



July 29, 2011

Dear Reader:

The enclosed draft environmental assessment (EA) for the RTI International Scale-up of High Temperature Syngas Cleanup and Carbon Capture and Sequestration Technologies, Polk County, Florida (Draft EA; DOE/EA-1867D), was prepared by the U.S. Department of Energy (DOE) in accordance with the Council on Environmental Quality's National Environmental Policy Act (NEPA) implementing regulations (40 CFR Parts 1500 to 1508) and DOE NEPA implementing procedures (10 CFR Part 1021). The draft EA evaluates the potential environmental consequences of providing a grant to RTI International (RTI) to facilitate construction and operation of its project demonstrating RTI's high-temperature syngas cleanup and carbon capture and sequestration (CCS) technologies. The project would be located at Tampa Electric Company's existing Polk Power Station in southwestern Polk County, Florida.

DOE's proposed action would provide RTI with a \$171.8 million grant under a cost-sharing arrangement. The proposed project would treat a slipstream, equivalent to as much as 66 megawatts of electricity generation, of coal-derived syngas from the existing Polk Unit 1 to remove 99.9 percent of the sulfur, reduce trace contaminants (arsenic, selenium, and mercury), and convert the removed sulfur compounds to commercial-grade elemental sulfur. Also, up to 300,000 tons per year, or 90 percent, of the carbon dioxide in the cleaned syngas would be captured and sequestered via a deep injection well in a saline geologic formation below the site.

This draft EA evaluates the potential impacts of the proposed project in 13 environmental resource areas. Based on initial screening evaluations, DOE determined that no or negligible impacts would occur in six of these resource areas. Additional impact evaluations for air quality, geology and soils, water resources, socioeconomics, transportation, waste management, and human health and safety identified negligible or minimal impacts from the proposed project's construction and operation. In this draft EA, potential cumulative impacts of the proposed project with other past, present, or future actions are also evaluated, and no adverse cumulative impacts are identified. The proposed project would have the beneficial impact of creating jobs during construction and operation.

Invitation to Comment

DOE invites interested parties to comment on this draft EA during a 15-day public comment period that begins on July 31, 2011, and ends August 15, 2011. Submit comments to:

Mr. Mark W. Lusk
U.S. Department of Energy
National Energy Technology Laboratory
3610 Collins Ferry Road
P.O. Box 880, MS B07
Morgantown, West Virginia, 26507-0880
Facsimile: (304) 285-4403
Email: mark.lusk@netl.doe.gov

Envelopes and the subject line of emails and faxes should be labeled "RTI Draft EA Comments." Comments received after the close of the comment period will be considered to the extent practicable.

Individual names and addresses, including e-mail addresses, received as part of the comment documents normally are considered part of the public record. Persons wishing to withhold his or her name, address, or other identifying information from the public record must state this request prominently at the beginning of the comment document. DOE will honor this request to the extent allowable by law. All submissions from organizations, businesses, and from individuals identifying themselves as representatives or officials of organizations or businesses will be included in the public record and open to public inspection in their entirety.

Thank you for your interest in the CCS from Industrial Sources Program and this draft EA. For further information on the draft EA or to request additional copies, please contact Mr. Mark W. Lusk as noted above. The draft EA can also be accessed from DOE's National Energy Technology Laboratory website at <http://www.netl.doe.gov/publications/others/nepa/ea.html>.

Sincerely,

A handwritten signature in black ink that reads "Mark W. Lusk". The signature is written in a cursive, flowing style.

Mark W. Lusk
NEPA Document Manager

**DRAFT
ENVIRONMENTAL ASSESSMENT**

for

**RTI INTERNATIONAL SCALE-UP OF HIGH-
TEMPERATURE SYNGAS CLEANUP AND
CARBON CAPTURE AND SEQUESTRATION
TECHNOLOGIES, POLK COUNTY, FLORIDA**



**U.S. DEPARTMENT OF ENERGY
National Energy Technology Laboratory**



**U.S. DEPARTMENT OF
ENERGY**



July 2011

This page intentionally left blank.

COVER SHEET

Responsible Agency: U.S. Department of Energy (DOE)

Title: Draft Environmental Assessment for RTI International Scale-Up of High-Temperature Syngas Cleanup and Carbon Capture and Sequestration Technologies, Polk County, Florida (DOE/EA-1867D)

Contact: For additional copies, to provide comments, or for more information concerning this environmental assessment (EA), please contact:

Mark W. Lusk
U.S. Department of Energy
National Energy Technology Laboratory
3610 Collins Ferry Road
P.O. Box 880, MS B07
Morgantown, West Virginia 26507-0880
mark.lusk@netl.doe.gov

Abstract: DOE prepared this Draft EA to evaluate the potential environmental consequences of its Proposed Action to provide cost-shared funding to RTI International (RTI) for its proposed project to demonstrate the precommercial scale-up of RTI's high-temperature syngas cleanup and carbon capture and sequestration technologies. Approximately \$168.8 million of DOE's total \$171.8 million funding for the proposed project would be provided from funds authorized in the American Recovery and Reinvestment Act of 2009 (Public Law 111-5, 123 Stat. 115). RTI's proposed project would advance the commercial deployment of cost-effective, environmentally sound technology options that reduce the constraints associated with using domestic coal energy resources and may ultimately assist in reducing greenhouse gas intensity.

RTI's proposed project would be located at Tampa Electric Company's existing Polk Power Station in Polk County, Florida. The proposed project would treat a slipstream, equivalent to up to 66 megawatts of electricity generation, of coal-derived syngas from the existing Polk Unit 1 integrated gasification combined-cycle power plant to remove 99.9 percent of the sulfur, reduce trace contaminant (arsenic, selenium, and mercury) concentrations, and convert the removed sulfur compounds to commercial-grade elemental sulfur. Also, up to 300,000 tons per year, or 90 percent, of the carbon dioxide (CO₂) in the cleaned syngas would be captured and sequestered in a deep geologic formation and not released to the atmosphere.

This EA evaluates the potential impacts of the proposed project in 13 environmental resource areas. Based on initial impact screening evaluations, DOE determined that no or negligible impacts would occur in six of these resource areas. Additional impact evaluations for air quality, geology and soils, water resources, socioeconomics, transportation, waste management, and human health and safety identify negligible or minimal impacts due to the proposed project's construction and operation. In this EA, potential cumulative impacts of the proposed project with other past, present, or future actions are also evaluated, and no adverse cumulative impacts are identified.

Availability: This Draft EA was made available for public review at the following Polk County public libraries:

Mulberry Public Library	Lakeland Public Library
103 East Canal Street	100 Lake Morton Drive
Mulberry, Florida 33860	Lakeland, Florida 33801

The Draft EA is also available on DOE's National Energy Technology Laboratory (NETL) website at <http://www.netl.doe.gov/publications/others/nepa/ea.html>.

This page intentionally left blank.

TABLE OF CONTENTS

<u>Section</u>	<u>Page</u>
Table of Contents	ii
List of Tables	vi
List of Figures	vii
List of Acronyms and Abbreviations	viii
Summary	xi
1.0 INTRODUCTION	1-1
1.1 <u>NEPA AND RELATED PROCEDURES</u>	1-2
1.2 <u>PURPOSE AND NEED FOR DOE'S PROPOSED ACTION</u>	1-2
1.3 <u>PREVIOUS ENVIRONMENTAL STUDIES</u>	1-4
1.4 <u>RELATED PROJECT</u>	1-5
1.5 <u>ENVIRONMENTAL RESOURCES NOT CARRIED FORWARD</u>	1-5
1.6 <u>CONSULTATIONS AND PUBLIC COMMENT AND RESPONSE PROCESS</u>	1-6
1.6.1 CONSULTATIONS	1-6
1.6.1.1 <u>State Historic Preservation Office</u>	1-6
1.6.1.2 <u>Seminole Tribe</u>	1-9
1.6.2 PUBLIC COMMENT AND RESPONSE PROCESS	1-9
2.0 PROPOSED ACTION AND ALTERNATIVES	2-1
2.1 <u>DOE'S PROPOSED ACTION</u>	2-1
2.2 <u>RTI'S PROPOSED PROJECT</u>	2-1
2.2.1 PROJECT LOCATION AND EXISTING FACILITIES	2-1
2.2.2 CONSTRUCTION ACTIVITIES	2-6
2.2.3 SYNGAS CLEANUP SYSTEMS	2-9
2.2.3.1 <u>High-Temperature Desulfurization Process</u>	2-10
2.2.3.2 <u>Trace Contaminant Removal Process</u>	2-12
2.2.3.3 <u>Direct Sulfur Recovery Process</u>	2-12
2.2.4 CARBON CAPTURE SYSTEM	2-12
2.2.4.1 <u>Water Gas Shift Reactor Unit</u>	2-13
2.2.4.2 <u>Low-Temperature Gas Cooling Unit</u>	2-13
2.2.4.3 <u>Activated Amine CO₂ Capture Unit</u>	2-13
2.2.4.4 <u>CO₂ Compression and Drying</u>	2-13
2.2.5 CARBON SEQUESTRATION	2-14
2.2.5.1 <u>Target Injection Zone</u>	2-14
2.2.5.2 <u>Injection and Monitoring Well Permitting</u>	2-15
2.2.5.3 <u>Well Design and Drilling/Construction</u>	2-16

TABLE OF CONTENTS

(Continued, Page 2 of 4)

<u>Section</u>	<u>Page</u>	
2.2.5.4	<u>Operations and Maintenance Plans</u>	2-22
2.2.5.5	<u>Monitoring, Verification, and Accounting Program</u>	2-22
2.3	<u>NO-ACTION ALTERNATIVE</u>	2-26
3.0	AFFECTED ENVIRONMENT AND ENVIRONMENTAL CONSEQUENCES	3-1
3.1	<u>AIR QUALITY</u>	3-1
3.1.1	AFFECTED ENVIRONMENT	3-1
3.1.1.1	<u>Climatology and Meteorology</u>	3-1
3.1.1.2	<u>Ambient Air Quality Conditions</u>	3-3
3.1.2	ENVIRONMENTAL CONSEQUENCES	3-8
3.1.2.1	<u>Proposed Project</u>	3-8
3.1.2.2	<u>No-Action Alternative</u>	3-11
3.2	<u>GEOLOGY AND SOILS</u>	3-11
3.2.1	AFFECTED ENVIRONMENT	3-11
3.2.1.1	<u>Subsurface Geology</u>	3-11
3.2.1.2	<u>Soils</u>	3-14
3.2.2	ENVIRONMENTAL CONSEQUENCES	3-16
3.2.2.1	<u>Proposed Project</u>	3-16
3.2.2.2	<u>No-Action Alternative</u>	3-17
3.3	<u>WATER RESOURCES</u>	3-17
3.3.1	AFFECTED ENVIRONMENT	3-17
3.3.1.1	<u>Surface Water</u>	3-17
3.3.1.2	<u>Groundwater</u>	3-18
3.3.2	ENVIRONMENTAL CONSEQUENCES	3-22
3.3.2.1	<u>Proposed Project</u>	3-22
3.3.2.2	<u>No-Action Alternative</u>	3-26

TABLE OF CONTENTS

(Continued, Page 3 of 4)

<u>Section</u>	<u>Page</u>
3.4 <u>SOCIOECONOMICS</u>	3-26
3.4.1 AFFECTED ENVIRONMENT	3-27
3.4.1.1 <u>Population</u>	3-27
3.4.1.2 <u>Employment and Income</u>	3-27
3.4.1.3 <u>Housing</u>	3-28
3.4.1.4 <u>Public Facilities and Services</u>	3-28
3.4.2 ENVIRONMENTAL CONSEQUENCES	3-28
3.4.2.1 <u>Proposed Project</u>	3-28
3.4.2.2 <u>No-Action Alternative</u>	3-29
3.5 <u>TRANSPORTATION</u>	3-29
3.5.1 AFFECTED ENVIRONMENT	3-29
3.5.2 ENVIRONMENTAL CONSEQUENCES	3-30
3.5.2.1 <u>Proposed Project</u>	3-30
3.5.2.2 <u>No-Action Alternative</u>	3-31
3.6 <u>SOLID WASTE AND BYPRODUCT MANAGEMENT</u>	3-31
3.6.1 AFFECTED ENVIRONMENT	3-31
3.6.2 ENVIRONMENTAL CONSEQUENCES	3-32
3.6.2.1 <u>Proposed Project</u>	3-32
3.6.2.2 <u>No-Action Alternative</u>	3-33
3.7 <u>HUMAN HEALTH AND SAFETY</u>	3-33
3.7.1 AFFECTED ENVIRONMENT	3-33
3.7.2 ENVIRONMENTAL CONSEQUENCES	3-34
3.7.2.1 <u>Proposed Project</u>	3-34
3.7.2.2 <u>No-Action Alternative</u>	3-36
3.8 <u>RELATIONSHIP BETWEEN SHORT-TERM USES OF THE ENVIRONMENT AND MAINTENANCE AND ENHANCEMENT OF LONG-TERM PRODUCTIVITY</u>	3-36
3.9 <u>IRREVERSIBLE AND IRRETRIEVABLE COMMITMENTS OF RESOURCES</u>	3-36
3.10 <u>UNAVOIDABLE ADVERSE IMPACTS</u>	3-37

TABLE OF CONTENTS

(Continued, Page 4 of 4)

<u>Section</u>		<u>Page</u>
4.0	CUMULATIVE IMPACTS	4-1
4.1	<u>PAST, PRESENT, AND REASONABLY FORESEEABLE ACTIONS</u>	4-1
4.2	<u>GREENHOUSE GAS AND GLOBAL WARMING</u>	4-4
4.3	<u>CUMULATIVE IMPACT SUMMARY</u>	4-6
5.0	CONCLUSIONS	5-1
6.0	REFERENCES	6-1

APPENDICES

APPENDIX A—DISTRIBUTION LIST
APPENDIX B—CONSULTATIONS

LIST OF TABLES

<u>Table</u>		<u>Page</u>
1-1	Environmental Resource Areas Not Carried Forward	1-7
2-1	Estimated Composition of the CO ₂ Stream to be Sequestered	2-14
2-2	Summary of Pre-, During, and Post-CO ₂ Monitoring Program	2-23
2-3	Monitoring Zones and Technology Stages Proposed for RTI's Proposed Project at the Tampa Electric Polk Power Station	2-24
3-1	Ambient Temperatures Measured at Wauchula, Florida	3-2
3-2	Normal and Extreme Precipitation Measured at Wauchula, Florida	3-2
3-3	NAAQS and Monitored Air Quality Concentrations	3-6
3-4	Hydrogeological Framework for West-Central Florida	3-12
3-5	Population Trends for Polk County, Select Cities, and Florida	3-27
3-6	Polk County Major Industry Groups	3-27

This page intentionally left blank.

LIST OF FIGURES

<u>Figure</u>		<u>Page</u>
2-1	Regional Location of the Polk Power Station Site	2-2
2-2	General Vicinity Map and Boundaries of the Polk Power Station Site	2-3
2-3	Aerial Photograph of Polk Power Station Site	2-5
2-4	Location of RTI Proposed Project Site within the Polk Power Station Site	2-7
2-5	Simplified Block Flow Diagram of Syngas Cleanup Systems and Integration with Tampa Electric's IGCC Unit	2-9
2-6	General Arrangement of RTI's Proposed Project Facilities within Tampa Electric's Existing Facility Layout	2-11
2-7	Injection Well IW-2 Design, Tubing, and Fluid-Filled Annulus Details for Carbon Sequestration	2-17
2-8	Dual Zone Monitoring Well DZMW-2 Design Details	2-19
2-9	Injection Zone Monitoring Well IZMW-2 Design Details	2-21
2-10	MVA Monitoring Locations	2-25
3-1	5-Year Annual Wind Rose, Orlando International Airport, 1996 through 2000	3-4
3-2	5-Year Seasonal Wind Roses, Orlando International Airport, 1996 through 2000	3-5
3-3	North-South Geologic Cross-Section of West-Central Florida	3-13
3-4	Soils Map for Polk Power Station Site	3-15
3-5	Distribution and Presence of the SAS in Florida	3-19
3-6	Distribution and Presence of the IAS in Florida	3-20
3-7	Distribution and Presence of the UFAS in Florida	3-21
3-8	Water Balance for RTI's Proposed Project	3-23
4-1	Bone Valley Central Florida Phosphate District	4-2

This page intentionally left blank.

LIST OF ACRONYMS AND ABBREVIATIONS

°C	degree Celsius
°F	degree Fahrenheit
µg/m ³	microgram per cubic meter
aMDEA	activated methyldiethanolamine
ASRus	ASRus, LLC
BEBR	Bureau of Economic and Business Research
CCSP	U.S. Climate Change Science Program
CDC	Centers for Disease Control and Prevention
CEQ	Council on Environmental Quality
CFR	Code of Federal Regulations
cm/sec	centimeter per second
CO	carbon monoxide
CO ₂	carbon dioxide
COS	carbonyl sulfide
CR	County Road
DOE	U.S. Department of Energy
DSRP	direct sulfur recovery process
EA	environmental assessment
EIS	environmental impact statement
EPA	U.S. Environmental Protection Agency
F.A.C.	Florida Administrative Code
F.S.	Florida Statutes
FDEP	Florida Department of Environmental Protection
FDOT	Florida Department of Transportation
FGT	Florida Gas Transmission
FONSI	Finding of No Significant Impact
FRP	fiber reinforced piping
ft	foot (feet)
ft bls	foot (feet) below land surface
ft/day	foot (feet) per day
GHG	greenhouse gas
H ₂ S	hydrogen sulfide
hr/yr	hour per year
HTDP	high-temperature desulfurization process
IAS	intermediate aquifer system
ICCS	industrial carbon capture and sequestration
ICP	integrated contingency plan
IDLH	immediately dangerous to life or health
IGCC	integrated gasification combined-cycle
InSAR	interferometric synthetic aperture radar
IPCC	International Panel on Climate Change
kV	kilovolt
LFAS	Lower Floridan aquifer system
LOS	level of service
MGD	million gallons per day
MMBtu/hr	million British thermal units per hour
MMSCFH	million standard cubic feet per hour
mph	mile(s) per hour

LIST OF ACRONYMS AND ABBREVIATIONS

(Continued, Page 2 of 3)

MVA	monitoring, verification, and accounting
MW	megawatt
NAAQS	National Ambient Air Quality Standards
NCDC	National Climatic Data Center
NEPA	National Environmental Policy Act of 1969
NETL	DOE's National Energy Technology Laboratory
NIOSH	National Institute for Occupational Safety and Health
NO ₂	nitrogen dioxide
NO _x	nitrogen oxides
NPDES	National Pollutant Discharge Elimination System
NSR	new source review
NWS	National Weather Service
OSHA	Occupational Safety and Health Administration
PBR	polished borehole receptacle
PFT	perfluorocarbon tracer
PM	particulate matter
PM ₁₀	particulate matter less than 10 microns in aerodynamic diameter
PM _{2.5}	particulate matter less than 2.5 microns in aerodynamic diameter
ppb	part per billion
ppm	part per million
ppmv	part per million by volume
PPSA	Florida Electrical Power Plant Siting Act
psig	pound-force per square inch gauge
RCRA	Resource Conservation and Recovery Act
Recovery Act	American Recovery and Reinvestment Act of 2009
RTI	RTI International
SAS	surficial aquifer system
SCA	site certification application
SCS	Soil Conservation Service
SHPO	State Historic Preservation Office
SIP	State Implementation Plan
SO ₂	sulfur dioxide
SR	State Road
SWFWMD	Southwest Florida Water Management District
syngas	synthesis gas
Tampa Electric	Tampa Electric Company
TCLP	toxicity characteristic leaching procedure
TCRP	trace contaminant removal process
THPO	Tribal Historic Preservation Office
tpd	ton(s) per day
tpy	ton(s) per year
U.S.C.	United States Code
UFAS	Upper Floridan aquifer system
UIC	underground injection control
USACE	U.S. Army Corps of Engineers
USC	United States Code
USDA	U.S. Department of Agriculture

LIST OF ACRONYMS AND ABBREVIATIONS

(Continued, Page 3 of 3)

USDW	underground source of drinking water
VMT	vehicle-mile traveled
VOC	volatile organic compound

This page intentionally left blank.

SUMMARY

The U.S. Department of Energy (DOE) proposes to provide \$171.8 million in cost-shared funding to RTI International (RTI) for its proposed project to demonstrate the precommercial scale-up of RTI's high-temperature synthesis (syngas) cleanup and carbon dioxide (CO₂) capture and sequestration technologies. Approximately \$168.8 million of DOE's funding would be provided from Carbon Capture and Sequestration from Industrial Sources Program funds authorized in the American Recovery and Reinvestment Act of 2009. RTI's proposed project would be located at Tampa Electric Company's (Tampa Electric's) existing Polk Power Station electric generating facilities in southwestern Polk County, Florida. The project facilities would occupy approximately 2.4 acres adjacent to the existing power plant facilities. RTI's proposed project would treat a slipstream, equivalent to up to 66 megawatts of electricity generation, of the coal-derived syngas from the Polk Unit 1 integrated gasification combined-cycle (IGCC) power plant to remove 99.9 percent of the sulfur, reduce trace contaminant (arsenic, selenium, and mercury) concentrations, and convert removed sulfur compounds to elemental sulfur. Also, the proposed project would capture up to 300,000 tons per year, or 90 percent, of the CO₂ in the cleaned syngas and sequester the CO₂ by deep well injection in a deep geologic formation at the site. The proposed project would have a target to operate for approximately 8,000 hours over the 18-month demonstration period.

In compliance with the National Environmental Policy Act of 1969 (NEPA) (Title 42, Section 4321 *et seq.*, United States Code) and DOE's NEPA implementing procedures (Chapter 10, Part 1021, Code of Federal Regulations), this environmental assessment (EA) evaluates the potential environmental impacts of DOE's Proposed Action to provide funding to RTI, RTI's proposed project, and the no-action alternative, under which it is assumed the proposed project would not be constructed. This EA is intended to provide DOE with information on the potential environmental consequences of the proposed project for consideration in its decision-making on proceeding with its Proposed Action.

In this EA, the potential impact evaluations considered all the environmental resource areas that DOE typically considers in NEPA documents. Based on initial impact screening evaluations, some of the resource areas were not carried forward for additional analyses because DOE determined the proposed project would not impact these resources or the potential impacts would be negligible. DOE focused the more detailed impact evaluations on the following resource areas:

- Air quality.
- Geology and soils.
- Water resources.
- Socioeconomics.
- Transportation.
- Waste management.
- Human health and safety.

AIR QUALITY

The proposed project site area is designated as attainment for all National Ambient Air Quality Standards (NAAQS) criteria air pollutants. Construction of the proposed project would result in fugitive dust air emissions during site preparation activities and the release of nitrogen oxides, carbon monoxide, and other fuel combustion emissions from equipment and vehicles. The potential air quality impacts of the construction-related emissions would be minor due to the temporary and localized nature of the emissions. During operations, the proposed project would have three sources of intermittent emissions and one continuous emissions source, a propane-fired heater. Due to the intermittent and minor level of emissions from these sources, potential air quality impacts would be minor and would not contribute to exceedances of NAAQS or changes in attainment status.

The proposed project would reduce greenhouse gas emissions by capturing and sequestering 300,000 tons per year of CO₂, which would otherwise have been released to the atmosphere.

GEOLOGY AND SOILS

Soils on the proposed project site have been previously disturbed by phosphate mining activities and construction activities for the existing power plant facilities. The general geologic framework at the Polk Power Station site consists of surficial layers of unconsolidated sands, clays, and consolidated carbonate strata underlain by a series of thick, stratigraphic units consisting of sedimentary carbonate (limestone and dolomite) rocks.

The targeted CO₂ injection zone would be a deep saline carbonate (limestone and dolomite) system located between 4,200 and 8,000 feet below land surface (ft bls). The injection zone is overlain by a laterally continuous, more than 1,300-foot-thick, low-permeability confining unit. A release of CO₂ vertically through the geologic materials up to the surface or nearer surface geologic units would be considered unlikely because of the proposed injection well design plus the proposed operational monitoring program and the presence of the thick confining unit. Therefore, the proposed project would be expected to have minimal impacts on geologic or soil resources.

WATER RESOURCES

The proposed project site is located within the headwaters of Little Payne Creek that flows from the site to Payne Creek, which is a tributary of the Peace River. Key surface water features on the Polk Power Station site include the 755-acre cooling reservoir, a 26-acre stormwater detention pond, old water-filled mine cuts, and a reclaimed lake. During construction of the proposed project, soil erosion and stormwater

runoff from the project facility area and construction laydown/parking areas would be the primary potential surface water resource concern. During construction, appropriate stormwater management and erosion control measures would be used to avoid or minimize potential impacts, and any potential impacts would be minor and temporary. During operation, the proposed project would use minor amounts of additional water resources and discharge minimal amounts of wastewater. Water would be provided from the existing Polk Power Station water supply system, and wastewater would be discharged to the existing wastewater treatment system, which ultimately discharges to the cooling reservoir. Therefore, potential impacts to surface water resources would be minimal.

The groundwater aquifer systems below the proposed project site area include, in descending order, the surficial, intermediate, and the Upper and Lower Floridan aquifers. The Upper Floridan aquifer, which extends between 300 and 1,000 ft bls in the site area, is the major source of drinking water supply in the project area, as well as in most of the northern and central portions of the Florida Peninsula. The targeted CO₂ injection zone for the proposed project would be a deep saline carbonate system between 4,200 and 8,000 ft bls. This zone is primarily separated from the Upper Floridan drinking water aquifer system by a thick, low-permeability confining unit that extends between 2,900 and 4,000 ft bls, as well as an intermediate low-permeability confining unit directly below the aquifer. The unplanned release of CO₂ vertically up to the drinking water aquifer would be considered unlikely due to the presence of these confining units, as well as the proposed design of the injection well, which would include multiple steel casings and cement packings through and below the aquifer. Further, should a release of CO₂ occur, preliminary geochemical modeling indicates the CO₂ solution would react with carbonate materials and be dissolved prior to reaching drinking water aquifers. Therefore, potential impacts to groundwater resources are expected to be minor.

SOCIOECONOMICS

The proposed project would be located in a rural, unincorporated area of Polk County. The proposed project facilities would be situated adjacent to, and integrated with, the existing IGCC power plant within the Polk Power Station. Because of its nature, size, and location, the proposed project would have negligible impacts on local socioeconomic resources such as population, housing, schools, and police and fire protection. The proposed project would create a monthly average of 107 jobs on the site during the 13-month construction period and 12 jobs during the 18-month operational period. The creation of jobs would provide minor short-term benefits to the local economy.

TRANSPORTATION

Transportation facilities in the vicinity of the Polk Power Station site include several state and county roadways and a railroad. The roads in the vicinity of the site are functioning at an acceptable level of service (LOS). During construction, the proposed project would have short-term, minor transportation impacts due to the movement of construction workers and equipment and material deliveries to and from the site. These potential impacts would involve minor traffic congestion and delays in the vicinity of access road entrances to the Polk Power Station. These potential impacts would be temporary and would not be expected to cause the roads to function at an unacceptable LOS. During operations, the potential impacts of the proposed project on transportation would be minimal due to the small number of operational employees.

WASTE MANAGEMENT

The existing Polk Power Station Unit 1 IGCC operations generate various wastes and byproducts, including some materials with potentially hazardous properties. Under applicable Resource Conservation and Recovery Act (RCRA) regulations (Chapter 40, Parts 260 through 279, Code of Federal Regulations [CFR]), the Polk Power Station is classified as a large-quantity hazardous waste generator. Currently, all wastes, byproducts, and potential hazardous materials are managed by Tampa Electric in accordance with applicable RCRA and state requirements.

The proposed project would store and use various chemicals and materials and generate moderate quantities of waste products, some of which may be potentially hazardous. During the proposed project operations, the wastes would be managed, controlled, characterized by testing, and transported offsite for appropriate disposal. Further, workers responsible for the proposed project operations would be properly trained on waste handling procedures, as well as emergency response procedures in case of an accidental release. Based on these measures, the proposed project is expected to have minimal impacts due to the generation, handling, and disposal of wastes.

HUMAN HEALTH AND SAFETY

Potential human health and safety impacts associated with the proposed project may result from air pollution releases, accidental spills or releases of hazardous materials or toxic gases, and worker injuries due to accidents. These potential concerns are similar to those associated with the existing Polk Power Station operations. The proposed project would have minor, intermittent air emissions that would not create any major air pollution nor contribute to exceedances of NAAQS, which were established to protect human health and welfare. Potentially hazardous wastes and materials generated by the proposed project would be managed, controlled, and disposed in accordance with applicable federal and state

regulations to minimize potential human health risks due to accidental releases. Applicable Occupational Safety and Health Administration procedures, similar to the existing plant programs, would be followed during construction and operation of the proposed project to minimize the potential for worker injury due to accidents.

The proposed project would involve the handling of two gas streams, which have human health exposure concerns. These streams would include gas removed from the untreated syngas in the high-temperature desulfurization process, which would have high concentrations of hydrogen sulfide (H₂S) and the CO₂ gas captured in the activated amine system. The equipment, vessels, and piping for the H₂S and CO₂ gas streams would be designed and constructed to minimize the potential for leaks. These systems would also be regularly inspected and equipped with monitoring detectors and alarms to minimize human health and safety risks.

During preparation of this EA, DOE consulted with the Florida State Historic Preservation Office (SHPO), Seminole Tribe of Florida, and Seminole Nation of Oklahoma regarding the potential impacts of the proposed project on historic and tribal resources property. Based on initial evaluations, DOE determined that no resources or properties would be affected by the proposed project. The Florida SHPO and Seminole Tribal Historic Preservation Office concurred with DOE's determinations.

Cumulative impact considerations included air emissions from the existing power plant units and potential future generating units at the Polk Power Station and Tampa Electric's future use of the same injection well, which would be used for CO₂ injection for the proposed project, for disposal of wastewater from the existing operations. Due to the intermittent, minor level of emissions from the proposed project, the cumulative impacts on air quality would be negligible. Based on preliminary geochemical modeling, the combined CO₂ and wastewater plumes would not migrate a considerable distance from the injection site, and the CO₂ plume would react with and dissolve in the brine wastewater within the injection zone in a relatively short period of time. Therefore, the cumulative impacts of the future use of the injection well are expected to be minimal.

Under the no-action alternative, DOE would not provide funding to RTI, and the proposed project would not be constructed or operated. Therefore, no impacts to environmental resources would occur, and no short-term benefits to the local economy would occur. Also, under the no-action alternative, Tampa Electric would proceed with its plans to construct and use two injection wells for the disposal of wastewater from the power plant operations.

This page intentionally left blank.

1.0 INTRODUCTION

The U.S. Department of Energy (DOE) proposes to provide cost-shared funding to RTI International (RTI) for a project that would demonstrate the scale-up of high-temperature synthesis gas (syngas) cleanup and carbon dioxide (CO₂) capture and sequestration technologies. RTI's proposed project would be located at Tampa Electric Company's (Tampa Electric's) existing integrated gasification combined-cycle (IGCC) electric generating facility at its Polk Power Station in Polk County, Florida. The overall objective of RTI's proposed project is to mitigate the technical risks associated with scale-up of syngas cleanup and CO₂ capture and sequestration technologies to enable subsequent commercial deployment.

DOE proposes to provide approximately \$171.8 million in funding to RTI for the proposed project. DOE intends to provide approximately \$168.8 million of its funding from Carbon Capture and Sequestration from Industrial Sources Program funds authorized in the American Recovery and Reinvestment Act of 2009 (Recovery Act) (Public Law 111-5, 123 Stat. 115). Congress appropriated the Recovery Act funds to stimulate the economy and reduce unemployment in addition to furthering DOE's Industrial Carbon Capture and Sequestration (ICCS) Program.

DOE's decision (i.e., DOE's Proposed Action) to provide funding for the RTI project requires compliance with the National Environmental Policy Act of 1969 (NEPA) (Title 42, Section 4321, *et seq.*, United States Code [USC]), Council on Environmental Quality (CEQ) regulations for implementing NEPA (Chapter 40, Parts 1500 to 1508, Code of Federal Regulations [CFR]), and DOE's NEPA Implementing Procedures (10 CFR 1021). To comply with NEPA, DOE's National Energy Technology Laboratory (NETL) prepared this Draft Environmental Assessment for the RTI International Scale-Up of High-Temperature Syngas Cleanup and Carbon Capture and Sequestration Technologies, Polk County, Florida. This environmental assessment (EA) evaluates the potential environmental effects of DOE's Proposed Action to provide cost-shared funding to RTI for the construction and operation of its proposed project. The EA also evaluates the potential environmental effects of the no-action alternative, under which DOE would not provide funding to RTI, and RTI would not proceed with the proposed project.

The remainder of this chapter describes NEPA and other related environmental procedures for the proposed project (Section 1.1), DOE's purpose and need for the Proposed Action (Section 1.2), previous environmental studies for the Polk Power Station (Section 1.3), a related project (Section 1.4), the environmental resources DOE did not carry forward for detailed analysis in the EA (Section 1.5), and the consultations and public comment and response process (Section 1.6). Chapter 2.0 describes DOE's Proposed Action, RTI's proposed project, and the no-action alternative. Chapter 3.0 provides

descriptions of the affected environment and the potential environmental effects of the proposed project and the no-action alternative. Chapter 4.0 discusses the cumulative impacts, and Chapter 5.0 provides DOE's conclusions from the analyses in the EA. Chapter 6.0 lists the references for the EA document. Other supporting information is provided in the appendices.

1.1 NEPA AND RELATED PROCEDURES

DOE prepared this EA in accordance with the requirements of NEPA and the CEQ and following DOE's NEPA implementing procedures. NEPA requires federal agencies to consider the potential consequences of a Proposed Action (e.g., funding decision) in their decision-making process. NEPA also encourages federal agencies to protect, restore, or enhance the environment through well-informed federal decisions. DOE must comply with these requirements prior to making a decision to proceed with the Proposed Action to provide funding for RTI's proposed project.

In accordance with DOE's NEPA implementing procedures, DOE determined that preparation of an EA is the appropriate level of analysis for RTI's proposed project. DOE based this determination of its initial review of the scope of the proposed project, its environmental setting, and its potential environmental effects. To meet DOE's regulatory requirements under NEPA, this EA evaluates the potential environmental impacts of RTI's proposed project on the physical, human, and natural environment. For comparison purposes, the EA also evaluates the potential environmental impacts of DOE's no-action alternative. This EA is intended to provide DOE with the information needed to make an informed decision on providing funding for RTI's proposed project. Based on this EA, DOE will either issue a Finding of No Significant Impact (FONSI) or determine that additional detailed analyses are needed through preparation of an environmental impact statement (EIS).

Further, in accordance with the CEQ regulations and DOE NEPA implementing procedures, the EA incorporates appropriate agency and American Indian tribal consultation and public involvement processes. All input received through these processes is considered in the environmental analyses and development of the final EA, which will form the basis for DOE's decision on its Proposed Action.

1.2 PURPOSE AND NEED FOR DOE'S PROPOSED ACTION

One of DOE's primary goals is to catalyze the timely, material, and efficient transformation of the nation's energy system and secure United States leadership in clean energy technologies (DOE, 2011). DOE's NETL contributes to this goal by funding and managing research, development, and demonstration programs to advance cost-effective technologies focused on clean energy production and use of United States domestic fossil energy resources. A key environmental issue and constraint

associated with using domestic fossil fuels involves emissions of CO₂, a greenhouse gas (GHG) that contributes to global climate change. NETL's program titled Carbon Capture and Sequestration from Industrial Sources and Innovative Concepts for Beneficial CO₂ Use fulfills a critical need by providing opportunities for the advancement of CO₂ capture and sequestration technologies. One of the principal goals of this program is to gain technical, engineering, and economic information on these technologies through large-scale testing in order to advance the commercial deployment of cost-effective, environmentally sound options that may ultimately lead to a reduction in GHG levels.

The purpose of RTI's proposed project is to design, build, and demonstrate high-temperature syngas cleanup technologies integrated with carbon capture and sequestration at a precommercial scale. The overall objective of the project is to mitigate the technical risks associated with scale-up of the syngas cleanup and CO₂ capture and sequestration technologies to enable subsequent commercial deployment. The project would support the goal of advancing cost-effective technologies to make coal power plants and other industrial facilities cleaner by removing contaminants from the coal-derived syngas and by reducing the cost and improving the efficiency of capturing and sequestering CO₂. Also, DOE believes a number of other industrial applications can potentially benefit from the RTI cleanup technologies, including the production of hydrogen for use in petroleum refineries and petrochemical plants and the production of chemicals and plastics.

In addition to providing needed information on the commercialization of syngas cleanup technologies, RTI's proposed project would also provide large-scale field testing information on the geologic sequestration characteristics, storage capacity, and processes in the deep saline aquifer formations underlying Tampa Electric's Polk Power Station in west-central Florida. The CO₂ injection process would be carefully controlled and monitored to determine potential effects and facilitate the effective design of potential CO₂ sequestration projects at other power plants near similar saline formations.

Further, DOE's Proposed Action to provide funding for RTI's proposed project would support the goals of the Recovery Act to create jobs and restore economic growth through measures that modernize the nation's infrastructure and enhance the nation's energy independence. The construction of the proposed project would create a monthly average of 107 jobs and a peak of 160 jobs on the site over the 13-month construction period and would involve expenditures for equipment, materials, and service of more than \$62 million. During the subsequent 18-month operational period, the project would create 12 jobs. Additional economic benefits to the local community may also be realized.

1.3 PREVIOUS ENVIRONMENTAL STUDIES

The proposed project would be located at Tampa Electric's Polk Power Station in Polk County, Florida. The project facilities would be located adjacent to and integrated with the existing facilities and systems for the Polk Unit 1 IGCC plant. The Polk Power Station site and existing power plant facilities have been subject to various environmental studies, impact assessments, and licensing/permitting requirements. These previous environmental studies include:

- Tampa Electric Company Polk Power Station Site Certification Application, Environmental Consulting & Technology, Inc. (ECT), July 1992. This site certification application (SCA) was prepared to fulfill the environmental licensing requirements under the Florida Electrical Power Plant Siting Act (PPSA), Section 403.501 through .518, Florida Statutes (F.S.), for construction and operation of 1,150 megawatts (MW) of new electric generating facilities at the Polk Power Station site, including the Polk Unit 1 IGCC facilities. The SCA is a comprehensive environmental document, similar to an EA or EIS, which includes detailed descriptions of the existing physical, biological, and socioeconomic environment and the effects of the plant construction and operation.
- Final Environmental Impact Statement, Tampa Electric Company, Polk Power Station, U.S. Environmental Protection Agency (EPA), June 1994. This EIS was prepared by EPA, as lead agency, to meet NEPA requirements under the National Pollutant Discharge Elimination System (NPDES) permitting program. DOE was a cooperating agency for the EIS preparation to meet its NEPA requirements based on its proposed cost-shared funding for the Polk Unit 1 IGCC plant under DOE's Clean Coal Technology Demonstration Program. The U.S. Army Corps of Engineers (USACE) was also a cooperating agency.
- Polk Power Station Unit 6, Site Certification Application, ECT, September 2007. This SCA was prepared to meet the environmental licensing requirements under the Florida PPSA for construction and operation of a nominal 630-MW IGCC generating unit at the Polk Power Station site. The SCA included detailed descriptions of the existing environment and effects of the proposed unit. Tampa Electric withdrew the SCA prior to approval due to changes in economic conditions.
- Various Deep Underground Injection Well Permit Applications, ECT and ASRus, LLC (ASRus), August 2007, August 2009, February 2010a, April 2010b, May 2011a, and May 2011b. These permit applications were submitted under the Florida Department of Environmental Protection (FDEP) Underground Injection Control (UIC) Program rules (Chapter 62-528, Florida Administrative Code [F.A.C.]) for the drilling and construction of two deep injection wells (IW-1 and IW-2) and associated monitoring wells at the Polk Power Station site. These two injection wells will be used to dispose of wastewaters from

the existing power plant operations and one well (IW-2) would also be used for injection of CO₂ during RTI's proposed project demonstration period. The permit applications include information on the hydrogeologic characteristics at the site, well inventories, well design, injectate characterization, and testing and monitoring programs.

These previous environmental studies and permitting applications include useful information to support the analyses in this EA, such as detailed information on the existing affected physical, biological, and socioeconomic environmental conditions on and in the vicinity of the Polk Power Station site.

1.4 RELATED PROJECT

Prior to agreeing to provide the host site for RTI's proposed project, Tampa Electric initiated efforts to permit, drill, and construct two deep injection wells at the Polk Power Station site to be used for the disposal of wastewaters from its existing power plant operations. These efforts are part of Tampa Electric's overall plans to reduce groundwater use at the plant by using reclaimed water from the city of Lakeland for cooling reservoir makeup water.

Under its Proposed Action for RTI's proposed project, DOE would provide partial funding for the drilling, construction, and modification of one of the deep wells (IW-2) to be temporarily used to inject and sequester CO₂. After the DOE-funded RTI project demonstration period has been completed, Tampa Electric intends to use the IW-2 well for injection of wastewaters. Also, after completion of the project and if the demonstration results were favorable, Tampa Electric may consider the option of continuing the operation of all or some portion of the syngas cleanup systems. Tampa Electric has no current plans to continue the injection of CO₂ in well IW-2. The cumulative impacts of Tampa Electric's future use of the well for wastewater injection purposes are addressed in Chapter 4.0 of this EA.

1.5 ENVIRONMENTAL RESOURCES NOT CARRIED FORWARD

This EA analyzes the potential environmental impacts that may occur from DOE's Proposed Action, the implementation of RTI's proposed project, and DOE's no-action alternative. Under the no-action alternative, DOE would not provide funding to RTI, and RTI would not proceed with the proposed project. Further, under the no-action alternative, Tampa Electric would proceed with its ongoing plans to drill and construct two deep wells for the injection of wastewaters from its existing Polk Power Station facilities. However, one of the wells would not be used for injection of CO₂ during RTI's proposed demonstration project.

The focus of the detailed analyses in Chapter 3.0 is on those environmental resources with the potential for adverse impacts, controversy, or public interest. Based on its initial screening evaluation of the project's potential impacts, DOE identified the following environmental resource areas for more detailed analyses:

- Air quality.
- Geology and soils.
- Water resources.
- Socioeconomics.
- Transportation.
- Solid and hazardous waste management.
- Human health and safety.
- Energy and utilities.

DOE EAs typically address other environmental resource areas not included in the previous list. However, during its internal scoping and impact screening evaluations for the project, DOE determined that certain resource areas did not warrant detailed analysis because the proposed project would not impact these resources, or the impacts would be negligible, temporary, and/or limited to the immediate project area within the existing Polk Power Station site. Table 1-1 provides a listing of the environmental resource areas that were considered by DOE, but not carried forward for detailed analysis in this EA, and DOE's conclusions for eliminating these areas from further discussion.

1.6 CONSULTATIONS AND PUBLIC COMMENT AND RESPONSE PROCESS

The CEQ NEPA implementing regulations encourage federal agencies to involve Native American tribes; local, state, and other federal agencies; as well as the public, in the preparation of NEPA documents, such as this EA. The purpose of these consultations is to obtain inputs and comments on environmental and cultural issues from the tribes, agencies, and persons who may be interested or affected by a proposed action.

1.6.1 CONSULTATIONS

1.6.1.1 State Historic Preservation Office

On April 11, 2011, DOE sent a formal consultation letter to the Florida State Historic Preservation Office (SHPO) in accordance with the requirements of Section 106 of the National Historic Preservation Act (Title 16, Section 470, United States Code [U.S.C.], *et seq.*). The letter provided information on the proposed project and its location and requested any comments the agency may have on the potential impacts of the proposed project. The Florida SHPO provided a letter response dated April 25, 2011, stating that no historic properties will be affected by the proposed project. Appendix B contains copies of these letters.

Table 1-1. Environmental Resource Areas Not Carried Forward

Environmental Resource Area	Impact Screening Conclusions
Land use	The proposed project facilities would be located within an approximately 2.4-acre area on the existing 4,348-acre Polk Power Station site, which is a certified power generation facility under the Florida PPSA. The zoning and future land use designation for the site is Phosphate Mining, within which a certified power generation facility is allowed with the approval of a conditional use permit. Polk County approved the conditional use permit for the Polk Power Station site on June 2, 1992. The proposed project is consistent with current land uses on the site and would not affect other existing or proposed land uses near the site.
Biological	The previous environmental licensing studies for the initial development and subsequent expansions of the Polk Power Station included detailed surveys and assessments for wetlands, vegetation, and protected wildlife and plant species. The specific area for the proposed project facilities has been previously impacted and disturbed by phosphate mining activities and construction and operation of the existing power plant facilities. This immediate area contains no wetlands or suitable wildlife habitat. The proposed project would have no additional impacts on biological resources.
Noise	During construction of the proposed project, noise levels may be slightly, temporarily higher than existing noise levels of the power plant operations. During operation, noise levels from the proposed project are expected to be similar to existing noise levels. Project workers would be required to follow similar noise protection procedures as used by the existing power plant workforce in accordance with Occupational Safety and Health Administration (OSHA) standards. The project site is located more than 0.7 mile from the Polk Power Station property boundary and more than 1.7 miles from the nearest residential receptor; therefore, no adverse noise impacts are expected to offsite receptors. Noise levels are expected to meet noise level standards established in Section 761 of the Polk County Land Development Code (Polk County, 2005).
Aesthetic, visual, and recreational	The Polk Power Station site and most of the adjacent and nearby areas have been previously disturbed by phosphate mining, and the existing industrial power plant has been in operation since 1996. The proposed project would be similar, on a smaller scale, in appearance to the existing industrial facilities, and would not alter the existing visual landscape. No significant recreational, park, scenic, or natural areas occur in the vicinity of the site; therefore, no impacts are expected.
Cultural	A cultural resources assessment was conducted on the Polk Power Station site in 1991 as part of the original environmental licensing for the power plant (ECT, 1992). No archaeological or historic resources were identified during the assessment, and the State Historic Preservation Office (SHPO) concurred that no significant resources are expected on the Polk Power Station site. The SHPO was also consulted for this EA and determined that no historic properties would be affected by the proposed project (see Appendix B).

Table 1-1. Environmental Resource Areas Not Carried Forward (Continued, Page 2 of 2)

Environmental Resource Area	Impact Screening Conclusions																																										
Environmental justice	<p>Executive Order 12898, Federal Actions to Address Environmental Justice in Minority Populations and Low Income Populations, requires federal agencies to identify and address disproportionately high and adverse human health or environmental effects of their programs and policies on minority and low-income communities and Native American tribes. The following provides information regarding the racial and Hispanic/Latino makeup and income and poverty levels in Polk County and the state of Florida.</p> <p style="text-align: center;"><u>Population by Race and Hispanic/Latino Origin, 2010</u></p> <table border="1" style="width: 100%; border-collapse: collapse;"> <thead> <tr> <th rowspan="2" style="text-align: center;">Area</th> <th rowspan="2" style="text-align: center;">Total Population</th> <th colspan="4" style="text-align: center;">Race (%)</th> <th rowspan="2" style="text-align: center;">Hispanic/Latino Origin (%)</th> </tr> <tr> <th style="text-align: center;">White</th> <th style="text-align: center;">Black</th> <th style="text-align: center;">American Indian/ Alaska Native</th> <th style="text-align: center;">Other</th> </tr> </thead> <tbody> <tr> <td style="text-align: center;">Polk County</td> <td style="text-align: center;">602,095</td> <td style="text-align: center;">75.2</td> <td style="text-align: center;">14.8</td> <td style="text-align: center;">0.4</td> <td style="text-align: center;">9.6</td> <td style="text-align: center;">17.7</td> </tr> <tr> <td style="text-align: center;">State of Florida</td> <td style="text-align: center;">18,801,310</td> <td style="text-align: center;">75.0</td> <td style="text-align: center;">16.0</td> <td style="text-align: center;">0.4</td> <td style="text-align: center;">8.6</td> <td style="text-align: center;">22.5</td> </tr> </tbody> </table> <p style="text-align: center;"><u>Income and Poverty Level, 2009</u></p> <table border="1" style="width: 100%; border-collapse: collapse;"> <thead> <tr> <th style="text-align: center;">Area</th> <th style="text-align: center;">Median Household Income</th> <th style="text-align: center;">Per Capita Income</th> <th style="text-align: center;">Persons Below Poverty Level (%)</th> </tr> </thead> <tbody> <tr> <td style="text-align: center;">Polk County</td> <td style="text-align: center;">\$41,913</td> <td style="text-align: center;">\$22,283</td> <td style="text-align: center;">16.8</td> </tr> <tr> <td style="text-align: center;">State of Florida</td> <td style="text-align: center;">\$44,755</td> <td style="text-align: center;">\$26,503</td> <td style="text-align: center;">15.0</td> </tr> </tbody> </table>						Area	Total Population	Race (%)				Hispanic/Latino Origin (%)	White	Black	American Indian/ Alaska Native	Other	Polk County	602,095	75.2	14.8	0.4	9.6	17.7	State of Florida	18,801,310	75.0	16.0	0.4	8.6	22.5	Area	Median Household Income	Per Capita Income	Persons Below Poverty Level (%)	Polk County	\$41,913	\$22,283	16.8	State of Florida	\$44,755	\$26,503	15.0
Area	Total Population	Race (%)				Hispanic/Latino Origin (%)																																					
		White	Black	American Indian/ Alaska Native	Other																																						
Polk County	602,095	75.2	14.8	0.4	9.6	17.7																																					
State of Florida	18,801,310	75.0	16.0	0.4	8.6	22.5																																					
Area	Median Household Income	Per Capita Income	Persons Below Poverty Level (%)																																								
Polk County	\$41,913	\$22,283	16.8																																								
State of Florida	\$44,755	\$26,503	15.0																																								

Source: U.S. Census Bureau, 2011.

Based on these data, the racial and Hispanic/Latino origin composition of Polk County’s population and levels of income and poverty are relatively similar to the statewide averages. Therefore, no disproportionately high or adverse impacts to minority or low-income communities are expected due to the proposed project.

Source: ECT, 2011.

1.6.1.2 Seminole Tribe

On April 11, 2011, DOE sent a formal consultation letter to tribal leaders and the Tribal Historic Preservation Offices (THPOs) of the Seminole Tribe of Florida and Seminole Nation of Oklahoma in accordance with Section 106 of the National Historic Preservation Act and the Native Americans Graves Protection and Repatriation Act of 1990. The letters stated that DOE had completed an initial evaluation of the potential impacts of the proposed project and determined that no tribal resources or properties would be affected. The letters also requested tribal concurrence with DOE's finding and any comments on the potential impacts of the project on tribal resources. The Seminole Tribe of Florida's THPO provided a letter response dated May 2, 2011, stating that the THPO has no objection to DOE's findings. Appendix B provides copies of these letters.

1.6.2 PUBLIC COMMENT AND RESPONSE PROCESS

A public notice describing the proposed project and providing notice of the availability of this Draft EA was published in the local newspaper, the Lakeland Ledger. The notice requested comments on the Draft EA for a period of 15 days following publication of the notice. Copies of the Draft EA were distributed to various agencies with jurisdiction or special expertise, and copies were sent to Polk County libraries in Mulberry and Lakeland (see distribution list in Appendix A). Also, the Draft EA will be made available to the public on the DOE NETL website at <http://www.netl.doe.gov/publications/others/nepa/ea.html>.

Any comments received during the public comment period will be considered by DOE in the preparation of the Final EA and in its decision-making regarding the proposed project.

This page intentionally left blank.

2.0 PROPOSED ACTION AND ALTERNATIVES

This chapter describes DOE's Proposed Action, RTI's proposed project, and the no-action alternative.

2.1 DOE'S PROPOSED ACTION

DOE's Proposed Action would provide RTI \$171.8 million in cost-shared funding to demonstrate the scale-up of its high-temperature syngas cleanup and CO₂ capture and sequestration technologies at Tampa Electric's Polk Power Station in Polk County, Florida. The proposed project would demonstrate these technologies at a large scale for a period of 18 months. The successful demonstration would potentially mitigate the technical risks associated with subsequent commercial deployment of these technologies that provide high-purity syngas, from which 90 percent of the carbon has been removed and sequestered, at lower costs than current technology alternatives.

2.2 RTI'S PROPOSED PROJECT

RTI's proposed project would involve the design, construction, and demonstration of its high-temperature syngas cleanup technologies integrated with CO₂ capture and sequestration at a precommercial scale. The project would build on the field tests of these cleanup technologies completed at a pilot scale using syngas from the Eastman Chemical Company's gasifier in Kingsport, Tennessee.

2.2.1 PROJECT LOCATION AND EXISTING FACILITIES

The proposed project would be located at Tampa Electric's 4,348-acre Polk Power Station site in southwestern Polk County, Florida. As shown in Figure 2-1, this site is located approximately 11 miles south of the city of Mulberry, 17 miles south of the city of Lakeland, and 28 miles southeast of the city of Tampa. The Polk Power Station site currently contains five electric generating units and associated facilities, including the nominal 260-MW Polk Unit 1 IGCC plant that began commercial operation in 1996. Polk Unit 1 is fired with syngas produced by gasifying coal and petroleum coke and consists of a nominal 190-MW combustion turbine and a nominal 70-MW heat recovery steam generator and steam turbine. The other four existing Polk units (Units 2 through 5) are 165-MW, simple-cycle combustion turbine facilities fired on natural gas with distillate fuel oil as the backup fuel for Units 2 and 3. The existing power plant facilities are located on the 2,837-acre eastern portion of the Polk Power Station property on the east side of State Road (SR) 37 (see Figure 2-2). Tampa Electric is in the process of donating the 1,511-acre western portion of the site to FDEP as a wildlife management/recreation area.

Jun 26, 2007 - 1:34pm by roberts

M:\eas\070404\DOT msp.dwg

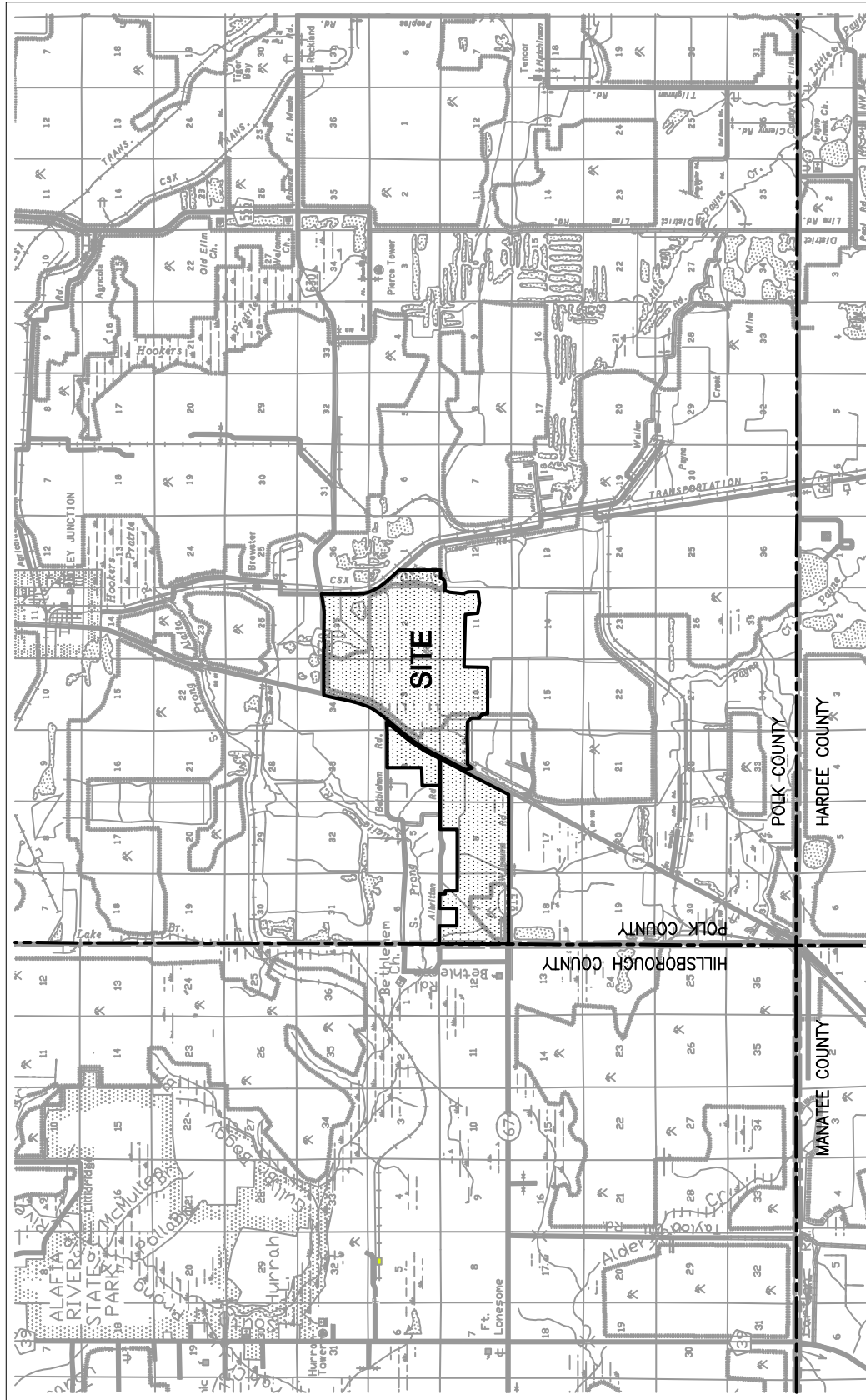

Figure 2-2. General Vicinity Map and Boundaries of the Polk Power Station Site

Sources: FDOT Map, 2000. ECT, 2011.

Figure 2-3 provides a recent aerial photograph of the eastern portion of the Polk Power Station site. Prior to Tampa Electric's construction of the Polk Power Station, which began in November 1994, much of the site was previously impacted by phosphate mining activities and consisted of water-filled mine cuts between spoil piles. The specific portion of the site containing the existing power plant facilities, as well as the area for RTI's proposed project facilities, was not mined but was disturbed by equipment and material storage activities associated with mining. In general, the majority of lands surrounding the site and in the region have also been impacted by phosphate mining operations and currently consist of undeveloped, reclaimed, and unreclaimed lands. Properties to the south and east of the eastern portion of the site contain retired clay settling areas, which contain clay materials produced during phosphate ore processing. Several areas with low-density, scattered residential uses are located more than 1.7 miles west of the project site. These areas are located north of the western portion of the site along Bethlehem and Albritton Roads and west of the site along SR 674 in Hillsborough County. The only other areas of residential development in the site vicinity are located in the unincorporated community of Bradley Junction, approximately 4 miles north of the site.

The Polk Unit 1 IGCC facility represents a technology to cleanly and efficiently generate electricity using coal and other solid fuels. The technology integrates environmental control systems to achieve lower air emissions compared to many other coal-fired generating units. Polk Unit 1 was developed by Tampa Electric with funding support from DOE under its Clean Coal Technology Demonstration Program to demonstrate the commercialization of the IGCC technology. Tampa Electric has successfully operated Polk Unit 1 for more than 15 years.

Key major, existing facilities at the Polk Power Station site include:

- 755-acre cooling reservoir.
- Oxygen-blown gasifier.
- Air separation unit.
- Sulfuric acid plant.
- Slag byproduct storage area.

As shown in Figure 2-3, the existing approximately 755-acre (i.e., water surface) cooling reservoir was constructed by modifying previously mined-out areas. The cooling reservoir is currently primarily used for condenser and other cooling purposes for Polk Unit 1; however, the reservoir was designed during initial development to be capable of providing additional cooling capacity to support the ultimate buildout of the Polk Power Station.

The existing oxygen-blown gasifier facility is used to produce syngas for firing in Polk Unit 1. The existing air separation unit is used to separate air into its primary components: nitrogen and oxygen. The

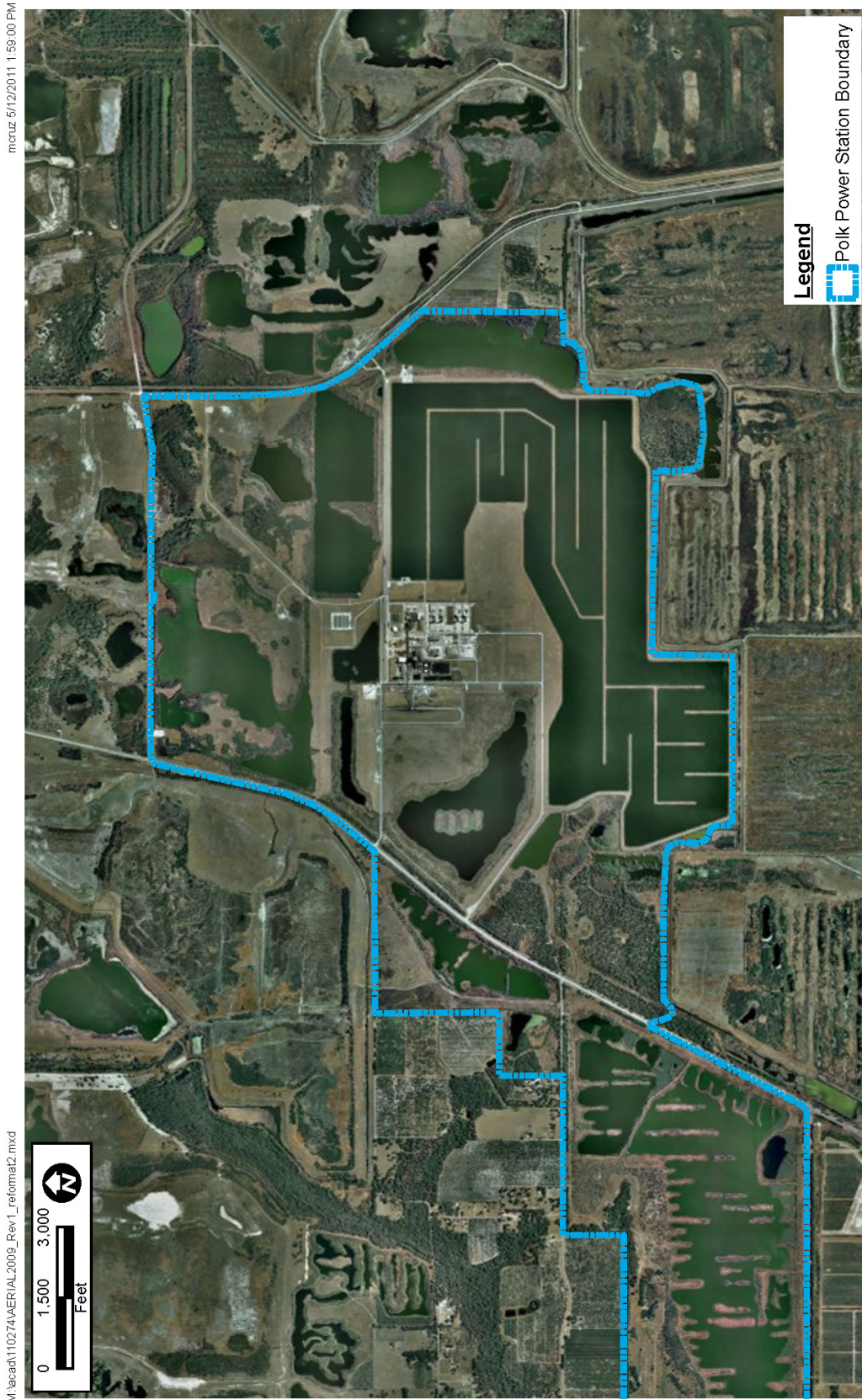

Figure 2-3. Aerial Photograph of Polk Power Station Site

Sources: Aerials Express, 2009. ECT, 2011.

oxygen is used in the fuel gasification process as an oxidant, while the nitrogen is injected into the combustion turbine to control nitrogen oxides (NO_x) emissions, as well as provide power augmentation for Polk Unit 1.

Prior to firing in the Polk Unit 1 combustion turbine, the syngas is treated to remove sulfur compounds. The resultant sulfur-laden gas (i.e., acid gas) removed from the syngas is converted to commercial-grade sulfuric acid in the existing sulfuric acid plant at the Polk Power Station site. This byproduct is sold for offsite commercial uses, and the existing Polk Power Station site includes facilities for the temporary storage and shipment of this byproduct. Slag byproduct from the gasification process for Unit 1 is also currently sold for offsite commercial uses. For the existing Polk Unit 1 operations, noncommercial-grade slag is separated and temporarily stored in the existing lined slag storage area for reuse in the gasification process.

The existing Polk Power Station site is served by four 230-kilovolt (kV) transmission circuits and an onsite substation, a spur from a CSX railroad line, and a Florida Gas Transmission (FGT) natural gas pipeline. Plant process and cooling reservoir makeup water is currently supplied from four onsite ground water wells, and process wastewater is treated and reused within the processes. Potable water is provided from the onsite wells and treatment facility. Sanitary wastewater is disposed through an existing septic system. Other existing onsite facilities include an administration building, control room, warehouse, and construction management building. The main entrance road to the site is from SR 37 on the west side and Fort Green Road on the east side of the site.

As shown in Figure 2-4, RTIs proposed project facilities would be located within an approximately 2.4-acre area adjacent to the existing Polk Unit 1 IGCC facilities to facilitate integration of the proposed project with the IGCC systems. In addition, as shown in Figure 2-4, the proposed project would temporarily utilize two areas totaling approximately 20 acres for construction laydown and parking during the construction period. The project facility area and construction laydown/parking areas currently contain no power plant-related facilities and are primarily covered by mowed native grass.

2.2.2 CONSTRUCTION ACTIVITIES

According to RTI's proposed schedule, construction activities for the project syngas cleanup facilities would start in April 2012, after receipt of applicable environmental permits and approvals, and construction would be completed in March 2013. For the proposed project, Tampa Electric would be responsible for permitting and construction of the deep injection well IW-2 and the required monitoring wells to support the carbon sequestration aspects of the project. Tampa Electric plans to mobilize the drill

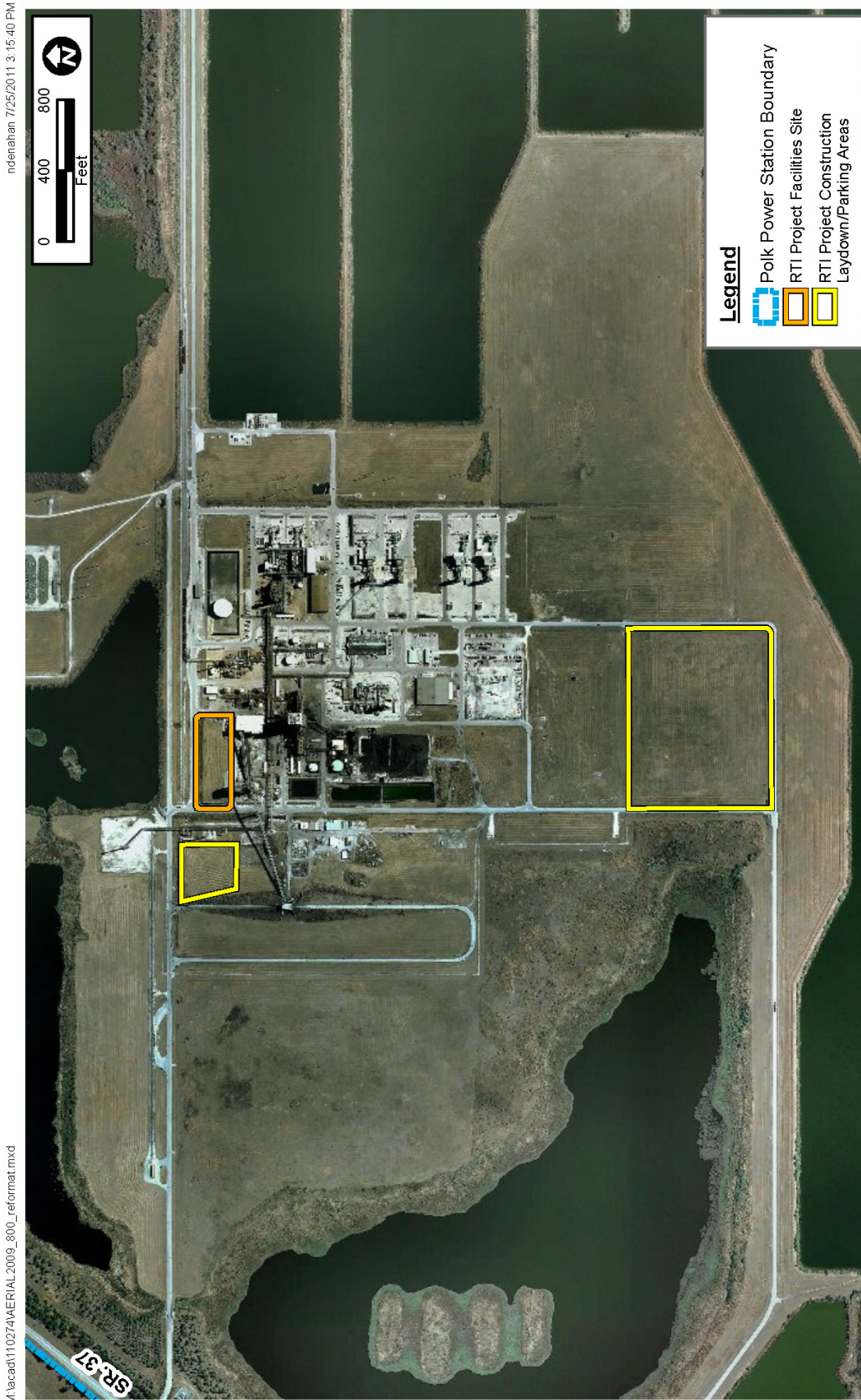

Figure 2-4. Location of RTI Proposed Project Site within the Polk Power Station Site

Sources: Aerials Express, 2009. ECT, 2011.

rig and begin drilling of the injection and monitoring wells in August 2011, with completion of the wells anticipated in June 2013. DOE approved RTI's request for an interim action to proceed with the drilling of the IW-2 injection well prior to completion of the EA and issuance of a FONSI. This decision was based on the onsite location of the well and the anticipation of minimal impacts associated with its development. After a period of system testing and checkout, RTI anticipates that operation of the overall demonstration facilities would begin in the third quarter of 2013 and be completed by the third quarter of 2015. The targeted goal for the project would be to achieve at least 8,000 hours of precommercial scale operations.

Construction of the project facilities would involve the following general activities and phases:

- Construction Mobilization—Construction equipment would be mobilized, and temporary facilities, construction trailers, and prefabrication areas would be established.
- Site Grading—Plot area would be graded to minimize soil erosion and sedimentation. Erosion control measures would be established, and the plot area would be graveled suitable to start work.
- Above/Underground Tie-Ins—Construction would install fire loop and tie into Tampa Electric's existing fire loop system. Storm and oily water drains would be connected to the existing site drain systems. Finally, construction would tie into aboveground tie-in points for utilities as necessary.
- Civil Foundations—Plot would be prepared for foundations. This includes excavation, forming, rebar installation, and concrete pouring.
- Equipment Setting—Equipment would be set on the foundations.
- Structural Steel—Structural steel and pipe-racks would be installed.
- Piping Installation—Piping would be installed followed by hydro-testing.
- Electrical Installation—Appropriate electrical switchgear, cable trays, wiring, and landing would be accomplished.
- Instrument and Controls Installation—Instruments and controls would be installed. Additionally, communications between the field and the distributed control system would be established.

During construction of the proposed project, the majority of the equipment and materials would be delivered to the Polk Power Station site by trucks using the existing roadway system, similar to the construction deliveries for the existing power plant units. The existing main plant access roads from SR 37 on the west side of the site and the access road from Fort Green Road on the east side would be used to accommodate deliveries, as well as the construction workforce. These access roads and

intersections were constructed and used for delivery of equipment and materials for Polk Unit 1 and are anticipated to be adequate to support the proposed project construction activities. Additionally, the CSX railroad network and existing onsite rail spur would be used for oversized equipment.

Once on the site, the equipment and construction materials would be unloaded for immediate erection or placed in designated construction laydown areas using cranes and trucks. The construction laydown and parking areas would be graded, and appropriate drainage provisions would be provided. These areas would include access roads that would typically consist of gravel. A portion of the laydown area would be used for equipment storage and equipment assembly along with space for prefabrication, preassembly, welding, painting, and other activities necessary for the preparation of the equipment. Temporary fencing would be installed around the construction laydown and parking areas. The construction laydown and parking areas would be compacted, and water wagons would be used, as necessary, during the construction activities to control fugitive dust emissions. Also, appropriate stormwater runoff management systems would be provided to control sediment erosion impacts.

2.2.3 SYNGAS CLEANUP SYSTEMS

The proposed project would include scale-up of syngas cleanup technologies developed by RTI and CO₂ capture and sequestration systems. Figure 2-5 provides a simplified block flow diagram of these proposed syngas cleanup and CO₂ capture systems and key tie-ins with existing IGCC facilities.

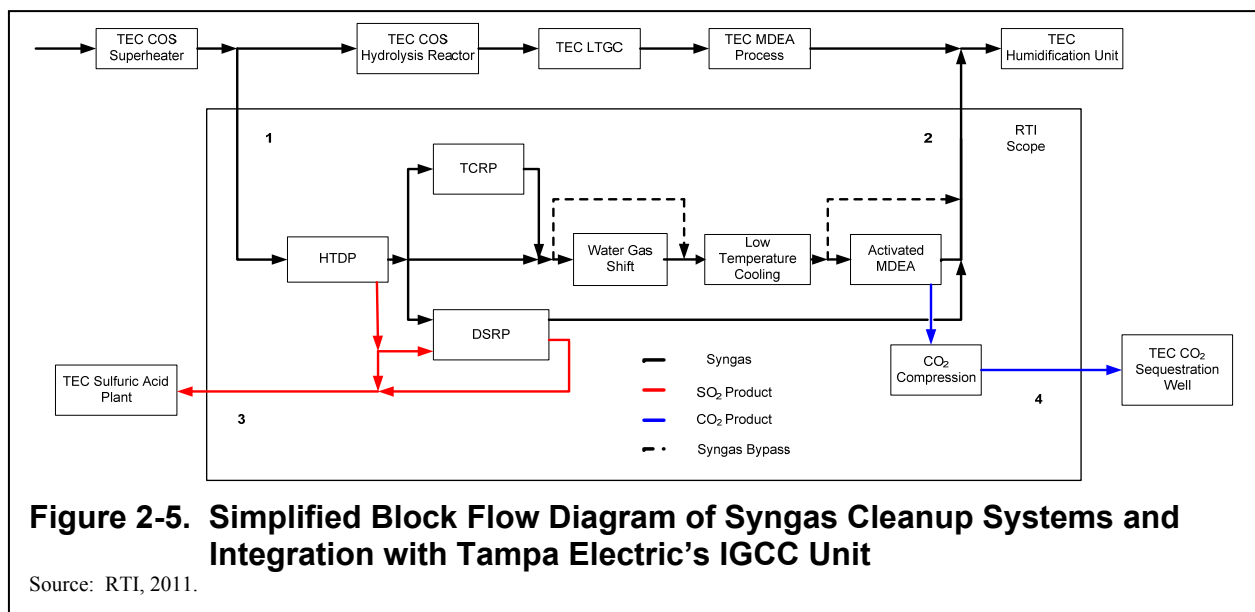

For the proposed project, an up to 66-MW equivalent slipstream of syngas from the existing IGCC plant would be treated in the cleanup systems to mimic commercial operations. The cleanup systems would

remove more than 99.9 percent of the sulfur in the syngas; reduce arsenic, selenium, and mercury concentrations in the syngas; and convert sulfur dioxide (SO₂) to commercial-grade elemental sulfur. The high level of sulfur removal would provide a syngas product from which activated methyldiethanolamine (aMDEA) can be used to capture up to 90 percent of the CO₂ in the cleaned syngas, which would be suitable for geologic sequestration. The CO₂ product generated from the aMDEA system would have a sulfur concentration of less than 100 parts per million by volume (ppmv).

The following descriptions of the proposed project syngas cleanup and CO₂ capture and sequestration technologies are primarily based on information provided by RTI (Gardner, 2011).

The proposed scale-up project would include the demonstration at a precommercial scale of the following syngas cleanup technologies:

- High-temperature desulfurization process (HTDP).
- Trace contaminant removal process (TCRP).
- Direct sulfur recovery process (DSRP).

These cleanup systems would be integrated with Tampa Electric's Polk Unit 1 IGCC facilities.

Figure 2-6 shows the general arrangement of the proposed syngas cleanup systems on the approximately 2.4-acre area within the existing Polk Power Station site layout.

The following subsections provide descriptions of the proposed syngas cleanup processes.

2.2.3.1 High-Temperature Desulfurization Process

A slipstream of syngas from the IGCC plant with a flow rate of up to 2 million standard cubic feet per hour (MMSCFH), which would be equivalent to up to 66 MW of electric power, would be treated in the HTDP system. The untreated syngas would contain a hydrogen sulfide (H₂S) concentration of approximately 7,200 ppmv. The HTDP system consists of two coupled transport reactors, the first serving as the sulfur absorber and the second as the sorbent regenerator. The sulfur absorber utilizes chemical reactions with RTI's proprietary sorbent to remove H₂S and carbonyl sulfide (COS) from the syngas to produce a syngas with a total sulfur concentration of less than 10 ppmv.

In the sorbent regenerator reactor, the sorbent is regenerated by oxidizing the sulfur compounds to produce a flue gas stream containing SO₂. Most of this stream would be directed to Tampa Electric's

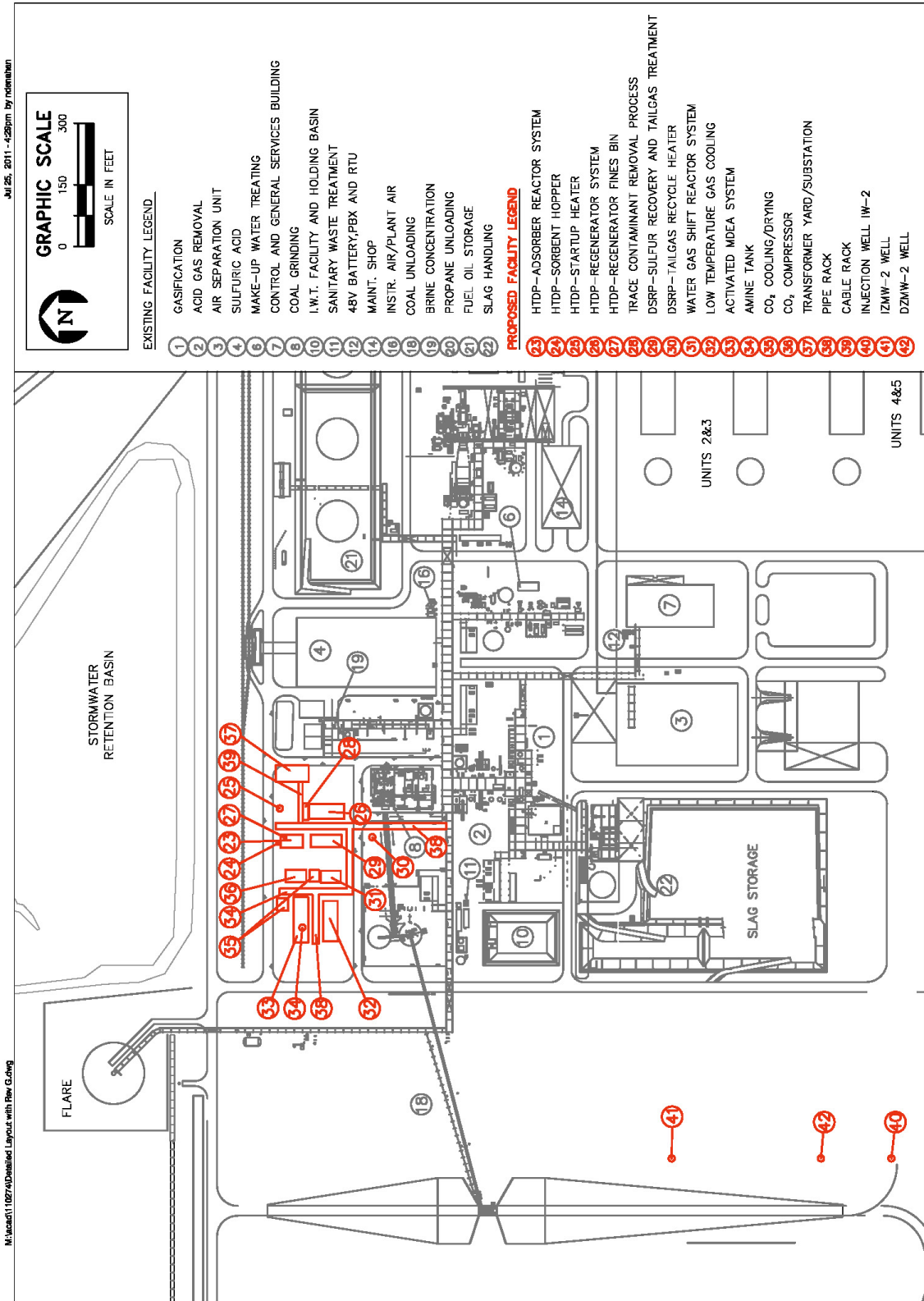

Figure 2-6. General Arrangement of RTI's Proposed Project Facilities within Tampa Electric's Existing Facility Layout

Sources: RTI, 2011. Tampa Electric, 2011. ECT, 2011.

existing sulfuric acid plant, where the SO₂ would be converted to sulfuric acid. As part of the proposed project, a small portion of this SO₂ stream would be routed to the DSRP system.

The HTDP system would involve several intermittent sources of air emissions. During startup of the system, a propane-fired heater, which is vented to the atmosphere, would be used to heat the absorber and regenerator systems. During startups, the regenerator is further preheated using distillate fuel oil. The syngas initially introduced into the absorber and regenerator gases would be sent to Tampa Electric's existing flare to minimize impacts on downstream processes (i.e., combustion turbine and steam turbine), while the gas does not meet specifications during startup. Also, intermittent particulate matter (PM) emissions would occur from the vented sorbent storage hopper and regenerator fines bin.

2.2.3.2 Trace Contaminant Removal Process

A slipstream (equivalent to approximately 5 MW of electric power) of the desulfurized syngas from the HTDP system would be further treated in the TCRP system. The TCRP system would consist of three fixed bed reactors to reduce the concentrations of the arsenic, selenium, and mercury contaminants in the syngas. The mercury reactor would be preceded by a sulfur guard bed to investigate the potential of achieving a higher mercury removal. The treated syngas slipstream would then be recombined with the main desulfurized syngas stream and sent to the water gas shift reactor.

2.2.3.3 Direct Sulfur Recovery Process

In the DSRP system, SO₂ in the small slipstream of SO₂-rich gas from the HTDP regenerator would be converted into approximately 5 tons per day (tpd) of commercial-grade, elemental sulfur. The SO₂ in the slipstream is converted by reducing it with hydrogen and carbon monoxide (CO), and the sulfur product is condensed out of the stream. After analyzing the quality of the elemental sulfur, it would be burned using air to create an SO₂ stream, which is sent to Tampa Electric's sulfuric acid plant.

The DSRP system facilities would include a propane-fired heater, which would be vented to the atmosphere and operated continuously to provide required heat for the DSRP system.

2.2.4 CARBON CAPTURE SYSTEM

For the proposed project, the carbon capture system would produce up to 300,000 tons per year (tpy) of high-quality CO₂, which is suitable for geologic sequestration at the Polk Power Station site. The carbon capture system would be comprised of the following components:

- Water gas shift reactor unit.
- Low-temperature gas cooling unit.

- Activated amine CO₂ capture unit.
- CO₂ compression and drying unit.

The following subsections provide descriptions of these facilities.

2.2.4.1 Water Gas Shift Reactor Unit

In the water gas shift reactor unit, CO in the desulfurized syngas from the HTDP would be converted to CO₂. The system would consist of three fixed-bed reactors operating in parallel and use conventional commercial catalyst technologies. Similar catalysts are used in the processes for producing methanol and ammonia. In the unit, the syngas would be mixed and preheated with steam provided from the IGCC facilities to the reactor inlet temperature of 650 degrees Fahrenheit (°F), with water injected to control the temperature. In the reactions, CO and water would be converted to CO₂ and hydrogen.

2.2.4.2 Low-Temperature Gas Cooling Unit

In the low-temperature gas cooling unit, the product stream from the shift reactor system would be cooled from approximately 650 to 100°F in boiler steam drums using feedwater provided from the Tampa Electric IGCC cooling system and a heat exchanger. The cooling process would generate steam, which would be provided back to the Tampa Electric steam system. Process condensate would also be separated from the gas stream and returned to Tampa Electric's wastewater treatment system.

2.2.4.3 Activated Amine CO₂ Capture Unit

In this unit, the cooled CO₂ in the shifted syngas would be separated from the hydrogen by absorption in the aMDEA absorption column. The proposed aMDEA process technology is commercially available only from BASF. The absorbed CO₂ would be separated from the amine in a regenerator/separation drum and the high-quality CO₂ steam would be piped to the CO₂ compression station. The separated hydrogen-rich stream would be sent back to Tampa Electric's syngas stream to the IGCC plant for firing in the combustion turbine.

2.2.4.4 CO₂ Compression and Drying

The captured CO₂ stream from the aMDEA unit would be compressed in a five-stage compression station from approximately 7 to 1,500 pounds-force per square inch gauge (psig). During the compression process, the water in the CO₂ stream would be removed in a series of interstage knockout drums. The CO₂ would exit the compression station as a supercritical fluid and would be cooled to approximately 120°F in coolers. Condensate collected in the drying process would be treated and sent to Tampa Electric's existing wastewater treatment facilities and/or cooling water system.

2.2.5 CARBON SEQUESTRATION

The compressed CO₂ would be transferred through an approximately 2,100-ft, 6-inch stainless steel, pressurized pipeline to the injection well for injection and sequestration in a deep saline aquifer geologic formation under the Polk Power Station site. As shown in Figure 2-6, the injection well (IW-2) would be located in an open, grassy area adjacent to the southwest corner of the proposed syngas cleanup facilities. Up to 300,000 tpy of CO₂ would be sequestered during the demonstration period for the proposed project. Table 2-1 provides the estimated composition of the high-quality CO₂ stream to be sequestered.

Prior to agreeing to provide the host site for RTI's proposed project, Tampa Electric initiated efforts to permit, drill, and construct two deep injection wells (i.e., IW-1 and IW-2) at the Polk Power Station site to be used for disposal of wastewater from its existing power plant operations. Therefore, as part of the agreement with RTI, Tampa Electric would be responsible for the permitting, drilling, and construction of the injection well (IW-2) that would be used to inject CO₂ for the proposed project. After the CO₂ sequestration aspects of the proposed project have been completed, Tampa Electric would use IW-2 for injection of wastewater. This dual use of IW-2 has been considered in the well design and drilling schedule. This dual-use approach has been discussed with and agreed to by FDEP and EPA Region 4 UIC program staff.

Table 2-1. Estimated Composition of the CO₂ Stream to be Sequestered

Parameter	CO ₂ Stream
Temperature (°F)	120
Pressure (psig)	1,500
Composition (molar %)	
Hydrogen gas	0.50
CO	0.05
CO ₂	99.44
Nitrogen	0.01
Argon	0.00
Methane	0.00
H ₂ S	<100 ppmv
COS	<10 ppmv
Water	<15 ppmv
Ammonia	0.00
SO ₂	
Oxygen	
Total	100.00

Source: RTI, 2011.

The following subsections describe the proposed injection zone at the site; injection and monitoring permitting efforts; well design and drilling/construction activities; operations and maintenance plans; and proposed monitoring, verification, and accounting program.

2.2.5.1 Target Injection Zone

The targeted CO₂ injection zone for the proposed project would be a deep saline carbonate (dolomite/limestone) reservoir system extending between 4,200 and 8,000 feet below land surface (ft bls). This zone includes the lower Cedar Keys Formation of Paleocene Age, the Lawson limestone (which may correlate to the upper Pine Key Formation), and the Pine Key Formation of the Upper Cretaceous Age.

Much of the data and information initially used to characterize the upper portion of this injection zone were obtained from the KCI Mulberry UIC injection well that began operations in the mid 1970s and is located approximately 10 miles north of the Polk Power Station site. Tampa Electric recently completed the drilling of IW-1 through this depth interval and performed various sampling, logging, and testing activities to improve the site-specific characterization of the injection zone.

Based on review of the site-specific testing completed to date, plus the available regional deep geologic information (Amato *et al.*, 1986; Chen, 1965; FDEP, 2010; USF, 2011; USGS, 2010; and Winston, 1994), several relevant observations can be made regarding the injection zone:

- A laterally continuous, thick (more than 1,000 foot [ft]) low permeability confining unit (cap rock) is present.
- Fractures, faults, or folds potentially serving as traps or migration pathways are not present.
- Major horizontal variation in depositional environment (and hence the carbonate strata) are not expected.
- The nearest penetration of the confining unit is located approximately 10 miles away.
- Suitable zones for CO₂ storage with horizontal porosity and permeability are present.
- Vertical variations of porosity and permeability are expected to enhance CO₂ storage capacity.
- West-central Florida is seismically stable and experiences little seismic activity.
- The hydrodynamic (physical) and geochemical properties are favorable for long-term CO₂ storage.

Therefore, the proposed subsurface injection zone is expected to be both viable and well suited for the purpose of the proposed CO₂ sequestration demonstration project.

2.2.5.2 Injection and Monitoring Well Permitting

Tampa Electric recently completed the drilling of IW-1 and its associated dual zone monitoring well, DZMW-1. This well and its associated monitoring well were permitted individually as UIC Class V, Group 9 exploratory borings. Upon the completion of its installation, Tampa Electric will submit a Class I construction/testing well permit application for IW-1 for industrial wastewater injection (late summer/early fall 2011). Following between 18 to 24 months of preliminary testing, a subsequent Class I operational UIC well permit will be obtained (early to mid-2013). Information gained from the drilling and testing program for IW-1 would be incorporated into the permit application for IW-2.

In April 2010 and prior to agreeing to host the proposed project, Tampa Electric submitted a UIC Class V, Group 9 exploratory boring permit application for IW-2 and DZMW-2, which would be used for wastewater injection and monitoring. In May 2011, FDEP announced its notice to issue this UIC permit effective in June 2011. Approval of this permit allows Tampa Electric to avoid unnecessary drilling schedule delays or additional costs resulting from mobilizing a new contractor or remobilizing the same drilling contractor, or alternatively resulting from undesirable idle rig time waiting for permit approval to start drilling the IW-2 wells. For the proposed project, DOE also considered the cost and schedule effectiveness of proceeding with the drilling of IW-2, as well as any environmental impacts, and approved RTI's request for an interim action to proceed with the drilling prior to completion of the EA and issuance of a FONSI. This decision was based on the onsite location of the well and the anticipation of no significant environmental impacts associated with its development.

An injection zone monitoring well (IZMW-2) would also be added to this Class V, Group 9 permit through a UIC permit modification (June 2011). However, unlike the Class I construction/testing permit anticipated for IW-1, for the purpose and duration of the proposed demonstration project, the IW-2 wells would be covered by a UIC Class V experimental technology well permit. It is anticipated that this Class V experimental technology well permit application will be submitted in July 2011. The permitting of the carbon sequestration demonstration project using the UIC Class V experimental technology well approach is consistent with that taken at numerous other proposed carbon sequestration pilot projects (e.g., Frio, Texas [Kopema, 2007], and Plant Daniel, Mississippi [Papadeas *et al.*, 2005]). Additionally, the proposed permitting approach is consistent with UIC Program Guidance No. 83, issued by EPA on March 1, 2007. Upon the completion of the demonstration project, Tampa Electric plans to operate IW-2 and DZMW-2 under a subsequent Class I industrial UIC well permit for wastewater injection. This permitting approach has been discussed with and agreed to by FDEP and EPA Region 4 UIC program staff.

2.2.5.3 Well Design and Drilling/Construction

Figure 2-7 provides an illustration of the proposed UIC well design for IW-2. The basic design for IW-2 would be similar to that approved and implemented for IW-1. A series of telescoping steel casings would be designed to isolate the overlying underground source of drinking water (USDW) from the proposed injection zone located beneath the confining unit. These casings would include:

- 52-inch diameter steel casing in an approximately 60-inch diameter borehole to approximately 300 ft bls.
- 42-inch diameter steel casing in an approximately 50-inch diameter borehole to approximately 1,200 ft bls.

- 28-inch diameter steel casing in an approximately 40-inch diameter borehole to approximately 3,300 ft bls (based on the lowermost USDW at approximately 3,000 ft).

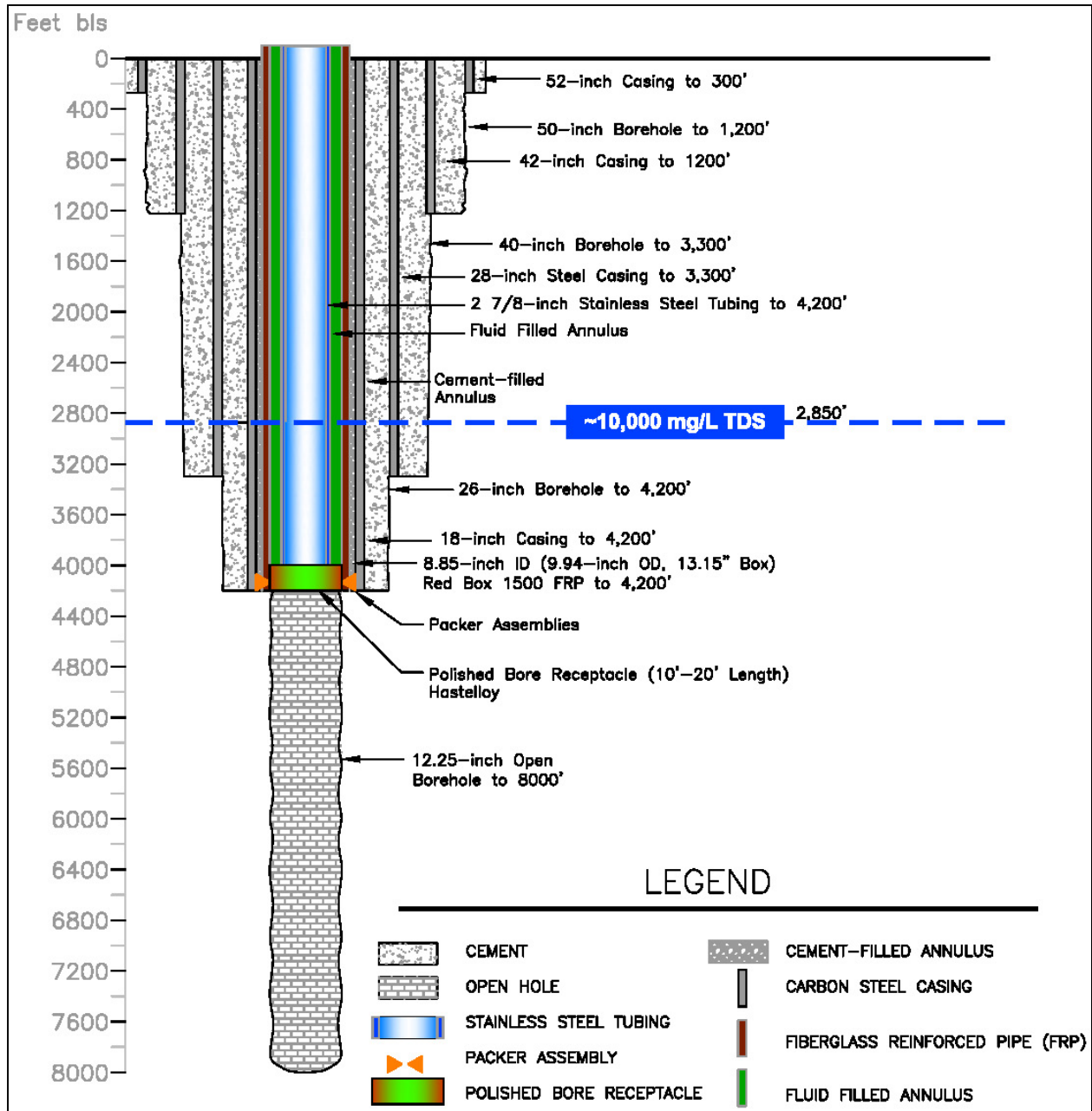

Figure 2-7. Injection Well IW-2 Design, Tubing, and Fluid-Filled Annulus Details for Carbon Sequestration

Source: ECT, 2011.

- 18-inch diameter steel casing in an approximately 26-inch diameter borehole to approximately 4,200 ft bls.
- 12.25-inch open borehole to approximately 8,000 ft bls.

Inside the 18-inch diameter steel casing, 8.85-inch inner diameter fiberglass reinforced piping (FRP) would be grouted in place using a cement-filled annulus. The lower 500 ft of the outer borehole and the cement-filled annulus would be grouted with CO₂-resistant cement.

In order for the well to be used for CO₂ injection for the proposed project, there would be two main differences in the design of IW-1 and IW-2. These differences would include the use of a polished borehole receptacle (PBR) and a stainless steel tubing and packer system. The PBR would consist of a short 10- to 20-ft segment of corrosion-resistant, high-performance alloy pipe placed at the bottom (lowest/last casing portion) of the FRP (Figure 2-7). The PBR would provide a smooth metal surface wherein the bottom packer system would be seated for the smaller diameter stainless steel tubing through which the CO₂ would be injected. Details of the final design of IW-2 would be determined in the approved UIC Class V experimental technology well construction permit.

The proposed well design of IW-2 would allow for the CO₂ injection zone to be: (1) vertically isolated from the USDW by a laterally continuous stratigraphic unit that is more than 1,000 ft thick and contains numerous layers with vertical permeabilities that are less than 10⁻⁸ centimeters per second (cm/sec); and (2) horizontally isolated from the USDW by four (one stainless steel, one FRP, two carbon steel) casings, one fluid-filled annulus, and approximately 9 inches of cement. The lower 500 ft of the outer borehole and the cement-filled annulus would be grouted with CO₂-resistant cement.

Figure 2-8 provides an illustration of the proposed well design for DZMW-2. A series of telescoping steel casings would be designed to isolate selected intervals throughout the USDW above a substantial confining unit. These casings would include:

- 24-inch diameter steel casing in an approximately 30-inch diameter borehole to approximately 300 ft bls.
- 16-inch diameter steel casing in an approximately 23-inch diameter borehole to approximately 1,100 ft bls (upper DZMW).
- 6.21-inch diameter FRP casing in an approximately 15-inch diameter borehole to approximately 2,800 ft bls.
- 6-inch open borehole to approximately 2,850 to 2,900 ft bls (lower DZMW).

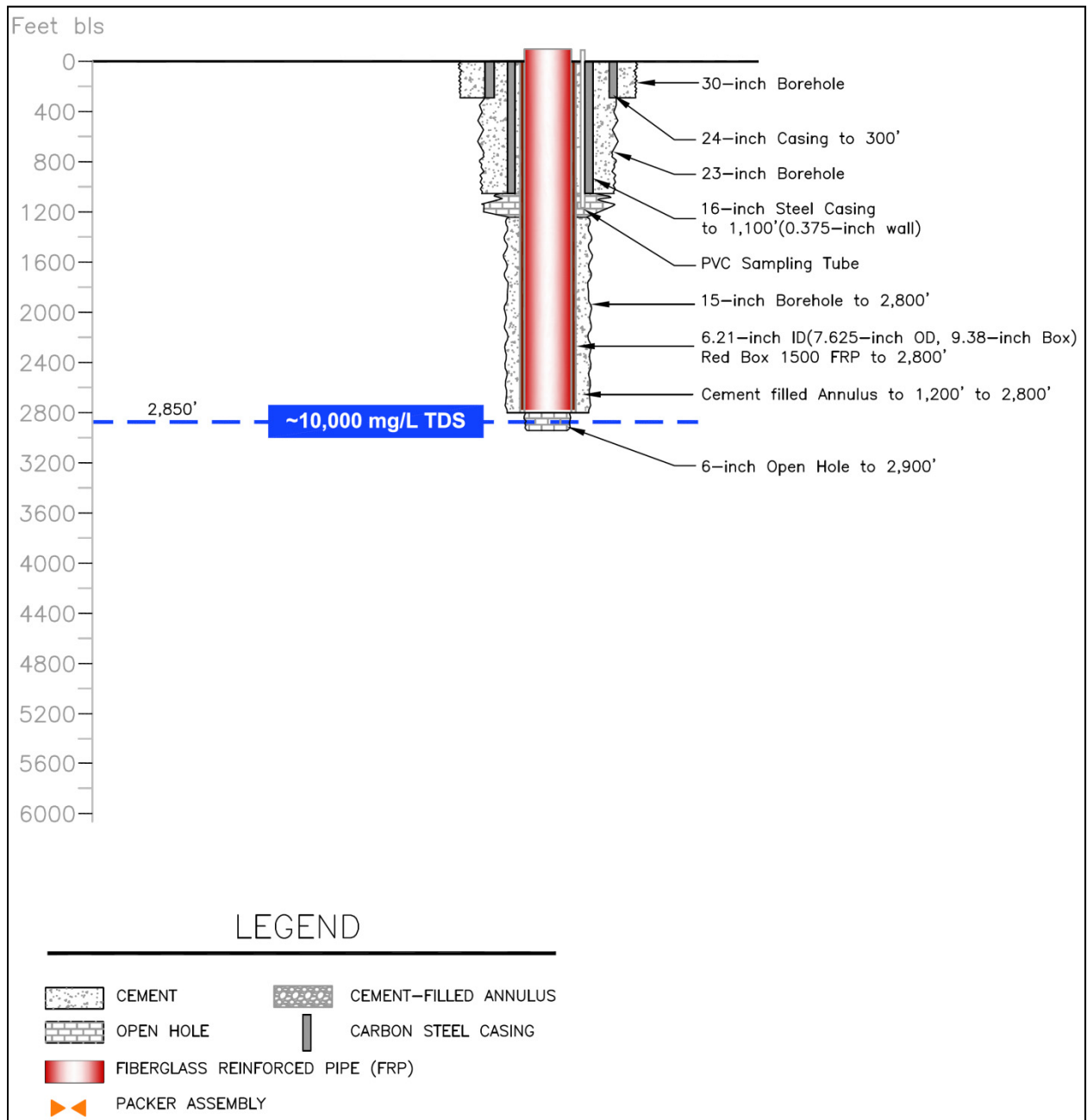

Figure 2-8. Dual Zone Monitoring Well DZMW-2 Design Details

Source: ECT, 2011.

The two zones within the DZMW would be used to measure various parameters including selected water quality constituents, temperature, and pressure to detect for potential leakage of either CO₂ or wastewater through the confining unit and into the USDW.

Figure 2-9 presents an illustration of the proposed well design for the injection zone monitoring well, IZMW-2. The purpose of this well would be to support the evaluation of and accounting for the CO₂ injected into the subsurface as part of the proposed project. For this well, a series of telescoping steel casings would be designed to isolate selected intervals throughout the USDW above a substantial confining unit. These casings include:

- 36-inch diameter steel casing in an approximately 42-inch diameter borehole to approximately 300 ft bls.
- 24-inch diameter steel casing in an approximately 32-inch diameter borehole to approximately 1,200 ft bls.
- 16-inch diameter steel casing in an approximately 23-inch diameter borehole to approximately 3,300 ft bls.
- 6.21-inch diameter FRP casing in an approximately 15-inch diameter borehole to approximately 4,200 ft bls.
- 12.25-inch open borehole to approximately 8,000 ft bls.

The proposed well design of IZMW-2 would allow for the CO₂ injection interval to be: (1) vertically isolated from the USDW by a laterally continuous stratigraphic unit that is more than 1,000 ft thick; and (2) horizontally isolated from the USDW by two (one FRP and one carbon steel) casings and approximately 8.5 inches of cement. The lower 500 ft of the outer borehole would be grouted with CO₂-resistant cement.

Similar to the IW-1 well drilling, the IW-2 well would be drilled using the largest electric drilling rig operational in the southeastern United States. The drill rig would be equipped with fluid containment systems to handle all drilling fluids and muds to minimize potential impacts in the vicinity of the well site. Mud rotary methods would be used to set the casing at the 300-ft depth interval, but the drilling method would be switched to reverse air rotary drilling methods to complete the drilling to the 1,200-ft depth and set the next casing. Using the reverse air drilling method would minimize the amount of water required to support the drilling operations. The drilling fluids and produced waters would be contained in metal drilling pad and mud tanks, and groundwater in proximity to the well site and drilling pad would be monitored weekly using a series of perimeter monitoring wells. This drilling rig has the torque necessary

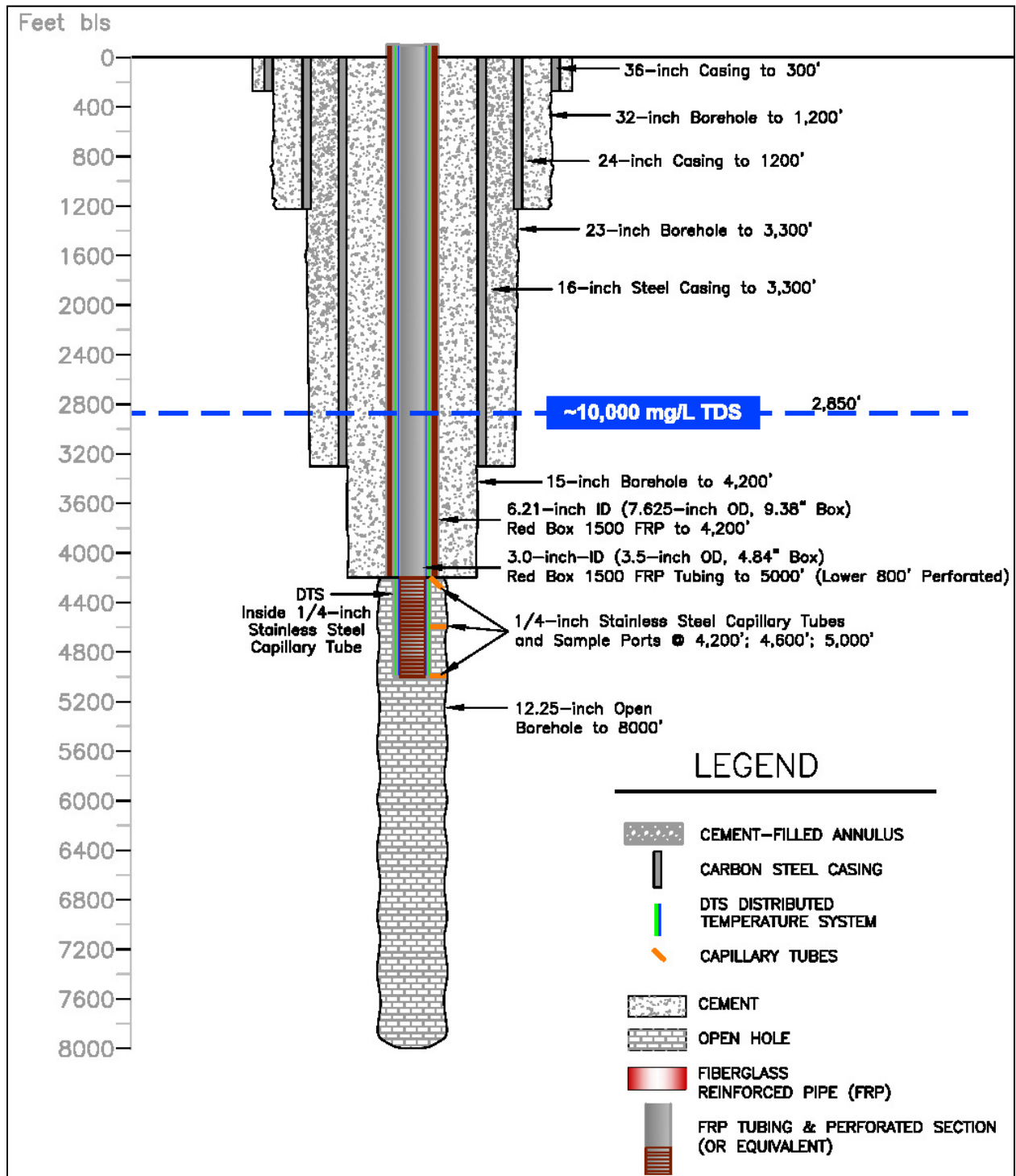

Figure 2-9. Injection Zone Monitoring Well IZMW-2 Design Details

Source: ECT, 2011.

to drill the large diameter boreholes required for the project plus top head capacity to manage 8,000+ ft of drill string.

2.2.5.4 Operations and Maintenance Plans

For the proposed project, CO₂ capture and sequestration activities would take place over approximately an 18-month period targeted to start in the third quarter of calendar year 2013. During this period, the proposed project would be expected to inject and sequester CO₂ at a rate of approximately 300,000 tpy into the more than 4,200-ft-bls deep saline carbonate formation.

Some of the anticipated routine injection well operational monitoring requirements are described in the subsequent section. During the CO injection and UIC Class V experimental technology well operation, the fluid filled annulus between the FRP and stainless steel tubing (described in the preceding section) would also be monitored and its associated equipment maintained. Details of the operating and monitoring requirements would be determined in the final approved UIC permit.

2.2.5.5 Monitoring, Verification, and Accounting Program

The DOE (2009) NETL Best Practices Manual for “Monitoring, Verification, and Accounting of CO₂ Stored in Deep Geologic Formations” provides a detailed list of different monitoring, verification, and accounting (MVA) techniques either previously tested or proposed to be tested at various carbon capture and sequestration projects. The MVA program developed for this proposed project would use information presented in this document, including the formatting style from some of its tables. A summary of the proposed MVA program is provided in the following discussion, and the detailed program will be included as an appendix to the UIC Class V experimental technology well permit application for IW-2 and the associated monitoring wells.

The overall goals of the MVA program would be to demonstrate: (1) implementation of the proposed carbon capture and sequestration project would be safe; (2) the capture and storage aspects would provide effective CO₂ control and would not create adverse environmental impacts; (3) and the project and MVA program would be compliant with the applicable regulations.

The fundamental goals and objectives of the proposed MVA program would be as follows (DOE, 2009):

- Understand the CO₂ storage processes and demonstrate their effectiveness.
- Evaluate the geochemical interactions of CO₂ with and mobility through the injection zone formation solids and brine fluids.

- Assess the potential for environmental, health, and safety impacts as a result of the CO₂ injection and in case of a leak to the atmosphere.
- Evaluate and monitor required corrective actions in the event a leak should occur.

The intent of the MVA plan would be to present and explain the specific approach, technologies, and methodologies developed for this site (see Table 2-2).

Table 2-3 summarizes the main environmental monitoring zones and the different proposed MVA techniques for the proposed project. Figure 2-10 illustrates the surface locations for these various monitoring stations. Table 2-3 provides a brief description of the key monitoring objectives for each of the different monitoring zones and provides a distinction as to whether the methods proposed are considered primary, secondary, or potential additional MVA technologies. In short, the primary technologies would be proven methods associated with carbon capture and sequestration projects that typically require the direct placement of monitoring equipment or collection of data through invasive techniques (well drilling, sample coring, etc.) and, as such, would be generally constrained to fixed locations. However, the secondary and potential additional technologies would be less proven methods for carbon capture and sequestration projects but could often be used in less invasive or noninvasive applications. As such, the secondary and potential additional technologies would be used to compliment the information obtained from the primary technologies and help to better assess the CO₂ plume location and areas of potential leakage over larger spatial scales.

Table 2-2. Summary of Pre-, During, and Post-CO₂ Monitoring Program	
Proposed MVA Program	
Pre-CO₂ injection period	
Geophysical well logs	
Wellhead pressure	
Formation pressure	
Injection rate testing	
Seismic survey (VSP walk-out survey)	
Atmospheric CO ₂ monitoring	
Pressure and water quality within and above storage formation	
During CO₂ injection period	
Geophysical well logs	
Wellhead pressure	
Formation pressure	
Annulus pressure	
Injection rate	
Seismic survey (VSP walk-out survey)	
CO ₂ and oxygen flux monitoring	
Pressure and water quality within and above storage formation	
Active source thermal logging	
Post-CO₂ injection (closure) period	
Seismic survey (VSP walk-out survey)	
Pressure and water quality within and above storage formation	
Routine UIC monitoring for wastewater injection	
Sources: DOE, 2009. ECT, 2011.	

Table 2-3. Monitoring Zones and Technology Stages Proposed for RTI's Proposed Project at the Tampa Electric Polk Power Station

Objectives	Primary Technologies	Secondary Technologies	Potential Additional Technologies
<p>Atmospheric monitoring</p> <p><i>Objectives:</i></p> <ul style="list-style-type: none"> • Ambient CO₂ concentration • Leak detection <p>Near surface monitoring</p> <p><i>Objectives:</i></p> <ul style="list-style-type: none"> • Groundwater monitoring • Fluid chemistry • Soil gas monitoring • Crustal deformation • Leak detection • Vadose zone characterization 	<p>CO₂ Detection CO₂ detectors (Ambient CO₂ concentration)</p> <p>Geochemical analysis (Groundwater monitoring) (Fluid chemistry)</p>	<p>Advanced Water Quality Analysis</p> <ul style="list-style-type: none"> • Inorganics and organics • Isotopes • Total organic and inorganic carbon <p>Soil-Vadose Zone Gas Monitoring</p>	<p>CO₂ Detection Isotopes</p> <p>Tracers (<i>Leak Detection</i>)</p> <ul style="list-style-type: none"> • Noble gases/isotopes/perfluorocarbons <p>Remote sensing (<i>Crustal Deformation</i>)</p> <ul style="list-style-type: none"> • Synthetic aperture radar and InSAR
<p>Subsurface monitoring</p> <p><i>Objectives:</i></p> <ul style="list-style-type: none"> • Groundwater monitoring • Soil gas monitoring • Leak detection • Subsurface-reservoir characterization • Plume tracking • Well integrity testing 	<p>Water Quality Analysis</p> <ul style="list-style-type: none"> • Injection fluid monitoring • Formation fluid monitoring • Water level <p>Caprock integrity (Characterization)</p> <ul style="list-style-type: none"> • Geomechanical analysis • Core collection <p>Wireline Logging (<i>Well Integrity</i>)</p> <ul style="list-style-type: none"> • Temperature • Noise • Cement bond • Density • Gamma ray • Sonic (acoustic) <p>Physical Testing (<i>Well Integrity</i>)</p> <ul style="list-style-type: none"> • Annulus pressure • Injection volume/rate • Wellhead pressure • Downhole pressure • Downhole temperature 	<p>Seismic Surveying</p> <ul style="list-style-type: none"> • VSP <p>Geochemistry</p> <ul style="list-style-type: none"> • Brine/fluid composition • Tracer injection/monitoring <p>Injection well logging</p> <ul style="list-style-type: none"> • Temperature logging • Reservoir saturation tool • Optical 	<p>Geophysical Techniques</p> <ul style="list-style-type: none"> • Wireline logging <ul style="list-style-type: none"> ○ Resistivity ○ Specialty logging

Sources: DOE, 2009.
ECT, 2011.

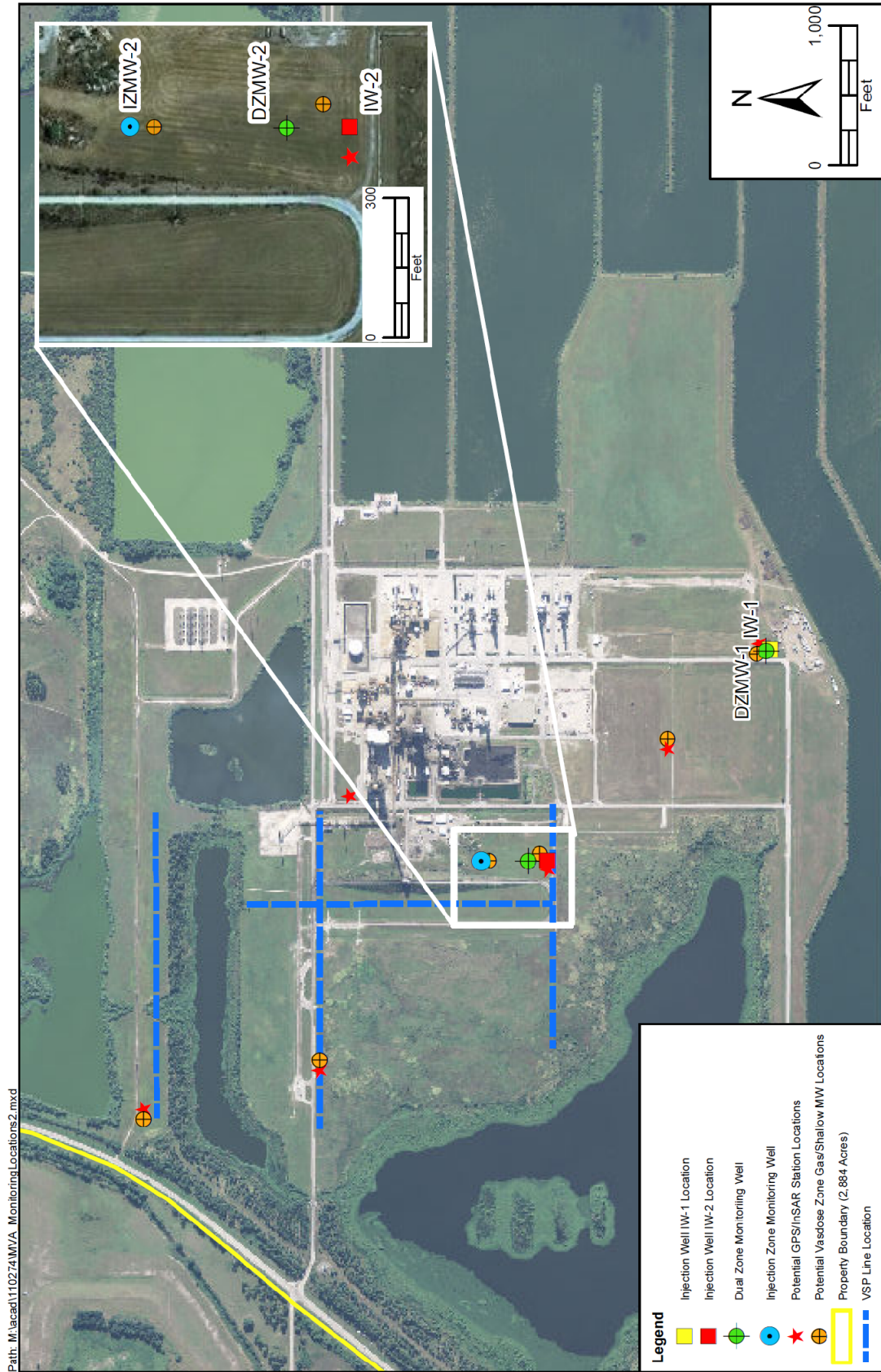

Figure 2-10. MVA Monitoring Locations

Sources: SWFWMD Aerial Photography, 2009,
ECT, 2011.

In summary, the proposed MVA technologies would likely include the following:

- Atmospheric monitoring:
 - CO₂ detectors.
 - Tracers (isotopes/injected compounds such as perfluorocarbon tracers [PFTs]).
- Near-surface monitoring:
 - Geochemical/advanced groundwater monitoring.
 - Soil-vadose zone gas monitoring.
 - Tracers (isotopes/injected compounds such as PFTs).
 - Remote sensing-interferometric synthetic aperture radar (InSAR) monitoring (test for viability prior to sitewide deployment).
- Subsurface monitoring:
 - Physical monitoring of injection pressures, volumes, rates, and temperatures.
 - Caprock integrity (via cores and geomechanical analysis).
 - Wireline geophysical logging (including some specialty logs).
 - Water quality, geochemistry, and fluid level/pressure monitoring.
 - Vertical seismic profiling (walkout surveys).
 - Tracer injection monitoring (within wastewater and possibly CO₂ gas).

Based on site-specific conditions, plus the different types and level of proposed monitoring activities, the proposed MVA program would be expected to satisfy the primary MVA goals and fundamental objectives associated with the proposed demonstration project. Ultimately, details of the MVA requirements would be determined in the final approved UIC permit.

2.3 NO-ACTION ALTERNATIVE

Under the no-action alternative, DOE would not provide cost-shared funding to RTI for the proposed project. In the absence of DOE funding, DOE assumes that RTI would not proceed with the proposed project, and any potential environmental impacts of the project would not occur, except that Tampa Electric would proceed with its plans to construct deep injection well IW-2 for disposal of wastewater from its existing power plant operations. Further, under the no-action alternative, DOE's efforts to advance clean energy technologies, improve energy security using domestic resources, and reduce GHG levels would be delayed.

3.0 AFFECTED ENVIRONMENT AND ENVIRONMENTAL CONSEQUENCES

This chapter provides descriptions of the affected environment and analyses of the environmental consequences of the proposed project and the no-action alternative for the following resource areas:

- Air quality.
- Geology and soils.
- Water resources.
- Socioeconomics.
- Transportation.
- Waste management.
- Human health and safety.

3.1 AIR QUALITY

3.1.1 AFFECTED ENVIRONMENT

3.1.1.1 Climatology and Meteorology

The proposed project site at the Polk Power Station in Polk County, Florida, lies within the Northern Hemisphere's humid subtropical climate zone. This zone is noted for long, hot, and humid summers and mild and wet winters. The central Florida climate is also affected by maritime influences from the Atlantic Ocean and the Gulf of Mexico.

Table 3-1 provides a summary of monthly mean and extreme temperatures based on National Weather Service (NWS) data collected at Wauchula, Florida, for the period of record from 1971 through 2000. The Wauchula weather station is located in Hardee County, approximately 19 miles southeast of the Polk Power Station site, and is the nearest representative NWS surface observation station with available temperature and precipitation data. A slightly closer station is located in Bartow, approximately 15 miles to the northeast. However, the area surrounding the Wauchula station is more rural and, therefore, more similar to the proposed project site. As shown in Table 3-1, monthly mean temperatures vary by only 20°F. Temperatures above 90°F have occurred in every month except January, which had a highest recorded temperature of 88°F. From 1971 through 2000, there were only 5 days with below-freezing temperatures.

Based on historical records, rainfall in the vicinity of the site varies widely from month to month. Table 3-2 presents 30-year rainfall records from the Wauchula weather station. Average rainfall is greatest during the summer months, when convective thunderstorms are likely, and lower for the remainder of the year, especially in the winter months. Table 3-2 also shows daily and monthly extremes. The maximum daily rainfall has ranged from 2.74 to 7.6 inches. Monthly precipitation has varied from 0 to more than 15 inches.

Table 3-1. Ambient Temperatures Measured at Wauchula, Florida

Month	Daily				Monthly		
	Mean Maximum	Mean Minimum	Highest	Lowest	Lowest Mean	Mean	Highest Mean
January	72.8	48.5	88	20	51.0	60.7	69.5
February	74.3	49.2	93	25	54.6	61.8	68.2
March	78.7	53.2	94+	23	61.9	66.0	71.0
April	83.1	57.4	97	34	65.7	70.3	73.5
May	88.3	63.7	101+	44	72.3	76.0	79.6
June	90.7	69.6	102	51	77.5	80.2	83.4
July	91.6	71.2	100+	57	79.3	81.4	83.5
August	91.7	71.7	98+	58	80.4	81.7	83.3
September	89.9	70.7	99	55	78.7+	80.3	82.1
October	85.1	64.2	95+	39	71.4	74.7	79.0
November	79.3	56.8	90+	24	63.6	68.1	74.7
December	74.2	50.7	92	21	57.5	62.5	68.4
Annual	83.3	60.6	102	20	51.0	72.0	83.5

Note: Highest and lowest daily temperatures based on complete station record (i.e., 1948 to 2001).
Mean temperatures based on years 1971 through 2000.
Temperatures are degrees Fahrenheit.

Sources: National Climatic Data Center (NCDC), Climatology of the United States: No. 20, 1971-2000.
ECT, 2011.

Table 3-2. Normal and Extreme Precipitation Measured at Wauchula, Florida

Month	Monthly Normals			Extremes		
	Mean	Median	Highest Daily	Highest Monthly	Lowest Monthly	
January	2.30	1.85	2.74	7.84	0.00	
February	2.63	2.07	4.40	8.82	0.00	
March	3.27	2.47	5.75	12.14	0.30	
April	2.37	1.92	5.55	6.60	0.00	
May	3.83	3.13	5.72	8.39	0.00	
June	7.92	7.52	6.05	15.96	1.69	
July	7.85	8.35	4.73	12.46	2.21	
August	7.37	7.32	6.94	12.76	2.66	
September	6.17	5.62	5.33	11.56	1.44	
October	2.68	1.75	6.32	10.36	0.00	
November	2.05	1.24	7.60	11.18	0.12	
December	2.00	1.51	3.96	6.29	0.28	
Annual	50.44	51.47	7.60	15.96	0.00	

Note: Precipitation is in inches.

Sources: NCDC, Climatology of the United States: No. 20, 1971-2000.
ECT, 2011.

The nearest representative station with detailed wind data is located at the Orlando International Airport, approximately 63 miles northeast of the Polk Power Station. There are a number of other weather stations closer to the site, but they were not considered to be as representative because of their coastal locations. The observations at these other stations could be expected to be affected more by the Gulf of Mexico, and thus experience routine on- and off-shore breezes. Therefore, the Orlando International Airport is expected to have wind patterns more representative of the proposed project site's inland location. Figure 3-1 provides a 5-year annual wind rose based on wind speed and direction observed for the years 1996 through 2000. Figure 3-2 depicts 5-year seasonal wind roses for the same station. The information presented in these figures represents the percentage of time the wind blows from a particular direction at a given speed. Although there is no single prevailing wind direction throughout the year, the winds are slightly more predominant from the easterly direction (56 through 101 degrees), which occurs approximately 15 percent of the time, with another 7+ percent from the north and 6+ percent from the south. Winds in the spring predominate from the southern sector, and southwesterly winds are common during summer months. In the fall, winds mostly occur from the northeast quadrant, and there is a strong northerly wind component in the winter. The average wind speed over the 5-year period was 7.5 miles per hour (mph). Spring has the highest winds at 8.4 mph. The lowest average winds are in the summer at 6.3 mph.

3.1.1.2 Ambient Air Quality Conditions

The ambient air quality in an area can be characterized in relation to the National Ambient Air Quality Standards (NAAQS). NAAQS have been established for six common air pollutants selected because of their prevalence and importance to human health and welfare: CO, nitrogen dioxide (NO₂), SO₂, ozone, particulate matter less than 10 and 2.5 microns in aerodynamic diameter (PM₁₀ and PM_{2.5}, respectively), and lead. These are also commonly referred to as criteria pollutants, because the limits are largely based on health criteria. Primary NAAQS were established to protect human health, and secondary NAAQS were designed to protect the environment and physical property.

Table 3-3 shows the primary NAAQS. The secondary standards are the same as the primary NAAQS for most pollutants. However, there are no secondary standards for CO or for the NO₂ and SO₂ 1-hour averaging times. Also, there is a 3-hour secondary standard for SO₂, but no primary standard associated with that averaging time. Except for establishing slightly lower SO₂ standards for the annual and 3-hour averaging periods, Florida has adopted the NAAQS.

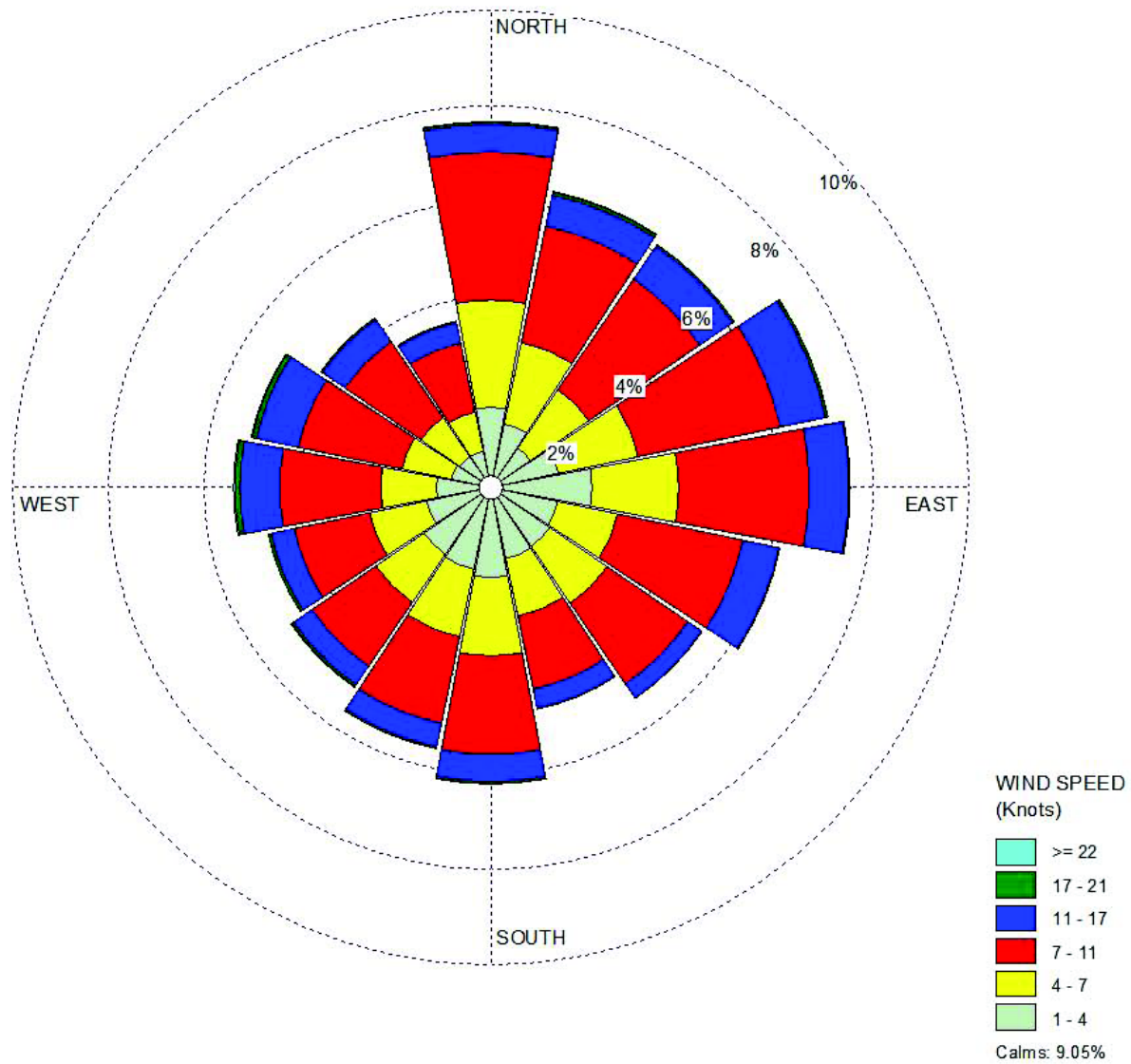

Figure 3-1. 5-Year Annual Wind Rose, Orlando International Airport, 1996 through 2000

Source: NCDC, 2002.

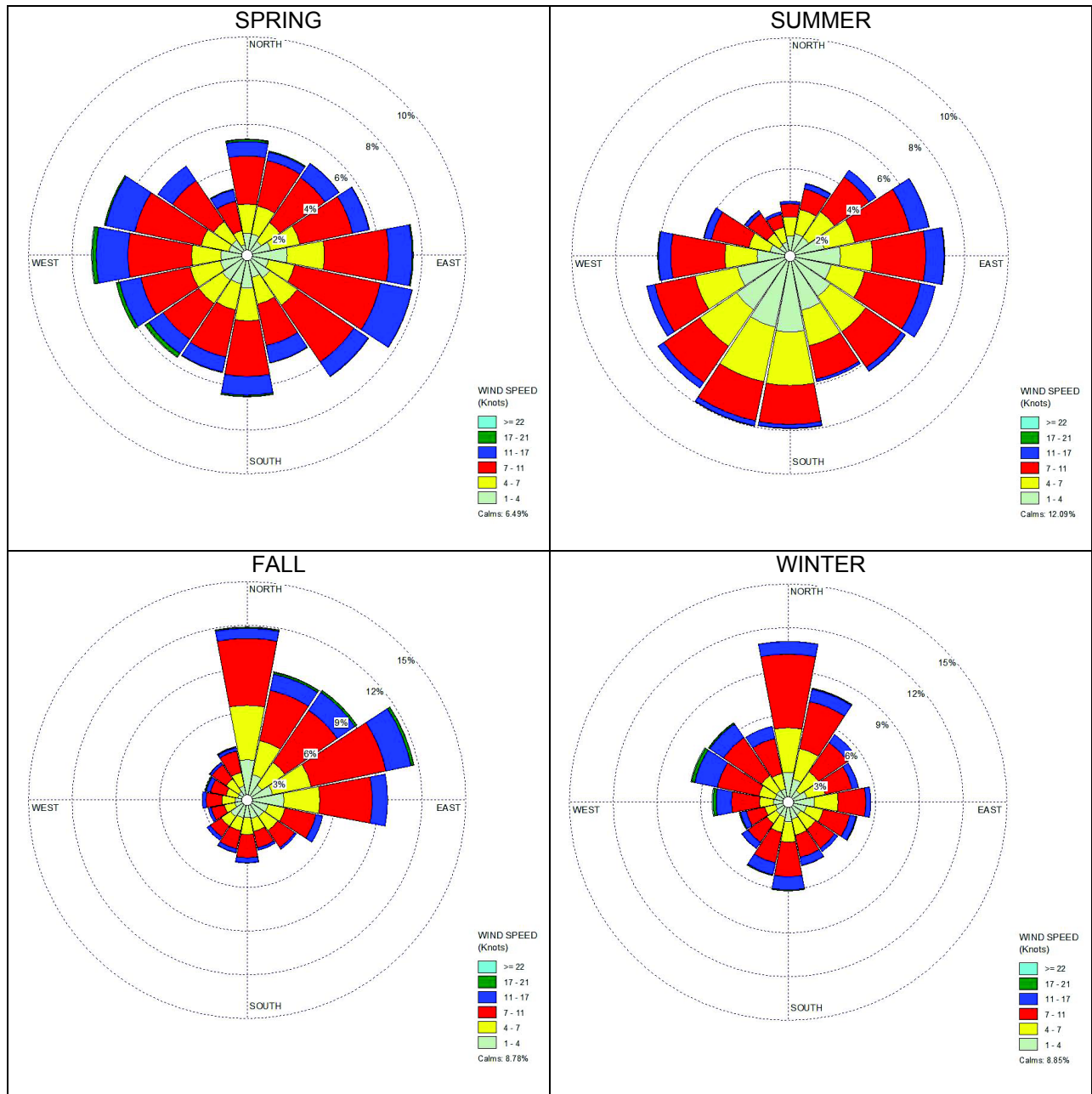

Figure 3-2. 5-Year Seasonal Wind Roses, Orlando International Airport, 1996 through 2000

Source: NCDC, 2002.

Table 3-3. NAAQS and Monitored Air Quality Concentrations

Pollutant and Averaging Time	Primary NAAQS ¹	2008 Monitored Data ²		Location of Monitor	
				City	County
CO					
8-hour†	9 ppm	0.4 ppm	2 nd Maximum	Plant City	Hillsborough
1-hour†	35 ppm	1.0 ppm	2 nd Maximum	Plant City	Hillsborough
NO₂					
Annual‡	53 ppb	4 ppb	Arithmetic mean	Plant City	Hillsborough
1-hour§	100 ppb	29 ppb	2 nd Maximum	Plant City	Hillsborough
PM₁₀					
24-hour†	150 µg/m ³	52 µg/m ³	2 nd Maximum	Lakeland	Polk
PM_{2.5}					
Annual‡	15 µg/m ³	8.66 µg/m ³	Arithmetic mean	Lakeland	Polk
24-hour§	35 µg/m ³	17.6 µg/m ³	98 th Percentile	Lakeland	Polk
Ozone					
8-hour* £	0.075 ppm	0.074 ppm	4 th Maximum	Lakeland	Polk
1-hour†	0.12 ppm	0.09 ppm	2 nd Maximum	Lakeland	Polk
SO₂					
Annual‡	0.03 ppm	0.001 ppm	Arithmetic mean	Plant City	Hillsborough
24-hour†	0.14 ppm	0.004 ppm	2 nd Maximum	Plant City	Hillsborough
1-hour¥	75 ppm	28 ppm	2 nd Maximum	Plant City	Hillsborough
Lead					
Rolling 3-month average	0.15 µg/m ³	0.6 µg/m ³	Quarterly average	Tampa	Hillsborough

*2008 standard.

†Not to be exceeded more than once per year.

‡Arithmetic mean.

§The 3-year average of the 98th percentile of the daily maximum 1-hour average.

£Standard attained when the average of the annual 4th highest daily maximum 8-hour average concentration is less than or equal to the standard.

¥The 3-year average of the 99th percentile of the daily maximum 1-hour average.

Sources: ¹ 40 CFR 50.1-50.12.

² EPA AirData website, <http://www.epa.gov/air/data/index.html>.
ECT, 2011.

With the exception of the lead standard, all areas of Florida have air quality designated as being better than NAAQS. There is a localized area (less than 2 square kilometers) in Tampa surrounding an industrial facility that is nonattainment for the lead standard. This area is more than 25 miles from the proposed project site and is not relevant to the evaluation of this project.

In addition to NAAQS, Table 3-3 lists recent data (i.e., 2008) for monitoring stations located in Polk and Hillsborough Counties. The Polk County monitors are considered to be fairly representative of the rural Polk Power Station site. PM₁₀ data were collected at the Mulberry station located approximately 8 miles northwest of the project site. As shown in Table 3-3, the second highest 24-hour PM₁₀ concentration was 52 micrograms per cubic meter (µg/m³), which is well below the primary standard of 150 µg/m³. Another Polk County site in Lakeland, which is 21 miles to the north northwest of the project site, recorded a 24-hour PM₁₀ concentration of 58 µg/m³. PM_{2.5} was monitored at the Lakeland monitor location and recorded 24-hour and annual values of 17.6 and 8.66 µg/m³, respectively. The measured PM_{2.5} at this site is approximately half of the standards and is similar to values obtained at the Plant City monitor located approximately 21 miles northwest of the project site in Hillsborough County.

Ozone concentrations were collected at two monitoring stations in Lakeland located approximately 15 and 21 miles north of the site. As shown in Table 3-3, the second highest measured 1-hour ozone concentration is adequately below the 1-hour standard, even though this standard has been revoked. The ozone value of 0.074 part per million (ppm) measured at the Sikes Boulevard monitoring station is close to the current 8-hour standard of 0.075 ppm. A value of 0.069 ppm was measured at the Shepherd Road site. From 2006 through 2008, the ambient ozone air quality has generally been improving, and long-term attainment with the ozone standard is expected.

The lead value shown in Table 3-3 is the highest quarterly average measured at either of the two monitors located in the vicinity of the nonattainment area in Tampa. As shown, the highest quarterly lead value was less than half of the standard.

Data from the Plant City monitor were used to determine ambient air quality for the remainder of the gaseous pollutants (i.e., CO, NO₂, and SO₂). As shown in Table 3-3, the measured 1- and 8-hour CO concentrations are less than 5 percent of the standards. High CO levels are generally associated with high volume intersections, roadways, and parking areas.

The NO₂ data shown in Table 3-3 collected from the Plant City monitor site indicate the annual ambient levels are well below the standard (i.e., 7.5 percent of the standard). The second highest value was used

to assess ambient air quality for the 1-hour NO₂ standard. The eighth highest value, on which attainment with the standard is based, was not readily available. Although, the second highest value of 29 parts per billion (ppb) is conservatively high, it is still well below the standard of 100 ppb.

As shown in Table 3-3, the SO₂ values measured at the Plant City monitor are well below NAAQS. The measured values of 0.001 ppm annual concentration and 0.004 ppm 24-hour concentration are less than 5 percent of NAAQS. These values are also less than 5 percent or less of the Florida ambient air quality standards for those averaging times. Comparison of the second highest measured 1-hour concentration of 28 ppm to the recently promulgated 1-hour standard of 75 ppm is conservative, since the standard is based on the maximum daily fourth highest value averaged across 3 years and should be significantly lower than the second highest measured in a single year.

3.1.2 ENVIRONMENTAL CONSEQUENCES

3.1.2.1 Proposed Project

Construction activities for the proposed project would start in April 2012 and be completed in March 2013. The CO₂ capture and sequestration activities would take place over an approximate 18-month period targeted to start in the third quarter of 2013.

Due to the limited duration of the construction and operation phases, the proposed project would have short-term minor air quality impacts. Emissions during construction and operation would not exceed major new source review (NSR) air permitting applicability thresholds, have a regionally significant impact, or contribute to violations of federal, state, or local air regulation or ambient air quality standards. In summary, the proposed project would conform to the EPA-approved Florida State Implementation Plan (SIP) due to the minimal level of the emissions. Discussions of air quality impacts during construction and operation of the proposed project are provided in the following sections.

Construction

Construction of the proposed project would result in three general categories of air emissions. First, site preparation and vehicle movement would generate fugitive dust emissions. Second, internal combustion engines in construction equipment would release NO_x, CO, and other motor fuel combustion products. And third, construction worker travel to and from the Polk Power Station would result in vehicular emissions.

The quantity of emissions released during the construction process would generally be low but would vary due to weather conditions and would fluctuate on an hourly and daily basis as construction

progresses. Fugitive dust emissions would be greatest during the site preparation phase. Fugitive dust emissions would also be greater during the more active construction periods as a result of increased vehicle traffic on the construction site.

Fugitive dust emissions from the construction site would be minimized using appropriate dust suppression control methods. Standard control methods include the application of environmentally approved dust-suppressing chemicals or water to unpaved roads and other exposed surfaces and the seeding of exposed areas. Construction-related fugitive dust emissions would be temporary and would cease once construction is completed.

Emissions from internal combustion engines would occur during site preparation and construction because of the use of onsite construction equipment for site grading, concrete placement, and structural steel and major equipment installation. In addition to the pollutants associated with the combustion of motor fuel by the construction equipment engines, the following construction activities would result in minor emissions of volatile organic compounds (VOCs):

- Evaporative losses from onsite painting.
- Refueling of construction equipment.
- Application of adhesives, waterproofing chemicals, and cleaning solvents.

There would be an estimated 107 construction workers on a monthly average basis. While not readily quantifiable, the temporary net changes in vehicle-miles traveled (VMT) in the area would be minimal, as would any temporary net changes in areawide vehicular emissions due to the relatively low number of construction workers anticipated.

Air quality impacts caused by construction activity would vary from day to day as a function of the level of activity, specific nature of the activity, weather conditions while the activity occurs, and emissions controls applied to the activity. However, even under worst-case conditions, maximum ambient impacts caused by construction emissions are expected to be modest, temporary, and limited to the general area of the construction site. Additionally, there is a substantial buffer between the project construction site and the nearest point of public exposure; i.e., approximately 0.65 mile (3,400 ft).

In summary, based on the type and nature of the construction-related emissions sources, air quality impacts caused by construction-related emissions would be minor and localized, primarily limited to the immediate onsite area of the construction activity, and well within the Polk Power Station property boundaries.

Operation

During the approximate 18-month operation phase, the proposed project would have minimal impacts on ambient air quality due to the small number and size of the project's emissions sources. Emissions sources associated with operation of the proposed project include the following continuous and intermittent sources:

- 23.75-million-British-thermal-units-per-hour (MMBtu/hr) propane-fired HTDP unit startup heater (intermittent combustion emission source; would operate for approximately 32 percent of the time; i.e., 2,820 hours per year [hr/yr]).
- 2.1-MMBtu/hr propane-fired DSRP tailgas recycle heater (continuous combustion emission source).
- HTDP unit adsorber sorbent hopper (intermittent particulate matter [PM] emission source - would operate for approximately 1.2 percent of the time; i.e., 104 hr/yr).
- Amine (aMDEA) surge drum (intermittent VOC emission source; would operate for approximately 0.02 percent of the time; i.e., 12 hr/yr).
- HTDP unit regenerator system regenerator fines bin (intermittent PM emission source; would operate for approximately 1.2 percent of the time; i.e., 104 hr/yr).

In addition to the emission sources described, the existing Polk Power Station flare would be used to oxidize intermittent emissions associated with startup and shutdown of the demonstration high-temperature syngas cleanup process.

Due to the temporary, intermittent, and minor level of emissions associated with operation of the proposed project, impacts on ambient air quality would be minimal and would not contribute to violations of federal, state, or local ambient air quality standards. As discussed in Subection 3.1.1, Polk County is presently designated as in attainment with respect to NAAQS.

In addition to having minimal impacts on ambient air quality, during the operation phase, the proposed project is expected to inject and sequester CO₂ that would otherwise have been released to the atmosphere at a rate of approximately 300,000 tpy. The demonstration high temperature syngas cleanup process would also result in reductions of SO₂ and trace metal (arsenic, selenium, and mercury) compared to the current Polk Power Station syngas cleanup process.

3.1.2.2 No-Action Alternative

Under the no-action alternative, DOE would not provide RTI with cost-shared funding for the proposed project, and the project would not be constructed nor operated. Therefore, no impacts to air quality due to the proposed project would occur.

3.2 GEOLOGY AND SOILS

3.2.1 AFFECTED ENVIRONMENT

3.2.1.1 Subsurface Geology

In general, the Polk Power Station site and surrounding region contain surficial layers of unconsolidated sands plus clays and consolidated carbonate strata to depths of roughly 250 to 300 ft. These stratigraphic units are underlain by a thick sequence of sedimentary carbonate (limestone and dolomite) rocks. A summary of the geologic and hydrogeologic framework for the central Florida phosphate district of west-central Florida is presented in Table 3-4 and illustrated on Figure 3-3.

In the vicinity of the site, the Upper Cretaceous Pine Key Formation is present at the anticipated UIC well completion depth of 8,000 ft bls. The Upper Cretaceous Lawson limestone (which may correlate to the Upper Pine Key Formation) occurs above this and is present between roughly 4,600 to 4,800 ft bls. Overlying this stratigraphic unit is the lower unit of the Cedar Keys Formation, which is still of the Late Cretaceous age and present between depths of 4,200 to 4,600 ft bls. The Lower Cedar Keys Formation, Lawson limestone, and Pine Key Formation (units greater than 4,200 ft bls) comprise the targeted injection zone for this project. Vertical permeability testing performed on samples taken from a core collected from between 4,767 and 4,774 ft bls from IW-1 indicated permeabilities ranging from 1.5×10^{-5} to 6.8×10^{-4} cm/sec (0.04 to 1.9 feet per day [ft/day]) (Ardaman, 2011). It should be noted that, for sedimentary rock, the vertical permeability is typically thought to range between one-tenth and one-hundredth of the horizontal permeability. Also, the total porosity of these cores ranged from 23 to 32 percent (Ardaman, 2011). The Upper and Middle units of the Paleocene Cedar Keys Formation overlie these Upper Cretaceous units, and these strata occur at or below depths of approximately 3,150 ft.

The Upper and Middle units of the Cedar Keys Formation, along with the lowermost portion of the overlying Oldsmar Formation, comprise the primary confining unit exceeding 1,300 ft in thickness and overlying the proposed CO₂ injection zone. The majority of the pore space within these Cedar Keys units is filled with anhydrite and these units also include numerous layers of strata that are predominantly anhydrite. With the anhydrite filling the pore space, the vertical permeability and total porosities will be reduced, as is evident from the test results performed on several core samples. Vertical permeability testing performed on core samples collected from the confining unit during the drilling of IW-1 indicated

Table 3-4. Hydrogeological Framework for West-Central Florida

System	Series	Stratigraphic Unit	General Lithology	Major Lithologic Unit	Hydrogeological Unit
Quaternary	Holocene and Pleistocene	Undifferentiated surficial deposits	Predominantly fine quartz sand; shell interbedded clay, marl, peat, dolostone, sandstone, and phosphorite	Sand	Surficial aquifer system
		Fort Thompson Formation	Shelly quartz sand, unfossiliferous quartz sand, and thin limestone beds		
Tertiary	Pliocene	Caloosahatchee Formation	Shelly quartz sand; thin, shelly limestone beds, and marl	Clastic	Intermediate aquifer system
		Tamiami Formation	Sandy limestone, clayey and pebbly sand; clay, marl, shell, phosphatic		
		Peace River Formation*	Clayey, phosphatic, sandy beds; silty and sandy phosphatic clay beds, and clayey phosphatic quartz sand		
	Miocene	Hawthorn Group	Dolomite and clay, and limestone, silty, phosphatic	Carbonate and elastic	Aquifer
		Arcadia Formation†			
	Oligocene	Suwannee Limestone	Limestone, sandy limestone, fossiliferous	Carbonate	Confining unit
		Ocala Group	Limestone, chalky, foraminiferal, dolomitic, near bottom		
	Eocene	Avon Park Formation	Limestone and hard brown dolomite; intergranular evaporite in lower part in some areas	Carbonate	Floridan aquifer system
		Oldsmar Formation	Dolomite and limestone, with intergranular gypsum in most areas		
		Upper and Middle Units Cedar Keys Formation	Dolomite and limestone with beds of anhydrite		
Paleocene	Lower Unit Cedar Keys Formation	Dolomite and limestone with some anhydrite	Carbonate with evaporites	Sub-Floridan confining unit	
	Lawson Limestone/Pine Key Formation	Dolomite and limestone with some anhydrite and traces of shale			
					Carbonates with minor evaporites

*Peace River Formation includes Bone Valley Member and undifferentiated deposits.

†Arcadia Formation includes undifferentiated deposits, Tampa Member, and Nocatee Member.

Sources: Ryder, 1985.
Johnson, 1989.

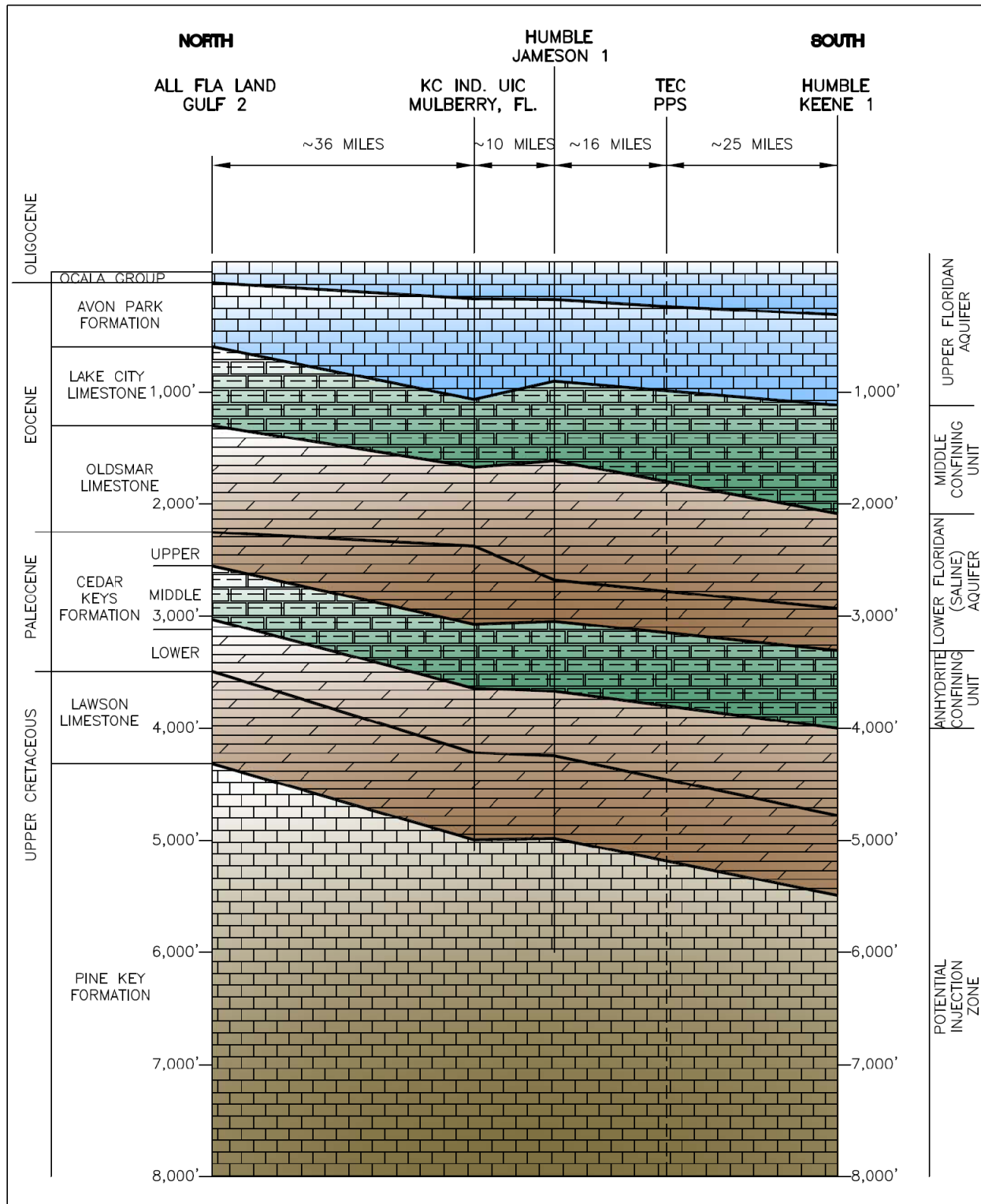

Figure 3-3. North-South Geologic Cross-Section of West-Central Florida

Sources: Kaiser, 1973. ECT, 2011.

low permeabilities ranging from 1.8×10^{-8} to 5.6×10^{-9} cm/sec (1.6×10^{-5} to 6.2×10^{-6} ft/day) (Ardaman, 2010). Additionally, the average total porosity of the cores tested from the confining unit was 3.5 percent with an average effective porosity, measured by a helium pycnometer, of 0.132 percent (Ardaman, 2010). The substantial thickness (greater than 1,300 ft) and extremely low vertical permeability would provide a suitable seal against the potential vertical migration of CO₂.

Above these Cretaceous age units is the Eocene Series, which includes the Oldsmar Formation, Avon Park limestone, and Ocala Group. The Avon Park limestone is the lower of two highly productive units of the Upper Floridan aquifer. The Suwannee limestone of Oligocene age overlies the Ocala Group. At the project site, the Suwannee limestone is encountered between 300 to 420 ft bls, but this unit pinches out to the northeast portion of Polk County. The Suwannee limestone is the top of two highly productive units of the Upper Floridan aquifer and is overlain by strata comprising the Hawthorn Group.

The Hawthorn Group consists of the Arcadia and Peace River Formations, in ascending order. The Arcadia Formation contains, in ascending order, the Nocatee and Tampa Members plus an unnamed member. The Arcadia Formation consists of dolomite, sand, clay, and silty, phosphatic limestone. The Peace River Formation is comprised of clayey phosphatic sand beds, which comprise the Bone Valley Member, which is the primary unit mined for phosphate (Scott, 1986). The Hawthorn Group is present from approximately 40 to 200 ft bls at the Polk Power Station site but varies from absent to approximately 300 ft across Polk County. The most recent deposits are undifferentiated sands and terrace deposits, which may range in thickness from 0 to approximately 40 ft.

The nearest offsite penetration into the Lower Cedar Keys Formation is the KCI Mulberry UIC well located in Mulberry, Florida, roughly 10 miles straight north of the Polk Power Station site. The KCI Mulberry UIC well began operation in the mid-1970s and injects acidic wastes into the subsurface.

Regarding its physiographic setting, the site is located within the geomorphic province known as the Polk Upland (White, 1970). There are no known or mapped regional faults or fractures within the injection zone or overlying confining unit within a 25-mile radius of the site.

3.2.1.2 Soils

Soil types have been mapped by the U.S. Department of Agriculture (USDA) in cooperation with the Polk County Soil Conservation Services (SCS) (1990). The Polk Power Station site is situated primarily on Smyrna-Myakka, Arents-Water, and Ona soil types (Figure 3-4). Seventeen other soil types occur across the site but cover significantly less area.

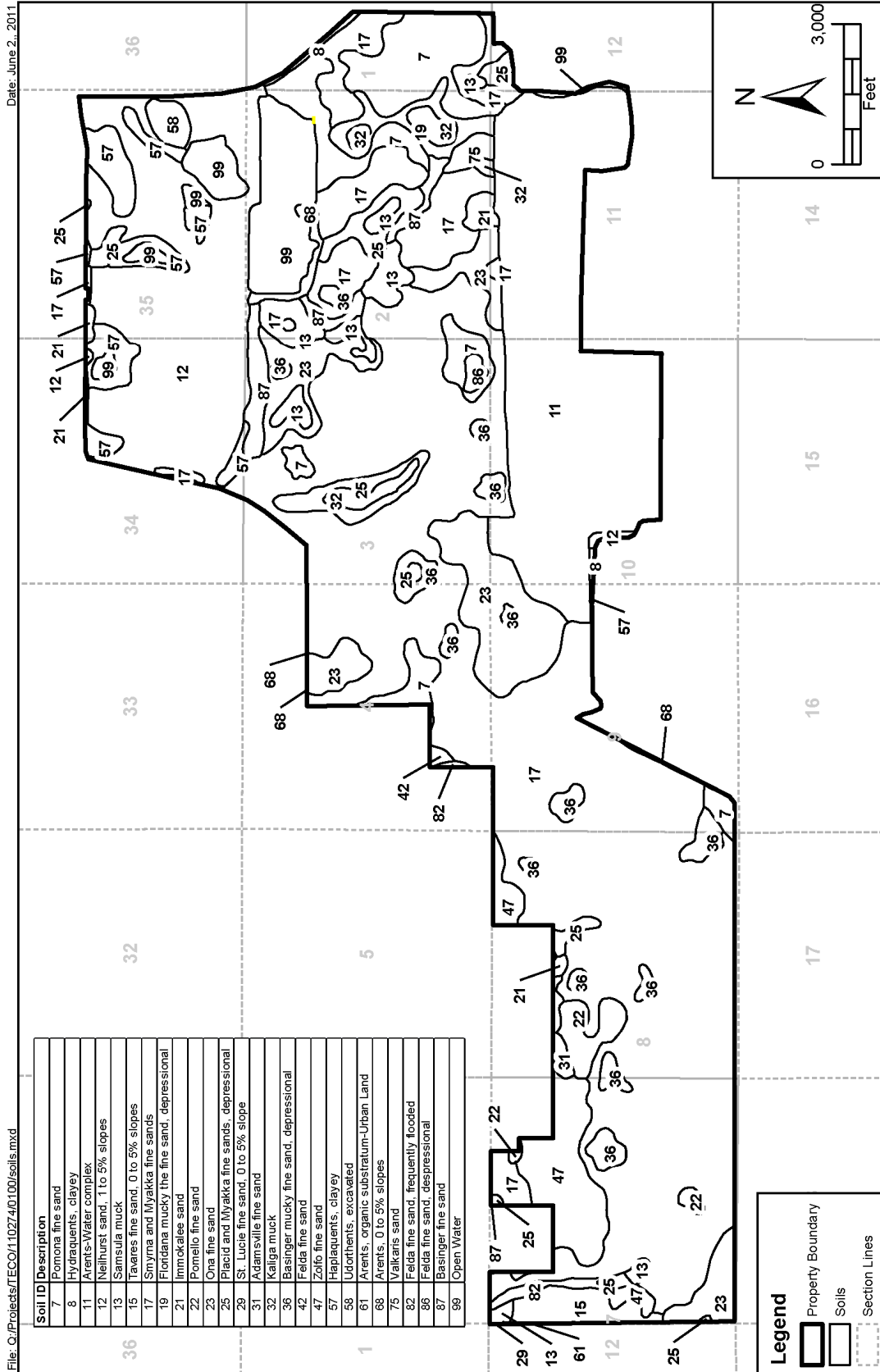

Figure 3-4. Soils Map for Polk Power Station Site

Sources: USDA NRCS, 2002. Amato *et al.*, 1986. Chen, 1965. Winston, 1994. ECT, 2011.

The Smyrna-Myakka soil complex consists primarily of fine sands that cover broad areas of flatwoods. These soils are somewhat poorly drained with the water table typically within 0 to 1 ft of the land surface for 1 to 4 months in most years. The Smyrna soils have an organic matter content of 1 to 5 percent, and the Myakka soils have an organic matter content of 2 to 5 percent (SCS, 1990).

The Arents-Water complex is a soil type resulting from mining activities. The Arents consists of overburden soil piles (various slopes) created during phosphate mining activities. The water portion of the complex is the groundwater, which subsequently flows into and fills the mine cuts that typically remain open.

The Ona fine sands are also found in broad areas of flatwoods. The Ona soils are also somewhat poorly drained with the water table typically within 0 to 1 ft of the land surface for 1 to 4 months in most years.

3.2.2 ENVIRONMENTAL CONSEQUENCES

3.2.2.1 Proposed Project

The main potential adverse effects of the proposed project on geology and soils would result from the injection of approximately 300,000 tpy of CO₂ over 18 months. These impacts are presented in the following paragraphs with a brief discussion including their likelihood of occurrence.

A sudden unplanned or uncontrolled release of CO₂ to the surface would be considered unlikely because of the well design plus the operational and monitoring technologies, which would be used. If a release were to occur at or from the well/wellhead, such an event would have minimal impacts on the soil resources surrounding the well. Most effects would be localized mainly to nearby low-lying areas surrounding the well and could be readily remediated.

A sudden unplanned or uncontrolled release of CO₂ vertically through the geologic materials adjacent to the injection well up to the surface soils or near surface geologic units would also be considered unlikely. The reasons for this include the lateral continuity, substantial thickness, and low vertical permeability of the confining (caprock) unit plus the lack of other nearby well/borehole penetrations or fractures/faults through the confining unit. Relatively slow leakage from the well bores due to casing and/or cement problems would be detected ahead of time by mechanical integrity testing to be conducted as part of the monitoring anticipated to be required under the UIC permit. If a release were to occur, such an event would not be expected to reach or have adverse impacts on the surface soils or near surface geologic units due to the presence of additional confining units within the overlying 2,500- to 3,000-ft vertical distance.

Additionally, the released CO₂ would continue to react geochemically with the carbonate materials and most likely be geochemically converted and dissolved within the formation fluids via solubility and mineral trapping.

Due to the highly unlikely nature of the previously described effects, the proposed project would be expected to have minimal impacts due to leakage of CO₂ from the storage formation to the surface or into another area in the subsurface.

3.2.2.2 No-Action Alternative

Under the no-action alternative, DOE would not provide funding to RTI, and the proposed project would not proceed. Therefore, no impacts to geology or soils would occur due to the project construction and operation. However, under the no-action alternative, Tampa Electric would proceed with its plans to drill and construct the deep injection well IW-2 and associated monitoring well and use the injection well for disposal of wastewater from the power plant operations.

3.3 WATER RESOURCES

3.3.1 AFFECTED ENVIRONMENT

3.3.1.1 Surface Water

The eastern portion (i.e., east of SR 37) of the Polk Power Station site, which includes the existing power plant facilities and would contain the proposed project site, is located within the headwaters of the Little Payne Creek drainage basin. Little Payne Creek flows approximately 10 miles southeast from the site to Payne Creek. Payne Creek is a tributary of the Peace River, which flows into Charlotte Harbor and the Gulf of Mexico in southwest Florida. According to Chapter 62-302, F.A.C., these surface waters are classified as Class III fresh waters with designated uses for recreation, propagation, and maintenance of a healthy, well-balanced population of fish and wildlife.

Key surface water features located on the eastern portion of the Polk Power Station site include the 755-acre cooling reservoir, a 26-acre stormwater retention pond, several areas of reclaimed wetlands, an old water-filled mine cut, and a reclaimed, unnamed lake (see Figure 2-3).

The existing Polk Power Station operations use the cooling reservoir for once-through cooling for the Polk Unit 1 IGCC plant and also for the discharge of treated plant wastewaters. Stormwater runoff from the existing power plant facility areas is collected, treated as needed, and routed to the stormwater retention pond. Under NPDES Permit No. FL0043869-Major, the Polk Power Station is permitted to have two external outfalls to the Little Payne Creek system. Outfall D-001 discharges from the cooling

reservoir to the unnamed lake along the eastern boundary of the site, which flows to Little Payne Creek. Outfall D-002 discharges stormwater from the retention pond to an old mine cut, which flows to the unnamed lake. Tampa Electric monitors and reports the water quality of these two external outfalls in accordance with the NPDES permit conditions.

3.3.1.2 Groundwater

The groundwater aquifer systems in Polk County include, shallowest to deepest, the surficial (usually unconfined), intermediate (usually semi-confined to confined), and Floridan aquifers (usually confined). Table 3-4 and Figure 3-3 present the general geologic and hydrogeologic framework for these aquifer systems in west-central Florida.

Figure 3-5 illustrates the distribution and presence of the surficial aquifer system (SAS) in Florida and Polk County (Copeland *et al.*, 2009). At the project site, the SAS is composed of the undifferentiated sands and clays, plus the upper sandy section of the Bone Valley Member of the Peace River Formation. At the proposed project location, this unit is approximately 40 to 50 ft thick (ECT, 1992). The average annual precipitation at the site is approximately 53 inches per year, and the amount of recharge entering the surficial aquifer is affected by runoff and evapotranspiration. The SAS is not used as a significant source of water in Polk County nor in the vicinity of the project site (Copeland *et al.*, 2009).

Figure 3-6 illustrates the distribution and presence of the intermediate aquifer system (IAS) in Florida and Polk County (Copeland *et al.*, 2009). The IAS consists of portions of the Peace River and Arcadia Formations of the Hawthorn Group. At the site, the intermediate aquifer has two producing zones that are separated by different semiconfining to confining units. At the proposed project location, this aquifer with its associated confining units is approximately 220 to 250 ft thick (ECT, 1992). The primary recharge to the upper intermediate aquifer is leakage from the SAS. The IAS is used as a source of water in Polk County primarily for agricultural and residential purposes (Arthur *et al.*, 2008).

The Upper Floridan aquifer system (UFAS) includes the Suwannee Limestone, Ocala Group, and upper portion of the Avon Park Formation. Figure 3-7 illustrates the distribution and presence of the UFAS in Florida and Polk County (Copeland *et al.*, 2009). At the proposed project location, the UFAS is approximately 700 to 750 ft thick (ECT, 1992). In proximity to the site, the UFAS has two highly transmissive and producing zones, which include the Suwannee Limestone and Avon Park Formation. Primary recharge to the UFAS comes from the physiographic ridge areas to the north and east of the Polk Power Station site, with some additional recharge coming from the lower IAS. The UFAS is one of the major sources of drinking water supply for this area in west-central Florida.

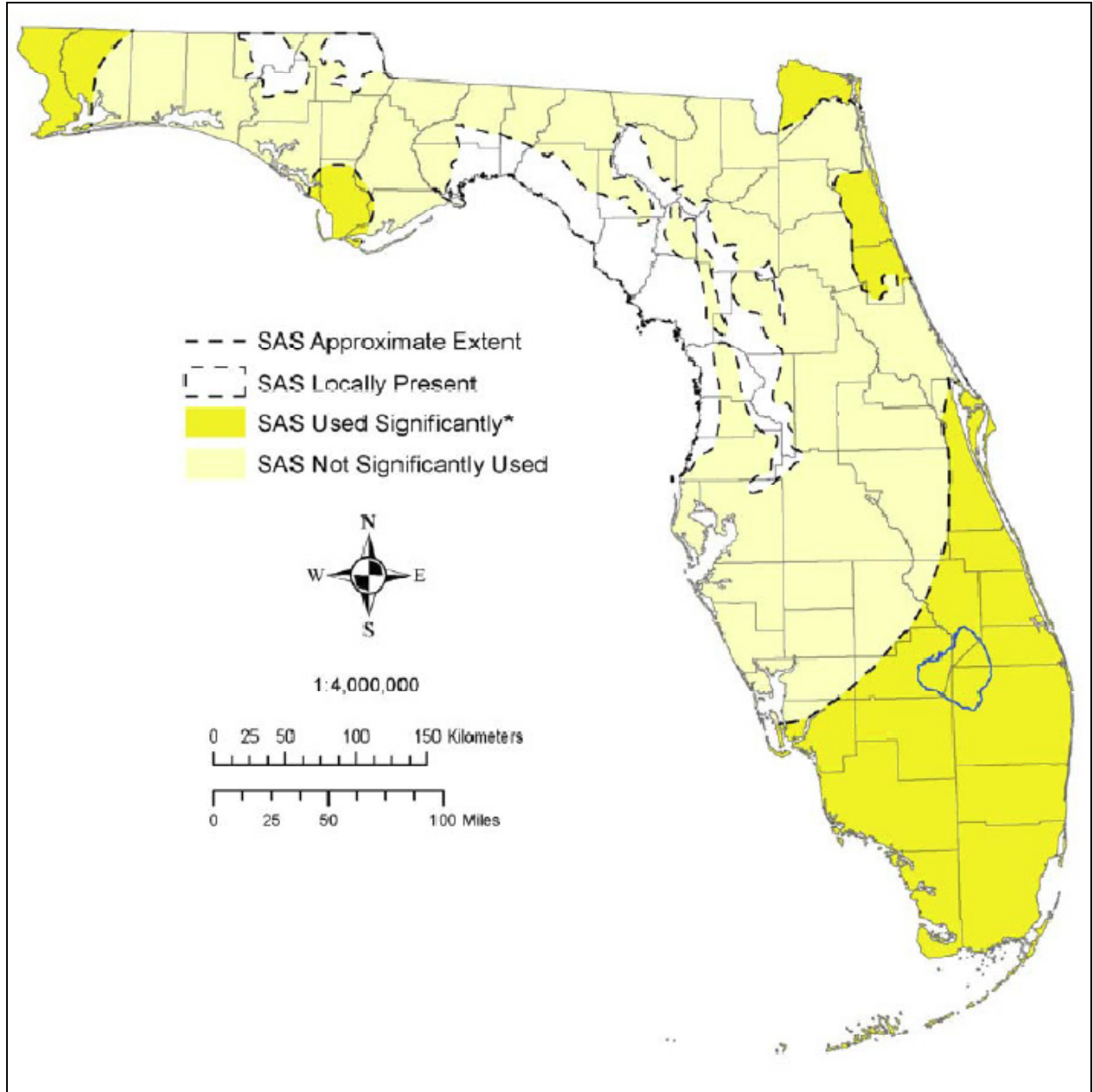

Figure 3-5. Distribution and Presence of the SAS in Florida

Source: Copeland *et al.*, 2009.

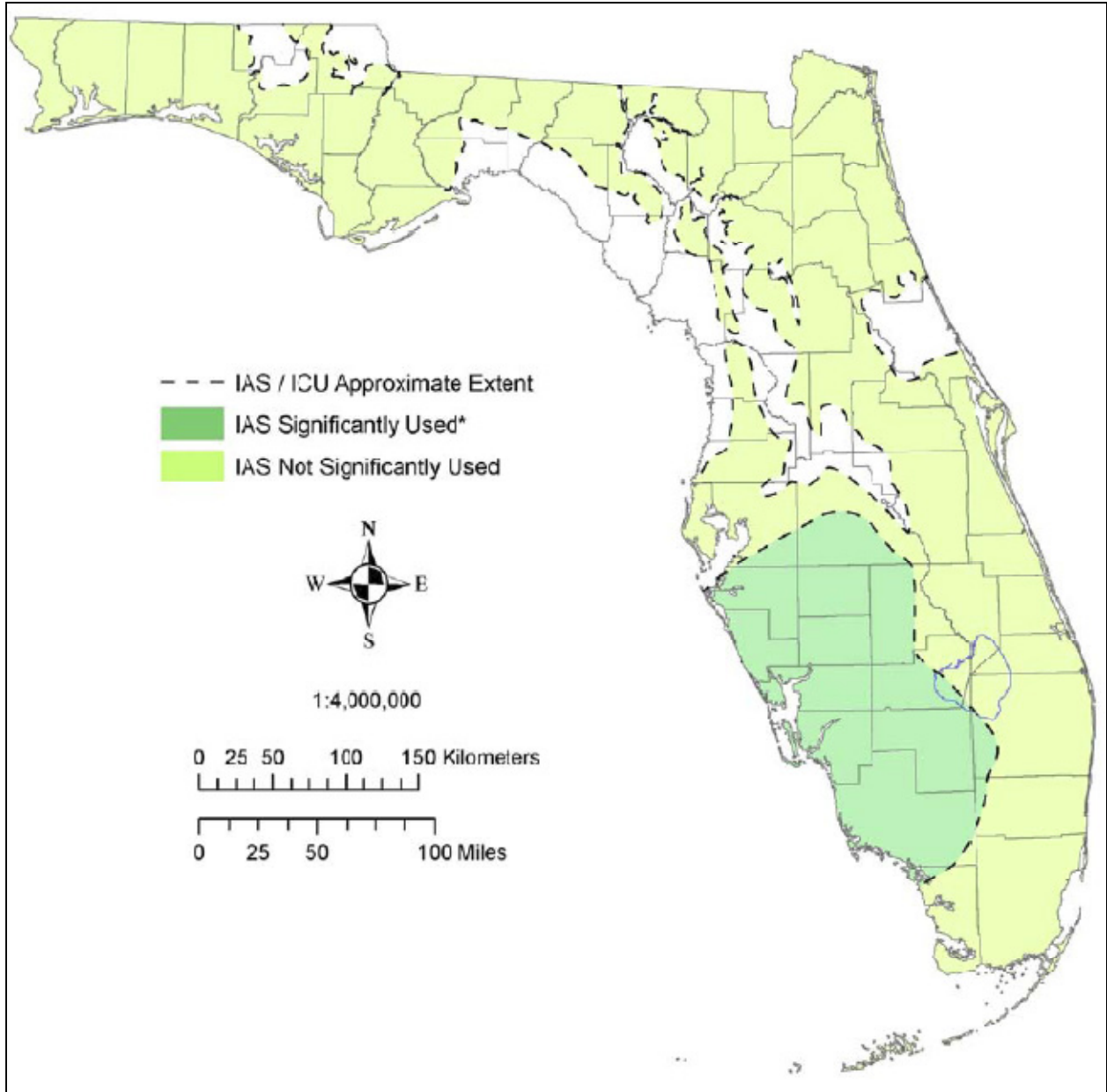

Figure 3-6. Distribution and Presence of the IAS in Florida

Source: Copeland *et al.*, 2009.

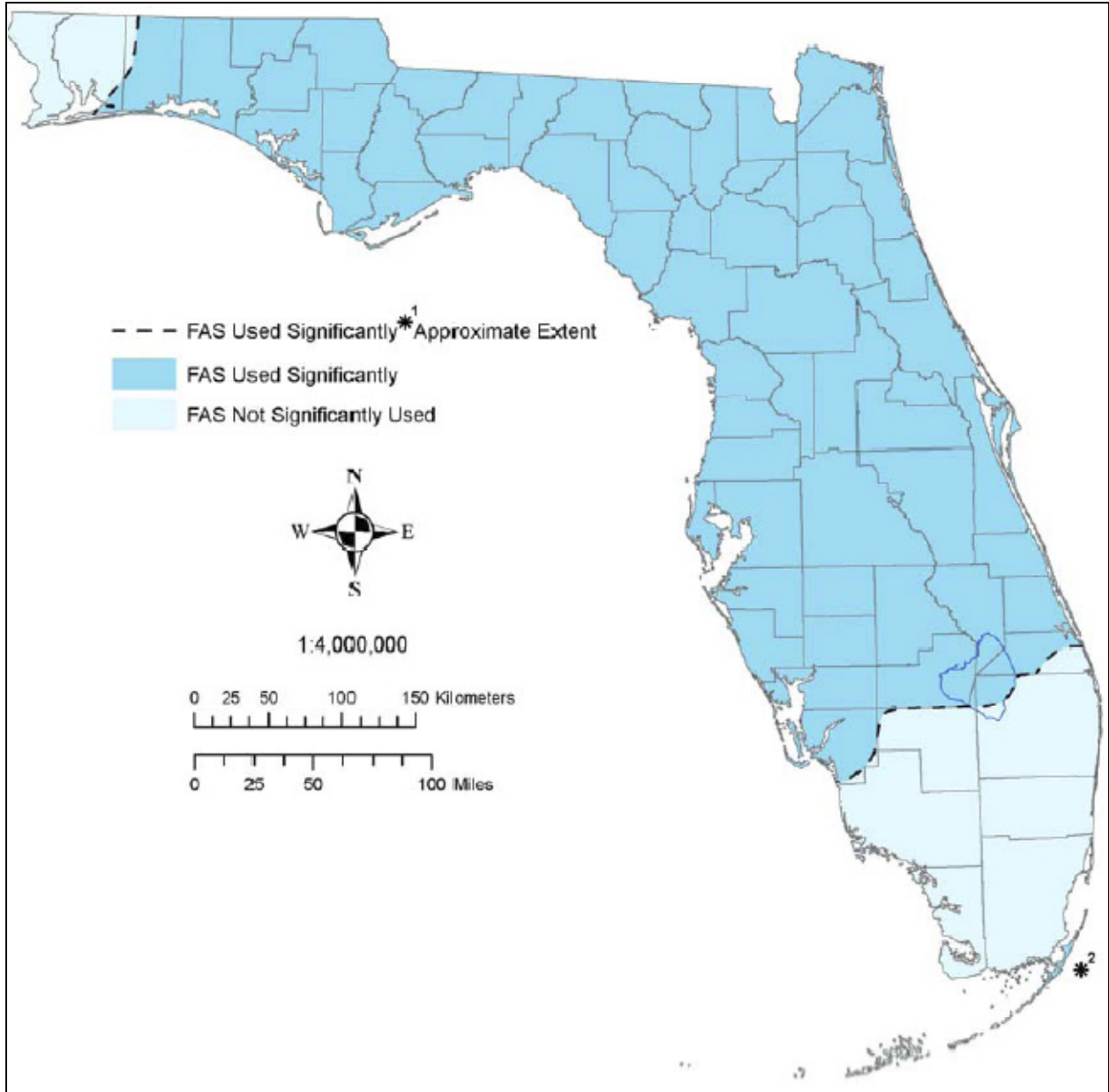

Figure 3-7. Distribution and Presence of the UFAS in Florida

Source: Copeland *et al.*, 2009.

The Lower Floridan aquifer system (LFAS) is separated from the UFAS by the middle confining unit that coincides with the lower portion of the Avon Park Formation (formerly known as the Lake City Limestone), beneath which lies the Oldsmar Formation, which is the main producing zone in this aquifer. However, due to the occurrence of more transmissive, productive units at shallower depths, the LFAS is not commonly used as a water source in the west-central portion of Florida (Southwest Florida Water Management District [SWFWMD 2011]). Also, the LFAS has poorer water quality with total dissolved solids concentrations ranging from 2,000 to 10,000 milligrams per liter, which would require additional treatment prior to use as drinking water.

In February 2011, the SWFWMD water use permit electronic database was screened for all permitted wells within a 2-mile radius of the Polk Power Station site (located east of SR 37). The results of this search indicated 33 existing wells were permitted for withdrawals and reportedly used for industrial-, agricultural-, or mining-related purposes. Of these 33 permitted wells, 4 are used for industrial or commercial purposes with up to a 6.99-million-gallons-per-day (MGD) permitted use (all at Polk Power Station), 14 were used for mining and sealing water-related purposes with up to a 7.08-MGD permitted use, plus 15 were used for irrigation with up to a 1.08-MGD permitted use.

The deepest water supply wells drilled in the vicinity of the site are the four water supply wells installed for the existing power plant. These wells were drilled to a depth of approximately 900 ft bls and do not penetrate to the bottom of the USDW nor approach the depth to the top of the confining unit (approximately 2,900 ft bls) above the proposed injection zone. Currently, Tampa Electric is authorized to withdraw up to 5.24 MGD on an annual average daily basis from these wells in the UFAS. Otherwise, most of the other water wells in the vicinity of the site penetrating into the UFAS have depths ranging between 300 to 500 ft bls or are completed into one of the shallower overlying aquifers (intermediate or SAS).

As previously mentioned, the nearest offsite deep well penetration into the Lower Cedar Keys Formation is the KCI Mulberry UIC well located in Mulberry, Florida, roughly 10 miles straight north of the Polk Power Station site. This UIC well has been in operation since the mid-1970s and injects acidic wastes.

3.3.2 ENVIRONMENTAL CONSEQUENCES

3.3.2.1 Proposed Project

Surface Water

During construction of the proposed project, the primary surface water resource concerns would be soil erosion and stormwater runoff from the proposed project facility area and construction laydown/parking

areas. These areas are relatively level, covered in grass, and within existing drainage infrastructure areas for the existing power plant. During construction, appropriate erosion control and stormwater management measures would be used to minimize potential impacts. These measures would be implemented in accordance with the requirements of a generic permit for stormwater discharge from large and small construction activities, under Chapter 62-621, F.A.C., which would be required for the proposed project. Based on these measures, the potential impacts on surface water resources during construction of the proposed project would be minimal and temporary.

During operations, stormwater runoff from the proposed project facility area would be directed to and integrated with the stormwater drainage system for the existing power plant facilities. The existing drainage system and stormwater retention pond have sufficient capacity to detain and appropriately treat the additional project-related runoff. Therefore, no potential impacts to surface water resources are anticipated.

Also, during operations, the proposed project would require cooling and process water and would produce a process wastewater. Figure 3-8 provides the water balance for the proposed project.

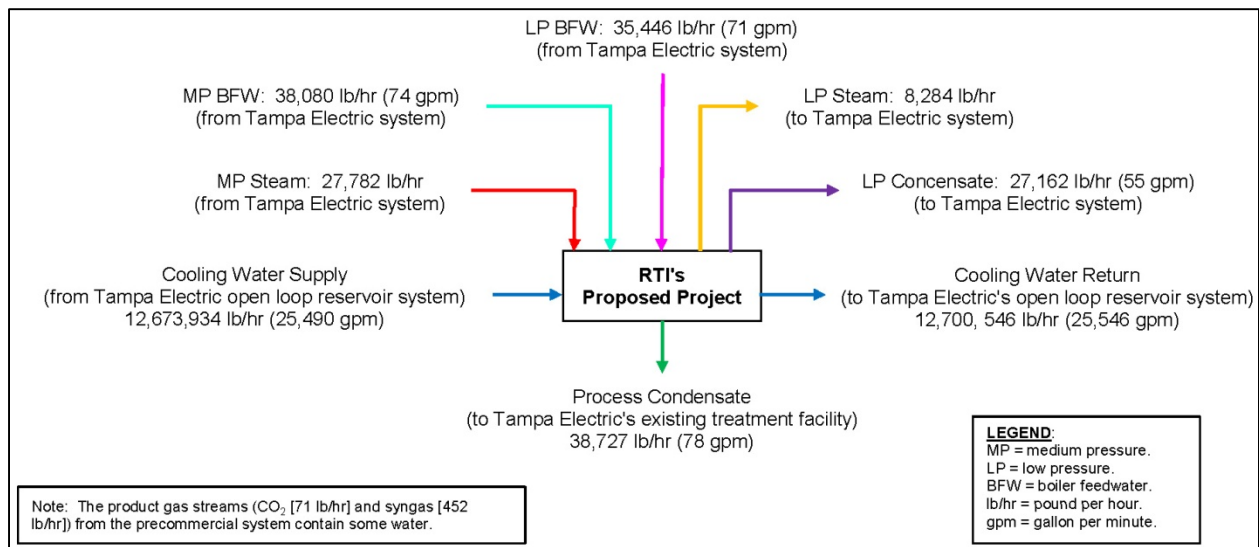

Figure 3-8. Water Balance for RTI's Proposed Project

Sources: RTI, 2011. ECT, 2011.

As shown in Figure 3-8, the largest water use for the proposed project would be process cooling water. The cooling water would be supplied by tying into the supply headers of Tampa Electric's existing open loop cooling reservoir system. The cooling water would be returned to the existing system. The existing circulating water flow rate for the cooling reservoir is approximately 250 MGD; therefore, the proposed

project water use would increase the flow rate by approximately 15 percent. The cooling reservoir has sufficient existing capacity to supply the additional cooling water needs of the proposed project without the use of additional surface water or groundwater resources.

The primary source of wastewater from the proposed project would be process condensate generated in the low-temperature gas cooling unit and the CO₂ compression and drying system. This process condensate would be recycled within the proposed project systems to the extent possible. The remaining process condensate would be routed to Tampa Electric's existing wastewater treatment facilities and/or treated and routed to the existing cooling water system. Effluent from Tampa Electric's existing wastewater treatment facilities is discharged to the cooling reservoir. The potential impacts of the additional condensate wastewater discharge from the proposed project on the cooling reservoir or other surface waters would be minimal.

Groundwater

The UIC program in Florida is regulated jointly by FDEP using Chapter 62-528, F.A.C., and EPA Region 4 using 40 CFR 146. The primary regulatory purpose of the FDEP and EPA regulations is to protect the quality of Florida's underground sources of drinking water from inappropriate injection operations and to prevent degradation of the quality of other aquifers adjacent to the injection zone that may be used for other purposes. Currently there are six main regulatory categories for UIC wells, which include:

- Class I—wells used for disposal of municipal and industrial wastewater below the USDW.
- Class II—oil and gas injection wells.
- Class III—solution mining injection wells.
- Class IV—hazardous waste injection wells (banned in Florida).
- Class V—other types of injection wells.
- Class VI—carbon capture and sequestration.

At present, and as it pertains to these different UIC well classifications, FDEP has primacy for Classes I, III, IV, and V, while EPA has primacy over Classes II, with involvement from the Florida Geological Survey. Presently, EPA has primacy over the new Class VI category for geological carbon sequestration wells, as the state of Florida has not decided whether it will pursue primacy over these wells at this time.

Both state and federal regulations applicable to UIC permitting include multiple provisions for safeguarding and preventing injected fluid movement into USDWs. The injection well for the proposed project is expected to be permitted as a Class V experimental technology well that would meet the more

stringent Class I industrial injection well design standards. For most of the previous carbon capture and sequestration projects performed in the United States, the UIC wells were permitted under either Class I, II, V, or some combination of these regulatory criteria.

Injection wells used for carbon capture and sequestration pilot projects may be permitted as Class V experimental technology wells if their design and operation are experimental in nature, plus all applicable Safe Drinking Water Act and UIC permitting requirements are met. Once, or if, the experimental technology well is no longer considered experimental, the well would need to be permitted for the most applicable class of UIC wells, if it is expected to continue in operation. For the proposed project, Tampa Electric intends to permit injection well IW-2 as a Class V experimental technology well for CO₂ injection during the demonstration period. After that period, Tampa Electric plans to change the well to a Class I UIC well for the injection of wastewater.

A sudden unplanned or uncontrolled release of CO₂ vertically through the subsurface adjacent to the injection well up into the overlying aquifers would be considered unlikely. The reasons for this include the lateral continuity, substantial thickness, low vertical permeability of the confining (caprock) unit, plus the lack of other nearby well/borehole penetrations or fractures/faults through the confining unit. Relatively slow leakage from the well bores due to casing and/or cement problems would be detected ahead of time by mechanical integrity testing to be conducted as part of the monitoring typically required under the UIC permit. If a release were to occur, such an event would not be expected to reach or have a significant impact on the primary drinking water aquifers due to the presence of additional low permeability confining units within the 2,000- to 2,400-ft vertical distance.

Preliminary geochemical modeling analyses for the proposed project are being performed by Dr. Stewart from the University of South Florida, and those efforts will be more thoroughly described in supporting documentation provided for the UIC permit application. However, the preliminary geochemical modeling results, which account for CO₂ injection followed by subsequent wastewater injection at IW-2, indicate the CO₂ plume would react with and completely dissolve into the brine within the injection zone within a relatively short period of time (less than 5 years), long before the CO₂ plume would possibly be able to move horizontally and reach the Polk Power Station property boundaries (Stewart, 2011, verbal communication). This rapid dissolution and mineral trapping would also reduce the likelihood that CO₂ would exist long enough to migrate very far vertically as well.

However, should a slow release or small amount of CO₂ escape through the injection zone's confining unit, no adverse consequences would be expected. The CO₂ in the released solution would continue to

react geochemically with the substantial thickness of carbonate materials during its upward migration between the confining unit and much shallower overlying aquifers. The CO₂ solution would most likely continue to geochemically react and dissolve via solubility and mineral trapping before reaching the overlying shallow aquifers more commonly used for potable purposes.

The injection well drilling and CO₂ injection process for the proposed project would not require substantial volumes of water. After drilling and setting the first well casing using mud rotary drilling methods, the drilling method used for the remainder of the borehole would be switched to reverse air, which requires little makeup water.

As shown in Figure 3-8, medium- and low-pressure boiler feedwater for the proposed project would be supplied from Tampa Electric's existing boiler feedwater treatment and supply system. Tampa Electric's existing process water is provided through groundwater withdrawals from the Floridan aquifer. The additional feedwater for the proposed project would potentially increase overall groundwater use by up to 145 gallons per minute or 208,800 gallons per day during the 18-month demonstration period. However, this relatively minor increase in groundwater use would not cause an increase in Tampa Electric's authorized water use of 5.2 MGD for the Polk Power Station. Therefore, potential impacts of this additional groundwater use for the proposed project would be minimal and short-term. The proposed project would not adversely impact groundwater resources of the area.

3.3.2.2 No-Action Alternative

Under the no-action alternative, DOE would not provide funding to RTI, and the proposed project would not proceed. Therefore, no impacts to surface water and groundwater would occur due to the project construction and operation. However, under the no-action alternative, Tampa Electric would proceed with its plans to drill and construct the deep injection well IW-2 and use the well for disposal of wastewater from the power plant operations.

3.4 SOCIOECONOMICS

The following subsections describe the existing socioeconomic conditions, including population, employment, income, housing, and public facilities and services in Polk County, Florida, and the potential impacts of the proposed project and no-action alternative.

3.4.1 AFFECTED ENVIRONMENT

3.4.1.1 Population

The Polk Power Station and proposed project site are located in an unincorporated area of Polk County in west-central Florida. Table 3-5 provides population trends for Polk County, select cities in Polk County, and the state of Florida. According to the 2010 Census data, the population of Polk County was 602,095 on April 1, 2010. The population in Polk County grew at a rate of slightly lower than the state in the 1990 to 2000 period and higher than the state in between 2000 and 2010. In 2010, Polk County was the 9th most populous of the 67 counties in Florida and ranked 19th in population density.

Table 3-5. Population Trends for Polk County, Select Cities, and Florida

Area	Population			Percent Change	
	1990	2000	2010	1990 to 2000	2000 to 2010
Polk County	405,382	483,924	602,095	19.4	24.4
Bartow	14,716	15,340	17,298	4.2	12.8
Lakeland	70,576	78,452	97,422	11.2	24.2
Florida (state)	12,938,071	15,982,824	18,801,310	23.5	17.6

Sources: Bureau of Economic and Business Research (BEBR), Florida Statistical Abstract, 2010.
U.S. Census Bureau, 2011.

3.4.1.2 Employment and Income

In 2009, Polk County had an estimated labor force of 272,831 persons, of which 254,530 were employed (Bureau of Economic and Business Research [BEBR], Florida Statistical Abstract, 2010). Unemployed persons in 2009 totaled 18,301, for an unemployment rate of 6.7 percent. The statewide unemployment rate in 2009 was estimated at 6.2 percent. Table 3-6 presents the five largest major industry groups in terms of employment in Polk County in 2009. The largest group was government (federal, state, and local), followed by health care, social assistance, and retail trade.

Per capita personal income in Polk County in 2008 was \$32,572, and median household income was \$44,350. Both of these figures were lower than the state of Florida average income figures or \$39,064 and \$47,802, respectively.

Table 3-6. Polk County Major Industry Groups

Industry	Number of Persons Employed	Percent of Total Persons Employed
Government (federal, state, and local)	29,177	15.2
Health care and social assistance	24,722	12.9
Retail trade	24,004	12.5
Administration and support	15,459	8.0
Manufacturing	14,780	7.7

Source: BEBR, Florida Statistical Abstract, 2010.

3.4.1.3 Housing

The 2010 U.S. Census data indicate that there were 281,214 total housing units in Polk County, of which 227,485 units or 80.9 percent were occupied. Of the occupied housing units, 160,442 units or 70.5 percent were owner-occupied and 67,043 units or 29.5 percent were renter-occupied. In 2010, the vacancy rates for homeowner units in Polk County was 4.3 percent and rental units was 15.7 percent, compared to the statewide average rates of 3.8 and 13.2 percent, respectively.

3.4.1.4 Public Facilities and Services

According to Polk County Public School District information, Polk County has 160 school sites and centers, including 66 elementary schools, 19 middle schools, and 17 high schools, plus charter and alternative schools, with a total enrollment of approximately 92,000 students in the fall of 2010. The nearest schools to the Polk Power Station site are located in the cities of Mulberry and Fort Meade.

The nearest fire station to the Polk Power Station site is located in Bradley Junction, approximately 4.4 miles to the north. This station is manned by two fulltime firefighters and eight to twelve volunteer firefighters and is equipped with a pumper truck, tanker truck, and rescue truck. Police services for the site area are provided by the Polk County Sheriff's Department. Sheriff's deputies patrolling the area are based out of the Southwest Regional Substation, located in south Lakeland. The Florida Highway Patrol also patrols the area. Access roads to the Polk Power Station are gated, and access is controlled by onsite security personnel.

The nearest hospitals to the Polk Power Station site are Bartow Memorial and Polk General, both located in Bartow approximately 13 miles northwest of the site. Both hospitals are equipped with emergency rooms. The emergency medical service that would respond to the Polk Power Station site is located at the Fort Meade Fire Station.

The Polk Power Station site is located in rural Polk County in an area that is not provided with public potable water supply or sanitary sewerage services. Water and sanitary services for the existing power plant are provided by onsite facilities operated by Tampa Electric.

3.4.2 ENVIRONMENTAL CONSEQUENCES

3.4.2.1 Proposed Project

The proposed project would have minor impacts on socioeconomic resources in the project area. The proposed project would not induce population growth or adversely impact housing in the Polk County

area. During construction, the proposed project would create a monthly average of 107 jobs and a peak of 160 jobs on the site over the 13-month construction period and would involve various expenditures for materials, equipment, and services. During the 18-month operational period, the project would create 12 jobs. The creation of jobs and project-related expenditures would provide some short-term benefits to the local economy.

The proposed project would not adversely impact or create the need to expand public facilities and services, such as schools, police and fire protection services, and medical facilities. Any potential effects of the proposed project on socioeconomic resources would be short-term during the approximately 2.5-year period for construction and operation of the project.

3.4.2.2 No-Action Alternative

The no-action alternative would have no impacts on socioeconomic resources since the proposed project would not be constructed. However, under the no-action alternative, the short-term benefits to the local economy of project-related jobs and expenditures would also not occur.

3.5 TRANSPORTATION

3.5.1 AFFECTED ENVIRONMENT

Transportation facilities in the vicinity of the Polk Power Station site include roadways and a railroad. As shown in Figure 2-2, the eastern portion of the Polk Power Station site is bordered by SR 37 on the west, County Road (CR) 630 on the north, and CR 663 (Fort Green Road) on the east. SR 674/Wimauma Road is located just to the southwest of the eastern portion of the site. The main entrance road to the site is from SR 37, which runs southwest to northeast in the site area. This entrance has a manned security gate located approximately 250 ft from SR 37. SR 37 is a two-lane highway classified as a minor arterial that functions at an acceptable level of service (LOS) B from the Manatee County line to CR 640 based on 2009 traffic counts of 260 peak hour, peak direction trips (Polk Transportation Planning Organization, 2010). Polk County's minimum LOS standard for rural arterial and collector roads is LOS D.

SR 674 is also a two-lane highway classified as a rural major collector from the Hillsborough County line to SR 37 that operates at LOS B with 101 peak hour, peak direction trips in 2009. CR 630, which runs east from SR 37 on the northern site boundary, is a two-lane highway classified as a minor arterial that functions at LOS B with 154 peak hour, peak direction trips. CR 663 (Fort Green Road) is a two-lane highway classified as a minor collector running north-south along the eastern site boundary. There is a secondary access road to the Polk Power Station facilities from Fort Green Road. The roadways in the vicinity of the Polk Power Station site currently function at acceptable LOS.

The Polk Power Station site also has a rail spur from the CSX Railroad, an existing north-south rail line running along Fort Green Road on the east side of the site. The rail line has been used for delivery of some of the equipment during construction of the existing power plant units. Rail is not routinely used for the ongoing operations. Coal and petroleum coke fuels for Polk Unit 1 and other materials are delivered by truck. There are no private or public aviation facilities located within a 5-mile radius of the site. Further, the rural site area is not served by public transit services.

3.5.2 ENVIRONMENTAL CONSEQUENCES

3.5.2.1 Proposed Project

Some short term, minor transportation impacts may be expected due to the movement of construction workers and equipment and material deliveries to and from the Polk Power Station site during construction of the proposed project. These potential impacts would involve minor traffic congestion and delays in the immediate vicinity of the access road entrances to the site on SR 37 and Fort Green Road. These entrances are currently gated, and access to the site is controlled.

As part of the previous environmental licensing/permitting efforts for the Polk Power Station, detailed transportation analyses were conducted to assess impacts of construction- and operation-related traffic associated with development of the power plant facilities. For the original SCA (ECT, 1992), the analysis considered the trips generated by an average construction workforce of 400 workers and a peak of 600 workers. For the Polk Unit 6 SCA (ECT, 2007), the analysis considered a construction workforce average of 600 workers and peak of 1,700 workers. The results of both of these transportation analyses found that the roadway links and intersections within the traffic impact area would operate at acceptable LOS with the existing geometry of the facilities, and no improvements were needed. Also, during the initial development of the Polk Power Station, the roadway entrances were designed and constructed with appropriate geometric improvements, such as deceleration, acceleration, and turn lanes, based on Florida Department of Transportation (FDOT) standards, to accommodate the anticipated construction and operation traffic.

Since the construction workforce for RTI's proposed project of an average of 107 workers and peak of 160 workers would be significantly less than the workforces considered in the previous transportation analyses, the construction traffic for the project would not be expected to adversely impact the surrounding roadway network or cause the roads to function at unacceptable LOS.

Potential transportation impacts are not expected during the operational phase of the proposed project due to the small number of workers needed to operate the facilities (i.e., three workers per shift).

3.5.2.2 No-Action Alternative

Under the no-action alternative, no impacts to transportation would occur since the proposed project would not be constructed.

3.6 SOLID WASTE AND BYPRODUCT MANAGEMENT

3.6.1 AFFECTED ENVIRONMENT

Various nonhazardous solid wastes and byproducts are generated by the existing Polk Unit 1 IGCC operations on the Polk Power Station site. These wastes and byproducts include:

- Slag byproduct.
- Sulfuric acid byproduct.
- Used oils and oily wastes.
- Water treatment media.
- Worn gasifier refractory and brick.
- Miscellaneous solid wastes.

The slag and sulfuric acid byproducts are temporarily stored onsite and are sold by Tampa Electric for offsite commercial uses. In general, for the existing operations, the nonhazardous solid wastes are periodically collected, characterized, and transported offsite for appropriate recycling or disposal.

The Polk Power Station is currently classified as a large-quantity generator under applicable Resource Conservation and Recovery Act (RCRA) regulations outlined in 40 CFR 260 through 279. The materials with potentially hazardous properties that are generated by the existing Polk Unit 1 IGCC operations include:

- Spent sulfuric acid plant catalysts.
- Acid gas removal solvent and filters.
- Deactivated carbon filter media.
- Vent sorbents.
- Sulfuric acid byproduct.

These potentially hazardous wastes are managed by Tampa Electric in accordance with RCRA and state requirements. The current Polk Power Station Integrated Contingency Plan (ICP) addresses emergency procedures to be implemented in case of an accidental release of these wastes. These wastes are periodically collected, characterized, and transported offsite by a licensed hauler for appropriate disposal at RCRA-permitted facilities.

3.6.2 ENVIRONMENTAL CONSEQUENCES

3.6.2.1 Proposed Project

The proposed project would use and store various chemicals and materials and generate various waste products. These materials and wastes would be managed by RTI in accordance with the same procedures and programs used by Tampa Electric for the existing Polk Power Station operations. RTI has a large-quantity generator license for handling RCRA wastes. RTI would obtain a specific license to cover the Polk Power Station site and would arrange for an appropriately licensed hauler to transport any potentially hazardous wastes offsite for disposal at a RCRA-permitted facility.

In the HTDP unit, circulation of the sorbent would result in attrition and generation of fines, which would be separated from the treated syngas by filters. These sorbent fines would be periodically removed from the filters. The fines would be accumulated in a lock hopper system, which is sized for approximately 30 days or 17,000 pounds of fines. Toxicity characteristic leaching procedure (TCLP) testing of the fines generated from the pilot testing of RTI's syngas cleanup technologies at the Eastman Chemical plant indicated that the fines were not considered hazardous. For the proposed project, the fines would be characterized by TCLP testing, collected in storage drums, and transported offsite for appropriate disposal.

Another waste generated during the proposed project operations would be the arsenic, selenium, and mercury sorbents from the TCRP unit. It is anticipated that these sorbents, which total approximately 34,000 pounds, would be changed out at least once during the 8,000 hours of operation. TCLP testing of these sorbents when used in syngas cleanup has not been performed; therefore, it is currently uncertain whether or not these sorbent wastes would be considered hazardous. For the proposed project, these sorbent wastes would be collected, characterized by TCLP testing, and transported offsite for appropriate disposal.

It is anticipated that the catalysts in the DSRP unit and water gas shift reactors would be used for the duration of the proposed project operations. If at the end of operations these systems are decommissioned, these catalysts would be characterized and appropriately handled and shipped offsite for disposal. Other used and unused solvents, such as aMDEA, would be either sold for reuse or characterized for offsite disposal at an appropriately permitted facility.

The proposed project is not expected to create adverse impacts due to the generation and handling of solid wastes, including potentially hazardous wastes. Wastes would be managed, controlled, stored, and disposed in accordance with applicable federal and state regulations. Persons responsible for the

operations of the proposed project facilities would be properly trained and informed on the safety and emergency response procedures in the Polk Power Station ICP, similar to current Tampa Electric employees at the site. Further, potential impacts due to waste generation and management would be short-term over the 18-month operational period for the proposed project.

3.6.2.2 No-Action Alternative

Under the no-action alternative, no impacts due to the generation and management of wastes would occur since the proposed project would not be constructed nor operated.

3.7 HUMAN HEALTH AND SAFETY

3.7.1 AFFECTED ENVIRONMENT

Potential human health and safety impacts may result from air pollution releases, accidental spills or release of hazardous materials or toxic gases, and worker injuries due to accidents. Air pollution can cause human health problems. NAAQS were established to protect human health and welfare with a reasonable margin of safety. As discussed in Section 3.1, air quality in the area of the Polk Power Station is designated as attainment for NAAQS pollutants.

As discussed in Section 3.6, the Polk Power Station operations generate potentially hazardous wastes and materials. These wastes are controlled, managed, and disposed in accordance with applicable RCRA and state regulations to minimize potential spills and releases and protect human health and safety. Further, in case of an accidental release, workers at the Polk Power Station have been trained in the emergency response procedures contained in Tampa Electric's RCRA ICP for the Polk Power Station to minimize human health risks.

The acid gas removal process in the existing syngas cleanup system for the Polk Unit 1 IGCC facility produces a gas stream with a high concentration of H₂S. H₂S is a colorless, flammable gas with a characteristic foul odor of rotten eggs. Human exposure to lower concentrations of H₂S can result in eye irritation, sore throat, nausea, shortness of breath, and fluid in the lungs. At higher concentrations (i.e., 300 to 500 ppm), inhalation of H₂S can result in pulmonary edema with the possibility of death. To minimize the potential release of H₂S gas, Tampa Electric conducts routine inspections of the equipment and piping in the acid gas removal system for Polk Unit 1. Also, the facility is equipped with gas detectors set to sound alarms if H₂S is detected at very low concentrations.

Tampa Electric's worker safety program for the Polk Power Station includes training and adherence to applicable Occupational Safety and Health Administration (OSHA) procedures to minimize injuries due to accidents.

3.7.2 ENVIRONMENTAL CONSEQUENCES

3.7.2.1 Proposed Project

As discussed in Section 3.1.2.1, the potential air quality impacts caused by construction of the proposed project would be short-term and localized to the immediate onsite area of the construction activity. During operations, the proposed project would have minor, intermittent air emissions and would not contribute to exceedance of NAAQS. Therefore, the construction and operation of the proposed project would have negligible impacts to human health and safety due to air pollution.

Similar to the existing Polk Power Station operations, potentially hazardous wastes generated by the proposed project operations would be controlled, managed, and disposed in accordance with applicable RCRA and state regulations to minimize potential releases and human health risks. Also, similar to the existing operations, applicable OSHA procedures would be followed to minimize the potential for worker injuries due to potential accidents.

For the proposed project, potential concerns to human health and safety related to the CO₂ capture and sequestration aspects of the project could result from CO₂ leaks to the air and CO₂ migration to underground aquifers used for drinking water. CO₂ is heavier than ambient air, colorless, and odorless, which makes it an invisible hazard (DOE, 2007). CO₂ is normally present in the atmosphere at a concentration of approximately 0.03 percent. However, if humans are exposed to high concentrations of CO₂ for extended periods of time, health risks, such as suffocation and permanent brain injury from lack of air, can occur (DOE, 2007). Headache, impaired vision, labored breathing, and mental confusion can also occur from CO₂ exposure. Generally, the pooling and large, rapid releases of CO₂ are the situations of concern for human health and safety, instead of small gradual leaks (DOE, 2007). No general CO₂ exposure standards currently exist for the general public (DOE, 2007).

However, OSHA and the National Institute for Occupational Safety and Health (NIOSH) have established CO₂ exposure limits to protect workers against health effects due to exposure to high concentrations of CO₂. OSHA has set the permissible exposure limit for CO₂ of 5,000 ppm or 9,000 milligrams per cubic meter based on an 8-hour time-weighted exposure (Centers for Disease Control and Prevention [CDC], 2011). OSHA permissible exposure limits are regulatory limits on the amount or concentrations of a substance in the air to prevent adverse human health effects. NIOSH has established immediately

dangerous to life or health (IDLH) values that the exposure to airborne contaminants is likely to cause death or immediate or delayed permanent adverse health effects or prevent escape from such an environment (CDC, 2011). The NIOSH IDLH value for CO₂ is 40,000 ppm based on a 30-minute exposure. Extended exposure to such high concentrations of CO₂ would normally only occur due to a large, rapid release of CO₂ or if a release were contained within an enclosure. For the proposed project, the presence of these conditions would be considered unlikely. Based on the proposed project design, any release of CO₂ would occur to the ambient atmosphere and would be expected to quickly dissipate.

After injection underground, CO₂ migration in high concentrations can cause human health issues in aquifers used for drinking water. If CO₂ migrates to drinking water aquifers in high concentrations, the groundwater can become contaminated, because CO₂ can cause the mobilization of elements in the soil, such as metals, into the aquifers. Similar to air leaks of CO₂, gradual releases of CO₂ into underground drinking water sources typically do not cause substantial harm to human health due to contamination, but rapid releases could (DOE, 2007).

For the proposed project, the equipment, vessels, and piping systems for the CO₂ capture and compression processes, as well as the injection wellhead, well casing, and grouting/packing systems, would be designed and constructed to minimize the risks for potential CO₂ leaks. The proposed project's MVA program would be designed and implemented in accordance with applicable UIC permitting requirements to avoid, detect, and correct unintended CO₂ leaks to minimize risks to human health. The program would include regular equipment and pipeline inspections and monitoring detectors to reduce the risks of failures leading to CO₂ releases. All operational personnel would also be trained in emergency procedures in case of an accidental CO₂ release to minimize human health and safety risks.

The injection well would be designed, drilled, and constructed to make migration of CO₂ to drinking water aquifers highly unlikely. Based on available geologic formation sources and site-specific information collected during the drilling of IW-1 at the Polk Power Station site, the targeted CO₂ injection zone is vertically isolated from the closest drinking water aquifer by a more than 1,300-ft-thick, low-permeability confining unit. The proposed IW-2 well design would include four casings, one fluid-filled annulus, and approximately 9 inches of CO₂-resistant cement to horizontally isolate the injected CO₂ from the underground source of drinking water. Therefore, potential human health risks due to CO₂ migration in high concentrations are expected to be minimal. These risks would be further mitigated by the short-term operational period for the proposed project and the MVA program, which includes monitoring of groundwater quality. The final operational and MVA requirements would be detailed in the approved UIC permit.

3.7.2.2 No-Action Alternative

Under the no-action alternative, no risks to human health or safety would occur due to construction or operation of the proposed project, including no risks due to CO₂ capture and sequestration.

3.8 RELATIONSHIP BETWEEN SHORT-TERM USES OF THE ENVIRONMENT AND MAINTENANCE AND ENHANCEMENT OF LONG-TERM PRODUCTIVITY

The CEQ regulations that implement the procedural requirements of NEPA require consideration of the relationship between short-term uses of man's environment and the maintenance and enhancement of long-term productivity (40 CFR 1502.16). Construction and operation of the proposed project would require short-term uses of land, energy, water, and other resources. In the context of the CEQ regulations, short-term uses of the environment involve those uses during the life of the proposed project, whereas long-term productivity refers to the period of time after which the project has ceased operations and the equipment has been decommissioned and removed. Under the funding agreement with DOE, the proposed project would be operated for approximately 18 months, ending by the third quarter of 2015. Currently, it is uncertain whether the proposed project facilities would cease operations and be decommissioned or would continue to be operated by Tampa Electric without further DOE funding. In either case, at some time in the future when the project facilities have reached their useful life, the equipment could be removed, and the site land could be restored to its predisturbance condition or used for other purposes for the Polk Power Station operations. As discussed in Section 1.4, the deep injection well IW-2 would be used by Tampa Electric to dispose of wastewater for its existing power plant operations after the CO₂ capture and sequestration aspects of the proposed project have been completed. Therefore, the short-term use of the land and other resources for the proposed project would not impact the long-term productivity of the area.

3.9 IRREVERSIBLE AND IRRETRIEVABLE COMMITMENTS OF RESOURCES

Construction of the proposed project facilities would cause the irreversible and irretrievable commitment of materials, such as concrete and steel, and fuels. During operation, the project would cause the irretrievable commitment of electrical energy, fuels, water, and certain chemicals and solvents. When the project facilities are decommissioned, some of the materials, equipment, and chemicals would be recycled, to the extent practicable.

3.10 UNAVOIDABLE ADVERSE IMPACTS

Construction and operation of the proposed project would cause small unavoidable impacts due to emissions of some air pollutants. These small air impacts would be short-term, localized, and would not adversely impact ambient air quality in the general region. The project would also cause short-term traffic congestion impacts due to construction workers accessing the site. These unavoidable impacts are not expected to be significant.

This page intentionally left blank.

4.0 CUMULATIVE IMPACTS

CEQ NEPA implementing regulations require an analysis of the cumulative impacts that could result from the incremental impact of a proposed project when added to other past, present, and reasonably foreseeable future actions regardless of what agency or person undertakes such actions (40 CFR 1508.7). The purpose of this analysis is to determine if, even though the impacts from a proposed project may be minor and localized, combining those impacts with the effects of other projects could result in significant impacts. This chapter describes the past, present, and reasonably foreseeable actions or activities at the Polk Power Station site and the cumulative impacts of the proposed project in combination with these other activities.

4.1 PAST, PRESENT, AND REASONABLY FORESEEABLE ACTIONS

Conditions resulting from past activities on and in the vicinity of the Polk Power Station site are included in the descriptions of the affected environment in Chapter 3.0 of this EA. The Polk Power Station site is located within an area known as the Bone Valley Central Florida Phosphate District (see Figure 4-1). A significant portion of the rural lands within this district has been mined to recover phosphate or disturbed by mining-related activities, which began in the late 1800s and continue today. Some of the lands comprising the Polk Power Station site were mined prior to 1940, and mining activities continued on the western portion of the site until 1994. The specific area of the site containing the existing power plant and where RTI's proposed project would be located was not mined but was disturbed by adjacent mining activities. Tampa Electric began construction of the Polk Power Station in November 1994, and the Polk Unit 1 260-MW IGCC plant began commercial operation in 1996. In conjunction with development of the power plant facilities, Tampa Electric also was required to reclaim some of the lands (i.e., lands mined after July 1, 1975) in accordance with state and county requirements.

Since Polk Unit 1 was constructed, Tampa Electric expanded the electric generating capacity at the Polk Power Station by adding four simple-cycle combustion turbine generating units. Polk Units 2 and 3 started commercial operation in July 2000 and May 2002, respectively. Unit 4 was placed into service in March 2007 and Unit 5 in May 2007.

Cumulative impacts on air quality could result from the combination of air emissions from the existing Polk generating units with emissions from the proposed project. As part of the environmental permitting efforts for the existing units, dispersion modeling was conducted to demonstrate that the emissions would not adversely impact ambient air quality or exceed NAAQS. The existing units are also subject to

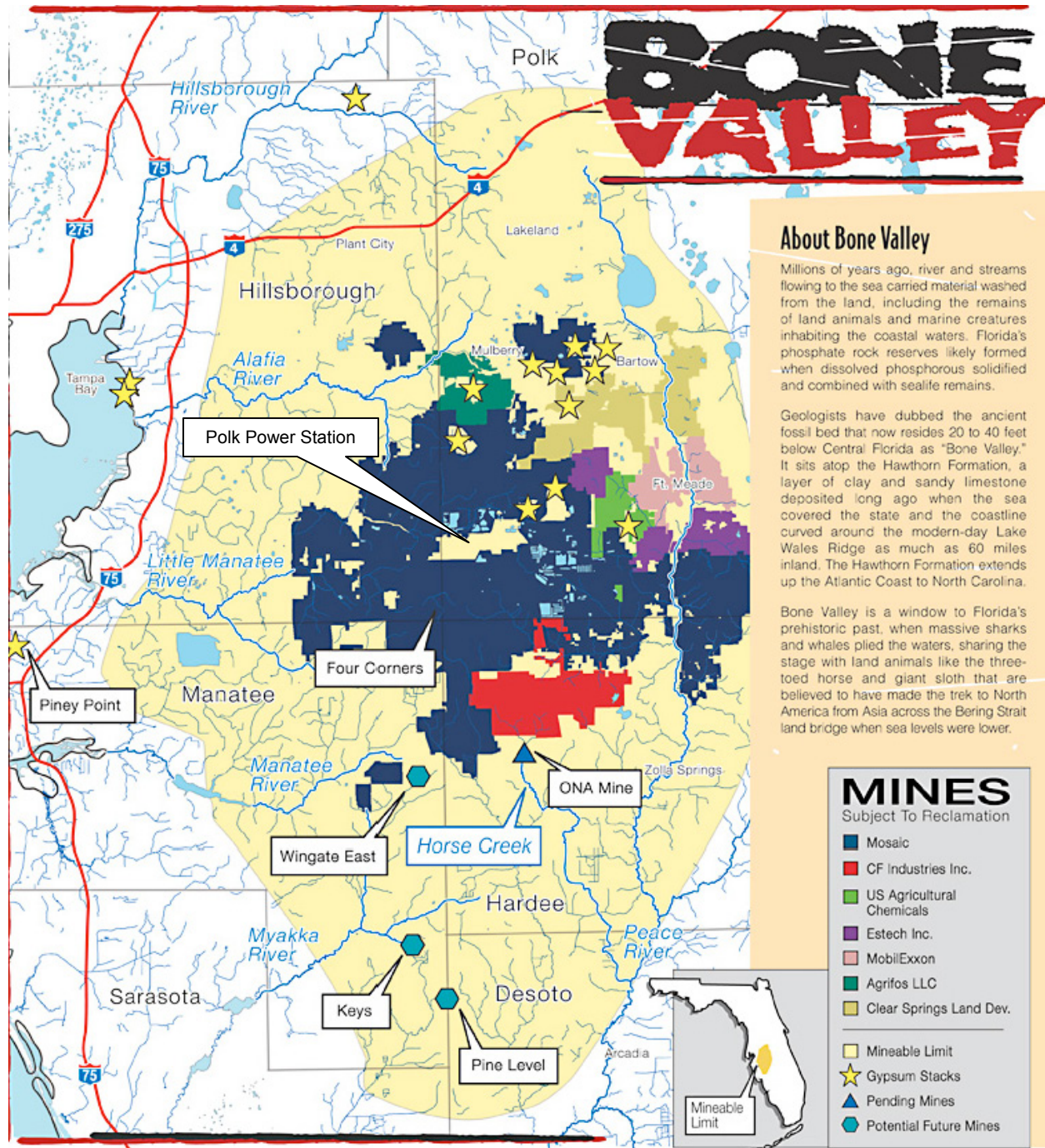

The above map includes lands mined for phosphate since 1975, subject to mandatory reclamation. Reclamation of lands mined prior to 1975 (not included here) is voluntary. Although several companies are referenced in the legend, only three phosphate mining companies remain in Florida: Mosaic, CF Industries, and PCS Phosphates, located in northern Hamilton County. Only a few potential future mines are identified. In almost all cases, wherever a gypsum stack is noted, there is a fertilizer processing plant.

Figure 4-1. Bone Valley Central Florida Phosphate District

Source: www.baysoundings.com, 2005.

emissions monitoring, testing, and reporting requirements to ensure the units are operating within permitted emissions limits.

In the reasonably foreseeable future, it is anticipated that Tampa Electric could construct additional electric generating units at the Polk Power Station site. The site offers sufficient available land area, and the configuration of the existing facilities would allow for development of additional units. According to Tampa Electric's 10-year Site Plan for Electrical Generating Facilities and Associated Transmission Lines, January 2011 – December 2020 (Tampa Electric, 2011), the company forecasts that approximately 480 MW of additional combustion turbine peaking generation capacity will be needed in the 2013 to 2018 timeframe to meet its customers' electric needs. Some of these combustion turbine units could be located at the Polk Power Station. Beyond 2018, Tampa Electric's forecasts indicate that additional intermediate generation capacity will be needed and that capacity could be provided by converting Polk Units 2 through 5 to combined-cycle units. The addition of any of these future generating units at the Polk Power Station would result in additional air emissions. As part of the permitting requirements for the units, dispersion modeling analyses would be required to demonstrate that the additional air emissions would not adversely impact air quality. Also, in the foreseeable future, upon completion of the project and if the demonstration results were favorable, Tampa Electric may consider the option of continuing the operation of all or some portion of the syngas cleanup system.

As discussed in Section 1.4, prior to agreeing to provide the host site for RTI's proposed project, Tampa Electric initiated efforts and is presently proceeding with efforts to permit, drill, and construct two deep injection wells at the Polk Power Station site. Tampa Electric plans to use these wells for the disposal of wastewaters from its existing power plant operations. These efforts are part of Tampa Electric's overall plan to use reclaimed water from the city of Lakeland for cooling reservoir makeup water to reduce groundwater use. The injected wastewater would primarily consist of reverse osmosis brine effluent resulting from the treatment of the reclaimed water prior to use as makeup water. Use of reclaimed water would also allow Tampa Electric to permit and construct additional generation capacity at the site since any additional groundwater use may not be allowed by SWFWMD.

For the proposed project, DOE would provide partial funding for the drilling and construction of one of the planned deep injection wells (i.e., IW-2), which would initially be used to inject and sequester CO₂ during the demonstration period. Upon completion of the proposed project, Tampa Electric plans to use the IW-2 well for injection of wastewater. Tampa Electric's future use of the injection well is considered a future action that could result in cumulative effects on geologic and groundwater aquifer resources even after completion of the proposed project.

4.2 GREENHOUSE GAS AND GLOBAL WARMING

According to the International Panel on Climate Change (IPCC) (2007a), a worldwide environmental issue is the likelihood of changes in the global climate as a consequence of global warming produced by increasing atmospheric concentrations of GHGs. The atmosphere allows a large percentage of incoming solar radiation to pass through to the earth's surface, where it is converted to heat energy (infrared radiation) that is more readily absorbed by GHGs such as CO₂ and water vapor than incoming solar radiation. The heat energy absorbed near the earth's surface increases the temperature of the air, soil, and water.

GHGs include water vapor, CO₂, methane, nitrous oxide, ozone, and several chlorofluorocarbons. The GHGs constitute a small percentage of the earth's atmosphere. Water vapor, a natural component of the atmosphere, is the most abundant GHG. The second-most abundant GHG is CO₂, which remains in the atmosphere for long periods of time. Due to man's activities, atmospheric CO₂ concentrations have increased approximately 35 percent over preindustrial levels. Fossil fuel burning is the primary contributor to increasing concentrations of CO₂ (IPCC, 2007a).

According to the IPCC fourth assessment report, “[w]arming of the climate system is unequivocal, as is now evident from observations of increases in global average air and ocean temperatures, widespread melting of snow and ice, and rising global average sea level” (IPCC, 2007b). The IPCC report finds that the global average surface temperature has increased by approximately 0.74 degrees Celsius (°C) in the last 100 years; global average sea level has risen approximately 150 millimeters over the same period; and cold days, cold nights, and frosts over most land areas have become less frequent during the past 50 years. The report concludes that most of the temperature increase since the middle of the twentieth century “is very likely due to the observed increase in anthropogenic [GHG] concentrations.”

The IPCC 2007 report estimates that, at present, CO₂ accounts for approximately 77 percent of the climate change potential attributable to anthropogenic releases of GHGs, with the vast majority (74 percent) of this CO₂ coming from the combustion of fossil fuels.

IPCC and the U.S. Climate Change Science Program (CCSP) examined the potential environmental impacts of climate change at global, national, and regional scales. IPCC's report states that, in addition to increases in global surface temperatures, the impacts of climate change on the global environment may include:

- More frequent heat waves, droughts, and fires.
- Rising sea levels and coastal flooding; melting glaciers, ice caps, and polar ice sheets.
- More severe hurricane activity and increases in frequency and intensity of severe precipitation.
- Spread of infectious diseases to new regions.
- Loss of wildlife habitats.
- Heart and respiratory ailments from higher concentrations of ground-level ozone (IPCC, 2007b).

On a national scale, average surface temperatures in the United States have increased, with the last decade being the warmest in more than a century of direct observations (CCSP, 2008). Impacts on the environment attributed to climate change that have been observed in North America include:

- Extended periods of high fire risk and large increases in burned area.
- Increased intensity, duration, and frequency of heat waves.
- Decreased snow pack, increased winter and early spring flooding potentials, and reduced summer stream flows in the western mountains.
- Increased stress on biological communities and habitat in coastal areas (IPCC, 2007b).

In the southeast region of the United States where the proposed project would be located, the average temperatures have declined from 1901 to 1970; then temperatures increased strongly since 1970. Over the last century, Florida has experienced decreased precipitation overall, and in all seasons except winter. In the area where the proposed project would be located, precipitation has increased approximately 10 to 15 percent in the winter months. During the next century, Florida's climate may change even more; however, IPCC predicts that the largest increases in future temperatures are likely to occur in the northern latitudes (IPCC, 2007b).

Because climate change is a cumulative phenomenon produced by releases of GHGs from industry, agriculture, and land use changes around the world, it is generally accepted that any successful strategy to address it must rest on a global approach to controlling these emissions. In other words, imposing controls on one industry or in one country is unlikely to be an effective strategy. And because GHGs remain in the atmosphere for a long time and industrial societies will continue to use fossil fuels for at least 25 to 50 years, climate change cannot be avoided. As IPCC report states, “[s]ocieties can respond to climate change by adapting to its impacts and by reducing [GHG] emissions (mitigation), thereby reducing the rate and magnitude of change” (IPCC, 2007b).

According to the IPCC, there is a wide array of adaptation options. While adaptation will be an important aspect of reducing societies' vulnerability to the impacts of climate change over the next two to three decades, "adaptation alone is not expected to cope with all the projected effects of climate change, especially not over the long term as most impacts increase in magnitude" (IPCC, 2007). Therefore, it will also be necessary to mitigate climate change by stabilizing the concentrations of GHGs in the atmosphere. Because these gases remain in the atmosphere for long periods of time, stabilizing their atmospheric concentrations will require societies to reduce their annual emissions. The stabilization concentration of a particular GHG is determined by the date that annual emissions of the gas start to decrease, the rate of decrease, and the persistence of the gas in the atmosphere. The IPCC report predicts the magnitude of climate change impacts for a range of scenarios based on different stabilization levels of GHGs. "Responding to climate change involves an iterative risk management process that includes both mitigation and adaptation, taking into account actual and avoided climate change damages, co-benefits, sustainability, equity, and attitudes to risk" (IPCC, 2007b).

During the 18-month demonstration period, the proposed project would reduce GHG emissions by capturing and sequestering approximately 300,000 tpy of CO₂, which would otherwise have been released to the atmosphere.

4.3 CUMULATIVE IMPACT SUMMARY

The specific land area where the proposed project facilities would be located was previously disturbed by phosphate mining-related activities, as well as the construction activities for the existing power plant facilities. The proposed project facilities would be relatively similar to the existing facilities on the Polk Power Station site and integrated with the existing operations. Therefore, the cumulative impacts of the proposed project on the local land use would be negligible.

As discussed in Subsection 3.1.2, the proposed project would have four air emissions sources. Three of these sources would operate intermittently over the 18-month demonstration period. Only the propane-fired DSRP tailgas recycle heater emissions source would operate continuously. Based on the temporary, intermittent, and minor level of emissions from the proposed project operations, the cumulative impacts on local air quality in combination with the existing power plant emissions sources would be minimal. Further, if Tampa Electric places any future generating units in service during the demonstration period, the cumulative impacts on air quality due to the proposed project would be minimal due to the minor level of emissions from the project.

During the 18-month demonstration period, the proposed project would reduce GHG emissions by capturing and sequestering approximately 300,000 tpy of CO₂, which would otherwise have been released to the atmosphere.

Following the completion of the CO₂ sequestration aspects of the proposed project, Tampa Electric intends to terminate CO₂ injection, remove the CO₂ tubing and packer system from IW-2, and initiate wastewater injection using the same well. This subsequent wastewater injection in IW-2 as well as in IW-1 is anticipated to continue for the duration of the power plant operations, or at least as long as the plant continues to receive and reuse reclaimed water as part of its water supply. As discussed in Subsection 2.2.5.2, FDEP has approved a Class V exploratory boring UIC permit for IW-2 for the injection of wastewater. Tampa Electric intends to submit a Class V experimental technology UIC well permit application in late June 2011 for the injection of CO₂ for the proposed project. Upon completion of the proposed project, Tampa Electric plans to obtain and operate IW-2 under a subsequent Class I industrial UIC permit for wastewater injection.

Preliminary geochemical modeling results indicate that even after 50 years of subsequent wastewater injection (at rates up to 1.7 MGD), the combined CO₂ and wastewater plumes are unlikely to migrate much more than approximately 1.5 miles away from the point of injection at the injection wells (Stewart, 2011). Also, the preliminary geochemical modeling results, which account for the initial CO₂ injection followed by subsequent wastewater injection in IW-2, indicate the CO₂ plume would react with and completely dissolve in the brine wastewater within the geological injection zone within a relatively short period of time (i.e., less than 5 years). This dissolution would occur before the CO₂ plume would be able to move horizontally and reach the Polk Power Station property boundaries or migrate vertically to reach a drinking water aquifer.

Although neither the CO₂ nor the wastewater plumes are predicted to migrate a long distance offsite, the resulting pressure front caused by injection of these two materials may extend some distance away from the site, with the greatest pressures occurring onsite at the injection wells and dissipating with distance away from the point of injection. However, these pressures are not expected to cause the migration of brine wastewater into overlying aquifers due to the substantial thickness and low vertical permeability of the primary overlying confining unit. Furthermore, the confining unit is known to be laterally continuous, and its closest penetrations from other deep drilling activities are located at least 10 miles or farther away from the project site (Chen, 1965). Therefore, the cumulative impacts of Tampa Electric's use of IW-2 for wastewater disposal after the well would be used for CO₂ injection are expected to be minimal.

This page intentionally left blank.

5.0 CONCLUSIONS

DOE's Proposed Action would provide \$171.8 million in cost-shared funding to RTI for the construction and demonstration of the precommercial scale-up of its high-temperature syngas cleanup and CO₂ capture and sequestration technologies. RTI's proposed project would be located on approximately 2.4 acres of previously disturbed land at Tampa Electric's existing Polk Power Station electric generating facilities in Polk County, Florida. RTI's proposed project would treat a slipstream, equivalent to approximately 66 MW of electricity, of syngas from the Polk Unit 1 IGCC plant to remove 99.9 percent of the sulfur, reduce trace contaminant concentrations, and convert SO₂ to elemental sulfur. Also, up to 90 percent of the CO₂ in the cleaned syngas would be captured and sequestered in a deep geologic formation.

DOE prepared this EA to comply with the requirements and procedures of NEPA. This EA provides evaluations of the potential environmental impacts of DOE's Proposed Action of providing funding to RTI, RTI's proposed project, and the no-action alternative. The impact evaluations considered environmental resource areas typically included in NEPA documents. Some of the resource areas were not carried forward for detailed analysis, because DOE determined the proposed project would not impact these resources, or the potential impacts would be negligible. The following discussion provides DOE's conclusions regarding the potential impacts of RTI's proposed project.

During preparation of this EA, DOE consulted with the Florida SHPO, the Seminole Tribe of Florida, and the Seminole Nation of Oklahoma regarding potential impacts of the proposed project on historic and tribal resources or properties. Based on initial evaluations, DOE determined that no resources or properties would be affected by the proposed project. The Florida SHPO and the Seminole Tribe of Florida THPO concurred with DOE's determination.

Construction of the proposed project would result in fugitive dust air emissions from site preparation activities and the release of NO_x, CO, and other fuel combustion emissions from equipment and vehicles. Operation of the proposed project would also result in the release of PM and other minor air emissions. Due to the temporary, intermittent, and minor level of emissions associated with the construction and operation of the proposed project, potential impacts on air quality would be minimal and not contribute to exceedances of NAAQS. During the 18-month demonstration period, the proposed project would reduce GHG emissions by sequestering 300,000 tpy of CO₂, which would otherwise have been released to the atmosphere.

During construction and operation of the proposed project, appropriate stormwater management and erosion control measures would be implemented to minimize or avoid potential impacts to surface water resources. Also, the proposed project would use minor amounts of additional water resources and discharge minimal amounts of wastewater. Water would be provided from the existing Polk Power Station water supply system, and discharged wastewater would be returned to the existing wastewater treatment system; therefore, potential impacts on water resources would be minimal.

The proposed injection of CO₂ into the deep geologic formation at the Polk Power Station site would not adversely impact underground sources of drinking water due to the presence of a low permeability, laterally continuous confining unit that exceeds 1,300 ft in thickness and the proposed design of the injection well with multiple casings and cement packings through and below the drinking water aquifer. Further, should a slow release of CO₂ occur, preliminary geochemical modeling analyses indicate the CO₂ solution would geochemically react with carbonate materials within the target injection zone and be dissolved via solubility and mineral trapping before vertically migrating into drinking water aquifers. A comprehensive MVA program would be implemented to assure the safe operation of the proposed CO₂ capture and sequestration activities. The well used for CO₂ injection would be covered by a Class V experimental technology UIC permit. Tampa Electric intends to submit this permit application in July 2011. FDEP has reviewed and concurred with this permitting approach.

The proposed project would have minimal impacts on socioeconomic resources in the project area. Construction of the proposed project would have short-term benefits to the local economy due to the creation of jobs and project-related expenditures for materials, equipment, and services. Also, construction of the proposed project would have short-term, minor impacts to traffic congestion due to the movement of workers and equipment to and from the Polk Power Station site. However, these potential traffic impacts would not cause surrounding roads to function at unacceptable LOS.

The proposed project would generate moderate quantities of solid waste, some of which may be potentially hazardous. These wastes would be managed, controlled, and disposed in accordance with applicable federal and state regulations and would not be expected to cause adverse impacts. Also, the proposed project would have minimal impacts to human health and safety. Applicable OSHA procedures would be followed to minimize the potential for worker injuries due to accidents.

Under the no-action alternative, DOE would not provide funding to RTI, and it is assumed the proposed project would not be constructed. Therefore, no impacts would occur to environmental resources, and no short-term benefits to the local economy would occur.

6.0 REFERENCES

- Amato, R.V., *et al.* 1986. Regional Geology and Petroleum Potential of the Straits of Florida Planning Area, Minerals Management Service – Atlantic and Gulf of Mexico ICS Regions.
- Ardaman. 2010. Rock Core Testing Report, Tampa Electric Company, Polk Power Station. Prepared for Layne Christensen, File No. 10-13-0197. November.
- Arthur, J., *et al.* 2008. Hydrogeologic Framework of the Southwest Florida Water Management District. Florida Geologic Survey, Bulletin No. 68.
- Bay Soundings. 2005. Tampa Bay's Science and Nature News Journal. *About Bone Valley*. Volume 5, No. 3. Summer. <<http://www.baysoundings.com/sum05/BoneValley.pdf>>. Site accessed on June 14, 2011.
- Bureau of Economic and Business Research (BEBR). 2010. Florida Statistical Abstract, 2010.
- Chen, C.S. 1965. The Regional Lithostratigraphic Analysis of Paleocene and Eocene Rocks of Florida. Florida Geological Survey, Geological Bulletin No. 45.
- Copeland, R., *et al.* 2009. Hydrogeologic Units of Florida - Florida Geologic Survey. Special Publication No. 28.
- Environmental Consulting & Technology, Inc. (ECT). 1992. Tampa Electric Company Polk Power Station Site Certification Application; July. ECT No. 90263. Gainesville, Florida.
- . 2007. Polk Power Station Unit 6, Site Certification Application; September. ECT No. 070040. Gainesville, Florida.
- Environmental Consulting & Technology, Inc. (ECT), and ASRus, LLC (ASRus). 2007. Florida Department of Environmental Protection Exploratory Well Permit Application for the Polk Power Station Deep Injection Well System (IW-1). Prepared for Tampa Electric Company, Tampa, Florida. August
- . 2009. Florida Department of Environmental Protection Exploratory Well Permit Modification Application for the Polk Power Station Deep Injection Well System (IW-1). Prepared for Tampa Electric Company, Tampa, Florida. August
- . 2010a. Florida Department of Environmental Protection Application to Construct/Operate/Abandon Class I, III, or V Injection Well System Dual Zone Monitoring Well No. 1 (DZMW-1) Construction Permit Application for Tampa Electric Company Polk Power Station, Polk County, Florida. Prepared for Tampa Electric Company, Tampa, Florida. February.
- . 2010b. Florida Department of Environmental Protection Exploratory Well Permit Application for Injection Well System and Dual Zone Monitoring Well (IW-2 and DZMW-2) for Tampa Electric Company Polk Power Station, Polk County, Florida. Prepared for Tampa Electric Company, Tampa, Florida. April.
- . 2011a. Draft completed; final pending submittal. Florida Department of Environmental Protection Application to Construct/Operate/Abandon Class I, III, or V Injection Well System and Dual Zone Monitoring Well – Class V Experimental Well Construction/Testing Permit Application at the Tampa Electric Company Polk Power Station, Polk County, Florida. Prepared for Tampa Electric Company, Tampa, Florida. May.

- . 2011b. Draft in progress. Florida Department of Environmental Protection Injection Zone Monitoring Well – Monitoring Well Only Construction Permit Application at the Tampa Electric Company Polk Power Station, Polk County, Florida. Prepared for Tampa Electric Company, Tampa, Florida. May.
- Florida Department of Environmental Protection (FDEP). 2010. Geographic Information Systems electronic files from FDEP and Florida Geological Survey illustrating the locations of UIC, ASR, plus Oil & Gas Wells in Florida.
- Gardner, B. 2011. “EA infoneed.docx” (Information Needed for Environmental Assessment), e-mail message from RTI International (RTI). April 27, 2011.
- Intergovernmental Panel on Climate Change (IPCC). 2007a. Climate Change 2007, The Physical Science Basis. Contribution of Working Group I to the 4th Assessment Report of the IPCC. Solomon, S., Qin, D., Manning, M., Chen, Z., Marquis, M., Averyt, K.B., Tignor, M., and Miller, H.L., Editors. Cambridge University Press, Cambridge, United Kingdom, and New York, New York, USA.
- Johnson, R.A.. 1989. Geologic Descriptions of Selected Exposures in Florida. Florida Geological Survey, Special Publication, No. 30, 174 p.
- . 2007b. Climate Change 2007 Synthesis Report – IPCC 4th Assessment Report. <<http://www.ipcc.ch/ipccreports/index.htm>>. Site accessed in 2009.
- Kaiser Aluminum & Chemical Corporation (Kaiser). 1973. Kaiser’s Mulberry Disposal UIC Well Application for Operating Permit. February 28.
- Koperna, G.J. 2007. Perspectives from the Field - Permitting the Southeast Regional Carbon Sequestration Partnership (SECARB) Mississippi Test Site. U.S. Environmental Protection Agency Geologic Sequestration Technical Workshop: Geological Considerations and Area of Review Studies, Advanced Resources International, Inc., July. Washington, DC.
- National Climatic Data Center (NCDC). 2004. Climatology of the United States: No. 20, Monthly Station Climate Summaries, 1971 – 2000 for Florida. Asheville, North Carolina. Issue Data: February 2004.
- Papadeas, P.W., *et al.* 2005. Review of Existing Injection Well Permit Regulations and Expectations of Future Geologic Sequestration CO₂ Regulations with Monitoring Conditions – 4th Annual Conference on Carbon Capture and Sequestration - Developing Potential Paths Forward Based on the Knowledge, Science and Experience to Date Regulatory Analysis. May. Alexandria, Virginia
- Polk Transportation Planning Organization. 2010. <http://ptpo.s3.amazonaws.com/downloads/884/01_06_10_RND.pdf>. Site accessed May 2011.
- Ryder, P.D. 1985. Hydrology of the Floridan Aquifer System in West-Central Florida. U.S. Geological Survey Professional Paper 1403-F.
- Scott, T.M. 1986. The Central Florida Phosphate District, Geological Society of America Centennial Field Guide -Southeast Section.
- Stewart, M. 2011. Technical meeting discussing preliminary geochemical modeling results for the proposed CO₂ and wastewater injection at Tampa Electric Company, Polk Power Station. Verbal communication.

- Tampa Electric Company. 2011. Ten-Year Site Plan for Electrical Generating Facilities and Associated Transmission Lines; January 2011 to December 2020.
- U.S. Census Bureau. 2011. State and County QuickFacts. <<http://quickfacts.census.gov/qfd/states/12/12105.html>>. Site accessed May 2011.
- U.S. Climate Change Science Program (CCSP). 2008. Scientific Assessment of the Effects of Global Change on the United States – Summary and Findings.
- U.S. Department of Agriculture (USDA), National Resource Conservation Service (NRCS). 2002. Soil Survey Geographic (SSURGO) Database.
- U.S. Department of Energy (DOE). 2011. Strategic Plan, May 2011. DOE/CF-0067. <<http://energy.gov/media/DOE.StrategicPlan.pdf>>. Site accessed June 2011.
- . 2010. National Energy Technology Laboratory (NETL). Kemper County IGCC Project. Final Environmental Impact Statement. DOE/EIS-0409. In cooperation with the U.S. Army Corps of Engineers.
- . 2009. National Energy Technology Laboratory (NETL). Best Practices Manual for: Monitoring, Verification, and Accounting of CO₂ Stored in Deep Geologic Formations. DOE/NETL-311/081508.
- . 2007. National Energy Technology Laboratory (NETL). Carbon Sequestration Program Environmental Reference Document. No. DE-AT26-04NT42070. <http://www.netl.doe.gov/technologies/carbon_seq/refshelf/nepa/index.html>. Site accessed June 2011.
- U.S. Environmental Protection Agency (EPA). AirData: Access to Air Pollution Data. <<http://www.epa.gov/air/data/index.html>>. Site accessed May 2011.
- . 1994. Final Environmental Impact Statement, Tampa Electric Company, Polk Power Station; June. EPA No. 904/9-94-002.
- U.S. Geological Survey (USGS). 2010. USGS Earthquake Hazards Program – Florida Earthquake Information. <<http://earthquake.usgs.gov/earthquakes/states/index.php?regionID=9>>. Site accessed May 2011.
- U.S. Soil Conservation Services (SCS). 1990. Soil Survey of Polk County, Florida. U.S. Department of Agriculture.
- University of South Florida (USF). 2011. Draft Report - Numerical Simulation of CO₂ and Wastewater Injection at Tampa Electric Company Polk Power Station. Prepared for Environmental Consulting & Technology, Inc., and Tampa Electric Company. Prepared by Roland Okwen, Mark Thomas, Dr. Mark Stewart, Dr. Maya Trotz, and Dr. Jeffrey Cunningham.
- White, W.A. 1970. Geomorphology of the Florida Peninsula. Florida Bureau of Geology, Bulletin No. 51, 164 p.
- Winston, G.O. 1994. The Paleogene of Florida – Volume 3, Lithostratigraphy of the Cedar Keys Formation of Paleocene and Upper Cretaceous Age – Peninsular Florida and Environs. Miami Geological Society.

This page intentionally left blank.

APPENDIX A DISTRIBUTION LIST

This appendix contains the list of persons and agencies who received a copy of this environmental assessment.

LOCAL OFFICES

Edwin Smith, Chairman
Polk County Board of County Commissioners
300 West Church Street
Bartow, Florida 33830-3760

Mulberry Public Library
103 East Canal Street
Mulberry, Florida 33860-2442

Frank Satchel, Jr., City Manager
City of Mulberry
104 South Church Avenue
Mulberry, Florida 33860-3002

Lakeland Public Library
100 Lake Morton Drive
Lakeland, Florida 33801-5347

STATE OFFICES

Rick Scott
Governor of Florida
The State Capitol
400 South Monroe Street
Tallahassee, Florida 32399-0001

Cindy Mulkey, Program Administrator
Siting Coordination Office
Florida Department of Environmental Protection
3900 Commonwealth Boulevard, MS 48
Tallahassee, Florida 32399-3000

Lauren Milligan, Environmental Manager
Florida State Clearinghouse
Florida Department of Environmental Protection
3900 Commonwealth Boulevard, MS 47
Tallahassee, Florida 32399-3000

Michael Halpin, Director
Division of Air Resource Management
Florida Department of Environmental Protection
2600 Blair Stone Road, MS 5500
Tallahassee, Florida 32399-2400

Maryann Poole, Director
Office of Policy and Stakeholder Coordination
Florida Fish & Wildlife Conservation Commission
620 South Meridian Street, MS 5B5
Tallahassee, Florida 32399-1600

Joe Haberfeld
Underground Injection Control Program
Water Facilities Regulation
Florida Department of Environmental Protection
2600 Blair Stone Road, MS 3500
Tallahassee, Florida 32399-2400

Laura A. Kammerer
Deputy State Historic Preservation Officer for
Review and Compliance
Division of Historical Resources
500 South Bronough Street
Tallahassee, Florida 32399-0250

FEDERAL OFFICES

Heinz Mueller, Chief
NEPA Program Office
U.S. Environmental Protection Agency, Region 4
61 Forsyth Street, Southwest
Atlanta, Georgia 30303

Paul Souza, Field Supervisor
South Florida Ecological Services Office
U.S. Fish & Wildlife Service
1339 20th Street
Vero Beach, Florida 32960-3559

TRIBES

Mr. Mitchell Cypress
Chairperson
Seminole Tribe of Florida
6300 Stirling Road
Hollywood, Florida 33024

Mr. Leonard Harjo
Principal Chief
Seminole Nation of Oklahoma
P.O. Box 1498
Wewoka, Oklahoma 74884

Mr. Alan D. Emarthle
Seminole Nation Historical Preservation Officer
Mekusukey Mission
P.O. Box 1768
Seminole, Oklahoma 74868

Mr. Ted Underwood
Seminole Nation of Oklahoma
Business and Corporate Regulatory Commission
Mekusukey Mission
P.O. Box 1768
Seminole, Oklahoma 74868

Mr. Willard Steele
Tribal Historic Preservation Officer
Seminole Tribe of Florida
Tribal Historic Preservation Office
34725 West Boundary Road
Clewiston, Florida 33440

APPENDIX B CONSULTATIONS

This appendix contains the consultation correspondence between DOE and the Florida State Historic Preservation Office, Seminole Tribe of Florida, and Seminole Nation of Oklahoma.

Note: The figure attachments to the letters sent to the tribal contacts are identical and are not duplicated for all of the letters.



April 11, 2011

Mr. Scott Stroh, Director and State Historic Preservation Officer
Division of Historical Resources
R.A. Gray Building
500 South Bronough Street
Tallahassee, Florida 32399-6504

Dear Mr. Stroh:

SUBJECT: U.S. Department of Energy Request for Consultation for the RTI International Scale-Up of High-Temperature Synthesis Gas Cleanup and Carbon Capture and Sequestration Technologies, Polk County, Florida

The U.S. Department of Energy (DOE) proposes to provide cost-shared funding to RTI International (RTI) for a project that would demonstrate the scale-up of high-temperature synthesis gas (syngas) cleanup and carbon dioxide (CO₂) capture and sequestration technologies. The proposed project would be located at Tampa Electric Company's existing integrated gasification combined-cycle (IGCC) power plant at its Polk Power Station in Polk County, Florida. The overall objective of RTI's proposed project is to mitigate the technical risk associated with scale-up of the syngas cleanup and CO₂ capture and sequestration technologies to enable subsequent commercial deployment.

The proposed project would be located within the 4,348-acre Tampa Electric Polk Power Station property in southwestern Polk County. This industrial property dedicated to electricity generation is located approximately 11 miles south of the city of Mulberry, 17 miles south of the city of Lakeland, and 28 miles southeast of the city of Tampa (see enclosed Figures 1 and 2). The Polk Power Station currently contains five electric generating units and associated facilities, including the nominal 260-megawatt (MW) Polk Unit 1 IGCC facility that began commercial operation in 1996. Polk Unit 1 is fired with syngas produced by gasifying coal and petroleum coke. The other four existing Polk units are 165-MW, simple-cycle combustion turbine facilities fired on natural gas. Prior to Tampa Electric's development of the existing Polk Power Station, the site and majority of the surrounding lands were previously impacted by phosphate mining activities. The proposed RTI project facilities would be located within an approximately 2.4-acre area adjacent to the existing Polk Unit 1 IGCC facilities (see enclosed Figure 3). The enclosed Figure 4 shows the specific RTI project site, located in Township 32 south, Range 23 east, Section 3, on the Baird, Florida, U.S. Geological Survey (USGS) quadrangle.

For the proposed scale-up demonstration project, a slipstream of the Polk Unit 1 IGCC syngas would be treated using RTI high-temperature cleanup technologies. These technologies include a high-temperature desulfurization process to remove more than 99.9 percent of the sulfur in the syngas; trace contaminant removal processes to reduce arsenic, selenium, and mercury concentrations; and a direct sulfur recovery process to convert sulfur dioxide (SO₂) to commercial-grade elemental sulfur. In addition, the technologies would include a water gas shift reactor to convert carbon monoxide in the cleaned syngas into CO₂ and an activated methyldiethanolamine process to capture up to 90 percent of the CO₂, which has suitable quality for sequestration due to the high level of sulfur removal. Further, the demonstration project would include compression and drying facilities for the captured CO₂, and injection and sequestration of the CO₂ via a deep well (i.e., up to 6,000 to 8,000 feet below land

surface) into saline aquifer geologic formations underlying the Polk Power Station site. Up to 300,000 tons per year of CO₂ would be captured and sequestered. According to RTI's currently proposed plans, construction of the project facilities would start in April 2012, and be completed in March 2013. After a period of system testing and checkout, the scale-up technologies would be operated for approximately 8,000 hours over an 18 month period beginning in early 2014.

An environmental assessment (EA) is currently being prepared by DOE's National Energy Technical Laboratory for the proposed RTI project in accordance with the requirements of the National Environmental Policy Act. At this time, DOE has no reason to believe this project would cause impacts to any historic, prehistoric, or cultural resources or properties on the project site. The specific project site has been previously disturbed and used for development of the existing Polk Power Station. Further, prior to power plant development, a cultural resource assessment survey was conducted of the Polk Power Station property as part of the original environmental permitting efforts. The results of the survey were reviewed by the Florida Division of Historical Resources, State Historic Preservation Officer, who determined that the project was unlikely to affect any known or unknown historic or prehistoric resources (see enclosed letter, dated February 27, 1992).

In support of the EA preparation and to comply with Section 106 of the National Historic Preservation Act, DOE is initiating consultation and requesting any comments or concerns you have on the potential for this project to affect cultural resources. DOE completed an initial evaluation of the potential impacts that may be associated with this proposed project and determined that no historic properties would be affected. At this time, DOE asks the Florida State Historic Preservation Office for its concurrence with this finding. If you require additional information, or have any questions or comments about this project, please contact me at the following:

Mr. Mark Lusk, NEPA Document Manager
U.S. Department of Energy, National Energy Technology Laboratory
3610 Collins Ferry Road
P.O. Box 880, MS B07
Morgantown, West Virginia 26507-0880
Telephone: (304) 285-4145
E-mail: mark.lusk@netl.doe.gov

We would appreciate a timely response to our request for consultation. Thank you for taking the time to review this letter. DOE looks forward to working with you on this and future projects.

Sincerely,



Mark Lusk
NEPA Document Manager

Enclosed:

Figure 1: Regional Location of Polk Power Station Site

Figure 2: General Vicinity Map of Polk Power Station

Figure 3: Aerial Photograph of Polk Power Station Site and RTI Project Site

Figure 4: USGS Quadrangle of Polk Power Station Site (Premining and Predevelopment) and RTI Project Site

Letter: Polk Power Station Cultural Resource Assessment Review Request

Cc: David Lyons (NETL)
Jack D. Doolittle (ECT)
Mr. Ben Gardner (RTI)

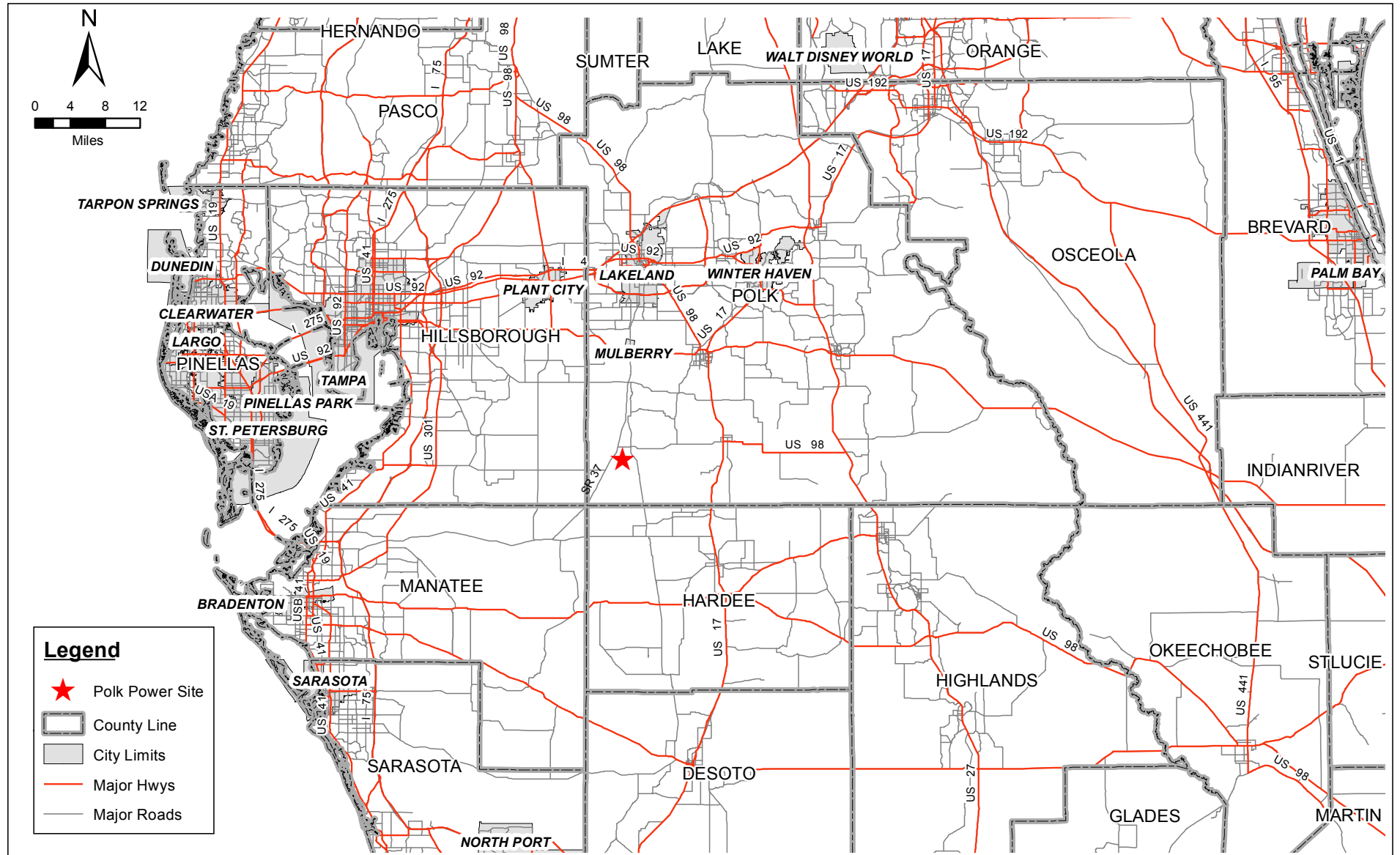

FIGURE 1.
REGIONAL LOCATION OF THE POLK POWER STATION SITE

Sources: FGDL, 2006; ECT, 2011.

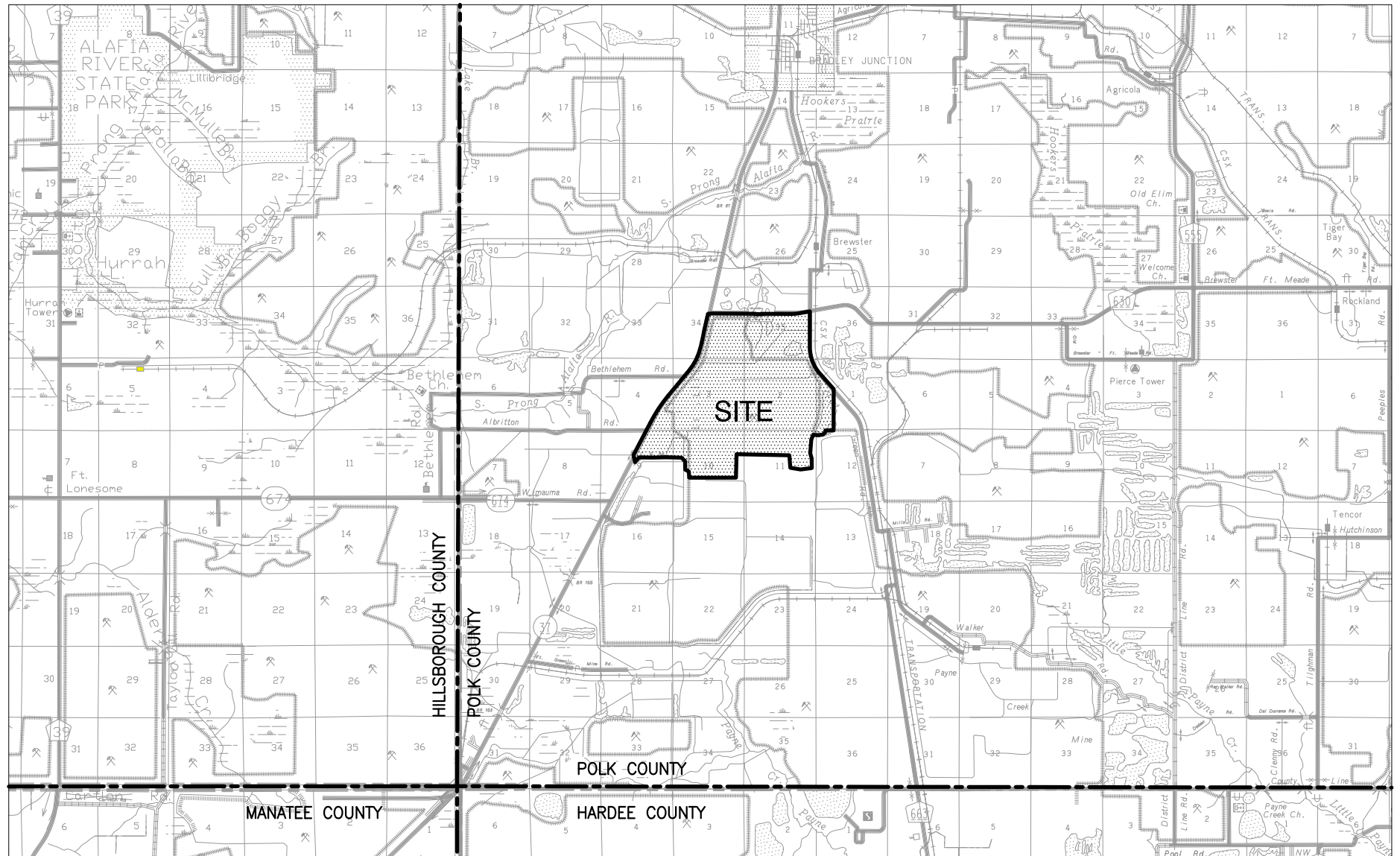

FIGURE 2.

GENERAL VICINITY MAP AND BOUNDARIES OF THE POLK POWER STATION SITE

SOURCES: FDOT Map, 2000; ECT, 2011.

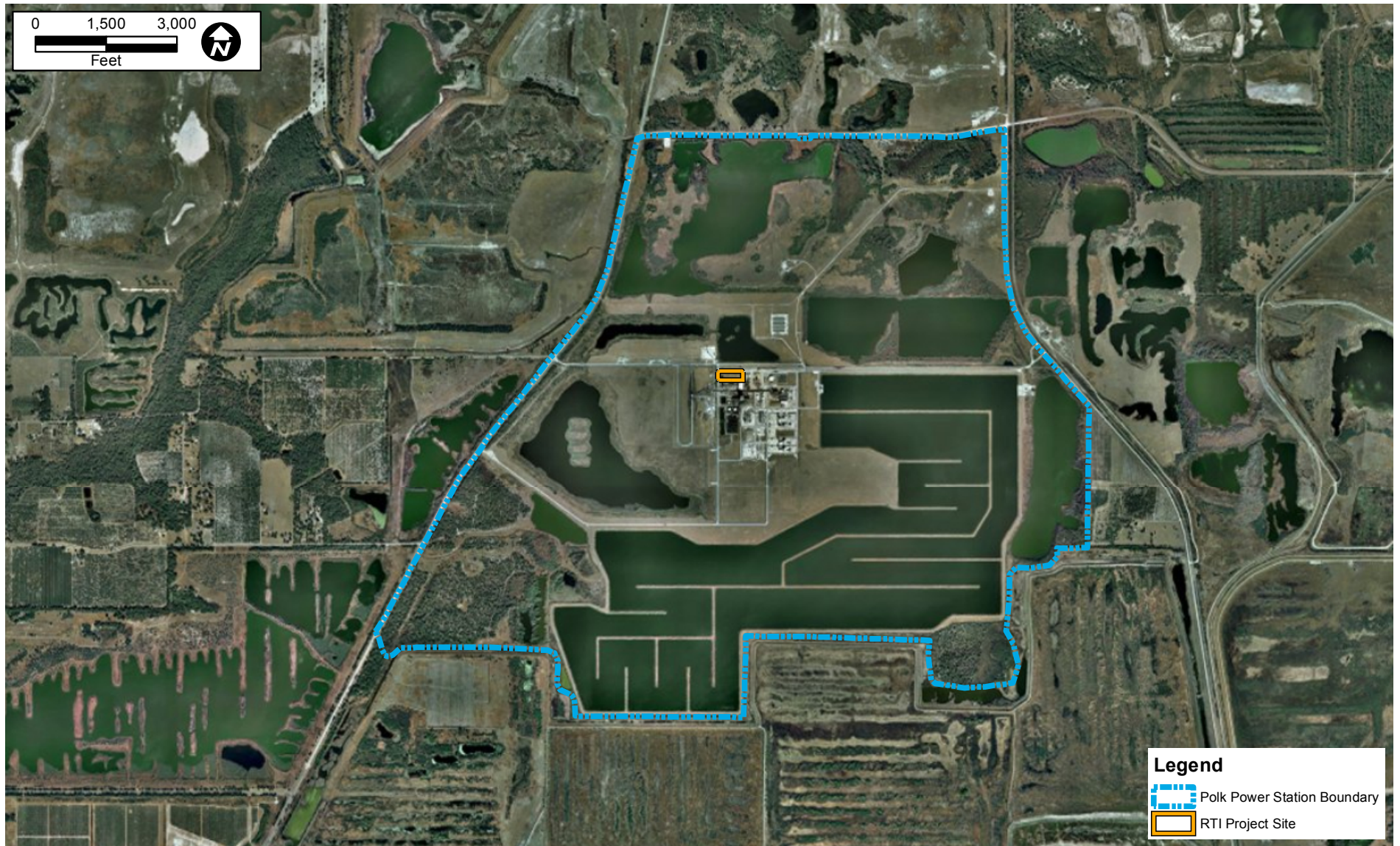

FIGURE 3.

AERIAL PHOTOGRAPH OF POLK POWER STATION SITE AND RTI PROJECT SITE

Sources: Aerials Express, 2009; ECT, 2011.

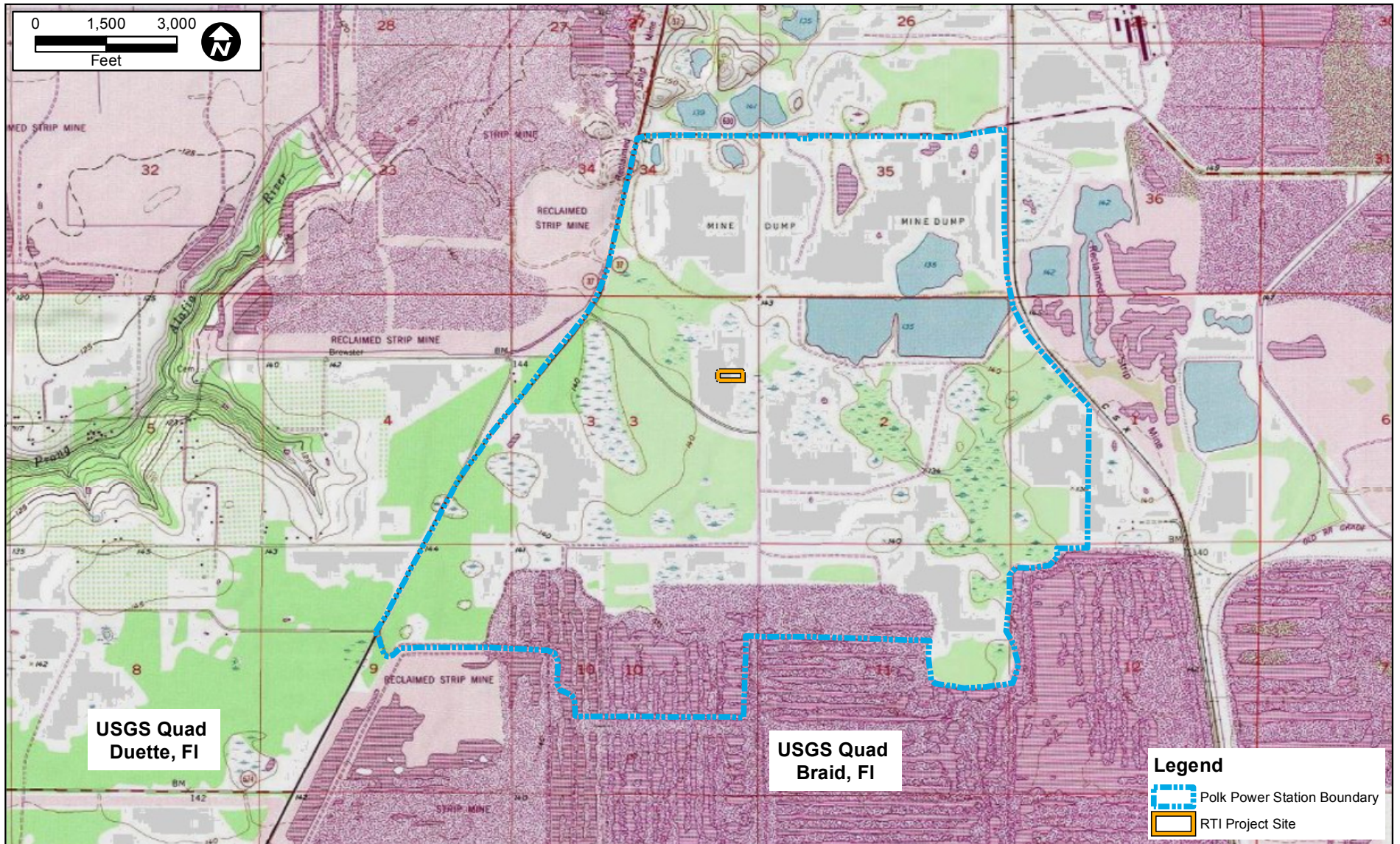

FIGURE 4.
USGS QUAD OF POLK POWER STATION SITE (PRE-MINING AND PRE-DEVELOPMENT)
AND RTI PROJECT SITE

Sources: USGS Quads: Duette and Braid, FI, 1987; ECT, 2011.



FLORIDA DEPARTMENT OF STATE

Jim Smith
Secretary of State

DIVISION OF HISTORICAL RESOURCES

R.A. Gray Building
500 South Bronough

Tallahassee, Florida 32399-0250

Director's Office

Telecopier Number (FAX)

(904) 488-1480

(904) 488-3353

February 27, 1992

Mr. Charles Fuhrmeister
Piper Archaeology/Janus Research
P.O. Box 919
St. Petersburg, Florida 33731

In Reply Refer To:
Susan Hammersten
Historic Sites
Specialist
(904) 487-2333
Project File No. 920360

Re: Cultural Resource Assessment Review Request
*Cultural Resource Assessment Survey of the Proposed TEC
Polk Power Station Siting Area, Polk County, Florida.*

Dear Mr. Fuhrmeister:

In accordance with this agency's responsibilities under Chapter 403, Florida Statutes, we have reviewed the information in the above referenced report, and find it to be complete and sufficient. We note that no previously unrecorded, historic or prehistoric sites were encountered during the survey.

Therefore, on the basis of the negative findings, it is the opinion of this agency that the proposed TEC Polk Power Station project is unlikely to affect any sites listed, or eligible for listing, in the National Register. The project may proceed without further involvement with this agency.

If you have any questions concerning our comments, please do not hesitate to contact us. Your interest in protecting Florida's archaeological and historic resources is appreciated.

Sincerely,

Suzanne P. Walker
for George W. Percy, Director
Division of Historical Resources
and
State Historic Preservation Officer

GWP/Hsh



FLORIDA DEPARTMENT OF STATE
Kurt S. Browning
Secretary of State
DIVISION OF HISTORICAL RESOURCES

Mr. Mark Lusk
U.S. Department of Energy
National Energy Technology Laboratory
3610 Collins Ferry Road
P.O. Box 880, MS B07
Morgantown, West Virginia 26507-0880

April 25, 2011

Re: SHPO #: 2011-1491/ Received by SHPO: April 14, 2011
*U.S. Department of Energy: RTI International Scale-Up of High-Temperature Synthesis Gas
Cleanup and Carbon Capture and Sequestration Technologies*
Project located at Tampa Electric Company's Existing Integrated Gasification Combined-
Cycle (IGCC) Power Plant at Polk Power Station in Polk County

Dear Mr. Lusk:

This office reviewed the referenced project for possible impact to historic properties listed, or eligible for listing, in the *National Register of Historic Places*. The review was conducted in accordance with Section 106 of the *National Historic Preservation Act of 1966*, as amended in 1992, *36 CFR Part 800: Protection of Historic Properties*.

Due to the nature of the above referenced undertaking no historic properties will be affected.

If there are any questions concerning our comments or recommendations, please contact Katherine Peterson, Historic Preservationist, by phone at 850.245.6333, or by electronic mail at kdpeterson@dos.state.fl.us.

Sincerely,

Laura A. Kammerer
Deputy State Historic Preservation Officer
For Review and Compliance

500 S. Bronough Street • Tallahassee, FL 32399-0250 • <http://www.flheritage.com>

Director's Office
850.245.6300 • FAX: 245.6436

Archaeological Research
850.245.6444 • FAX: 245.6452

Historic Preservation
850.245.6333 • FAX: 245.6437



April 11, 2011

Mr. Ted Underwood
Seminole Nation of Oklahoma
Business and Corporate Regulatory Commission
Mekusukey Mission
P.O. Box 1768
Seminole, Oklahoma 74868

Dear Mr. Underwood:

SUBJECT: U.S. Department of Energy Request for Consultation for the RTI International Scale-Up of High-Temperature Synthesis Gas Cleanup and Carbon Capture and Sequestration Technologies, Polk County, Florida

The U.S. Department of Energy (DOE) proposes to provide cost-shared funding to RTI International (RTI) for a project that would demonstrate the scale-up of high-temperature synthesis gas (syngas) cleanup and carbon dioxide (CO₂) capture and sequestration technologies. The proposed project would be located at Tampa Electric Company's existing integrated gasification combined-cycle (IGCC) power plant at its Polk Power Station in Polk County, Florida. The overall objective of RTI's proposed project is to mitigate the technical risk associated with scale-up of the syngas cleanup and CO₂ capture and sequestration technologies to enable subsequent commercial deployment.

The proposed project would be located within the 4,348-acre Tampa Electric Polk Power Station property in southwestern Polk County. This industrial property dedicated to electricity generation is located approximately 11 miles south of the city of Mulberry, 17 miles south of the city of Lakeland, and 28 miles southeast of the city of Tampa (see enclosed Figures 1 and 2). The Polk Power Station currently contains five electric generating units and associated facilities, including the nominal 260-megawatt (MW) Polk Unit 1 IGCC facility that began commercial operation in 1996. Polk Unit 1 is fired with syngas produced by gasifying coal and petroleum coke. The other four existing Polk units are 165-MW, simple-cycle combustion turbine facilities fired on natural gas. Prior to Tampa Electric's development of the existing Polk Power Station, the site and majority of the surrounding lands were previously impacted by phosphate mining activities. The proposed RTI project facilities would be located within an approximately 2.4-acre area adjacent to the existing Polk Unit 1 IGCC facilities (see enclosed Figure 3).

For the proposed scale-up demonstration project, a slipstream of the Polk Unit 1 IGCC syngas would be treated using RTI high-temperature cleanup technologies. These technologies include a high-temperature desulfurization process to remove more than 99.9 percent of the sulfur in the syngas; trace contaminant removal processes to reduce arsenic, selenium, and mercury concentrations; and a direct sulfur recovery process to convert sulfur dioxide (SO₂) to commercial-grade elemental sulfur. In addition, the technologies would include a water gas shift reactor to convert carbon monoxide in the cleaned syngas into CO₂ and an activated methyldiethanolamine

process to capture up to 90 percent of the CO₂, which has suitable quality for sequestration due to the high level of sulfur removal. Further, the demonstration project would include compression and drying facilities for the captured CO₂ and injection and sequestration of the CO₂ via a deep well (i.e., up to 6,000 to 8,000 feet below land surface) into saline aquifer geologic formations underlying the Polk Power Station site. Up to 300,000 tons per year of CO₂ would be captured and sequestered. According to RTI's currently proposed plans, construction of the project facilities would start in April 2012, and be completed in March 2013. After a period of system testing and checkout, the scale-up technologies would be operated for approximately 8,000 hours over an 18 month period beginning in early 2014.

An environmental assessment (EA) is currently being prepared by DOE's National Energy Technology Laboratory for the proposed RTI project in accordance with the requirements of the National Environmental Policy Act. At this time, DOE has no reason to believe this project would cause impacts to tribal resources or properties of traditional, religious, or cultural significance on the project site. The specific project site has been previously disturbed and used for the existing Polk Power Station. Further, prior to power plant development, a cultural resource assessment survey was conducted of the Polk Power Station property as part of the original environmental permitting efforts. The results of the survey were reviewed by the Florida Division of Historical Resources, State Historic Preservation Officer, who determined that the project is unlikely to affect any known or unknown historic or prehistoric resources.

In support of the EA preparation and to comply with Section 106 of the National Historic Preservation Act and the Native American Graves protection and Repatriation Act of 1990, DOE is initiating consultation and requesting information your tribe may have on properties of traditional, religious, and cultural significance near the proposed project and any comments or concerns you have on the potential for this project to affect these properties. DOE completed an initial evaluation of the potential impacts that may be associated with this proposed project and determined that no tribal resources or properties would be affected. At this time, DOE asks you for concurrence with this finding. If you require additional information, or have any questions or comments about this project, please contact me at the following:

Mr. Mark Lusk, NEPA Document Manager
U.S. Department of Energy
National Energy Technology Laboratory
3610 Collins Ferry Road
P.O. Box 880, MS B07
Morgantown, West Virginia 26507-0880
Telephone: (304) 285-4145
E-mail: mark.lusk@netl.doe.gov

We would appreciate a timely response to our request for consultation. Thank you for taking the time to review this letter. DOE looks forward to working with you on this and future projects.

Sincerely,



Mark Lusk
NEPA Document Manager

Enclosed:

Figure 1: Regional Location of Polk Power Station Site

Figure 2: General Vicinity Map of Polk Power Station

Figure 3: Aerial Photograph of Polk Power Station Site and RTI Project Site

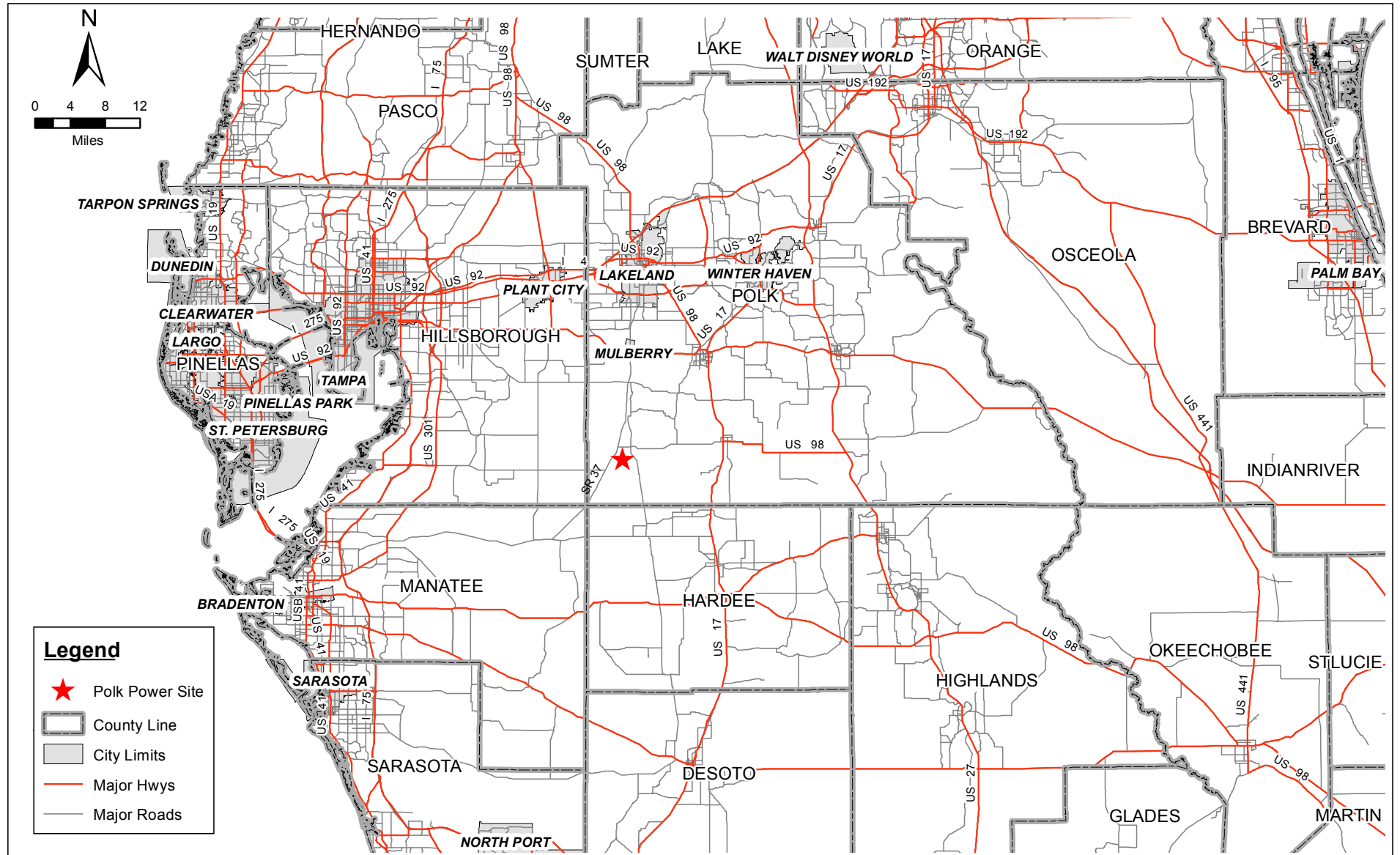

FIGURE 1.
REGIONAL LOCATION OF THE POLK POWER STATION SITE

Sources: FGDL, 2006; ECT, 2011.

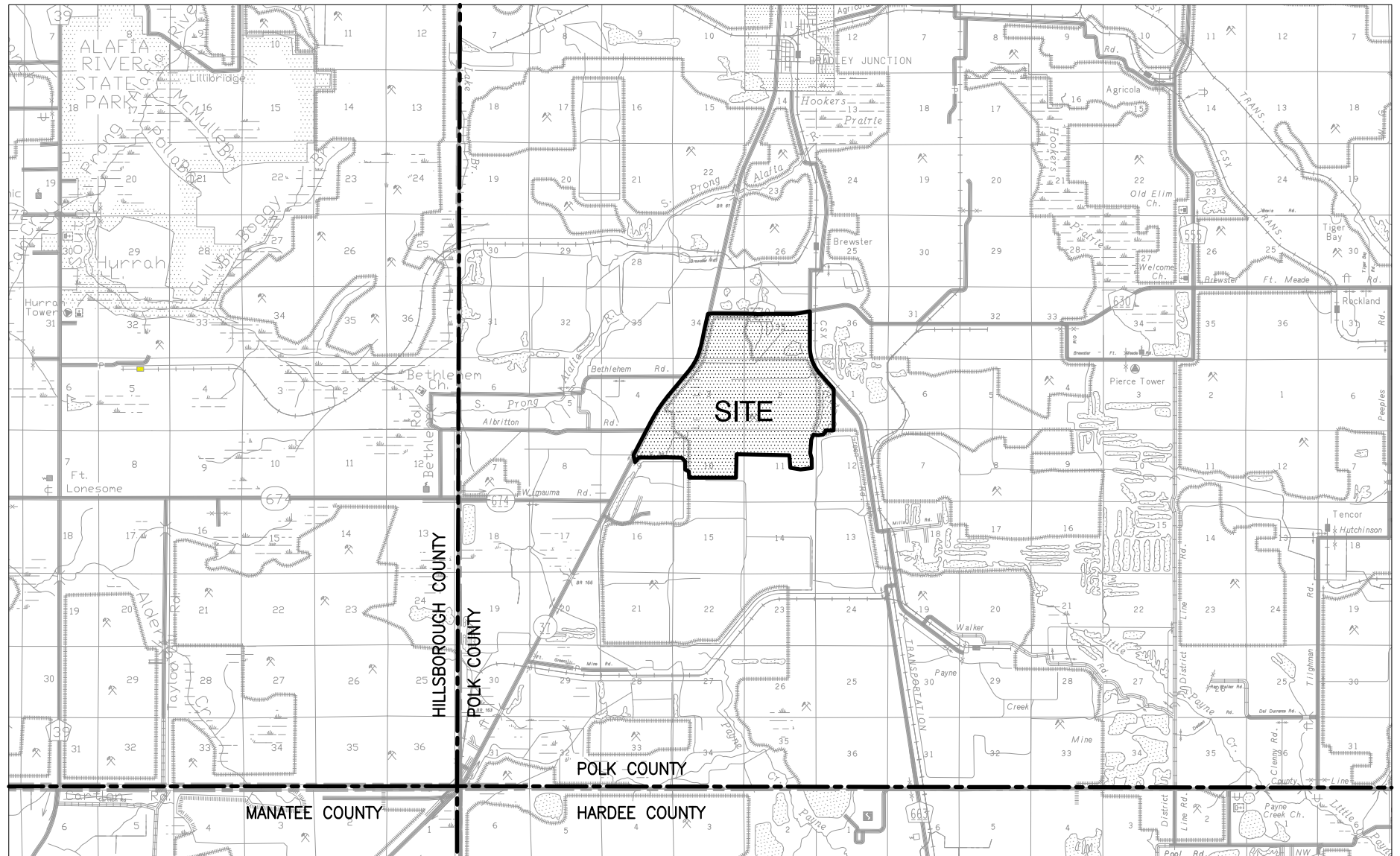

FIGURE 2.

GENERAL VICINITY MAP AND BOUNDARIES OF THE POLK POWER STATION SITE

SOURCES: FDOT Map, 2000; ECT, 2011.

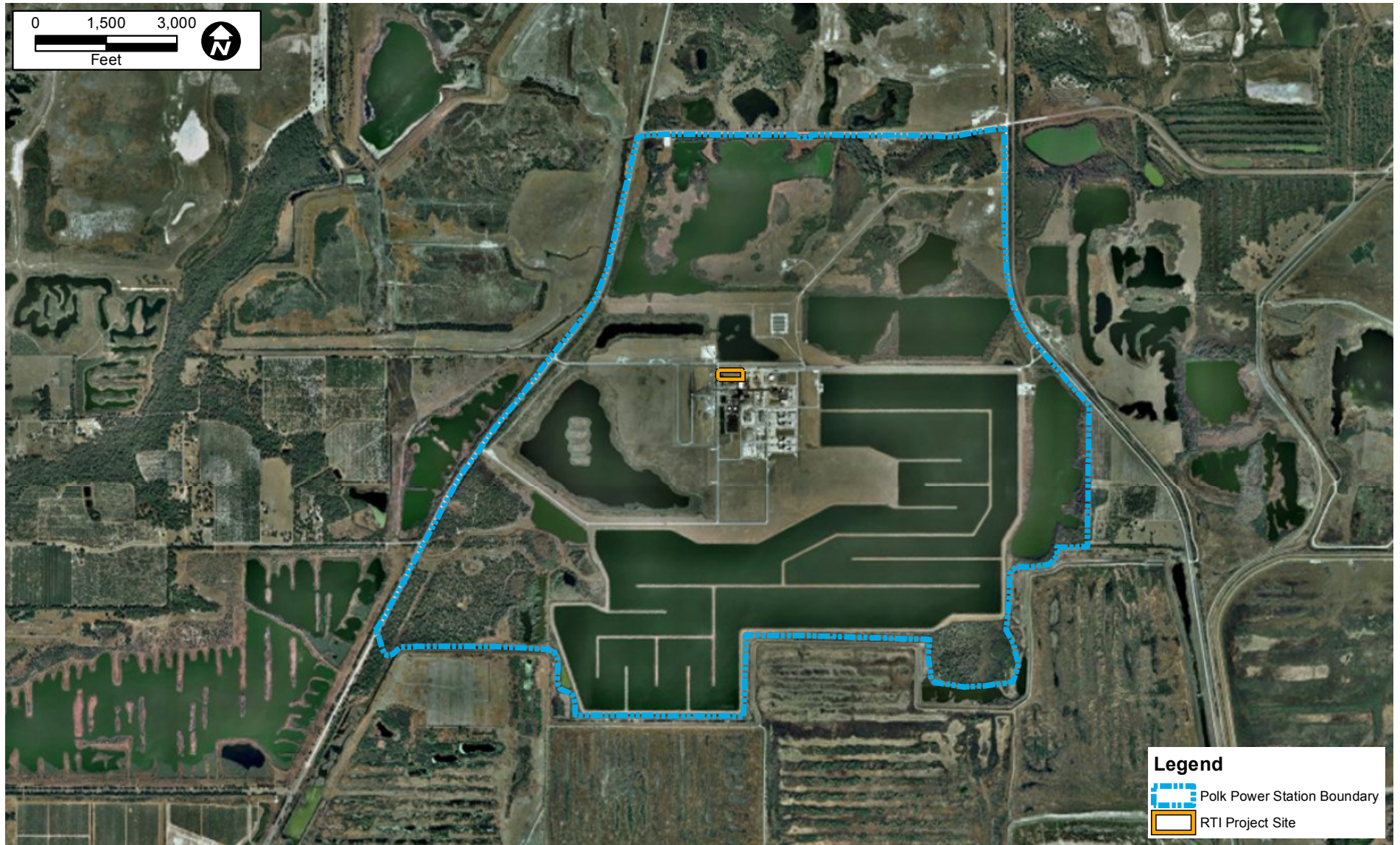

FIGURE 3.

AERIAL PHOTOGRAPH OF POLK POWER STATION SITE AND RTI PROJECT SITE

Sources: Aerials Express, 2009; ECT, 2011.



April 11, 2011

Mr. Alan D. Emarthle
Seminole Nation Historical Preservation Officer
Mekusukey Mission
P.O. Box 1768
Seminole, Oklahoma 74868

Dear Mr. Emarthle:

SUBJECT: U.S. Department of Energy Request for Consultation for the RTI International Scale-Up of High-Temperature Synthesis Gas Cleanup and Carbon Capture and Sequestration Technologies, Polk County, Florida

The U.S. Department of Energy (DOE) proposes to provide cost-shared funding to RTI International (RTI) for a project that would demonstrate the scale-up of high-temperature synthesis gas (syngas) cleanup and carbon dioxide (CO₂) capture and sequestration technologies. The proposed project would be located at Tampa Electric Company's existing integrated gasification combined-cycle (IGCC) power plant at its Polk Power Station in Polk County, Florida. The overall objective of RTI's proposed project is to mitigate the technical risk associated with scale-up of the syngas cleanup and CO₂ capture and sequestration technologies to enable subsequent commercial deployment.

The proposed project would be located within the 4,348-acre Tampa Electric Polk Power Station property in southwestern Polk County. This industrial property dedicated to electricity generation is located approximately 11 miles south of the city of Mulberry, 17 miles south of the city of Lakeland, and 28 miles southeast of the city of Tampa (see enclosed Figures 1 and 2). The Polk Power Station currently contains five electric generating units and associated facilities, including the nominal 260-megawatt (MW) Polk Unit 1 IGCC facility that began commercial operation in 1996. Polk Unit 1 is fired with syngas produced by gasifying coal and petroleum coke. The other four existing Polk units are 165-MW, simple-cycle combustion turbine facilities fired on natural gas. Prior to Tampa Electric's development of the existing Polk Power Station, the site and majority of the surrounding lands were previously impacted by phosphate mining activities. The proposed RTI project facilities would be located within an approximately 2.4-acre area adjacent to the existing Polk Unit 1 IGCC facilities (see enclosed Figure 3).

For the proposed scale-up demonstration project, a slipstream of the Polk Unit 1 IGCC syngas would be treated using RTI high-temperature cleanup technologies. These technologies include a high-temperature desulfurization process to remove more than 99.9 percent of the sulfur in the syngas; trace contaminant removal processes to reduce arsenic, selenium, and mercury concentrations; and a direct sulfur recovery process to convert sulfur dioxide (SO₂) to commercial-grade elemental sulfur. In addition, the technologies would include a water gas shift reactor to convert carbon monoxide in the cleaned syngas into CO₂ and an activated methyldiethanolamine process to capture up to 90 percent of the CO₂, which has suitable quality for sequestration due to

the high level of sulfur removal. Further, the demonstration project would include compression and drying facilities for the captured CO₂ and injection and sequestration of the CO₂ via a deep well (i.e., up to 6,000 to 8,000 feet below land surface) into saline aquifer geologic formations underlying the Polk Power Station site. Up to 300,000 tons per year of CO₂ would be captured and sequestered. According to RTI's currently proposed plans, construction of the project facilities would start in April 2012, and be completed in March 2013. After a period of system testing and checkout, the scale-up technologies would be operated for approximately 8,000 hours over an 18 month period beginning in early 2014.

An environmental assessment (EA) is currently being prepared by DOE's National Energy Technology Laboratory for the proposed RTI project in accordance with the requirements of the National Environmental Policy Act. At this time, DOE has no reason to believe this project would cause impacts to tribal resources or properties of traditional, religious, or cultural significance on the project site. The specific project site has been previously disturbed and used for the existing Polk Power Station. Further, prior to power plant development, a cultural resource assessment survey was conducted of the Polk Power Station property as part of the original environmental permitting efforts. The results of the survey were reviewed by the Florida Division of Historical Resources, State Historic Preservation Officer, who determined that the project is unlikely to affect any known or unknown historic or prehistoric resources.

In support of the EA preparation and to comply with Section 106 of the National Historic Preservation Act and the Native American Graves protection and Repatriation Act of 1990, DOE is initiating consultation and requesting information your tribe may have on properties of traditional, religious, and cultural significance near the proposed project and any comments or concerns you have on the potential for this project to affect these properties. DOE completed an initial evaluation of the potential impacts that may be associated with this proposed project and determined that no tribal resources or properties would be affected. At this time, DOE asks you for concurrence with this finding. If you require additional information, or have any questions or comments about this project, please contact me at the following:

Mr. Mark Lusk, NEPA Document Manager
U.S. Department of Energy
National Energy Technology Laboratory
3610 Collins Ferry Road
P.O. Box 880, MS B07
Morgantown, West Virginia 26507-0880
Telephone: (304) 285-4145
E-mail: mark.lusk@netl.doe.gov

We would appreciate a timely response to our request for consultation. Thank you for taking the time to review this letter. DOE looks forward to working with you on this and future projects.

Sincerely,



Mark Lusk
NEPA Document Manager

Enclosed:

Figure 1: Regional Location of Polk Power Station Site

Figure 2: General Vicinity Map of Polk Power Station

Figure 3: Aerial Photograph of Polk Power Station Site and RTI Project Site



April 11, 2011

Mr. Leonard Harjo
Principal Chief
Seminole Nation of Oklahoma
P.O. Box 1498
Wewoka, Oklahoma 74884

Dear Mr. Harjo:

SUBJECT: U.S. Department of Energy Request for Consultation for the RTI International Scale-Up of High-Temperature Synthesis Gas Cleanup and Carbon Capture and Sequestration Technologies, Polk County, Florida

The U.S. Department of Energy (DOE) proposes to provide cost-shared funding to RTI International (RTI) for a project that would demonstrate the scale-up of high-temperature synthesis gas (syngas) cleanup and carbon dioxide (CO₂) capture and sequestration technologies. The proposed project would be located at Tampa Electric Company's existing integrated gasification combined-cycle (IGCC) power plant at its Polk Power Station in Polk County, Florida. The overall objective of RTI's proposed project is to mitigate the technical risk associated with scale-up of the syngas cleanup and CO₂ capture and sequestration technologies to enable subsequent commercial deployment.

The proposed project would be located within the 4,348-acre Tampa Electric Polk Power Station property in southwestern Polk County. This industrial property dedicated to electricity generation is located approximately 11 miles south of the city of Mulberry, 17 miles south of the city of Lakeland, and 28 miles southeast of the city of Tampa (see enclosed Figures 1 and 2). The Polk Power Station currently contains five electric generating units and associated facilities, including the nominal 260-megawatt (MW) Polk Unit 1 IGCC facility that began commercial operation in 1996. Polk Unit 1 is fired with syngas produced by gasifying coal and petroleum coke. The other four existing Polk units are 165-MW, simple-cycle combustion turbine facilities fired on natural gas. Prior to Tampa Electric's development of the existing Polk Power Station, the site and majority of the surrounding lands were previously impacted by phosphate mining activities. The proposed RTI project facilities would be located within an approximately 2.4-acre area adjacent to the existing Polk Unit 1 IGCC facilities (see enclosed Figure 3).

For the proposed scale-up demonstration project, a slipstream of the Polk Unit 1 IGCC syngas would be treated using RTI high-temperature cleanup technologies. These technologies include a high-temperature desulfurization process to remove more than 99.9 percent of the sulfur in the syngas; trace contaminant removal processes to reduce arsenic, selenium, and mercury concentrations; and a direct sulfur recovery process to convert sulfur dioxide (SO₂) to commercial-grade elemental sulfur. In addition, the technologies would include a water gas shift reactor to convert carbon monoxide in the cleaned syngas into CO₂ and an activated methyldiethanolamine process to capture up to 90 percent of the CO₂, which has suitable quality for sequestration due to

the high level of sulfur removal. Further, the demonstration project would include compression and drying facilities for the captured CO₂ and injection and sequestration of the CO₂ via a deep well (i.e., up to 6,000 to 8,000 feet below land surface) into saline aquifer geologic formations underlying the Polk Power Station site. Up to 300,000 tons per year of CO₂ would be captured and sequestered. According to RTI's currently proposed plans, construction of the project facilities would start in April 2012, and be completed in March 2013. After a period of system testing and checkout, the scale-up technologies would be operated for approximately 8,000 hours over an 18 month period beginning in early 2014.

An environmental assessment (EA) is currently being prepared by DOE's National Energy Technology Laboratory for the proposed RTI project in accordance with the requirements of the National Environmental Policy Act. At this time, DOE has no reason to believe this project would cause impacts to tribal resources or properties of traditional, religious, or cultural significance on the project site. The specific project site has been previously disturbed and used for the existing Polk Power Station. Further, prior to power plant development, a cultural resource assessment survey was conducted of the Polk Power Station property as part of the original environmental permitting efforts. The results of the survey were reviewed by the Florida Division of Historical Resources, State Historic Preservation Officer, who determined that the project is unlikely to affect any known or unknown historic or prehistoric resources.

In support of the EA preparation and to comply with Section 106 of the National Historic Preservation Act and the Native American Graves protection and Repatriation Act of 1990, DOE is initiating consultation and requesting information your tribe may have on properties of traditional, religious, and cultural significance near the proposed project and any comments or concerns you have on the potential for this project to affect these properties. DOE completed an initial evaluation of the potential impacts that may be associated with this proposed project and determined that no tribal resources or properties would be affected. At this time, DOE asks you for concurrence with this finding. If you require additional information, or have any questions or comments about this project, please contact me at the following:

Mr. Mark Lusk, NEPA Document Manager
U.S. Department of Energy
National Energy Technology Laboratory
3610 Collins Ferry Road
P.O. Box 880, MS B07
Morgantown, West Virginia 26507-0880
Telephone: (304) 285-4145
E-mail: mark.lusk@netl.doe.gov

We would appreciate a timely response to our request for consultation. Thank you for taking the time to review this letter. DOE looks forward to working with you on this and future projects.

Sincerely,



Mark Lusk
NEPA Document Manager

Enclosed:

Figure 1: Regional Location of Polk Power Station Site

Figure 2: General Vicinity Map of Polk Power Station

Figure 3: Aerial Photograph of Polk Power Station Site and RTI Project Site



April 11, 2011

Mr. William Steele
Tribal Historic Preservation Officer
Seminole Tribe of Florida
Tribal Historic Preservation Office
34725 West Boundary Road
Clewiston, Florida 33440

Dear Mr. Steele:

SUBJECT: U.S. Department of Energy Request for Consultation for the RTI International Scale-Up of High-Temperature Synthesis Gas Cleanup and Carbon Capture and Sequestration Technologies, Polk County, Florida

The U.S. Department of Energy (DOE) proposes to provide cost-shared funding to RTI International (RTI) for a project that would demonstrate the scale-up of high-temperature synthesis gas (syngas) cleanup and carbon dioxide (CO₂) capture and sequestration technologies. The proposed project would be located at Tampa Electric Company's existing integrated gasification combined-cycle (IGCC) power plant at its Polk Power Station in Polk County, Florida. The overall objective of RTI's proposed project is to mitigate the technical risk associated with scale-up of the syngas cleanup and CO₂ capture and sequestration technologies to enable subsequent commercial deployment.

The proposed project would be located within the 4,348-acre Tampa Electric Polk Power Station property in southwestern Polk County. This industrial property dedicated to electricity generation is located approximately 11 miles south of the city of Mulberry, 17 miles south of the city of Lakeland, and 28 miles southeast of the city of Tampa (see enclosed Figures 1 and 2). The Polk Power Station currently contains five electric generating units and associated facilities, including the nominal 260-megawatt (MW) Polk Unit 1 IGCC facility that began commercial operation in 1996. Polk Unit 1 is fired with syngas produced by gasifying coal and petroleum coke. The other four existing Polk units are 165-MW, simple-cycle combustion turbine facilities fired on natural gas. Prior to Tampa Electric's development of the existing Polk Power Station, the site and majority of the surrounding lands were previously impacted by phosphate mining activities. The proposed RTI project facilities would be located within an approximately 2.4-acre area adjacent to the existing Polk Unit 1 IGCC facilities (see enclosed Figure 3).

For the proposed scale-up demonstration project, a slipstream of the Polk Unit 1 IGCC syngas would be treated using RTI high-temperature cleanup technologies. These technologies include a high-temperature desulfurization process to remove more than 99.9 percent of the sulfur in the syngas; trace contaminant removal processes to reduce arsenic, selenium, and mercury concentrations; and a direct sulfur recovery process to convert sulfur dioxide (SO₂) to commercial-grade elemental sulfur. In addition, the technologies would include a water gas shift reactor to convert carbon monoxide in the cleaned syngas into CO₂ and an activated methyldiethanolamine

process to capture up to 90 percent of the CO₂, which has suitable quality for sequestration due to the high level of sulfur removal. Further, the demonstration project would include compression and drying facilities for the captured CO₂ and injection and sequestration of the CO₂ via a deep well (i.e., up to 6,000 to 8,000 feet below land surface) into saline aquifer geologic formations underlying the Polk Power Station site. Up to 300,000 tons per year of CO₂ would be captured and sequestered. According to RTI's currently proposed plans, construction of the project facilities would start in April 2012, and be completed in March 2013. After a period of system testing and checkout, the scale-up technologies would be operated for approximately 8,000 hours over an 18 month period beginning in early 2014.

An environmental assessment (EA) is currently being prepared by DOE's National Energy Technology Laboratory for the proposed RTI project in accordance with the requirements of the National Environmental Policy Act. At this time, DOE has no reason to believe this project would cause impacts to tribal resources or properties of traditional, religious, or cultural significance on the project site. The specific project site has been previously disturbed and used for the existing Polk Power Station. Further, prior to power plant development, a cultural resource assessment survey was conducted of the Polk Power Station property as part of the original environmental permitting efforts. The results of the survey were reviewed by the Florida Division of Historical Resources, State Historic Preservation Officer, who determined that the project is unlikely to affect any known or unknown historic or prehistoric resources.

In support of the EA preparation and to comply with Section 106 of the National Historic Preservation Act and the Native American Graves protection and Repatriation Act of 1990, DOE is initiating consultation and requesting information your tribe may have on properties of traditional, religious, and cultural significance near the proposed project and any comments or concerns you have on the potential for this project to affect these properties. DOE completed an initial evaluation of the potential impacts that may be associated with this proposed project and determined that no tribal resources or properties would be affected. At this time, DOE asks you for concurrence with this finding. If you require additional information, or have any questions or comments about this project, please contact me at the following:

Mr. Mark Lusk, NEPA Document Manager
U.S. Department of Energy
National Energy Technology Laboratory
3610 Collins Ferry Road
P.O. Box 880, MS B07
Morgantown, West Virginia 26507-0880
Telephone: (304) 285-4145
E-mail: mark.lusk@netl.doe.gov

We would appreciate a timely response to our request for consultation. Thank you for taking the time to review this letter. DOE looks forward to working with you on this and future projects.

Sincerely,



Mark Lusk
NEPA Document Manager

Enclosed:

Figure 1: Regional Location of Polk Power Station Site

Figure 2: General Vicinity Map of Polk Power Station

Figure 3: Aerial Photograph of Polk Power Station Site and RTI Project Site



April 11, 2011

Mr. Mitchell Cypress
Chairperson
Seminole Tribe of Florida
6300 Stirling Road
Hollywood, Florida 33024

Dear Mr. Cypress:

SUBJECT: U.S. Department of Energy Request for Consultation for the RTI International Scale-Up of High-Temperature Synthesis Gas Cleanup and Carbon Capture and Sequestration Technologies, Polk County, Florida

The U.S. Department of Energy (DOE) proposes to provide cost-shared funding to RTI International (RTI) for a project that would demonstrate the scale-up of high-temperature synthesis gas (syngas) cleanup and carbon dioxide (CO₂) capture and sequestration technologies. The proposed project would be located at Tampa Electric Company's existing integrated gasification combined-cycle (IGCC) power plant at its Polk Power Station in Polk County, Florida. The overall objective of RTI's proposed project is to mitigate the technical risk associated with scale-up of the syngas cleanup and CO₂ capture and sequestration technologies to enable subsequent commercial deployment.

The proposed project would be located within the 4,348-acre Tampa Electric Polk Power Station property in southwestern Polk County. This industrial property dedicated to electricity generation is located approximately 11 miles south of the city of Mulberry, 17 miles south of the city of Lakeland, and 28 miles southeast of the city of Tampa (see enclosed Figures 1 and 2). The Polk Power Station currently contains five electric generating units and associated facilities, including the nominal 260-megawatt (MW) Polk Unit 1 IGCC facility that began commercial operation in 1996. Polk Unit 1 is fired with syngas produced by gasifying coal and petroleum coke. The other four existing Polk units are 165-MW, simple-cycle combustion turbine facilities fired on natural gas. Prior to Tampa Electric's development of the existing Polk Power Station, the site and majority of the surrounding lands were previously impacted by phosphate mining activities. The proposed RTI project facilities would be located within an approximately 2.4-acre area adjacent to the existing Polk Unit 1 IGCC facilities (see enclosed Figure 3).

For the proposed scale-up demonstration project, a slipstream of the Polk Unit 1 IGCC syngas would be treated using RTI high-temperature cleanup technologies. These technologies include a high-temperature desulfurization process to remove more than 99.9 percent of the sulfur in the syngas; trace contaminant removal processes to reduce arsenic, selenium, and mercury concentrations; and a direct sulfur recovery process to convert sulfur dioxide (SO₂) to commercial-grade elemental sulfur. In addition, the technologies would include a water gas shift reactor to convert carbon monoxide in the cleaned syngas into CO₂ and an activated methyldiethanolamine process to capture up to 90 percent of the CO₂, which has suitable quality for sequestration due to

the high level of sulfur removal. Further, the demonstration project would include compression and drying facilities for the captured CO₂ and injection and sequestration of the CO₂ via a deep well (i.e., up to 6,000 to 8,000 feet below land surface) into saline aquifer geologic formations underlying the Polk Power Station site. Up to 300,000 tons per year of CO₂ would be captured and sequestered. According to RTI's currently proposed plans, construction of the project facilities would start in April 2012, and be completed in March 2013. After a period of system testing and checkout, the scale-up technologies would be operated for approximately 8,000 hours over an 18 month period beginning in early 2014.

An environmental assessment (EA) is currently being prepared by DOE's National Energy Technology Laboratory for the proposed RTI project in accordance with the requirements of the National Environmental Policy Act. At this time, DOE has no reason to believe this project would cause impacts to tribal resources or properties of traditional, religious, or cultural significance on the project site. The specific project site has been previously disturbed and used for the existing Polk Power Station. Further, prior to power plant development, a cultural resource assessment survey was conducted of the Polk Power Station property as part of the original environmental permitting efforts. The results of the survey were reviewed by the Florida Division of Historical Resources, State Historic Preservation Officer, who determined that the project is unlikely to affect any known or unknown historic or prehistoric resources.

In support of the EA preparation and to comply with Section 106 of the National Historic Preservation Act and the Native American Graves protection and Repatriation Act of 1990, DOE is initiating consultation and requesting information your tribe may have on properties of traditional, religious, and cultural significance near the proposed project and any comments or concerns you have on the potential for this project to affect these properties. DOE completed an initial evaluation of the potential impacts that may be associated with this proposed project and determined that no tribal resources or properties would be affected. At this time, DOE asks you for concurrence with this finding. If you require additional information, or have any questions or comments about this project, please contact me at the following:

Mr. Mark Lusk, NEPA Document Manager
U.S. Department of Energy
National Energy Technology Laboratory
3610 Collins Ferry Road
P.O. Box 880, MS B07
Morgantown, West Virginia 26507-0880
Telephone: (304) 285-4145
E-mail: mark.lusk@netl.doe.gov

We would appreciate a timely response to our request for consultation. Thank you for taking the time to review this letter. DOE looks forward to working with you on this and future projects.

Sincerely,



Mark Lusk
NEPA Document Manager

Enclosed:

Figure 1: Regional Location of Polk Power Station Site

Figure 2: General Vicinity Map of Polk Power Station

Figure 3: Aerial Photograph of Polk Power Station Site and RTI Project Site

SEMINOLE TRIBE OF FLORIDA
TRIBAL HISTORIC PRESERVATION OFFICE

TRIBAL HISTORIC
PRESERVATION OFFICE

SEMINOLE TRIBE OF FLORIDA
AH-TAH-THI-KI MUSEUM

34725 WEST BOUNDARY ROAD
CLEWISTON, FL 33440

PHONE: (863) 983-6549
FAX: (863) 902-1117



TRIBAL OFFICERS

CHAIRMAN
MITCHELL CYPRESS

VICE CHAIRMAN
RICHARD BOWERS JR.

SECRETARY
PRISCILLA D. SAYEN

TREASURER
MICHAEL D. TIGER

Mark Lusk, NEPA Document Manager
U.S. Department of Energy
National Energy Technology Laboratory
3610 Collins Ferry Road
P.O. Box 880, MS B07
Morgantown, West Virginia 26507-0880

THPO#:008086

May 2, 2011

Subject: RTI International Scale-Up of High-Temperature Synthesis Gas Cleanup and Carbon Capture and Sequestration Technologies, Polk County, Florida

Dear Mr. Lusk,

The Seminole Tribe of Florida's Tribal Historic Preservation Office (STOF-THPO) has received the U.S. Department of Energy's correspondence concerning the aforementioned project. The STOF-THPO has no objection to your findings at this time. However, the STOF-THPO would like to be informed if cultural resources that are potentially ancestral or historically relevant to the Seminole Tribe of Florida are inadvertently discovered during the final disposition process. We thank you for the opportunity to review the information that has been sent to date regarding this project. Please reference **THPO-008086** for any related issues.

We look forward to working with you in the future.

Sincerely,

Direct routine inquiries to:

Willard Steele
Tribal Historic Preservation Officer
Seminole Tribe of Florida

Anne Mullins
Compliance Review Supervisor
annemullins@semtribe.com

JP:am:ws

This page intentionally left blank.