



Environmental Assessment

K Pool Fish Rearing, Hanford Site, Richland, Washington

RECEIVED
FEB 24 1997
OSTI

U.S. Department of Energy
Richland, Washington

MASTER

December 1996

ENVIRONMENTAL ASSESSMENT

K POOL FISH REARING

HANFORD SITE, RICHLAND, WASHINGTON

U.S. DEPARTMENT OF ENERGY

RICHLAND, WASHINGTON

DISTRIBUTION OF THIS DOCUMENT IS UNLIMITED

December 1996

ng

This page intentionally left blank.

DISCLAIMER

**Portions of this document may be illegible
in electronic image products. Images are
produced from the best available original
document.**

Summary

The U.S. Department of Energy (DOE) has a need to respond to a request to lease facilities at the Hanford Site 100-KE and 100-KW filter plant pools (K Pools) for fish rearing activities. These fish rearing activities would be: (1) business ventures with public and private funds and (2) long-term enhancement and supplementation programs for game fish populations in the Columbia River Basin.

During the last three years, it has been demonstrated that Hanford water purification facilities are very adaptable for the rearing of fish. From May 1993 to May 1995, the Yakama Indian Nation (YIN), Washington Department of Fish & Wildlife, DOE, and Westinghouse Hanford Company (WHC) have participated in various cooperative projects in which fall chinook salmon smolts were raised and released into the Columbia River. Rainbow trout have also been raised in the K Pools. Certain warm-water species have also been raised for stocking into appropriate Washington State lakes.

The proposed action is to enter into a use permit or lease agreement with the YIN or other parties who would rear fish in the 100-K Area Pools. The proposed action would include necessary piping, pump, and electrical upgrades of the facility; cleaning and preparation of the pools; water withdrawal from the Columbia River, and any necessary water or wastewater treatment; and introduction, rearing and release of fish. Future commercial operations may be included.

The fish-rearing program would eventually include raising fall chinook salmon juveniles, white sturgeon, coho salmon, steelhead-trout, rainbow trout, and channel catfish, walleye, bass, crappie, and other warm water species. Only chinook salmon would be released into the Columbia River.

The K Pool salmon that would be released into the Columbia River and its tributaries would be reared under the policies, guidance, and procedures created by the Integrated Hatchery Operations Team (IHOT) for the Northwest Power Planning Council for the technical operation of all Columbia Basin anadromous salmonid hatcheries.

Cultural and biological reviews were conducted in order to judge the environmental impacts of the proposed actions. The main environmental issues of the proposed action are the return of water which may contain small amounts of fish food and waste products to the Columbia River and the possible effect on genetic diversity on stocks of native fish.

The former issue is mitigated by compliance with the National Pollutant Discharge Elimination System (NPDES) permit conditions on suspended solids and the small magnitude of soluble nutrients that would be in the effluent so as to avoid excessive plant growth. The latter issue is mitigated by the timing of the K Pool salmon release, which would not take place until after most smolts naturally produced in the Hanford Reach have already migrated downstream, and by limiting the number of salmon juveniles released from the K Pools to a small fraction of a percent of smolts either naturally produced or released from all other hatcheries.

Impacts on air, water, cultural, socioeconomic and environmental justice are also discussed.

These impacts were found to be minor with minimal environmental effect.

Glossary

Acronyms

BPA	Bonneville Power Administration
CFR	<i>Code of Federal Regulations</i>
CRR	Cultural Resources Review
CX	Categorical Exclusion
DOE	U.S. Department of Energy
EA	Environmental Assessment
ESA	<i>Endangered Species Act of 1973</i>
IHOT	Integrated Hatchery Operations Team
KE	K East
KW	K West
NEPA	<i>National Environmental Policy Act of 1969</i>
NPDES	National Pollutant Discharge Elimination System
NPPC	Northwest Power Planning Council
SHPO	State Historic Preservation Officer
SNF	Spent Nuclear Fuel
USFWS	United States Fish & Wildlife Service
WAC	<i>Washington Administrative Code</i>
WHC	Westinghouse, Hanford Company
WDFW	Washington Department of Fish and Wildlife
YIN	Yakama Indian Nation

Metric Conversion Chart

If you know	Multiply by	To get
Length		
centimeters	0.394	inches
meters	3.28084	feet
kilometers	0.62	miles
Area		
hectares	2.471054	acres
square kilometers	0.39	square miles
Volume		
liters	0.264	gallons
liters	.001	cubic meters
gallons	.13368	cubic feet
cubic meters	35.3147	cubic feet
Weight		
Kilograms	2.2046	Pounds

Source: Adapted from *CRC Handbook of Chemistry and Physics*, Robert C. Weast, Ph.D., 70th Ed., 1989-1990, CRC Press, Inc., Boca Raton, Florida.

Table of Contents

1.0 Purpose and Need for Agency Action	1-1
2.0 Description of the Proposed Action	2-1
3.0 Alternatives to the Proposed Action	3-1
3.1 No-Action Alternative	3-1
3.2 Alternative of leasing ponds at 100-D Area	3-1
3.3 Alternative of building and leasing new facilities	3-1
3.4 Alternative of continuing cooperative agreements	3-2
4.0 Affected Environment	4-1
5.0 Environmental Impacts of the Proposed Action	5-1
5.1 Impacts to Cultural Resources	5-1
5.2 Impacts to Biological Resources	5-1
5.3 Air Impacts	5-6
5.4 Land Impacts	5-6
5.5 Surface and Groundwater Impacts	5-6
5.6 Safety Impacts	5-7
5.7 Socioeconomic Impacts	5-7
5.8 Transportation Impacts	5-7
5.9 Environmental Justice Impacts	5-7
5.10 Cumulative Impacts	5-7
5.11 Impacts of Alternative Actions	5-8
6.0 Permits and Regulatory Requirements	6-1
7.0 Organizations Consulted	7-1
8.0 References	8-1

Appendices

Appendix A Biological Resources Review	A-1
Appendix B Cultural Resources Review	B-1
Appendix C Historic Property Inventory Form	C-1
Appendix D Public Comment and DOE Response to Comments	D-1
National Marine Fisheries Service, Comments and Response	D-2
Washington Department of Ecology, Comments and Response	D-8
Bonneville Power Administration, Comments and Response	D-10
Yakama Indian Nation, Comments and Response	D-14

Figures

1. Hanford Site Map	1-4
2. 100-K Area with Water Purification (K Pools) Layout	1-5

1.0 Purpose and Need for Agency Action

The U.S. Department of Energy (DOE) has a need to respond to a request for a long-term use permit or lease of unused Hanford Site facilities at the 100-K filter plant pools (K Pools) for fish rearing activities.

Background

Water purification filter plants (K Pools) located in the 100-K Area of the Hanford Site (Figures 1 and 2) were constructed in the early 1950's to provide cooling water to the associated plutonium production reactors. A distinction needs to be made between the K Basins where spent nuclear fuel is stored and the K Pools proposed for fish rearing activities. In February of 1996 the DOE issued a Final Environmental Impact statement (DOE/EIS-0245F) on the management of spent nuclear fuel (SNF) at the K Basins.

The K Pools received water pumped directly from the nearby Columbia River. Water flowed from the K Pools in single-pass fashion through the reactors and back to the river without any possibility of contaminating the K Pools with radioactive material. This mission ended in the 1970's, and, except for some interim usage for Hanford programs, 10 of the 12 K Pools have been unused by DOE since that time.

Because of possible concerns about radioactive contamination at the Hanford Site, all salmon projects conducted at the K Pools have had fish samples collected and bioassayed for radionuclides by the Washington Department of Health laboratory in Olympia, Washington. No radionuclides of significance were expected or found in the fish flesh because of the design, operation, and prior use of the water purification pools. This contamination-free nature of the Hanford K Pools has been repeatedly confirmed by testing samples of water, fish, sediment, and pool material for radioactivity.

Each of these K Pools has a water depth of 5.2 meters (17 feet). The pools are unlined concrete rectangular basins, each measuring 107 meters (351 feet) in length and 39 meters (127 feet) in width which is about .40 hectares (1 acre) in area. The capacity of each pool is approximately 23.8 million liters (6.3 million gallons) of water. Operable systems for these basins include pumps to control river water inflow, outflow from the settling pools, and discharge through an outfall pipe back to the river.

During the last three years, it has been shown on a small scale that excess Hanford water purification facilities are very adaptable for the rearing of fish. Beginning in the spring of 1993, the following short-term fish rearing pilot projects have either been conducted or are underway in the K Pools:

- From early April to late May 1993, 150,000 juvenile fall chinook salmon were held and fed ("grown-out") in a floating, tethered net pen, and then released as "smolts" into the Columbia River from the nearby Priest Rapids Hatchery. A smolt is a fish several months old, capable of adapting to salt water.

- In August 1993, 550 white sturgeon were placed in a net pen. They were intended to be raised as domestic broodstock to obtain eggs and young fish for sale to other aquaculturists.
- In early May 1994, the Yakama Indian Nation (YIN), DOE, and Westinghouse Hanford Company (WHC) took part in a cooperative agreement in which 500,000 upriver bright fall chinook salmon juveniles were grown-out to smolt stage, and released directly into the Hanford Reach of the Columbia River at the K Area to begin their migration to the Pacific Ocean.
- Beginning in May 1994, the Washington Department of Fish & Wildlife, DOE, and WHC participated in a collaborative project by rearing walleye and channel catfish for stocking into appropriate Washington State lakes.
- On March 17, 1995, about 12,000 rainbow trout fry were delivered to a net pen in a K Pool for rearing and eventual planting in mountain lakes on the YIN reservation.
- Starting in May 1995, the YIN, DOE, and WHC participated in rearing 700,000 upriver bright fall chinook salmon to be released in the Columbia River as smolts.

Based on the success of these small-scale projects, the YIN propose to conduct larger, long-term fish rearing activities in the K Pools under a long term use permit or lease with the DOE. The primary benefit of a fish rearing program at the K Pools would be the long-term enhancement of game fish populations with associated employment opportunities to the YIN as fishermen and fish resource managers. A secondary benefit would be the establishment of a commercial aquaculture program in the K Pools for economic development reasons, which could contribute to Tribal employment opportunities.

A large number of successful measures need to be implemented before the benefits of sustainable fisheries, as contemplated by the Northwest Power Act, tribal treaty rights, and commitments under the U.S./Canada Pacific Salmon Treaty, can again be achieved. The Northwest Power Planning Council's (NPPC) "Columbia River Basin Fish and Wildlife Program" (NPPC, 1994), which is funded by the Bonneville Power Administration (BPA), addresses this issue (BPA 1995).

The Department of Energy determined the small-scale short-term fish rearing activities were categorically excluded from the requirement to prepare a *National Environmental Policy Act of 1969* (NEPA) environmental assessment or environmental impact statement. These actions were excluded under 10 *Code of Federal Regulations* (CFR) 1021, Appendix D, Subpart B categorical exclusions (CX): B1.20, Small-scale activities undertaken to protect, restore, or improve fish and wildlife habitat, fish passage facilities (such as fish ladders or minor diversion channels), or fisheries, and B3.3, Research, inventory, and information collection activities that are directly related to the conservation of fish and wildlife resources and that involve only negligible animal mortality, habitat destruction, or population reduction.

However, the proposed long-term fish rearing activity evaluated in this document is not considered to be categorically excluded because the activity is proposed for a minimum period of five years with the potential to be ongoing for many more years. Expanded and long-term activities are not categorically excluded under the B1.20 or B3.3 CXs and therefore, preparation of this environmental assessment is necessary.

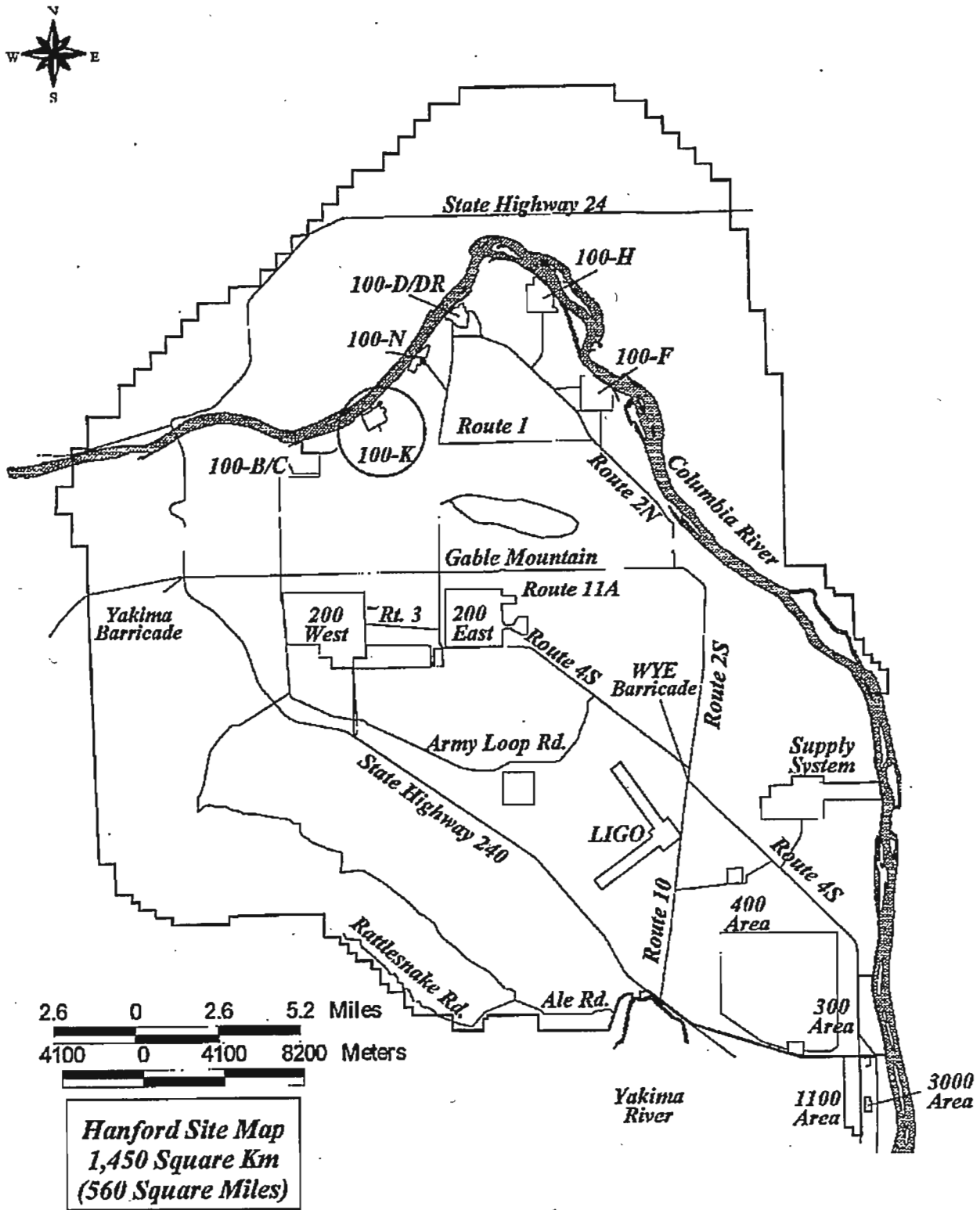

Figure 1.
Hanford Site Map.

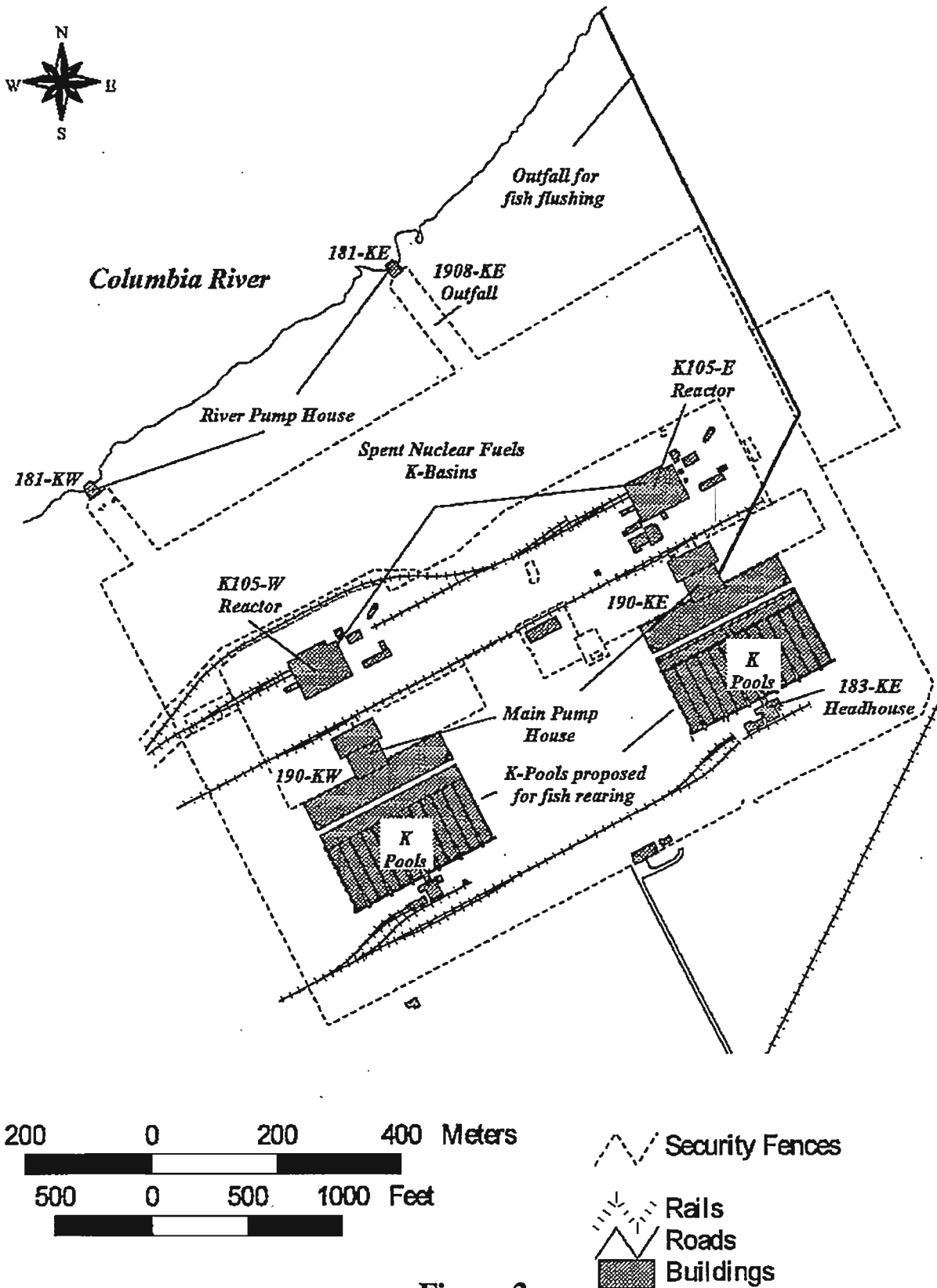

Figure 2.

100-K Area with Water Purification (K Pools) Layout

2.0 Description of the Proposed Action

The DOE proposes to enter into a use permit or lease agreement for up to 12 Hanford 100-K filter plant pools (K Pools) (Figure 2) and associated facilities, infrastructure, and/or services for the purpose of rearing fish. The initial agreement would be for a period of five years with options for renewal. If economically feasible, the fish rearing program would include an ongoing commercial fish rearing operation. These fish rearing activities would be a business venture by the lessee.

The lessee would raise fish for two purposes: (1) to provide a public service in the form of rearing and releasing fish species (e.g., salmon, sturgeon) for regional Columbia River Basin fisheries supplementation and enhancement purposes, and (2) to provide a product for commercial economic development reasons (fresh fish for sale to retail and restaurant markets, and live juvenile fish for sale to state and private agencies for stocking for sports fishing).

The fall chinook salmon smolts that would annually be reared in the K Pools and released to the Columbia River would be of upriver bright genetic stock. Fertilized eggs from broodstock returning to the Priest Rapids Hatchery would be hatched at either the Bonneville Salmon Hatchery, the Little White Salmon National Fish Hatchery, or the Priest Rapids Hatchery before being transported as juveniles to the K Pools via tanker truck.

The success and experience of three years of Hanford fish rearing pilot projects would be built upon to support future and private fish-rearing projects. The fish-rearing program would be expanded in terms of species, number of fish reared, and the number of water purification pools used. The following types of fish-rearing activities would take place at the K Pools:

- 1) Annual rearing of up to 700,000 fall chinook salmon juveniles to the smolt stage and releasing them directly into the Hanford Reach of the Columbia River,
- 2) Rearing of up to 500 white sturgeon to a mature stage for broodstock purposes to supply fish roe and young fish for sale but not for release.
- 3) Rearing up to 20,000 rainbow trout to 500-1000 g (1-2 lb) size for planting in appropriate lakes in accordance with appropriate fisheries agency procedures,
- 4) Rearing of up to 500,000 warm-water species (channel catfish, walleye, bass, crappie, etc.) to 150 g (0.33 lb) size for planting in appropriate lakes and ponds in accordance with appropriate fisheries agency procedures, and
- 5) Raising up to 1,400,000 kg (3,000,000 lb) annually of domesticated species, such as coho salmon and steelhead-trout for the fresh fish market.

Only salmon would be released to the Columbia River. White sturgeon and other fish being raised would not be released under this program. A separate environmental review by appropriate agencies would be required before other species of fish would be released to the river.

The raising of warm-water species would be operated in a water recirculation mode so that warm water would be conserved and heating expenses minimized. Dissolved

contaminants would be removed using appropriate fisheries technology. The live warm-water species and trout would be transported by tanker truck and turned over to the agencies that have the planting authority and responsibilities while the aquaculture fish would be transported in trucks from the Hanford Site directly to processing facilities.

Transportation to market of up to 1,359,000 kilograms (3,000,000 pounds) of fresh fish per year would involve a maximum of about 625 truck trips per year. This based on an estimated 362 kilograms (800 pounds) of fish per tote and a truck that would hold 6 totes or about 2174 kilograms (4800 pounds) per load. This equates to 2 trips per day. Also needing transport would be about 1,630,800 kilograms (3,600,000 pounds) of fish food per year. Assuming 18,120 kilograms (40,000 pounds) per tractor trailer load this would require about 2 transportation trips per week.

At present, during morning rush time (6:00am to 7:00am) Route 4S carries 1690 vehicles and route 2S carries 163 vehicles. During the rest of the day these highways are relatively free of traffic. Hanford Site highways are capable of carrying heavy loads and high volumes of traffic and thus would be unaffected by the few extra truck loads hauling fish and fish food.

The NPPC Columbia River Basin Fish and Wildlife Program is funded by the BPA. For the salmon and white sturgeon raising program it is expected that the lessee would obtain funding from the NPPC Fish and Wildlife Program. The potential budgets for annual BPA-funded lessee-sponsored fish propagation projects at the K Pools would be developed from the BPA Fish and Wildlife Division's future cost estimates. For the next four years maximum funding from all sources would be estimated as follows (in millions of dollars):

<u>1997</u>	<u>1998</u>	<u>1999</u>	<u>2000</u>
\$1.50	\$2.50	\$3.50	\$4.50

Job creation, in terms of person-years employment would be estimated at:

<u>Year 1</u>	<u>Year 2</u>	<u>Year 3</u>	<u>Year 4</u>
22.5	38	56	74

To support the fish rearing activity, there would be piping, pump and electrical upgrades of the leased facilities; cleaning and preparation of the pools; water withdrawal from the Columbia River and any necessary water or wastewater treatment, such as filtration and use of settling ponds to remove solids. Fish would be reared and released or sold to market. A temporary above ground pipeline would be constructed to aid in releasing or flushing fish into the river (see Figure 2).

The pools would be operated in such a manner that up to 34 million liters (9 million gallons) of river water per day would be needed to properly recirculate the pool water and keep temperatures within optimal levels. This water would be pumped from the 181-KE Pumping Station. The effluent from the pools would be released into the Hanford Reach of the Columbia River. The discharge would comply with conditions of any National Pollutant Discharge Elimination System (NPDES) permit that may become applicable.

Currently, the safe storage and management of radioactive reactor fuel in the K Basins (two rectangular concrete basins adjacent to the KE and KW reactors that were built in 1951

to temporarily store SNF) is an ongoing mission of the DOE (DOE/EIS-0245F). With regard to the life of the SNF storage mission, the Hanford Federal Facility Agreement and Consent Order (Washington State Department of Ecology, U.S. Environmental Protection Agency, and DOE) sets the year 2002 as the milestone date for the removal of spent fuel.

During the period when both the SNF Program and a fish rearing project would be ongoing at the K Area, the lessee would control those KE pools necessary for fish rearing. DOE would provide services to the lessee as specified in the lease while retaining control of the following: trash racks; fish screens; spray wash; motor control center; river pump house; the water flow path from river water pumps to the K Pools; headhouse for personal-comfort only access; water flow paths; including associated piping; valves; pumps; and electrical power; process sewer water flow paths to 1908-KE outfall; including associated piping and valves.

Also needed would be associated facilities for storage and ground area adjacent to K-pools as a laydown yard. After the SNF mission in the 100-K area ends, additional pools and features may be released to the lessee for use including areas such as additional water purification pools and some storage buildings and laydown yards. Certain utilities in the area may be modified to allow for a more efficient operation. Power sources may be needed adjacent to the pools to allow for aerators, automatic fish feeders, etc. Modifications would not involve surface excavations but may include upgrading or replacement of existing fish screens to meet Washington Department of Wildlife specifications.

The lease would provide that K Pool fish would be raised and released in accordance with procedures approved by the Integrated Hatchery Operations Team (IHOT) (BPA 1995) and other cognizant authorities. The IHOT is a multi-agency group comprised of representatives from the fisheries co-managers (six northwest Tribes, including the Yakama Indian Nation; Idaho, Oregon, and Washington Fish and Wildlife Agencies; National Marine Fisheries Service (NMFS); and the U.S. Fish and Wildlife Service) and the cooperating entities (Bonneville Power Administration, Mid-Columbia Public Utility Districts, U.S. Army Corps of Engineers, NPPC, Pacific Northwest Utilities Conference Committee, Columbia River Inter-Tribal Fish Commission, and Columbia Basin Fish and Wildlife Authority.)

The purpose of the IHOT policies is to ensure that hatchery operations would be consistent with the regional goal of rebuilding the Columbia Basin wild and naturally spawning fish runs. The IHOT-created performance standards for hatchery operations address such major activities as fish rearing, maintenance of fish health, fish transportation, monitoring and evaluating hatchery compliance, and staff training. Specific policies and procedures address the important considerations associated with fish health, ecological interactions, and fish genetics.

Releases of fall chinook salmon smolts from the K Pools would be tagged 100 percent and would not be increased above 700,000 until tag recovery information determines that Hanford fish do not adversely impact listed Snake River species. This is consistent with the NMFS biological opinion for 1995 to 1998 (Appendix D, pages D-4, D-5. At that time, the K Pool program may petition the National Marine Fisheries Service to increase K Pool releases to several million fall chinook salmon smolt and to reduce associated tagging requirements.

2.1 Special Lease Conditions

Historic Property Inventory Forms (Appendix C) would be processed through the State Historic Preservation Officer (SHPO). The lease agreement would assure that adequate restrictions or conditions are in place to comply with the National Historic Preservation Act.

The lessee, under conditions to be specified in the lease, would have use of portions of Hanford approved site(s) for disposal of non-hazardous solid effluents, infrastructure services such as electrical power, sanitary water, process and sanitary sewer, telephone, etc., and such other equipment, facilities, and pools as would be specified in the use permit or leasing agreement.

3.0 Alternatives to the Proposed Action

A range of reasonable alternatives to the proposed action was considered. These are alternative DOE responses to the YIN leasing request. Alternatives considered include: (1) The No Action Alternative and (2) offering other lease arrangements. These include: (A) The use of the water treatment basins at the 100-D Area, (B) Construction of new fish rearing facilities, and (C) Continuing one year cooperative agreements for fish rearing.

3.1 No-Action Alternative

Under the No Action Alternative, no long-term use permit or lease agreement for fish rearing at the K Pools would be granted. Ongoing fish rearing demonstration projects would continue to completion. The pools would sit unused waiting for eventual decommissioning. Any anticipated benefits for the fisheries resources would not be realized.

3.2 Alternative of leasing ponds at 100-D Area

Under this alternative, 14 of 16 concrete water supply basins at the 100-D Area would be leased as alternate facilities for fish rearing.

Two of the 16 concrete basins (Basins # 7 and 8) cannot currently be used for fish rearing activities that require flowing water because the discharge line has been filled with concrete. A new 2.4 kilometer (1.5 mile) long discharge line would be required for continuous water flow through the basins. Permits and approvals needed for construction on and near the shore of the Columbia River and for a new outfall would be necessary.

The other 14 basins would require extensive modifications to make them operational. The water inlet flume to the basins has been closed and repairs to the bottom plug valves are likely needed to keep the basins from leaking. There is extensive spalling of the concrete of all 16 basins which would require repair. For these reasons using the 100-D basins would be more expensive and difficult and therefore this alternative is less desirable than the proposed action.

3.3 Alternative of building and leasing new facilities

Under this alternative, new basins, water import and export lines, pumping systems and other infrastructure would be constructed elsewhere on the Hanford site and offered for use or lease for fish rearing activities.

However, building new facilities would be cost prohibitive when suitable facilities already exist. In addition, obtaining permits and approvals for new river intakes and outfalls would make this alternative more expensive than using the presently available and operational K Pools. Also, additional acres of shrub-steppe habitat might be destroyed by this approach.

3.4 Alternative of continuing cooperative agreements

Under this alternative, DOE would offer to make K water purification pools and infrastructure available to a lessee for fish rearing under consecutive one year cooperative agreements instead of making long-term agreements. An extensive and ongoing fish rearing and marketing business plan cannot be built upon short-term, one year agreements. Reliable, long-term agreements are needed for investment and business purposes. For these reasons, this alternative is not responsive to the YIN request.

4.0 Affected Environment

The Hanford Site is 1,450 square kilometers (560 square miles) of flat to gently rolling, shrub-steppe desert in southeastern Washington. Two topographical features dominate the landscape: Rattlesnake Mountain, which is a nearly treeless anticline 1,066 meters (3,500 feet) high, on the southwestern edge of the Hanford Site; and Gable Mountain, a ridge 339 meters (1,112 feet) high, north of the 200 East Area. The Hanford Site has a mild dry climate with about 16 centimeters (6 inches) of annual precipitation and occasional high winds up to 129 kilometers (80 miles) per hour. The Hanford Site is in an area of low to moderate seismicity (Neitzel 1996).

The Columbia River flows through the northern part of the Hanford Site, and turning south, it forms part of the Site's eastern boundary. Average annual flow of the Columbia river near Priest Rapids is 3,300 cubic meters per second (120,000 cubic feet per second). The minimum Federal Energy Regulatory Commission-licensed water flow release at the Priest Rapids Dam, which is upstream of the K Area, is 1,086 m³/sec (36,000 ft³/sec).

The K Area is located along the banks of the Columbia River (Figure 1) with the distance from the K Pools to the River being roughly .81 kilometers (0.5 mile). The K Area project site is surrounded by chainlink fence and is highly disturbed and industrialized. The natural environment inside the fenced area at K has been highly altered by development. All ground surface not covered by buildings, structures, and roadways is covered with a layer of gravel which is sprayed for vegetation control. Details specific to the natural environment surrounding the 100-K Area, including geology, soil, groundwater, and flora and fauna can be found in the *Hanford Site National Environmental Policy Act Characterization* report (Neitzel 1996).

The Hanford Reach of the Columbia River (a stretch of river that runs from Priest Rapids Dam to the headwaters of Lake Wallula in the 300 Area) is being considered for protection under Public Law 100-605, "Study of the Hanford Reach of the Columbia River". The destruction of other mainstream Columbia spawning grounds by dams has increased the relative importance of the Hanford Reach as a spawning ground for fall chinook salmon and steelhead trout. The closest observed spawning areas to the K Area permanent outfall and temporary flush line, during 40 years of observation, were at least 1 km (1/2 mi) upriver beyond Coyotes Rapids and about 6 km (4 mi) downriver (Dauble et al 1990).

The Columbia pebble snail and the shortface lanx are found in the Columbia River and are State of Washington candidate species for threatened or endangered listing. Both the these organisms occupy areas with sufficient flow, oxygenation, and gravel-to-boulder stable substrate (Neitzel et al 1993). Their diet consists largely of diatoms and smaller epilithic and epiphytic algae. Both avoid areas of slow flow, mud or silt substrate, or bare bedrock substrate.

The total number of fish species identified in the Hanford Reach is 44. Of these species, the chinook salmon, sockeye salmon, coho salmon, and steelhead trout use the river as a migration route to and from upstream spawning areas and are of economic importance. Both the fall chinook salmon and steelhead trout also spawn in the Hanford Reach. The destruction of other mainstream Columbia spawning grounds by dams has increased the relative importance of the Hanford Reach spawning. Other fish of importance to sport fishermen are the whitefish, white sturgeon, smallmouth bass, crappie, catfish, walleye, and perch.

A biological review was completed for the proposed project area (Appendix A). The review focused on plant and animal species protected under the *Endangered Species Act of 1973* (ESA), candidate species for such protection, species listed as threatened or endangered by the State of Washington, and species listed as state monitor species. The biological review concluded that: "No plant or animal species protected under the ESA, candidates for such protection, or species listed by the Washington state government were observed in the vicinity of the proposed site. No flora were observed in the vicinity. No migratory bird species were observed nesting in the vicinity of the proposed site."

The biological review also looked at the area where the temporary pipeline would be placed. Columbia River mugwort (state monitor 3 species) was observed as well as western kingbirds nesting on the 190 KE substation.

The river bed at the site of the K Area effluent pipeline is covered with large cobbles and boulders (WHC 1994). This permanent outfall pipeline which originates from 1908-KE is exposed along most of its length, and protrudes 0.3 to 1 m (1 to 3 ft) above the river bed at the exposure locations. The end of the pipeline is about 1 m (3 ft) above the river bed and discharges into an apparent 1 to 3 m (3 to 10 ft) deep depression, presumably caused when the K Reactors were in operation and receiving and discharging 980 million L/day (259 million gal/day) of water.

The 183 KE and KW Head Houses, the 183 KE and KW Chlorine Vaults, and the 183 KE and KW Filter Plants (K Pools) have been evaluated as contributing properties within the Hanford site Historic District and have been determined to be eligible for listing on the National Register of Historic Places.

Cultural resources in the vicinity of the 100-K area are varied and include archaeological and historical resources such as: Native American sites, original settler's homesteads, and Cold War properties. Archaeological districts are located both upstream and downstream and across the river from the K area. Inside the fenced area, culturally significant materials are unlikely to be discovered because there is a high degree of previous disturbance. The Cultural Review (Appendix B) concluded, "...If the facilities are found to be eligible for inclusion on the Register in the future, the current project will have no effect on any characteristics of the facilities that would make them eligible."

5.0 Environmental Impacts of the Proposed Action

5.1 Impacts to Cultural Resources

A Cultural Resources Review (CRR), Appendix B, was conducted for the proposed action. The CRR identified one archaeological site potentially in the path of the temporary fish flushing pipeline. The CRR recommended that either the pipeline be routed to circumvent the site or that the pipeline be constructed and dismantled by hand so as to avoid damaging the site by vehicles. To avoid impacting the archaeological site, hand placement of the pipeline would be employed as has been done the past two years with the experimental fish rearing runs. Modifications to existing structures would not require excavations into the surface.

Section 800.9(b)(5) of the implementing regulations for the National Historic Preservation Act requires that the lease of property determined to be eligible for listing on the National Register of Historic Places be considered and adverse effect unless "adequate restrictions or conditions are included to ensure preservation of the property's significant historic features" (36 CFR 800.9(c)(3)). Such conditions have been established for the K East Pools under the provisions of the *Programmatic Agreement among the U.S. Department of Energy, Richland Operations Office, the Advisory Council on Historic Preservation, and the Washington State Historic Preservation Office for the Maintenance, Deactivation, Alteration, and Demolition of the Built Environment on the Hanford Site, Washington (PA) DOE/RL-96-77 rev 0*.

The PA allows DOE-RL to manage historic properties at the site as elements of the Hanford Site Manhattan Project and Cold War Era Historic District. Per the PA, historic documentation will be prepared on representative buildings and structures to mitigate all adverse effects (including leasing) to the district. The K East Pools were determined to be a contributing property within the Historic District; however, they were not selected for mitigation since the historic significance of the K East Pools and supporting infrastructure will be represented on the Historic Property Inventory Forms prepared for the K West facilities. The historic significance of water treatment will be captured in the comprehensive sitewide historic narrative within the chapter documenting Reactor Operations.

Implementation of the PA provides for a no adverse effect determination for this action under the National Historic Preservation Act. In fact, the lease of the K Pools will have a beneficial effect on the Historic District. If the K pools are leased for a long term fish-rearing program, this adaptive re-use would lead to maintenance and some restoration of the structures involved. One expected positive impact of this action would be the physical preservation of the basic features of the historic property.

5.2 Impacts to Biological Resources

In February of 1996 the DOE issued a Final Environmental Impact Statement (DOE/EIS-0245F) on the management of spent nuclear fuel at the K Basins. This EIS examined various alternatives for managing spent nuclear fuel and the environmental impacts from those alternatives. The EIS identified no impacts on land use, geologic resources, or aesthetic and scenic resources and found that mitigation measures would not be necessary.

A Biological Review was conducted (Appendix A) for the proposed site. The Biological Review concluded that no federal endangered or threatened species or critical habitat would be adversely affected by activities within the 100 K fence. An extended review of the area outside the 100 K fence recommended that the pipeline not be placed before the end of July to avoid disturbing nesting kingbirds. The survey also recommended that the pipeline be placed upstream of an existing buried pipeline that runs out of the 116-KE building.

K Pool fish-rearing water effluent has been routinely released through the pipeline extending to near the center of the Columbia River. During the annual fall chinook salmon rearing and releasing project, it has been found that the K Pool surface water temperature is about 1.5 to 2° C (3 to 4° F) warmer than the Columbia River water temperature (Blodgett 1994). In addition, the end of this pipeline is about 1 m (3 ft) above the river bed. The minor K Pool effluent nutrient concentrations, the large river flow dilution effect, the buoyancy of the slightly warmer effluent water, and the above-river bed effluent release point all combine to lead to the conclusion that the Columbia pebblesnail and the shortface lanx would not be adversely impacted, even if assumed to live on the substrate below the end of the effluent pipeline.

The intermittent, several-day-per-year flushing of fall chinook salmon smolt through a temporary above-ground PVC pipeline into the Columbia River near the bank would have no adverse impact on (1) the Columbia pebblesnail and shortface lanx, because these mollusks avoid the slow water, and mud and silt substrate near the shore, and (2) the fall chinook salmon redds, because the nearest one is about 6 km (4 mi) downriver.

Operation of intake pump houses that supply river water to the K Pool fish programs may have the potential to impinge or entrain wild juvenile fall chinook salmon during March through May when emergent juveniles tend to rear along the shoreline. Juvenile resident species, such as minnows and suckers, are similarly vulnerable from April to September. Mortality of naturally-spawned juvenile fall chinook salmon is the environmental impact associated with withdrawal of Columbia River water. Properly designed and maintained fish screens, as described in the proposed action, would essentially eliminate this concern.

The annual release of about 700,000 K Pool-reared fall chinook salmon smolts into the Columbia River adjacent to the Hanford 100-K Area is expected to have minimal impact to either the fisheries in the migration corridor to the Pacific Ocean, or the downstream river aquatic environment. This is because (1) the K Pool release involves a relatively small number of fish when compared to other fish populations downstream of the release point, (2) the K Pool release would not increase overall production of fall chinook salmon in the Columbia River, and (3) the K Pool release would be timed so that most fall chinook salmon smolts naturally produced in the Hanford Reach would have already migrated downstream.

The Priest Rapids Hatchery, which is about 24 km (15 mi) upriver from the K Pools, has been releasing hatchery-reared fall chinook salmon smolts since the early 1960s. The K Pool acclimation operation would be the same type of activity, but on a smaller scale. The K Pool release would represent about 12% of the current 6 million annual fall chinook salmon juveniles released from Priest Rapids Hatchery. There is no evidence that the 30 year history of Priest Rapids Hatchery releases have reduced the survival of fall chinook salmon smolts naturally produced in the Hanford Reach. It is estimated that between 1981-89 the natural production of fall chinook salmon smolts in the Columbia River above McNary Dam and below Priest Rapids Dam ranged from 5 to 24 million fish (Norman, 1992).

When compared to the fall chinook salmon juveniles naturally spawned in the Hanford Reach plus those released from Priest Rapids Hatchery (estimated to range from 11-30 million per year), the K Pool release represents only 3-6% of this total. If fall chinook salmon smolts released from all Snake and Columbia River hatcheries are considered, then the K Pool release represents only a small fraction of this percentage. The K Pool fall chinook salmon rearing program may receive funding under the auspices of the John Day Mitigation Act. This would result in the reprogramming of the release of Priest Rapids fall chinook lower Columbia River hatcheries (such as Bonneville and Little White Salmon) to the upriver K Pool release site so as to enhance the upriver fishery. This would thus not result in an increase in the overall production of fall chinook salmon eggs in the Columbia River.

In January of 1996 Bonneville Power Administration issued a final Environmental Impact Statement (DOE/EIS-0169, *Yakima Fisheries Project*). This EIS was undertaken to study the environmental effects of raising anadromous fish for release into the Yakima River. While many of the issues are unique to the Yakima River tributaries, many of the issues on raising fish for release are the same for the Yakima River as for the Columbia River.

Just as in the case of the *Yakima Fisheries Project*, K Pool fish would be raised and released in accordance with procedures approved by the Integrated Hatchery Operations Team (IHOT) (BPA 1995) and other cognizant authorities. Using IHOT hatchery management policy would restrict the importation, dissemination, and amplification of pathogens and diseases known to adversely affect fish. Fish health and fish populations, whether cultured or free-swimming, would be protected from the adverse effects of disease outbreaks through the exposure to bacteria and viruses. IHOT health care standards include sanitation requirements, water quality parameters, general culture practices, fish health inspections and visits by specialists, and fish transfer and release requirements.

IHOT hatchery management policy would minimize ecological interactions that might adversely affect the productivity of aquatic ecosystems. Interactions between wild, natural, and hatchery fish populations that could adversely affect competition for food and habitat, or could involve predation would be avoided. IHOT ecological interaction standards include requirements on location and density of fish releases, fish size and age at release, and imprinting strategies.

IHOT genetic performance standards include requirements on donor stock (broodstock) selection, adult collection procedures, and spawning strategies. With regard to maintaining genetic diversity, existing genetic traits in fishery populations would be preserved. IHOT hatchery management policy would maintain genetic variation and fitness in populations and protect the genetic diversity of wild, natural, and cultured salmonids.

A recently-published National Research Council report (NRC, 1995) that responds to a Congressional request for advice on improving the prospects for long-term sustainability of Pacific Northwest salmon stocks addresses the issue of possible hatchery impacts on genetic/evolutionary risks and fish health. The important findings from this report on these two issues are summarized in the next two paragraphs.

Genetic variability or diversity within a local breeding population (such as upriver bright fall chinook salmon in the Hanford Reach) is believed to be exceedingly important for the species to adapt to extreme environmental changes that are likely to occur on the evolutionary time scale. Genetic diversity is maintained and expands through natural increases in the size of wild local populations, and through genetic exchange via natural

straying within a metapopulation of wild fish (i.e., clusters of local populations of the same species). Among fish species, salmon are unusually susceptible to local extinction because of their homing behavior, the relative small size of a local population and the associated riverain habitat, and their dependence on genetic diversity. The following type of genetic-related risks are believed to be possible as a result of artificial propagation programs at hatcheries:

- (1) The incubation, rearing, and releasing of hatchery fish of non-native or non-indigenous origin results in the loss of genetic variability in the wild local population.
- (2) Repeated hatchery inbreeding and the practice of making artificial mating selections erodes local population genetic diversity.
- (3) Human actions impose a degree of domestication in hatchery fish through such means as non-random collection of broodstock and differences between the hatchery and the natural environment (e.g., feeding practices, operational conditions, etc.) This may lead to a genetic response in hatchery descendants that results in decreased fitness for the natural environment.
- (4) Hatchery production can lead to the "mixed-stock" fishery problem in which the less productive stock in the mixture (often the wild or naturally reproducing one) would be over fished over time as compared to the hatchery stock. The wild population would eventually be driven to extinction as its escapement level drops below the replacement level.
- (5) Hatcheries remove returning adult fish depriving the aquatic ecosystem of the riverain habitat of an important seasonal source of nutrients.

Disease outbreaks are relatively common in hatcheries and are managed through standard water disinfectant and fish separation practices. There is considerable information available on the incidence of disease and effects on salmon in hatcheries. Once released into the Columbia River, a hatchery stock is exposed to the same parasites and infectious pathogens as fish from the wild or naturally reproducing stock. "In spite of comparatively high incidence among some hatchery-fish populations, there is little evidence of transmission of disease from infected hatchery fish to naturally reproduced fish," (NRC, 1995).

The goal of the K Pool upriver bright fall chinook salmon rearing and releasing program is to assist the rehabilitation of the natural population of the Hanford Reach. The goals of this program would be achieved without foreseeable adverse genetic impacts because the salmon juveniles grown out in the K Pools would be native to the Hanford Reach, being descended from upriver bright broodstock returning to the Priest Rapids Hatchery. Repeated inbreeding and artificial mating is not expected to occur at the K Pools since returning adults would not have physical access to the pool environment nor would they be expected to return to the Priest Rapids area having been imprinted on Hanford Reach water. It is expected that these fish would either spawn naturally in the Hanford Reach or not at all. K Pool salmon would receive identifying marks (finclips and coded-wire tags) to assess and control straying that may affect endangered stocks in other basins (e.g., lower Snake River fall chinook salmon). This is one element of the adaptive management approach that would be used in the K Pool program.

Since the K Pool fall chinook salmon would spend a relatively short time being reared in fresh water, as compared to most other salmon species, and would migrate downstream

during their first year, "domestication" impacts that may render these fish or their descendants less fit for the natural survival are not expected to occur. Wild fish currently compose the majority of mid-Columbia River fall-run chinook salmon and descendants of returning K Pool-released salmon would revert to natural stock, the K Pool program should not contribute to a "mixed-stock" fishery problem. K Pool-reared adult salmon cannot physically return to the pools, their carcasses would remain in the Hanford Reach, where they would provide benefits by depositing ocean-derived chemicals in the nutrient-poor aquatic and riparian ecosystems, and by providing food for birds and animals.

The potential environmental impact of discharging of K Pool water through the steel outfall pipeline to the center of the river is assessed as follows. Soluble and particulate nitrogen (N) and phosphorus (P) released by fish-rearing effluents could adversely impact the receiving water quality if excessive plant growth is promoted. The degree of impact depends on the season, the quantities of N and P released, the ambient concentrations of nutrients already in the receiving water, and the volumetric flow rate of the receiving water that provides dilution. The assessment of K Pool effluent impact is based on Ackerfors and Enell's values for the release of nutrients in both solid and soluble form from salmon farm operations using modern fish feed (Ackerfors and Enell, 1994):

Phosphorous	10 Kg per metric ton salmon produced
Nitrogen	60 Kg per metric ton salmon produced

The potential K Pool effluent impact is compared to target concentrations for avoiding excessive plant growth presented in DOE/EIS-0169, *Yakima Fisheries Project*, which are 1 to 2 mg/L of N and 0.1 mg/L of P.

It is possible to reduce the release of N and P by removing the solids component of the effluent. This would occur in the K Pools because of the "settling basin" nature of the pool design (i.e., outflow over a weir wall) and by providing settling areas or filters for fish reared in tanks or raceways. It is reasonable to expect 70% solid removal efficiency for such systems, which should lead to a reduction in at least 20% and 50%, respectively, of the total N and P released in the K Pool effluent. The nutrient loads applicable to K Pool fish rearing are thus estimated to be:

Phosphorous	5 Kg per metric ton fish produced
Nitrogen	48 Kg per metric ton fish produced

The expected maximum annual K Pool fish production that can result in release of N and P-laden effluent is estimated to be:

Commercial coho salmon/steelhead:	3,000,000 lb	= 1360.8 metric ton
Fall chinook salmon:	(700,000 fish)(1/60 lb/fish)	= 5.3 metric ton
White sturgeon:	(500 fish)(35 lb/fish)	= 6.8 metric ton
<u>Rainbow trout:</u>	<u>(20,000 fish)(2 lb/fish)</u>	<u>= 18.1 metric ton</u>
Total fish:		1391.0 metric ton

A K Pool production of 1,391 metric tons per year would give total releases of 6,955 Kg of P and 66,768 Kg of N per year, or 0.22 g/sec of P and 2.12 g/sec of N. When this effluent is mixed with the minimum expected Columbia River volumetric flow of 1,086 m³/sec, the resulting discharge would give concentration increases of 0.0002 mg/L of P and 0.0020 mg/L of N. These values are 2-3 orders of magnitude less than the target concentrations for avoiding excessive plant growth, and thus the impact would be negligible.

With regard to the rearing of up to 500,000 warm-water species, this K Pool program would only be feasible if operated in essentially a water recirculation mode so that warm water can be conserved and heating expenses minimized. Options for neutralizing dissolved contaminants in a recirculation mode would be investigated. The most economically and environmentally feasible option would be employed. There would be little, if any, water released to the environment, and no buildup of dissolved contaminants would be expected in this water. Suspended solids, such as fish food and waste, would be removed by either filtration or settling.

The potential of non-indigenous species reared under a K Pool commercial aquaculture program inadvertently escaping to the Columbia River would be highly unlikely because of pool design, the pool outlet piping, and process sewer and outfall design. The NMFS has determined that as long as provisions of the "Biological Opinion for 1995 to 1998 Hatchery Operations in the Columbia River Basin," are followed the K Pool operations will not jeopardize the continued existence of Snake river salmon stocks listed as either threatened or endangered under the Endangered species Act.

5.3 Air Impacts

Air discharges from the proposed action would be normal evaporation of water from the surface of the pools and exhaust from services vehicles, hatchery trucks, and workers cars.

5.4 Land Impacts

Potential upgrades or modifications to the existing facilities from the proposed action would have minor impacts to the soil because all activities would be temporary and occur on highly disturbed grounds. There would be no surface excavations required. In addition, all waste would be disposed of in appropriate disposal sites in accordance with applicable regulatory requirements.

5.5 Surface and Groundwater Impacts

During fish rearing periods, up to 34 million liters (34,000 cubic feet) which is 9 million gallons (12,300 cubic feet) of water a day may be pumped from the Columbia River, pass through the fish rearing ponds and be released back to the river. This is a small percentage of the average daily river flow of 570 million cubic meters (20.14 billion cubic feet). Released water could convey small amounts of soluble solids to the Columbia River in the form of fish food or waste products. This probably would occur both during the rearing period and during the release of the juvenile fish to the river after the required rearing period. Such releases would conform to the NPDES suspended solids limits. The water temperature limit of 24 degrees Celsius (75 degrees Fahrenheit) would be met.

5.6 Safety Impacts

Public health and safety would not be affected because the area is closed to the general public. Fencing would further keep unauthorized persons and wildlife away from the pools. Standard safety practices would be employed to protect members of the workforce. This is a non-radiation area with no history of worker contamination. Workers monitored in this area have not received any measurable radiation exposure above natural background levels.

5.7 Socioeconomic Impacts

In the Benton-Franklin County community of over 165,000 persons with a workforce in excess of 10,000 at the Hanford Site, the socioeconomic impacts of this proposed action would be expected to be small. With projected staffing of up to 70 people within five years, members of the community would benefit from the jobs and revenue that the project would generate. Some increased trade from people coming to fish for salmon in the Columbia River could occur.

5.8 Transportation Impacts

At present, during morning rush time (6:00am to 7:00am) Route 4S carries about 1690 vehicles and route 2S carries 163 vehicles. Route 11A through the Yakima barricade carries about 500 morning rush hour vehicles. Evening traffic is approximately the same. Workers traveling to and from the fish raising project would add 10 or 15 vehicles to the rush time traffic. During the rest of the day these highways are relatively free of traffic. The transport of fish food and fresh fish would generate about two truck trips per day. Hanford Site highways are capable of carrying heavy loads and high volumes of traffic and thus would be unaffected by the few extra truck loads hauling fish and fish food.

5.9 Environmental Justice Impacts

Evaluation of environmental justice impacts, as required by Executive Order 12898, must consider a range of factors that may place disproportionate negative environmental impacts on minority and low income populations. Minority and low income populations are present near the Hanford Site (Neitzel 1996). However, the proposed action considered in this Environmental Assessment (EA) would not cause disproportionate adverse health or socioeconomic impacts to these segments of the community.

5.10 Cumulative Impacts

Cumulative impacts from the proposed action appear to be minimal. No additional terrestrial habitat would be disturbed by the proposed action. No major change in the workforce or infrastructure is anticipated.

There are currently differing opinions among fish biologists and institutions responsible for managing salmon about the potential impact of hatchery salmon on the survival of wild salmon, and thus the salmon populations. The salmon species whose life cycle brings them farthest inland from the Pacific Ocean (i.e., requires them to successfully pass the most dams) and causes them to spend extended time being reared in fresh water are particularly at

risk. These two factors do not generally apply to the upriver bright fall chinook salmon that would be grown-out to smolt stage at the Hanford K Pools and released directly in the Hanford Reach of the Columbia River. This salmon species only has to traverse four Columbia River dams, which all have modern fish-passage facilities. The smolt would be several months old when migration to the Pacific Ocean begins.

The impact of fish rearing and release on salmon populations, either adverse or beneficial, is not yet established. Potential adverse genetic or predatory effects on wild fish or endangered species could have a cumulative impact. A discussion of genetic impacts occurs in this document under section 5.2, Impacts to Biological Resources and is not repeated here. IHOT policies on salmon genetic diversity and impacts of hatcheries on wild fish and salmon populations would be followed during K Pool fish rearing operations.

A possible cumulative impact which could be viewed as positive would be the long-term enhancement and supplementation of game fish populations in the Columbia River and other regional waters.

5.11 Impacts of Alternative Actions:

Impacts of alternative actions to the natural environment would be essentially the same as the proposed action. Under the No Action Alternative, no long-term use permit or lease agreement for fish rearing at the K Pools would be granted. The cost of decommissioning the pools would not be avoided. Any anticipated benefits for the fisheries resources would not be realized.

Alternative actions for implementing the proposed fish rearing project would be more costly and require a longer time to implement than the proposed action. In addition, the alternative of building new facilities could impact an area of undisturbed shrub-steppe habitat and also contact as yet undiscovered cultural artifacts.

6.0 Permits and Regulatory Requirements

The proposed project would comply with the following standards:

- Washington Administrative Code 173-216 *State Waste Discharge Permit Program*.
- Permits identified as possibly needed for the proposed action are modification of the current NPDES permit for the water discharge to the river, a water withdrawal permit for non-consumptive use, and a hydraulic permit when fish screens are repaired or upgraded.
- An Upland Fin-fish Hatching and Rearing Water Discharge NPDES General Permit would be obtained as needed.

7.0 Organizations Consulted

The Nez Perce Tribe, the Confederated Tribes of the Umatilla Indian Reservation, the Wanapum, the Yakama Indian Nation, the United States Fish & Wildlife Service, the National Marine Fisheries Service, The Northwest Power Planning Council, the Bonneville Power Association, and the State of Washington have received this EA in draft form for review. The National Park Service also received this EA in draft form for review because the action is in the Hanford Reach of the Columbia River under Public Law 100-605.

Comments were received from the Yakama Indian Nation, the National Marine Fisheries Service, the State of Washington, and the Bonneville Power Association. These comments have been considered in preparing the final EA.

8.0 References

- Ackefors, H. and Enell, M., 1994, *The Release of Nutrients and Organic Matter from Aquaculture Systems in Nordic Countries*, Journal of Applied Ichthyology, Volume 10(4), Special Issue: Proceedings Workshop on Fish Farm Effluents, pp. 225-241.
- Blodgett, J., 1994, *K-Basin Fall Chinook Acclimation Project - 1994 Report*, Yakama Indian Nation Fisheries Resource Management Program, Toppenish, WA.
- BPA, 1995, DOE/BP-60629, July 1995, *Policies and Procedures from Columbia Basin Anadromous Salmonid Hatcheries*, Annual report, 1994, Prepared by Integrated Hatcheries Operations Team for Bonneville Power Administration, Portland Oregon.
- Dauble, D.D. and D.G. Watson, 1990, *Spawning and Abundance of Fall Chinook Salmon (Oncorhynchus Tshawytscha) in the Hanford Reach of the Columbia River, 1948-1988*. Pacific Northwest Laboratory, Richland, WA.
- Endangered Species Act of 1973*, 16 USC 1531-1544 et seq.
- Ecology, EPA, and DOE, 1994, *Hanford Federal Facility Agreement and Consent Order*, as amended, Washington State Department of Ecology, U.S. Environmental Protection Agency, and U.S. Department of Energy, Olympia, WA.
- DOE/EIS-0169F, February 1996, *Yakima Fisheries Project*, Final Environmental Impact Statement, Bonneville Power Administration, Portland, Oregon.
- DOE/EIS-0245F, February 1996, *Management of Spent Nuclear fuel from the K Basins at the Hanford Site, Richland, Washington*, U.S. Department of Energy, Richland, WA
- DOE/RL-96-77, August 1996, *Programmatic Agreement among the U.S. Department of Energy, Richland Operations Office, the Advisory Council on Historic Preservation, and the Washington State Historic Preservation Office for the Maintenance, Deactivation, Alteration, and Demolition of the Built Environment on the Hanford Site, Washington*, U.S. Department of Energy, Richland, WA
- Neitzel, D. A. and T. J. Frest, 1993, *Survey of Columbia River Basin Streams For Columbia Pebblesnail Fluminicola columbiana And Shortface Lanx Fisherola nuttalli*, PNL-8229, Rev. 1, Pacific Northwest Laboratory, Richland, WA.
- Neitzel, D. A., 1996, *Hanford Site National Environmental Policy Act (NEPA) Characterization*, PNL-6415, Rev. 8, Pacific Northwest Laboratory, Richland, WA.
- National Marine Fisheries Service, *Biological Opinion for 1995 to 1998 Hatchery Operations in the Columbia River Basins*, pp 58 - 59, signed April 5, 1995
- Norman, W. T. 1992, *Factors Controlling Variation of Naturally Spawning Fall Chinook Salmon in the Upper Columbia River*, Master's Thesis, University of Washington, Seattle, WA.
- NPPC, 1994, *1994 Columbia River Basin Fish and Wildlife Program*, Northwest Power Planning Council.

NRC, 1995, *Upstream - Salmon and Society in the Pacific Northwest*, National Research Council, National Academy Press, Washington, D.C.

WHC, 1994, *Columbia River Effluent Pipeline Survey*, WHC-SD-EN-TI-278, Rev.0, Golder Associates Inc., prepared for Westinghouse Hanford Company, Richland, WA.

Appendix A
Biological Resources Review for
Proposed K Pools Fish Rearing Project

**Battelle**

Pacific Northwest Laboratories
Battelle Boulevard
P. O. Box 999
Richland, Washington 99352
Telephone (509) 376-5345

April 24, 1995

Ms. Kathryn Moss
Westinghouse Hanford Company
P. O. Box 1970, MSIN X0-21
Richland, WA 99352

Dear Ms. Moss:

**BLANKET BIOLOGICAL REVIEW FOR PROJECTS REQUIRED FOR GENERAL MAINTENANCE
ACTIVITIES INSIDE THE 100 K BOUNDARY FENCE, 100 K Area, #95-100-037**

Project Description:

- Excavations, etc. required for routine maintenance and general repairs inside the of the 100 K Area boundary fence.

Survey Objectives:

- To identify plant and animal species protected under the Endangered Species Act (ESA), candidates for such protection, and species listed as threatened, endangered, candidate, sensitive, or monitor by the state of Washington, and species protected under the Migratory Bird Treaty Act.
- To evaluate the potential impacts of disturbance on priority habitats and protected plant and animal species identified in the survey.

Survey Methods:

- Pedestrian and ocular reconnaissance of the proposed site was conducted by G. Fortner, and T. Hanrahan on April 18, 1995.
- Priority habitats and species of concern are documented as such in the following: Washington Department of Wildlife (1993), U. S. Fish and Wildlife service (1994), U. S. Fish and Wildlife Service (1985), U. S. Fish and Wildlife Service (1992), and Washington Dept. of Wildlife (1994), Washington State Department of Natural Resources (1994),
- The Braun-Blanquet cover-abundance scale (Bonham 1989) was used to determine percent cover of dominant vegetation.

Survey Results and Conclusions:

- No plant and animal species protected under the ESA, candidates for such protection, or species listed by the Washington state government were observed in the vicinity of the proposed site,
- No flora were observed in the vicinity,
- No migratory bird species were observed nesting in the vicinity of the proposed site,

Kathryn Moss
95-100-037)
Page 2 of 3

- No adverse impacts to species or habitats of concern are expected to occur from proposed actions within the designated area.
- This survey pertains to all work requiring Biological Review within the boundary fence of the 100 K area until April 1, 1996.

Sincerely,

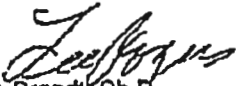

CA Brandt, Ph.D.
Project Manager
Ecological Compliance Assessment

CAB:glf

Kathryn Moss
95-100-037)
Page 3 of 3

REFERENCES

Bonham, Charles D. 1989. Measurements for Terrestrial Vegetation, published by John Wiley & Sons, Inc., pp. 27-128.

U. S. Department of Interior, U. S. Fish and Wildlife Service. 1994. Endangered and Threatened Wildlife and Plants, Animal Candidate Review for Listing as Endangered or Threatened Species, Proposed Rule, 50 CFR 17. (November 15, 1994).

U. S. Department of Interior, U. S. Fish and Wildlife Service. 1985. Revised List of Migratory Birds: Final Rule. 50 FR 13708 (April 5, 1985).

U. S. Department of Interior, U. S. Fish and Wildlife Service. 1992. Endangered and Threatened Wildlife and Plants. 50 CFR 17.11 and 17.12. (August 29, 1992).

Washington Department of Wildlife. 1993. Priority Habitats and Species. pp. 22.

Washington Department of Wildlife. 1994. Species of Special Concern in Washington. (April 1994).



Pacific Northwest Laboratories
Battelle Boulevard
P.O. Box 999
Richland, Washington 99352
Telephone (509) 376-5345

May 17, 1996

Mr. Brewster Strobe
Westinghouse Hanford Company
P. O. Box 1970, MSIN H6-26
Richland, WA 99352

Dear Mr. Strobe:

BIOLOGICAL REVIEW OF THE OUTFALL FOR FISH FLUSHING, 100-K Area, #96-100-032

Project Description:

- Emplacement of an above-ground, flexible, plastic pipeline through which fish will be flushed. The pipeline will extend approximately from 190-KE in a northeasterly direction to the 100-K perimeter fence. The pipeline will cross the perimeter fence and run along the outside of the perimeter fence directly to the Columbia River. This pipeline will be emplaced in the fall, 1996, and left in place for approximately one week to flush fish; then it shall be removed.

Survey Objectives:

- To determine the occurrence in the project area of plant and animal species protected under the Endangered Species Act (ESA), candidates for such protection, and species listed as threatened, endangered, candidate, sensitive, or monitor by the state of Washington, and species protected under the Migratory Bird Treaty Act.
- To evaluate the potential impacts of disturbance on priority habitats and protected plant and animal species identified in the survey.

Survey Methods:

- Pedestrian and ocular reconnaissance of the portion of the pipeline located inside the 100-K perimeter fence was conducted by M. Sackschewsky, T. Hanrahan, and J. Becker on April 25, 1996, and by C. Brandt, J. Becker, and T. Hanrahan on May, 2, 1996. Pedestrian and ocular reconnaissance of the portion of the pipeline located outside the 100-K perimeter fence was conducted by G. Fortner, R. Zufelt, and G. Lougheed on May 17, 1996. The Braun-Blanquet cover-abundance scale (Bonham 1989) was used to determine percent cover of dominant vegetation.
- Priority habitats and species of concern are documented as such in the following: Washington Department of Fish and Wildlife (1993, 1994), U. S. Fish and Wildlife Service (1985, 1994a & b) and Washington State Department of Natural Resources (1994).

Mr. B. Strope
96-100-032
Page 2 of 4

Survey Results:

Area within the Perimeter Fence

- The area within the 100-K boundary fence is a highly disturbed industrial site whose substrate consists largely of pavement and packed gravel. Thus flora is depauperate within the 100-K boundary fence.
- Western kingbirds were observed nesting on the exterior of the 190 KE Substation.

Area outside the Perimeter Fence

- Vegetation changes along this portion of the proposed pipeline from species characteristic of upland disturbed areas to those characteristic of the riparian corridor of the Columbia River.
- Columbia River mugwort (*Artemisia lindleyana* - state monitor 3) was observed northeast of an existing buried pipeline that runs out of the north end of 116-KE to the north-northwest toward the Columbia River (see enclosed map).
- No migratory birds were observed nesting in the vicinity of the proposed pipeline.

Considerations and Recommendations:

- The field survey for this biological review was conducted too early to observe Columbia yellowcress (*Rorippa columblae* - former federal candidate and state endangered), as the Columbia River flows were still too high. The south bank of the Columbia River between the northwest corner of 100-K and the northwest corner of 100-N has not been surveyed for Columbia yellowcress prior to this survey (Pacific Northwest National Laboratory 1996a and 1996b). Thus it is uncertain whether this species occurs on the site of the proposed pipeline. In order to assess the occurrence of this species, a subsequent biological survey will have to be conducted after the Columbia River flows have receded for one to two weeks. After this period of time, this species will likely have resumed growth and will be observable to field personnel. A subsequent biological review letter will be provided summarizing the results of this subsequent biological survey.
- In order to avoid adverse impacts to Columbia River mugwort, we recommend that the pipeline be emplaced on the upstream side of the existing buried pipeline that runs out of the north end of 116-KE to the north-northwest toward the Columbia River (see enclosed map).
- Should motor vehicles and heavy equipment need to be used to emplace the pipe outside the 100-K perimeter fence, we recommend that personnel of the Ecological Compliance Assessment Project (ECAP) at Pacific Northwest National Laboratory be contacted (376-7610). ECAP personnel will accompany project engineers in the field and flag the route/ areas to which vehicle traffic and heavy equipment will be restricted. This will ensure minimal damage to riparian and upland vegetation and substrate.
- The Migratory Bird Treaty Act makes it illegal to take, capture, or kill, as applicable, any migratory bird, or any part, nest, or egg of any such birds, included in the terms of the conventions. The nesting season for western kingbirds will terminate at the end of July, 1996. Thus running the pipeline from the 190 KE Substation in the fall, 1996, will not adversely affect nesting western kingbirds and thus will not be subject to compliance with the Migratory Bird Treaty Act.

Mr. B. Strobe
96-100-032
Page 3 of 4

Conclusions:

- This biological review is effective until April 1, 1997. Should pipeline emplacement commence after this date, a new ecological review will be required for this project.
- No other plant and animal species protected under the ESA, candidates for such protection, or species listed by the Washington state government were observed in the vicinity of the location proposed for the pipeline.
- If the above recommendations are followed, no adverse impacts to species or habitats of concern are expected to occur from the proposed action.

Sincerely,

J. M. Becker for C.A. Brandt

CA Brandt, Ph.D.
Project Manager
Ecological Compliance Assessment
CAB:jmb

Mr. B. Strobe
96-100-032
Page 4 of 4

REFERENCES

Bonham, Charles D. 1989. Measurements for Terrestrial Vegetation, published by John Wiley & Sons, Inc. pp. 127-128.

Pacific Northwest National Laboratory. 1996a. Ecosystem Monitoring Project Database.

Pacific Northwest National Laboratory. 1996b. Ecological Compliance Assessment Project Database.

U. S. Fish and Wildlife Service. 1985. Revised List of Migratory Birds; Final Rule. 50 FR 13708 (April 5, 1985).

U. S. Department of Interior, U. S. Fish and Wildlife Service. 1992a. Endangered and Threatened Wildlife and Plants. 50 CFR 17.11 and 17.12. (August 29, 1992).

U. S. Fish and Wildlife Service. 1994b. Endangered and Threatened Wildlife and Plants, Animal Candidate Review for Listing as Endangered or Threatened Species, Proposed Rule, 50 CFR 17. (November 15, 1994).

Washington Department of Fish and Wildlife. 1993. Priority Habitats and Species. pp. 22.

Washington Department of Fish and Wildlife. 1994. Species of Special Concern in Washington. (April 1994).

Washington Department of Natural Resources. 1994. Endangered, Threatened & Sensitive Vascular Plants of Washington. (January 1994).



Hanford Site

100 K Area

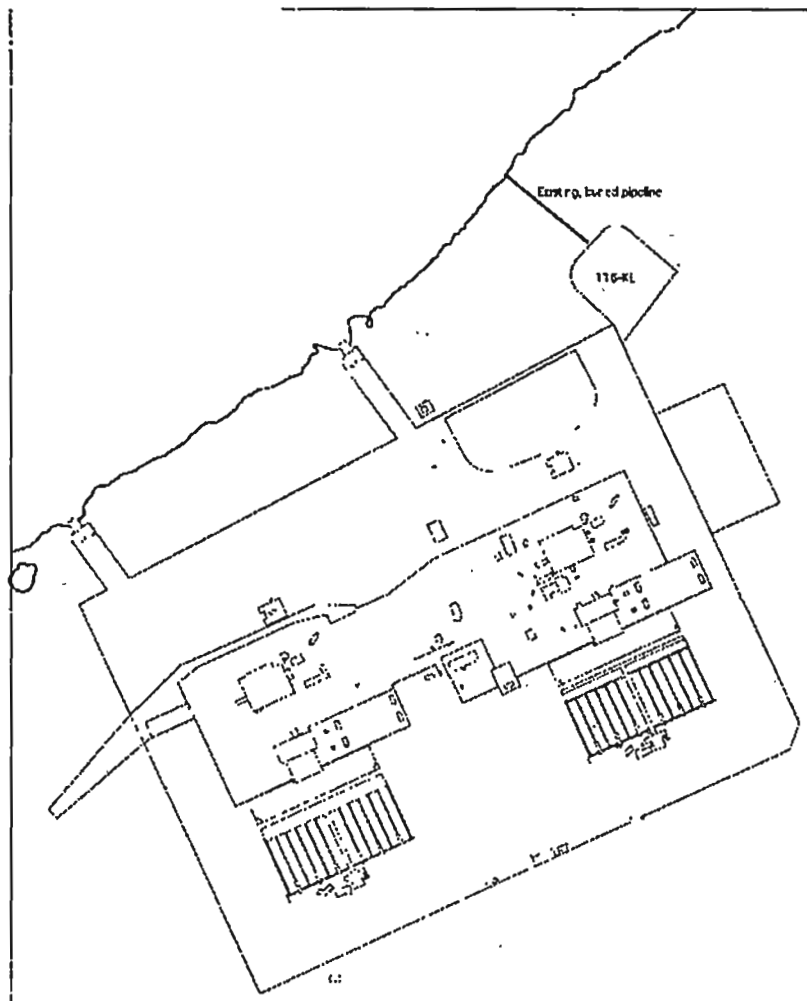

- Existing Pipeline
- Roads
- - - Fences
- ▭ Buildings

PL-1, Facility Group, 1/1/76
Hanford NE 0120 012, 150'

Appendix B
Cultural Resources Review for Proposed
K Pools Fish Rearing Project

**Battelle**

Pacific Northwest Laboratories
Battelle Boulevard
P.O. Box 999
Richland, Washington 99352
Telephone (509)

376-8107

September 5, 1995

Historic Properties

D. I. Herborn
Westinghouse Hanford Company
P. O. Box 1970/H6-06
Richland, WA 99352

Dear Mr. Herborn:

CULTURAL RESOURCES REVIEW OF THE YAKAMA INDIAN NATION FISH REARING IN HANFORD K POOLS. HCRC #95-100-058.

In response to your request received September 1, 1995, staff of the Hanford Cultural Resources Laboratory (HCRL) conducted a cultural resources review of the subject project, located in the 100 KE and 100 KW Area of the Hanford Site. According to the information that you supplied, the project entails the lease of 100 K Area facilities to the Yakama Indian Nation for implementation of a fish rearing program. Facilities leased may include the 183.1 KE and KW Head Houses, the 183 Chlorine Vaults, and the 183.2 KE and KW Flocculation and Subsidence Basins. No ground disturbing activities are anticipated with this proposed project. About one week per year, a temporary above-ground PVC line will be installed between the 100 K Pools and the Columbia River for the transport and release of salmon smolts. Anticipated minor modifications to buildings would be internal (e. g. installation of tanks).

Our literature and records review shows that the 183.1 KE and KW Head Houses, the 183 Chlorine Vaults, and the 183.2 KE and KW Flocculation and Subsidence Basins, constructed in 1955, have not been evaluated for eligibility for the National Register of Historic Places (Register). However, the 105 KE Reactor and the 190 KE Building have been determined eligible to the Register (letter dated August 31, 1995, from the State Historic Preservation Officer to DOE-Richland Operations Office) and it is likely that the project facilities would be eligible as contributing to the historic character of the KE and KW complex.

If the facilities are found to be eligible for inclusion on the Register in the future, the current project will have no effect on any characteristics of the facilities that would make them eligible. The modifications will be minor and will not affect the structural integrity or exterior appearance of the facilities. Historic Property Inventory Forms are being completed for the structures to be used by this project. Additional documentation of the proposed project by HCRL staff is not required.

The proposed pipeline passes through the boundary of archaeological site 45BN423, which has been determined to be eligible to the Register (letter dated May 17, 1994, from R. G. Whitlam of the Office of Archaeology and Historic Preservation and C. Pasternak, DOE-Richland Operations Office). To avoid adversely affecting this site it is recommended that the pipeline be routed so as to avoid the site, or that the pipeline be constructed and dismantled by hand so as to avoid damaging the site by vehicles.



September 5, 1995
D. I. Herborn
Page 2.

The HCRL must be notified of any changes to project location or scope, especially if structural modifications, are anticipated. This is a Class IV and VI case, defined as a project which involves new construction in a disturbed, high-sensitivity area, and which involves demolition or remodeling of existing structures. Copies of this letter have been sent to Dee Lloyd, DOE, Richland Operations Office, as official documentation. If you have any questions, please call me at 376-8107. Please use the HCRC# above for any future correspondence concerning this project.

Very truly yours,

N. A. Cadoret
Technical Specialist
Cultural Resources Project

Concurrence:

for P. R. Nickens, Project Manager
Cultural Resources Project

cc: D. Lloyd, RL (2)
L. L. Christl
File/LB

May 7, 1996

Potential Adverse Effect

D. I. Herborn
Westinghouse Hanford Company
P. O. Box 1970/H6-06
Richland, WA 99352

Dear Mr. Herborn:

CULTURAL RESOURCES REVIEW OF THE YAKAMA INDIAN NATION FISH REARING IN HANFORD K POOLS. ADDENDUM. HCRC #95-100-058.

A cultural resources review of the subject project was performed by staff of the Hanford Cultural Resources Laboratory (HCRL) (letter from N. A. Cadoret, HCRL, to D. I. Herborn, dated September 5, 1995). The project entailed in part the lease of 100 K Area facilities to the Yakama Indian Nation for implementation of a fish rearing program. Facilities leased may include the 183.1 KE and KW Head Houses, the 183 Chlorine Vaults, and the 183.2 KE and KW Flocculation and Subsidence Basins. This letter provides an additional finding regarding the lease of the building. The remainder of the findings as stated in the original review remain unchanged.

The 183.1 KE and KW Head Houses, the 183 Chlorine Vaults, and the 183.2 KE and KW Flocculation and Subsidence Basins, constructed in 1955, have not been evaluated for eligibility for the National Register of Historic Places (Register). However, the 105 KE Reactor and the 190 KE Building have been determined eligible to the Register (letter dated August 31, 1995, from the State Historic Preservation Officer to DOE- Richland Operations Office) and it is likely that the project facilities would be eligible as contributing to the historic character of the KE and KW complex.

If the facilities are found to be eligible for inclusion on the Register in the future, the current project will have no effect on any characteristics of the facilities that would make them eligible. The modifications will be minor and will not affect the structural integrity or exterior appearance of the facilities. However, the lease of the property would be considered an adverse effect if the facilities are found to be eligible for inclusion on the National Register.

Copies of this letter have been sent to Dee Lloyd, DOE, Richland Operations Office, as official documentation. If you have any questions, please call me at 376-8107. Please use the HCRC# above for any future correspondence concerning this project.

Very truly yours,

N. A. Cadoret
Technical Specialist
Cultural Resources Project

Concurrence:

P. R. Nickens, Project Manager
Cultural Resources Project

cc: D. Lloyd, RL (2)
L. L. Christl
File/LB

Appendix C

**Historic Property Inventory Form for Proposed
K Pools Fish Rearing Project**

HISTORIC PROPERTY INVENTORY FORM

Field No. 11-EE OAHF No. Date Recorded 03/12/96

Site Name Rhode River Township

County

Field Recorder MS Garber

Viewer's Name Department of Energy, Rhode Operations Office

Address P.O. Box 530

City/Township Code Rhode, WA 99352

State

Survey/Inventory

National Register

State Register

Other Register

Designated Eligible

View of Front Elevation

Diagonal Not Eligible

Other (GRAB, BAR, NEU)

Local Designation

Characterization District

State Building

Structure

Object

Characterization District Status

NR SR LTR INTV

Non-Contributing

Contributing

District/Thematic Association Name

DESCRIPTION SECTION

Material & Construction/Structural Type

Building Type

Roof Type

Gable

Other

Roof

Roof System

Shed

Other

Structural System

Reinforced Concrete

Other (specify)

None

Particular

Roof System

Wood Shingle

Other

Roof System

Shed

Other

Foundation

Log

Other

Foundation

Block

Other

Foundation

Other

Foundation

Other

Foundation

Other

Foundation

Other

Foundation

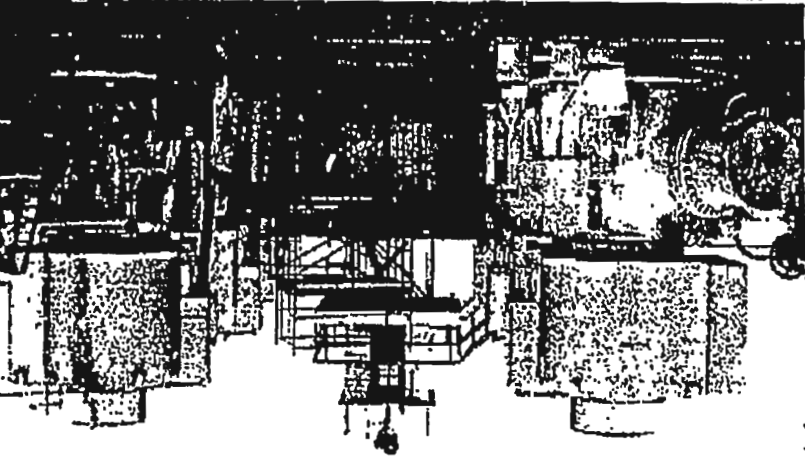

LOCATION SECTION Office of Archaeology and Historic Preservation 111 21st Avenue Southwest, P.O. Box 48343 98504-4843 (206) 753-4011

Address 181-KB/100-KB Aves./Harland Site

City/County/Zip Code Richland, Washington County/99352

Twp. 14N Range 26E Section 12

Tax No./Parcel No. M H Section

UTM Reference Zone 11

Photographic Map

Supplemental Maps

Photography Neg. No. 96030041-100

View of Front Elevation

Date March 1996

Roof Type

Material & Construction/Structural Type

Building Type

District/Thematic Association Name

DESCRIPTION SECTION

Characterization District

State Building

Structure

Object

Characterization District Status

NR SR LTR INTV

Non-Contributing

Contributing

District/Thematic Association Name

DESCRIPTION SECTION

Material & Construction/Structural Type

Building Type

Roof Type

Gable

Other

Foundation

Log

Other

Foundation

Block

Other

Foundation

Changes to plan Changes to elevation Changes to original siding Changes to interior

Dimensions of Physical Appearance (include details depicted in plan) Material Kilgim Moderate Reticulate

Other (specify) Changes to plan Changes to elevation Changes to original siding Changes to interior

Other (specify) Changes to plan Changes to elevation Changes to original siding Changes to interior

Other (specify) Changes to plan Changes to elevation Changes to original siding Changes to interior

High Style/Focus (check one or more of the following) Spanish Colonial Revival/Tudor Revival

High Style/Focus (check one or more of the following) Spanish Colonial Revival/Tudor Revival

High Style/Focus (check one or more of the following) Spanish Colonial Revival/Tudor Revival

High Style/Focus (check one or more of the following) Spanish Colonial Revival/Tudor Revival

High Style/Focus (check one or more of the following) Spanish Colonial Revival/Tudor Revival

NARRATIVE SECTION

Study Unit Themes (check one or more of the following)

- Agricultural
- Architecture/Landscape Architecture
- Arts
- Commerce
- Communications
- Community Planning/Development

- Construction
- Education
- Environmental/Recreation
- Ethnic Heritage (Specify)
- Health/Medicine
- Manufacturing/Industry
- Military

- Political/Government/Law
- Religion
- Science & Engineering
- Social Movement/Organizations
- Transportation
- Other (Specify) Cold War
- Study Unit Sub-Theme(s) (Specify) Reactor Operations/
Water Treatment

Statement of Significance: _____
Date of Construction: 1954-55

Architect/Engineer/Builder: General Electric Hanford Company/U.S. Atomic
Energy Commission

- In the opinion of the surveyor, this property appears to meet the criteria of the National Register of Historic Places
- In the opinion of the surveyor, this property is located in a potential historic district (National and/or local).

The 181-KE River Pump House was constructed during 1954-55 to perform the first step in the indirect water treatment process for the Hanford Site's KE Reactor. The 105-KE Reactor began operations in April 1955, producing plutonium for the U.S. Cold War effort. The 181-KE facility is not a "house" at all (see Physical Description), but is a series of pumps and motor controls placed on a concrete pad. The facility functioned to withdraw water from the Columbia River to be used as coolant for KE Reactor operations, as coolant for the spent fuel basin located inside the 105-KE Reactor Building, and for all other process, service and auxiliary needs of the 100-KE Area. After withdrawal from the river by the 181-KE structure's large pumps, the water was piped to other facilities to be filtered and settled. Then the majority of the water was treated with chemical additions, before being sent through the reactor's process tubes or circulated through the spent fuel basin. Smaller portions of the water were separated from the stream and routed to 100-KE Area buildings to supply sanitary, fire protection, and other needs.

During 1960-61, in a series of upgrades known as the Hanford Site's "Reactor Plant Modifications for Increased Production," six additional pumps were installed in the 181-KE facility, and the capacity of the six existing pumps was increased with the implementation of new impellers. However, the role of the 181-KE facility remained the same. It continued in this same role until the shutdown of the KE Reactor in January 1971. After the reactor closed however, irradiated spent fuel continued to be stored in the 105-KE Reactor Building. Such fuel storage continues to the present day. Likewise, sanitary and fire protection water supplies continue to be needed in the 100-KE Area, and the 181-KE facility acts to supply those needs. In 1993, a cooperative project was initiated between the Department of Energy, Richard Operations Office (DOE/RO), the Washington Department of Fisheries, and the Yakima Indian Nation, to treat salmon smelt in a portion of the 181-KE ponds. The 181-KE facility acts to supply water to this project.

The 181-KE facility has played a significant role in the production of plutonium for the Cold War in the 105-KE Reactor. Without the 181-KE facility, this reactor could not have operated. As such, the 181-KE facility contributed to the most primary and essential role of the Hanford Site, defense plutonium production. The facility's role as a supplier of water to other 100-KE Area buildings is useful but not distinctive. Therefore, DOE/RO concludes that the 181-KE facility is a contributing property to the Hanford Site Historic District under Criterion A. It is not eligible under Criterion B, because it is not associated with significant persons. It is not eligible under Criterion C, because its architecture and construction are not distinctive. Current and subsequent physical modifications to the 181-KE facility will not affect its historic significance, because such significance is derived from historic roles and events that have already occurred.

Description of Physical Appearance

The 181-KE River Pump House is not a "house" nor a building as such. As originally constructed in 1954-55, the 181-KE facility consisted of a concrete pad 90 feet long by 62 feet wide, containing six reinforced concrete pump wells that extended 64 and 1/2 feet from the pad (known as the "operating floor") to the base. The operating floor elevation was at 421 feet, because Columbia River minimum flood levels at that location and time were determined to be 417 feet. In each pump well was mounted a vertical, mixed flow pump. The 181-KE facility was located 700 feet west of the center line of the 105-KE Reactor, at the shore of the Columbia River. There was no superstructure on the facility, but a small motor control center (housing electrical connections, all valves, temperature instruments, and emergency stop buttons for the pump units) existed to the north of the pumping units.

Additionally, a 10-foot square guard house, constructed of steel with windows on all sides, was placed along an elevated sidewalk/walkway above the center of the facility. Large gates known as "grizzlies" were employed at the front (river-side, or northwest side) of the intake area, to prevent debris, fish, logs, and other material from entering the pumps and clogging them. Travelling fish screens and connecting piping completed the facility. All piping that was not self-draining was furnished and provided with electrical stop buttons to prevent freezing during periods of no flow. The 1,500-hp (three per well), 4,160-volt pump motors were located for weatherproofing. The pumps were operated from a control room located in the 105-KE structure nearby.

In 1960, in Hanford Site Project CGT-383, six additional pumps were installed in the 181-KE facility. The new pumps were submersible, and were installed in each pump bay through a penetration in the floor slab. Steel beams were employed to support areas of the slab. Additionally in this project, the new pumps were connected to the raw water intake header at the river, and motor-operated valves were installed at the discharge piping of each new pump. Also, new intakes were installed in the six original pumps, and a portable overhead hoist support was employed on the slab for pump maintenance.

After the 105-KE Reactor had shut down, parts of the stairs leading to the guard station at the 181-KE facility were removed. The guard house is now closed and inaccessible.

**Primary Production and
Energy Requirements**

**Energy Requirements for
Production of Fuel**

James A. A., Project Proposal, Revision C, General Electric Nuclear Power, 100X Area, HY-2000-10, York, Pa., G.E. Bedford Co., June 15, 1960

Mill, C. W. Inc., Completion Report, Project C-112, Volume C, 100X Area, HY-2000-10, York, Pa., G.E. Bedford Co., 1955

U.S. Atomic Energy Commission General Electric Bedford Co. (AEC/GE), "Energy of Fuel and Energy Requirements," GE-2000, York, Pa., Bedford, Pa., AEC/GE, 1964

100K UTM COORDINATES

	N	E
(NE CORNER)	5169934	301430
(NW CORNER)	5169415	300448
(SW CORNER)	5168697	300779
(SE CORNER 1)	5169147	301752
(SE CORNER 2)	5169196	301770

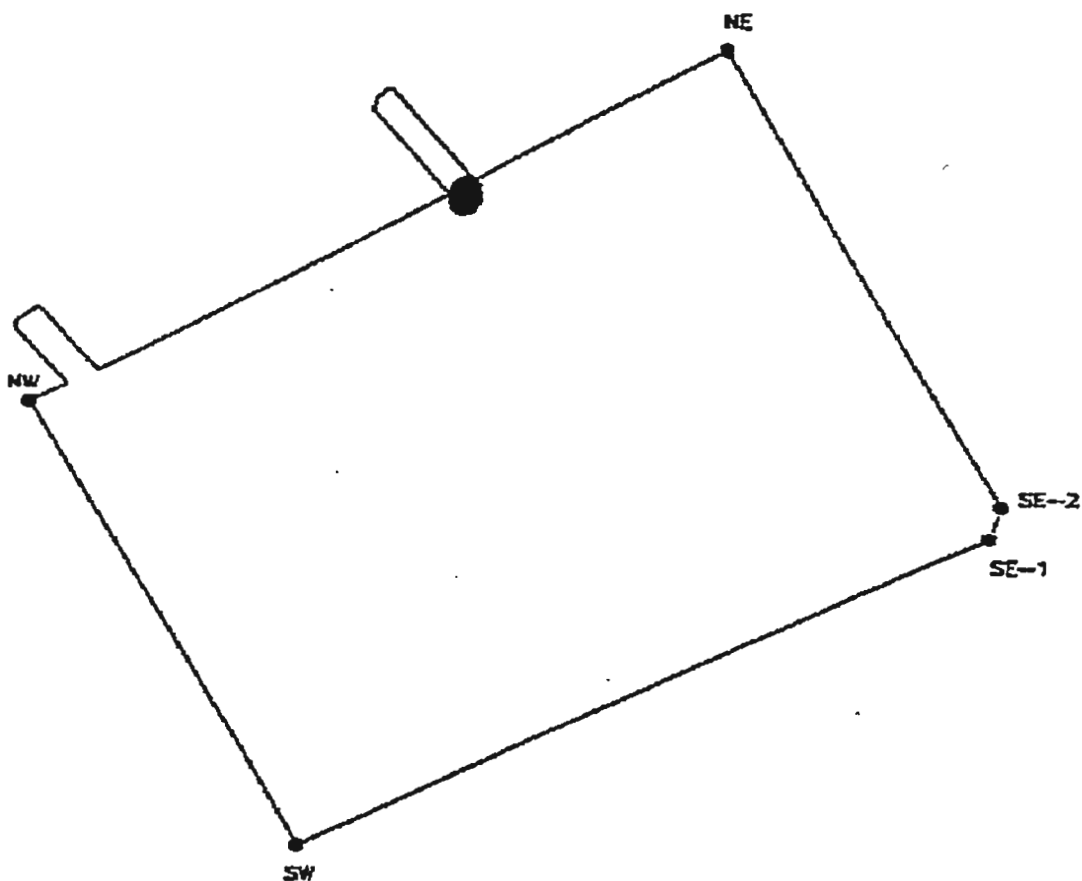

HISTORIC PROPERTY INVENTORY FORM
IDENTIFICATION SECTION

Field Site No. 183-KE OARF No. Date Recorded 03/12/96
 Site Name Historic Head House, Flooded on Basin, Filters Clearwells and Line House
 Common 183-KE Water System
 Field Recorder KG Lindsay, AL Mitchell, MS Gerber
 Owner's Name Department of Energy, Richland Operations Office
 Address P.O. Box 550
 City/State/Zip Code Richland, WA 99152
 State WA

- Survey/Inventory
- National Register
- State Register
- Determined Eligible
- Determined Not Eligible
- Other (HAER, HAER, NHL)
- Local Designation

PHOTOGRAPHY

Photography Neg. No. 5630047-2a
 (Roll No. & Frame No.)
 View of Southeast
 Date March 1996

Classification District Site Building Structure Object
 District Status NR IR LR INV
 Contributing Non-Contributing

District/Thematic Nomination Name _____

DESCRIPTION SECTION

Materials & Features/Structural Types

Building Type Industry

Plan Rectangular

Structural System Reinforced concrete

No. of Stories One (head house); N/A other parts

Cladding (Exterior Wall Surfaces)

- Log
- Horizontal Wood Siding
 - Board/Strip
 - Board
- Wood Shingle
- Board and Batten

- Vertical Board
- Asbestos/Asphalt
- Block
- Stone
- Stucco
- Terra Cotta
- Concrete/Concrete Block
- Vinyl/Aluminum Siding
- Metal (specify) _____
- Other (specify) _____

(Include detailed description in

Description of Physical Appearance)

	Intact	Slight	Moderate	Extensive
Changes to plan	<input type="checkbox"/>	<input type="checkbox"/>	<input checked="" type="checkbox"/>	<input type="checkbox"/>
Changes to windows	<input type="checkbox"/>	<input type="checkbox"/>	<input type="checkbox"/>	<input type="checkbox"/>
Changes to original cladding	<input checked="" type="checkbox"/>	<input type="checkbox"/>	<input type="checkbox"/>	<input type="checkbox"/>
Changes to interior	<input checked="" type="checkbox"/>	<input type="checkbox"/>	<input type="checkbox"/>	<input type="checkbox"/>
Other (specify) _____	<input type="checkbox"/>	<input type="checkbox"/>	<input type="checkbox"/>	<input type="checkbox"/>

- Roof Type
 - Gable
 - Flat
 - Monitor
 - Gambrel
 - Shed
- Roof Material
 - Wood Shingle
 - Wood Shakes
 - Composition
 - Slate
 - Tar/Build-Up
 - Tile
 - Metal (specify) _____
 - Other (specify) Asbestos Concrete Board coated with asphalt/astyle
- Other (specify) _____
- Not Visible

- Foundation
 - Log
 - Post & Pile
 - Stone
 - Brick
 - Not visible
- Concrete
 - Block
 - Footed
 - Other (specify) _____

State of Washington, Department of Community Development
 Office of Archaeology and Historic Preservation
 111 21st Avenue Southwest, Post Office Box 48343
 Olympia, Washington 98504-8343 (206) 753-4011

LOCATION SECTION

Address 183-KE/100-KE Area/Hankford Site
 City/County/Zip Code Richland, WA/Penton County 99302
 Twp. 13N Range 20E Section 5 4 Section NW 4 1/2 Section _____
 Tax No./Parcel No. _____ Abnaga _____
 Quarter(s) or map name _____
 UTM Reference Zone 11 Easting _____ Northing _____
 Post/Block/Lot _____
 Supplemental Maps _____

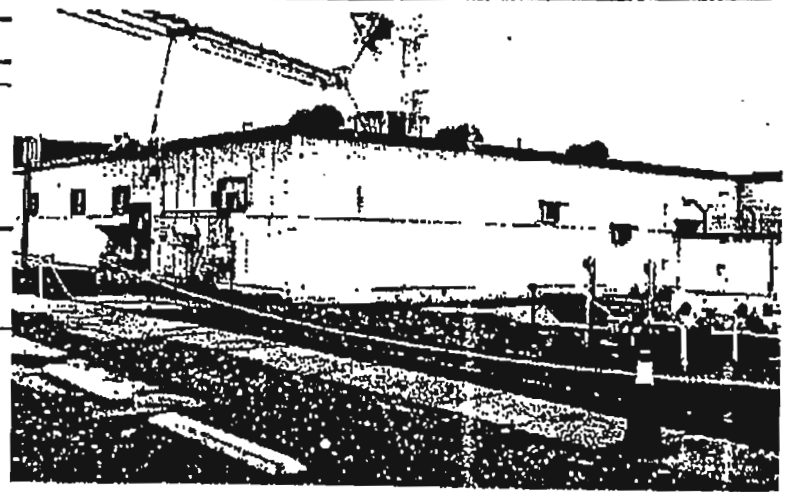

(Use Styles/Forms (check one or more of the following))

- Greek Revival
- Gothic Revival
- Italianate
- Second Empire
- Romanesque Revival
- Stick Style
- Queen Anne
- Shingle Style
- Colonial Revival
- Arts and Crafts/Neoclassical
- Chicago/Commercial Style
- American Four-square
- Mission Revival
- Vernacular Urban Type
 - Gable front
 - Gable front and wing
 - Side gable
- Spanish Colonial Revival/Mediterranean
- Tudor Revival
- Craftsman/Arts & Crafts
- Bungalow
- Prairie Style
- Art Deco/Art Moderne
- Rustic Style
- International Style
- Northwest Style
- Commercial Vernacular
- Residential Vernacular (see below)
- Other (specify) Industrial Vernacular

Description of Physical Appearance (continued)

The 183-4 clearwells are located north of the 183-2 basins. They are two, symmetrical, reinforced concrete reservoirs, covered by precast concrete panel roofs covered by asphalt and gravel bulk-up roofing. Each is 159 feet by 392 feet by 24 feet deep, and holds 9 million gallons of filtered water. The two reservoirs are 24 feet apart, and separated by a tunnel that runs between the 183-KE Head House and the 192-KE Pump House, but may be converted through two sluice gate valves located in the 190-KE Building. Two corrugated metal chemical feed buildings (known in the early years as "line houses") are located at the southeast and southwest corners of the 183-4 clearwells basins. These buildings are L-shaped, 28 feet by 38 feet, with flat roofs on two levels. (Sometimes, in recent years, these buildings have been known as the 183.5 and 183.6 facilities. These numbers were not associated with the buildings at their inception.)

In 1960, in Project COI-583, the 183-KE facility was modified with new instrumentation, controls and calibration systems to accommodate increased water flow. The backwash facilities were modified to shorten the automatic backwash cycle time and the time for valving operations, and to permit the overlapping of backwash cycles. An acid-resistant enclosure was built over the flash mixing chambers, and provision was made for the addition of sulfuric acid to the water system without the use of flash mixers. These mixers were removed. After the 103 KE reactor shut down in 1971, the need for water flow was greatly reduced, and portions of the 183-KE facility were blanked off. In 1993, the eastern most basin in the west half began to be used for raising sodium metal, and its flow system was separated from other portions of the system.

Major Bibliographic References

Hanford Site drawing H-1-21824

Janos, A. A., "Project Proposal, Revision 2 - Increased Process Water Flow, 100-K Area," HW-64903 (Richland, WA: G.E. Hanford Co., June 15, 1960)

Main, C. T., Inc., "Completion Report: Project CA-312, Volume 0: 100-K Water Plant," HW 24904-103, Vol. 2 (Richland, WA: G.E. Hanford Co., 1955)

U.S. Atomic Energy Commission/General Electric, Hanford Co. (AEC/GE), "Status of Hanford Buildings and Facilities," HW 26134, Vol. 1 (Richland, WA: AEC/GE, 1964)

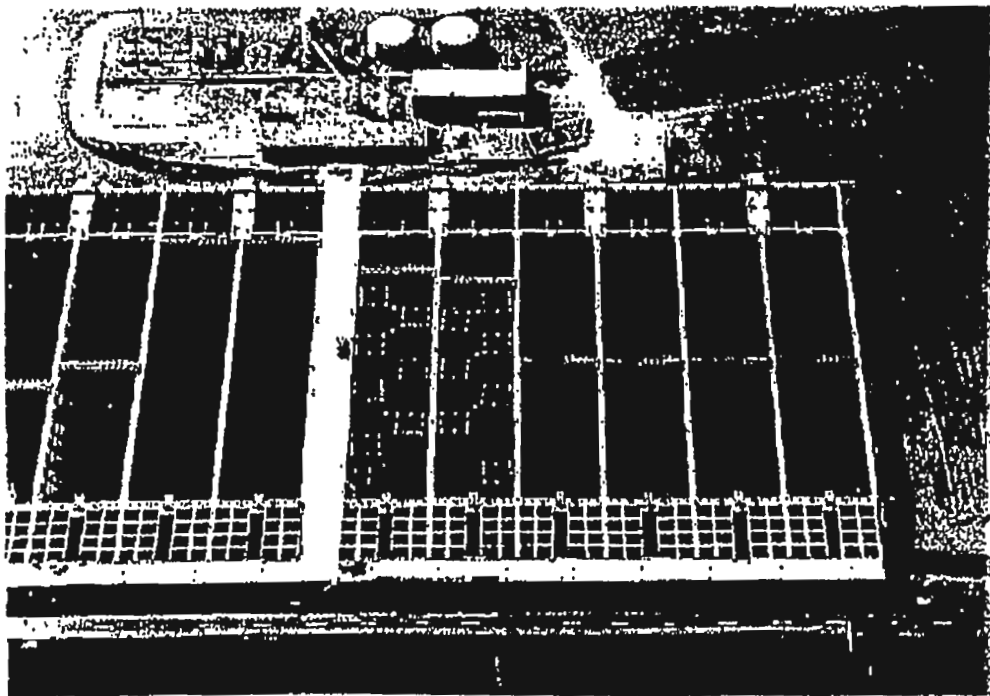

100K UTM COORDINATES

	N	E
(NE CORNER)	5169934	301430
(NW CORNER)	5169415	300448
(SW CORNER)	5168697	300779
(SE CORNER 1)	5169147	301752
(SE CORNER 2)	5169196	301770

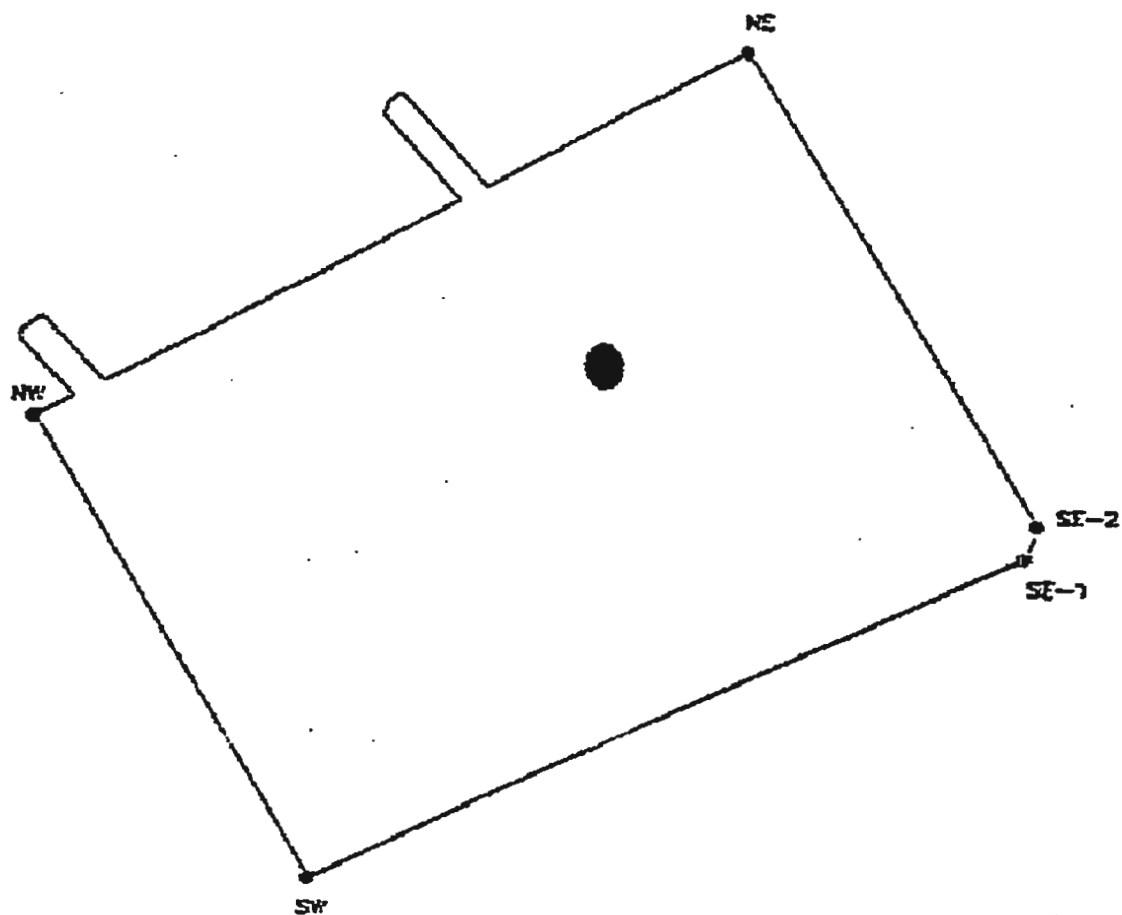

Appendix D

**Comments and DOE Response to Comments for
Proposed K Pools Fish Rearing Project**



UNITED STATES DEPARTMENT OF COMMERCE
National Oceanic and Atmospheric Administration
NATIONAL MARINE FISHERIES SERVICE
ENVIRONMENTAL & TECHNICAL SERVICES DIVISION
525 NE Oregon Street
PORTLAND, OREGON 97232-2737

AUG 20 1996

F/NWO3

Faul F.X. Dunigan, Jr.
NEPA Compliance Officer, DOE
Richland Operations Office
P.O. Box 550
Richland, Washington 99352

RE: Draft Environmental Assessment Announcement: K Pool Fish Rearing

Dear Mr. Dunigan:

Thank you for the opportunity to review the Environmental Assessment (EA) (DOE/EA-1111) for K Pool Fish Rearing at the Hanford Site, Richland, WA.

We are very familiar with the pilot project that has been operated for the past several years at that site which resulted in the release of as many as 700,000 up-river bright fall chinook salmon smolts (*Oncorhynchus tshawytscha*) into the Hanford Pool. This rearing program was included in the NMFS' "Biological Opinion for 1995 to 1998 Hatchery Operations in the Columbia River Basin", signed April 5, 1995. As long as the provisions set out on pages 58-59 of the Biological Opinion (copy enclosed) are followed, we have determined that this fish rearing program at the K Pool will not jeopardize the continued existence of Snake River salmon stocks listed as either threatened or endangered under the Endangered Species Act.

For other portions of the proposed project (aquaculture and warm-water fish rearing), NMFS is concerned about the selection of stocks of fish to be reared. We are also concerned about the potential for disease transmission via rearing effluent to other stocks of fish in the vicinity of the project outfall. The EA provides assurances that procedures approved by the Integrated Hatchery Operations Team (IHOT) will be followed in all aspects of this project. The IHOT management policies and fish health care standards directly address our concerns and, as long as they are followed, should minimize the potential for adverse effects.

196-NCT-011



2

If you have questions on our comments, please have your staff call R.Z. Smith in our Portland, Oregon office at 503/231-2009.

Sincerely,

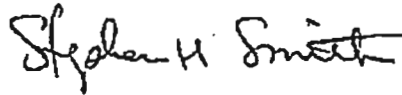

Stephen H. Smith
Chief, Hatchery/Harvest Branch

Enclosure

cc: Donna Wieting, NOAA

Enclosure to NMFS Comment Letter

stocks of fish; NMFS believes that it is highly unlikely that natural origin fish that originated from above LWG or Lyons Ferry Hatchery fish fall back below Ice Harbor Dam at the high rates reported. Consequently, it is likely that the fall back rate used in the ODFW model significantly underestimates Umatilla River chinook salmon fall back and that this is likely the major reason for the discrepancy between the two methods. For this reason, NMFS believes that its analysis is the more reliable one to use.

NMFS, Using recent information on returns to LWG, estimated the number of Snake River fall chinook salmon that could be expected to return in the future. This was calculated as follows:

Natural fish based on 1990-1994 average - 460
Lyons Ferry Hatchery (Snake River fish) - 255

TOTAL 725

NMFS estimates that stray fish passing LWG must remain at 36 ($725 \times .05$) or less to remain under the 5 percent standard described above. NMFS concludes, using its analysis above, that total strays above LWG are likely to remain below this number if 100 percent of Umatilla River fish released in the future are wire tagged. However, information presented in NMFS' analysis above needs to be updated to take into account new information as it becomes available.

c. Reprogramming Release Locations

Federal, state, and tribal hatchery managers (Co-managers) are developing plans to reprogram release locations of upriver bright fall chinook salmon (URBs) and coho salmon from the lower Columbia River to the middle and upper Columbia River. NMFS has assessed the Co-managers' proposed release of upriver bright fall chinook salmon in 1995 at Ringold Springs (approximately 3.4 million) and Hanford K Ponds (approximately 700,000). NMFS reviewed tag recovery information for past release of fall chinook salmon near these two sites (fax to Mike Delarm, NMFS from Tom Sheldrake, USFWS dated March 7, 1995). The USFWS in a review of this tag recovery information concluded that nearly all straying into the Snake River is attributable to fish released into the Columbia Basin below the confluence of the Snake River (primarily from the Umatilla River). Many of these fish had no unique water source or suitable flows to return to when they came back. In addition, Snake River water is mixed with Columbia River water in mainstream areas where these fish imprinted.

Fall chinook salmon acclimated at Ringold Springs will be released above the confluence of the Columbia and Snake Rivers into the free flowing section of the Columbia River. Based on USFWS coded wire tag recovery information for fall chinook released in this area, it is unlikely that fall chinook released from Ringold Springs will stray into the Snake River. The USFWS found that no tags from similar releases were recovered in the Snake River from three brood year releases (1983-1985) totaling 575,153 coded Wire tagged URBs into the

Enclosure to NMFS Comment Letter

Hanford Reach from Spring Creek Hatchery; In addition, Ringold Springs has a unique water supply (from springs) and the potential to collect adults upon their return. As a result, releases of fall chinook salmon from Ringold Springs is appropriate. However, all releases should have groups of fish tagged (minimum of 200,000) for monitoring and evaluation purposes.

There may be greater potential for straying into the Snake River from the proposed 700,000 fall chinook (all to be coded wire tagged) release from Hartford K Ponds as there is no unique water supply. (uses Columbia River) and no adult re-capture facilities for these fish to come back to. Fish will be released above the Snake and Columbia River confluence into the free flowing section of the Columbia River. Tag recovery information for past releases of fall chinook near the mouth of the Yakima River are used to estimate potential strays into the Snake River. Hartford K ponds are located on the Columbia River 20 to 25 miles upstream from the Yakima River so fish release there may not result in the same straying. Based on the USFWS tag recovery information, NMFS estimates that fish released from Hanford K Ponds could contribute a range of 0 to 9 fish (average of 2 fish) into the Snake River. This estimate was generated using the range of straying reported by the USFWS for release of URBs near the mouth of the Yakima River. Trapping at Lower Granite Dam would remove 90 percent of strays leaving from 0 to 1 (average .2) fish escaping above Lower Granite Dam. This number, in combination with the analysis presented above for the Umatilla program, should still be within the 5 percent straying standard. NMFS strongly recommends that releases from Hanford K Pond not be increased above 700,000 until tag recovery information becomes available to assist in future management decisions concerning this program. Until this information becomes available, all fish released should be coded wire tagged.

Reprogramming coho release locations outside of the Snake River Basin should not alter the results of the analysis of effects in this Opinion as those fish would continue to only interact with listed fish in migration corridor and ocean environments. However, reprogramming release locations into the Snake River Basin will require a reinitiation of consultation or a separate consultation. While reintroducing Coho salmon into the Snake River may be an appropriate long-term management goal, NMFS does not consider it appropriate in the Short term given the record low numbers of listed spring/summer chinook, salmon.

NMFS recommends that 100 percent of fall chinook salmon be wire tagged in instances where there is no evidence to show that straying into the Snake River Basin is minimal. In addition, NMFS recommends that existing fish production that is reprogrammed to new release sites be acclimated if possible and initiated as pilot programs that can be evaluated prior to initiating large Scale production releases. New hatcheries or production from existing hatcheries that exceeds the production ceiling recommended in the proposed recovery plan will require reinitiation of consultation.



Department of Energy
 Richland Operations Office
 P.O. Box 550
 Richland, Washington 99352

MAY 12 1996

96-OEA-239

Mr. Stephen H. Smith, Chief
 Hatchery/Harvest Branch
 National Marine Fisheries Service
 Environmental & Technical Services Division
 525 NE Oregon Street
 Portland, Oregon 97232-2737

Dear Mr. Smith:

RESPONSE TO COMMENTS ON DRAFT ENVIRONMENTAL ASSESSMENT OF K POOL FISH REARING

Thank you for your comments on the Draft Environmental Assessment (EA), (DOE/EA-1111). Your comments were helpful in preparing the final EA. Your comments or questions and our responses are included below.

Comment: "This rearing program was included in the NMFS' "Biological Opinion for 1995 to 1998 Hatcher Operations in the Columbia River Basin", signed April 5, 1995. As long as the provisions set out on pages 58-59 of the Biological Opinion (copy enclosed) are followed, we have determined that this fish rearing program at the K Pool will not jeopardize the continued existence of Snake River salmon stocks listed as either threatened or endangered under the Endangered Species Act."

Response: We agree with the comment. Appropriate wording has been placed in the EA committing to 100 percent tagging of salmon to be released under the program until tag recovery information becomes available to assist in future management decisions (Please see EA Section 2.0, Proposed Action, page 2-3, last paragraph). The biological opinion has been added to the list of references.

Comment: "NMFS is concerned about the selection of stocks of fish to be reared. We are also concerned about the potential for disease transmission via rearing effluent to other stocks of fish in the vicinity of the project outfall. The EA provides assurances that procedures approved by the Integrated Hatchery Operations Team (IHOT) will be followed in all aspects of this project."

Response: We agree and on page 2-3 of the EA have committed to using IHOT practices. Please see EA Section 2.0, Proposed Action, page 2-3. Also see EA Section 5.2, Impacts to Biological resources, page 5-3.

Mr. Smith
96-OEA-239

-2-

NOV 12 1996

If you have any questions please call Kevin Clarke, Office of External Affairs, on (509) 376-6332 or myself on (509) 376-6667.

Sincerely,

Paul F. X. Dunigan, Jr.
Paul F.X. Dunigan, Jr.
NEPA Compliance Officer

OEA:KVC



STATE OF WASHINGTON
DEPARTMENT OF ECOLOGY

P.O. Box 47600 • Olympia, Washington 98504-7600 • (206) 407-6000 • TDD Only (Hearing Impaired) (206) 407-6006

August 27, 1996

Mr. Paul F. X. Dunigan, Jr.
U.S. Dept. of Energy
Richland Operations Office
PO Box 550
Richland WA 99352

Dear Mr. Dunigan:

Thank you for the opportunity to comment on the environmental assessment for the leasing of the Hanford Site 105-KE and 105-KW filter plant pools (K Pools) for fish rearing by the Yakama Indian Nation or other parties. We reviewed the environmental assessment and have the following comments.

1. The proponent will need to apply for an upland fin-fish hatching and rearing NPDES General Permit.
2. Our Water Resources Program will consider this use of water non-consumptive as long as the by-pass reach is kept to an absolute minimum and there is no adverse effect to fish and wildlife habitat in the by-pass area.

If you have any questions on comment 1, please call Mr. David Giglio with our Water Quality Program at (509) 575-2490. For questions on comment 2, please call Ms. Carol Mortensen with our Water Resources Program at (509) 575-2597.

Sincerely,

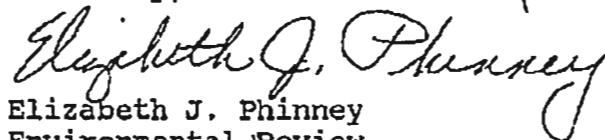
Elizabeth J. Phinney
Environmental Review

EJP:
96-5265

cc: David Giglio, CRO
Carol Mortensen, CRO
Debbie Smith, CRO



Department of Energy
Richland Operations Office
P.O. Box 550
Richland, Washington 99352

NOV 12 1996

96-OEA-240

Ms. Elizabeth J. Phinney
Environmental Review
State of Washington
Department of Ecology
P.O. Box 47600
Olympia, Washington 98504-7600

Dear Ms. Phinney:

COMMENTS ON ENVIRONMENTAL ASSESSMENT OF K POOL FISH REARING

Thank you for your comments on the Draft Environmental Assessment (EA), (DOE/EA-1111). Your comments were helpful in preparation of the final EA. Your comments or questions and our responses are included below.

Comment: "The proponent will need to apply for an upland fin-fish hatching and rearing NPDES General Permit."

Response: We agree. The requirement for the lessee to obtain an Upland Fin-fish Hatching and Rearing Water Discharge NPDES General Permit has been added to Section 6.0, Permits and Regulatory Requirements. We understand that this was a new program in 1995.

Comment: "Our Water Resources Program will consider this use of water non-consumptive as long as the by-pass reach is kept to an absolute minimum and there is no adverse effect to fish and wildlife habitat in the by-pass area."

Response: This concern is addressed in the EA in Section 5.2 Impacts to Biological Resources. In this section the impacts to Hanford Flora and Fauna are shown to be minimal and the maximum water to be withdrawn for pass-through use is shown to be about one millionth of the total water flowing in the river (30 billion cubic feet per day with about 34,000 cubic feet withdrawn at maximum usage).

If you have any questions please call Kevin Clarke, Office of External Affairs, on (509) 376-6332 or myself on (509) 376-6667.

Sincerely,

Paul F.X. Dunigan, Jr.
Paul F.X. Dunigan, Jr.
NEPA Compliance Officer

OEA:KVC



Department of Energy
Bonneville Power Administration
P.O. Box 3621
Portland, Oregon 97208-3621

September 3, 1996

Mr. Paul F. X. Dunigan, Jr.
NEPA Compliance Officer
Department of Energy
Richland Operations Office
P.O. Box 550
Richland, WA 99352

Dear Mr. Dunigan:

Bonneville Power Administration (BPA) staff have reviewed the Draft Environmental Assessment (EA) for the K Pool Fish Rearing proposal (DOE/EA-1111) and have the following comments to offer:

1. The EA is silent on whether Section 7 consultation under the Endangered Species Act has been completed with the National Marine Fisheries Service (NMFS). Given the proximity of the Hanford Reach to the confluence of the Snake River with the Columbia, it seems that it may be possible to adversely affect listed Snake River salmon stocks. If consultation has been completed, we suggest you state that it has. If not, you may want to consider contacting NMFS.
2. The three action alternatives in Section 3.0 appear to be alternatives considered but dismissed from further consideration. You may want to clarify this, and then state why they were dismissed.
3. Several reviewers who had previously not been involved with the project were quite concerned about the possibility of the fish and/or workers becoming contaminated with radioactive wastes due to the proximity of the K Pools to the contaminated K Reactors. We suggest that this be addressed in the EA.
4. In Chapter 2.0, under bullets 3 and 4, it states that rainbow trout and warm-water species would be raised for planting in "...appropriate lakes and ponds." However, in the paragraph immediately below the bullets, it is stated that these fish "...would not be released into the Columbia River and its tributaries." Also, at the bottom of page 5-4 it states that "White sturgeon and other fish being raised would not be released under this program." This is somewhat confusing -- can you clarify what will happen?

DPCE

Thank you for the opportunity to comment. BPA plans to start preparation of our EA on the Master Plan for rearing fall chinook, white sturgeon, and coho salmon in the K Pools this winter. We would appreciate receiving copies of any comments you receive on this EA for our consideration in preparing our EA. We will keep you informed of the progress on our EA and put you on our mailing list.

If you have any questions or need clarification of any of our comments, please contact me at (503) 230-5373.

Sincerely,



Nancy H. Weintraub
Team Lead, Fish and Wildlife NEPA



Department of Energy
Richland Operations Office
P.O. Box 550
Richland, Washington 99352

NOV 12 1995

96-OEA-238

Ms. Nancy Weintraub, Team Lead
Fish and Wildlife NEPA
Bonneville Power Administration
P.O. Box 3621
Portland, Oregon 97208-3621

Dear Ms. Weintraub:

COMMENTS ON ENVIRONMENTAL ASSESSMENT OF K POOL FISH REARING

Thank you for your comments on the Draft Environmental Assessment (EA), (DOE/EA-111). Your comments were helpful in preparing the final EA. Your comments or questions and our responses are included below.

Comment: "The EA is silent on whether Section 7 consultation under the Endangered Species Act has been completed with the National Marine Fisheries Service (NMFS). Given the proximity of the Hanford Reach to the confluence of the Snake River with the Columbia, it seems that it may be possible to adversely affect listed Snake River salmon stocks. If consultation has been completed, we suggest you state that it has. If not, you may want to consider contacting NMFS."

Response: DOE has consulted with the NMFS. Their letter has been added to Appendix D of the EA, in Section 8.0, references, National Marine Fisheries Service, *Biological Opinion for 1995 to 1998 Hatchery Operations in the Columbia River Basins*, pp 58 - 59, signed April 5, 1995.

Comment: "The three action alternatives in Section 3.0 appear to be alternatives considered but dismissed from further consideration. You may want to clarify this, and then state why they were dismissed."

Response: Section 3.0, Alternatives, lists the alternatives considered. We considered each alternative under a separate paragraph and our reasons for dismissal are given. Please see Sections 3.1, 3.2, 3.3, and 3.4 of the EA.

Comment: "Several reviewers who had previously not been involved with the project were quite concerned about the possibility of the fish and/or workers becoming contaminated with radioactive wastes due to the proximity of the K Pools to the contaminated K Reactors. We suggest that this be addressed in the EA."

Ms. Weintraub
96-OEA-238

-2-

DEC 12 1996

Response: We have examined the question of possible radioactive contamination. Text has been added to the background information in Section 1.0, Purpose and Need for Agency Action and to Section 5.5 Safety Impacts to explain the situation more thoroughly.

Comment: "In Chapter 2.0, under bullets 3 and 4, it states that rainbow trout and warm-water species would be raised for planting in "...appropriate lakes and ponds." However, in the paragraph immediately below the bullets, it is stated that these fish "...would not be released into the Columbia River and its tributaries." Also, at the bottom of page 5-4 it states that "White sturgeon and other fish being raised would not be released under this program." This is somewhat confusing--can you clarify what will happen?"

Response: Text has been modified in Section 2.0. page 2-1, last paragraph, to emphasize that only salmon would be released under this program. Warm water species and rainbow trout would be released into appropriate lakes and ponds but would not be released into the Columbia River or its tributaries. White sturgeon raised under this program will not be released into any waters.

If you have any questions please call Kevin Clarke, Office of External Affairs, on (509) 376-6332 or myself on (509) 376-6667.

Sincerely,

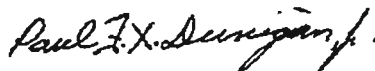

Paul F.X. Dunigan, Jr.
NEPA Compliance Officer

OEA:KVC



**Confederated Tribes and Bands
of the Yakama Indian Nation**

**Established by the
Treaty of June 9, 1855**

ROXANN R. SOCKZEHIGH
Environmental Engineer Intern
Confederated Tribes & Bands of the Yakama Nation
P.O. Box 151
Toppenish, WA 98948

August 30, 1996

Kevin Clarke
NEPA Document Manager
Department of Energy
P.O. Box 550
Richland, WA 99352

RE: DRAFT ENVIRONMENTAL ASSESSMENT (EA) ANNOUNCEMENT: K POOL FISH REARING

Greetings:

In regards to the Draft Environmental Assessment (EA) (DOE/EA-1111), concerning fish rearing in the 100 area, 1E; water purification filter plants (K pools). After reading through the document, certain questions arose as far as ecological factors are concerned, and also, a couple questions in regards to funding and consent to proceed with the pilot project and fish rearing.

Summary:

☐ These fish rearing activities would be: (1) business ventures by the YIN or other parties with public and private funds and (2) long-term enhancement and supplementation programs for game fish populations in the Columbia River Basin. ☐

Question: The business ventures that may include the YIN, which department would take part in the funding or would be the Yakama Nation? Is decision based off a liaison for the tribe be recognized?

2.0 Description of the Proposed Action

☐ The effluent from the pools would be released into the Hanford Reach of the Columbia River. The discharge would comply with conditions of any National Pollutant Discharge Elimination System (NPDES) permit that may become applicable. ☐

Question: Will (or can) the Biological Oxygen Demand (BOD) be monitored or screened before water is pumped into the system as well as the effluent?

5.2 Impacts to Biological Resources

¶ The minor K Pool Effluent nutrient concentration, the large river flow dilution effect, the buoyancy of the slightly warmer effluent water, and the above-river bed effluent release point all combine to lead to the conclusion that the Columbia Pebblesnail and the shortface lamp would not be adversely impacted, even if assumed to live on the substrate below the end of the effluent pipeline. ¶

Question: The discharge may not affect the macro environment of the Columbia, but what about the micro environment? Increase in temperature and organic nutrients that are supplied may cause a reaction that may have inhibited growth of possible pathogens.

Kevin, please be advised, comments being made regarding this EA is trial based. In response to answers, guidance in refining questions would be greatly appreciated.

Respectfully,



ROXANN R. SOCKEZHGH
Environmental Engineer Intern



Department of Energy
Richland Operations Office
P.O. Box 550
Richland, Washington 99352

NOV 12 1996

96-DEA-241

Ms. Roxann R. Sockzehigh
Environmental Engineer Intern
Confederated Tribes & Bands of the Yakama Nation
P.O. Box 151
Toppenish, WA 98948

Dear Ms. Sockzehigh:

COMMENTS ON ENVIRONMENTAL ASSESSMENT OF K POOL FISH REARING

Thank you for your comments on the Draft Environmental Assessment (EA), (DOE/EA-1111). Your comments were helpful in preparation of the Final EA. Your comments or questions and our responses are included below:

- Comment:** "The business ventures that may include the YIN, which department would take part in the funding or would be the Yakama Nation's decision based off a liaison for the tribe be recognized?"
- Response:** The focus of an EA concerns the effect on the environment of the proposed action. Notice that the EA is written to apply to the YIN or any other interested parties who may enter into a lease arrangement. This question cannot be answered by the EA.
- Comment:** "Will (or can) the Biological Oxygen Demand (BOD) be monitored or screened before water is pumped into the system as well as the effluent?"
- Response:** The dissolved oxygen content of the rearing water (e.g., net pens, tanks, raceways) would be routinely monitored during fish culture activities to ensure that the environment is satisfactory for fish raising. Effluent water would be monitored to assure compliance with NPDES permit conditions.
- Question:** "The discharge may not affect the macro environment of the Columbia, but what about the micro environment? Increase in temperature and organic nutrients that are supplied may cause a reaction that may have inhibited growth of possible pathogens."
- Response:** We believe that the same features that protect the macroenvironment act to protect the microenvironment, i.e., high dilution, rapid mixing and the location of the discharge pipe above the river bed. In addition, employing IHOT practices as indicated in the EA would adequately protect the microenvironment. See sections 2.0 and 5.0 of the EA.

Ms. Sockzehigh
96-OEA-241

-2-

NOV 12 1996

If you have any questions, please call Kevin Clarke, Office of External Affairs, on (509) 376-6332 or myself on (509) 376-6667.

Sincerely,

Paul F.X. Dunigan, Jr.
Paul F.X. Dunigan, Jr.
NEPA Compliance Officer

OEA:KVC

FINDING OF NO SIGNIFICANT IMPACT

K POOL FISH REARING

HANFORD SITE, RICHLAND, WASHINGTON

U.S. DEPARTMENT OF ENERGY

December 1996

This page intentionally left blank.

AGENCY: U.S. Department of Energy

ACTION: Finding of No Significant Impact

SUMMARY: The U.S. Department of Energy (DOE) has prepared an Environmental Assessment (EA), DOE/EA-1111, for leasing the 100-K Basins for the purpose of raising fish. Based on the evaluation in the EA (which examined and compared the environmental impacts of the proposed action and reasonable alternatives), DOE has determined that the proposed action is not a major federal action significantly affecting the quality of the human environment, within the meaning of the *National Environmental Policy Act of 1969* (NEPA). Therefore, the preparation of an Environmental Impact Statement (EIS) is not required.

ADDRESSES AND FURTHER INFORMATION:

Single Copies of the EA and further information about the proposed action are available from:

Ms. Karen K. Randolph, Director
Office of External Affairs MSIN A7-75
U.S. Department of Energy
Richland Operations Office
P. O. Box 550
Richland, Washington 99352
(509) 376-8230

For further information regarding the DOE NEPA Process, contact:

Carol M. Borgstrom, Director
Office of NEPA Oversight
U.S. Department of Energy
1000 Independence Avenue, S.W.
Washington, D.C. 20585
(202) 586-4600 or (800) 472-2756

PURPOSE AND NEED: The U.S. Department of Energy (DOE) has a need to respond to a request for a long-term use permit or lease of unused Hanford Site facilities at the 100-K filter plant pools (K Pools) for fish rearing activities. These fish rearing activities would be: (1) business ventures with public and private funds and (2) long-term enhancement and supplementation programs for game fish populations in the Columbia River Basin.

BACKGROUND: Water purification pools located in the 100-K Area of the Hanford Site were constructed in the early 1950's to provide cooling water to the associated plutonium production reactors. Water from the Columbia River flowed from the purification pools in single-pass fashion through the reactors and back to the river without any possibility of contaminating the pools with radioactive material. This mission ended in the 1970's except for a small amount of cooling water needed for the spent nuclear fuel storage in the KE and KW Fuel Storage Basins.

During the last three years, it has been demonstrated that Hanford water purification facilities are very adaptable for the rearing of fish. Beginning in the spring of 1993, several fish-rearing projects have either been conducted or are underway in the K Pools:

- From early April to late May 1993, 150,000 juvenile fall chinook salmon were held and fed ("grown-out") in a floating, tethered net pen, and subsequently released as "smolts" in the Columbia River from the nearby Priest Rapids Hatchery.
- In August 1993, 550 white sturgeon were placed in a net pen. They are intended to be raised as broodstock to obtain eggs and young fish for sale to other aquaculturists.
- In early May 1994, the Yakama Indian Nation (YIN), DOE, and Westinghouse Hanford Company (WHC) took part in a cooperative agreement in which 500,000 upriver bright fall chinook salmon juveniles were grown-out to "smolt" stage, and released directly into the Hanford Reach of the Columbia River at the 100-K Area to begin their migration to the Pacific Ocean.
- Beginning in May 1994, the Washington State Department of Fish and Wildlife, DOE, and WHC participated in a collaborative project by rearing walleye and channel catfish for stocking into Washington State lakes.
- On March 17, 1995, about 12,000 rainbow trout fry were delivered to a net pen in a K Pool for rearing and eventual planting in mountain lakes on the YIN reservation.
- Starting in May 1995, the YIN, DOE, and WHC participated in rearing 700,000 upriver bright fall chinook salmon to be released into the Columbia River as smolts.

PROPOSED ACTION: The DOE proposes to lease surplus Hanford 100-K Area Pools and associated facilities, infrastructure, and/or services to the YIN or other interested parties for the purpose of rearing fish.

Initially only 100-KE pools and facilities would be leased, although DOE may lease the 100-KW Pools and facilities in the future. The proposed action would be to enter into a lease agreement with the YIN or other parties to rear fish in the 100-KE water treatment basins, and in the future possibly the 100-KW water treatment basins. The proposed action would include necessary piping, pump and electrical upgrades of the facility; preparation of the basins; water withdrawal from the Columbia River; water treatment; introduction, rearing and release of fish; and future commercial operations.

The lessee plans to raise fish in these leased facilities for two purposes: (1) to provide a public service in the form of rearing and releasing fish species (e.g., salmon, sturgeon) for regional Columbia River Basin supplementation and enhancement purposes, and (2) to provide a product for commercial economic development reasons (fresh fish for sale to retail

and restaurant markets, and live juvenile fish for sale to state and private agencies for stocking for sports fishing).

The lessee would use such associated infrastructure facilities, functions, or services, such as river water flow, electricity, etc., as may be provided by DOE or its contractor. After the Spent Nuclear Fuels mission ends at the KW Area facilities, the lessee could control and operate the infrastructure services required for fish rearing, with the right to make modifications, repairs, and changes.

To obtain funding for its proposed public service fish rearing program at the K Pools facilities, the prospective lessee wishes to demonstrate sufficient long term access and control of facilities that could be provided under a lease. Additionally, the lessee would demonstrate long-term control of K Pool facilities in order to attract the necessary capital for a commercial aquaculture program. A long-term lease of facilities would be needed for these purposes.

The lease will contain a provision requiring the lessee to obtain all necessary permits and approvals.

ALTERNATIVES CONSIDERED: No-Action: Under the No-Action Alternative, DOE would discontinue authorizing fish rearing at the K Pools and the pools would sit vacant and unused waiting for eventual decommissioning. The present fish rearing activities are not considered to be the status quo. This alternative would not allow any productive use of the facility.

Alternative of using ponds at 100-D Area: Under this alternative, 16 concrete basins and a large concrete reservoir at the 100-D Area would be used for fish rearing. The 25 Million gallon 182-D reservoir is currently in use as a header tank for the Hanford export water system that supplies raw Columbia River water to the 200 East and 200 West Areas. Plans are to use this reservoir in this capacity for at least 30 more years.

Two of the 16 concrete basins (Basins # 7 and 8) cannot currently be used for fish rearing activities that require flowing water because the discharge line has been filled with concrete to preclude leakage to a Resource Conservation and Recovery Act (RCRA) site. The other 14 basins would require extensive modifications to make them operational. For the reasons stated this alternative is not acceptable.

Alternative of building new facilities: The construction of new basins, water import and export lines, pumping systems, and the need to obtain permits and approvals for river intakes and outfalls would make this alternative more expensive than using the presently available and operational 100-K basins. In addition, several acres of prime sagebrush habitat could be destroyed during construction and operation of new basins and a new water supply system. Habitat destruction and high expense make this alternative unfeasible.

Alternative of continuing one-year agreements: Under this alternative, DOE would continue to make KE and KW water purification pools and infrastructure available to the YIN for fish rearing under one year cooperative agreements instead of a lease. An extensive and ongoing fish rearing and marketing business plan cannot be built upon short term, one year agreements. Reliable, long term agreements are needed for investment and business purposes. This alternative is not feasible for this reason.

ENVIRONMENTAL IMPACTS:

Cultural Resources: There will be no adverse impacts to cultural resources.

A Programmatic Agreement (PA) Among the U.S. Department of Energy, Richland Operations Office, the Advisory Council on Historic Preservation, and the Washington State Historic Preservation Office, for the Maintenance, Deactivation, Alteration, and Demolition of the Built Environment on the Hanford Site, Washington, was signed August 21, 1996, that removes the KE Pools from further consideration under Section 106 and Section 110 of the National Historic Preservation Act. The PA allows DOE to manage historic properties on the Hanford Site as elements of an Historic District. Per the PA, historic documentation will be prepared on representative buildings and structures to mitigate adverse effects (including leasing) to the Historic District. Prior to leasing KW Pools an Historic Property Inventory Form will be prepared.

Biological Resources: There will be no significant impacts on biological resources. A Ecological Survey was conducted for the proposed project. The survey concluded that the proposed project should have no adverse impact on any plant or animal species presently protected by the *Endangered Species Act of 1973*. Furthermore, fish rearing in accordance with IHOT Hatchery management policy is expected to not have an adverse impact on the health of native fish populations.

Air : There will be no significant impacts to air.

Water and Ground Water: There will be no significant adverse impacts to water. No surface streams will be adversely affected. Wastewater discharged to the Columbia River would be treated to comply with permit condition. The main project site is not located within a wetland area, or on the 100-year floodplain although existing water intake structures at the Columbia River are within the 100-year floodplain.

Land Impacts: There will be no significant impacts to land. All waste will be disposed of in appropriately permitted disposal sites.

Safety Impacts: There will be no significant impacts. Operations will conform to recognized safety codes and regulations to ensure a safe working environment.

Socioeconomic Impacts: The proposed action will provide employment for a small number of members of the YIN. Therefore, no significant socioeconomic impacts are expected from the proposed action.

Environmental Justice: Executive Order 12898, Federal Actions to Address Environmental Justice in Minority Populations and Low-Income Populations, requires that federal agencies identify and address, as appropriate, disproportionately high and adverse human health or environmental effects of their programs and activities on minority and low-income populations. With respect to Executive Order 12898 regarding environmental justice, distributions of minority and low income population groups have been identified for the Hanford Site. The analysis of the impacts in this EA indicates that there will be minimal impacts to both the offsite population and potential workforce by implementing the proposed action, because the proposed action will occur predominately on the Hanford Site and the offsite environmental impacts from the proposed action analyzed in this EA are expected to be minimal. Therefore, it is not expected that there will be any disproportionate impacts to any minority or low-income portion of the community.

Cumulative Impacts: An evaluation of the environmental impacts indicates that no significant adverse cumulative impacts will result from the proposed action. A possible positive cumulative impact would be the long-term enhancement of fish populations in the Columbia River and other regional waters.

DETERMINATION: Based on the analysis contained in the EA, and after considering the preapproval review comments of the State of Washington Department of Ecology, the Yakama Indian Nation, the National Marine Fisheries Service, and the Bonneville Power Administration, I conclude that the proposed action to lease the 100-K area water basins for the purpose of fish rearing does not constitute a major federal action significantly affecting the quality of the human environment within the meaning of NEPA. Therefore, an EIS for the proposed action is not required.

Issued at Richland, Washington, this 20th day of December 1996.

John D. Wagoner
Manager
Richland Operations Office