



U.S. DEPARTMENT OF
ENERGY

Nuclear Energy

NSUF Plans and Needs for In-Pile Sensors and Characterization

Brenden Heidrich, Ph.D.
R&D Capabilities Scientist, NSUF
Idaho National Laboratory

**Advanced Sensors and Instrumentation
Program Review**
October 12, 2016



INL/CON-16-39256

What is a User Facility?

- *Regional, national or international facility with unique experimental capabilities.*
- *Access is typically cost-free through a competitive proposal process.*
- *The goal is to connect the best ideas with the capability regardless of geographical separation.*



Advanced Photon Source (ANL)



Spallation Neutron Source (ORNL)

There are currently 50 DOE user facilities in the U.S.

- Advanced scientific computing research
- High flux synchrotron and neutron sources
- Electron beam characterization
- Nano-scale science
- Biological and environmental research
- High energy and nuclear physics
- Fusion energy science

.....But before 2007 there were no user facilities to address the unique challenges of nuclear energy.

Then came the Advanced Test Reactor National Scientific User Facility!

What does NSUF study?

In-Reactor Degradation Behavior of Nuclear Fuels and Materials

■ Maintaining fleet of current reactors

- Life extension for commercial reactors
- Developing accident tolerant nuclear fuels

■ Developing the next generation of safer more efficient reactor systems

- Materials resistant to high levels of radiation damage
- Reduced enrichment fuels for test reactors
- High temperature gas reactor fuels and materials
- Liquid metal cooled fast reactors for transmutation

Restructuring in
U-Pu-Zr Metallic Fuel

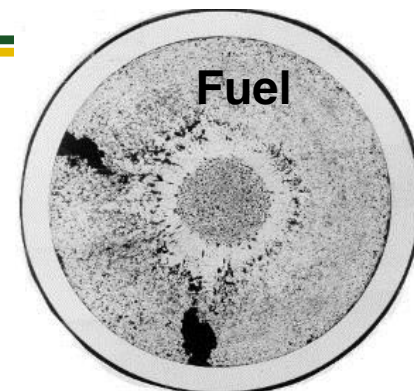

Radiation Damage Effects in
Cladding and Structural Materials



Austenitic Stainless Steel
Following Irradiation in
EBR II Fast Reactor

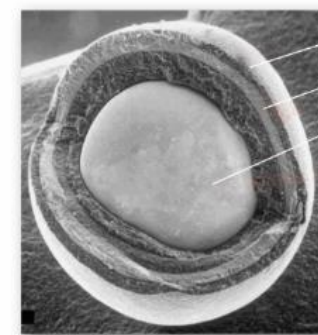

Gas Reactor Coated-
Particle Fuel

U-Mo Plate Fuel

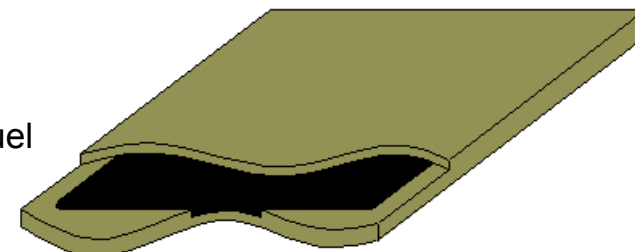



Initial Vision for the (ATR) NSUF



Allow the research community access to test reactor space and existing post irradiation examination facilities

Advanced Test Reactor

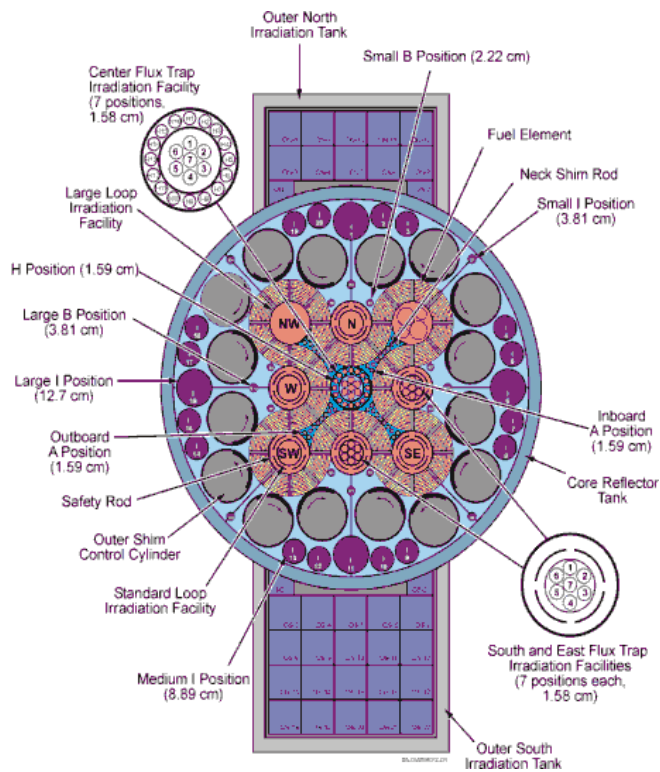

Post Irradiation Examination (PIE) Facilities at Materials & Fuels Complex (MFC @ INL)





U.S. DEPARTMENT OF
ENERGY

Nuclear Energy

NSUF – A consortium





NSUF Capabilities

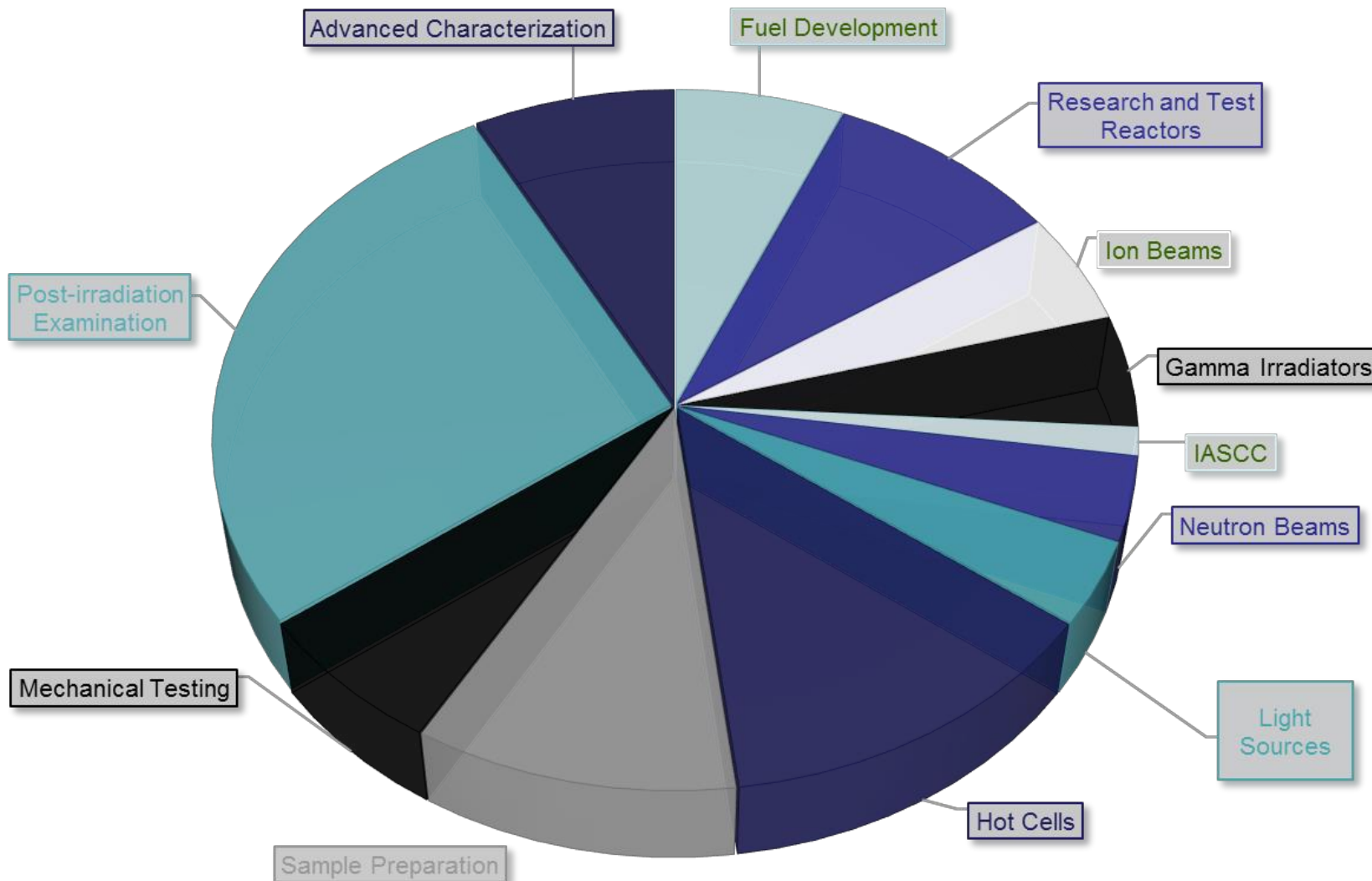



U.S. DEPARTMENT OF
ENERGY

Nuclear Energy

Expanded NSUF Vision



Build sustainable value over the long term

High Impact Results

Focus on High Impact Results Addressing Most Pressing Issues or Areas Offering Greatest Potential for Advancement. Advanced Understanding of Most Important Phenomena. Increased Public Awareness.

R&D Projects

Competitive Awards (Focused CINR Scope). Non-Competitive Awards (NE Programs, CRADA, Proprietary). All Forward Funded.

Capability Maintenance Replacement

F&M Sample Library

Keep Core Infrastructure Functional. Reduce Costs. Manage High Value Materials. Aid in Disposition Decisions

Infrastructure Management

High Performance Computing

Identify and Analyze Capability Status and Needs. Couple Experiment to Computation. Support Validation & Verification in M&S.

Capability Development

Capability Enhancement

Human Capital

Develop Cutting Edge, State of the Art Instrumentation and Internationally Recognized Expertise. Leverage other User Facilities.

- 1. Consolidated Innovative Nuclear Research FOA**
 - For full irradiation/PIE, PIE Only, or APS projects
 - Kickoff in August, awarded the following June
 - R&D support funding can be requested
- 2. Rapid Turnaround Experiment calls**
 - For small examination or beam-line projects
 - Three calls per year
 - No R&D support funding
 - XPD at NSLS-II, IVEM and MRCAT at APS are available
- 3. CRADA and WFO (non-competitive)**
 - Cost shared non-proprietary research
 - Full cost recovery proprietary research
 - Utilized so far by industry and the Nuclear Regulatory Commission
- 4. DOE-NE Infrastructure Programs**
 - Reactor Upgrades
 - General Scientific Infrastructure





NSUF Awarded Research

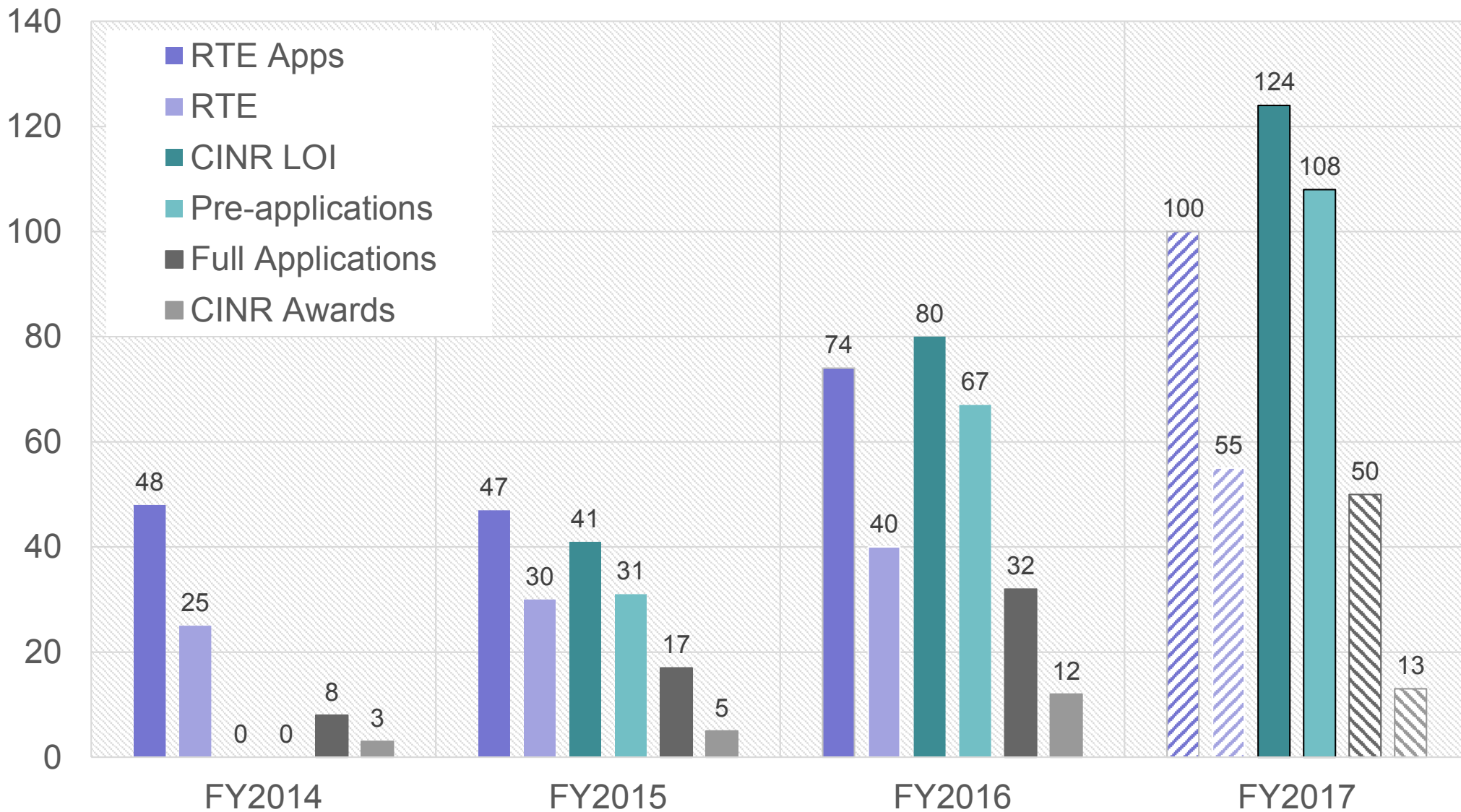

Nuclear Energy-Related R&D Supported By Nuclear Science User Facilities Capabilities (NSUF -1)

- NSUF 1.1a: Neutron Radiation Assessment of Advanced Alloys for LWR Core Internals
- NSUF 1.1b: Synergistic Radiation and Thermal Aging Effects on Cast Austenitic Stainless Steel
- **NSUF 1.2a: Advanced Manufacturing of Instrumentation for In-Pile Measurement and Characterization of Nuclear Fuels and Materials**
- **NSUF 1.2b: Developing and Testing Advanced Materials and Advanced Sensors through In-Pile Tests.**
- NSUF 1.2c: Irradiation Testing Of Materials Produced By Innovative Manufacturing Techniques (SiC)
- NSUF-1.3: Advanced Material Technologies Development (ODS)

■ Nuclear Science User Facilities Access Only (NSUF-2)

- Core and Structural Materials
- Nuclear Fuel Behavior and Advanced Nuclear Fuel Development
- **Advanced In-reactor Instrumentation**
- Experiments with Synchrotron Radiation



■ Separate Effects Irradiation Testing For Validation of Microstructural Models in Marmot (NEAMS 2)

Nuclear Science User Facilities

CAPABILITIES

■ Neutron Irradiations

- ATR (loop, rabbit) 250MW
- ATR-C
- HFIR (rabbit) 85MW
- MITR (loop) 6MW
- PULSTAR 2MW

■ Hot Cells

- INL (HFEEF, FCF, AL, IASCC)
- ORNL (IFEL, IMET, REDC)
- PNNL (RPL)
- Westinghouse (MCOE)
- U. Michigan (IMC)

■ Ion Irradiations

- Tandem Accelerator Ion Beam (Wisconsin)
- Michigan Ion Beam Lab (Michigan)
- Intermediate Voltage Electron Microscope – IVEM (ANL)

■ Beam-lines

- X-ray (ANL APS: MRCAT, IIT)
- Neutron, positron (PULSTAR, NCSU)

- Visit [NSUF.INL.gov](https://www.nsls.gov) under Research Capabilities tab for details



U.S. DEPARTMENT OF
ENERGY

Nuclear Energy

NSUF – Multiple Research & Test Reactors

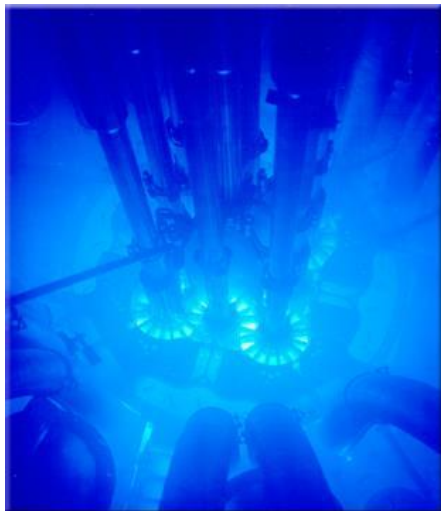

Advanced Test Reactor (INL)

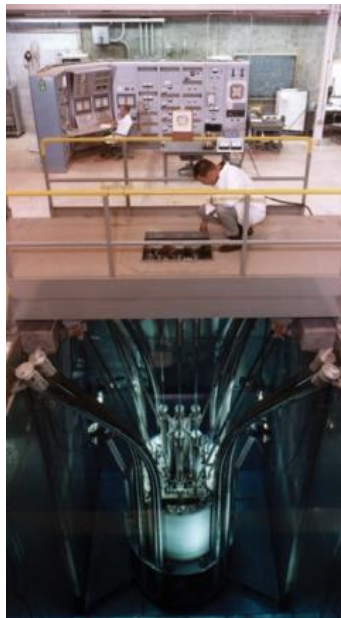

ATR Critical Facility (INL)

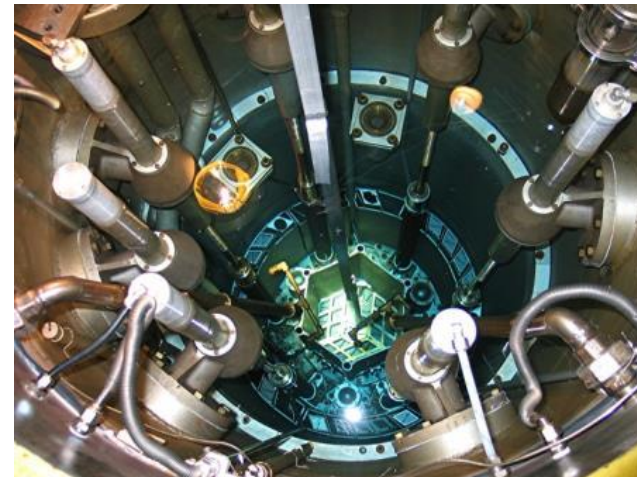

MIT Reactor



High Flux Isotope Reactor (ORNL)

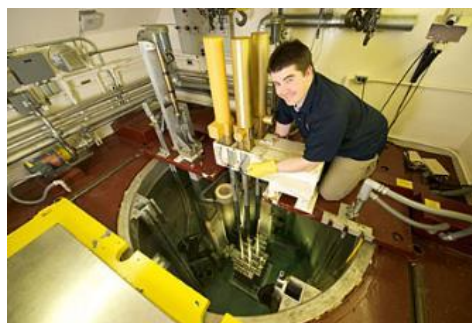

NRAD Reactor (INL)

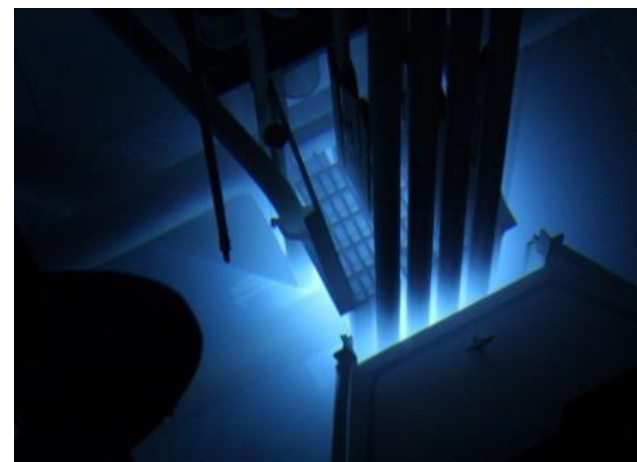

PULSTAR Reactor
(NCSU)



University of Michigan
Ion Beam Laboratory

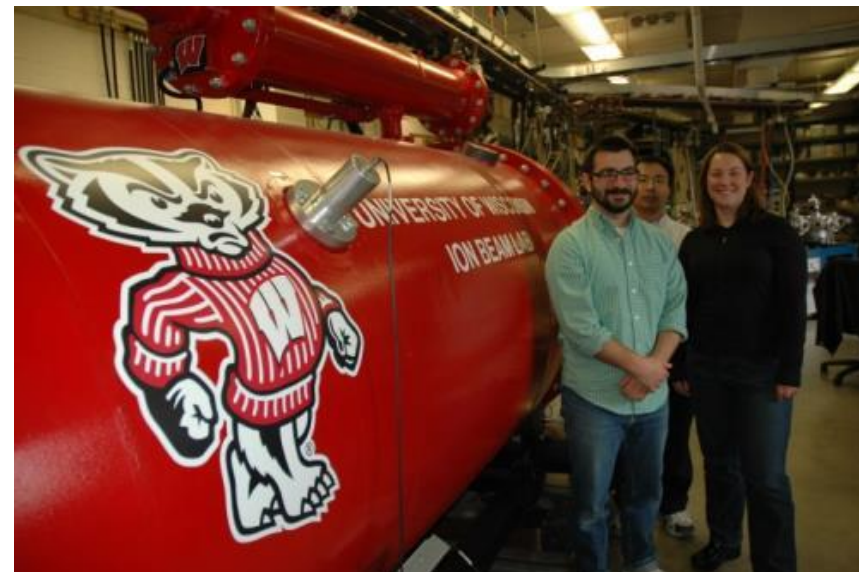

University of Wisconsin
Tandem Accelerator Ion Beam

Additional & Pending Partners:

- IVEM at the Argonne National Laboratory
- CMUXE at the Purdue University (surface science)
- Ion Beam Laboratory at the Texas A&M University(p)
- I³TEM Facility at the Sandia National Laboratory(p)

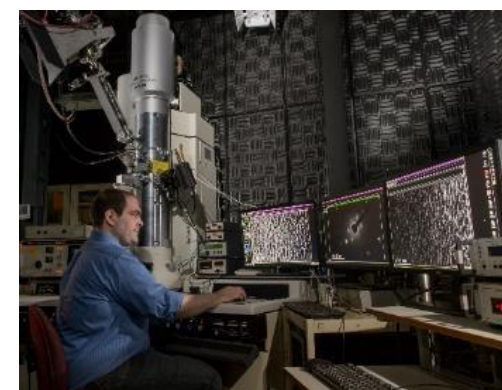

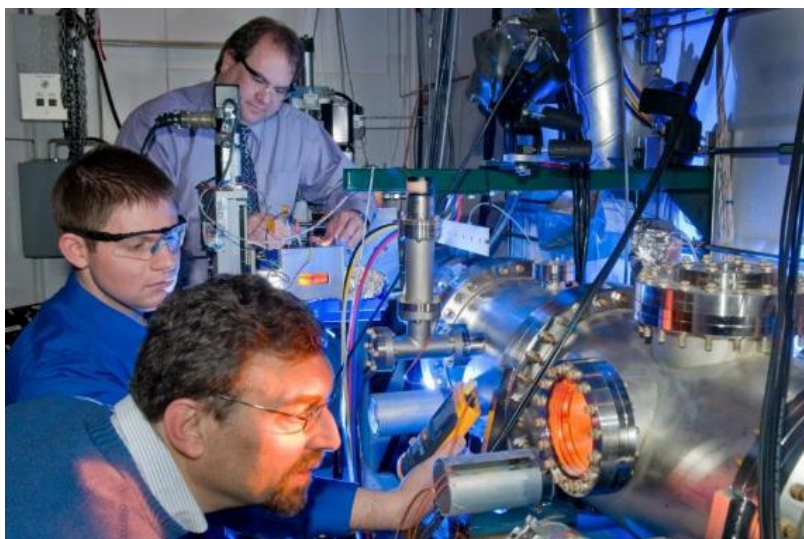

Illinois Institute of Technology MRCAT Beamline

at Argonne National Laboratory's
Advanced Photon Source



National Synchrotron Light Source-II (NSLS-II)

radioactive materials beamline
at Brookhaven National Laboratory
(pending)

Hot Cell Capabilities



Hot Fuel Examination Facility (INL)

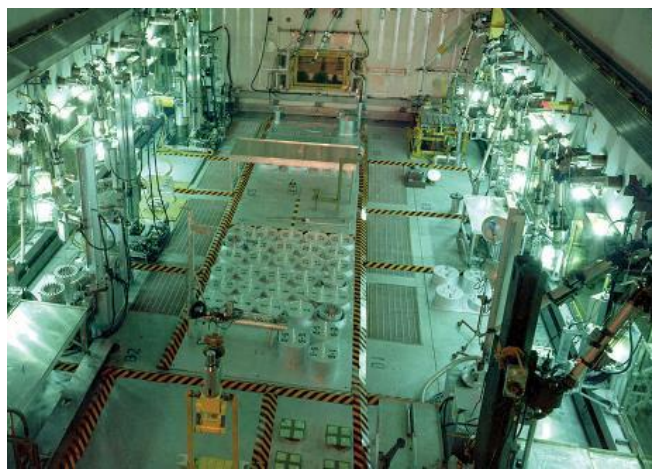

MIT Reactor Hot Cells



Materials Center of Excellence
Laboratories (Westinghouse)



Radiochemical Engineering
Development Center (ORNL)



Radiochemistry Processing
Laboratory (PNNL)

Post Irradiation Examination

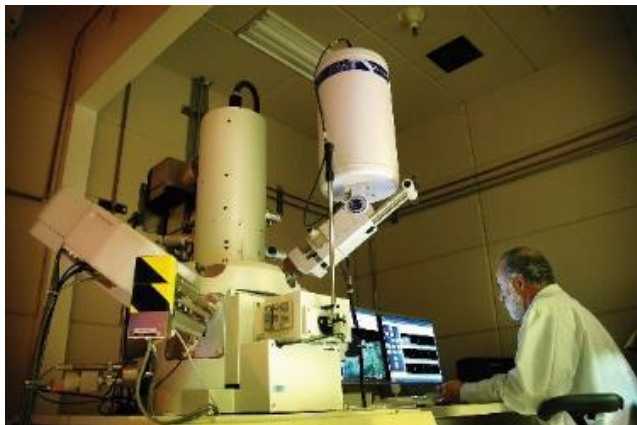

Electron Microscopy Laboratory (INL)

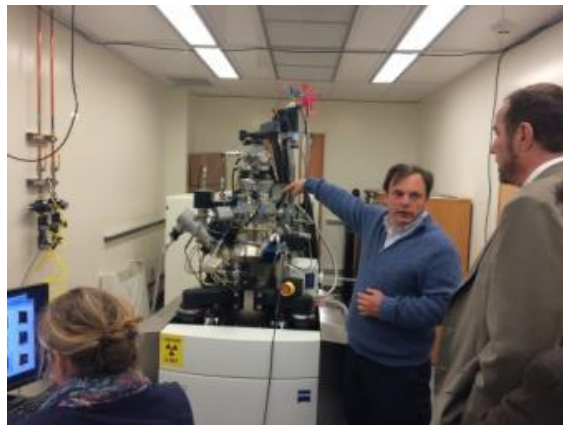

Nuclear Materials Laboratory (UCB)



Radiochemistry Processing Laboratory & the Materials Science and Technology Laboratory (PNNL)

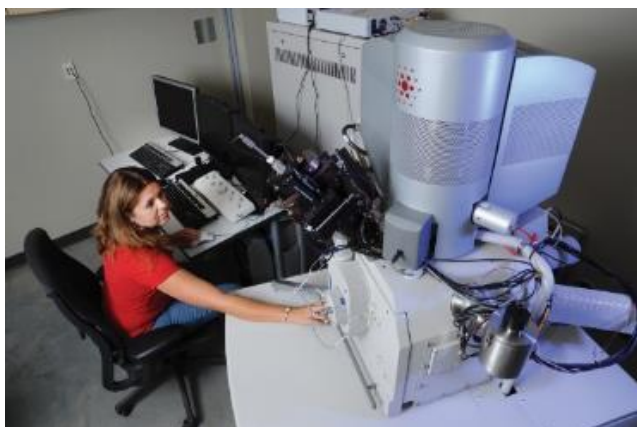

Microscopy and Characterization Suite (Center for Advanced Energy Studies)



Low Activation Materials Development and Analysis Laboratory (ORNL)

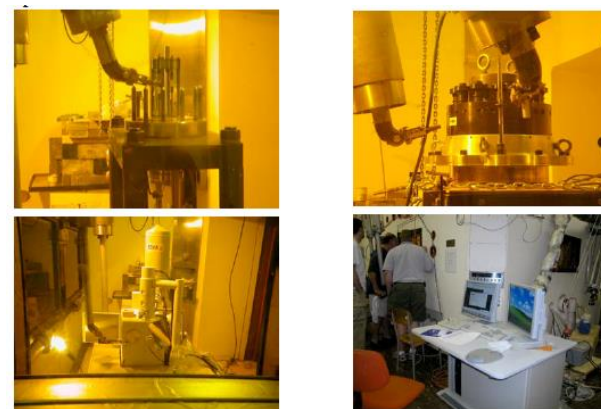

Irradiated Materials Laboratory (University of Michigan)

How does HPC enable DOE missions?

- High Performance Computing (HPC) compliments theory and informs experimental processes.
- HPC functions as a 'microscope' for researchers to better understand physics, chemistry, and engineering principles in ways not otherwise possible.
- HPC resources support NSUF, CASL, NEAMS, NEUP, and GAIN

NSUF Program Support

- System already in place for quickly granting user access and prioritizing work
- Reporting and accounting systems are being modified to better capture NSUF metrics and science impact
- Implementing tools to improve and simplify user experience
- Ensuring that NSUF and related programs have needed support
 - Priority scheduling for milestones upon request
 - Supporting as-run analysis, thermal analytics, neutronics analytics
 - MOOSE support

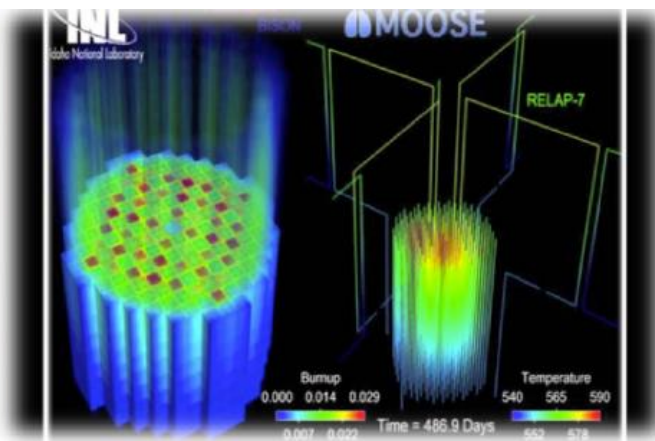
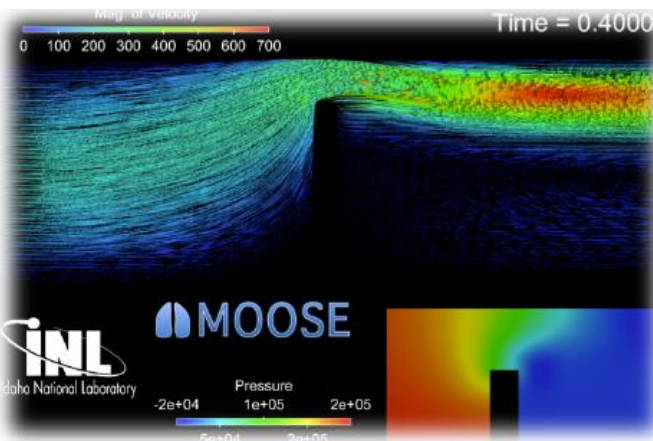
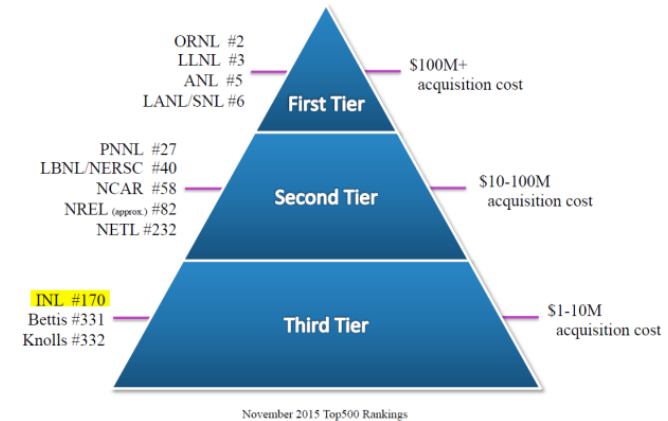

Nuclear Science User Facilities

IRRADIATION EXPERIMENTS

Test Reactor Irradiation Experiment Designs

- **Simple Static Capsules (Drop-in)**
 - Designed for a single temperature
 - Instrumented with flux and melt wires
- **Instrumented Lead Experiments**
 - On-line experiment measurements
 - With or w/o temperature control
- **Pressurized Water Loops**
 - Six loops installed in flux traps
 - Control pressure, temperature, chemistry
- **Hydraulic Shuttle Irradiation System**
 - Inserted and removed during reactor ops

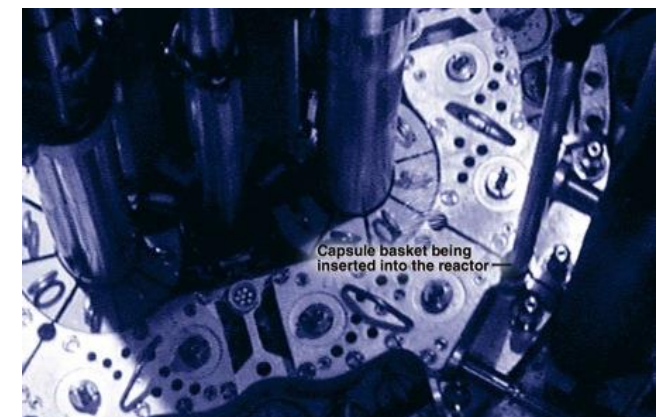
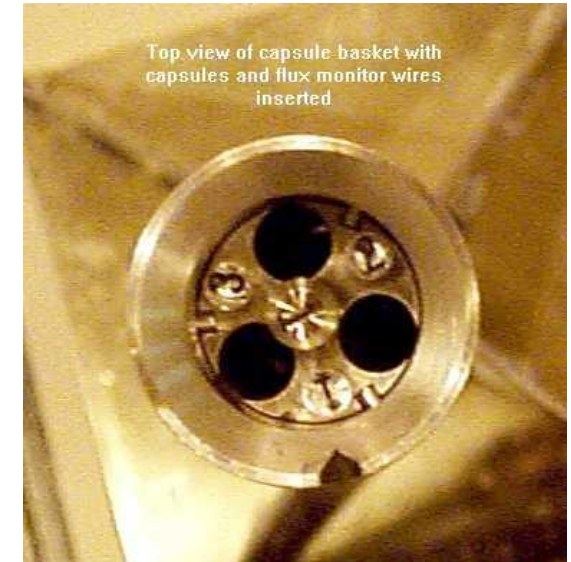



Advanced Test Reactor

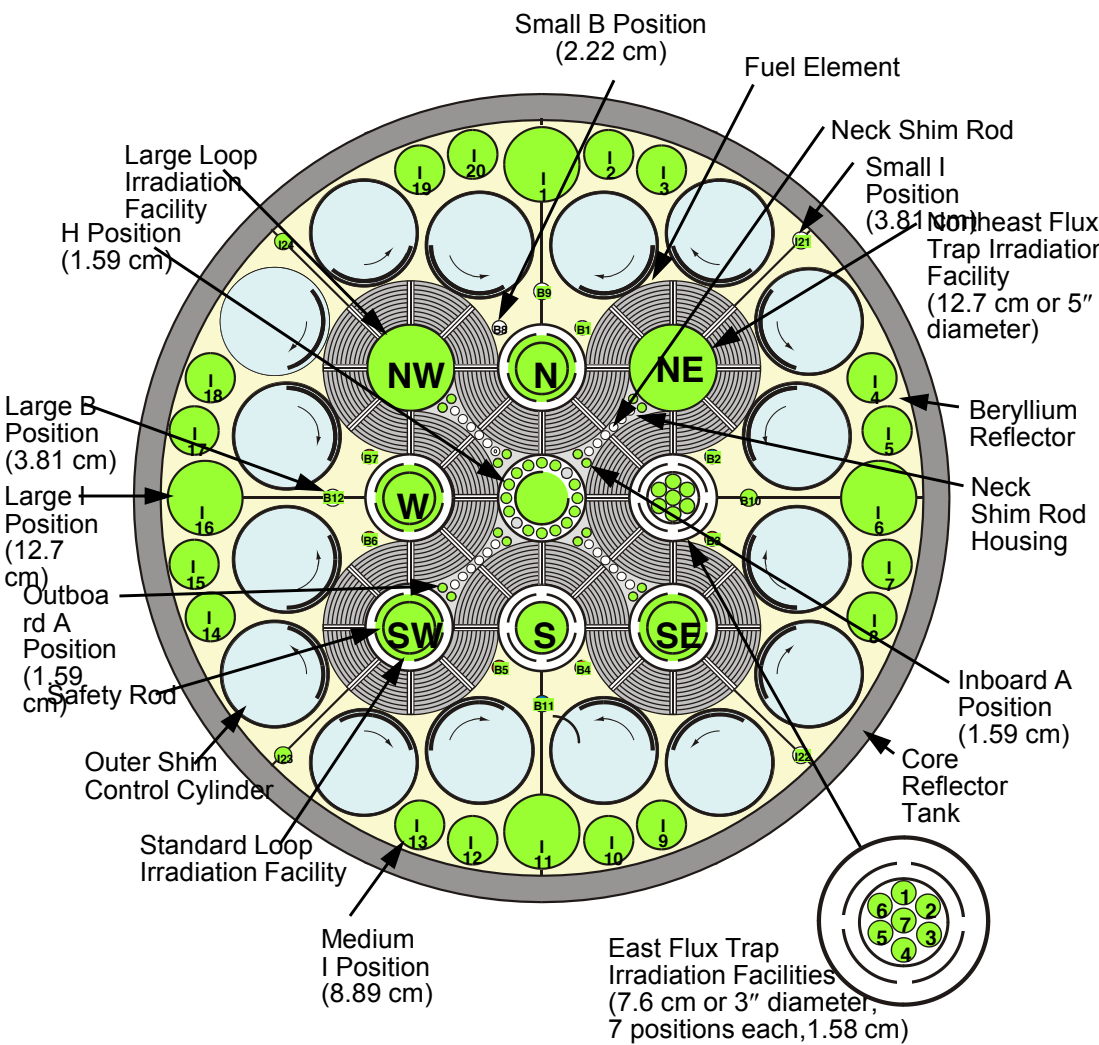

Outer shim cylinder drives

In-pile tubes

Safety rod drives

Reactor core

Discharge chute

In-pile tubes entrance/exit piping

Neck shim and regulating rod drives

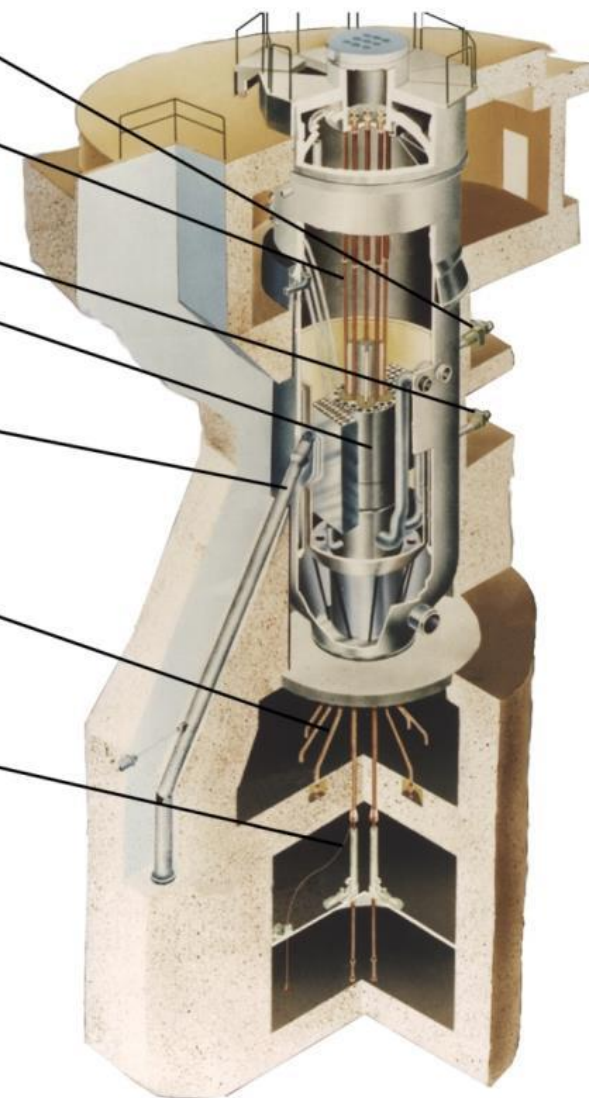

Hydraulic Shuttle Irradiation System

- 14 shuttle capsules
- Simultaneously irradiated
- Flux, at 110 MW:
 - Thermal Flux: 2.5×10^{14} n/cm²-s
 - Fast (>1MeV): 8.1×10^{13} n/cm²-s
- Dimensions:
 - ~ 0.55" ID, ~2.1" IL
 - ~ 7 cc useable volume
 - ~35 gm Contents
- Can irradiate small amounts of fissile material (10mg)

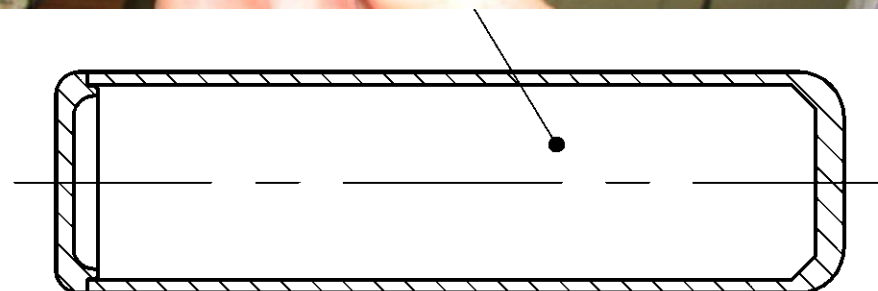



High Flux Isotope Reactor (HFIR)

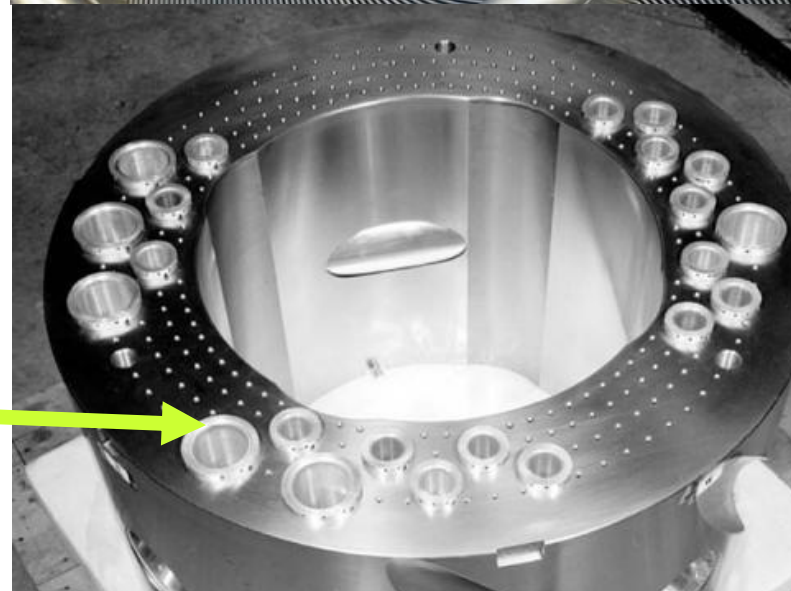
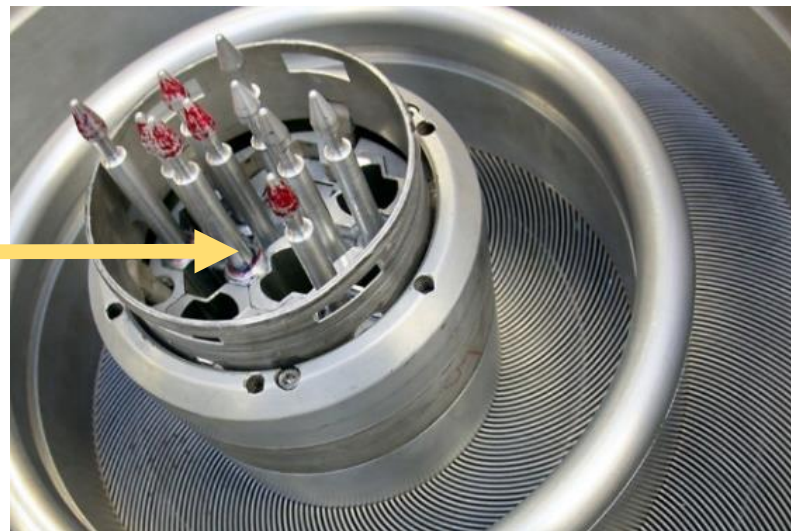
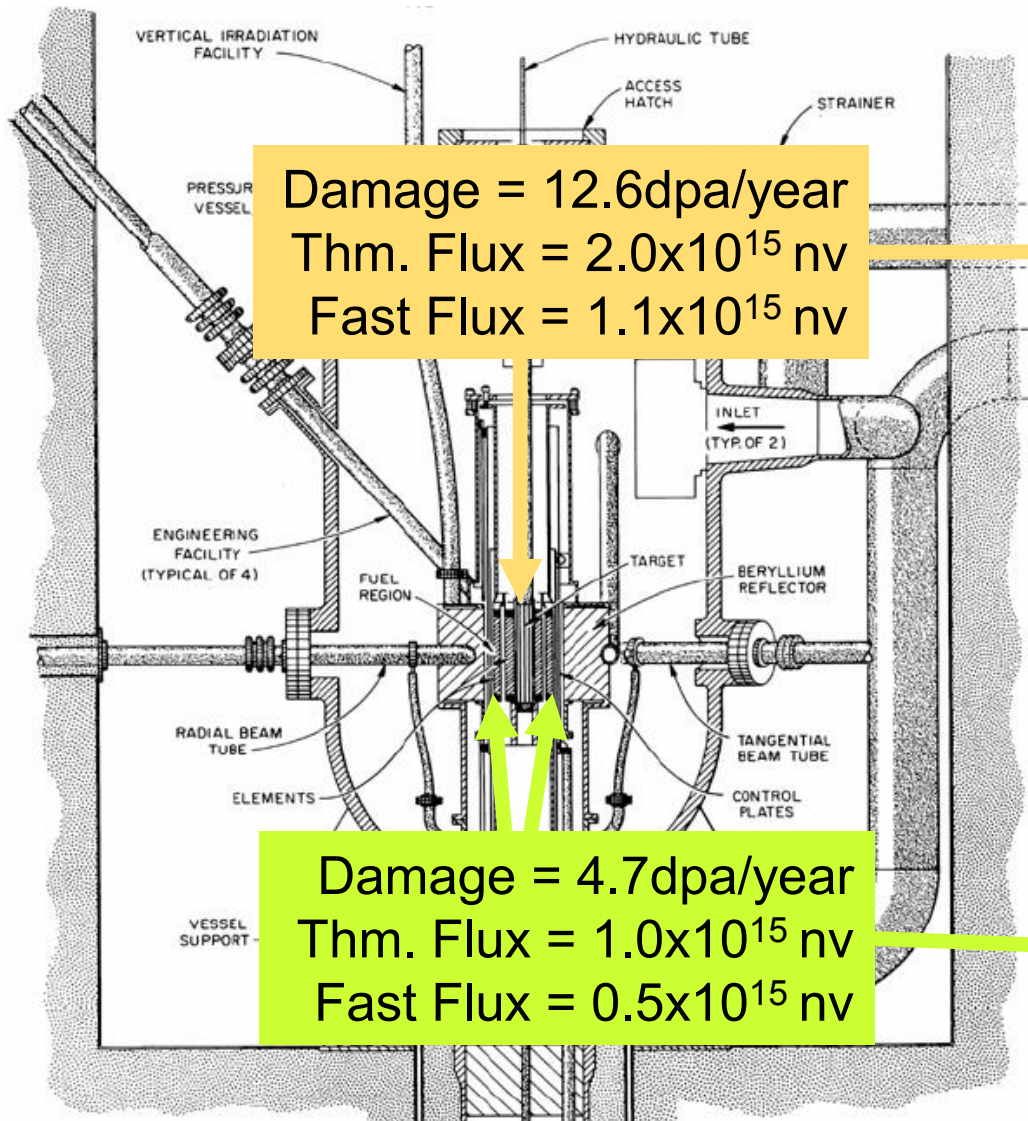



High Flux Isotope Reactor (HFIR)

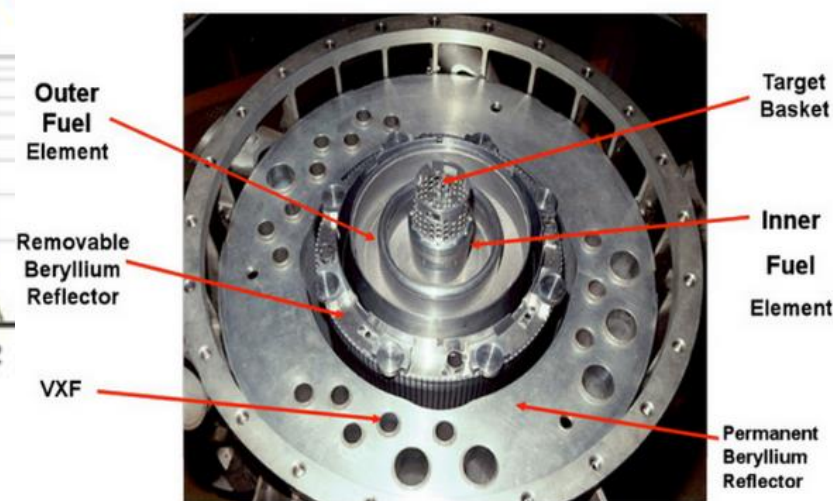
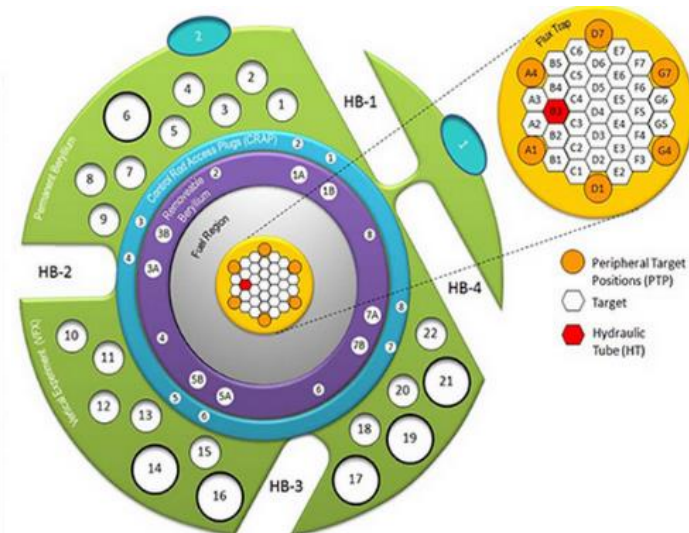
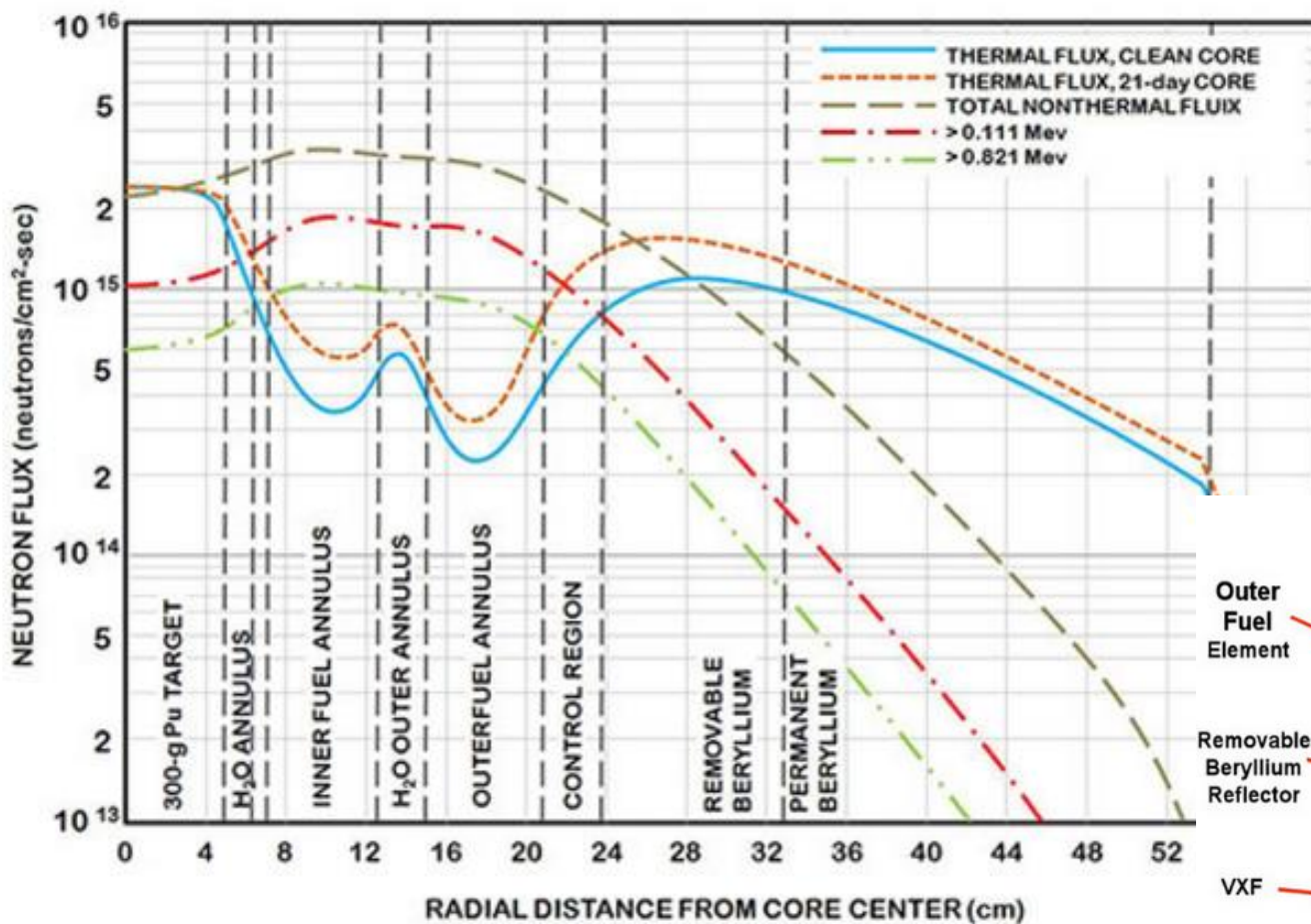

■ The MITR has the capability to perform a wide range of experiments in the reactor's core.

- An inert gas-filled irradiation tube (**ICSA**) for sample capsule irradiation at $<900\text{ }^{\circ}\text{C}$ (instrumented or un-instrumented),
- Forced-circulation coolant loops that replicate conditions in both pressurized and boiling water reactors,
- High temperature ($>900\text{ }^{\circ}\text{C}$) irradiation facility for materials irradiations in inert gas (He/Ne mix),
- Custom, dedicated facilities for irradiations in unique conditions (e.g., molten fluoride salts).
- Fast flux ($>0.1\text{ MeV}$) $1.2 \times 10^{14}\text{ n/cm}^2\text{-s}$.
- Thermal flux $3.6 \times 10^{13}\text{ n/cm}^2\text{-s}$

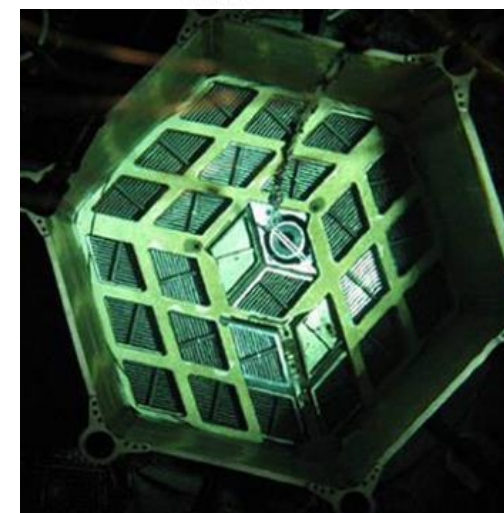
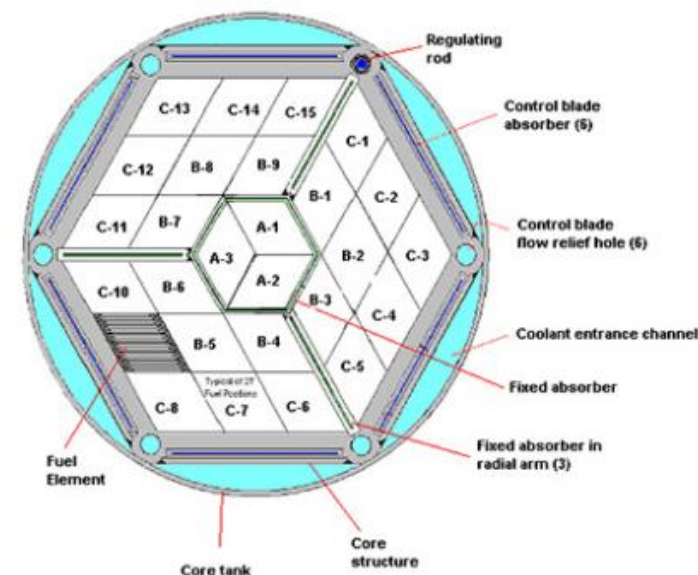

In-Core Sample Assembly” (ICSA)

- sample irradiations in an inert gas atmosphere with TCs.
- The ICSA is cooled by the reactor coolant.
- Active heating or cooling is also potentially available.
- Fuel irradiations $\leq 100 \text{ gm } ^{235}\text{U}_{\text{eq}}$.
 - not forced circulation loop

Parameter	Permissible values	Comments
Total in-core volume	2" ID x 22" long	Maximum available opening in an in-core dummy fuel element
LWR sample space	- 1" ID x 22" long	Typical - dependent on autoclave design pressure and materials.
High temperature sample space	- 0.8" ID x 20" long	Dependent on temperature desired and gamma heating susceptor material choice.
MITR coolant wetted materials	Aluminum, stainless steel, titanium, zircaloy	Small amounts of other materials on case by case basis
MITR coolant heat flux	<400 kW/m ²	No Onset of Nucleate Boiling
Fissile material content	<100 g U-235 or equivalent	Fissile materials other than U-235 require pre-approval
Facility reactivity	Secured: <1.8% DK/K Non-secured: <0.5% DK/K Movable: <0.2% DK/K	"Movable" reactivity limits apply to coolant phase change and dissolvable neutron poison.

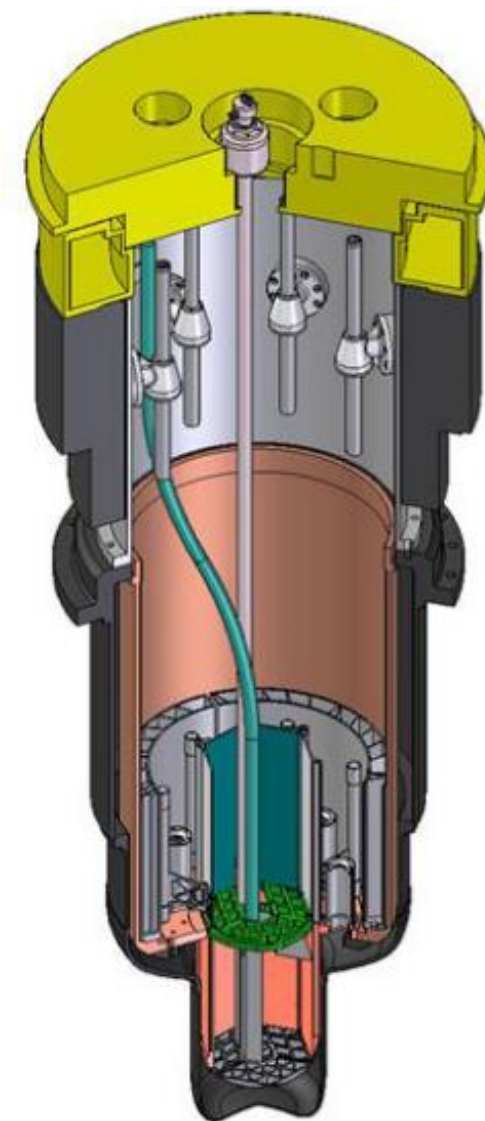

Experimental Parameters from NSUF Experiments

1. Temperature (magnitude & variation)	Passive or Active in-pile
2. Neutron Fluence & Spectrum	Passive or Active in-pile
3. Gamma Fluence & Spectrum	Active in-pile only
4. Microstructure	PIE
5. Density	PIE
6. Swelling	PIE
7. Cracking	PIE
8. Hardness	PIE
9. Mechanical Strength (tension)	PIE
10. Thermal Conductivity	PIE
11. Heat Capacity	PIE
12. Coefficient of Thermal Expansion	PIE
13. Creep	PIE
14. Chemistry/Corrosion	PIE

Drop-in / Static Capsule Experiments

Project	Reactor	Position	Material	Parameters
1	ATR	B _S 0.875"	Advanced Fuels	1,2,4,5,6,14
2	ATR / BR-2	Water-filled capsule	Advanced fuels	1,2,4,5,6,7,10,11,12,13,14
3	ATR	A _I 0.625"	AM metal	1,2,4,6,7,8,9,14
4	MITR	ICSA 1"	sensors	1,2,3, performance
5	ATR	B _L 1.5" or loop	AM metal	1,2,4,7,9
6	ATR	B _S 0.875"	AM metal	1,2,4,9,13,14
7	ATR	B _S 0.875"	AM metal	1,2,4,10,11,14

Often researchers require parameters within a given tolerance interval. Doses range from ~0 to 6 dpa in these experiments

Rabbit Experiments

Project	Reactor	Position	Material	Parameters
8	ATR	B-7(HSIS) 0.875"	Advanced Fuels	1,2,4,5,6,14
9	HFIR	CFT (HTS) 0.500"	Various SiC materials	1,2,4,6,10
10	HFIR	CFT (HTS) 0.500"	PyC-SiC (TRISO)	1,2,4,14

These experiments cannot have instrument leads connected.

Doses range from ~0 to 2 dpa in these experiments

- HFIR ~ 2dpa in one cycle (25 days)

Nuclear Science User Facilities

INSTRUMENTATION CHALLENGES

Challenge Problem #1

1. **Static Capsule Irradiations (drop-ins) are the most often utilized technique.**

- These are (relatively) inexpensive and (relatively) easy to design.
- What advances can be made in instrumentation that will make these experiments as good as they can be.
- HSIS irradiations have a similar set of issues.

The challenge is to design sensors that can provide real-time data wirelessly, including sensor power supply.



Effects of Temperature



Iron-chromium phase diagram at 8% nickel

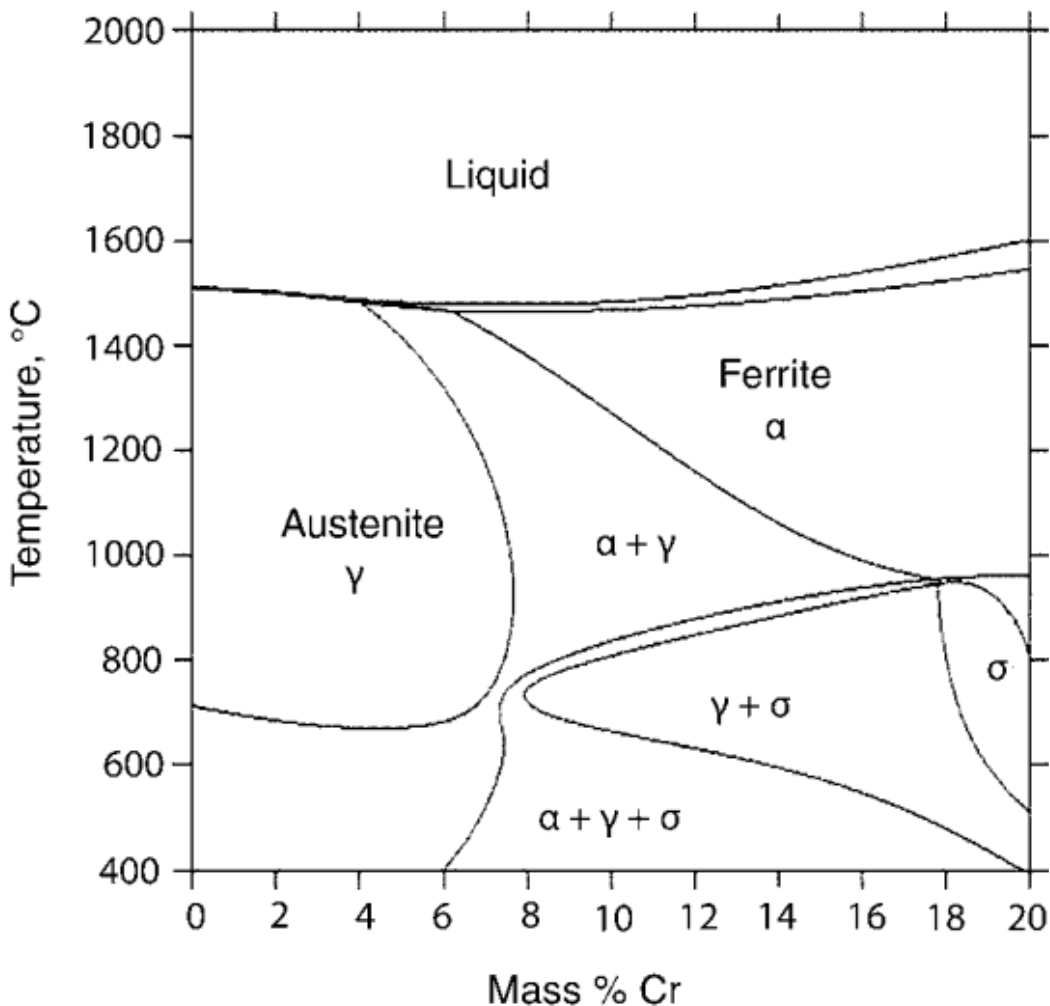

ASTM-Stainless Steel for Design Engineers (2008)

EBR-II CW 316 SS

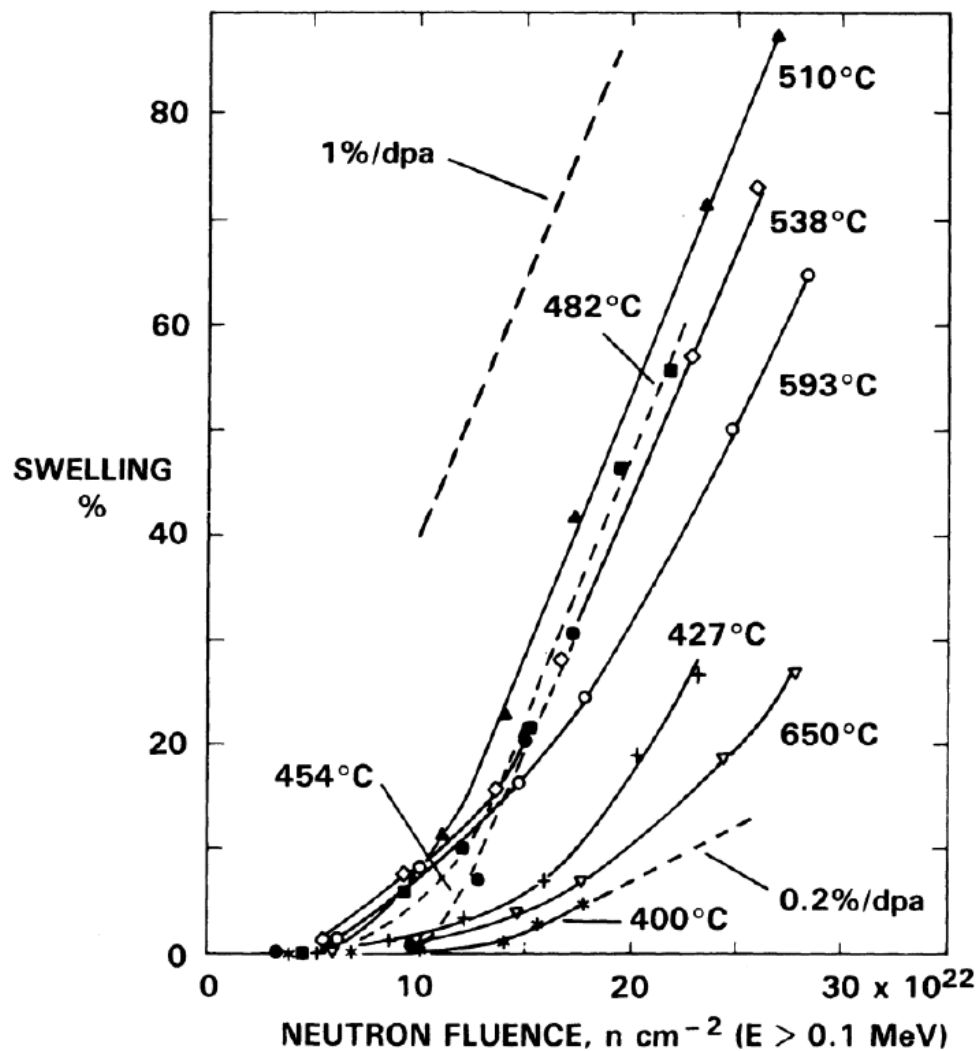

Garner and Gelles (1990)

2. Instrumented Lead Experiments are very expensive (\$4MM)

- They are used because they provide temperature control and live monitoring of irradiation parameters, primarily sample temperature.
- NSUF would like to be able to irradiate capsules from several experiments in a single instrumented lead assembly, each with its own temperature control and suite of sensors.
 - This would reduce the cost per experiment and make the use of this technique more accessible.

Challenge Problem #3

-
- 3. How can NSUF leverage all of the available resources to develop advanced in-pile instrumentation while minimizing the design cycle time and minimize the expenditure?**
- Modeling and simulation / model-based engineering
 - Use of ion beams and smaller RTRs to do initial testing.

Contact Information for NSUF

Brenden Heidrich

(208) 526-8117

Brenden.Heidrich@INL.gov

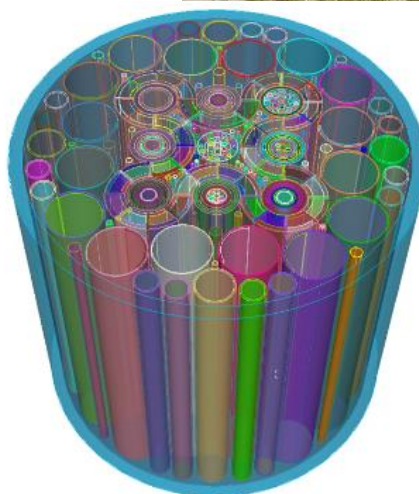
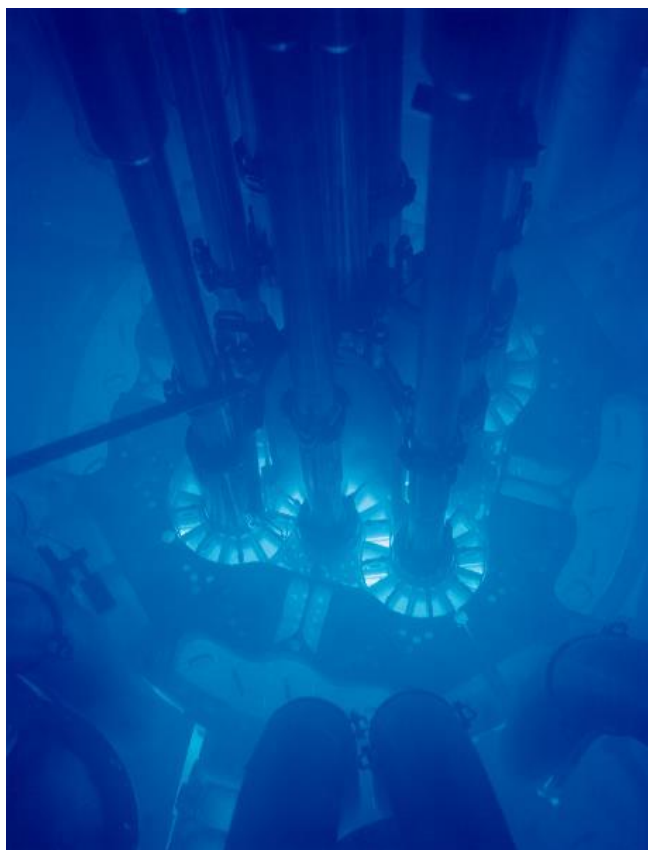
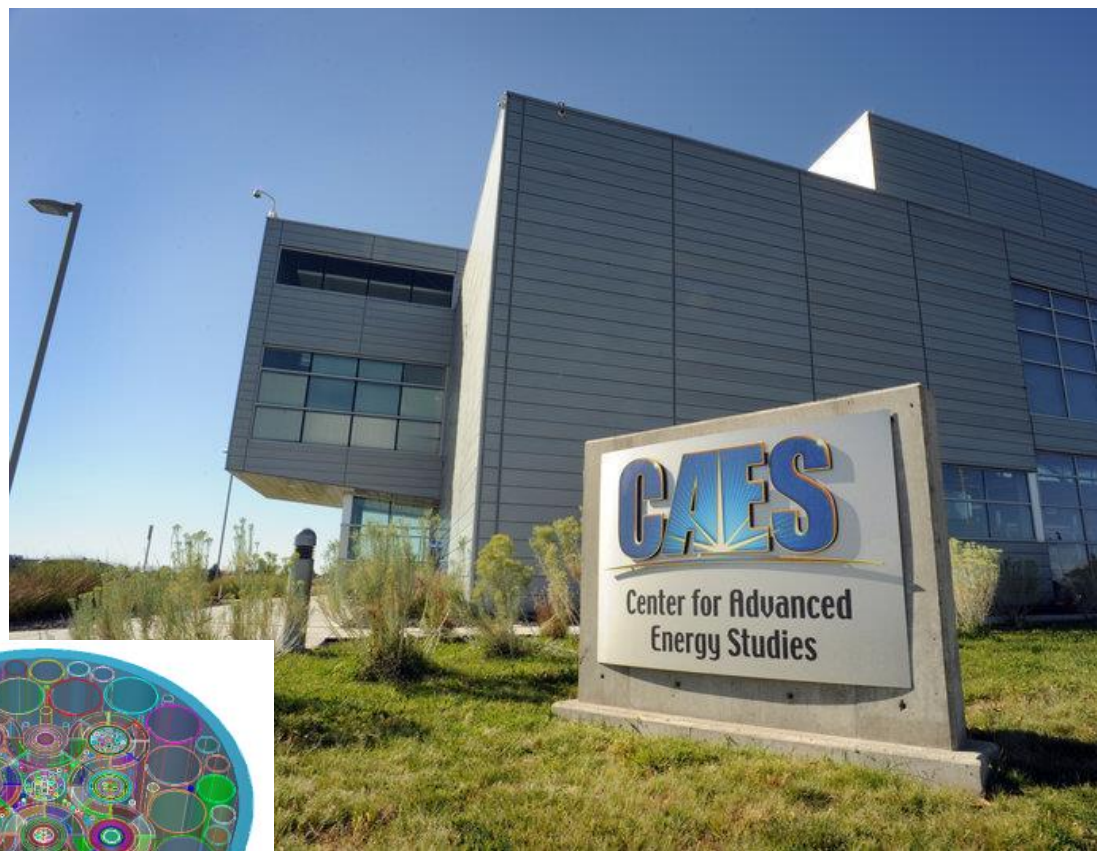

NSUF@INL.gov

NSUF.INL.gov

NSUF-Infrastructure.INL.gov



DISCLAIMER

- This information was prepared as an account of work sponsored by an agency of the U.S. Government.
- Neither the U.S. Government nor any agency thereof, nor any of their employees, makes any warranty, express or implied, or assumes any legal liability or responsibility for the accuracy, completeness, or usefulness of any information, apparatus, product, or process disclosed, or represents that its use would not infringe privately owned rights.
- References herein to any specific commercial product, process, or service by trade name, trademark, manufacturer, or otherwise, does not necessarily constitute or imply its endorsement, recommendation, or favoring by the U.S. Government or any agency thereof.
- The views and opinions of authors expressed herein do not necessarily state or reflect those of the U.S. Government or any agency thereof.



Instrumentation Summary Temperature



Static Capsule/HSIS	Instrumented Lead	PWR Loop	Available at ATR	Available at other MTRs	Developmental
x	x	x	Melt Wires (peak), SiC (range)	Paint spots, thermal expansion devices (TED)	
	x	x	Thermocouples & High-Temperature Irradiation Resistant TCs (HTIR-TC)	Expansion thermometers	Fiber optics, noise thermometry, ultrasonic thermometers

Sensor	Status
Melt Wires	Currently used in several ATR NSUF irradiations. Both quartz and vanadium encapsulation available for wires with melting temperatures between 85 and 1455 °C.
SiC Temperature Monitors	Currently used in several ATR NSUF irradiations.
HTIR-TC	Initial out-of-pile testing completed. In-pile testing (in the first Advanced Gas Reactor (AGR-1) NGNP fuel irradiation test) and sensor enhancement evaluations completed; HTIR-TCs provided to MIT and IFE/HRP. Additional HTIR-TCs being fabricated for NGNP program in FY14.
Ultrasonic Thermometers	FCRD program funded first two years of a three year effort to develop and evaluate an enhanced prototype. Additional funding required to complete prototype evaluations and design optimization. Although prototype is focused on use of magnetostrictive transducers, deployment will benefit from MITR test to compare irradiation-related survivability of piezoelectric and magnetostrictive transducers.

Instrumentation Summary

Irradiation

Parameter	Static Capsule/HSIS	Instrumented Lead	PWR Loop	Available at ATR	Available at other MTRs	Developmental
Neutron Flux & Fluence	x	x	x	Flux wires and foils		
		x	x		Self-powered neutron detectors, miniature fission chambers	moveable SPNDs, micro-pocket fission chambers
Gamma Heating & Flux		x	x		Calorimeters, gamma thermometers, self-powered gamma detectors	

Sensor	Status
Neutron Dosimetry Wires and Foils	Various flux wires and foils available. Vanadium encapsulation available.
SPNDs and fission chambers	Specially-developed fixtures designed, fabricated, and installed at ATRC. In FY13, additional evaluations of detectors completed. Additional ATRC evaluations planned for FY14. In addition, SPND will be included in NEET-funded MITR. Development of MPFDs for ATRC evaluations underway.
Gamma thermometers and SPGDs	Currently used at HBWR; SPGDs will be included in NEET-funded MITR irradiation in FY14.

Instrumentation Summary

Dimensional

Parameter	Instrumented Lead	PWR Loop	Available at ATR	Available at other MTR	Developmental
Dimensional Changes	x	x	LVDT-based elongation	diameter gauge	ultrasonic techniques, fiber optics
Crud Deposition		x		diameter gauge with neutron detectors and TCs	

Parameter	Sensor	Status
Elongation, Crud deposition, Corrosion	LVDTs	Out-of-pile testing completed on developmental LVDT that resists high temperature degradation and eliminates Curie temperature effects.
	Diameter Gauge	Currently used in the Halden Boiling Water Reactor (HBWR) for detecting swelling, corrosion, and crud buildup. Three year LDRD initiated in FY14.
	Ultrasonic Techniques	Scoping tests completed on elongation prototype. Prior to deployment, additional prototype out-of-pile testing needed and results from NEET-funded MITR piezoelectric and magnetostrictive transducer irradiation test needed.
	Fiber Optic Techniques	FCRD funded first two years of a three year effort to develop and evaluate the accuracy of a candidate probe. Prior to deployment, an instrumented lead test needed to evaluate fiber optic survivability in radiation environments.
In-Pile Creep Test Rig	LVDT-based rig with bellows	Design developed and prototype evaluated at PWR conditions in a laboratory autoclave. Enhanced design, with variable load capability, developed and evaluated in a laboratory autoclave. Both designs developed for future use in an ATR PWR loop.

Instrumentation Summary

Parameter	Instrumented Lead	PWR Loop	Available at ATR	Available at other MTR	Developmental
Crack Growth Rate		x		Direct current potential drop technique	
Thermal Conductivity	x	x	Transient Hot-Wire Method Needle Probe	Degradation using signal changes in TCs	
Fission gas (amount and composition)	x	x	on-line sampling, pressure gauge	LVDT-based pressure monitors	acoustic measurements with high-frequency echography

Parameter	Sensor	Status
Crack Growth	DCPD methods with CT specimens	Currently used at HBWR; Investigations initiated in 2012.
	Ultrasonic Techniques	Funding source needed for laboratory evaluations. Prior to deployment, results of piezoelectric and magnetostrictive transducer irradiation test at MITR needed.
	Fiber Optic Techniques	Funding source needed for laboratory evaluations. Prior to deployment, an instrumented lead test needed to evaluate fiber optic survivability in radiation environments.
Thermal Conductivity	Transient Hot-Wire Method Needle Probe	Prototype design developed and initial laboratory testing completed. Prototype THWM probe prepared and shipped to CEA and being prepared for shipment to IFE/HRP.



NSUF Instrumentation Development Plans

