

Amped Up!

Volume 1, No. 6, November/December 2015

IN THIS ISSUE

A Message from Dave.....	2
EERE Unveils New Strategic Plan	3
Grid Modernization Q&A	4
Lab Impact Initiative Hits Milestone.....	5
ENERGY EFFICIENCY SUCCESSES	
Building Technologies	6
Federal Energy Management.....	8
Weatherization & Intergovernmental	9
Advanced Manufacturing	10
TRANSPORTATION SUCCESSES	
Vehicle Technologies	12
Bioenergy Technologies	14
Fuel Cell Technologies	15
RENEWABLE POWER SUCCESSES	
Solar Energy Technologies	16
Wind	18
Water Power Technologies	19
Geothermal Technologies	20
OPERATIONS & STRATEGIC INNOVATION	
Strategic Programs	21
Operations	23

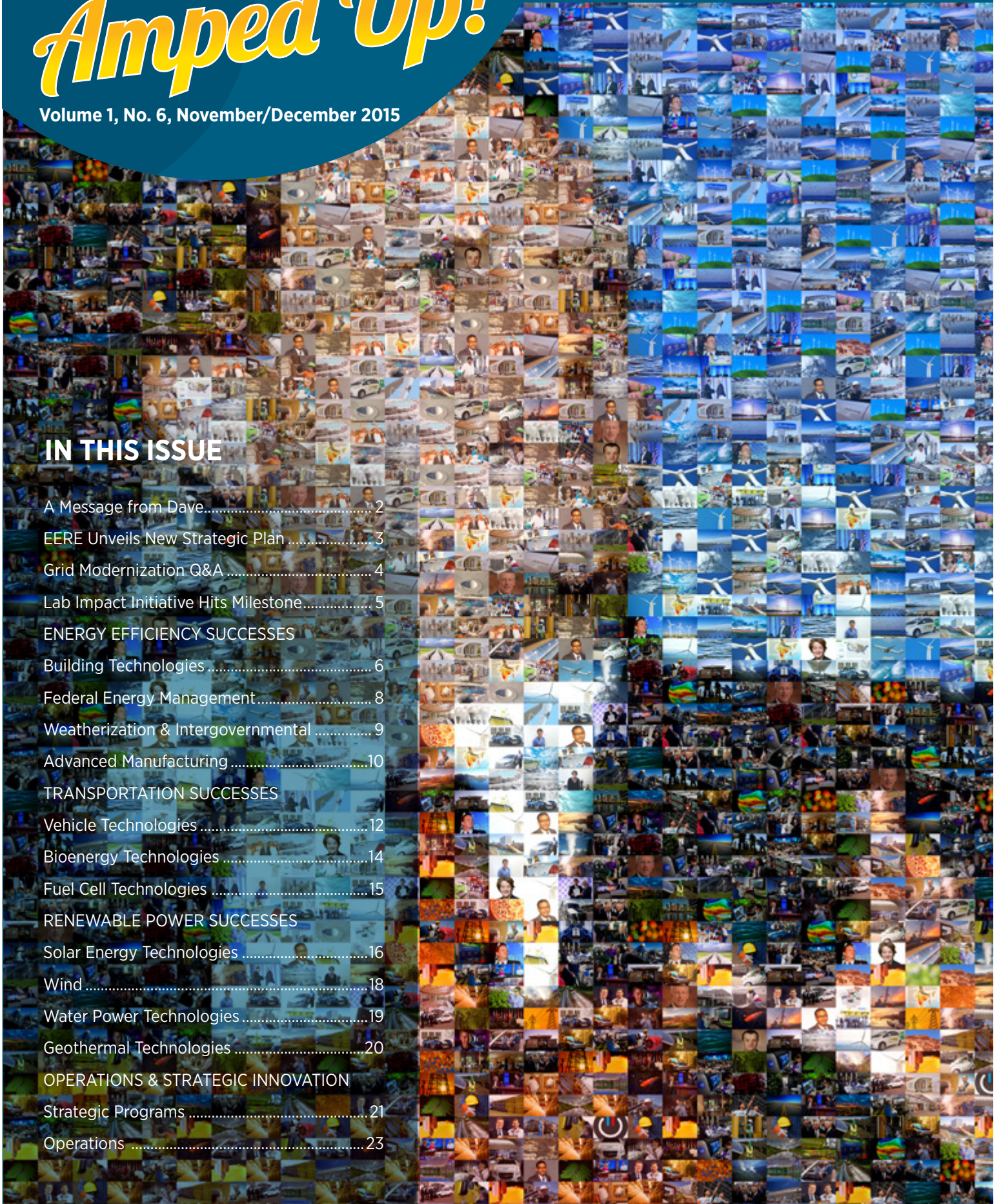

A Message from Dave



Dear EERE Family,

I want to sincerely thank all of you for your hard work over the past year. With your support, EERE's strategic investments are accelerating innovation and the U.S. transition to a clean energy economy – creating new opportunities for American workers across the country. You'll find stories highlighting some of this year's major successes throughout this issue of *Amped Up!*

Each of you play a critical role in these accomplishments. That includes everyone – from those working within our technology offices and programs to our research and development teams at our national labs to the operations and administrative professionals that keep EERE running smoothly and efficiently. We could not do our critical work without all of your contributions.

This moment presents us with exciting opportunities. During the historic climate change summit in Paris this month, President Obama committed to the landmark Mission Innovation initiative to double our country's investments in clean energy research and development over the next five years, alongside 19 other nations from around the world. This pledge is bolstered by a parallel

commitment by the newly formed Breakthrough Energy Coalition – led by Bill Gates and consisting of more than 28 private investors – to significantly increase private investment to commercialize early-stage, game-changing new clean energy technologies.

These public-private coalitions demonstrate the growing global consensus that technological innovation must play a critical role in meeting the climate change challenge – and the awareness that the clean energy economy is an enormous economic opportunity. Even as we work with partners around the globe to tackle the challenge of climate change, our imperative remains outpacing our competitors and serving as a model to the world.

We released our 2016-2020 EERE Strategic Plan in December. The Strategic Plan is our blueprint for how we are going to win the global clean energy race in the critical years ahead of us.

The United States brings enormous strengths in our second-to-none technology innovation ecosystem and our entrepreneurial culture. Our focus now is on applying these advantages to break down the remaining technology and market barriers that still persist for the development, commercialization, and cost-effective deployment of many emerging clean energy technologies. We will continue to drive forward on mission critical initiatives, including our Grid Modernization Initiative, focused on delivering a clean, affordable, resilient, and secure 21st century power grid; our National Lab Impact Initiative focused on enhancing collaboration among brilliant minds in the private sector and our national labs; and strengthening our manufacturing competitiveness and productivity through our Clean Energy Manufacturing Initiative.

At the same time, EERE's leadership team remains absolutely committed to continually making EERE an even greater place to work – one that will foster growing job satisfaction and the continued development and professional growth of the exceptional world-class individuals who make up our team here at EERE.

Thank you for making this world a better place. I wish all of you an enjoyable holiday season with your loved ones. As we head into the New Year, let us resolve to tackle 2016 with a renewed commitment to helping our country make the most of this historic moment.

Dave

Amped Up! is a bimonthly newsletter on the latest developments within EERE and is brought to you by EERE's Communications Office; do not cite or release without prior approval. If you have any suggestions or comments about what you would like to see in this newsletter, please contact eeAmpedUp@ee.doe.gov.

With New Strategic Plan, EERE Unveils Blueprint for U.S. Clean Energy Leadership

Assistant Secretary Dave Danielson and Principal Deputy Assistant Secretary David Friedman unveiled EERE's updated Strategic Plan for 2016-2020 in December. The Strategic Plan was undertaken in response to President Obama's challenge in 2013 at Georgetown University, releasing the Climate Action Plan.

In this speech, the president laid out the national imperative in clear terms:

"A low-carbon, clean energy economy can be an engine of growth for decades to come. And I want America to build that engine," said President Obama. "I want America to build that future – right here in the United States of America. That's our task."

The EERE Strategic Plan – EERE's first since 2002 – provides the blueprint for a U.S. transition toward a clean energy economy in an effort to create American jobs and spur economic growth. It was developed through the tireless efforts of EERE staff and with the help of key stakeholders, both inside of the federal government, and those representing national laboratories, companies, universities, think tanks, and state and local government organizations that are touched by EERE activities. The Strategic Plan supports the U.S. Department of Energy Strategic Plan and is aligned with both the Quadrennial Energy Review and the Quadrennial Technology Review.

Within the Strategic Plan, EERE's vision of "a strong and prosperous America powered by clean, affordable and secure energy," and mission "to create and sustain American leadership in the transition to a global clean energy economy" are presented. A total of seven specific goals are described to accomplish these: three focusing on EERE's primary technology sectors, along with four cross-cutting goals. Each goal is supported by an implementing framework that includes specific strategies and success indicators that can serve to focus and guide EERE progress. Key elements of the Strategic Plan, applicable to each program, will be reflected and incorporated in each technology office's Multi-Year Program Plan.

A January webinar and other follow-on activities are being planned to make sure the Strategic Plan is well communicated to EERE both internally and externally. The goal is for all EERE employees, partners at the national laboratories, and external stakeholders to become thoroughly familiar with the Strategic Plan, and work closely together to achieve the plan's goals. It is only through such a large and coordinated effort that EERE can meet the president's challenge in leading the United States to a prosperous and secure clean energy future.

Read the full [EERE Strategic Plan](#)

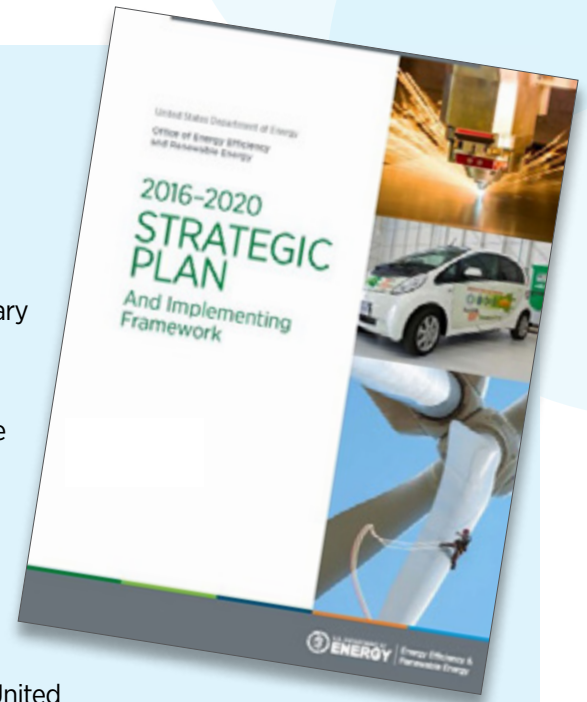

Grid Modernization

As director of the U.S. Department of Energy's [Grid Modernization Initiative](#), Kevin Lynn is the go-to guy on upgrading the U.S. electric grid. Working closely with the Office of Electricity and Energy Delivery, he and his team did some heavy lifting that pushed the unparalleled national integration effort forward on several fronts. They include the release of the first-ever Grid Modernization Lab Call funding opportunity this month, a series of regional workshops to fast-track education and outreach with key stakeholders, and the final Multi-Year Program Plan that will guide U.S. efforts to transform the grid. The *Amped Up!* team spoke with Lynn about the importance of this initiative heading into 2016.



**Kevin Lynn, director,
Grid Modernization Initiative**

“This integration introduces new challenges for the operation of the U.S. power system...it also provides new opportunities to transform our grid into a platform for greater prosperity, growth and innovation.”

What role does EERE play in accelerating America's grid modernization efforts?

EERE has focused on driving down the costs and improving the performance of clean energy technologies. These long-term efforts have helped an array of clean energy technologies become more cost competitive, resulting in a dramatic increase in the number of these technologies being integrated into the electrical power system. Success integrating these technologies at scale will be critical to delivering on the nation's climate and energy goals. This integration introduces new challenges for the operation of the U.S. power system that will require the development and deployment of new tools and technologies to ensure the electrical power system continues to operate in a safe, reliable, and cost-effective manner. However, it also provides new opportunities to transform our grid into a platform for greater prosperity, growth, and innovation.

What are the biggest challenges and opportunities facing the Energy Department and country in modernizing the grid?

Five key trends are driving this transformation that challenge the capacity of the grid to provide us with the services we need. They are:

- A changing mix of electric generation (in particular, distributed and clean energy)

- Growing demand for a more resilient and reliable grid (especially due to weather impacts and cyber and physical attacks)
- Growing supply- and demand-side opportunities for customers to participate in electricity markets
- Emergence of interconnected electricity information and control systems
- Aging electricity infrastructure.

What are the key goals over the next few years for grid modernization?

The technologies and techniques required for successful grid integration include improved approaches to renewable power forecasting; application of energy storage technologies; advanced power electronics; “grid responsive” building technologies; vehicle-to-grid technologies; and new approaches to grid sensing, control, and operations.

Close engagement and collaboration with and among industry, regulators, and other stakeholders also will be needed to develop and deploy the standardized communication and control protocols for these devices to interface and interact successfully – enabling grid operations at the lowest cost possible while maintaining or improving grid reliability.

Lab Impact Initiative Hits Stride at Major Milestone

December marks the two year anniversary for the [Lab Impact Initiative](#), which turns world-class research results in the U.S. Department of Energy's national laboratories into real-world products. Lab Impact successfully launched three pilots during this time and finalized a framework for EERE and the national labs to operate under to spur clean energy innovation.

Guiding Principles

Released in March 2015, the [EERE-National Laboratory Guiding Principles](#) document explains EERE's approach to managing lab projects and programs. It also explicitly states the roles and responsibilities of work units, and maps out a well-informed decision-making process.

Lab-Corps Pilot Graduates First Cohort

Launched in 2014, the [Lab-Corps](#) pilot graduated its first cohort at the [National Renewable Energy Laboratory](#) this November. The \$2.3 million pilot trains the nation's top lab researchers on moving lab technologies into the market, while fostering an entrepreneurial culture at the national labs.

Small Business Vouchers Pilot Launched

The \$20 million [Small Business Voucher \(SBV\)](#) pilot launched in September and received more than 450 proposals in its first round of competition. SBV helps small businesses bring next-generation clean energy technologies to the market faster by teaming them up with the national labs. The labs will provide approximately 100 vouchers, ranging from \$50,000 to \$300,000, to access their facilities and experts. First round winners will be announced in 2016.

Technologist in Residence Pairs Selected

Through the [Clean Energy Manufacturing Initiative](#), EERE announced in September the seven pairs selected to receive \$2.6 million to participate in its [Technologist in Residence \(TIR\)](#) pilot. TIR is designed to strengthen the relationships between the national labs and the private sector (particularly manufacturers), and to identify opportunities for long-term research and development (R&D) collaborations. EERE held a TIR kick-off meeting in December where representatives from

selected national labs and companies, and from across the national lab enterprise, discussed in detail goals and feedback methods for the pilot and began foundational relationship building to help get the pilot's R&D collaborations off to a strong start.



Assistant Secretary Dave Danielson (right) tours Oak Ridge National Laboratory to witness EERE innovation at work.

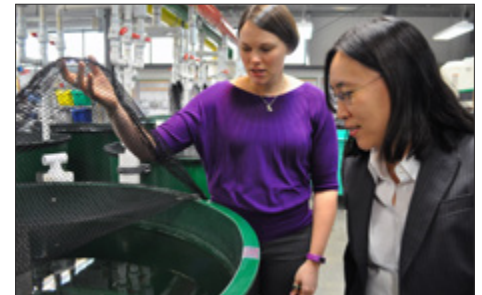

Joyce Yang (right) recently stepped down as Lab Impact director and will support EERE's new Lab Operations team. Victor Kane, previously of the SunShot Initiative, was named new Lab Impact director.

EERE LAUNCHES CEMAC

As part of the [Clean Energy Manufacturing Initiative](#), EERE launched the [Clean Energy Manufacturing Analysis Center \(CEMAC\)](#) in 2015. The center works with industry and academia to deliver credible, timely, reliable analyses in clean energy technology supply chains, global trade flows, and factors that drive manufacturing strategy. In June, CEMAC published its [first branded report](#), which is providing EERE, industry, and policymakers with an objective look at the factors affecting lithium-ion battery manufacturing investments.

CEMAC's analysis is already influencing [other clean energy manufacturing technology areas](#). For example, JP Morgan Asset Management, one of the top asset funds in the world, most recently used CEMAC's bottom-up methodology on utility-scale photovoltaic capital costs for its [annual energy paper](#) – demonstrating both CEMAC's immediate importance for industry decisions and its impact in the transition to the clean energy economy.

CEMAC is a collaboration across the national laboratories and is directed from the [National Renewable Energy Laboratory](#) by the [Joint Institute for Strategic Energy Analysis](#).

Kathleen Hogan

Deputy Assistant Secretary for the Office of Energy Efficiency

The best offense is a great defense. And energy efficiency is the best offense for defending against climate change. I'm confident in the talent of our organization to continue to find solutions through innovation, voluntary partnerships, and regulatory standards that will result in savings and other societal benefits to the American homeowner, manufacturers, and state and local governments. Together, we can make significant progress in the President's target announced at COP21 in Paris – that America will reduce its emissions 26-28% below 2005 levels within 10 years. And energy efficiency is a proven strategy to get us there, while growing America's economy.



Building Technologies Office Highlights



More than 37,000 grocery stores nationwide can benefit from Solstice N40.

ERE is at the forefront of a major shift toward high efficiency and low global warming potential (GWP) technologies. The [Building Technologies Office \(BTO\)](#) funded research between the [Oak Ridge National Laboratory \(ORNL\)](#) and Honeywell to commercialize Solstice N40, a low-GWP refrigerant that reduces green-

house gas emissions by 67% and cuts energy consumption by 10%.

Solstice N40 is a non-toxic hydrofluoroolefin-based alternative to R-404A, the most common refrigerant used in U.S. supermarket refrigeration systems. R-404A contains hydrofluorocarbons (HFCs), which are strong greenhouse gases. By using Solstice

N40 as a drop-in replacement refrigerant, more than 37,000 grocery stores nationwide can now benefit from greater energy savings, while reducing the threat of greenhouse gases at a minimal cost.

In addition, an interagency group led by the White House called on BTO to perform a testing program that evaluated the performance of several low-GWP alternative refrigerants that could replace HFCs. In under six months, BTO worked with ORNL to establish the testing program, organize an international panel of technical experts, and produce a report that demonstrated several viable low-GWP replacements. This new information could lead to an amendment that would phase down HFCs globally. According to BTO, with strong international action on HFCs, the world can avoid up to 0.5°C of warming by the end of the century.

ENERGY EFFICIENCY

Next Generation HVAC Systems

BTO is also making a push toward a new generation of technologies that can operate with zero-GWP cooling fluids such as water. In Fiscal Year (FY) 2015, BTO invested nearly \$8 million to develop advanced vapor compression and non-vapor compression heating, ventilating, and air conditioning (HVAC) technologies.

Advanced vapor compression systems use highly-efficient versions of the technologies that currently drive HVAC systems, but use refrigerants that have a minimal effect on the environment. Non-vapor compression systems employ new technologies that use refrigerants that won't harm the environment.

Non-vapor compression HVAC systems have the potential to use 40% less energy than current systems.

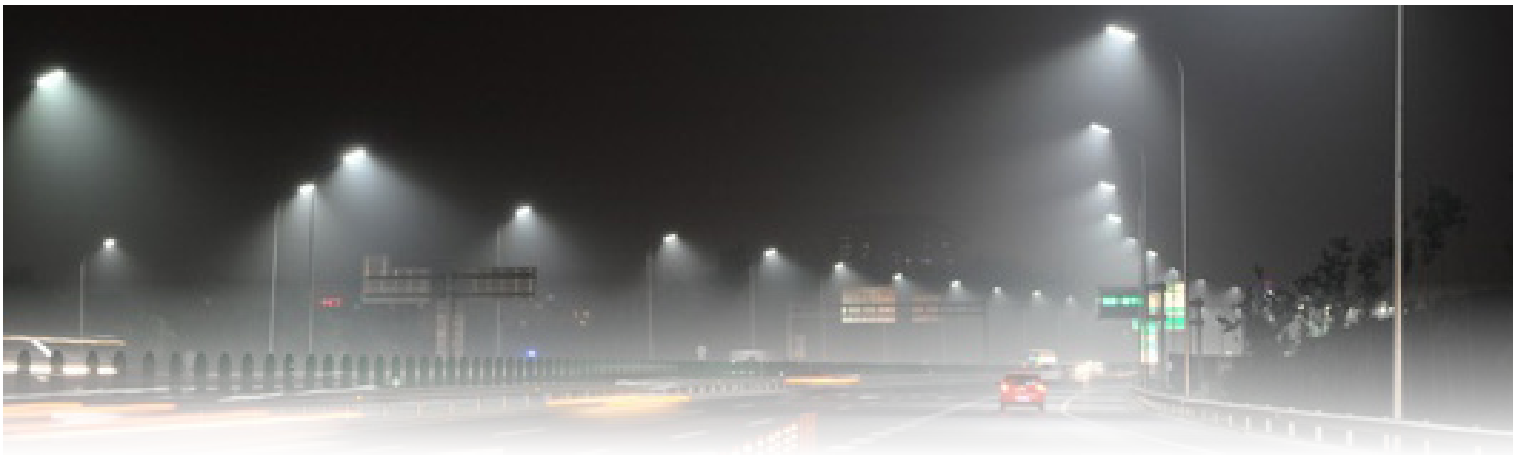
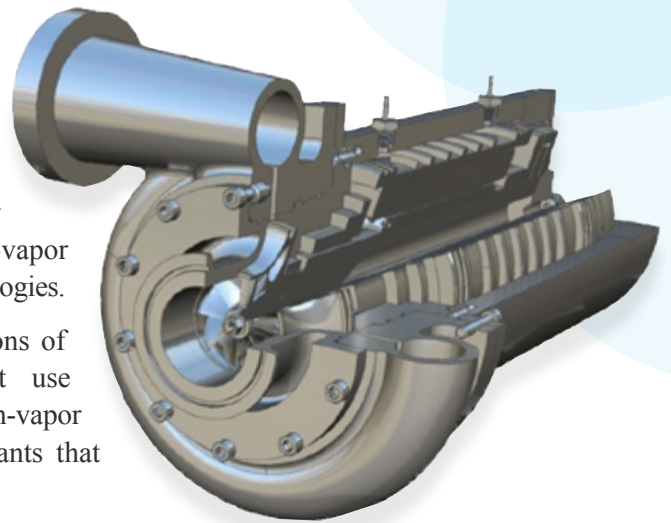

Smart Campaign Adoptions

Through the [Better Buildings Alliance](#), the U.S. Department of Energy is working with industry to adopt and install the most efficient and impactful technologies in America's buildings and facilities. These campaigns accelerate market adoption and spur carbon savings nationwide by providing recognition for technological innovation, as well as the organizational action taken to promote upgrades and replacements.

Lighting Energy Efficiency in Parking (LEEP) Campaign	The Advanced Rooftop Unit Campaign (ARC)	Interior Lighting Campaign (ILC)
<ul style="list-style-type: none"> • 140 partners • Installing efficient lighting across more than 470 million square feet of parking space • \$3 million savings annually 	<ul style="list-style-type: none"> • 190+ partners • Replaced/Retrofitted 40,000 high-efficiency commercial building rooftop units • \$37 million total saved since 2014 	<ul style="list-style-type: none"> • 65+ partners • Launched in May 2015 • Goal to replace one million indoor troffers

ENERGY EFFICIENCY

Better Buildings Challenge

More than 250 [Better Buildings Challenge \(BBC\)](#) partners saved a total of \$840 million in energy costs since the program’s launch in 2011. On average, BBC partners are achieving two percent energy savings each year and are on track to meet their energy savings goals of 20% over 10 years. Combined, BBC partners cut energy use by 94 trillion British thermal units, avoiding six million tons of carbon emissions – the equivalent of one million cars.

BY THE NUMBERS:

- 250+ commercial, industrial, and multifamily partners
- Represent 3.5 billion square feet of commercial building space
- 650 manufacturing facilities
- 50 cities and states
- \$5.5 billion in financial commitments from the private sector



50 cities and states, including Boston, Massachusetts, participate in the Better Buildings Challenge.

BETTER PLANTS

The [Better Plants](#) program has grown in participation, scope, and impact. Over the last year, the program welcomed 21 new partners, including 12 through its expansion into the water and wastewater treatment sector. Through Better Plants, the U.S. Department of Energy is also starting initiatives to improve water efficiency and promote supply chain energy management.

BY THE NUMBERS:

- 160 manufacturers across 2,400 manufacturing facilities
- Represent 11.4% of the total U.S. manufacturing energy footprint
- Avoiding 26.6 million metric tons of carbon

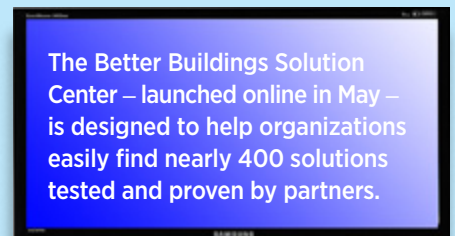

The Better Buildings Solution Center – launched online in May – is designed to help organizations easily find nearly 400 solutions tested and proven by partners.

Federal Energy Management Program Office Highlights



Principal Deputy Assistant Secretary David Friedman speaks at the Energy Exchange in Phoenix.

ENERGY EXCHANGE

The [Federal Energy Management Program \(FEMP\)](#) held its first annual Energy Exchange training event in Phoenix, Arizona in August. The training provided critical knowledge to more than 1,600 attendees working to improve facility performance, advance the use of renewable energy, and reduce greenhouse gas emissions at federal sites. The event featured 90 training sessions in 10 tracks, covering cost-effective best practices and information about cutting-edge, energy-efficient technologies. The sessions were led and moderated by subject

matter experts in project and policy implementation.

DATA CENTER CHALLENGE

As part of the Energy Department’s Better Buildings Challenge (BBC), FEMP added the new Data Center Accelerator in January 2015. Under this program, BBC partners commit to reducing the energy use of at least one data center (IT load ≥ 100 kilowatts) by 25% or more within five years. The accelerator continues to grow with 29 partners and more than 150 megawatts committed.

ENERGY EFFICIENCY

Weatherization and Intergovernmental Programs Highlights

The Weatherization Assistance Program (WAP) released the results of a national evaluation of program operations in August 2015. The Retrospective Evaluation addressed cost-effective energy savings to American families, health and safety benefits, along with job creation and stability for program year 2008. The Recovery Act Evaluation reports on these findings for program year 2010. Both evaluations demonstrate that [WAP is a cost-effective program](#).

WAP is the nation’s largest, whole-house energy efficiency program that provides core program funding to all 50 states, the District of Columbia, Native American Tribes, and five U.S. territories to provide weatherization services for low-income families – particularly the elderly, people with disabilities, and families with children. Since 1976, the program has weatherized more than seven million homes.

[More on WAP’s national evaluation.](#)

ALASKA COMPETITION

EERE and the Office of Indian Energy [announced a new \\$4 million initiative](#) in September to help Alaskan communities develop clean, affordable and reliable energy options. [President Obama announced this competition as one of several new commitments](#) to respond to the unique climate challenges facing remote Alaskan communities. The Remote Alaskan Communities Energy Efficiency Competition is designed to empower these communities to develop and implement affordable, clean and energy efficient solutions that are applicable throughout rural Alaska and potentially other Arctic regions.



National Evaluation Results: Benefits from the Weatherization Assistance Program		
Summary of Benefits	Retrospective (2008)	Recovery Act (2010)
<i>Program Wide Benefits for All Housing Types</i>		
Total Homes Weatherized	98,000	340,000
Average Cost to the Energy Department per Weatherized House	\$2,300	\$6,000
Savings per Household (Present Value)	\$4,200	\$3,200
Energy Savings (Present Value)	\$340 million	\$1.1 billion
Total Benefits Including Health & Safety	\$13,550	\$13,170
Jobs Supported	8,500	28,000
Carbon Reduction	2.24 million metric tons	7.38 million metric tons

State Energy Program

The [State Energy Program \(SEP\)](#) selected [11 states](#) in September for \$5 million in competitive funds to advance innovative approaches for local clean energy development. SEP provides funding and technical assistance to state and territory energy offices to help them advance their clean energy economy while contributing to national energy goals. (Photo courtesy of National Renewable Energy Laboratory)



ENERGY EFFICIENCY

Advanced Manufacturing Office Highlights

3D PRINTED SHELBY COBRA

2015 began with the national debut of a fully-functioning, 3D printed replica of an all-electric vehicle that is three times stronger and half the weight of the original. To mark the 50th anniversary of the Shelby Cobra, EERE partner [Oak Ridge National Laboratory \(ORNL\)](#) produced 500 pounds of car parts using a first-of-its-kind Big Area Additive Manufacturing (BAAM) machine in six weeks – roughly one tenth the time of conventional production. The process used less than half the amount of energy currently required to make these car parts.

[EERE's Advanced Manufacturing Office \(AMO\)](#) partners with ORNL on a number of emerging clean energy technologies that could go commercial within the decade – like wireless charging, energy absorption, printed power electronics, and new drivetrains.

The additive manufacturing process, and particularly BAAM, is enabling rapid innovation in transportation. For instance, BAAM could revolutionize production of new model prototypes. While new designs today are demonstrated as clay models – the same way they made them 40 years ago – the BAAM machine could allow manufacturers to print out a working prototype vehicle in weeks and get real-time response to style while testing for form, fit, and function. Additionally, BAAM technology can produce a 3D printed vehicle mold in about two days, instead of months, cutting costs by hundreds of thousands of dollars.

The 3D printed Shelby Cobra demonstrates the enormous potential of additive manufacturing.



IACMI

In January, President Obama announced the new [National Composites Manufacturing Institute \(IACMI\)](#), led by the University of Tennessee. This \$259 million public-private partnership connects the world's leading manufacturers across the supply chain with universities and national laboratories that are pioneering advanced technologies in composite development and research. The initiative also promotes widespread use of advanced fiber-reinforced polymer composites – a material lighter and stronger than steel – for use in vehicles, wind turbines, compressed gas storage, and other advanced manufacturing processes. The effort aims to reduce the amount energy used to make composites by 75% and enable recycling of composites by more than 95% within the decade.

EERE'S MANUFACTURING DEMONSTRATION FACILITY

Two standout industry partners reduced their energy load and greenhouse gas emissions this year through EERE investments. Honeywell introduced advanced manufacturing components for aerospace with a proprietary technology they developed at the [Manufacturing Demonstration Facility \(MDF\)](#), established at ORNL. Honeywell is the first company to use electron beam melting to produce their aerospace parts from high-temp Inconel alloy. In partnership with ORNL and the MDF, industry partner Cummins fabricated the world's largest high-speed diesel engine, called the Hedgehog.



Cummins' Hedgehog is the world's largest high-speed diesel engine.

Showcasing EERE Clean Energy Leadership at COP21

by Mekell Mikell,
Stakeholder Engagement

In December, U.S. Department of Energy Secretary Ernest Moniz and several distinguished U.S. policymakers and international dignitaries attended the 21st Conference of the Parties (COP21) to the United Nations Framework Convention on Climate Change, in Paris, France. The Secretary highlighted the Energy Department's global leadership in advancing low carbon technologies. He also emphasized the importance of utilizing international collaboration through the [Clean Energy Ministerial](#) to find solutions that combat global climate change.

The Energy Department sponsored booths throughout COP21. A number of international figures and public and private sector stakeholders toured EERE's innovations, including:

- U.S. Secretary of Agriculture Tom Vilsack
- U.S. Ambassador to France and Monaco Jane Hartley
- NOAA Administrator and Under Secretary of Commerce for Oceans and Atmosphere Kathryn Sullivan
- West Palm Beach Mayor Jeri Muoio
- State Department Under Secretary of State for Economic Growth, Energy & Environment Catherine Novelli
- French Minister of Foreign Affairs and International Development Laurent Fabius
- South African Parliament Member Robert Alfred Lees
- Minister of Environment for the Republic of Albania Lefter Koka

Seven U.S. lawmakers joined Secretary Moniz to tour a showcase of EERE



U.S. Senator Ben Cardin and Secretary Moniz visit La Galerie, Paris, where U.S. innovation was on display. View additional resources and highlights at [EERE's COP21 website](#).

supported and developed clean energy solutions at the climate conference. Senators Ben Cardin, Cory Booker, Al Franken, Edward J. Markey, Jeff Merkley, Chris Coons, and Tom Udall viewed the electric 3D printed Shelby Cobra and the Natel Energy Schneider Linear hydroEngine. The senators saw the power and commercial application of EERE technologies and research and learned how those innovations connect to their states and the global clean energy economy.

During COP21, President Obama and world leaders also announced [Mission Innovation](#) – an effort to dramatically accelerate clean energy investment in the next five years. The initiative aims to address global climate change, provide affordable clean energy to consumers and create additional commercial opportunities in clean energy.

France's Minister of Foreign Affairs Laurent Fabius gets a tour of the 3D printed Shelby Cobra, an electric vehicle.



In Paris, EERE participated in the USA Pavilion that featured a 3D printer demonstration, among other EERE innovations.

Reuben Sarkar

Deputy Assistant Secretary for Transportation

I'm looking forward to more great things from the Vehicles Technologies Office and the EV Everywhere team in 2016. I am also really excited to see the Fuel Cell Technologies Office develop and launch their ElectroCat consortium for PGM-Free Catalysts and membrane electrode assemblies as part of the new Energy Materials Network. And in Bioenergy we have a major new funding opportunity announcement (FOA) on integrated biorefineries for drop-in biofuels to help revitalize our Demonstration and Market Transformation portfolio; the team spent a lot of time in the second half of 2015 putting together a great multi-year strategy and we're really excited to put the first FOA out on the streets next quarter.



SuperTruck Project Sets New Record



The Daimler Trucks North America SuperTruck gets 12.2 miles per gallon freight efficiency.

The [Vehicle Technologies Office's](#) (VTO's) SuperTruck project set another freight efficiency record for Class 8 tractor trailers for the second consecutive year.

In March, the [Daimler Trucks North America](#) team achieved 12.2 miles per gallon freight efficiency, which includes both fuel used and weight hauled. This milestone marks a 115% increase in freight efficiency over typical Class 8 trucks, which normally average 5.8 miles to the gallon.

Daimler Trucks is the second SuperTruck team to exceed the original initiative goal to boost freight efficiency 50% over baseline tractor trailers by 2015. The Cummins and Peterbilt team earlier broke the goal in 2014 with its 10.7 miles-per-gallon long-haul truck.

The SuperTruck project originally started in 2009 when EERE competitively awarded four freight vehicle manufacturers funding. All four teams focused on integrating advanced combustion engines, aerodynamics, vehicle systems,

and lightweight materials to boost Class 8 truck efficiency, increase energy security, and lower carbon pollution.

In 2016, technical managers will work with the Navistar and Volvo teams on separate project schedules; both of them are on track to meet the goal.

For the next phase of the project, SuperTruck II, the U.S. Department of Energy requested \$40 million in FY16 to research, develop and demonstrate technologies to improve the freight efficiency of heavy-duty Class 8 long-haul vehicles by 100% by 2020 compared to 2009 vehicles as well as demonstrate applicability to regional-haul vehicles.

Currently, Class 8 trucks haul as much as 80% of the nation's goods and use about 20% of the fuel consumed in transportation. If all Class 8 trucks in the United States used SuperTruck technologies, the country would consume nearly 300 million fewer barrels of oil and spend nearly \$20 billion less on fuel each year.

TRANSPORTATION

Partnerships Spotlight Electric Vehicle Growth

New partnerships between the U.S. Department of Energy, utilities and other key stakeholders are expected to expand the national conversation on transportation electrification, leading to quicker adoption of plug-in electric vehicles by U.S. consumers.

In June, Energy Department Secretary Ernest Moniz announced a memorandum of understanding known as the [EV Everywhere Utility Partnership](#) with the Edison Electric Institute – the largest association of utilities in the country. The partnership is part of the [EV Everywhere Grand Challenge](#), which aims to have the United States become the first nation in the world to produce plug-in electric vehicles that are as affordable for the average American family as 2012’s gasoline-powered vehicles by 2022.

Similarly, in November, EERE [signed a memorandum of understanding](#) with the Northeast States for Coordinated Air Use Management (NESCAUM) that provides for collaborative federal and state efforts in six keys areas where action is needed to expand the electric vehicle (EV) market. Under

the agreement, EERE and NESCAUM will pursue complementary workplace charging initiatives, collaborate on studies demonstrating the positive economic impacts of transportation electrification, address barriers to EV adoption by state fleets, plan locations for future EV charging stations, and coordinate a nationwide education and outreach campaign.

Both of these partnerships are part of a wider effort by Energy Department leaders to expand collaborative efforts to promote the economic, environmental and national security benefits of electric transportation. In October, EERE Assistant Secretary Dave Danielson gave keynote remarks on the Grid Modernization Initiative and EV Everywhere at the American Public Power Association’s Public Power Forward Summit in Alexandria, Virginia. At the session, he encouraged public power providers to attend upcoming national workshops with Energy Department grid modernization experts to better understand how plug-in electric vehicles impact the grid.

Since 2011, more than 20 plug-in electric vehicle models have entered the market or are coming soon.

VTO ALLIANCES POWER PROGRESS

Partnerships are at the heart of VTO’s work—driving innovation, technology development, and market adoption. This fall, U.S. DRIVE held its biannual All-Tech Team Meeting in Troy, Michigan. This event brought together all 14 of the partnership’s technical groups spanning advanced combustion engines and emission control; batteries; fuel cells; electric drive systems; vehicle systems; and fuel pathways.

During the session, Deputy Assistant Secretary for Transportation Reuben Sarkar shared his vision for EERE’s Sustainable Transportation portfolio especially key initiatives EV Everywhere, H₂USA, Optima (optimizing fuels and engines), the Energy Materials Network, and SMART Mobility.

VTO collaborates with industry on light-duty vehicles through the [U.S. DRIVE partnership](#) and medium- and heavy-duty vehicles through the [21st Century Truck partnership](#). Both focus on sharing pre-competitive technical information among partners, providing a forum to discuss research and development needs, develop joint goals, and evaluate progress. Through this discussion, the groups help ensure that publicly-funded research delivers high-value results.



Bioenergy Office Highlights



EERE investments enabled research at DuPont's new cellulosic ethanol facility.

DUPONT

DuPont's newest facility is the world's largest cellulosic ethanol biorefinery and the fourth of its kind in the United States. The Nevada, Iowa plant opened October 30 and will be using biofuel conversion technology developed in part through early U.S. Department of Energy investments.

With EERE funding in the early 2000s, DuPont and the National Renewable Energy Laboratory collaborated on pretreatment and fermentation processes to create cellulosic ethanol from cellulosic sugars in the non-food parts of the plant called corn stover (husks, stalks, and leaves). Investments of \$51 million from EERE's [Bioenergy Technologies Office \(BETO\)](#) enabled the research. DuPont then constructed the new facility independent of Energy Department funding.

The biorefinery has an estimated production capacity of 30 million gallons of cellulosic ethanol per year that can be used to make an ethanol-petroleum gasoline blend. Through a partnership between DuPont and Proctor and Gamble, some of the cellulosic ethanol from this plant will also be used in laundry detergent.

DuPont indicated that the biorefinery has already provided an economic boost to this rural area, with 1,000 construction jobs, 85 jobs for plant operators, and 150 additional workers to collect, transport, and store the feedstock. With a commitment to buy local, DuPont also extends a market for farmers within a 30-mile radius of the plant.

HARVESTING TECH GOES COMMERCIAL

The process to harvest and transport biofeedstocks—which are a significant cost for a biorefinery—secured a great gain in 2015 with the self-loading trailer. Through EERE investments, project partners created this technology, which is capable of lifting an entire load of 36 stacked bales of corn husks, stalks, and leaves all at once. This innovation cuts loading time by about two thirds and enables the private sector to pass along more competitive prices for their end-products: biofuel, electricity, and chemicals. As production prices drop through improved efficiencies, BETO is nearing its goal of making next-generation biofuels economically viable.



The self-loading trailer could substantially reduce the cost of gathering biofeedstocks.

RENEWABLE JET FUEL SECURES INTEREST FROM PRIVATE INDUSTRY



Cathay Pacific entered into a long-term agreement to purchase renewable jet fuel from Fulcrum Bioenergy.

To meet the administration's near-term greenhouse gas reduction targets for both the aviation industry and military, EERE is investing in scale-up of [renewable jet fuel](#) production. This year, four companies signed agreements with EERE's biorefinery partners. FedEx and Southwest Airlines agreed to purchase fuel from Red Rock Biofuels,

which plans to construct a biorefinery in Oregon to produce renewable jet, diesel, and naphtha fuel from forest residues. United Airlines announced a \$30 million investment in Fulcrum Bioenergy, which will construct a biorefinery in Nevada to produce jet fuel from municipal solid waste. Fulcrum also received a long-term jet fuel supply agreement from Hong Kong-based airline Cathay Pacific.

TRANSPORTATION

FCEVs Moving to Market

Fuel cells generated major headlines and excitement in 2015 as automakers delivered fuel cell electric vehicles (FCEVs) to customers in select locations around the world. Commercial leases were introduced in the United States this year and originally started in Japan in 2014. Hyundai and Toyota are currently leasing their FCEV models in both locations, with Toyota's Mirai now for sale. Honda also announced plans for commercial FCEVs in the spring.

EERE has been researching and developing the technology needed to make FCEVs a viable transportation option for the American public since the 1970s. U.S. Department of Energy-funded research has cut the cost of automotive fuel cells in half since 2006.

Fuel cells produce electricity and heat as long as fuel—in this case, hydrogen—is [pumped into your vehicle](#), just like you would with gasoline. FCEVs can be driven more than 300 miles on one tank of hydrogen and refueling takes less than five minutes.

Watch [Energy Secretary Ernest Moniz drive the Toyota Mirai](#) and [EERE Assistant Secretary Dave Danielson](#) drive the Hyundai Tucson on the streets of Washington, D.C. earlier this year.



Hyundai Tucson



Toyota Mirai

FUEL CELL CARGO TRUCKS

Thanks to research and development funding from the Fuel Cell Technologies Office, the Federal Express Hub at the Memphis International Airport in Tennessee is boasting a 15-vehicle fleet of hydrogen fuel cell powered ground support equipment. The two-year vehicle demonstration kicked off in April and is part of the world's first zero-emissions ground support fleet in the world. The project is expected to save more than 175,000 gallons of diesel fuel and 1,700 metric tons of carbon dioxide.



Fuel cell powered ground support equipment

H₂USA

H₂USA has grown to more than 40 members, including automakers, federal agencies, the fuel cell trade association, hydrogen providers, fuel cell developers, and national laboratories. The H₂USA public-private partnership was created to overcome the hurdles to expanding the nation's hydrogen fueling infrastructure and to enable the large-scale adoption of fuel cell electric vehicles.

EERE Principal Deputy Assistant Secretary David Friedman recently attended an event at the La Cañada Flintridge hydrogen station in California and spoke with the station owner and real life FCEV drivers.



Douglas Hollett

Deputy Assistant Secretary for Renewable Power

In the coming year, renewable power will continue to shape the future of energy in America through a broad array of exciting projects. The team will advance the development of offshore wind technologies through its demonstration portfolio, select finalists in the pioneering Frontier Observatory for Research in Geothermal Energy project, and publish a landmark study on hydropower. We will build on the momentum of the Grid Modernization Initiative through targeted research and development funding supported by a completed Multi-Year Program Plan, and develop new metrics and a roadmap for solar energy technologies through 2030.



U.S. Solar Manufacturing Boom Brings Jobs

Several solar manufacturers in the United States announced expansions in 2015, reversing a decade-long decline in U.S.-based solar photovoltaic manufacturing. Their growth will ultimately lead to more than two gigawatts of solar production and the creation of more than 2,100 jobs across the country. Four of these manufacturers were supported through [SunShot Initiative](#) funding.



Suniva employee doing quality assurance testing at its Georgia headquarters. Source: Suniva

Suniva

Suniva, a manufacturer of high-efficiency crystalline silicon solar cells and modules, will expand its headquarters in Norcross, Georgia, growing its manufacturing capacity to 400 megawatts and creating 500 jobs. Suniva grew out of U.S. Department of Energy-funded research at the University Center of Excellence for Photovoltaics at the Georgia Institute of Technology.

Suniva opened a second manufacturing facility in Saginaw, Michigan last year and created 350 jobs.

SolarWorld

SolarWorld, the largest solar panel manufacturer in the U.S., is expanding its Hillsboro, Oregon facility. The expansion will create 200 jobs in the state's fifth-largest city, located 20 miles west of Portland.

1366 Technologies

1366 Technologies, a manufacturer of silicon wafers, is building a new manufacturing plant in upstate New York that will produce 1,000 new solar jobs. The company also received support from the [Advanced Research Projects Agency -Energy](#) and the [Loan Programs Office](#).

SolarCity

SolarCity is building a one gigawatt capacity factory in Buffalo, New York using technology developed by SunShot awardee Silevo, which SolarCity recently acquired. The technology will enable a reduction in capital costs for high-volume domestic manufacturing, reducing wafer-to-cell conversion costs by adapting plasma-enhanced chemical vapor deposition tools used by the flat panel display industry.

RENEWABLE POWER

Sekaric Sets Sights on SunShot Mission



Lidija Sekaric, acting director, Solar Energy

▶ Click here to view a video

Dr. Lidija Sekaric is the new acting director of the [Solar Energy Technologies Office \(SETO\)](#). She replaces Minh Le, who is on detail to the Office of Management and Budget after six years of service with the U.S. Department of Energy.

Prior to joining SETO, Sekaric served as a senior adviser in the Office of the Under Secretary of Energy and as a technical and market adviser on the some of the world's largest distributed solar generation projects. She has authored more than 40 scientific publications, holds 30 U.S. patents, and has developed record-setting devices in nanophotonics, electronics, nanomechanics, and sensors.

LE MOVES TO OMB

In his new post, Minh Le serves as a senior adviser at the White House's Office of Management and Budget, focusing on developing and advancing clean water technologies. As director of SETO, Minh Le oversaw the creation of the [SunShot Initiative](#), which aims to make solar energy cost competitive with traditional energy sources before the end of the decade.

Under his leadership, SunShot funded more than 350 projects spanning a broad array of solar technologies to accelerate the nation's solar energy goals. These investments and industry advances have driven innovations to make solar generated electricity cost competitive with traditional energy sources in 14 states across the country.



Minh Le is now a senior adviser at the Office of Management and Budget



SETO CATALYST PRIZE

The SunShot Initiative recently announced seven winners of its second Catalyst prize Demo Day in December. A total of 12 startup companies have now earned \$30,000 each in seed funding since the [Catalyst prize program](#) launched in May 2014. The Catalyst program recently won the Challenge.gov [Edison Innovation Award](#) for its work in accelerating the development of solutions and startups in the U.S. solar marketplace.

Solar Ready Vets

More than 100 transitioning military service members and veterans have graduated from the [Solar Ready Vets](#) pilot program with two more classes set to graduate soon. Every single graduate from Solar Ready Vets has received at least one job offer from a solar company.

▶ Press the play button to view video



RENEWABLE POWER

Wind Buoy Deployed



In September, EERE hosted [one of two WindSentinel buoys](#) outside Energy Department headquarters in Washington, D.C., temporarily on display before heading north, where it is now deployed off the coast of New Jersey.

To better gauge domestic wind energy potential, EERE deployed two highly-instrumented resource characterization buoys in 2015 to provide long-term offshore wind profile data. The data collected from the WindSentinel buoys will help guide U.S. Department of Energy [investments in](#)

[offshore wind development](#) – a priority of EERE’s [Wind & Water Power Technologies Office \(WWPTO\)](#) in 2016 and going forward. Measuring 20 feet long and weighing more than seven tons, the buoys are equipped with LiDAR technology – a cutting-edge remote sensing device that uses light in the form of a

pulsed laser to model wind currents for turbines up to 650 feet tall. The buoys were acquired by EERE from AXYS Technologies and are designed to be deployed in open oceans, lakes and rivers.

With a [technical resource potential](#) of 4,000 gigawatts (GW) in state and federal waters along America’s coastlines and Great Lakes, offshore wind power represents a substantial opportunity to generate electricity near coastal, high-density population centers. This abundant resource blows stronger and more consistently than land-based wind and is nearly four times the current combined generating capacity of all U.S. electric power plants.

[Watch the WindSentinel buoy tour with WWPTO Director Jose Zayas.](#)

Wind Reports

Two new reports in 2015 quantify the upward trend in wind energy in America. The [Wind Vision Report](#) sets an ambitious goal to realize 20% of U.S. electricity demand from wind power by 2030; that number stands at five percent today. Other findings indicate that wind energy preserves water resources and holds the potential to generate more than 600,000 jobs in manufacturing, installation, and maintenance by 2050. Wind energy could also save consumers \$280 billion by 2050 while avoiding 2.6 million metric tons of sulfur dioxide, 4.7 million metric tons of nitrogen oxides, and 0.5 million metric tons of fine particulate matter, equivalent to \$108 billion in savings from avoided healthcare costs and economic damages.

A second study, [Enabling Wind Power Nationwide](#) focuses on technological advances in next-generation wind turbines. EERE investments support taller turbine towers and larger rotors – up to 1-1/2 times the height of the Statue of Liberty. In addition, EERE support for siting practices and policy improvements will help to create a better environment for the adoption of wind energy. The study estimates that wind energy harnessed higher above ground could unlock about one-fifth of America’s land mass, especially in areas with characteristically low wind speeds, such as the Southeast.

RENEWABLE POWER

Natel Hydropower Turns Heads



Natel Energy's Schneider Linear hydroEngine generates predictable, renewable energy for a previously unpowered, irrigation canal.

A small hydropower project in central Oregon marks an advance for the [Wind and Water Power Technologies Office \(WWPTO\)](#) that could change the face of hydropower.

Natel Energy's Schneider Linear hydroEngine is producing electricity that is being purchased by Apple to lower its carbon footprint and help power one of its data centers. This first-of-its-kind project has made use of an existing, previously unpowered, irrigation canal to generate predictable, renewable energy.

Natel, whose technology was on display in Paris this month at an innovation venue linked to the global climate change talks, has received four financial assistance awards from the U.S. Department of Energy since 2009. They include Small Business Innovation

Research Phase I & Phase II awards, as well as two WWPTO funding opportunity awards.

Through this support and private funding, the company optimized technology devised decades earlier and adapted it for low-cost manufacturing. The Energy Department connection, however, is not the only thing that's interesting about Natel.

The company's founders are a sister and brother team, Gia and Abe Schneider, who never gave up on a hydropower concept developed by their father, Daniel. He developed and deployed the Schneider Linear hydroEngine in three pilot projects but the world wasn't ready for the technology and he folded up his efforts in the early 80s.

In 1998, Gia and Abe entered the MIT Business Plan Competition, and formally restarted the technology, forming Natel Energy in 2005. They offer a great example of today's pathfinders for clean energy.

The rest is history: the Schneider Linear hydroEngine has progressed from an idea to full-scale commercialization, demonstrating that other small hydropower technologies can successfully be deployed to contribute to the nation's renewable energy mix.

WAVE ENERGY PRIZE

With more than \$2 million in prize money, WWPTO's Wave Energy Prize launched with fanfare in 2015. A record 92 teams vied for a role in the design-build-test competition that supports the Energy Department's goal to double the energy captured from ocean waves and reduce the cost of wave energy. Twenty teams were chosen to develop small-scale wave energy converters for tank testing at one of five facilities across the country. In March 2016, up to 10 finalists will be tapped to build larger scale models of their devices. The next step will be tank testing of the devices in summer 2016 at the premier U.S. wave-making facility—the Naval Surface Warfare Center's Maneuvering and Seakeeping Basin in Carderock, Maryland.

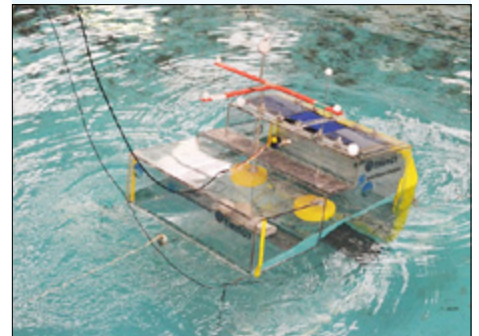

EERE research in marine and hydrokinetic efforts is advancing technologies that capture energy from the nation's oceans and rivers.



Azura is the first wave energy device to connect to the U.S. grid.

Wave Power

Azura, the nation's first grid-connected wave energy converter, started feeding renewable electricity to Marine Corps Base Hawaii in June, following its launch at the U.S. Navy's Wave Energy Test Site at Kaneohe Bay, Oahu. This marked a major milestone for the emerging marine and hydrokinetic (MHK) energy industry. Through EERE investments, MHK technologies are harnessing energy from the nation's oceans and rivers with the potential to power millions of American homes.

RENEWABLE POWER

FORGE Takes Cutting Edge Research into the Field

The Frontier Observatory for Research in Geothermal Energy (FORGE) initiative officially launched in April 2015 – marking a major milestone for the [Geothermal Technologies Office \(GTO\)](#). FORGE could lead to a clean energy source capable of powering more than 100 million homes in the United States – but it almost didn't happen.

The goal of FORGE is to develop a field laboratory dedicated to cutting-edge research on enhanced geothermal systems (EGS). These technologies utilize directional drilling and pressurized water to capture energy below the earth's surface. The first U.S. demonstration on EGS took place in the 1970's but research and development ended 20 years later. The concept was revisited by GTO in 2008 due to its vast potential generation capacity of more than 100 gigawatts – roughly one tenth of America's energy demand.

“We were looking at our demonstration portfolio and thought that there was a need for a holistic approach for EGS projects,” recalls Lauren Boyd, the EGS program manager for GTO.

Four years later, GTO teamed up with the [National Energy Technology Laboratory](#) to develop a proposal to present

before Congress in 2012. That plan was sent back to GTO for revisions.

“The amount of collaboration within the building was tremendous,” said Boyd. “There was daily involvement with Deputy Assistant Secretary Steve Chalk, Assistant Secretary Dave Danielson, the chief financial officer, and all of our congressional liaisons.”

Nearly six months later, Congress approved the proposal.

“The FORGE team did an outstanding job incorporating constructive feedback from the Hill and industry stakeholders,” said Deputy Assistant Secretary for Renewable Power Doug Hollett. “They developed a comprehensive budget and operational plan and technical briefings that ultimately gained broad bipartisan approval.”

Three of the five current Phase 1 teams will move forward to the next round, developing their individual field sites. Pending appropriations, one site will ultimately be funded in Phase 3.

“Seeing our community excited about something is rare,” said Boyd. “They are very, very excited.”



NEW GTO DIRECTOR SUSAN HAMM

Dr. Susan Hamm is the new acting director of the Geothermal Technologies Office (GTO). Hamm leads the office's efforts to advance geothermal as a key contributor to the U.S. energy portfolio by improving performance, lowering costs, and accelerating deployment of cutting-edge technologies. Hamm previously served as the Directorate Operations Officer for Mathematical and Physical Sciences at the National Science Foundation. She has also worked at the Department of Homeland Security, advocated with professional science societies, and served as a legislative assistant on Capitol Hill.



GTO Stillwater Plant

Industry partner Enel Green Power completed the 2 MW Stillwater Concentrated Solar Power (CSP) Project in 2015. The project now operates alongside the existing geothermal plant and solar photovoltaic field in Fallon, Nevada, for a total installed capacity of nearly 60 MW. This is the world's first hybrid plant to combine geothermal and solar thermal systems.

STRATEGIC PROGRAMS

EERE International Successes

EERE International continues to successfully implement two presidential initiatives with China – [the Energy Efficiency Action Plan](#) and the [U.S. – China Renewable Energy Partnership \(USCREP\)](#). Under these initiatives, [EERE International](#) hosted two key events in 2015 that involved more than 100 Chinese delegates, facilitating eight commercial and institutional partnerships with more than \$100 million of trade investment planned.

U.S. – CHINA ENERGY EFFICIENCY FORUM

The [sixth annual U.S.- China Energy Efficiency Forum \(EEF\)](#) formalized five new partnerships in September, including three facilitated by the [Energy Performance Contracting initiative](#). EERE International provided technical and policy advice on energy performance contracts, a model that pays for upfront costs of energy efficiency retrofits with utility bill savings over time. The annual energy savings from the three projects – all located in China – range from 25% - 51% and represent millions of dollars in trade and investment.

EEF falls under the U.S.- China Energy Efficiency Action Plan which aims to improve the energy efficiency of buildings, industrial facilities, and consumer appliances in both countries.



The REIF is a biennial forum under USCREP, which accelerates deployment of clean energy technologies through the design and implementation of technical tools and policy.

U.S. – CHINA RENEWABLE ENERGY INDUSTRIES FORUM

The [fourth annual U.S.- China Renewable Energy Industries Forum \(REIF\)](#) formalized a partnership this summer between BrightSource, a U.S. leader in [concentrating solar power \(CSP\) technology](#), and two Chinese entities to develop the first commercial CSP plant in Qinghai, China.

Construction on the first two 135 megawatt CSP towers hopes to break ground in 2016, providing enough renewable energy to power more than 452,000 Chinese homes. The project is currently pending approval of a government-issued tariff.

The REIF is a biennial forum under USCREP, which accelerates deployment of clean energy technologies through the design and implementation of technical tools and policies.



LEGISLATIVE AFFAIRS

Through proactive engagement, the Office of Legislative Affairs increased the number of Congressional staff meetings on the Hill for EERE technology offices by 140% compared to Fiscal Year 2014. Technical assistance requests to the Hill also increased by 44% in FY15 and influenced several high-profile energy bills.

STRATEGIC PROGRAMS



Cleantech UP

EERE's [Technology to Market Office](#) announced the launch of the [Cleantech University Prize](#) this summer. The initiative, which builds on the success of the National Clean Energy Business Plan Competition (NCEBPC), will expand to eight competitions and launch a new national organization to grow and strengthen the community of student clean energy entrepreneurs. The NCEBPC influenced more than 1,000 clean energy student teams over the last four years, hitting a number of milestones that include raising capital, securing agreements with Fortune 100 companies, acceptance into prestigious incubator programs, and receiving late-stage EERE funding. [Hyliion from Carnegie Mellon University](#) (pictured) won in 2015 for an add-on hybrid system for tractor trailers that reduces fuel consumption by more than 30% and pays for itself in less than a year.

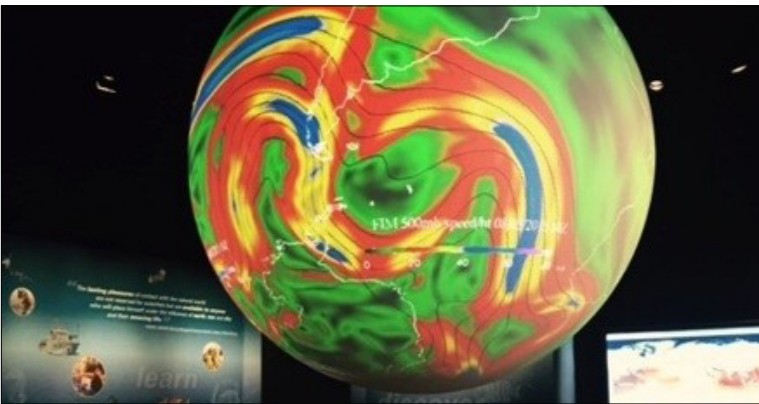

Energy on a Sphere (Education)

Tools like Science on a Sphere – a giant animated globe that visualizes complex earth science with colorful maps and imagery – are educating students of all ages on worldwide trends in earth science. EERE joined the game this year, capturing energy-specific data about renewable solar, wind and geothermal science. In August, more than 16 participating museums showcased the data sets at a White House Back to School climate event. Today, this popular learning instrument, created by the National Oceanic and Atmospheric Administration (NOAA), reaches more than 120 museums and technology centers worldwide.



Solar Decathlon

EERE Assistant Secretary Dave Danielson [presented the first-place trophy](#) to Stevens Institute of Technology – the overall winner of October's U.S. Department of Energy Solar Decathlon. Steven's [SURE House](#) also achieved a win for vulnerable mid-Atlantic coastal communities that suffered record flooding and wind damage in the wake of Superstorm Sandy. The self-sustaining house generates all its energy needs from solar electric, even during power outages. Solar Decathlon is a biennial, award-winning competition that promotes education in sustainable technologies and private sector adoption of solar efficiencies.



Communications

In partnership with the program offices, the Communications Office nearly doubled EERE's exposure over last year with more than 2,200 news articles. The team also published 68 success stories in 2015, garnering more than 57,000 pageviews and gained more than 111,000 Facebook likes – up from just 11,000 two years ago. In addition to its six issues of *Amped Up!*, EERE Communications also managed media for the program offices and successfully secured national and local coverage of Solar Decathlon 2015 in high-profile outlets, including Reuters, Associated Press, Yahoo! News, and Bloomberg.

OPERATIONS

EERE Stewards America's Energy Resources

BUDGET OFFICE

The Budget Office welcomed Director Karen Ray and Deputy Director Fredy Alberto in 2015. Under their leadership, the team's review and analysis contributed to a 31% reduction of EERE un-costed balances in FY15. The office also created a Sector Analysis Team and actively participated in the development of next-generation financial management and budget systems that will simplify data entry and provide more intuitive query options.

WORKFORCE MANAGEMENT OFFICE

The Workforce Management Office analyzed the results of the 2015 Federal Employee Viewpoint Survey (FEVS) and is implementing cross-cutting focus groups to gauge employee feedback on the data. EERE achieved an 84% participation rate this year – its highest ever on the survey. WMO is also working on streamlining the hiring process. EERE averaged 12 new hires per month over the last quarter and is working towards a steady state of 700 employees.

GOLDEN FIELD OFFICE

The Golden Field Office completed a site-wide environmental assessment at the National Renewable Energy Laboratory's South Table Mountain (STM) campus in Golden, Colorado. The finding of No Significant Impact will serve as a planning tool that aids decisions about future use and development of STM and nearby leased facilities in the Denver West Office Park. Proposed improvements to the NREL campus will support the continued development of clean energy technologies and practices, advancement of related science and engineering, and transfer of knowledge and innovations to the market.



INFORMATION MANAGEMENT

The Information Technology Systems Integration (ITSI) project officially kicked off in February 2015 and the team has been capturing the functional requirements and process integration points between the PM, FOA, AOP and budget processes. The team has also developed mockups of the future system interface and have been presenting those mockups through the ITSI webinar series and collecting feedback from the EERE user community. These webinars will continue into FY16 and culminate with the finalization of the baseline requirements for the new system by next May.

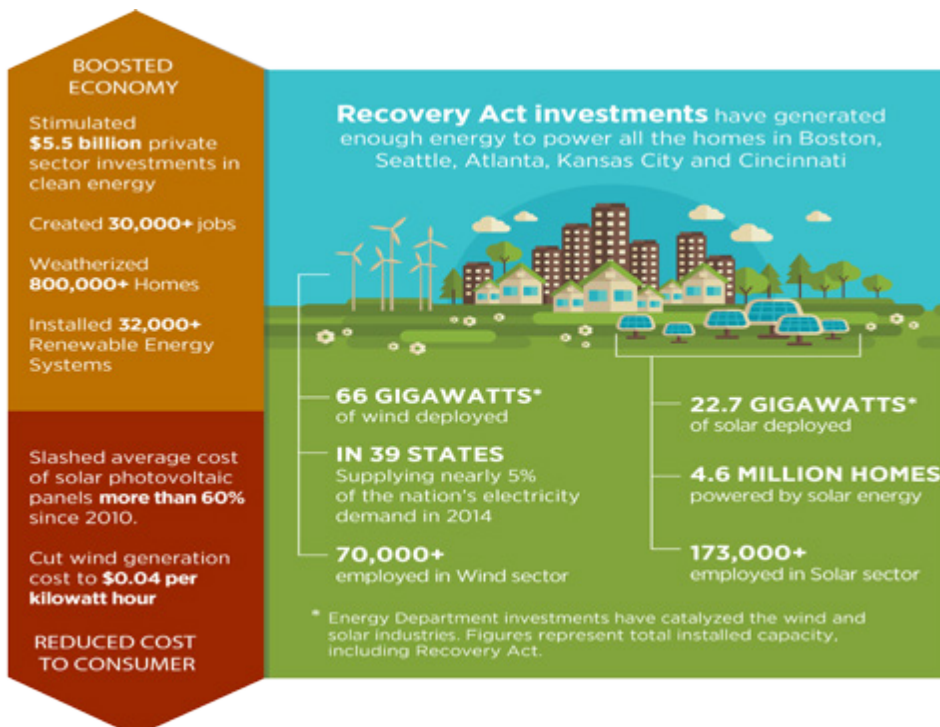

RECOVERY ACT

Recovery Act funding helped EERE lead U.S. Department of Energy efforts to deliver market-driven solutions for energy-saving homes and buildings, advanced manufacturing, sustainable transportation, and renewable power. Energy Department investments resulted in reduced costs of clean energy to the consumer and helped create jobs and boost the economy. The Project Management Coordination Office successfully expended or deobligated all Recovery Act funding.

U.S. DEPARTMENT OF
ENERGY

Energy Efficiency &
Renewable Energy

For more information, visit energy.gov/eere

For questions regarding this newsletter and future newsletters, please email
eeAmpedUp@ee.doe.gov

DOE/EE-1320