

High Efficiency, Low EMI and Positioning Tolerant Wireless Charging of EVs



Presenter: John Robb
Principal Investigator: Allan Lewis
Hyundai America Technical Center Inc (HATCI)
10 June, 2015

**2015 DOE Vehicle Technologies Program Annual Merit
Review and Peer Evaluation Meeting**

This presentation does not contain any proprietary, confidential, or otherwise restricted information

Timeline

- Start date – Oct. 2012
- End date – Sept. 2015
- Percent complete – 70%

Budget

- **Total funding: \$6,014,868.00**
 - Government* share: \$4,215,593.00
 - Contractor share: \$1,799,275.00
- Expenditure of Gov't funds in
 - FY13: \$721,632.12 (10/12-9/30)
 - FY14: \$993,035.37 (10/1-9/30)
 - FY15: ~\$500,000.00 (10/1-Present)

* Thank you to the DOE Vehicle Technologies program for their support and funding of this project

Partners

- Mojo Mobility

Technical Barriers

- Conductive charging stations introduce limitations regarding access, range, and usability.
 - ADA access
 - Cord length and inconsistent vehicle port placement
 - Overall usability
- Wireless charging systems are prone to EMI, position intolerance, and low efficiency.

Technical Targets

- Transfer power at over 6.6kW.
- Total system efficiencies of more than 85%.
- Achieve real world position and gap tolerance.
 - ± 0.25 m along the width of the vehicle.
 - ± 1 m along the length of the vehicle.
 - Greater than 20 cm coil to coil gap.







Objectives

The objective of this project is to develop, implement, and demonstrate a wireless power transfer system with total system efficiencies of more than 85%, power transfer at over 6.6 kW, and maximum positioning tolerance that can be achieved while meeting regulatory emission guidelines.

Addresses Technical Barriers

- Reduce the dependence on conductive charging stations which will allow more convenience to the user, increased access and usability in support of ADA, and provide a charge with potentially no action required by the driver.
- Develop a wireless charging system that meets industry guidelines, while operating with position tolerance and efficiency of more than 85%.

Milestones

Month/Year	Milestone or Go/No-Go Decision	Description	Status
02/2013	Milestone	Design of Initial WPT Prototype System.	
06/2013	Milestone	System Test and Corrections.	
07/2013	Milestone	Design of Second Generation WPT Prototype System.	
09/2013	Milestone	System Test and Corrections.	
02/2014	Go/No-Go Decision	Demonstrate the wireless power transfer system and perform a power transfer of at least 6.6 kW with an efficiency of at least 85% with at least a 20 cm coil to coil gap.	
09/2014	Milestone	Design of Third Generation WPT Prototype System.	
04/2015	Milestone	Vehicle Integration and Test.	
05/2015	Go/No-Go Decision	Demonstration of the wireless power transfer system integrated into an electric vehicle with performance as defined in phase 1 Go-No-Go criteria.	
08/2015	Milestone	The Project team will build five WPT-enabled EVs based on the EV and WPT chargers using system specifications developed in Phase II.	
02/2016	Milestone	The Project team will deliver one WPT-enabled EV and wireless charging station to the Department of Energy for National Laboratory testing.	
04/2016	Milestone	The Project team will perform vehicle and product tests as specified in Test Plan and provide data to a DOE national laboratory as specified in the data collection plan.	

■ System Design

- System Requirement Specification
- Defined end-to-end block diagram and control interfaces
- Modeled and developed high efficiency coil and magnetics

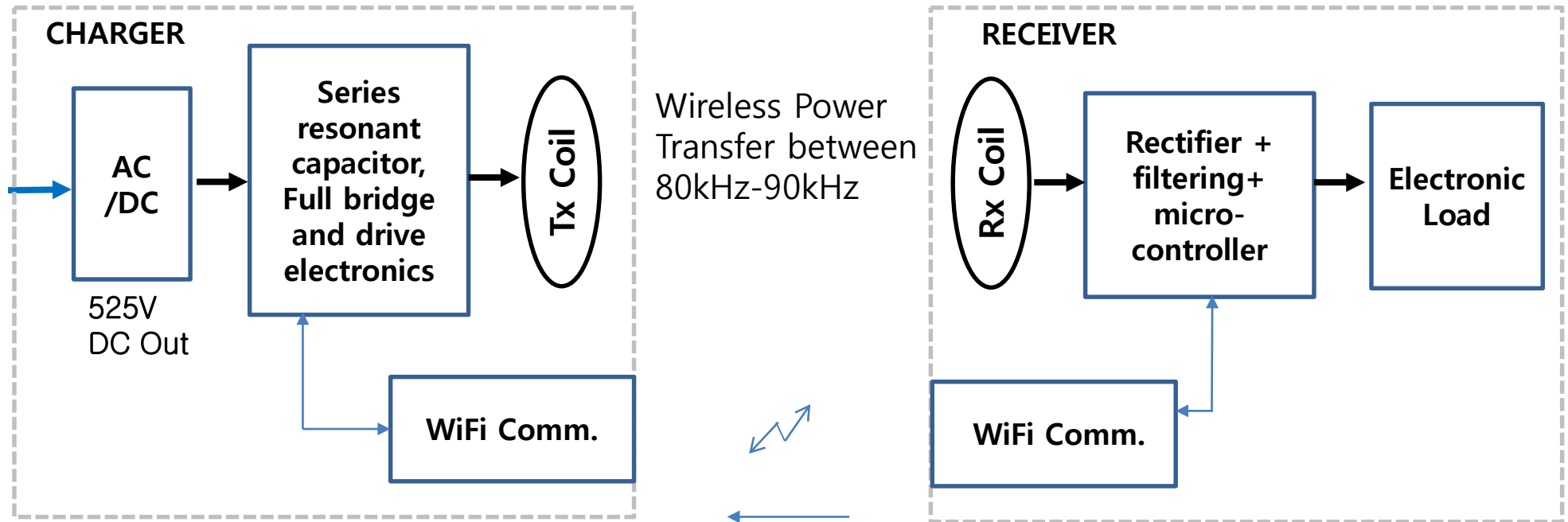

Output current/voltage Measurements for feedback loop

Development Stages

- First Generation WPT Prototype System
 - Initial proof of concept
 - Basic board layouts with little consideration for real estate constraints
 - Heavily populated with test points
 - Allowance for external gate drive
 - Variable DC power supply
 - Initial focus on charger and receiver board design
 - Symmetric coil design
 - Initial focus on control system development
- Second Generation WPT Prototype System
 - Optimized charger and receiver boards
 - Board size reduction
 - Trace and component optimization
 - Integrated DC power supply
 - Asymmetric coil design
 - Geometrically designed for position freedom
- Third Generation WPT Prototype System
 - PFC AC/DC front end (>20 kW output design)
 - Redesign charger for integration with PFC
 - Redesign receiver for EV integration
 - Redesign receiver and charger coil for EV integration and housings
 - Mechanical, environmental, weight, etc.



Gen. 1 Charger

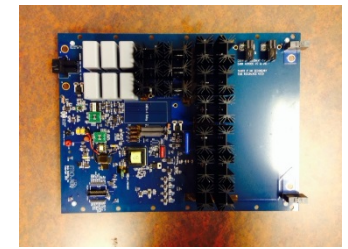

Gen. 1 Receiver

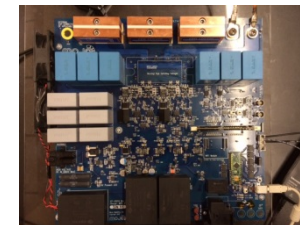

Gen. 2 Charger

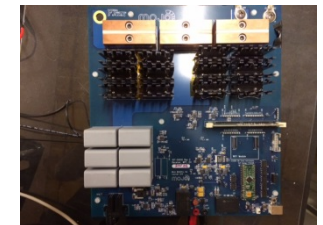

Gen. 2 Receiver



Gen. 3 Charger



Gen. 3 Receiver Housing and Coil

Phase 2 Development

High Efficiency (98%) AC/DC Power Factor Correction (PFC) front end:

- 240 V AC input to 480 V DC output
- Designed for > 20 kW output – Tested to 10 kW so far
- Interleaved 4 phase operation
 - Reduced current through each switch
 - Reduced output ripple of PFC
- SCR bridge input combines rectification and power switch to reduce components and increase efficiency.
- Micro-controlled with firmware for startup, control of stand-by power, and interface with charger
- Small volume design (63 x 40 x 13 cm)
- Single board construction – Low cost assembly
- Fan cooled

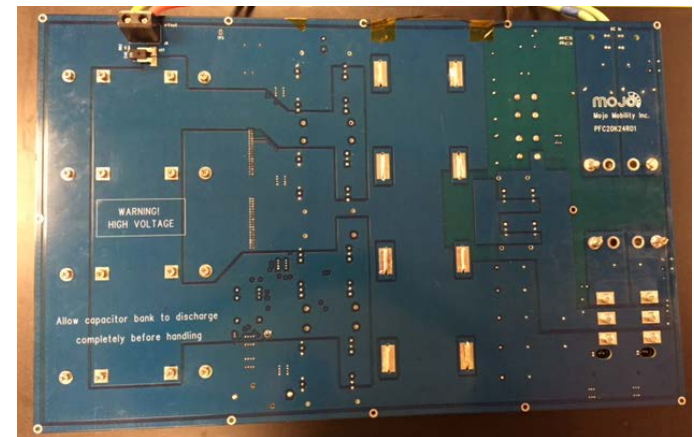
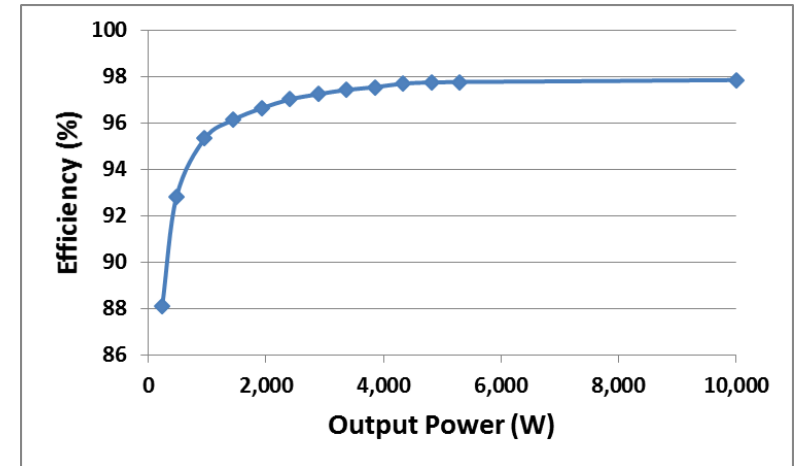

Top View of PFC

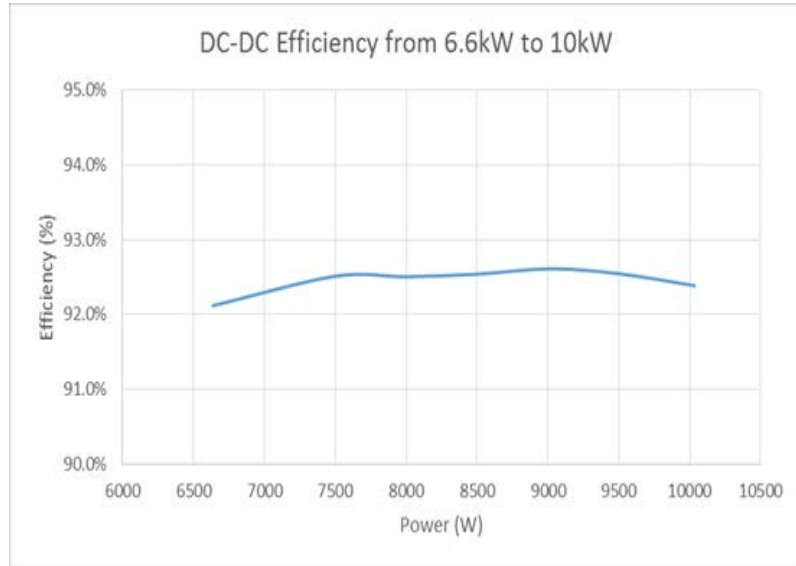

Phase 1

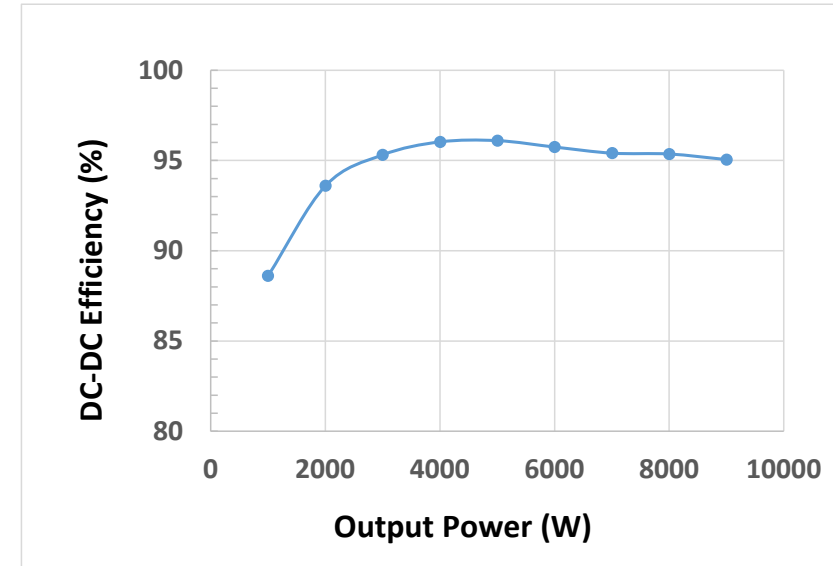

Phase 2

- In Summary, we have decreased size of Tx coil in Phase 2
 - Results in 3% efficiency increase
 - Smaller X-Y positioning but sufficient for most applications ($> \pm 20$ cm)
- Output power limited by electronic load. Higher powers can be reached with 2 loads in series.

Efficiency Comparison with Wired Charging

	Average Level 2 Wired Charging	HATCI/Mojo Wireless Charging
High Energy Charge (>2kWh)	86.5%	Over 92%

- Level 2 standard wired chargers have average AC to Battery efficiencies of 86.5%
- Wireless charging provides comparable efficiencies and better user experience

Source:

Vermont Energy Investment Corporation: An Assessment of Level 1 and Level 2 Electric Vehicle Charging Efficiency, 2013

WPT DC-DC Efficiency vs Coil Offset

X Offset

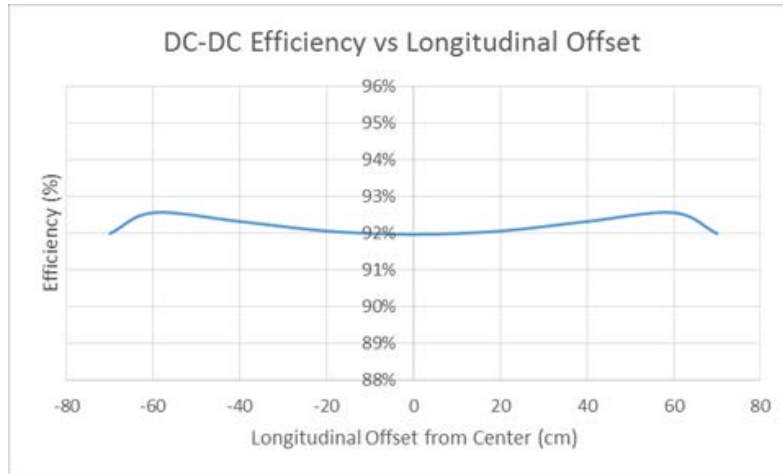

X Offset

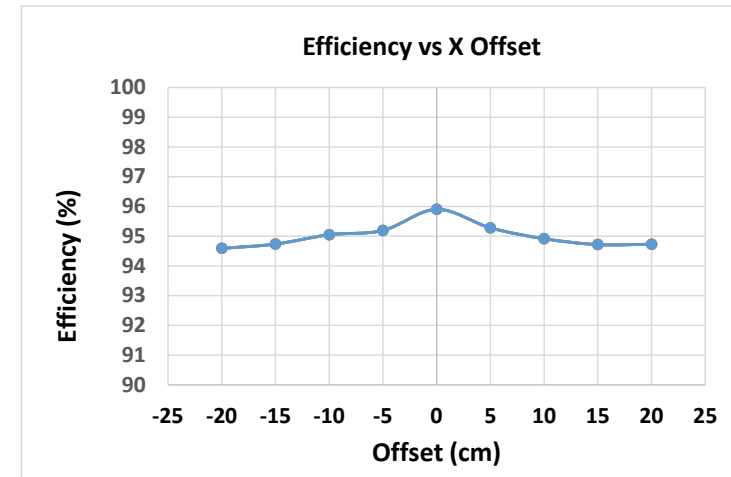

Phase 1



Phase 2

Conditions:

- 87kHz switching frequency
- 20cm coil to coil separation

Notes:

- Phase 2 utilizes a smaller coil design

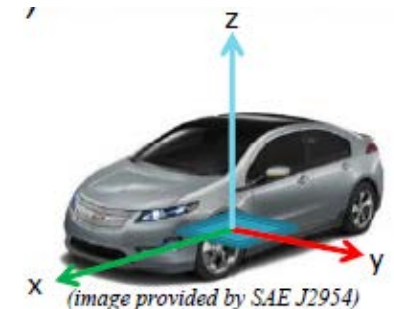

WPT DC-DC Efficiency vs Coil Offset

Y Offset

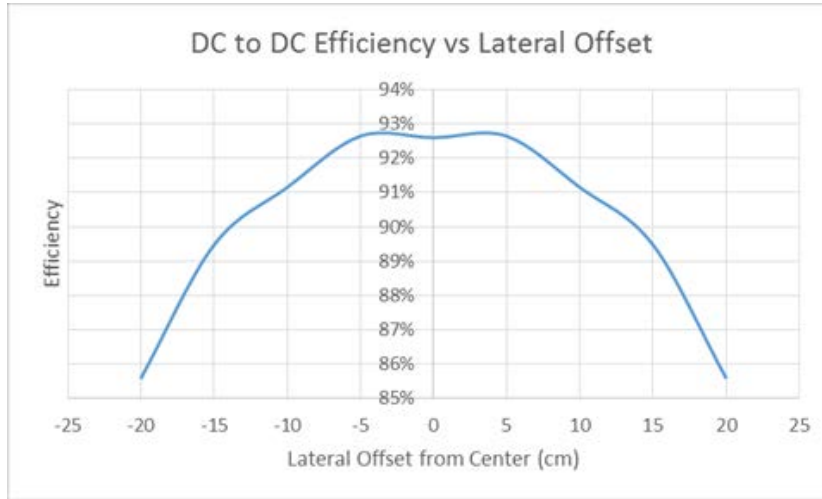

Y Offset

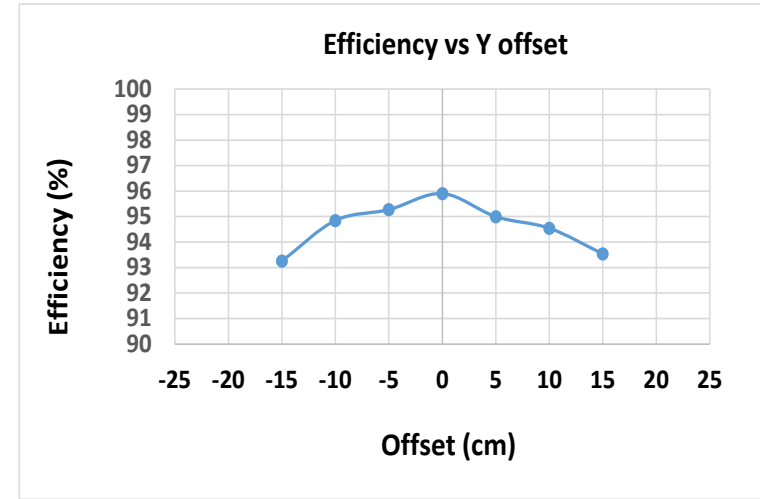

Phase 1



Phase 2

Conditions:

- 87kHz switching frequency
- 20cm coil to coil separation

Notes:

- Phase 2 utilizes a smaller coil design

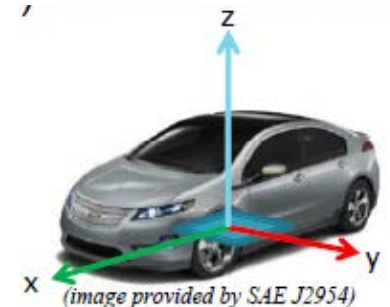

ICNIRP Electromagnetic Emission Safety Guidelines

ICNIRP 2010 Guidelines for Safe Exposure to Electric & Magnetic Fields in Frequency Range of 80kHz to 90kHz:

- 100 μT & 170 V/m for Occupational Exposure
- 27 μT & 83 V/m for General Exposure

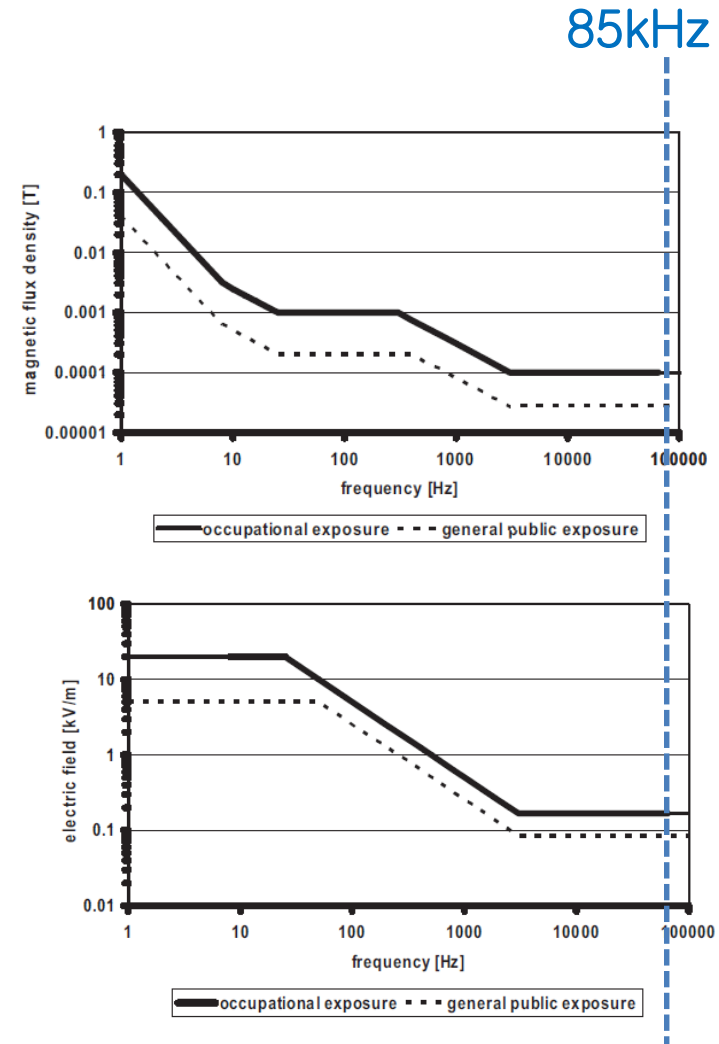

System Emissions Measurements (ICNIRP)

ICNIRP 2010 Limits for General Public

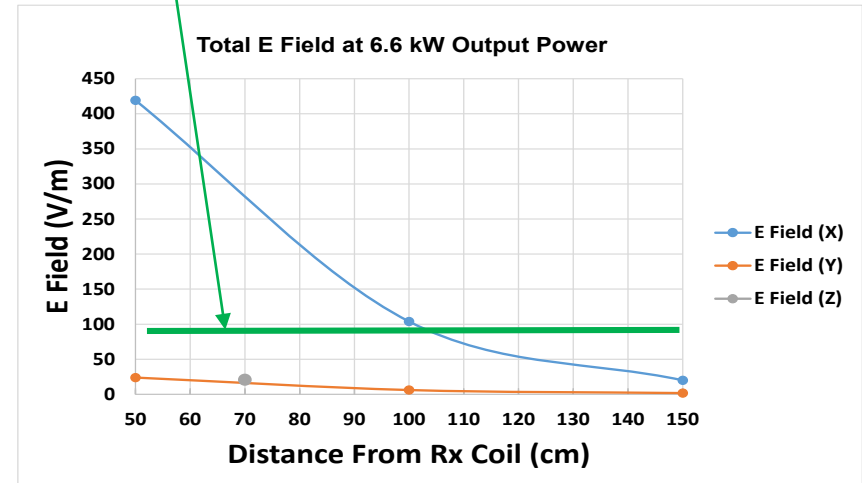
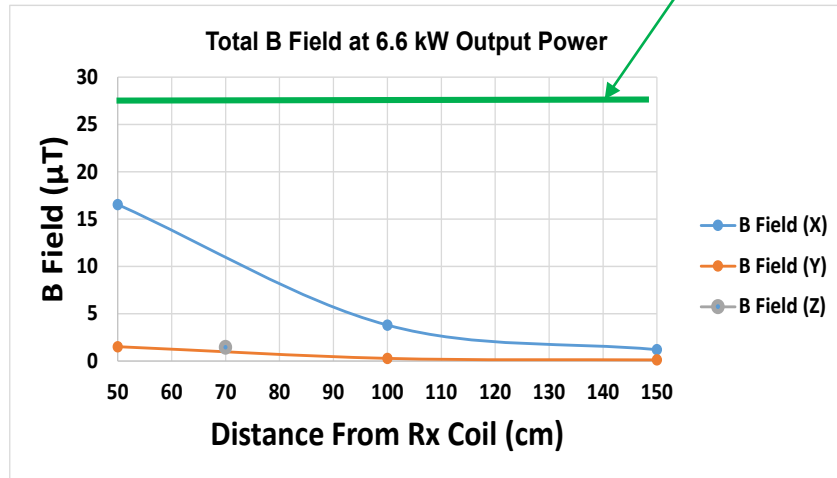

Conditions:

- 82 kHz switching frequency
- 20 cm coil to coil separation
- Bench system measurements (no shielding)

Note:

- Very low lateral emissions (unique design)
- Vehicle length will help shield the x-axis component

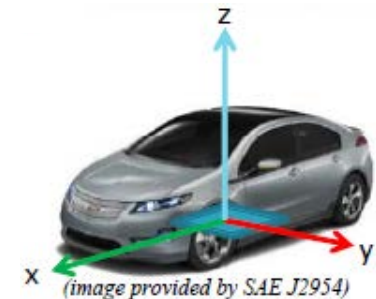

EMF Exposure to Humans & Implanted Medical Devices

SAE J2954 TIR

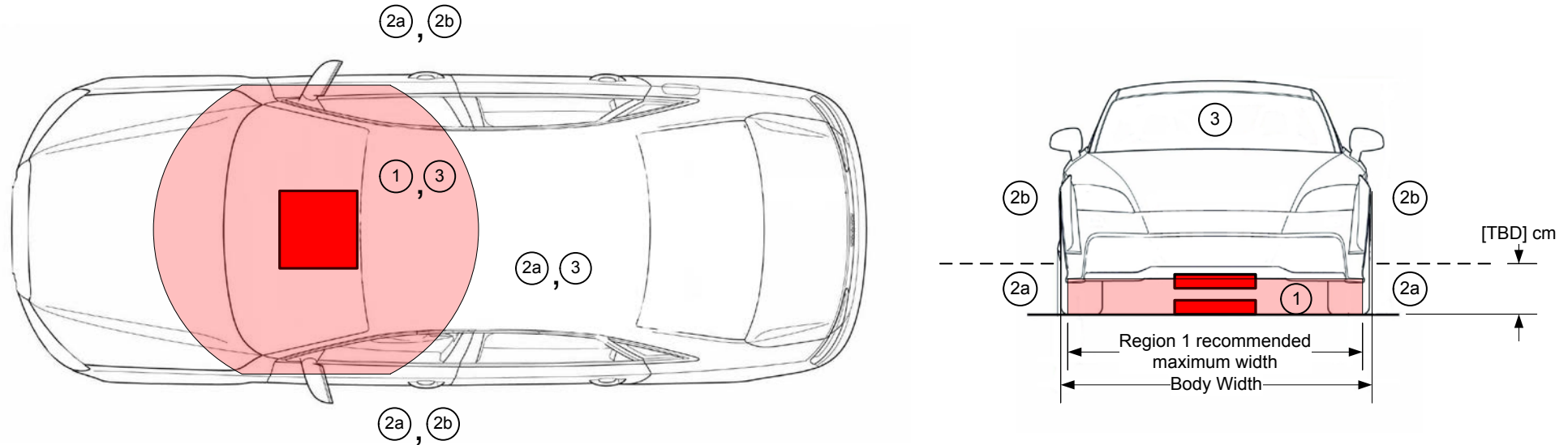

SAE has been working hard to define EMF exposure limits as it relates to the automotive environment.

Region 1: Underneath the vehicle and near the wireless power pads.

Region 2a: Around the vehicle at heights less than 20cm above the ground.

Region 2b: Around the vehicle at heights greater than 20cm above the ground.

Region 3: Vehicle interior.

System Emissions Measurements (SAE J2954 – Automotive)

Magnetic Field: Bench measurement, unshielded, front bumper, 6.6kW

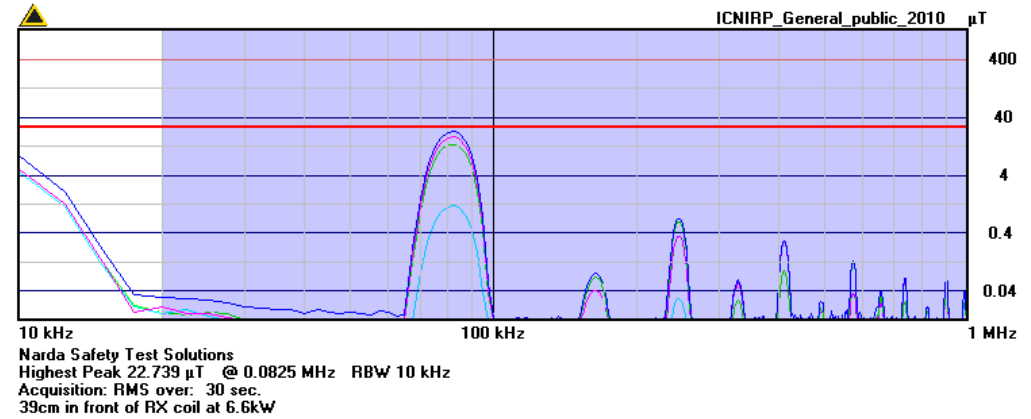

Magnetic Field: Bench measurement, unshielded, interior footrest (D), 6.6kW

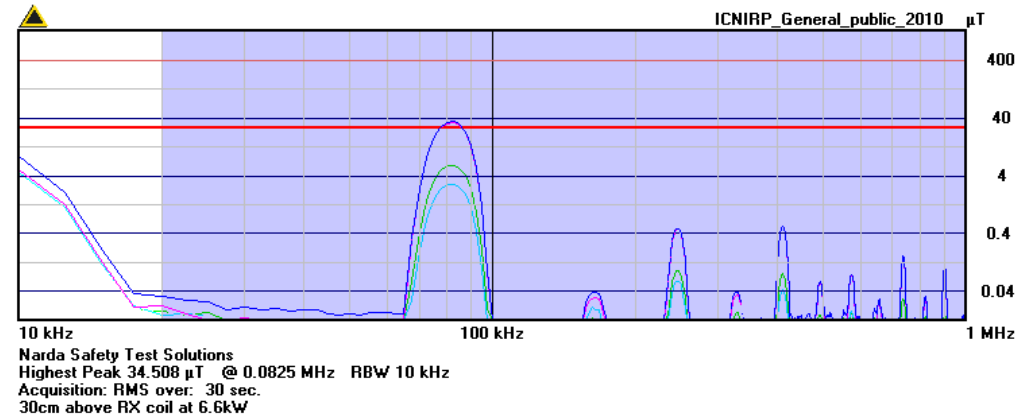

System Emissions Measurements (SAE J2954 – Automotive)

Electric Field: Bench measurement, unshielded, front bumper, 6.6kW

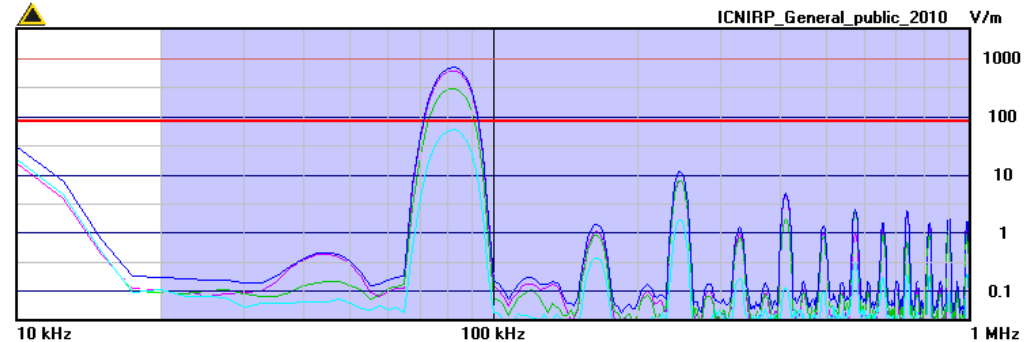

Electric Field: Bench measurement, unshielded, interior footrest (D), 6.6kW

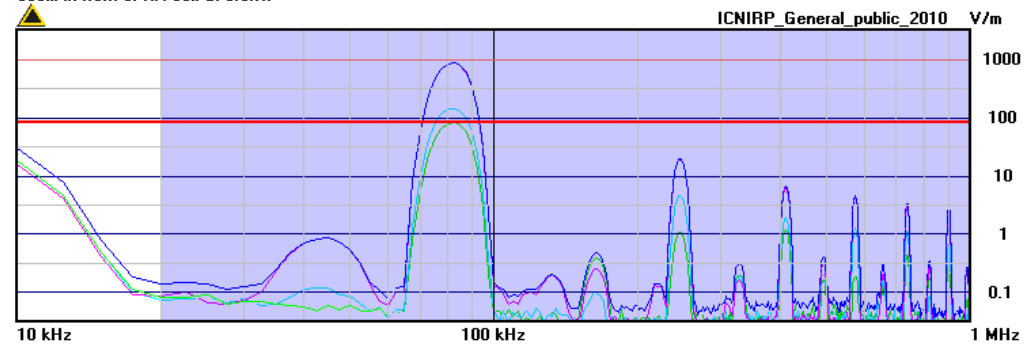

Next Steps: Emissions testing on the vehicle integration system to identify the surrogate vehicles' effect on H and E fields.

Responses to Previous Year Reviewers' Comments

Notes: (1) Comments taken from the 2014 AMR evaluations

Reviewer Comments (2014 AMR) ⁽¹⁾	Response
"The project appeared to be running about six months behind milestones."	Project contract negotiations delayed development kick-off by approximately six months.
"Collaboration with Mojo Mobility appeared to be insufficient."	Phase 2 has required closer collaboration to overcome mechanical packaging and shielding as well as electrical power and signal connection as it applies to vehicle integration.
"FY 2015 proposed work includes National Laboratory testing without any National Laboratory listed as a partner."	The National Laboratory is not intended to be a partner. DOE specifies NL for independent testing and evaluation of vehicles and wireless charging systems. Our project deliverables will be evaluated by Idaho National Laboratory.



- Mojo Mobility
 - Sub-recipient of award no. DE-EE0005963.
 - Responsible for design, development of wireless charging system.
 - Currently developing wireless charging systems for consumer electronics, and automotive applications.



- Society of Automotive Engineers (SAE)
 - J2954 Wireless Charging Task Force (Voting Member)
 - J2836/6 Wireless Charging Specific Use Cases (Voting Member)
 - J2847/6 Wireless Charging Specific Messages (Voting Member)
 - J2931/6 Wireless Charging Specific Protocols (Voting Member)



- Next Energy
 - Advising on commercialization strategies and opportunities.
 - Market intelligence support.
 - Vehicle level functional validation support.

■ FY15

• Fleet Build-Up

- Build five (5) WPT-enabled EVs based on the Gen. 3 system specifications
 - Vehicle retrofitting will be performed at HATCI HQ in Ann Arbor, MI

• Validation

- Deliver one (1) WPT-enabled EV and charging system to DOE
 - National Laboratory Testing
- Perform vehicle and product validation
 - Component level EMC/EMI
 - Vehicle level EMC/EMI
 - Electrical parametric
 - Ingress protection
 - Thermal
 - Durability





The benefits provided by wirelessly charging Grid Connected Electric Drive Vehicles (GCEDV) are motivating innovation in the area to address technical challenges. The early design work by HATCI and Mojo Mobility is leading towards the ability to present new state of the art performance capabilities in the areas of:

- Low spurious unwanted emissions into the environment.
- High power transfer efficiencies.
- High power transfer
- Large coil to coil misalignment and vertical gap separation.

The cooperation of HATCI and Mojo Mobility provides an opportunity to develop a next generation GCEDV wireless charging system that can be quickly integrated into production ready vehicles for vehicle level testing that will provide proof of concept systems for evaluation for commercial potential.

- Commercial Viability Study performed in FY14 will provide an understanding of the following considerations:
 - Commercial viability and cost benefits.
 - Comparison with SAE 1772 compliant conductive charging system.
 - Expected market penetration.
 - Potential petroleum reduction.

