

APPENDIX D

WASTE INVENTORIES

This appendix provides additional information about the inventories that compose the proposed alternatives described in Chapter 2 of this *Tank Closure and Waste Management Environmental Impact Statement for the Hanford Site, Richland, Washington (TC & WM EIS)*. Information provided in this appendix forms the basis for determining short-term environmental impacts of each alternative, which are described in Chapter 4 of this *TC & WM EIS*. Each alternative represents a combination of technologies, processes, and facilities that could accomplish the desired outcome for that alternative. Distribution of the radioactive and chemical constituents of the tank waste among the various waste form, storage, and management options depends on the technologies and processes used under each alternative. Section D.1 provides information on the basis for the chemical and radionuclide composition in the tanks, as well as on equipment, soils, and waste forms. Section D.2 provides information on the basis for the chemical and radionuclide composition for the decommissioning of the Fast Flux Test Facility. Section D.3 provides information on the basis for the chemical and radionuclide composition for the waste management activities at Hanford, including treatment, storage, and disposal of onsite- and offsite-generated waste. This information, along with data regarding the technologies and processes that would be used under each alternative, was used as a basis for modeling transport of contaminants in air, water, and soil.

D.1 TANK CLOSURE ALTERNATIVES

Beginning in 1944, the Federal Government irradiated uranium fuel in nuclear reactors at the Hanford Site (Hanford) to produce plutonium for national defense programs. Uranium and plutonium were recovered from the fuel using a variety of physical and chemical separations processes that generated highly radioactive waste streams. Between 1943 and 1964, 12 tank farms containing 149 single-shell tanks (SSTs) were commissioned to store waste containing the radioactive and chemical constituents. During this time, programs were instituted to recover specific constituents and reduce stored volumes to accommodate production needs. During the 1950s, leakage from the tanks was confirmed. To address this leakage and provide safe storage of the waste, 28 double-shell tanks (DSTs) grouped in 6 additional tank farms were placed in service between 1971 and 1986. Because of the complexity of the production, processing, and waste management operations, the exact radiological and chemical characteristics of each tank are uncertain.

To support this *Tank Closure and Waste Management Environmental Impact Statement for the Hanford Site, Richland, Washington (TC & WM EIS)* environmental impact analyses, the amounts of radioactive and chemical constituents in the tanks and in leaks, discharges, and waste forms associated with tank operations, retrieval, and closure were estimated. Inventory estimates are presented in the following sections of this appendix:

- D.1.1, Current Tank Inventory of Radioactive and Chemical Constituents
- D.1.2, Tank Ancillary Equipment Waste
- D.1.3, Tank Residual Waste Inventories
- D.1.4, Historical Leaks and Other Releases
- D.1.5, Discharges to Cribs and Trenches (Ditches)
- D.1.6, Tank Waste Retrieval Leaks
- D.1.7, Inventories and Flowsheets
- D.1.8, Distribution of Radiological Constituents of Potential Concern for Tank Closure Alternatives

The primary sources of information related to tank inventories and past releases are summarized in the *Inventory and Source Term Data Package* (DOE 2003a), which was developed for this *TC & WM EIS*.

D.1.1 Current Tank Inventory of Radioactive and Chemical Constituents

Constituent concentrations are based on sample data, models, calculations, and engineering assessments. For tanks with no sample data, sample-based templates and engineering templates were used to estimate inventories based on data from tanks containing the same waste type. The estimation methods are summarized in the following paragraphs.

The Best-Basis Inventory (BBI) establishes the inventory of the underground waste storage tanks at Hanford by using sample data, process knowledge, surveillance data, and waste stream composition information from the Hanford Defined Waste (HDW) computer model (Agnew et al. 1997). The BBI is a process that was developed to more fully understand and use the available analytical data for tank samples and use the best available information to estimate tank compositions and inventories. The BBI provides the official estimate of SST and DST contents at Hanford for 24 chemical species and 46 radionuclides. BBIs are updated on a quarterly basis to incorporate new data and waste transfer information. The BBI used in this environmental impact statement (EIS) reflects the inventory estimates for the wastes in the tanks as of December 1, 2002. All radionuclides are decayed to January 1, 2001 (DOE 2003a). Sample data released after December 1, 2002, and waste transfers occurring after December 1, 2002, are not included (DOE 2005).

Sample data, when they represent the current contents of the tank, are the preferred source of waste concentration information for the BBI (DOE 2003a). All of the DSTs and most of the SSTs have been sampled. However, a number of the sampled tanks were analyzed for a limited suite of analytes. In addition, the 23 SSTs listed in Table D-1 were not sampled or their historical sample data are unusable. Among the 23 unsampled SSTs are 13 of the 18 tanks in the TX tank farm and 6 of the 15 tanks in the SX tank farm. Sampling is not required for retrieval and disposal planning purposes (Simpson, DeFigh-Price, and Banning 1999).

Table D-1. Unsampled Single-Shell Tanks

| | | |
|------------|------------|------------|
| 241-B-105 | 241-BX-102 | 241-S-108 |
| 241-SX-107 | 241-SX-109 | 241-SX-110 |
| 241-SX-111 | 241-SX-112 | 241-SX-114 |
| 241-TX-101 | 241-TX-102 | 241-TX-103 |
| 241-TX-105 | 241-TX-106 | 241-TX-108 |
| 241-TX-109 | 241-TX-110 | 241-TX-111 |
| 241-TX-112 | 241-TX-114 | 241-TX-115 |
| 241-TX-117 | 241-U-104 | |

Due to these limitations on collected samples, a complete tank inventory cannot be determined based on samples only. Further, limited data are available for some of the key tank closure risk drivers.

Process knowledge concentrations may be derived from information such as historical tank sample data, sample data from other tanks, waste transfers, and chemical additions. Waste-type template concentrations were used when other information was not available. The solid-waste-type templates were based on sample data for a particular waste type, supplemented with process knowledge and waste-type concentrations from the HDW model (Agnew et al. 1997). Liquid-waste-type templates were primarily based on waste-type concentrations from the HDW model, adjusted for process knowledge of mercury and other water-insoluble metals.

Most of the BBI chemical inventories can be traced to sample data or template concentrations based on samples. However, aside from radionuclides such as cesium-137/barium-137m, strontium-90/yttrium-90, and the isotopes of americium, curium, plutonium, and uranium, the BBI radionuclide inventories are largely based on the HDW model. This is especially true for the SSTs.

However, the BBI does not provide inventory estimates for analytes such as chromium, pertechnetate, polychlorinated biphenyls (PCBs), and volatile and semivolatile organic compounds that may be of concern for retrieval, disposal, and closure purposes. The procedures used to estimate inventories for these constituents are presented in Section D.1.1.3.

Selected tanks are being analyzed for PCBs. To date, 55 tanks have been sampled; 43 showed no PCBs and 12 had positive results for PCBs. These results were used to estimate an inventory across the tank farms. The procedures used to estimate PCB concentrations are presented in Section D.1.1.3.

The BBI includes quantity estimates of 46 radioactive and 24 chemical constituents. Not all constituents are important in the exposure scenarios used to assess *TC & WM EIS* alternative implementation impacts. Thus, to focus attention on the constituents that control the impacts, U.S. Department of Energy (DOE) performed an initial screening analysis. For radionuclides, groundwater release and direct intrusion scenarios were considered. For the groundwater release screening scenario, only drinking water consumption was considered. Release was assumed to be partition-limited, and decay during transport was considered. For the direct intrusion screening scenario, inadvertent soil ingestion and inhalation pathways were considered.

The analysis estimated relative impacts based on distribution of radionuclides in the BBI for all tanks. Radionuclides contributing less than 1 percent of impacts under intruder or well scenarios were eliminated from the detailed analysis. To screen for hazardous chemicals, drinking water ingestion impacts were estimated for the 24 BBI chemical constituents and those contributing more than 99 percent of impacts were selected for detailed analysis. In addition, reported tank concentrations were reviewed and compared to health-based limits (DOE 2003a) and chemical constituents of potential concern (COPCs), when compared to health-based limits (DOE 2003a), were added to the initial list of screened chemicals. The results of this analysis are presented in Table D–2. The screening of the BBI for the groundwater scenarios resulted in reduction of the original set of 46 radionuclides and 24 chemical constituents to a final set of 10 radionuclides and 10 chemical constituents that was used in the analysis of the tank waste. However, a screening of the cumulative impacts analysis data resulted in the addition of other COPCs that are not included in Table D–2. Appendix Q provides details on this screening.

Table D–2. Constituents Selected for Detailed Analysis

| Radionuclides | Chemicals |
|----------------------------|---------------------------|
| Hydrogen-3 (tritium) | Chromium |
| Carbon-14 | Mercury |
| Strontium-90 | Nitrate |
| Technetium-99 | Lead |
| Iodine-129 | Uranium |
| Cesium-137 | Acetonitrile |
| Uranium isotopes | Benzene |
| Neptunium-237 | Butanol (n-butyl alcohol) |
| Plutonium isotopes | Polychlorinated biphenyls |
| Americium-241 ^a | 2,4,6-Trichlorophenol |

^a Applies to intruder analysis scenarios only due to inhalation pathway.

D.1.1.1 Current Waste Phase Volume Inventories

This section summarizes the waste phase volumes in the SSTs and DSTs. There are four main waste phases used in the BBI: retained gas, salt cake, sludge, and supernatant. Salt cake and sludge are often further divided into solid and interstitial liquid phases. With the exception of retained gas, one or more waste types are associated with each waste phase. Waste types are associated with the waste streams that entered the tank farms from the separations plants or evaporators.

Information such as surveillance data (e.g., waste-surface-level, sludge-level, and liquid-observation-well measurements); in-tank photographs; core-sample extrusion observations; core sample analyses (to distinguish between the salt cake and sludge waste phases); and waste transfer history were evaluated to determine the waste volumes used in the BBI. Interstitial liquid volumes were calculated using average porosities when no specific information was available for a tank. The volumes of tanks being stabilized by pumping of salt well liquids were estimated prior to the start of pumping and subsequently were adjusted to account for the volume of liquid removed from the tank.

BBI data as presented in the *Inventory and Source Term Data Package* provides the waste phase volumes for each tank as well as a summary of the waste volumes by tank farm and totals for the SSTs and DSTs (DOE 2003a). Note that any retained gas in a tank was assumed to be trapped in the salt cake and sludge waste phases. Supernatant phases have not been found to contain significant quantities of retained gas (Mahoney et al. 1999). As a result, the total salt cake and sludge waste phase tank volume was greater than the values listed in the *Inventory and Source Term Data Package* for tanks containing retained gas (DOE 2003a).

Estimates of current waste volumes and individual tank design (nominal) volumes for each tank farm are presented in Table D–3. Current waste volumes and tank nominal volumes were used in conjunction with estimates of current tank inventories to develop inventory estimates of constituents in past leaks and tank waste retrieval leaks.

Table D–3. Tank Inventory Volumes

| Tank Farm | Number of Tanks | Location | Nominal Volume of Tank Farms (cubic meters) | Current Volume of Waste^a (cubic meters) |
|---------------------------------|------------------------|-----------------|--|---|
| Single-Shell Tanks | | | | |
| A | 6 | 200-East Area | 22,710 | 4,338 |
| AX | 4 | 200-East Area | 15,140 | 2,097 |
| B | 16 | 200-East Area | 35,424 | 7,743 |
| BX | 12 | 200-East Area | 24,072 | 5,948 |
| BY | 12 | 200-East Area | 34,428 | 15,789 |
| C | 16 | 200-East Area | 35,424 | 6,653 |
| S | 12 | 200-West Area | 34,428 | 19,777 |
| SX | 15 | 200-West Area | 56,775 | 13,142 |
| T | 16 | 200-West Area | 35,424 | 7,024 |
| TX | 18 | 200-West Area | 51,624 | 24,568 |
| TY | 6 | 200-West Area | 17,214 | 2,398 |
| U | 16 | 200-West Area | 35,424 | 12,154 |
| Total Single-Shell Tanks | | | | 121,631 |

Table D–3. Tank Inventory Volumes (continued)

| Tank Farm | Number of Tanks | Location | Nominal Volume of Tank Farms (cubic meters) | Current Volume of Waste ^a (cubic meters) |
|---------------------------------|-----------------|---------------|---|---|
| Double-Shell Tanks | | | | |
| AN | 7 | 200-East Area | 30,737 | 21,181 |
| AP | 8 | 200-East Area | 35,128 | 27,828 |
| AW | 6 | 200-East Area | 26,346 | 16,368 |
| AY | 2 | 200-East Area | 7,570 | 3,257 |
| AZ | 2 | 200-East Area | 7,570 | 7,548 |
| SY | 3 | 200-West Area | 13,173 | 8,979 |
| Total Double-Shell Tanks | | | | 85,161 |
| Sum of all Tanks | | | | 206,792 |

^a Volumes as of December 1, 2002.

Note: To convert cubic meters to gallons multiply by 264.17.

Source: Derived from DOE 2003a.

D.1.1.2 Radiological Best-Basis Inventories

This section summarizes the BBI for each of the screened radiological constituents in the SSTs and DSTs. The BBI provided the individual tank inventories and concentrations for each waste phase or type. The *Inventory and Source Term Data Package* (DOE 2003a) provided the inventory mass of all of the screened radiological constituents estimated to be present at each tank farm as of December 1, 2002. Tables D–4 and D–5 summarize the screened radiological constituent inventories for the SST and DST farms, respectively.

D.1.1.3 Nonradiological Best-Basis Inventories

The BBI inventory mass for the screened nonradiological constituents (chromium, mercury, nitrate, lead, and uranium) for each tank farm was provided by the HDW model. Available solid-, liquid-, and gas-phase concentration data were utilized to derive inventory estimates of five additional nonradiological constituents identified during the screening procedure (DOE 2003a). The calculations and formulas used to estimate inventory masses for those additional constituents are described in the following paragraphs. Estimates of the current tank inventories for the 10 screened chemical constituents at the SST and DST farms are presented in Tables D–6 and D–7, respectively. Due to the reducing environment in the tanks, the nitrite inventory was converted on a molecular-weight basis and added to the nitrate inventory and reported as nitrate.

Table D-4. Single-Shell Tank Radiological Constituent Inventories by Tank Farm (curies)

| Analyte | Tank Farm | | | | | | | | | | | | Total |
|-------------------------------|-----------------------|-----------------------|-----------------------|-----------------------|----------------------|-----------------------|-----------------------|----------------------|-----------------------|----------------------|-----------------------|----------------------|----------------------|
| | A | AX | B | BX | BY | C | S | SX | T | TX | TY | U | |
| Hydrogen-3 (tritium) | 3.38×10 ² | 1.30×10 ² | 2.07×10 ¹ | 1.01×10 ² | 1.33×10 ³ | 1.10×10 ² | 1.94×10 ³ | 1.32×10 ³ | 3.42×10 ¹ | 2.13×10 ³ | 3.50×10 ¹ | 1.44×10 ³ | 8.93×10 ³ |
| Carbon-14 | 8.33×10 ¹ | 6.44×10 ¹ | 7.88 | 4.19×10 ¹ | 5.60×10 ² | 1.58×10 ¹ | 5.05×10 ⁻² | 2.90×10 ² | 1.48×10 ¹ | 6.47×10 ² | 7.63 | 3.56×10 ² | 2.59×10 ³ |
| Strontium-90 | 6.52×10 ⁶ | 3.09×10 ⁶ | 1.89×10 ⁶ | 1.30×10 ⁶ | 1.75×10 ⁶ | 9.18×10 ⁶ | 2.52×10 ⁶ | 5.28×10 ⁶ | 3.72×10 ⁵ | 1.17×10 ⁶ | 3.31×10 ⁵ | 9.05×10 ⁵ | 3.43×10 ⁷ |
| Technetium-99 | 6.74×10 ² | 4.13×10 ² | 2.13×10 ² | 3.70×10 ² | 2.54×10 ³ | 3.51×10 ² | 2.74×10 ³ | 1.76×10 ³ | 1.63×10 ² | 3.76×10 ³ | 1.02×10 ² | 2.43×10 ³ | 1.55×10 ⁴ |
| Iodine-129 | 9.45×10 ⁻¹ | 4.81×10 ⁻¹ | 8.18×10 ⁻² | 4.49×10 ⁻¹ | 5.55 | 9.93×10 ⁻¹ | 5.93 | 3.35 | 1.14×10 ⁻¹ | 7.15 | 1.29×10 ⁻¹ | 4.69 | 2.99×10 ¹ |
| Cesium-137 | 1.24×10 ⁶ | 6.58×10 ⁵ | 3.58×10 ⁵ | 3.26×10 ⁵ | 2.23×10 ⁶ | 9.93×10 ⁵ | 2.60×10 ⁶ | 2.68×10 ⁶ | 1.65×10 ⁵ | 2.44×10 ⁶ | 5.26×10 ⁴ | 2.32×10 ⁶ | 1.61×10 ⁷ |
| Uranium-233, -234, -235, -238 | 3.29×10 ¹ | 3.64 | 2.08×10 ¹ | 5.09×10 ¹ | 5.22×10 ¹ | 4.98×10 ² | 5.18×10 ¹ | 2.95×10 ¹ | 2.59×10 ¹ | 4.79×10 ¹ | 2.23×10 ¹ | 3.90×10 ¹ | 8.75×10 ² |
| Neptunium-237 | 2.20 | 7.83×10 ⁻¹ | 3.38×10 ⁻¹ | 7.42×10 ⁻¹ | 8.59 | 5.72 | 1.12×10 ¹ | 6.71 | 2.78×10 ⁻¹ | 1.32×10 ¹ | 2.28×10 ⁻¹ | 8.94 | 5.89×10 ¹ |
| Plutonium-239, -240 | 3.56×10 ³ | 9.83×10 ² | 1.42×10 ³ | 2.10×10 ³ | 1.32×10 ³ | 2.16×10 ⁴ | 5.00×10 ³ | 6.99×10 ³ | 1.43×10 ³ | 1.82×10 ⁴ | 4.04×10 ² | 3.89×10 ³ | 6.69×10 ⁴ |

Source: DOE 2003a.

Table D-5. Double-Shell Tank Radiological Constituent Inventories by Tank Farm (curies)

| Analyte | Tank Farm | | | | | | Total |
|-------------------------------|----------------------|----------------------|----------------------|-----------------------|----------------------|----------------------|----------------------|
| | AN | AP | AW | AY | AZ | SY | |
| Hydrogen-3 (tritium) | 1.18×10 ² | 1.53×10 ³ | 1.70×10 ² | 2.47×10 ¹ | 1.87×10 ² | 1.09×10 ³ | 3.12×10 ³ |
| Carbon-14 | 1.93×10 ² | 1.97×10 ² | 8.95×10 ¹ | 1.65 | 1.04×10 ¹ | 3.81×10 ¹ | 5.29×10 ² |
| Strontium-90 | 1.05×10 ⁶ | 5.20×10 ⁴ | 2.89×10 ⁵ | 6.66×10 ⁶ | 7.95×10 ⁶ | 2.18×10 ⁵ | 1.62×10 ⁷ |
| Technetium-99 | 3.68×10 ³ | 4.07×10 ³ | 1.86×10 ³ | 8.93×10 ¹ | 2.04×10 ³ | 2.46×10 ³ | 1.42×10 ⁴ |
| Iodine-129 | 3.81 | 7.69 | 2.11 | 1.42×10 ⁻¹ | 1.91 | 2.66 | 1.83×10 ¹ |
| Cesium-137 | 8.46×10 ⁶ | 5.36×10 ⁶ | 3.26×10 ⁶ | 2.89×10 ⁵ | 9.84×10 ⁶ | 2.58×10 ⁶ | 2.98×10 ⁷ |
| Uranium-233, -234, -235, -238 | 7.88 | 2.85 | 3.93×10 ¹ | 3.20 | 5.67 | 4.50 | 6.34×10 ¹ |
| Neptunium-237 | 8.17 | 1.43×10 ¹ | 2.39×10 ¹ | 5.03 | 2.70×10 ¹ | 3.80 | 8.22×10 ¹ |
| Plutonium-239, -240 | 4.70×10 ² | 2.48×10 ¹ | 3.02×10 ³ | 2.66×10 ³ | 3.52×10 ³ | 4.88×10 ³ | 1.46×10 ⁴ |

Source: DOE 2003a.

Table D-6. Single-Shell Tank Nonradiological Constituent Inventories by Tank Farm (kilograms)

| Analyte | Tank Farm | | | | | | | | | | | | Total |
|--------------|----------------------|----------------------|----------------------|----------------------|----------------------|----------------------|----------------------|----------------------|----------------------|----------------------|----------------------|----------------------|----------------------|
| | A | AX | B | BX | BY | C | S | SX | T | TX | TY | U | |
| Chromium | 1.62×10 ⁴ | 7.87×10 ³ | 1.11×10 ⁴ | 2.20×10 ⁴ | 7.34×10 ⁴ | 5.60×10 ³ | 1.20×10 ⁵ | 1.05×10 ⁵ | 1.21×10 ⁴ | 6.13×10 ⁴ | 7.95×10 ³ | 5.11×10 ⁴ | 4.95×10 ⁵ |
| Mercury | 1.59×10 ² | 4.27×10 ¹ | 1.38×10 ² | 2.27×10 ² | 1.74×10 ² | 3.93×10 ² | 7.15×10 ¹ | 1.46×10 ² | 1.99×10 ¹ | 2.83×10 ¹ | 2.56×10 ² | 2.55×10 ¹ | 1.68×10 ³ |
| Nitrate | 1.41×10 ⁶ | 7.63×10 ⁵ | 1.90×10 ⁶ | 1.73×10 ⁶ | 6.62×10 ⁶ | 6.56×10 ⁵ | 1.10×10 ⁷ | 6.62×10 ⁶ | 7.47×10 ⁵ | 1.40×10 ⁷ | 8.37×10 ⁵ | 5.46×10 ⁶ | 5.18×10 ⁷ |
| Lead | 4.02×10 ³ | 1.26×10 ³ | 6.69×10 ³ | 3.66×10 ³ | 5.12×10 ³ | 2.32×10 ⁴ | 2.23×10 ³ | 1.75×10 ³ | 4.34×10 ³ | 7.12×10 ³ | 1.39×10 ³ | 1.08×10 ⁴ | 7.16×10 ⁴ |
| Uranium | 1.10×10 ⁴ | 1.48×10 ³ | 2.86×10 ⁴ | 7.35×10 ⁴ | 6.55×10 ⁴ | 1.13×10 ⁵ | 5.19×10 ⁴ | 3.27×10 ⁴ | 3.72×10 ⁴ | 4.56×10 ⁴ | 3.24×10 ⁴ | 4.97×10 ⁴ | 5.42×10 ⁵ |
| Acetonitrile | 0 | 0 | 0 | 0 | 0 | 0 | 0 | 0 | 0 | 0 | 0 | 0 | 0 |
| Benzene | 0 | 0 | 0 | 0 | 0 | 0 | 0 | 0 | 0 | 0 | 0 | 0 | 0 |
| Butanol | 0 | 0 | 0 | 0 | 0 | 0 | 0 | 0 | 0 | 0 | 0 | 0 | 0 |
| PCBs | 3.05×10 ¹ | 1.47×10 ¹ | 5.44×10 ¹ | 4.18×10 ¹ | 1.11×10 ² | 4.67×10 ¹ | 1.39×10 ² | 9.23×10 ¹ | 4.93×10 ¹ | 1.73×10 ² | 1.68×10 ¹ | 8.53×10 ¹ | 8.54×10 ² |
| 2,4,6-TCP | 0 | 0 | 0 | 0 | 0 | 0 | 0 | 0 | 0 | 0 | 0 | 0 | 0 |

Key: 2,4,6-TCP=2,4,6-trichlorophenol; butanol=n-butyl alcohol; PCBs=polychlorinated biphenyls.

Source: DOE 2003a; SAIC 2007a.

Table D-7. Double-Shell Tank Nonradiological Constituent Inventories by Tank Farm (kilograms)

| Analyte | Tank Farm | | | | | | Total |
|---------------------------|-----------------------|-----------------------|-----------------------|-----------------------|-----------------------|-----------------------|----------------------|
| | AN | AP | AW | AY | AZ | SY | |
| Chromium | 1.85×10 ⁴ | 1.03×10 ⁴ | 1.99×10 ⁴ | 2.79×10 ³ | 5.09×10 ³ | 4.73×10 ⁴ | 1.04×10 ⁵ |
| Mercury | 4.66 | 0 | 2.09×10 ⁻¹ | 1.26×10 ² | 4.15 | 8.95 | 1.44×10 ² |
| Nitrate | 6.47×10 ⁶ | 5.65×10 ⁶ | 3.47×10 ⁶ | 1.70×10 ⁵ | 7.74×10 ⁵ | 2.48×10 ⁶ | 1.90×10 ⁷ |
| Lead | 3.63×10 ³ | 9.01×10 ² | 1.51×10 ³ | 4.48×10 ³ | 4.03×10 ² | 1.57×10 ³ | 1.25×10 ⁴ |
| Uranium | 2.68×10 ³ | 1.23×10 ³ | 3.95×10 ⁴ | 3.52×10 ³ | 5.19×10 ³ | 2.38×10 ³ | 5.45×10 ⁴ |
| Acetonitrile | 7.33×10 ³ | 9.63×10 ³ | 5.67×10 ³ | 1.13×10 ³ | 2.61×10 ³ | 3.11×10 ³ | 2.95×10 ⁴ |
| Benzene | 5.97×10 ⁻¹ | 7.85×10 ⁻¹ | 4.62×10 ⁻¹ | 9.19×10 ⁻² | 2.13×10 ⁻¹ | 2.53×10 ⁻¹ | 2.40 |
| Butanol (n-butyl alcohol) | 8.59×10 ⁵ | 1.13×10 ⁶ | 6.63×10 ⁵ | 1.32×10 ⁵ | 3.06×10 ⁵ | 3.64×10 ⁵ | 3.45×10 ⁶ |
| Polychlorinated biphenyls | 2.07×10 ² | 2.71×10 ² | 1.60×10 ² | 3.18×10 ¹ | 7.36×10 ¹ | 8.76×10 ¹ | 8.31×10 ² |
| 2,4,6-Trichlorophenol | 2.75×10 ⁻¹ | 3.62×10 ⁻¹ | 2.13×10 ⁻¹ | 4.23×10 ⁻² | 9.81×10 ⁻² | 1.17×10 ⁻¹ | 1.11 |

Source: DOE 2003a; SAIC 2007a.

The volatile constituents acetonitrile, benzene, butanol (n-butyl alcohol), and 2,4,6-trichlorophenol were assumed to be present in the aqueous phase and therefore present in the DST farms. Due to the completion of interim stabilization activities in the SSTs, which removed the remaining secondary quantities of supernatant from the tanks, only small quantities of volatile constituents may be present in the SST farms; for analysis purposes, these small quantities were assumed to be zero. Nonvolatile constituents such as PCBs were assumed present at both the SST and DST farms.

Estimation of inventory mass for the five screened chemical constituents not included in the BBI used data for waste volume (see Table D-3) and waste phase; concentration of the gas, liquid, or solid phase; density of the phase; and mole fraction. The type of calculation conducted depended upon two factors: the waste phase and the tank farm.

For volatile, nonradiological constituents with measured liquid-phase concentrations (benzene, 2,4,6-trichlorophenol), the inventory mass is equal to the product of the chemical concentration and the tank farm inventory volume.

$$M_{BBITF} = [C_{\text{chemical}}] \times V_{BBITF} \times \zeta_m \times \zeta_v$$

where:

| | |
|-----------------------|--|
| M_{BBITF} | = inventory mass for each tank farm, grams |
| C_{chemical} | = concentration of the benzene or 2,4,6-trichlorophenol, micrograms per milliliter |
| V_{BBITF} | = inventory volume for each tank farm, liters |
| ζ_m | = conversion constant, grams per micrograms |
| ζ_v | = conversion constant, milliliters per liter |

For the volatile, nonradiological constituents with measured vapor phase concentrations (acetonitrile and butanol [n-butyl alcohol]), four calculations needed to be performed. First, the vaporization pressure was calculated using Antoine's equation. Second, the measured gas-phase concentration was converted to partial pressure using the ideal gas law. Next, Raoult's law was used to determine the molar fraction of the species in the liquid phase. The final calculation for determining the inventory mass was the product of the mole fraction and the ratio of the species' molar mass over the water molar mass times the tank farm inventory volume.

For the first step of the estimation procedure, the equilibrium partial pressure of the constituent was calculated using Antoine's equation:

$$\ln P_{\text{vap}} = A - \frac{B}{T + C}$$

where:

| | |
|------------------|---|
| P_{vap} | = pressure of vaporization for the chemical, millimeters of mercury at 25 degrees Celsius ($^{\circ}\text{C}$) (77 degrees Fahrenheit [$^{\circ}\text{F}$]) |
| A, B, C | = constants for each chemical (SAIC 2007b) |
| T | = temperature of the chemical after transfer to DTS, assumed to be 298 kelvins (K) |

In the second step, the partial pressure of the constituent in the vapor phase is calculated using the ideal gas law:

$$P_{\text{partial}} = 760 \times \frac{[C_{\text{chemical}}] \times R \times T}{MW}$$

where:

| | |
|-----------------------|--|
| P_{partial} | = partial pressure of the chemical, millimeters of mercury |
| C_{chemical} | = concentration of acetonitrile or butanol (n-butyl alcohol), milligrams per cubic meter |
| R | = gas constant, assumed to be 0.082-liter atmosphere per mole-K |
| T | = temperature of the chemical, assumed to be 298 K |
| MW | = molecular weight of the chemical species, grams per mole |

Next, Raoult's law is utilized to calculate the mole fraction of the constituent in the liquid phase:

$$x = \frac{P_{\text{partial}}}{P_{\text{vap}}}$$

where:

| | |
|----------------------|---|
| x | = mole fraction |
| P_{partial} | = partial pressure of the chemical, millimeters of mercury |
| P_{vap} | = pressure of vaporization for the chemical, millimeters of mercury |

Finally, the mole fraction may be converted to a mass fraction and used to calculate the inventory mass:

$$M_{BBITF} = x \times \frac{MW_{\text{species}}}{MW_{\text{H}_2\text{O}}} \times \rho_l \times BBITF \times 10^3$$

where:

| | |
|---------------------------|--|
| M_{BBITF} | = inventory mass for each tank farm, grams |
| x | = mole fraction |
| MW_{species} | = molecular weight of the chemical species, grams per mole |
| $MW_{\text{H}_2\text{O}}$ | = molecular weight of water, grams per mole |
| ρ_l | = density of the tank farm liquid, grams per cubic centimeter (SAIC 2007b) |
| $BBITF$ | = inventory volume for each tank farm, liters |

For nonvolatile, nonradiological constituents (PCBs), the inventory masses would be equivalent to the products of the phase concentration times the density of the phase times the tank farm inventory volume. Even though PCBs were not detected in some tanks in certain tank farms, the inventory data were spread across all the tank farms to ensure the maximum mass was determined. PCBs, which are nonvolatile chemical constituents, have been detected in 12 of 55 tanks sampled. The average concentrations of 14 solid-phase samples (DOE 2003a) are 7.08 micrograms per gram. Using this average concentration and assuming that PCBs are present in all tanks, the inventory of each tank farm was estimated as:

$$M_{BBITF} = [C_{\text{chemical}}] \times \rho_s \times BBITF \times \zeta_m \times \zeta_v$$

where:

| | |
|-----------------------|--|
| M_{BBITF} | =inventory mass for each tank farm, grams |
| C_{chemical} | =concentration of the PCBs, micrograms per gram |
| ρ_s | =density of the solid, grams per cubic centimeter (SAIC 2007b) |
| V_{BBITF} | =inventory volume for each tank farm, liters |
| ζ_m | =conversion constant, grams per microgram |
| ζ_v | =conversion constant, cubic centimeters per liter |

D.1.1.4 Uncertainty in Best-Basis Inventories

The BBI process follows protocols developed to combine differing types of measurements and estimates to produce the most reliable estimate of inventory. However, the high-level radioactive waste (HLW) tank inventory estimates contain considerable uncertainty regarding the number and quality of the available measurements and the estimation procedures that were used in the absence of measurements. As described in Section D.1.1, the HLW tank inventory estimates were based on waste composition and phase volume measurements, process knowledge calculations, and waste-type templates that were developed based on the sample data and model estimates (Field and Bowen 2003). Six types of waste phases were considered in developing these estimates: supernatant, salt cake solids, salt cake liquids, sludge solids, sludge liquids, and gas. Process knowledge calculations included correlation with a known constituent such as a parent radionuclide with a well-established ratio of parent-to-progeny concentration. The model-derived waste template estimates used in this *TC & WM EIS* were based on Revision 4 of the HDW model (Agnew et al. 1997). Sample analysis data provided the preferred bases for the estimates; calculated and template-based information were assigned lower priority. In each case, the inventory estimates were derived as the products of waste density, volume, and composition.

The uncertainty in the measurement-based estimation is due to the limited number of available samples, the complex nature of the tank contents, and the number of transfers and process activities used to manage the waste. The number of available samples is limited due to safety issues and the cost of obtaining them. Because waste phases are not uniform in nature and may be mixed to some extent, estimates of phase volumes and constituent concentrations are uncertain due to measurement and spatial variability. Processing and transfers designed to increase safety and optimize tank utilization produce additional variation among individual tanks. Estimating inventories using process modeling involves consideration of reactor fuel irradiation and chemical separations operations, as well as transfer and processing of tank contents. Incomplete knowledge of the degree of irradiation, process extraction and separations efficiencies, plant stream flow rates that affect recovery and distribution, and process losses to the environment all contribute to uncertainty in developing process modeling inventory estimates.

Quantitative estimates of inventory variability were expressed using the relative standard deviation (RSD), which is defined as the ratio of the standard deviation to the mean. RSD values were estimated from tank sample or sample-based template data. Sample-based templates are averages of samples taken from tanks whose contents are similar in composition to the contents of the tank for which samples are not available. The RSD values for density were reported as 5.9 and 8.2 percent for SST and DST liquids, respectively, and 7.6 and 6.5 percent for SST and DST solids, respectively (Field and Bowen 2003). Because of the difficulty in determining the extent of phase volumes and in measuring volume, values of RSD values for volume were based on quantitative and qualitative information. Five data sources were used to estimate volume: surface-level, conductivity probe, sludge-level, liquid-observation well measurements, and core profiles. For the supernatant, salt cake, and sludge tanks, the average standard deviations of the surface-level readings were 0.64, 29.2, and 10.9 centimeters (0.25, 11.5, and 4.3 inches), corresponding to 2.6, 120, and 45 cubic meters (687; 31,700; and 11,888 gallons), respectively. The RSD for estimating volume was calculated as the standard deviation of the level divided by the total height of

the waste in the tank. The mean concentration and its RSD were estimated for the constituents in each waste phase based on sample data. Estimates of concentration RSD based on sample data can range from 0 to 100 percent, while those based on waste-type templates can be much larger (Field and Bowen 2003). Median sample-based RSDs for the inventories in the SSTs and DSTs were calculated at 20 and 29 percent, respectively (DOE 2003a). Median template-based RSDs for inventories of SSTs and DSTs were calculated at 164 and 182 percent, respectively (DOE 2003a).

The above information on RSDs for density, volume, and concentration was combined to develop estimates of inventory RSDs for the individual constituents contained within each tank and at each tank farm (DOE 2003a). For four long-lived radionuclides that are important in determining groundwater impacts—technetium-99, iodine-129, uranium-238, and neptunium-237—RSDs for inventories at the tank farm level ranged from 70 to 231 percent, 44 to 231 percent, 77 to 453 percent, and 46 to 473 percent, respectively. Further quantitative estimates would require assumptions that cannot be fully tested using the current data. For example, regarding the assumption of normal data distribution, the 95th percentile upper confidence limit of the technetium-99 inventories in individual tank farms ranged from 2.2 to 5.6 times the BBI estimate across the 18 tank farms. For the combination of variances, the 95th percentile upper confidence limit of the total technetium-99 inventory was approximately 20 percent greater than the BBI estimate.

The above considerations indicate that greater uncertainty is involved in estimating the inventories of individual tanks and tank farms compared to estimating total inventory, and greater uncertainty is associated with using template-based estimates compared with using sample-based estimates.

D.1.1.5 Best-Basis Inventory Comparison

As required by the *Technical Guidance Document for Tank Closure Environmental Impact Statement, Addendum One and Groundwater Revised Analyses* (DOE 2005), Table D–8 compares the radiological and chemical COPCs for the December 2002 BBI estimate (DOE 2003a) with the April 2008 update to the BBI estimate. The April 2008 BBI update was the latest current update to the BBI available for inclusion in this EIS. For comparison purposes, the table includes the radionuclides decayed to the same date, January 1, 2008.

The differences noted in Table D–8 are primarily due to the BBI Improvement Initiative, which was implemented after December 2002, and included:

- Updated ORIGEN2 [Oak Ridge Isotope Generation and Depletion Code] (Croff 1980) fuel activity estimates.
- Updated HDW model to Revision 5, which accounted for a release of hydrogen-3 (tritium), carbon-14, and iodine-129 to the environment and offsite shipment of technetium-99 with uranium.
- Updated BBI templates with new sample data that added a second type of Reduction-Oxidation Facility waste to the SX tank farm, resulting in an increase in SX tank farm inventory.
- Eliminated non-credible sample detection limit values from inventory estimates.
- Incorporated new sample data, including iodine-129 analysis of BY tank farm salt cake (CH2M HILL 2008).

Table D-8. Best-Basis Inventory Comparison of Constituents of Potential Concern

| | Column 1 December 2002 BBI, Decay Date: January 1, 2001 | Column 2 December 2002 BBI, Decay Date: January 1, 2008 | Column 3 April 2008 BBI, Decay Date: January 1, 2008 | Percent Change from Decayed December 2002 BBI: (Column 3 - Column 2) /Column 2 |
|----------------------------------|--|--|---|---|
| Radionuclides | Curies | Curies | Curies | Percent |
| Americium-241 | 1.45×10^5 | 1.45×10^5 | 1.58×10^5 | +9.0 |
| Carbon-14 | 3.12×10^3 | 3.12×10^3 | 5.88×10^2 | -81.2 |
| Cesium-137 | 4.58×10^7 | 3.90×10^7 | 3.90×10^7 | 0.0 |
| Hydrogen-3 (tritium) | 1.21×10^4 | 8.16×10^3 | 3.11×10^3 | -61.9 |
| Iodine-129 | 4.82×10^1 | 4.82×10^1 | 2.97×10^1 | -38.4 |
| Neptunium-237 | 1.41×10^2 | 1.41×10^2 | 1.20×10^2 | -14.9 |
| Plutonium-239, -240 | 8.14×10^4 | 8.14×10^4 | 6.14×10^4 | -24.6 |
| Strontium-90 | 5.05×10^7 | 4.27×10^7 | 4.82×10^7 | +12.9 |
| Technetium-99 | 2.97×10^4 | 2.97×10^4 | 2.66×10^4 | -10.4 |
| Uranium-233, -234, -235, -238 | 9.38×10^2 | 9.38×10^2 | 1.14×10^3 | +21.8 |
| Chemicals | Kilograms | Kilograms | Kilograms | Percent |
| Acetonitrile | NR | NR | NR | N/A |
| Benzene | NR | NR | NR | N/A |
| Butanol (n-butyl alcohol) | NR | NR | NR | N/A |
| Chromium | 5.98×10^5 | 5.98×10^5 | 5.89×10^5 | -1.5 |
| Lead | 8.41×10^4 | 8.41×10^4 | 8.33×10^4 | -1.0 |
| Mercury | 1.83×10^3 | 1.83×10^3 | 1.99×10^3 | +8.7 |
| Nitrate ^a | 6.67×10^7 | 6.67×10^7 | 6.71×10^7 | +0.6 |
| Uranium (total) | 5.97×10^5 | 5.97×10^5 | 6.49×10^5 | +8.7 |
| Polychlorinated biphenyls | NR | NR | NR | N/A |
| 2,4,6- Trichlorophenol | NR | NR | NR | N/A |

^a Nitrate and nitrite inventories reported as nitrate.

Key: BBI=Best-Basis Inventory; N/A=not applicable; NR=not reported.

Source: CH2M HILL 2008.

D.1.2 Tank Ancillary Equipment Waste

This section presents the estimated waste inventories contained in the ancillary facilities that are currently part of the SST and DST systems. Ancillary equipment includes miscellaneous underground storage tanks (MUSTs) (i.e., vaults), SST system tanks, DST system tanks, and the evaporators, evaporator tanks and vessels, pits, and transfer piping (DOE 2003a, 2003b) associated with the SST and DST farms.

Approximately one-half of the total waste volume estimate for ancillary equipment is credited to the MUSTs. Identification, dimensions, and locations of the MUSTs have been documented (DOE 2003a, 2003b). The reported capacities of the MUSTs range from 10 cubic meters (2,640 gallons) to 190 cubic meters (50,200 gallons) (DOE 2003b).

The pits include heel, pump, salt well, sluice, flush, and valve pits and diversion boxes. The SST farm volumes were derived by assuming a deposition of waste solids with an average thickness of only about 0.01 to 0.02 centimeters (0.004 to 0.008 inches) on the surfaces of the pits and piping (DOE 2003a). Waste volumes for the pits in the DST system were estimated by multiplying the waste volumes in the SST system pits by the ratio of DST system pit surface area to the SST system pit surface area. Waste

volumes for the piping in the DST system were estimated in a similar manner. Volumes and surface areas were developed based on extrapolating information from detailed analyses of three SST farms and applying it to the other tank farms. DST void volumes in piping and structures were based on measurements of the six SSTs in the 241-A tank farm, which were then multiplied by a factor of 28/6 to obtain volumes for all 28 DSTs.

For analysis purposes, the volume of waste in the ancillary equipment for a given tank farm was taken as the product of total waste volume in ancillary equipment for all tank farms times the number of tanks in a given tank farm, divided by the total number of tanks in the entire SST/DST system. Additionally, the concentration of each waste constituent in the ancillary equipment for a given tank farm was assumed to be the same as the average concentration of that constituent in the corresponding tank farm waste.

The inventories of radiological and nonradiological waste constituents in the ancillary equipment for a given tank farm were therefore calculated as the volume of waste in the ancillary equipment for that tank farm times the concentrations of each of those constituents in the waste currently stored in that tank farm. For example, the inventory of chromium in the ancillary equipment for the S tank farm was calculated as the volume of waste in the ancillary equipment for the S tank farm times the BBI mass of chromium in the S tank farm waste, divided by the volume of waste currently stored in the S tank farm. Radiological inventories were calculated similarly, with inventories and concentrations expressed in terms of curies rather than grams.

Volumes of ancillary equipment waste and quantities of individual constituents were estimated as:

$$V_{\text{anc}} = \frac{V_{\text{anc,tot}}}{N_{\text{tot}}} \times N_{\text{tanks}}$$

and

$$M_{\text{anc}} = \frac{M_{\text{BBITF}}}{V_{\text{BBITF}}} \times V_{\text{anc}}$$

where:

- M_{BBITF} = waste inventory mass for each tank farm, grams or curies
- V_{anc} = ancillary equipment volume for each tank farm, liters
- $V_{\text{anc,tot}}$ = total ancillary equipment volume, liters
- V_{BBITF} = inventory volume for each tank farm, liters
- N_{tanks} = number of tanks in tank farm
- N_{tot} = total number of tanks
- M_{anc} = waste inventory ancillary equipment for each tank farm, grams or curies

Tables D-9 and D-10 represent the ancillary equipment waste radiological and nonradiological constituents for the SSTs, respectively. Tables D-11 and D-12 represent the ancillary equipment waste radiological and nonradiological constituents for the DSTs, respectively.

Table D-9. Single-Shell Tank Ancillary Equipment Radiological Constituent Inventories (curies)

| Analyte | Tank Farm | | | | | | | | | | | | Total |
|-------------------------|-----------------------|-----------------------|-----------------------|-----------------------|-----------------------|-----------------------|-----------------------|-----------------------|-----------------------|-----------------------|-----------------------|-----------------------|-----------------------|
| | A | AX | B | BX | BY | C | S | SX | T | TX | TY | U | |
| H-3 (tritium) | 2.74 | 1.46 | 2.51×10 ⁻¹ | 1.20 | 5.94 | 1.55 | 6.92 | 8.83 | 4.58×10 ⁻¹ | 9.16 | 5.14×10 ⁻¹ | 1.12×10 ¹ | 5.02×10 ¹ |
| C-14 | 6.77×10 ⁻¹ | 7.21×10 ⁻¹ | 9.56×10 ⁻² | 4.96×10 ⁻¹ | 2.50 | 2.22×10 ⁻¹ | 1.80 | 1.94 | 1.98×10 ⁻¹ | 2.78 | 1.12×10 ⁻¹ | 2.75 | 1.43×10 ¹ |
| Sr-90 | 5.29×10 ⁴ | 3.46×10 ⁴ | 2.29×10 ⁴ | 1.54×10 ⁴ | 7.82×10 ³ | 1.29×10 ⁵ | 8.98×10 ³ | 3.54×10 ⁴ | 4.98×10 ³ | 5.02×10 ³ | 4.86×10 ³ | 6.99×10 ³ | 3.29×10 ⁵ |
| Tc-99 | 5.47 | 4.63 | 2.59 | 4.38 | 1.13×10 ¹ | 4.95 | 9.76 | 1.18×10 ¹ | 2.18 | 1.62×10 ¹ | 1.50 | 1.88×10 ¹ | 9.35×10 ¹ |
| I-129 | 7.67×10 ⁻³ | 5.38×10 ⁻³ | 9.92×10 ⁻⁴ | 5.31×10 ⁻³ | 2.47×10 ⁻² | 1.40×10 ⁻² | 2.11×10 ⁻² | 2.25×10 ⁻² | 1.52×10 ⁻³ | 3.07×10 ⁻² | 1.89×10 ⁻³ | 3.62×10 ⁻² | 1.72×10 ⁻¹ |
| Cs-137 | 1.00×10 ⁴ | 7.37×10 ³ | 4.34×10 ³ | 3.86×10 ³ | 9.96×10 ³ | 1.40×10 ⁴ | 9.26×10 ³ | 1.79×10 ⁴ | 2.20×10 ³ | 1.05×10 ⁴ | 7.73×10 ² | 1.79×10 ⁴ | 1.08×10 ⁵ |
| U-233, -234, -235, -238 | 2.67×10 ⁻¹ | 4.08×10 ⁻² | 2.53×10 ⁻¹ | 6.03×10 ⁻¹ | 2.33×10 ⁻¹ | 7.03 | 1.85×10 ⁻¹ | 1.98×10 ⁻¹ | 3.47×10 ⁻¹ | 2.06×10 ⁻¹ | 3.28×10 ⁻¹ | 3.01×10 ⁻¹ | 9.99 |
| Np-237 | 1.78×10 ⁻² | 8.77×10 ⁻³ | 4.10×10 ⁻³ | 8.79×10 ⁻³ | 3.83×10 ⁻² | 8.08×10 ⁻² | 3.99×10 ⁻² | 4.50×10 ⁻² | 3.72×10 ⁻³ | 5.66×10 ⁻² | 3.35×10 ⁻³ | 6.91×10 ⁻² | 3.76×10 ⁻¹ |
| Pu-239, -240 | 2.89×10 ¹ | 1.10×10 ¹ | 1.72×10 ¹ | 2.49×10 ¹ | 5.87 | 3.04×10 ² | 1.78×10 ¹ | 4.68×10 ¹ | 1.92×10 ¹ | 7.82×10 ¹ | 5.94 | 3.01×10 ¹ | 5.90×10 ² |

Key: C=carbon; Cs=cesium; H=hydrogen; I=iodine; Np=neptunium; Pu=plutonium; Sr=strontium; Tc=technetium; U=uranium.

Source: SAIC 2007c.

Table D-10. Single-Shell Tank Ancillary Equipment Nonradiological Constituent Inventories (grams)

| Analyte | Tank Farm | | | | | | | | | | | | Total |
|--------------|----------------------|----------------------|----------------------|----------------------|----------------------|----------------------|----------------------|----------------------|----------------------|----------------------|----------------------|----------------------|----------------------|
| | A | AX | B | BX | BY | C | S | SX | T | TX | TY | U | |
| Chromium | 1.32×10 ⁵ | 8.80×10 ⁴ | 1.34×10 ⁵ | 2.61×10 ⁵ | 3.27×10 ⁵ | 7.90×10 ⁴ | 4.29×10 ⁵ | 7.07×10 ⁵ | 1.62×10 ⁵ | 2.64×10 ⁵ | 1.17×10 ⁵ | 3.95×10 ⁵ | 3.09×10 ⁶ |
| Mercury | 1.29×10 ³ | 4.78×10 ² | 1.68×10 ³ | 2.69×10 ³ | 7.74×10 ² | 5.55×10 ³ | 2.55×10 ² | 9.80×10 ² | 2.66×10 ² | 1.22×10 ² | 3.76×10 ³ | 1.97×10 ² | 1.80×10 ⁴ |
| Nitrate | 1.15×10 ⁷ | 8.55×10 ⁶ | 2.30×10 ⁷ | 2.04×10 ⁷ | 2.95×10 ⁷ | 9.25×10 ⁶ | 3.93×10 ⁷ | 4.44×10 ⁷ | 9.98×10 ⁶ | 6.02×10 ⁷ | 1.23×10 ⁷ | 4.22×10 ⁷ | 3.11×10 ⁸ |
| Lead | 3.26×10 ⁴ | 1.41×10 ⁴ | 8.12×10 ⁴ | 4.34×10 ⁴ | 2.28×10 ⁴ | 3.27×10 ⁵ | 7.96×10 ³ | 1.17×10 ⁴ | 5.80×10 ⁴ | 3.06×10 ⁴ | 2.04×10 ⁴ | 8.37×10 ⁴ | 7.34×10 ⁵ |
| Uranium | 8.90×10 ⁴ | 1.66×10 ⁴ | 3.47×10 ⁵ | 8.70×10 ⁵ | 2.92×10 ⁵ | 1.59×10 ⁶ | 1.85×10 ⁵ | 2.19×10 ⁵ | 4.97×10 ⁵ | 1.96×10 ⁵ | 4.75×10 ⁵ | 3.84×10 ⁵ | 5.16×10 ⁶ |
| Acetonitrile | 0 | 0 | 0 | 0 | 0 | 0 | 0 | 0 | 0 | 0 | 0 | 0 | 0 |
| Benzene | 0 | 0 | 0 | 0 | 0 | 0 | 0 | 0 | 0 | 0 | 0 | 0 | 0 |
| Butanol | 0 | 0 | 0 | 0 | 0 | 0 | 0 | 0 | 0 | 0 | 0 | 0 | 0 |
| PCBs | 2.47×10 ² | 1.65×10 ² | 6.59×10 ² | 4.95×10 ² | 4.95×10 ² | 6.59×10 ² | 4.95×10 ² | 6.18×10 ² | 6.59×10 ² | 7.42×10 ² | 2.47×10 ² | 6.59×10 ² | 6.14×10 ³ |
| 2,4,6-TCP | 0 | 0 | 0 | 0 | 0 | 0 | 0 | 0 | 0 | 0 | 0 | 0 | 0 |

Key: 2,4,6-TCP=2,4,6-trichlorophenol; butanol=n-butyl alcohol; PCBs=polychlorinated biphenyls.

Source: SAIC 2007b, 2007c.

Table D–11. Double-Shell Tank Ancillary Equipment Radiological Constituent Inventories (curies)

| Analyte | Tank Farm | | | | | | Total |
|-------------------------------|-----------------------|-----------------------|-----------------------|-----------------------|-----------------------|-----------------------|-----------------------|
| | AN | AP | AW | AY | AZ | SY | |
| Hydrogen-3 (tritium) | 4.16×10 ⁻¹ | 4.70 | 6.64×10 ⁻¹ | 1.62×10 ⁻¹ | 5.30×10 ⁻¹ | 3.90 | 1.04×10 ¹ |
| Carbon-14 | 6.80×10 ⁻¹ | 6.05×10 ⁻¹ | 3.50×10 ⁻¹ | 1.08×10 ⁻² | 2.93×10 ⁻² | 1.36×10 ⁻¹ | 1.81 |
| Strontium-90 | 3.70×10 ³ | 1.60×10 ² | 1.13×10 ³ | 4.37×10 ⁴ | 2.25×10 ⁴ | 7.78×10 ² | 7.19×10 ⁴ |
| Technetium-99 | 1.30×10 ¹ | 1.25×10 ¹ | 7.28 | 5.86×10 ⁻¹ | 5.77 | 8.76 | 4.79×10 ¹ |
| Iodine-129 | 1.35×10 ⁻² | 2.36×10 ⁻² | 8.24×10 ⁻³ | 9.29×10 ⁻⁴ | 5.40×10 ⁻³ | 9.51×10 ⁻³ | 6.11×10 ⁻² |
| Cesium-137 | 2.98×10 ⁴ | 1.65×10 ⁴ | 1.28×10 ⁴ | 1.89×10 ³ | 2.78×10 ⁴ | 9.20×10 ³ | 9.80×10 ⁴ |
| Uranium-233, -234, -235, -238 | 2.78×10 ⁻² | 8.74×10 ⁻³ | 1.54×10 ⁻¹ | 2.10×10 ⁻² | 1.60×10 ⁻² | 1.61×10 ⁻² | 2.43×10 ⁻¹ |
| Neptunium-237 | 2.88×10 ⁻² | 4.40×10 ⁻² | 9.34×10 ⁻² | 3.30×10 ⁻² | 7.64×10 ⁻² | 1.36×10 ⁻² | 2.89×10 ⁻¹ |
| Plutonium-239, -240 | 1.66 | 7.61×10 ⁻² | 1.18×10 ¹ | 1.75×10 ¹ | 9.97 | 1.74×10 ¹ | 5.84×10 ¹ |

Source: SAIC 2007c.

Table D–12. Double-Shell Tank Ancillary Equipment Nonradiological Constituent Inventories (grams)

| Analyte | Tank Farm | | | | | | Total |
|---------------------------|-----------------------|----------------------|-----------------------|-----------------------|-----------------------|-----------------------|----------------------|
| | AN | AP | AW | AY | AZ | SY | |
| Chromium | 6.54×10 ⁴ | 3.18×10 ⁴ | 7.78×10 ⁴ | 1.83×10 ⁴ | 1.44×10 ⁴ | 1.69×10 ⁵ | 3.76×10 ⁵ |
| Mercury | 1.64×10 ¹ | 0 | 8.18×10 ⁻¹ | 8.26×10 ² | 1.18×10 ¹ | 3.19×10 ¹ | 8.87×10 ² |
| Nitrate | 2.28×10 ⁷ | 1.73×10 ⁷ | 1.36×10 ⁷ | 1.12×10 ⁶ | 2.19×10 ⁶ | 8.86×10 ⁶ | 6.59×10 ⁷ |
| Lead | 1.28×10 ⁴ | 2.77×10 ³ | 5.93×10 ³ | 2.94×10 ⁴ | 1.14×10 ³ | 5.59×10 ³ | 5.76×10 ⁴ |
| Uranium | 9.46×10 ³ | 3.78×10 ³ | 1.55×10 ⁵ | 2.31×10 ⁴ | 1.47×10 ⁴ | 8.51×10 ³ | 2.14×10 ⁵ |
| Acetonitrile | 2.59×10 ⁴ | 2.96×10 ⁴ | 2.22×10 ⁴ | 7.39×10 ³ | 7.39×10 ³ | 1.11×10 ⁴ | 1.04×10 ⁵ |
| Benzene | 2.11 | 2.41 | 1.81 | 6.02×10 ⁻¹ | 6.02×10 ⁻¹ | 9.04×10 ⁻¹ | 8.43 |
| Butanol (n-butyl alcohol) | 3.03×10 ⁶ | 3.46×10 ⁶ | 2.60×10 ⁶ | 8.66×10 ⁵ | 8.66×10 ⁵ | 1.30×10 ⁶ | 1.21×10 ⁷ |
| Polychlorinated biphenyls | 7.29×10 ² | 8.33×10 ² | 6.25×10 ² | 2.08×10 ² | 2.08×10 ² | 3.13×10 ² | 2.92×10 ³ |
| 2,4,6-Trichlorophenol | 9.72×10 ⁻¹ | 1.11 | 8.33×10 ⁻¹ | 2.78×10 ⁻¹ | 2.78×10 ⁻¹ | 4.17×10 ⁻¹ | 3.89 |

Source: SAIC 2007b, 2007c.

D.1.3 Tank Residual Waste Inventories

Residual waste is defined as the tank waste remaining in the tank after all waste retrieval actions have been completed. The Hanford Federal Facility Agreement and Consent Order, also known as the Tri-Party Agreement (TPA), allows approximately 10 cubic meters (360 cubic feet) of residual waste for 100-series SSTs and 0.9 cubic meters (30 cubic feet) of residual waste for 200-series SSTs following completion of retrieval operations; it also provides a method for determining the allowed residual waste in each tank on a tank-by-tank basis (Ecology, EPA, and DOE 1989). Three levels of retrieval were considered for the *TC & WM EIS* analysis: 90, 99, and 99.9 percent retrieval of the current inventory of radioactive and nonradioactive constituents. These retrieval percentages were developed to address various aspects related to retrieval levels or activities. Ninety percent retrieval was picked to represent a programmatic risk analysis of the tank farms as defined in the TPA Milestone M-45-00, Appendix H, process. Ninety-nine percent retrieval is in the TPA. The 99.9 percent retrieval rate was used in cases where tank removal was analyzed to limit worker exposure. The 99.9 percent retrieval also reflects multiple uses of retrieval technologies.

This appendix describes three proposed methods for estimating residual waste in the storage tanks following retrieval and presents the results for the method selected (first method) for the *TC & WM EIS* analyses. The three methods are:

1. Multiply the existing total tank inventory by a ratio of the final waste volume to the current waste volume. Assume that the inventory is distributed uniformly through the volume. This method represents the case for waste retrieved “as is,” i.e., without washing or leaching. For example, for 99 percent retrieval, the volume of SST residual waste in a specific tank would equal the current waste volume estimate in that tank, based on the 2002 BBI, multiplied by 0.01. This result may differ slightly from the TPA Milestone M-45-00, Appendix H, estimate, which used earlier tank volume estimates that were applied across all the SSTs.
2. A more complex method involves making the following assumptions about which waste phases would remain in the tank following retrieval:
 - All supernatant would be removed, and retained gas would be released from the tank during retrieval.
 - Ten cubic meters (360 cubic feet) of waste would remain in a 100-series SST; (0.9 cubic meters (30 cubic feet) would remain in a 200-series SST.
 - Sludge would be at the bottom of the tank.
 - When a tank contains multiple sludge phases, each would remain in the tank in the same proportions that were present prior to retrieval.
 - For tanks where only salt cake exists, the remaining salt cake would be volumetrically proportional to the volumes currently in the tanks.
 - Tanks 241-TX-116 and 241-TX-117 are exceptions: all waste in these tanks would be removed proportional to current volumes.
 - The fraction of each waste phase remaining (that is, the ratio of current phase volumes for each phase that would remain in the tank following retrieval) is calculated based on the assumptions above.
 - The final remaining constituent inventory (for each phase) is calculated from the initial inventory, current and final volume, and fraction of the phase.
 - The inventories for each phase are then added to get the tank total. This method is representative of dry retrieval by layer without mixing.
3. The third method uses output from the Hanford Tank Waste Operation Simulator model (for radionuclides only) adjusted to the same final volume as the other two methods. This model applies component- and tank-specific water-wash factors and adds sufficient water to achieve either a 5-molar sodium solution or a 10 weight-percent slurry, whichever is the limiting condition for feed to the Waste Treatment Plant (WTP), to predict the composition of waste retrieved from the tank. Waste remaining in the tank after retrieval is assumed to have the same composition as the waste in the tank (*Tank Farm Contractor Operation and Utilization Plan*) (Kirkbride et al. 2002). This method is representative of sluicing-type waste retrieval methods.

Because the last two methods do not provide estimates for both radionuclide and chemical constituents for each level of retrieval, the first method (volume retrieval) was applied. The degree of retrieval applicability across the Tank Closure alternatives is summarized in Table D-13. The inventory results of implementing the radiological constituent procedure for the three retrieval cases are presented in

Tables D–14 through D–19. The inventory results of implementing the chemical constituent procedure for the retrieval cases are presented in Tables D–20 through D–25.

Table D–13. Tank Closure Alternative Retrieval Approaches

| Alternative | Approach |
|--------------------|--|
| 1 | Best-Basis Inventory as salt cake for single-shell tanks, supernatant for double-shell tanks |
| 2A | 99 percent retrieval estimate; residual as salt cake for single-shell tanks and supernatant for double-shell tanks |
| 2B, 3A, 3B, and 3C | 99 percent retrieval estimate; residual stabilized with grout |
| 4 | 99.9 percent retrieval estimate; residual stabilized with grout |
| 5 | 90 percent retrieval estimate; residual stabilized with grout |
| 6A and 6B | 99.9 percent retrieval; tank and soil removed |
| 6C | 99 percent retrieval estimate; residual stabilized with grout |

Table D-14. Single-Shell Tank Residual Radiological Constituent Inventories: 90 Percent Retrieval (curies)

| Analyte | Tank Farm | | | | | | | | | | | | Total |
|-------------------------------|-----------------------|-----------------------|-----------------------|-----------------------|-----------------------|-----------------------|-----------------------|-----------------------|-----------------------|-----------------------|-----------------------|-----------------------|----------------------|
| | A | AX | B | BX | BY | C | S | SX | T | TX | TY | U | |
| Hydrogen-3 (tritium) | 3.38×10 ¹ | 1.30×10 ¹ | 2.07 | 1.01×10 ¹ | 1.33×10 ² | 1.10×10 ¹ | 1.94×10 ² | 1.32×10 ² | 3.42 | 2.13×10 ² | 3.50 | 1.44×10 ² | 8.93×10 ² |
| Carbon-14 | 8.33 | 6.44 | 7.88×10 ⁻¹ | 4.19 | 5.60×10 ¹ | 1.58 | 5.05×10 ¹ | 2.90×10 ¹ | 1.48 | 6.47×10 ¹ | 7.63×10 ⁻¹ | 3.56×10 ¹ | 2.59×10 ² |
| Strontium-90 | 6.52×10 ⁵ | 3.09×10 ⁵ | 1.89×10 ⁵ | 1.30×10 ⁵ | 1.75×10 ⁵ | 9.18×10 ⁵ | 2.52×10 ⁵ | 5.28×10 ⁵ | 3.72×10 ⁴ | 1.17×10 ⁵ | 3.31×10 ⁴ | 9.05×10 ⁴ | 3.43×10 ⁶ |
| Technetium-99 | 6.74×10 ¹ | 4.13×10 ¹ | 2.13×10 ¹ | 3.70×10 ¹ | 2.54×10 ² | 3.51×10 ¹ | 2.74×10 ² | 1.76×10 ² | 1.63×10 ¹ | 3.76×10 ² | 1.02×10 ¹ | 2.43×10 ² | 1.55×10 ³ |
| Iodine-129 | 9.45×10 ⁻² | 4.81×10 ⁻² | 8.18×10 ⁻³ | 4.49×10 ⁻² | 5.55×10 ⁻¹ | 9.93×10 ⁻² | 5.93×10 ⁻¹ | 3.35×10 ⁻¹ | 1.14×10 ⁻² | 7.15×10 ⁻¹ | 1.29×10 ⁻² | 4.69×10 ⁻¹ | 2.99 |
| Cesium-137 | 1.24×10 ⁵ | 6.58×10 ⁴ | 3.58×10 ⁴ | 3.26×10 ⁴ | 2.23×10 ⁵ | 9.93×10 ⁴ | 2.60×10 ⁵ | 2.68×10 ⁵ | 1.65×10 ⁴ | 2.44×10 ⁵ | 5.26×10 ³ | 2.32×10 ⁵ | 1.61×10 ⁶ |
| Uranium-233, -234, -235, -238 | 3.29 | 3.64×10 ⁻¹ | 2.08 | 5.09 | 5.22 | 4.98×10 ¹ | 5.18 | 2.95 | 2.59 | 4.79 | 2.23 | 3.90 | 8.75×10 ¹ |
| Neptunium-237 | 2.20×10 ⁻¹ | 7.83×10 ⁻² | 3.38×10 ⁻² | 7.42×10 ⁻² | 8.59×10 ⁻¹ | 5.72×10 ⁻¹ | 1.12 | 6.71×10 ⁻¹ | 2.78×10 ⁻² | 1.32 | 2.28×10 ⁻² | 8.94×10 ⁻¹ | 5.89 |
| Plutonium-239, -240 | 3.56×10 ² | 9.83×10 ¹ | 1.42×10 ² | 2.10×10 ² | 1.32×10 ² | 2.16×10 ³ | 5.00×10 ² | 6.99×10 ² | 1.43×10 ² | 1.82×10 ³ | 4.04×10 ¹ | 3.89×10 ² | 6.69×10 ³ |

Source: DOE 2003a; SAIC 2007d.

Table D-15. Double-Shell Tank Residual Radiological Constituent Inventories: 90 Percent Retrieval (curies)

| Analyte | Tank Farm | | | | | | Total |
|-------------------------------|-----------------------|-----------------------|-----------------------|-----------------------|-----------------------|-----------------------|----------------------|
| | AN | AP | AW | AY | AZ | SY | |
| Hydrogen-3 (tritium) | 1.18×10 ¹ | 1.53×10 ² | 1.70×10 ¹ | 2.47 | 1.87×10 ¹ | 1.09×10 ² | 3.12×10 ² |
| Carbon-14 | 1.93×10 ¹ | 1.97×10 ¹ | 8.95 | 1.65×10 ⁻¹ | 1.04 | 3.81 | 5.29×10 ¹ |
| Strontium-90 | 1.05×10 ⁵ | 5.20×10 ³ | 2.89×10 ⁴ | 6.66×10 ⁵ | 7.95×10 ⁵ | 2.18×10 ⁴ | 1.62×10 ⁶ |
| Technetium-99 | 3.68×10 ² | 4.07×10 ² | 1.86×10 ² | 8.93 | 2.04×10 ² | 2.46×10 ² | 1.42×10 ³ |
| Iodine-129 | 3.81×10 ⁻¹ | 7.69×10 ⁻¹ | 2.11×10 ⁻¹ | 1.42×10 ⁻² | 1.91×10 ⁻¹ | 2.66×10 ⁻¹ | 1.83 |
| Cesium-137 | 8.46×10 ⁵ | 5.36×10 ⁵ | 3.26×10 ⁵ | 2.89×10 ⁴ | 9.84×10 ⁵ | 2.58×10 ⁵ | 2.98×10 ⁶ |
| Uranium-233, -234, -235, -238 | 7.88×10 ⁻¹ | 2.85×10 ⁻¹ | 3.93 | 3.20×10 ⁻¹ | 5.67×10 ⁻¹ | 4.50×10 ⁻¹ | 6.34 |
| Neptunium-237 | 8.17×10 ⁻¹ | 1.43 | 2.39 | 5.03×10 ⁻¹ | 2.70 | 3.80×10 ⁻¹ | 8.22 |
| Plutonium-239, -240 | 4.70×10 ¹ | 2.48 | 3.02×10 ² | 2.66×10 ² | 3.52×10 ² | 4.88×10 ² | 1.46×10 ³ |

Source: DOE 2003a; SAIC 2007d.

Table D-16. Single-Shell Tank Residual Radiological Constituent Inventories: 99 Percent Retrieval (curies)

| Analyte | Tank Farm | | | | | | | | | | | | Total |
|-------------------------------|-----------------------|-----------------------|-----------------------|-----------------------|-----------------------|-----------------------|-----------------------|-----------------------|-----------------------|-----------------------|-----------------------|-----------------------|-----------------------|
| | A | AX | B | BX | BY | C | S | SX | T | TX | TY | U | |
| Hydrogen-3 (tritium) | 3.38 | 1.30 | 2.07×10 ⁻¹ | 1.01 | 1.33×10 ¹ | 1.10 | 1.94×10 ¹ | 1.32×10 ¹ | 3.42×10 ⁻¹ | 2.13×10 ¹ | 3.50×10 ⁻¹ | 1.44×10 ¹ | 8.93×10 ¹ |
| Carbon-14 | 8.33×10 ⁻¹ | 6.44×10 ⁻¹ | 7.88×10 ⁻² | 4.19×10 ⁻¹ | 5.60 | 1.58×10 ⁻¹ | 5.05 | 2.90 | 1.48×10 ⁻¹ | 6.47 | 7.63×10 ⁻² | 3.56 | 2.59×10 ¹ |
| Strontium-90 | 6.52×10 ⁴ | 3.09×10 ⁴ | 1.89×10 ⁴ | 1.30×10 ⁴ | 1.75×10 ⁴ | 9.18×10 ⁴ | 2.52×10 ⁴ | 5.28×10 ⁴ | 3.72×10 ³ | 1.17×10 ⁴ | 3.31×10 ³ | 9.05×10 ³ | 3.43×10 ⁵ |
| Technetium-99 | 6.74 | 4.13 | 2.13 | 3.70 | 2.54×10 ¹ | 3.51 | 2.74×10 ¹ | 1.76×10 ¹ | 1.63 | 3.76×10 ¹ | 1.02 | 2.43×10 ¹ | 1.55×10 ² |
| Iodine-129 | 9.45×10 ⁻³ | 4.81×10 ⁻³ | 8.18×10 ⁻⁴ | 4.49×10 ⁻³ | 5.55×10 ⁻² | 9.93×10 ⁻³ | 5.93×10 ⁻² | 3.35×10 ⁻² | 1.14×10 ⁻³ | 7.15×10 ⁻² | 1.29×10 ⁻³ | 4.69×10 ⁻² | 2.99×10 ⁻¹ |
| Cesium-137 | 1.24×10 ⁴ | 6.58×10 ³ | 3.58×10 ³ | 3.26×10 ³ | 2.23×10 ⁴ | 9.93×10 ³ | 2.60×10 ⁴ | 2.68×10 ⁴ | 1.65×10 ³ | 2.44×10 ⁴ | 5.26×10 ² | 2.32×10 ⁴ | 1.61×10 ⁵ |
| Uranium-233, -234, -235, -238 | 3.29×10 ⁻¹ | 3.64×10 ⁻² | 2.08×10 ⁻¹ | 5.09×10 ⁻¹ | 5.22×10 ⁻¹ | 4.98 | 5.18×10 ⁻¹ | 2.95×10 ⁻¹ | 2.59×10 ⁻¹ | 4.79×10 ⁻¹ | 2.23×10 ⁻¹ | 3.90×10 ⁻¹ | 8.75 |
| Neptunium-237 | 2.20×10 ⁻² | 7.83×10 ⁻³ | 3.38×10 ⁻³ | 7.42×10 ⁻³ | 8.59×10 ⁻² | 5.72×10 ⁻² | 1.12×10 ⁻¹ | 6.71×10 ⁻² | 2.78×10 ⁻³ | 1.32×10 ⁻¹ | 2.28×10 ⁻³ | 8.94×10 ⁻² | 5.89×10 ⁻¹ |
| Plutonium-239, -240 | 3.56×10 ¹ | 9.83 | 1.42×10 ¹ | 2.10×10 ¹ | 1.32×10 ¹ | 2.16×10 ² | 5.00×10 ¹ | 6.99×10 ¹ | 1.43×10 ¹ | 1.82×10 ² | 4.04 | 3.89×10 ¹ | 6.69×10 ² |

Source: DOE 2003a; SAIC 2007d.

Table D-17. Double-Shell Tank Residual Radiological Constituent Inventories: 99 Percent Retrieval (curies)

| Analyte | Tank Farm | | | | | | Total |
|-------------------------------|-----------------------|-----------------------|-----------------------|-----------------------|-----------------------|-----------------------|-----------------------|
| | AN | AP | AW | AY | AZ | SY | |
| Hydrogen-3 (tritium) | 1.18 | 1.53×10 ¹ | 1.70 | 2.47×10 ⁻¹ | 1.87 | 1.09×10 ¹ | 3.12×10 ¹ |
| Carbon-14 | 1.93 | 1.97 | 8.95×10 ⁻¹ | 1.65×10 ⁻² | 1.04×10 ⁻¹ | 3.81×10 ⁻¹ | 5.29 |
| Strontium-90 | 1.05×10 ⁴ | 5.20×10 ² | 2.89×10 ³ | 6.66×10 ⁴ | 7.95×10 ⁴ | 2.18×10 ³ | 1.62×10 ⁵ |
| Technetium-99 | 3.68×10 ¹ | 4.07×10 ¹ | 1.86×10 ¹ | 8.93×10 ⁻¹ | 2.04×10 ¹ | 2.46×10 ¹ | 1.42×10 ² |
| Iodine-129 | 3.81×10 ⁻² | 7.69×10 ⁻² | 2.11×10 ⁻² | 1.42×10 ⁻³ | 1.91×10 ⁻² | 2.66×10 ⁻² | 1.83×10 ⁻¹ |
| Cesium-137 | 8.46×10 ⁴ | 5.36×10 ⁴ | 3.26×10 ⁴ | 2.89×10 ³ | 9.84×10 ⁴ | 2.58×10 ⁴ | 2.98×10 ⁵ |
| Uranium-233, -234, -235, -238 | 7.88×10 ⁻² | 2.85×10 ⁻² | 3.93×10 ⁻¹ | 3.20×10 ⁻² | 5.67×10 ⁻² | 4.50×10 ⁻² | 6.34×10 ⁻¹ |
| Neptunium-237 | 8.17×10 ⁻² | 1.43×10 ⁻¹ | 2.39×10 ⁻¹ | 5.03×10 ⁻² | 2.70×10 ⁻¹ | 3.80×10 ⁻² | 8.22×10 ⁻¹ |
| Plutonium-239, -240 | 4.70 | 2.48×10 ⁻¹ | 3.02×10 ¹ | 2.66×10 ¹ | 3.52×10 ¹ | 4.88×10 ¹ | 1.46×10 ² |

Source: DOE 2003a; SAIC 2007d.

Table D-18. Single-Shell Tank Residual Radiological Constituent Inventories: 99.9 Percent Retrieval (curies)

| Analyte | Tank Farm | | | | | | | | | | | | Total |
|-------------------------------|-----------------------|-----------------------|-----------------------|-----------------------|-----------------------|-----------------------|-----------------------|-----------------------|-----------------------|-----------------------|-----------------------|-----------------------|-----------------------|
| | A | AX | B | BX | BY | C | S | SX | T | TX | TY | U | |
| Hydrogen-3 (tritium) | 3.38×10 ⁻¹ | 1.30×10 ⁻¹ | 2.07×10 ⁻² | 1.01×10 ⁻¹ | 1.33 | 1.10×10 ⁻¹ | 1.94 | 1.32 | 3.42×10 ⁻² | 2.13 | 3.50×10 ⁻² | 1.44 | 8.93 |
| Carbon-14 | 8.33×10 ⁻² | 6.44×10 ⁻² | 7.88×10 ⁻³ | 4.19×10 ⁻² | 5.60×10 ⁻¹ | 1.58×10 ⁻² | 5.05×10 ⁻¹ | 2.90×10 ⁻¹ | 1.48×10 ⁻² | 6.47×10 ⁻¹ | 7.63×10 ⁻³ | 3.56×10 ⁻¹ | 2.59 |
| Strontium-90 | 6.52×10 ³ | 3.09×10 ³ | 1.89×10 ³ | 1.30×10 ³ | 1.75×10 ³ | 9.18×10 ³ | 2.52×10 ³ | 5.28×10 ³ | 3.72×10 ² | 1.17×10 ³ | 3.31×10 ² | 9.05×10 ² | 3.43×10 ⁴ |
| Technetium-99 | 6.74×10 ⁻¹ | 4.13×10 ⁻¹ | 2.13×10 ⁻¹ | 3.70×10 ⁻¹ | 2.54 | 3.51×10 ⁻¹ | 2.74 | 1.76 | 1.63×10 ⁻¹ | 3.76 | 1.02×10 ⁻¹ | 2.43 | 1.55×10 ¹ |
| Iodine-129 | 9.45×10 ⁻⁴ | 4.81×10 ⁻⁴ | 8.18×10 ⁻⁵ | 4.49×10 ⁻⁴ | 5.55×10 ⁻³ | 9.93×10 ⁻⁴ | 5.93×10 ⁻³ | 3.35×10 ⁻³ | 1.14×10 ⁻⁴ | 7.15×10 ⁻³ | 1.29×10 ⁻⁴ | 4.69×10 ⁻³ | 2.99×10 ⁻² |
| Cesium-137 | 1.24×10 ³ | 6.58×10 ² | 3.58×10 ² | 3.26×10 ² | 2.23×10 ³ | 9.93×10 ² | 2.60×10 ³ | 2.68×10 ³ | 1.65×10 ² | 2.44×10 ³ | 5.26×10 ¹ | 2.32×10 ³ | 1.61×10 ⁴ |
| Uranium-233, -234, -235, -238 | 3.29×10 ⁻² | 3.64×10 ⁻³ | 2.08×10 ⁻² | 5.09×10 ⁻² | 5.22×10 ⁻² | 4.98×10 ⁻¹ | 5.18×10 ⁻² | 2.95×10 ⁻² | 2.59×10 ⁻² | 4.79×10 ⁻² | 2.23×10 ⁻² | 3.90×10 ⁻² | 8.75×10 ⁻¹ |
| Neptunium-237 | 2.20×10 ⁻³ | 7.83×10 ⁻⁴ | 3.38×10 ⁻⁴ | 7.42×10 ⁻⁴ | 8.59×10 ⁻³ | 5.72×10 ⁻³ | 1.12×10 ⁻² | 6.71×10 ⁻³ | 2.78×10 ⁻⁴ | 1.32×10 ⁻² | 2.28×10 ⁻⁴ | 8.94×10 ⁻³ | 5.89×10 ⁻² |
| Plutonium-239, -240 | 3.56 | 9.83×10 ⁻¹ | 1.42 | 2.10 | 1.32 | 2.16×10 ¹ | 5.00 | 6.99 | 1.43 | 1.82×10 ¹ | 4.04×10 ⁻¹ | 3.89 | 6.69×10 ¹ |

Source: DOE 2003a; SAIC 2007d.

Table D-19. Double-Shell Tank Residual Radiological Constituent Inventories: 99.9 Percent Retrieval (curies)

| Analyte | Tank Farm | | | | | | Total |
|-------------------------------|-----------------------|-----------------------|-----------------------|-----------------------|-----------------------|-----------------------|-----------------------|
| | AN | AP | AW | AY | AZ | SY | |
| Hydrogen-3 (tritium) | 1.18×10 ⁻¹ | 1.53 | 1.70×10 ⁻¹ | 2.47×10 ⁻² | 1.87×10 ⁻¹ | 1.09 | 3.12 |
| Carbon-14 | 1.93×10 ⁻¹ | 1.97×10 ⁻¹ | 8.95×10 ⁻² | 1.65×10 ⁻³ | 1.04×10 ⁻² | 3.81×10 ⁻² | 5.29×10 ⁻¹ |
| Strontium-90 | 1.05×10 ³ | 5.20×10 ¹ | 2.89×10 ² | 6.66×10 ³ | 7.95×10 ³ | 2.18×10 ² | 1.62×10 ⁴ |
| Technetium-99 | 3.68 | 4.07 | 1.86 | 8.93×10 ⁻² | 2.04 | 2.46 | 1.42×10 ¹ |
| Iodine-129 | 3.81×10 ⁻³ | 7.69×10 ⁻³ | 2.11×10 ⁻³ | 1.42×10 ⁻⁴ | 1.91×10 ⁻³ | 2.66×10 ⁻³ | 1.83×10 ⁻² |
| Cesium-137 | 8.46×10 ³ | 5.36×10 ³ | 3.26×10 ³ | 2.89×10 ² | 9.84×10 ³ | 2.58×10 ³ | 2.98×10 ⁴ |
| Uranium-233, -234, -235, -238 | 7.88×10 ⁻³ | 2.85×10 ⁻³ | 3.93×10 ⁻² | 3.20×10 ⁻³ | 5.67×10 ⁻³ | 4.50×10 ⁻³ | 6.34×10 ⁻² |
| Neptunium-237 | 8.17×10 ⁻³ | 1.43×10 ⁻² | 2.39×10 ⁻² | 5.03×10 ⁻³ | 2.70×10 ⁻² | 3.80×10 ⁻³ | 8.22×10 ⁻² |
| Plutonium-239, -240 | 4.70×10 ⁻¹ | 2.48×10 ⁻² | 3.02 | 2.66 | 3.52 | 4.88 | 1.46×10 ¹ |

Source: DOE 2003a; SAIC 2007d.

Table D-20. Single-Shell Tank Residual Nonradiological Constituent Inventories: 90 Percent Retrieval (grams)

| Analyte | Tank Farm | | | | | | | | | | | | Total |
|--------------|----------------------|----------------------|----------------------|----------------------|----------------------|----------------------|----------------------|----------------------|----------------------|----------------------|----------------------|----------------------|----------------------|
| | A | AX | B | BX | BY | C | S | SX | T | TX | TY | U | |
| Chromium | 1.62×10 ⁶ | 7.87×10 ⁵ | 1.11×10 ⁶ | 2.20×10 ⁶ | 7.34×10 ⁶ | 5.60×10 ⁵ | 1.20×10 ⁷ | 1.05×10 ⁷ | 1.21×10 ⁶ | 6.13×10 ⁶ | 7.95×10 ⁵ | 5.11×10 ⁶ | 4.95×10 ⁷ |
| Mercury | 1.59×10 ⁴ | 4.27×10 ³ | 1.38×10 ⁴ | 2.27×10 ⁴ | 1.74×10 ⁴ | 3.93×10 ⁴ | 7.15×10 ³ | 1.46×10 ⁴ | 1.99×10 ³ | 2.83×10 ³ | 2.56×10 ⁴ | 2.55×10 ³ | 1.68×10 ⁵ |
| Nitrate | 1.41×10 ⁸ | 7.63×10 ⁷ | 1.90×10 ⁸ | 1.73×10 ⁸ | 6.62×10 ⁸ | 6.56×10 ⁷ | 1.10×10 ⁹ | 6.62×10 ⁸ | 7.47×10 ⁷ | 1.40×10 ⁹ | 8.37×10 ⁷ | 5.46×10 ⁸ | 5.18×10 ⁹ |
| Lead | 4.02×10 ⁵ | 1.26×10 ⁵ | 6.69×10 ⁵ | 3.66×10 ⁵ | 5.12×10 ⁵ | 2.32×10 ⁶ | 2.23×10 ⁵ | 1.75×10 ⁵ | 4.34×10 ⁵ | 7.12×10 ⁵ | 1.39×10 ⁵ | 1.08×10 ⁶ | 7.16×10 ⁶ |
| Uranium | 1.10×10 ⁶ | 1.48×10 ⁵ | 2.86×10 ⁶ | 7.35×10 ⁶ | 6.55×10 ⁶ | 1.13×10 ⁷ | 5.19×10 ⁶ | 3.27×10 ⁶ | 3.72×10 ⁶ | 4.56×10 ⁶ | 3.24×10 ⁶ | 4.97×10 ⁶ | 5.42×10 ⁷ |
| Acetonitrile | 0 | 0 | 0 | 0 | 0 | 0 | 0 | 0 | 0 | 0 | 0 | 0 | 0 |
| Benzene | 0 | 0 | 0 | 0 | 0 | 0 | 0 | 0 | 0 | 0 | 0 | 0 | 0 |
| Butanol | 0 | 0 | 0 | 0 | 0 | 0 | 0 | 0 | 0 | 0 | 0 | 0 | 0 |
| PCBs | 3.05×10 ³ | 1.47×10 ³ | 5.44×10 ³ | 4.18×10 ³ | 1.11×10 ⁴ | 4.67×10 ³ | 1.39×10 ⁴ | 9.23×10 ³ | 4.93×10 ³ | 1.73×10 ⁴ | 1.68×10 ³ | 8.53×10 ³ | 8.54×10 ⁴ |
| 2,4,6-TCP | 0 | 0 | 0 | 0 | 0 | 0 | 0 | 0 | 0 | 0 | 0 | 0 | 0 |

Key: 2,4,6-TCP=2,4,6-trichlorophenol; butanol=n-butyl alcohol; PCBs=polychlorinated biphenyls.

Source: DOE 2003a; SAIC 2007a.

Table D-21. Double-Shell Tank Residual Nonradiological Constituent Inventories: 90 Percent Retrieval (grams)

| Analyte | Tank Farm | | | | | | Total |
|---------------------------|----------------------|----------------------|----------------------|----------------------|----------------------|----------------------|----------------------|
| | AN | AP | AW | AY | AZ | SY | |
| Chromium | 1.85×10 ⁶ | 1.03×10 ⁶ | 1.99×10 ⁶ | 2.79×10 ⁵ | 5.09×10 ⁵ | 4.73×10 ⁶ | 1.04×10 ⁷ |
| Mercury | 4.66×10 ² | 0 | 2.09×10 ¹ | 1.26×10 ⁴ | 4.15×10 ² | 8.95×10 ² | 1.44×10 ⁴ |
| Nitrate | 6.47×10 ⁸ | 5.65×10 ⁸ | 3.47×10 ⁸ | 1.70×10 ⁷ | 7.74×10 ⁷ | 2.48×10 ⁸ | 1.90×10 ⁹ |
| Lead | 3.63×10 ⁵ | 9.01×10 ⁴ | 1.51×10 ⁵ | 4.48×10 ⁵ | 4.03×10 ⁴ | 1.57×10 ⁵ | 1.25×10 ⁶ |
| Uranium | 2.68×10 ⁵ | 1.23×10 ⁵ | 3.95×10 ⁶ | 3.52×10 ⁵ | 5.19×10 ⁵ | 2.38×10 ⁵ | 5.45×10 ⁶ |
| Acetonitrile | 7.33×10 ⁵ | 9.63×10 ⁵ | 5.67×10 ⁵ | 1.13×10 ⁵ | 2.61×10 ⁵ | 3.11×10 ⁵ | 2.95×10 ⁶ |
| Benzene | 5.97×10 ¹ | 7.85×10 ¹ | 4.62×10 ¹ | 9.19 | 2.13×10 ¹ | 2.53×10 ¹ | 2.40×10 ² |
| Butanol (n-butyl alcohol) | 8.59×10 ⁷ | 1.13×10 ⁸ | 6.63×10 ⁷ | 1.32×10 ⁷ | 3.06×10 ⁷ | 3.64×10 ⁷ | 3.45×10 ⁸ |
| Polychlorinated biphenyls | 2.07×10 ⁴ | 2.71×10 ⁴ | 1.60×10 ⁴ | 3.18×10 ³ | 7.36×10 ³ | 8.76×10 ³ | 8.31×10 ⁴ |
| 2,4,6-Trichlorophenol | 2.75×10 ¹ | 3.62×10 ¹ | 2.13×10 ¹ | 4.23 | 9.81 | 1.17×10 ¹ | 1.11×10 ² |

Source: DOE 2003a; SAIC 2007a.

Table D–22. Single-Shell Tank Residual Nonradiological Constituent Inventories: 99 Percent Retrieval (grams)

| Analyte | Tank Farm | | | | | | | | | | | | Total |
|--------------|----------------------|----------------------|----------------------|----------------------|----------------------|----------------------|----------------------|----------------------|----------------------|----------------------|----------------------|----------------------|----------------------|
| | A | AX | B | BX | BY | C | S | SX | T | TX | TY | U | |
| Chromium | 1.62×10 ⁵ | 7.87×10 ⁴ | 1.11×10 ⁵ | 2.20×10 ⁵ | 7.34×10 ⁵ | 5.60×10 ⁴ | 1.20×10 ⁶ | 1.05×10 ⁶ | 1.21×10 ⁵ | 6.13×10 ⁵ | 7.95×10 ⁴ | 5.11×10 ⁵ | 4.95×10 ⁶ |
| Mercury | 1.59×10 ³ | 4.27×10 ² | 1.38×10 ³ | 2.27×10 ³ | 1.74×10 ³ | 3.93×10 ³ | 7.15×10 ² | 1.46×10 ³ | 1.99×10 ² | 2.83×10 ² | 2.56×10 ³ | 2.55×10 ² | 1.68×10 ⁴ |
| Nitrate | 1.41×10 ⁷ | 7.63×10 ⁶ | 1.90×10 ⁷ | 1.73×10 ⁷ | 6.62×10 ⁷ | 6.56×10 ⁶ | 1.10×10 ⁸ | 6.62×10 ⁷ | 7.47×10 ⁶ | 1.40×10 ⁸ | 8.37×10 ⁶ | 5.46×10 ⁷ | 5.18×10 ⁸ |
| Lead | 4.02×10 ⁴ | 1.26×10 ⁴ | 6.69×10 ⁴ | 3.66×10 ⁴ | 5.12×10 ⁴ | 2.32×10 ⁵ | 2.23×10 ⁴ | 1.75×10 ⁴ | 4.34×10 ⁴ | 7.12×10 ⁴ | 1.39×10 ⁴ | 1.08×10 ⁵ | 7.16×10 ⁵ |
| Uranium | 1.10×10 ⁵ | 1.48×10 ⁴ | 2.86×10 ⁵ | 7.35×10 ⁵ | 6.55×10 ⁵ | 1.13×10 ⁶ | 5.19×10 ⁵ | 3.27×10 ⁵ | 3.72×10 ⁵ | 4.56×10 ⁵ | 3.24×10 ⁵ | 4.97×10 ⁵ | 5.42×10 ⁶ |
| Acetonitrile | 0 | 0 | 0 | 0 | 0 | 0 | 0 | 0 | 0 | 0 | 0 | 0 | 0 |
| Benzene | 0 | 0 | 0 | 0 | 0 | 0 | 0 | 0 | 0 | 0 | 0 | 0 | 0 |
| Butanol | 0 | 0 | 0 | 0 | 0 | 0 | 0 | 0 | 0 | 0 | 0 | 0 | 0 |
| PCBs | 3.05×10 ² | 1.47×10 ² | 5.44×10 ² | 4.18×10 ² | 1.11×10 ³ | 4.67×10 ² | 1.39×10 ³ | 9.23×10 ² | 4.93×10 ² | 1.73×10 ³ | 1.68×10 ² | 8.53×10 ² | 8.54×10 ³ |
| 2,4,6-TCP | 0 | 0 | 0 | 0 | 0 | 0 | 0 | 0 | 0 | 0 | 0 | 0 | 0 |

Key: 2,4,6-TCP=2,4,6-trichlorophenol; butanol=n-butyl alcohol; PCBs=polychlorinated biphenyls.

Source: DOE 2003a; SAIC 2007a.

Table D–23. Double-Shell Tank Residual Nonradiological Constituent Inventories: 99 Percent Retrieval (grams)

| Analyte | Tank Farm | | | | | | Total |
|---------------------------|----------------------|----------------------|----------------------|-----------------------|-----------------------|----------------------|----------------------|
| | AN | AP | AW | AY | AZ | SY | |
| Chromium | 1.85×10 ⁵ | 1.03×10 ⁵ | 1.99×10 ⁵ | 2.79×10 ⁴ | 5.09×10 ⁴ | 4.73×10 ⁵ | 1.04×10 ⁶ |
| Mercury | 4.66×10 ¹ | 0 | 2.09 | 1.26×10 ³ | 4.15×10 ¹ | 8.95×10 ¹ | 1.44×10 ³ |
| Nitrate | 6.47×10 ⁷ | 5.65×10 ⁷ | 3.47×10 ⁷ | 1.70×10 ⁶ | 7.74×10 ⁶ | 2.48×10 ⁷ | 1.90×10 ⁸ |
| Lead | 3.63×10 ⁴ | 9.01×10 ³ | 1.51×10 ⁴ | 4.48×10 ⁴ | 4.03×10 ³ | 1.57×10 ⁴ | 1.25×10 ⁵ |
| Uranium | 2.68×10 ⁴ | 1.23×10 ⁴ | 3.95×10 ⁵ | 3.52×10 ⁴ | 5.19×10 ⁴ | 2.38×10 ⁴ | 5.45×10 ⁵ |
| Acetonitrile | 7.33×10 ⁴ | 9.63×10 ⁴ | 5.67×10 ⁴ | 1.13×10 ⁴ | 2.61×10 ⁴ | 3.11×10 ⁴ | 2.95×10 ⁵ |
| Benzene | 5.97 | 7.85 | 4.62 | 9.19×10 ⁻¹ | 2.13 | 2.53 | 2.40×10 ¹ |
| Butanol (n-butyl alcohol) | 8.59×10 ⁶ | 1.13×10 ⁷ | 6.63×10 ⁶ | 1.32×10 ⁶ | 3.06×10 ⁶ | 3.64×10 ⁶ | 3.45×10 ⁷ |
| Polychlorinated biphenyls | 2.07×10 ³ | 2.71×10 ³ | 1.60×10 ³ | 3.18×10 ² | 7.36×10 ² | 8.76×10 ² | 8.31×10 ³ |
| 2,4,6-Trichlorophenol | 2.75 | 3.62 | 2.13 | 4.23×10 ⁻¹ | 9.81×10 ⁻¹ | 1.17 | 1.11×10 ¹ |

Source: DOE 2003a; SAIC 2007a.

Table D-24. Single-Shell Tank Residual Nonradiological Constituent Inventories: 99.9 Percent Retrieval (grams)

| Analyte | Tank Farm | | | | | | | | | | | | Total |
|--------------|----------------------|----------------------|----------------------|----------------------|----------------------|----------------------|----------------------|----------------------|----------------------|----------------------|----------------------|----------------------|----------------------|
| | A | AX | B | BX | BY | C | S | SX | T | TX | TY | U | |
| Chromium | 1.62×10 ⁴ | 7.87×10 ³ | 1.11×10 ⁴ | 2.20×10 ⁴ | 7.34×10 ⁴ | 5.60×10 ³ | 1.20×10 ⁵ | 1.05×10 ⁵ | 1.21×10 ⁴ | 6.13×10 ⁴ | 7.95×10 ³ | 5.11×10 ⁴ | 4.95×10 ⁵ |
| Mercury | 1.59×10 ² | 4.27×10 ¹ | 1.38×10 ² | 2.27×10 ² | 1.74×10 ² | 3.93×10 ² | 7.15×10 ¹ | 1.46×10 ² | 1.99×10 ¹ | 2.83×10 ¹ | 2.56×10 ² | 2.55×10 ¹ | 1.68×10 ³ |
| Nitrate | 1.41×10 ⁶ | 7.63×10 ⁵ | 1.90×10 ⁶ | 1.73×10 ⁶ | 6.62×10 ⁶ | 6.56×10 ⁵ | 1.10×10 ⁷ | 6.62×10 ⁶ | 7.47×10 ⁵ | 1.40×10 ⁷ | 8.37×10 ⁵ | 5.46×10 ⁶ | 5.18×10 ⁷ |
| Lead | 4.02×10 ³ | 1.26×10 ³ | 6.69×10 ³ | 3.66×10 ³ | 5.12×10 ³ | 2.32×10 ⁴ | 2.23×10 ³ | 1.75×10 ³ | 4.34×10 ³ | 7.12×10 ³ | 1.39×10 ³ | 1.08×10 ⁴ | 7.16×10 ⁴ |
| Uranium | 1.10×10 ⁴ | 1.48×10 ³ | 2.86×10 ⁴ | 7.35×10 ⁴ | 6.55×10 ⁴ | 1.13×10 ⁵ | 5.19×10 ⁴ | 3.27×10 ⁴ | 3.72×10 ⁴ | 4.56×10 ⁴ | 3.24×10 ⁴ | 4.97×10 ⁴ | 5.42×10 ⁵ |
| Acetonitrile | 0 | 0 | 0 | 0 | 0 | 0 | 0 | 0 | 0 | 0 | 0 | 0 | 0 |
| Benzene | 0 | 0 | 0 | 0 | 0 | 0 | 0 | 0 | 0 | 0 | 0 | 0 | 0 |
| Butanol | 0 | 0 | 0 | 0 | 0 | 0 | 0 | 0 | 0 | 0 | 0 | 0 | 0 |
| PCBs | 3.05×10 ¹ | 1.47×10 ¹ | 5.44×10 ¹ | 4.18×10 ¹ | 1.11×10 ² | 4.67×10 ¹ | 1.39×10 ² | 9.23×10 ¹ | 4.93×10 ¹ | 1.73×10 ² | 1.68×10 ¹ | 8.53×10 ¹ | 8.54×10 ² |
| 2,4,6-TCP | 0 | 0 | 0 | 0 | 0 | 0 | 0 | 0 | 0 | 0 | 0 | 0 | 0 |

Key: 2,4,6-TCP=2,4,6-trichlorophenol; butanol=n-butyl alcohol; PCBs=polychlorinated biphenyls.

Source: DOE 2003a; SAIC 2007a.

Table D-25. Double-Shell Tank Residual Nonradiological Constituent Inventories: 99.9 Percent Retrieval (grams)

| Analyte | Tank Farm | | | | | | Total |
|---------------------------|-----------------------|-----------------------|-----------------------|-----------------------|-----------------------|-----------------------|----------------------|
| | AN | AP | AW | AY | AZ | SY | |
| Chromium | 1.85×10 ⁴ | 1.03×10 ⁴ | 1.99×10 ⁴ | 2.79×10 ³ | 5.09×10 ³ | 4.73×10 ⁴ | 1.04×10 ⁵ |
| Mercury | 4.66 | 0 | 2.09×10 ⁻¹ | 1.26×10 ² | 4.15 | 8.95 | 1.44×10 ² |
| Nitrate | 6.47×10 ⁶ | 5.65×10 ⁶ | 3.47×10 ⁶ | 1.70×10 ⁵ | 7.74×10 ⁵ | 2.48×10 ⁶ | 1.90×10 ⁷ |
| Lead | 3.63×10 ³ | 9.01×10 ² | 1.51×10 ³ | 4.48×10 ³ | 4.03×10 ² | 1.57×10 ³ | 1.25×10 ⁴ |
| Uranium | 2.68×10 ³ | 1.23×10 ³ | 3.95×10 ⁴ | 3.52×10 ³ | 5.19×10 ³ | 2.38×10 ³ | 5.45×10 ⁴ |
| Acetonitrile | 7.33×10 ³ | 9.63×10 ³ | 5.67×10 ³ | 1.13×10 ³ | 2.61×10 ³ | 3.11×10 ³ | 2.95×10 ⁴ |
| Benzene | 5.97×10 ⁻¹ | 7.85×10 ⁻¹ | 4.62×10 ⁻¹ | 9.19×10 ⁻² | 2.13×10 ⁻¹ | 2.53×10 ⁻¹ | 2.40 |
| Butanol (n-butyl alcohol) | 8.59×10 ⁵ | 1.13×10 ⁶ | 6.63×10 ⁵ | 1.32×10 ⁵ | 3.06×10 ⁵ | 3.64×10 ⁵ | 3.45×10 ⁶ |
| Polychlorinated biphenyls | 2.07×10 ² | 2.71×10 ² | 1.60×10 ² | 3.18×10 ¹ | 7.36×10 ¹ | 8.76×10 ¹ | 8.31×10 ² |
| 2,4,6-Trichlorophenol | 2.75×10 ⁻¹ | 3.62×10 ⁻¹ | 2.13×10 ⁻¹ | 4.23×10 ⁻² | 9.81×10 ⁻² | 1.17×10 ⁻¹ | 1.11 |

Source: DOE 2003a; SAIC 2007a.

D.1.4 Historical Leaks and Other Releases

Leaks from SSTs have been suspected, investigated, and, in some cases, confirmed. Currently, 67 of Hanford's 149 SSTs are listed as "known or suspected" leakers in the monthly *Waste Tank Summary Report* (Hanlon 2003). This information was compiled in the late 1980s and early 1990s and reflects the state of knowledge at that time. The document contains information of varying quality. For example, leak volumes for tanks 241-SX-113, 241-SX-115, and 241-T-106 are well documented; however, for 19 of the tanks listed in the *Waste Tank Summary Report*, the leak volume estimates provided were based on limited supporting data. The leak volume estimates for the remaining 45 tanks are based on various methods and are further described in the *Waste Tank Summary Report*. Estimates of the total leak losses in the *Waste Tank Summary Report* range from 1.89 million to 3.97 million liters (0.5 million to 1.05 million gallons). Vadose zone field investigations have not been completed for all tank farms, as well as remaining uncertainties regarding the estimated volumes of past leaks, the higher value of 3.97 million liters (1.05 million gallons) reported in the *Waste Tank Summary Report* was used for analysis purposes of this *TC & WM EIS*.

Current efforts to characterize impacts of leaks from the SSTs have focused on developing estimates of the inventories lost to the vadose zone. These efforts include gamma ray contamination detection mapping of the dry wells at the 12 SST farms using a gamma source and ongoing field investigations for four sets of tank farms. Using this information, estimates of inventories lost to the vadose zone have been developed. Analysis results for 20 tanks are documented in the *Inventory and Source Term Data Package* (DOE 2003a) and the Field Investigation Reports (CH2M HILL 2002; Jones et al. 2000, 2001; Myers 2005; Wood and Jones 2003; Wood et al. 2003); this analysis constitutes the best available basis for estimating leak inventories from all SSTs suspected to be leaking. The approach used to extend the available information was to assume that the concentration in a leak from a tank in a given tank farm for which a documented estimate is not available is equal to the average concentration in leaks from tanks in the same tank farm for which documented estimates are available. For losses from the tank farms for which a documented inventory estimate is not available, i.e., the AX tank farm, tank volumes and times of operation were reviewed, and the tank farm was associated with a tank farm for which a documented inventory estimate is available. Thus, average concentrations from the AX tank farm were assumed equal to those of documented losses from the A tank farm. The inventory in a leak event was calculated as the product of the concentration in the leak and the leak volume. Results of this analysis are summarized in Tables D-26 and D-27 for radiological and nonradiological constituents, respectively.

D.1.5 Discharges to Cribs and Trenches (Ditches)

During the early years of Hanford operations, three classes of liquid waste were produced during fuel reprocessing operations. Uncontaminated aqueous waste, such as cooling water, was discharged to surface ponds. High-volume waste streams with modest radionuclide and chemical contamination were discharged to cribs and trenches (ditches). Waste streams that contained isotopes with long half-lives and fission products with high radiation/short half-lives were transferred to underground SSTs. Because many of the cribs and trenches (ditches) are in close proximity to the SST farms, in some cases it is very difficult to clearly identify contamination sources in the vadose zone or groundwater.

Table D-26. Historical Single-Shell Tank Radiological Constituent Leak Inventories (curies)

| Analyte | Tank Farm | | | | | | | | | | | | Total |
|---------------------------|-----------------------|-----------------------|-----------------------|-----------------------|-----------------------|-----------------------|-----------------------|-----------------------|-----------------------|-----------------------|-----------------------|-----------------------|-----------------------|
| | A | AX | B | BX | BY | C | S | SX | T | TX | TY | U | |
| H-3 (tritium) | 1.91 | 7.39×10 ⁻² | 1.52×10 ¹ | 1.09×10 ¹ | 3.13 | 1.94×10 ¹ | 7.12 | 9.61×10 ¹ | 5.33×10 ¹ | 1.08×10 ² | 2.56 | 9.89 | 3.27×10 ² |
| C-14 | 4.87×10 ⁻¹ | 1.88×10 ⁻² | 3.10 | 5.17×10 ⁻¹ | 2.20×10 ⁻¹ | 8.07 | 5.53×10 ⁻¹ | 4.79 | 9.52 | 1.50×10 ¹ | 3.40×10 ⁻¹ | 5.16×10 ⁻¹ | 4.32×10 ¹ |
| Sr-90 | 7.80×10 ² | 3.01×10 ¹ | 7.61×10 ³ | 4.13×10 ³ | 1.49×10 ³ | 1.92×10 ⁴ | 4.52×10 ³ | 2.29×10 ⁴ | 2.43×10 ⁴ | 5.73×10 ⁴ | 3.17×10 ³ | 4.04×10 ³ | 1.49×10 ⁵ |
| Tc-99 | 3.44 | 1.33×10 ⁻¹ | 2.18×10 ¹ | 4.92 | 2.10 | 5.65×10 ¹ | 3.87 | 3.75×10 ¹ | 6.74×10 ¹ | 1.07×10 ² | 2.40 | 4.54 | 3.12×10 ² |
| I-129 | 6.64×10 ⁻³ | 2.56×10 ⁻⁴ | 4.20×10 ⁻² | 9.35×10 ⁻³ | 3.98×10 ⁻³ | 1.09×10 ⁻¹ | 7.44×10 ⁻³ | 7.10×10 ⁻² | 1.30×10 ⁻¹ | 2.06×10 ⁻¹ | 4.59×10 ⁻³ | 8.64×10 ⁻³ | 5.99×10 ⁻¹ |
| Cs-137 | 1.22×10 ⁴ | 4.71×10 ² | 2.64×10 ⁴ | 4.22×10 ³ | 1.54×10 ³ | 1.85×10 ⁵ | 1.14×10 ⁴ | 1.26×10 ⁵ | 2.49×10 ⁴ | 1.58×10 ⁵ | 5.64×10 ³ | 9.04×10 ³ | 5.65×10 ⁵ |
| U-233, -234, -235,-238 | 8.85×10 ⁻³ | 3.42×10 ⁻⁴ | 2.34×10 ⁻¹ | 7.16 | 3.06 | 1.48×10 ⁻¹ | 8.22×10 ⁻² | 4.20×10 ⁻¹ | 3.49×10 ⁻¹ | 3.16 | 1.33×10 ⁻¹ | 4.97 | 1.97×10 ¹ |
| Np-237 | 8.89×10 ⁻³ | 3.43×10 ⁻⁴ | 6.74×10 ⁻² | 2.64×10 ⁻² | 1.12×10 ⁻² | 2.25×10 ⁻¹ | 2.52×10 ⁻² | 1.65×10 ⁻¹ | 2.33×10 ⁻¹ | 3.86×10 ⁻¹ | 1.15×10 ⁻² | 2.58×10 ⁻² | 1.19 |
| Pu-239, -240 | 8.64×10 ⁻¹ | 3.33×10 ⁻² | 4.87 | 3.24 | 1.38 | 5.97 | 1.64 | 8.23 | 1.28×10 ¹ | 2.87×10 ¹ | 1.78 | 2.59 | 7.21×10 ¹ |

Key: C=carbon; Cs=cesium; H=hydrogen; I=iodine; Np=neptunium; Pu=plutonium; Sr=strontium; Tc=technetium; U=uranium.

Source: CH2M HILL 2002; Jones et al. 2000, 2001; Myers 2005; Wood and Jones 2003; Wood et al. 2003.

Table D-27. Historical Single-Shell Tank Nonradiological Constituent Leak Inventories (grams)^a

| Analyte | Tank Farm | | | | | | | | | | | | Total |
|----------|-----------------------|-----------------------|----------------------|----------------------|----------------------|----------------------|-----------------------|----------------------|----------------------|----------------------|----------------------|----------------------|----------------------|
| | A | AX | B | BX | BY | C | S | SX | T | TX | TY | U | |
| Chromium | 1.37×10 ⁴ | 5.27×10 ² | 2.35×10 ⁵ | 4.97×10 ⁴ | 2.12×10 ⁴ | 2.87×10 ⁵ | 7.81×10 ⁵ | 3.89×10 ⁶ | 1.10×10 ⁶ | 3.07×10 ⁶ | 8.47×10 ⁴ | 2.84×10 ⁵ | 9.81×10 ⁶ |
| Mercury | 6.61×10 ⁻¹ | 2.55×10 ⁻² | 3.55×10 ² | 3.40×10 ¹ | 1.45×10 ¹ | 5.41×10 ¹ | 6.49×10 ¹ | 3.57×10 ¹ | 2.35×10 ² | 1.34×10 ³ | 2.71×10 ¹ | 4.11×10 ¹ | 2.20×10 ³ |
| Nitrate | 1.00×10 ⁶ | 3.86×10 ⁴ | 3.35×10 ⁷ | 1.65×10 ⁷ | 7.04×10 ⁶ | 1.98×10 ⁷ | 2.63×10 ⁷ | 1.14×10 ⁸ | 6.74×10 ⁷ | 2.44×10 ⁸ | 4.18×10 ⁷ | 2.00×10 ⁷ | 5.91×10 ⁸ |
| Lead | 1.09×10 ² | 4.22 | 5.10×10 ⁴ | 5.51×10 ³ | 2.35×10 ³ | 8.60×10 ³ | 1.07×10 ⁴ | 5.75×10 ⁴ | 3.53×10 ⁴ | 1.29×10 ⁵ | 2.49×10 ³ | 4.41×10 ³ | 3.07×10 ⁵ |
| Uranium | 1.01×10 ⁴ | 3.89×10 ² | 2.44×10 ⁵ | 1.06×10 ⁷ | 4.52×10 ⁶ | 2.07×10 ⁵ | 1.19×10 ⁵ | 5.52×10 ⁵ | 3.82×10 ⁵ | 1.30×10 ⁶ | 1.04×10 ⁵ | 7.38×10 ⁶ | 2.54×10 ⁷ |
| Butanol | 4.66×10 ³ | 1.80×10 ² | 9.41×10 ⁴ | 6.56×10 ³ | 2.79×10 ³ | 4.45×10 ⁵ | 3.86×10 ⁻² | 6.37×10 ¹ | 3.78×10 ⁵ | 6.13×10 ⁵ | 9.40×10 ³ | 6.85×10 ³ | 1.56×10 ⁶ |

^a Acetonitrile, benzene, polychlorinated biphenyls, and 2,4,6-trichlorophenol not reported.

Key: butanol=n-butyl alcohol.

Source: CH2M HILL 2002; Jones et al. 2000, 2001; Myers 2005; Wood and Jones 2003; Wood et al. 2003.

In parallel with the development of tank leak inventory estimates, inventory estimates were developed for intentional discharges of tank waste to cribs and trenches (ditches) near the B/BX/BY and T/TX/TY waste management areas (Simpson, Corbin, and Agnew 2001). The proximity of the cribs and trenches (ditches) to the tank farms warrants inclusion of these inventory estimates because they may be appropriate in tank farm vadose zone analyses. All volume and inventory estimates for discharges to cribs and trenches (ditches) were derived from the Hanford Soil Inventory Model (SIM), Revision 1 (Corbin et al. 2005).

SIM is an extension and enhancement of previous efforts to quantify contaminant inventories in the Hanford site waste storage tanks. The SIM provides more details of what went into specific waste sites other than the tanks than previously estimated and provides a more complete picture of these discharges. It is based on historical records and data from various Hanford process facilities that extracted plutonium and uranium from spent nuclear fuel (SNF). SIM generates inventory and uncertainty estimates for liquid waste disposal sites, unplanned releases, and tank leaks over the operating lifetimes in intervals of 1 year from 1944 to 2001 (Corbin et al. 2005).

Information on the vertical distribution of chemicals and radionuclides that were intentionally discharged to the soil column is available. A number of field investigations have examined the contaminant profile in a number of cribs. In general, the levels of contamination have varied, with the highest contaminant concentrations being associated with less-mobile radionuclides like cesium-137 and strontium-90 near the release points. Most mobile contaminants, such as tritium, technetium-99, and nitrate are generally found in finer-grained materials at minor concentrations. Because of the high volumes of fluids discharged to the cribs, any contaminants that were not strongly sorbed by the soil were rapidly transferred to groundwater. Recent field investigations conducted by Bechtel Hanford at the B-38 trench (ditch) (and discussed in the *Waste Tank Summary Report* [Hanlon 2003]) provide strong evidence that the trenches (ditches) functioned as designed. Soil analyses as a function of depth show the location of mobile constituents such as nitrate and sorbed species such as cesium-137 and strontium-90 (Hanlon 2003).

Estimates of volumes and inventories of radioactive and chemical constituents discharged to six sets of cribs and trenches (ditches) are presented in Tables D-28 and D-29. (Note: The T Trenches and TX Trenches are considered one set.) The grouping of the 33 cribs and trenches (ditches) provided in Tables D-28 and D-29 is as follows:

- T Cribs: 216-T-5, 216-T-7 (2)
- T Trenches: 216-T-14 through 216-T-19 (6)
- TX Trenches: 216-T-21 through 216-T-25 (5)
- TY Cribs: 216-T-26, 216-T-28, 216-T-32 (3)
- B Cribs: 216-B-7 A&B, 216-B-8 (2)
- BX Trenches: 216-B-35 through 216-B-42 (8)
- BY Cribs: 216-B-43 through 216-B-49 (7)

Table D–28. Radiological Constituent Discharges to Cribs and Trenches (Ditches)^a

| | T Cribs | T Trenches | TX Trenches | TY Cribs | B Cribs | BX Trenches | BY Cribs | Total |
|-------------------------------|-----------------------|-----------------------|-----------------------|-----------------------|-----------------------|-----------------------|-----------------------|-----------------------|
| Volume discharged (liters) | 1.10×10 ⁸ | 4.60×10 ⁸ | 8.02×10 ⁶ | 8.24×10 ⁷ | 7.99×10 ⁷ | 1.49×10 ⁷ | 3.38×10 ⁷ | 7.89×10 ⁸ |
| Analyte (curies) | | | | | | | | |
| Hydrogen-3 (tritium) | 1.00×10 ⁻¹ | 5.15×10 ³ | 4.89×10 ¹ | 2.95 | 2.10×10 ⁻² | 9.09×10 ¹ | 2.11×10 ² | 5.50×10 ³ |
| Carbon-14 | 3.98×10 ⁻¹ | 5.94×10 ⁻¹ | 6.48×10 ⁻¹ | 3.80 | 1.71×10 ⁻¹ | 1.44 | 8.17 | 1.52×10 ¹ |
| Strontium-90 | 3.96×10 ² | 3.41×10 ² | 5.77×10 ² | 5.80×10 ² | 1.78×10 ³ | 1.16×10 ³ | 4.74×10 ³ | 9.57×10 ³ |
| Technetium-99 | 2.05×10 ⁻¹ | 9.41×10 ⁻¹ | 1.62 | 1.80 | 1.75×10 ⁻¹ | 8.40 | 1.28×10 ² | 1.42×10 ² |
| Iodine-129 | 1.49×10 ⁻⁵ | 8.28×10 ⁻³ | 1.41×10 ⁻² | 1.70×10 ⁻² | 6.94×10 ⁻⁴ | 3.09×10 ⁻² | 1.65×10 ⁻¹ | 2.36×10 ⁻¹ |
| Cesium-137 | 4.60×10 ² | 1.82×10 ³ | 3.67×10 ³ | 6.30×10 ² | 5.42×10 ² | 6.17×10 ³ | 1.62×10 ³ | 1.49×10 ⁴ |
| Uranium-233, -234, -235, -238 | 2.45×10 ⁻¹ | 1.35×10 ⁻¹ | 1.85×10 ⁻¹ | 3.00 | 1.58 | 3.40×10 ⁻¹ | 7.17×10 ⁻¹ | 6.21 |
| Neptunium-237 | 1.10×10 ⁻¹ | 2.60×10 ⁻² | 3.73×10 ⁻² | 8.01×10 ⁻² | 5.12×10 ⁻² | 1.07×10 ¹ | 1.02 | 1.43 |
| Plutonium-239, -240 | 2.81×10 ² | 1.47×10 ¹ | 3.71 | 9.45×10 ¹ | 1.64×10 ² | 6.96 | 2.82×10 ¹ | 5.94×10 ² |

^a Acetonitrile, benzene, polychlorinated biphenyls, and 2,4,6-trichlorophenol not reported.

Source: SAIC 2007e.

Table D–29. Nonradiological Constituent Discharges to Cribs and Trenches (Ditches)^a

| | T Cribs | T Trenches | TX Trenches | TY Cribs | B Cribs | BX Trenches | BY Cribs | Total |
|----------------------------|----------------------|----------------------|----------------------|----------------------|-----------------------|----------------------|----------------------|----------------------|
| Volume discharged (liters) | 1.10×10 ⁸ | 4.60×10 ⁸ | 8.02×10 ⁶ | 8.24×10 ⁷ | 7.99×10 ⁷ | 1.49×10 ⁷ | 3.38×10 ⁷ | 7.89×10 ⁸ |
| Analyte (kilograms) | | | | | | | | |
| Chromium | 2.93×10 ⁴ | 2.61×10 ³ | 2.87×10 ³ | 1.75×10 ⁴ | 1.79×10 ⁴ | 5.05×10 ³ | 5.82×10 ³ | 8.09×10 ⁴ |
| Mercury | 0 | 6.13 | 2.86 | 8.19 | 1.23×10 ⁻² | 5.26 | 1.09×10 ¹ | 3.33×10 ¹ |
| Nitrate | 6.79×10 ⁶ | 8.13×10 ⁵ | 1.04×10 ⁶ | 3.17×10 ⁶ | 4.65×10 ⁶ | 1.77×10 ⁶ | 6.72×10 ⁶ | 2.50×10 ⁷ |
| Lead | 0 | 5.50 | 0 | 1.46×10 ¹ | 7.69 | 0 | 0 | 2.78×10 ¹ |
| Uranium | 3.63×10 ² | 2.00×10 ² | 2.74×10 ² | 1.11×10 ³ | 3.88×10 ² | 5.04×10 ² | 1.06×10 ³ | 3.90×10 ³ |

^a Acetonitrile, benzene, polychlorinated biphenyls, and 2,4,6-trichlorophenol not reported.

Source: SAIC 2007e.

D.1.6 Tank Waste Retrieval Leaks

The amount of leakage that may occur during retrieval of waste from SSTs varies with the details of the individual tank condition and retrieval methods and is largely uncertain. During actual retrieval operations, leak detection and monitoring would be used to minimize leakage to the extent practical.

The SSTs were constructed as early as 1943. Currently, 67 of Hanford's 149 SSTs are listed as "known or suspected" leakers. The SSTs were formally removed from service in 1980, but still contain approximately 120 million liters (32 million gallons) of waste. Although the River Protection Project (RPP) plans to minimize the introduction of liquids into suspected leakers (utilizing vacuum-based retrieval), for analysis purposes, all SSTs were assumed to leak during retrieval. The *Tank Waste Remediation System, Hanford Site, Richland, Washington, Final Environmental Impact Statement* (DOE and Ecology 1996) assumed an average of 15,140 liters (4,000 gallons) would leak during SST retrieval. Due to limitations on currently employed leak detection equipment, this assumption was carried forward in this EIS. The leak detection monitoring and mitigation strategy developed for the tank 241-S-112 retrieval demonstration (Hanson 2003) estimated that the best of the three available leak detection methods utilized gamma ray contamination detection mapping of the dry wells and neutron contamination detection mapping of the soil. The 95th percentile upper confidence limit with this method estimated leak detection within a leak volume range from 1,140 to 68,000 liters (300 to 18,000 gallons), depending on where the leak originated in relation to the dry wells. In-tank liquid balance leak detection methods were even less sensitive, ranging from 68,000 to 310,000 liters (18,000 to 82,000 gallons) at the 95th percentile

upper confidence limit. Technologies to assist in mitigation and improve detection of leakage are currently being evaluated and tested by the River Protection Project. Testing conducted on resistivity-based technologies over a 110-day period in 2003 at the Hanford 105A mock-tank test site provided encouraging data for the potential future use of much more sensitive leak detection capabilities (Barnett et al. 2003). High resolution resistivity has been used on a number of SSTs starting in 2004. See Appendix E, Section E.1.2.2.5.1, for further details.

In addition to leak volume specification, estimating the inventory of each constituent released to the vadose zone requires knowledge of the retrieval method used and the tank inventories addressed during retrieval operations. Retrieval operations that may result in leakage are those that use liquid to sluice salt cake and sludge from the SSTs. Current analysis projects that three volumes of sluicing liquid would remove one volume of SST solids (DOE 2003b). A conservative estimate of the inventory present in the tank during retrieval is provided by the estimate of current tank inventories. These estimates are summarized in Section D.1.1. Given these considerations, the concentration of a constituent in leak liquid would be one-quarter of the volumetric concentration of the constituent in the tank prior to retrieval. For a single tank, the loss of a constituent in leakage during retrieval is estimated as:

$$M_{\text{retrieval}} = \frac{M_{BBIT}}{BBIT} \times \frac{1}{4} \times r$$

where:

| | | |
|------------------------|---|--|
| $M_{\text{retrieval}}$ | = | amount of the radiological or chemical constituent in tank waste retrieval leaks for a tank, curies or grams |
| M_{BBIT} | = | inventory of constituent in the tank, curies or grams |
| r | = | volume lost during retrieval, 15,000 liters (4,000 gallons) |
| $BBIT$ | = | inventory volume in the tank, liters |

The constituent loss estimates for all tank farms were calculated as the sum of the losses from the individual tanks in the tank farm. Estimated retrieval losses of radioactive and chemical constituents on a tank-farm basis are presented in Tables D-30 and D-31.

D.1.7 Inventories and Flowsheets

Retrieval of tank waste, processing and stabilization of the waste streams, and closure of the tank farms would generate a number of waste forms for onsite disposal. Volume and constituent inventory estimates for these waste forms are based on the mass balances that are applicable for the set of process operations proposed for each alternative (CEES 2007a, 2007b; DOE 2003a, 2003b), as well as on additional assumptions related to the generation and recovery efficiencies of the volatile constituents tritium, carbon dioxide, nitrate, mercury, and iodine during thermal processing.

Assumptions applied to these constituents for thermal processes under all alternatives include:

- Iodine-129: 80 percent goes to offgas (CEES 2007b; Whyatt, Shade, and Stegen 1996)
- Carbon-14: 100 percent to offgas (Zamecnik and Crawford 2003)
- Tritium: 100 percent to offgas (BNI 2002)
- Mercury: 100 percent to offgas (CEES 2007b)
- Nitrate: 100 percent to offgas (BNI 2002)
- All hazardous chemicals (organics): 100 percent to offgas

Table D-30. Single-Shell Tank Radiological Constituent Tank Waste Retrieval Leak Inventories (curies)

| Analyte | Tank Farm | | | | | | | | | | | | Total |
|----------------------------|-----------------------|-----------------------|-----------------------|-----------------------|-----------------------|-----------------------|-----------------------|-----------------------|-----------------------|-----------------------|-----------------------|-----------------------|-----------------------|
| | A | AX | B | BX | BY | C | S | SX | T | TX | TY | U | |
| H-3 (tritium) | 2.10 | 1.75 | 3.22×10 ⁻¹ | 5.30×10 ⁻¹ | 3.78 | 5.56×10 ⁻¹ | 4.39 | 4.33 | 4.66×10 ⁻¹ | 5.86 | 3.59×10 ⁻¹ | 4.20 | 2.86×10 ¹ |
| C-14 | 4.85×10 ⁻¹ | 6.15×10 ⁻¹ | 8.93×10 ⁻² | 2.23×10 ⁻¹ | 1.59 | 1.02×10 ⁻¹ | 1.15 | 7.71×10 ⁻¹ | 2.97×10 ⁻¹ | 1.71 | 8.03×10 ⁻² | 1.02 | 8.13 |
| Sr-90 | 1.83×10 ⁵ | 3.11×10 ⁵ | 1.47×10 ⁴ | 1.71×10 ⁴ | 5.13×10 ³ | 6.95×10 ⁴ | 6.33×10 ³ | 1.35×10 ⁵ | 7.15×10 ³ | 6.78×10 ³ | 2.56×10 ³ | 8.58×10 ³ | 7.68×10 ⁵ |
| Tc-99 | 5.06 | 1.48×10 ¹ | 1.26 | 2.31 | 7.46 | 2.72 | 6.36 | 5.55 | 1.71 | 1.01×10 ¹ | 1.36 | 6.97 | 6.57×10 ¹ |
| I-129 | 7.38×10 ⁻³ | 6.54×10 ⁻³ | 9.81×10 ⁻⁴ | 2.48×10 ⁻³ | 1.57×10 ⁻² | 4.85×10 ⁻³ | 1.35×10 ⁻² | 9.27×10 ⁻³ | 1.59×10 ⁻³ | 1.92×10 ⁻² | 9.23×10 ⁻⁴ | 1.33×10 ⁻² | 9.58×10 ⁻² |
| Cs-137 | 9.37×10 ³ | 1.07×10 ⁴ | 2.05×10 ³ | 2.60×10 ³ | 6.24×10 ³ | 1.01×10 ⁴ | 6.14×10 ³ | 1.03×10 ⁴ | 1.75×10 ³ | 7.61×10 ³ | 6.27×10 ² | 8.29×10 ³ | 7.57×10 ⁴ |
| U-233, -234, -235, -238 | 5.43×10 ⁻¹ | 3.15×10 ⁻² | 1.58×10 ⁻¹ | 5.00×10 ⁻¹ | 1.55×10 ⁻¹ | 2.18 | 1.31×10 ⁻¹ | 1.83×10 ⁻¹ | 1.95×10 ⁻¹ | 1.56×10 ⁻¹ | 2.21×10 ⁻¹ | 1.84×10 ⁻¹ | 4.64 |
| Np-237 | 1.24×10 ⁻² | 8.43×10 ⁻³ | 2.62×10 ⁻³ | 3.94×10 ⁻³ | 2.52×10 ⁻² | 3.42×10 ⁻² | 2.55×10 ⁻² | 1.96×10 ⁻² | 4.92×10 ⁻³ | 3.56×10 ⁻² | 2.33×10 ⁻³ | 2.59×10 ⁻² | 2.01×10 ⁻¹ |
| Pu-239, -240 | 7.47×10 ¹ | 5.70×10 ¹ | 1.52×10 ¹ | 2.53×10 ¹ | 3.67 | 2.21×10 ² | 1.29×10 ¹ | 1.74×10 ² | 2.01×10 ¹ | 7.47×10 ¹ | 3.83 | 1.45×10 ¹ | 6.97×10 ² |

Key: C=carbon; Cs=cesium; H=hydrogen; I=iodine; Np=neptunium; Pu=plutonium; Sr=strontium; Tc=technetium; U=uranium.

Source: SAIC 2006a.

Table D-31. Single-Shell Tank Nonradiological Constituent Tank Waste Retrieval Leak Inventories (kilograms)

| Analyte | Tank Farm | | | | | | | | | | | | Total |
|---------------------------|-----------------------|-----------------------|-----------------------|-----------------------|-----------------------|-----------------------|-----------------------|-----------------------|-----------------------|-----------------------|-----------------------|-----------------------|----------------------|
| | A | AX | B | BX | BY | C | S | SX | T | TX | TY | U | |
| Chromium | 1.19×10 ² | 4.39×10 ¹ | 1.20×10 ² | 2.31×10 ² | 2.29×10 ² | 4.15×10 ¹ | 2.73×10 ² | 4.21×10 ² | 1.38×10 ² | 2.05×10 ² | 7.17×10 ¹ | 1.92×10 ² | 2.08×10 ³ |
| Mercury | 4.02 | 2.54 | 1.18 | 2.71 | 4.93×10 ⁻¹ | 2.44 | 1.73×10 ⁻¹ | 1.20 | 1.37×10 ⁻¹ | 2.53×10 ⁻¹ | 1.57 | 3.32×10 ⁻¹ | 1.70×10 ¹ |
| Nitrate | 5.53×10 ³ | 1.02×10 ⁵ | 7.29×10 ⁴ | 2.89×10 ⁴ | 1.55×10 ⁴ | 9.53×10 ⁴ | 2.40×10 ⁴ | 5.35×10 ⁴ | 6.19×10 ⁴ | 3.74×10 ⁴ | 7.84×10 ³ | 9.72×10 ⁴ | 6.02×10 ⁵ |
| Lead | 8.21×10 ¹ | 6.98×10 ¹ | 4.42×10 ¹ | 4.26×10 ¹ | 1.47×10 ¹ | 3.33×10 ³ | 5.05 | 7.89 | 4.96×10 ¹ | 1.90×10 ¹ | 1.28×10 ¹ | 9.86×10 ¹ | 3.77×10 ³ |
| Uranium | 1.79×10 ² | 2.93×10 ¹ | 2.15×10 ² | 7.25×10 ² | 1.95×10 ² | 8.04×10 ² | 1.35×10 ² | 2.40×10 ² | 2.79×10 ² | 1.59×10 ² | 3.23×10 ² | 2.50×10 ² | 3.53×10 ³ |
| Acetonitrile | 0 | 0 | 0 | 0 | 0 | 0 | 0 | 0 | 0 | 0 | 0 | 0 | 0 |
| Benzene | 0 | 0 | 0 | 0 | 0 | 0 | 0 | 0 | 0 | 0 | 0 | 0 | 0 |
| Butanol | 0 | 0 | 0 | 0 | 0 | 0 | 0 | 0 | 0 | 0 | 0 | 0 | 0 |
| Polychlorinated biphenyls | 1.59×10 ⁻¹ | 1.06×10 ⁻¹ | 4.25×10 ⁻¹ | 3.19×10 ⁻¹ | 3.19×10 ⁻¹ | 4.25×10 ⁻¹ | 3.19×10 ⁻¹ | 3.99×10 ⁻¹ | 4.25×10 ⁻¹ | 4.78×10 ⁻¹ | 1.59×10 ⁻¹ | 4.25×10 ⁻¹ | 3.96 |
| 2,4,6-Trichlorophenol | 0 | 0 | 0 | 0 | 0 | 0 | 0 | 0 | 0 | 0 | 0 | 0 | 0 |

Key: butanol=n-butyl alcohol.

Source: SAIC 2007f.

The 11 Tank Closure alternatives developed for this *TC & WM EIS* are differentiated based on waste retrieval, waste treatment, and waste form characteristics, as described in Table D–32. The retrieval efficiencies considered vary from 90 to 99.9 percent of waste volume. Treatment options considered include:

- Retrieval and treatment of transuranic (TRU) waste constituents from selected tanks
- Solid-liquid separations designed to direct long-lived radionuclides to the immobilized high-level radioactive waste (IHLW) stream
- Ion exchange removal of technetium-99 to remove a mobile constituent from the low-activity waste (LAW) stream
- Recovery of iodine-129 from melter offgas to control releases to the atmosphere
- Distribution of recovered activity among waste forms, including IHLW glass and LAW forms, immobilized low-activity waste (ILAW) glass, bulk vitrification glass, cast stone waste, steam reforming waste, sulfate grout, and secondary (iodine) grout
- Treatment of the cesium-137 and strontium-90 capsules

Table D–32. Tank Closure Alternatives – Summary of Conditions

| Tank Closure Alternative | Retrieval Efficiency (percent) | Supplemental Treatment 200-East Area | | | Primary LAW Form | | TRU Waste Treatment |
|--------------------------|--------------------------------|--------------------------------------|-----------------------|-----------------|-----------------------------------|-----------------------|---------------------|
| | | Cesium Removal | Technetium-99 Removal | Sulfate Removal | 200-East Area | 200-West Area | |
| 1 | 0 | a | a | a | a | a | a |
| 2A | 99 | Yes | No | No | ILAW glass | b | No |
| 2B | 99 | Yes | Yes | No | ILAW glass | b | No |
| 3A | 99 | Yes | No | No | ILAW glass; BV glass | BV glass | Yes |
| 3B | 99 | Yes | Yes | No | ILAW glass; cast stone waste | Cast stone waste | Yes |
| 3C | 99 | Yes | No | No | ILAW glass; steam reforming waste | Steam reforming waste | Yes |
| 4 | 99.9 | Yes | No | No | ILAW glass; cast stone waste | BV glass | Yes |
| 5 | 90 | Yes | No | Yes | ILAW glass; cast stone waste | BV glass | Yes |
| 6A | 99.9 | Yes | No | No | Not applicable | c | No |
| 6B | 99.9 | Yes | No | No | ILAW glass ^d | c | No |
| 6C | 99 | Yes | No | No | ILAW glass ^d | c | No |

^a Not applicable; no retrieval or processing under Alternative 1.

^b Not applicable; no treatment in the 200-West Area under Alternative 2A or 2B.

^c Not applicable; no treatment in the 200-West Area under Alternative 6A, 6B, or 6C.

^d ILAW managed and disposed of as high-level radioactive waste under Alternatives 6B and 6C.

Key: BV=bulk vitrification; ILAW=immobilized low-activity waste; LAW=low-activity waste; TRU=transuranic; WTP=Waste Treatment Plant.

Source: SAIC 2007g.

An additional differentiating characteristic is location of the waste processing facilities. Under Tank Closure Alternative 1 (No Action), retrieval and processing would not occur, and the waste would be managed in place as required for safety and protection of the environment. This arrangement is represented in Figure D-1. Material balances under Tank Closure Alternative 1 are presented in Tables D-33 and D-34. The BBI estimate, summarized in Tables D-4 through D-7, constitutes the inventories under this alternative.

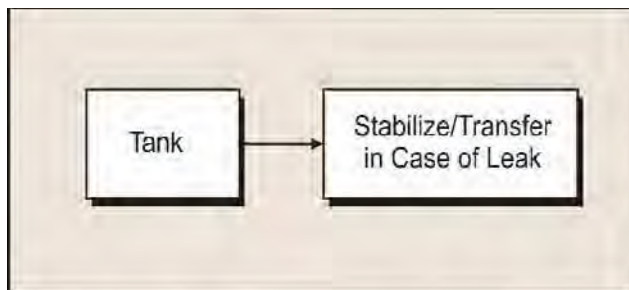

**Figure D-1. Tank Closure Alternative 1
Flowsheet**

Under Tank Closure Alternatives 2A, 2B, 6A, 6B, and 6C, all processing would occur in the 200-East Area. Under the remaining Tank Closure alternatives, processing would occur in both the 200-East and 200-West Areas. Under all alternatives other than Tank Closure Alternative 1, the initial processing step in both the 200-East and 200-West Areas would be solid-liquid separations, with recovered solids solidified as IHLW glass. Subsequent processing steps and related mass balances are described in the following paragraphs for each Tank Closure alternative.

The waste forms of the long-lived, mobile radionuclides technetium-99 and iodine-129 are of interest with regard to long-term performance assessment. Both elements exist as water-soluble species and move through process operations in the liquid phase. To facilitate evaluation of the relative efficiency of retention of these two radionuclides in the LAW forms, separation of technetium-99 from the 200-East Area liquid stream and immobilization into IHLW glass was considered under Tank Closure Alternatives 2B and 3B. Under Tank Closure Alternative 2B, with technetium-99 removal in WTP, approximately 98 percent of the BBI estimate for technetium-99 would be solidified in IHLW glass; under Tank Closure Alternative 3B, approximately 66 percent of the BBI estimate for technetium-99 would be solidified in IHLW glass. Under this latter alternative, approximately 32 percent of the BBI estimate for technetium-99 would be contained in the 200-East and 200-West Area cast stone. Without technetium-99 removal, under Tank Closure Alternatives 3A and 3C, approximately 28 percent of the BBI estimate for technetium-99 would be solidified in ILAW glass, and approximately 70 percent of the BBI estimate for technetium-99 would be solidified in the bulk vitrification glass or steam reforming waste. The remaining 2 percent would be encapsulated in a (secondary waste) grout.

The WTP Pretreatment Facility was originally designed to remove technetium and blend the technetium removed from LAW vitrification feed with HLW solids for feed to HLW vitrification. However, based on reviews of technetium-99 in ILAW glass, DOE and Ecology agreed to delete technetium removal from the WTP permit (Hedges 2008). With this modification, technetium-99 would not be separated from the pretreated LAW feed and combined with the HLW solids for vitrification processing into IHLW glass. Thus, the technetium-99 content of the resulting IHLW glass would decrease, while the technetium-99 concentration in the ILAW glass would increase.

Various alternatives in this *TC & WM EIS* examine the impacts of removing the technetium-99 in the WTP. Table D-32 indicates whether technetium-99 removal would occur under the various alternatives. If technetium-99 is not removed in WTP pretreatment, most of it would be immobilized in ILAW glass. If technetium-99 removal occurs during WTP pretreatment, most of the technetium-99 would be immobilized in IHLW glass. See Appendix E, Section E.1.2.3.10, for further details.

Table D-33. Tank Closure Alternative 1: Radiological Constituents of Potential Concern Balance

| | Iodine-129 | | Cesium-137 | | Carbon-14 | | Hydrogen-3 (Tritium) | | Uranium-233, -234, -235, -238 | | Neptunium-237 | | Plutonium -239, -240 | | Strontium-90 | | Technetium-99 | |
|--|----------------------------|--------------|----------------------------|--------------|----------------------------|--------------|----------------------------|--------------|-------------------------------|--------------|----------------------------|--------------|----------------------------|--------------|----------------------------|--------------|----------------------------|--------------|
| | Curies | % of BBI | Curies | % of BBI | Curies | % of BBI | Curies | % of BBI | Curies | % of BBI | Curies | % of BBI | Curies | % of BBI | Curies | % of BBI | Curies | % of BBI |
| Best-Basis Inventory | | | | | | | | | | | | | | | | | | |
| BBI ^a | 4.82×10 ¹ | N/A | 4.58×10 ⁷ | N/A | 3.12×10 ³ | N/A | 1.21×10 ⁴ | N/A | 9.38×10 ² | N/A | 1.41×10 ² | N/A | 8.14×10 ⁴ | N/A | 5.05×10 ⁷ | N/A | 2.97×10 ⁴ | N/A |
| Tank Closure Waste Inventory | | | | | | | | | | | | | | | | | | |
| Tank residual waste | 4.82×10 ¹ | 100.0 | 4.58×10 ⁷ | 100.0 | 3.12×10 ³ | 100.0 | 1.21×10 ⁴ | 100.0 | 9.38×10 ² | 100.0 | 1.41×10 ² | 100.0 | 8.14×10 ⁴ | 100.0 | 5.05×10 ⁷ | 100.0 | 2.97×10 ⁴ | 100.0 |
| Total | 4.82×10¹ | 100.0 | 4.58×10⁷ | 100.0 | 3.12×10³ | 100.0 | 1.21×10⁴ | 100.0 | 9.38×10² | 100.0 | 1.41×10² | 100.0 | 8.14×10⁴ | 100.0 | 5.05×10⁷ | 100.0 | 2.97×10⁴ | 100.0 |
| Other Inventory | | | | | | | | | | | | | | | | | | |
| Cesium and strontium capsules ^b | 0 | N/A | 4.63×10 ⁷ | N/A | 0 | N/A | 0 | N/A | 0 | N/A | 0 | N/A | 0 | N/A | 2.04×10 ⁷ | N/A | 0 | N/A |

^a Source of BBI is DOE-ORP-2003-02, Rev. 0, *Inventory and Source Term Data Package* (DOE 2003a). BBI percentages are rounded to the nearest tenth.

^b Cesium and strontium capsules remain in storage at the Waste Encapsulation and Storage Facility.

Key: %=percent; BBI=Best-Basis Inventory; N/A=not applicable.

Source: SAIC 2007g, 2007h, 2008a.

Table D-34. Tank Closure Alternative 1: Chemical Constituents of Potential Concern Balance

| | Chromium | | Mercury | | Nitrate | | Lead | | Total Uranium | | Acetonitrile | | Benzene | | Butanol | | PCBs | | 2,4,6-TCP | |
|-------------------------------------|----------------------------|--------------|----------------------------|--------------|----------------------------|--------------|----------------------------|--------------|----------------------------|--------------|----------------------------|--------------|-------------|--------------|----------------------------|--------------|----------------------------|--------------|-------------|--------------|
| | Kg | % of BBI | Kg | % of BBI | Kg | % of BBI | Kg | % of BBI | Kg | % of BBI | Kg | % of BBI | Kg | % of BBI | Kg | % of BBI | Kg | % of BBI | Kg | % of BBI |
| Best-Basis Inventory | | | | | | | | | | | | | | | | | | | | |
| BBI ^a | 5.98×10 ⁵ | N/A | 1.83×10 ³ | N/A | 7.08×10 ⁷ | N/A | 8.41×10 ⁴ | N/A | 5.97×10 ⁵ | N/A | 2.95×10 ⁴ | N/A | 2.40 | N/A | 3.45×10 ⁶ | N/A | 1.68×10 ³ | N/A | 1.11 | N/A |
| Tank Closure Waste Inventory | | | | | | | | | | | | | | | | | | | | |
| Tank residual waste | 5.98×10 ⁵ | 100.0 | 1.83×10 ³ | 100.0 | 7.08×10 ⁷ | 100.0 | 8.41×10 ⁴ | 100.0 | 5.97×10 ⁵ | 100.0 | 2.95×10 ⁴ | 100.0 | 2.40 | 100.0 | 3.45×10 ⁶ | 100.0 | 1.68×10 ³ | 100.0 | 1.11 | 100.0 |
| Total | 5.98×10⁵ | 100.0 | 1.83×10³ | 100.0 | 7.08×10⁷ | 100.0 | 8.41×10⁴ | 100.0 | 5.97×10⁵ | 100.0 | 2.95×10⁴ | 100.0 | 2.40 | 100.0 | 3.45×10⁶ | 100.0 | 1.68×10³ | 100.0 | 1.11 | 100.0 |

^a Source of BBI is DOE-ORP-2003-02, Rev. 0, *Inventory and Source Term Data Package* (DOE 2003a). BBI percentages are rounded to the nearest tenth.

Key: %=percent; 2,4,6-TCP=2,4,6-trichlorophenol; BBI=Best-Basis Inventory; butanol=n-butyl alcohol; kg=kilograms; N/A=not applicable; PCBs=polychlorinated biphenyls.

Source: SAIC 2007g, 2007i, 2008a.

The distribution of the radionuclides can vary based on how the waste is treated and on the types of waste produced under each Tank Closure alternative. The partitioning of iodine among the waste forms is affected by whether the processing is thermal or nonthermal. In nonthermal processing, iodine would remain in the cast stone. Thermal processing in the WTP HLW and LAW melters or in the bulk vitrification and steam reforming processes would leave a portion of the iodine in the feed stream where it would be volatilized and recovered from the offgas for disposal in a secondary grout. Thus, for thermal processing, it was assumed that approximately 20 percent of the feed iodine would be solidified in ILAW glass, bulk vitrification glass, and steam reforming waste, and approximately 80 percent would be encapsulated in a (secondary waste) grout (CEES 2007b). Distribution of technetium-99 and iodine-129 among the waste forms under each alternative is described in detail in the activity balance tables presented in the following text and in Appendix E, Sections E.1.2.3.6 and E.1.2.3.8.

Tank Closure Alternatives 2A and 2B both involve processing waste in the WTP to form IHLW glass and ILAW glass. No supplemental technology would be utilized to treat the LAW portion of the waste. Tank Closure Alternative 2A does not include technetium-99 removal; therefore, the bulk of the technetium-99 would be immobilized in the ILAW glass. Tank Closure Alternative 2B includes technetium-99 removal from the LAW stream, so the majority of the technetium-99 inventory, approximately 97.5 percent of the BBI estimate for technetium-99, would be immobilized in IHLW glass. Under both Tank Closure Alternatives 2A and 2B, it was estimated that approximately 20 percent of the retrieved iodine would be solidified in ILAW glass, while the remaining 80 percent would be encapsulated in grout (secondary waste). Appendix N, Section N.3.8, provides a sensitivity analysis of additional retention of iodine-129 in ILAW glass. Flowsheet schematics for Tank Closure Alternatives 2A and 2B are presented in Figures D-2 and D-3, respectively. Material balances under Tank Closure Alternatives 2A and 2B are presented in Tables D-35 through D-38.

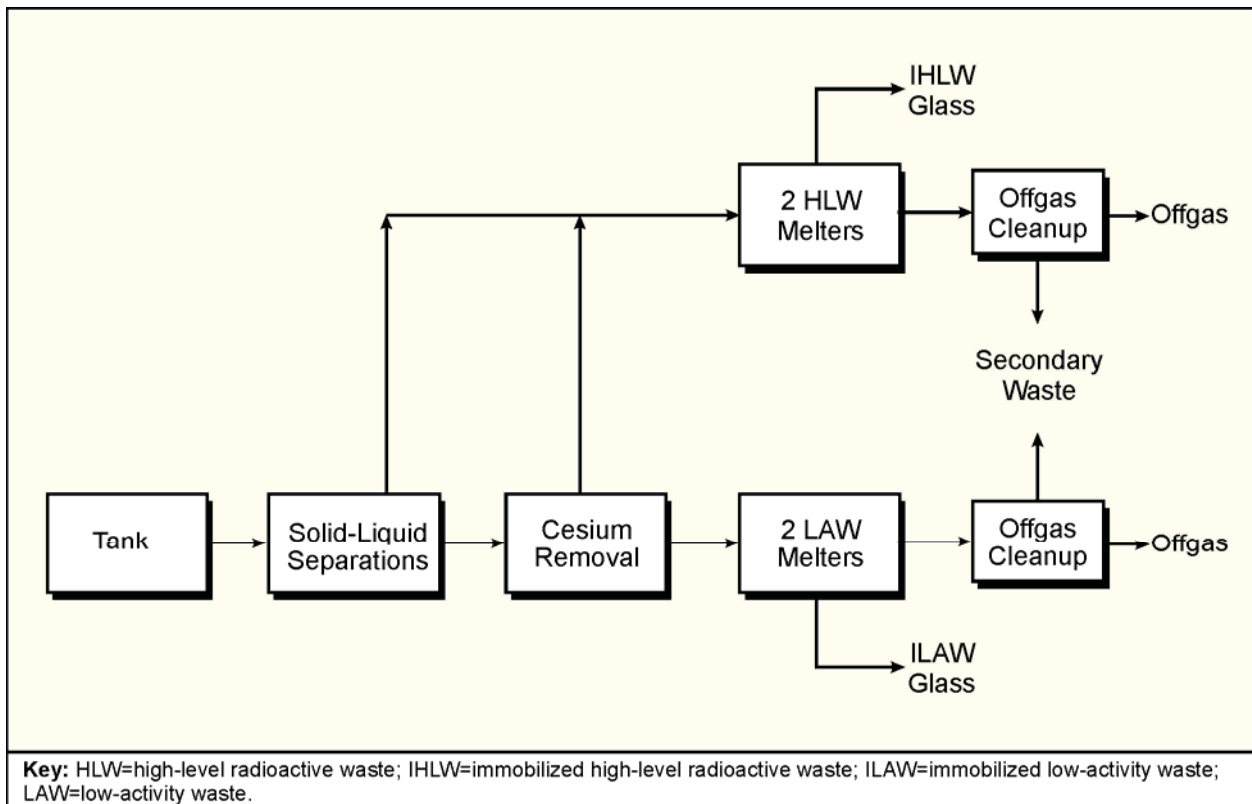

Figure D-2. Tank Closure Alternative 2A Flowsheet

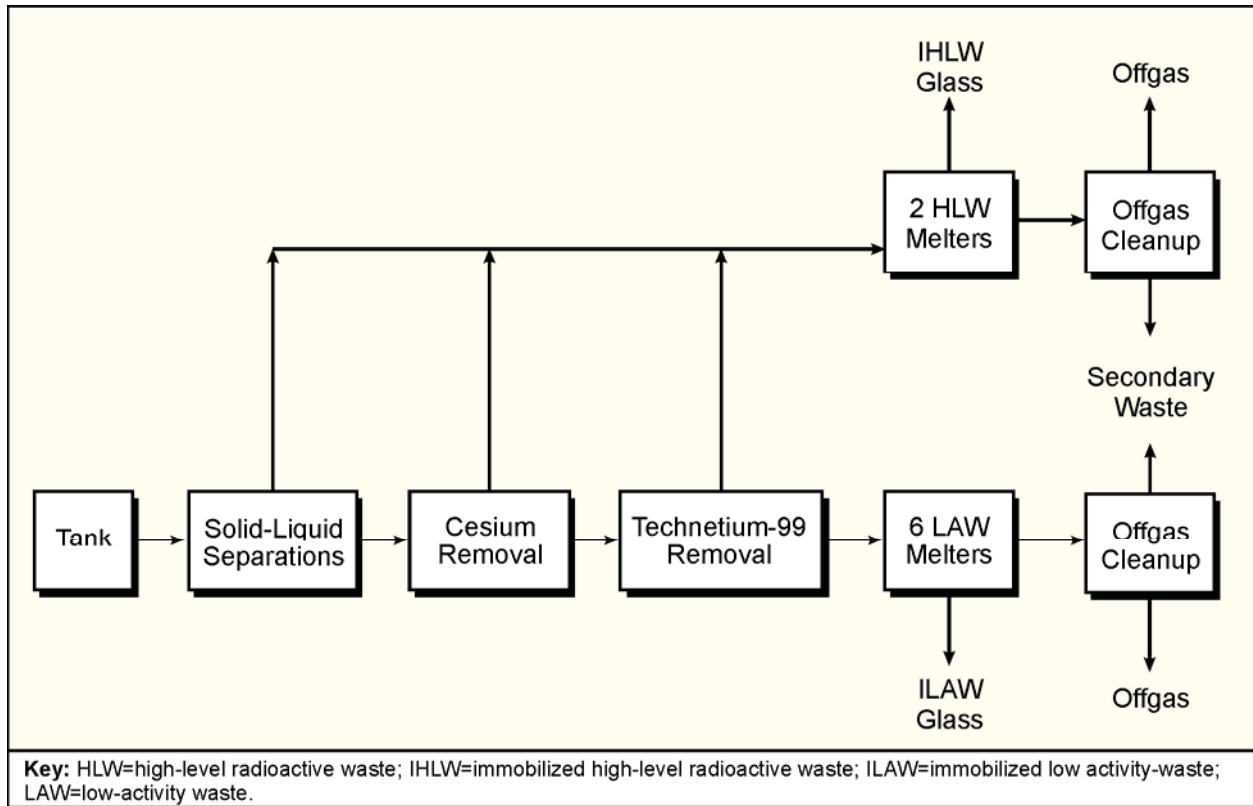

Figure D-3. Tank Closure Alternative 2B Flowsheet

Table D-35. Tank Closure Alternative 2A: Radiological Constituents of Potential Concern Balance

| | Iodine-129 | | Cesium-137 | | Carbon-14 | | Hydrogen-3 (Tritium) | | Uranium-233, -234, -235, -238 | | Neptunium-237 | | Plutonium -239, -240 | | Strontium-90 | | Technetium-99 | |
|--|----------------------------|--------------|----------------------------|--------------|----------------------------|-------------|----------------------------|-------------|----------------------------------|--------------|----------------------------|--------------|----------------------------|--------------|----------------------------|--------------|----------------------------|--------------|
| | Curies | % of BBI | Curies | % of BBI | Curies | % of BBI | Curies | % of BBI | Curies | % of BBI | Curies | % of BBI | Curies | % of BBI | Curies | % of BBI | Curies | % of BBI |
| Best-Basis Inventory | | | | | | | | | | | | | | | | | | |
| BBI ^a | 4.82×10 ¹ | N/A | 4.58×10 ⁷ | N/A | 3.12×10 ³ | N/A | 1.21×10 ⁴ | N/A | 9.38×10 ² | N/A | 1.41×10 ² | N/A | 8.14×10 ⁴ | N/A | 5.05×10 ⁷ | N/A | 2.97×10 ⁴ | N/A |
| Tank Closure Waste Inventory | | | | | | | | | | | | | | | | | | |
| Tank residual waste ^b | 4.82×10 ⁻¹ | 1.0 | 4.58×10 ⁵ | 1.0 | 3.12×10 ¹ | 1.0 | 1.21×10 ² | 1.0 | 9.38 | 1.0 | 1.41 | 1.0 | 8.14×10 ² | 1.0 | 5.05×10 ⁵ | 1.0 | 2.97×10 ² | 1.0 |
| IHLW glass ^c | 6.99×10 ⁻³ | 0.0 | 4.49×10 ⁷ | 97.9 | 0 | 0.0 | 0 | 0.0 | 8.73×10 ² | 93.1 | 1.40×10 ² | 99.0 | 8.06×10 ⁴ | 99.0 | 4.93×10 ⁷ | 97.6 | 2.47×10 ² | 0.8 |
| ILAW glass and retired LAW melters | 9.56 | 19.8 | 4.45×10 ⁵ | 1.0 | 0 | 0.0 | 0 | 0.0 | 5.47×10 ¹ | 5.8 | 8.35×10 ⁻³ | 0.0 | 1.45 | 0.0 | 2.30×10 ³ | 0.0 | 2.88×10 ⁴ | 96.9 |
| ETF-generated solid secondary waste ^d | 3.36×10 ¹ | 69.7 | 4.59×10 ⁻¹ | 0.0 | 8.51 | 0.3 | 0 | 0.0 | 4.03×10 ⁻² | 0.0 | 5.11×10 ⁻² | 0.0 | 6.90×10 ⁻⁴ | 0.0 | 6.42 | 0.0 | 8.63×10 ¹ | 0.3 |
| Solid secondary waste ^e | 4.65 | 9.7 | 1.95×10 ⁵ | 0.4 | 0 | 0.0 | 0 | 0.0 | 3.64 | 0.4 | 2.83×10 ⁻¹ | 0.2 | 1.98×10 ² | 0.2 | 7.76×10 ⁵ | 1.5 | 4.31×10 ² | 1.5 |
| Total^f | 4.83×10¹ | 100.2 | 4.60×10⁷ | 100.2 | 3.97×10¹ | 1.3 | 1.21×10² | 1.0 | 9.41×10² | 100.3 | 1.41×10² | 100.2 | 8.16×10⁴ | 100.2 | 5.06×10⁷ | 100.1 | 2.99×10⁴ | 100.5 |
| Other Inventory | | | | | | | | | | | | | | | | | | |
| Solid and liquid secondary waste from cesium and strontium capsules | 0 | N/A | 1.99×10 ⁵ | N/A | 0 | N/A | 0 | N/A | 0 | N/A | 0 | N/A | 0 | N/A | 3.16×10 ⁵ | N/A | 0 | N/A |
| Cesium and strontium capsules ^g | 0 | N/A | 4.59×10 ⁷ | N/A | 0 | N/A | 0 | N/A | 0 | N/A | 0 | N/A | 0 | N/A | 1.98×10 ⁷ | N/A | 0 | N/A |
| Air Emissions | | | | | | | | | | | | | | | | | | |
| Treatment air emissions ^h | 4.78×10 ¹ | N/A | 7.99×10 ⁴ | N/A | 3.10×10 ³ | N/A | 1.20×10 ⁴ | N/A | 4.66×10 ⁻¹ | N/A | 7.00×10 ⁻² | N/A | 4.04×10 ¹ | N/A | 3.59×10 ⁴ | N/A | 1.47×10 ¹ | N/A |

^a Source of BBI is DOE-ORP-2003-02, Rev. 0, *Inventory and Source Term Data Package* (DOE 2003a).

^b Represents 99.0 percent retrieval. For analysis purposes, waste inventories from tank waste retrieval leaks and ancillary equipment were assumed to be treated in the Waste Treatment Plant.

^c To be stored on site until disposition decisions are made and implemented. The inventory would include the retired HLW melters.

^d Includes secondary liquids that would be sent to the ETF and treated; solids would be disposed of in an Integrated Disposal Facility. Excludes liquid secondary waste from the processing of cesium and strontium capsules, which would be reported separately.

^e Includes solid low-level radioactive waste and mixed low-level radioactive waste streams that would be generated by the waste treatment operations. Such waste streams would include debris waste, melter consumables, failed process components, analytical laboratory waste, spent resins, spent carbon adsorbent, high-efficiency particulate air filters, and other process-related waste.

^f Totals may exceed 100 percent due to conservative in estimates or rounded numbers. BBI percentages were rounded to the nearest tenth. Carbon-14 and hydrogen-3 (tritium) may not total 100 percent; a portion of each would be released to the offgas streams and stack, and a portion (ETF-generated liquid) would be disposed of in the State-Approved Land Disposal Site.

^g To be treated in the Waste Treatment Plant, resulting in glass waste, which would be stored on site until disposition decisions are made and implemented.

^h Includes air emissions from all waste treatment processes, including those from treatment of the cesium and strontium capsules. For analysis purposes, both iodine-129 capture and air emission releases were assumed.

Key: %=percent; BBI=Best-Basis Inventory; ETF=Effluent Treatment Facility; HLW=high-level radioactive waste; IHLW=immobilized high-level radioactive waste; ILAW=immobilized low-activity waste; LAW=low-activity waste; N/A=not applicable.

Source: SAIC 2007g, 2007h, 2008a.

Table D-36. Tank Closure Alternative 2A: Chemical Constituents of Potential Concern Balance

| | Chromium | | Mercury | | Nitrate | | Lead | | Total Uranium | | Acetonitrile | | Benzene | | Butanol | | PCBs | | 2,4,6-TCP | |
|--|----------------------------|--------------|----------------------------|-------------|----------------------------|-------------|----------------------------|--------------|----------------------------|----------------------|----------------------------|------------|-----------------------------|----------------------|----------------------------|----------------------|----------------------------|------------|-----------------------------|------------|
| | Kg | % of BBI | Kg | % of BBI | Kg | % of BBI | Kg | % of BBI | Kg | % of BBI | Kg | % of BBI | Kg | % of BBI | Kg | % of BBI | Kg | % of BBI | Kg | % of BBI |
| Best-Basis Inventory | | | | | | | | | | | | | | | | | | | | |
| BBI ^a | 5.98×10 ⁵ | N/A | 1.83×10 ³ | N/A | 7.08×10 ⁷ | N/A | | | N/A | 2.95×10 ⁴ | N/A | 2.40 | N/A | 3.45×10 ⁶ | N/A | 1.68×10 ³ | N/A | 1.11 | N/A | |
| Tank Closure Waste Inventory | | | | | | | | | | | | | | | | | | | | |
| Tank residual waste ^b | 5.98×10 ³ | 1.0 | 1.83×10 ¹ | 1.0 | 7.08×10 ⁵ | 1.0 | 8.41×10 ² | 1.0 | 5.97×10 ³ | 1.0 | 2.95×10 ² | 1.0 | 2.40×10 ⁻² | 1.0 | 3.45×10 ⁴ | 1.0 | 1.68×10 ¹ | 1.0 | 1.11×10 ⁻² | 1.0 |
| IHLW glass ^c | 1.36×10 ⁵ | 22.7 | 0 | 0.0 | 0 | 0.0 | 7.45×10 ⁴ | 88.6 | 5.52×10 ⁵ | 92.5 | 0 | 0.0 | 0 | 0.0 | 0 | 0.0 | 0 | 0.0 | 0 | 0.0 |
| ILAW glass and retired LAW melters | 4.56×10 ⁵ | 76.2 | 0 | 0.0 | 0 | 0.0 | 8.88×10 ³ | 10.6 | 3.74×10 ⁴ | 6.3 | 0 | 0.0 | 0 | 0.0 | 0 | 0.0 | 0 | 0.0 | 0 | 0.0 |
| ETF-generated solid secondary waste ^d | 4.43×10 ¹ | 0.0 | 5.55 | 0.3 | 9.01×10 ⁶ | 12.7 | 4.58 | 0.0 | 4.00×10 ¹ | 0.0 | NR | N/A | NR | N/A | NR | N/A | NR | N/A | NR | N/A |
| Solid secondary waste ^e | 1.94×10 ³ | 0.3 | 1.76×10 ³ | 96.4 | 0 | 0.0 | 2.47×10 ² | 0.3 | 2.32×10 ³ | 0.4 | NR | N/A | NR | N/A | NR | N/A | NR | N/A | NR | N/A |
| Total^f | 6.00×10⁵ | 100.3 | 1.78×10³ | 97.7 | 9.72×10⁶ | 13.7 | 8.45×10⁴ | 100.5 | 5.98×10⁵ | 100.2 | 2.95×10² | 1.0 | 2.40×10⁻² | 1.0 | 3.45×10⁴ | 1.0 | 1.68×10¹ | 1.0 | 1.11×10⁻² | 1.0 |
| Other Inventory^g | | | | | | | | | | | | | | | | | | | | |
| Treatment air emissions ^h | NR | N/A | 2.00×10 ³ | N/A | NR | N/A | NR | N/A | NR | N/A | NR | N/A | NR | N/A | NR | N/A | NR | N/A | NR | N/A |

^a Source of BBI is DOE-ORP-2003-02, Rev. 0, *Inventory and Source Term Data Package* (DOE 2003a).

^b Represents 99.0 percent retrieval. For analysis purposes, waste inventories from tank waste retrieval leaks and ancillary equipment were assumed to be treated in the Waste Treatment Plant.

^c Includes retired HLW melter inventory. IHLW glass would be stored on site until disposition decisions are made and implemented.

^d Includes secondary liquids that would be sent to the ETF and treated; solids would be disposed of in an Integrated Disposal Facility.

^e Includes solid low-level radioactive waste and mixed low-level radioactive waste streams that would be generated by the waste treatment operations. Such waste streams would include debris waste, melter consumables, failed process components, analytical laboratory waste, spent resins, spent carbon adsorbent, high-efficiency particulate air filters, and other process-related waste. Excludes contaminated liquid effluent waste streams that would be treated at the ETF.

^f Totals may exceed 100 percent due to conservative in estimates or rounded numbers. BBI percentages were rounded to the nearest tenth. The organic chemicals (acetonitrile, benzene, butanol, polychlorinated biphenyls, and 2,4,6-trichlorophenol) may not total 100 percent because they would be destroyed during the thermal treatment processes. Nitrate may not total 100 percent because it would be volatilized and released through the facility stack.

^g No chemical constituents of potential concern have been reported in the cesium and strontium capsule secondary waste streams.

^h Includes air emissions from all waste treatment processes, including those from treatment of the cesium and strontium capsules. For analysis purposes, both mercury capture and air emission releases were assumed.

Key: %=percent; 2,4,6-TCP=2,4,6-trichlorophenol; BBI=Best-Basis Inventory; butanol=n-butyl alcohol; ETF=Effluent Treatment Facility; HLW=high-level radioactive waste; IHLW=immobilized high-level radioactive waste; ILAW=immobilized low-activity waste; kg=kilograms; LAW=low-activity waste; N/A=not applicable; NR=not reported; PCBs=polychlorinated biphenyls; WTP=Waste Treatment Plant.

Source: SAIC 2007g, 2007i, 2008a.

Table D-37. Tank Closure Alternative 2B: Radiological Constituents of Potential Concern Balance

| | Iodine-129 | | Cesium-137 | | Carbon-14 | | Hydrogen-3 (Tritium) | | Uranium-233, -234, -235, -238 | | Neptunium-237 | | Plutonium -239,-240 | | Strontium-90 | | Technetium-99 | |
|---|-----------------------|----------|-----------------------|----------|----------------------|----------|----------------------|----------|-------------------------------|----------|-----------------------|----------|-----------------------|----------|----------------------|----------|----------------------|----------|
| | Curies | % of BBI | Curies | % of BBI | Curies | % of BBI | Curies | % of BBI | Curies | % of BBI | Curies | % of BBI | Curies | % of BBI | Curies | % of BBI | Curies | % of BBI |
| Best-Basis Inventory | | | | | | | | | | | | | | | | | | |
| BBI ^a | 4.82×10 ¹ | N/A | 4.58×10 ⁷ | N/A | 3.12×10 ³ | N/A | 1.21×10 ⁴ | N/A | 9.38×10 ² | N/A | 1.41×10 ² | N/A | 8.14×10 ⁴ | N/A | 5.05×10 ⁷ | N/A | 2.97×10 ⁴ | N/A |
| Tank Closure Waste Inventory | | | | | | | | | | | | | | | | | | |
| Tank residual waste ^b | 4.82×10 ⁻¹ | 1.0 | 4.58×10 ⁵ | 1.0 | 3.12×10 ¹ | 1.0 | 1.21×10 ² | 1.0 | 9.38 | 1.0 | 1.41 | 1.0 | 8.14×10 ² | 1.0 | 5.05×10 ⁵ | 1.0 | 2.97×10 ² | 1.0 |
| IHLW glass ^c | 6.99×10 ⁻³ | 0.0 | 4.49×10 ⁷ | 97.9 | 0 | 0.0 | 0 | 0.0 | 8.73×10 ² | 93.1 | 1.40×10 ² | 99.0 | 8.06×10 ⁴ | 99.0 | 4.93×10 ⁷ | 97.6 | 2.90×10 ⁴ | 97.5 |
| ILAW glass and retired LAW melters | 9.56 | 19.8 | 4.45×10 ⁵ | 1.0 | 0 | 0.0 | 0 | 0.0 | 5.47×10 ¹ | 5.8 | 8.35×10 ⁻³ | 0.0 | 1.45 | 0.0 | 2.30×10 ³ | 0.0 | 2.88×10 ² | 1.0 |
| ETF-generated solid secondary waste ^d | 3.36×10 ¹ | 69.7 | 4.59×10 ⁻¹ | 0.0 | 8.51 | 0.3 | 0 | 0.0 | 4.03×10 ⁻² | 0.0 | 5.11×10 ⁻² | 0.0 | 6.90×10 ⁻⁴ | 0.0 | 6.42 | 0.0 | 8.63×10 ¹ | 0.3 |
| Solid secondary waste ^e | 4.65 | 9.7 | 1.95×10 ⁵ | 0.4 | 0 | 0.0 | 0 | 0.0 | 3.64 | 0.4 | 2.83×10 ⁻¹ | 0.2 | 1.98×10 ² | 0.2 | 7.76×10 ⁵ | 1.5 | 4.92×10 ² | 1.7 |
| Total^f | 4.82×10 ⁻¹ | 1.0 | 4.58×10 ⁵ | 1.0 | 3.12×10 ¹ | 1.0 | 1.21×10 ² | 1.0 | 9.38 | 1.0 | 1.41 | 1.0 | 8.14×10 ² | 1.0 | 5.05×10 ⁵ | 1.0 | 2.97×10 ² | 1.0 |
| Other Inventory | | | | | | | | | | | | | | | | | | |
| Solid and liquid secondary waste from cesium and strontium capsules | 0 | N/A | 1.99×10 ⁵ | N/A | 0 | N/A | 0 | N/A | 0 | N/A | 0 | N/A | 0 | N/A | 3.16×10 ⁵ | N/A | 0 | N/A |
| Cesium and strontium capsules ^g | 0 | N/A | 4.59×10 ⁷ | N/A | 0 | N/A | 0 | N/A | 0 | N/A | 0 | N/A | 0 | N/A | 1.98×10 ⁷ | N/A | 0 | N/A |
| Rubble, soil, and equipment ^h | 1.67×10 ⁻² | N/A | 1.31×10 ⁴ | N/A | 1.47 | N/A | 6.03 | N/A | 4.82×10 ⁻¹ | N/A | 3.24×10 ⁻² | N/A | 4.32×10 ¹ | N/A | 3.05×10 ⁴ | N/A | 9.72 | N/A |
| Air Emissions | | | | | | | | | | | | | | | | | | |
| Treatment air emissions ⁱ | 4.78×10 ¹ | N/A | 7.99×10 ⁴ | N/A | 3.10×10 ³ | N/A | 1.20×10 ⁴ | N/A | 4.66×10 ⁻¹ | N/A | 7.00×10 ⁻² | N/A | 4.04×10 ¹ | N/A | 3.59×10 ⁴ | N/A | 1.47×10 ¹ | N/A |

^a Source of BBI is DOE-ORP-2003-02, Rev. 0, *Inventory and Source Term Data Package* (DOE 2003a).

^b Represents 99.0 percent retrieval. For analysis purposes, waste inventories from tank waste retrieval leaks and ancillary equipment were assumed to be treated in the Waste Treatment Plant.

^c To be stored on site until disposition decisions are made and implemented. The inventory would include the retired HLW melters.

^d Includes secondary liquids that would be sent to the ETF and treated; solids would be disposed of in an Integrated Disposal Facility. Excludes liquid secondary waste from the processing of cesium and strontium capsules, which would be reported separately.

^e Includes solid low-level radioactive waste and mixed low-level radioactive waste streams that would be generated by the waste treatment operations. Such waste streams would include debris waste, melter consumables, failed process components, analytical laboratory waste, spent resins, spent carbon adsorbent, high-efficiency particulate air filters, and other process-related waste. The value for technetium-99 includes 6.04×10⁻¹ curies of technetium-99 that would remain in the spent resin from the technetium-99 removal process.

^f Totals may exceed 100 percent due to conservative estimates or rounded numbers. BBI percentages were rounded to the nearest tenth. Carbon-14 and hydrogen-3 (tritium) may not total 100 percent; a portion of each would be released to the offgas streams and stack, and a portion (ETF-generated liquid) would be disposed of in the State-Approved Land Disposal Site.

^g To be treated in the Waste Treatment Plant, resulting in glass waste, which would be stored on site until disposition decisions are made and implemented.

^h Rubble, soil, and equipment would be generated by removal of 4.6 meters (15 feet) of soil and ancillary equipment at the BX and SX tank farms. This material would be disposed of in the River Protection Project Disposal Facility.

ⁱ Includes air emissions from all waste treatment processes, including those from treatment of the cesium and strontium capsules. For analysis purposes, both iodine-129 capture and air emission releases were assumed.

Key: %=percent; BBI=Best-Basis Inventory; ETF=Effluent Treatment Facility; HLW=high-level radioactive waste; IHLW=immobilized high-level radioactive waste; ILAW=immobilized low-activity waste; LAW=low-activity waste; N/A=not applicable.

Source: SAIC 2007g, 2007h, 2008a.

Table D-38. Alternative 2B: Chemical Constituents of Potential Concern Balance

| | Chromium | | Mercury | | Nitrate | | Lead | | Total Uranium | | Acetonitrile | | Benzene | | Butanol | | PCBs | | 2,4,6-TCP | |
|--|----------------------------|--------------|----------------------------|-------------|----------------------------|-------------|----------------------------|--------------|----------------------------|--------------|----------------------------|------------|-----------------------------|------------|----------------------------|------------|----------------------------|------------|-----------------------------|------------|
| | Kg | % of BBI | Kg | % of BBI | Kg | % of BBI | Kg | % of BBI | Kg | % of BBI | Kg | % of BBI | Kg | % of BBI | Kg | % of BBI | Kg | % of BBI | Kg | % of BBI |
| Best-Basis Inventory | | | | | | | | | | | | | | | | | | | | |
| BBI ^a | 5.98×10 ⁵ | N/A | 1.83×10 ³ | N/A | 7.08×10 ⁷ | N/A | 8.41×10 ⁴ | N/A | 5.97×10 ⁵ | N/A | 2.95×10 ⁴ | N/A | 2.40 | N/A | 3.45×10 ⁶ | N/A | 1.68×10 ³ | N/A | 1.11 | N/A |
| Tank Closure Waste Inventory | | | | | | | | | | | | | | | | | | | | |
| Tank residual waste ^b | 5.98×10 ³ | 1.0 | 1.83×10 ¹ | 1.0 | 7.08×10 ⁵ | 1.0 | 8.41×10 ² | 1.0 | 5.97×10 ³ | 1.0 | 2.95×10 ² | 1.0 | 2.40×10 ⁻² | 1.0 | 3.45×10 ⁴ | 1.0 | 1.68×10 ¹ | 1.0 | 1.11×10 ⁻² | 1.0 |
| IHLW glass ^c | 1.36×10 ⁵ | 22.7 | 0 | 0.0 | 0 | 0.0 | 7.45×10 ⁴ | 88.6 | 5.52×10 ⁵ | 92.5 | 0 | 0.0 | 0 | 0.0 | 0 | 0.0 | 0 | 0.0 | 0 | 0.0 |
| ILAW glass and retired LAW melters | 4.56×10 ⁵ | 76.2 | 0 | 0.0 | 0 | 0.0 | 8.88×10 ³ | 10.6 | 3.74×10 ⁴ | 6.3 | 0 | 0.0 | 0 | 0.0 | 0 | 0.0 | 0 | 0.0 | 0 | 0.0 |
| ETF-generated solid secondary waste ^d | 4.43×10 ¹ | 0.0 | 5.55 | 0.3 | 9.01×10 ⁶ | 12.7 | 4.58 | 0.0 | 4.00×10 ¹ | 0.0 | NR | N/A | NR | N/A | NR | N/A | NR | N/A | NR | N/A |
| Solid secondary waste ^e | 1.94×10 ³ | 0.3 | 1.76×10 ³ | 96.4 | 0 | 0.0 | 2.47×10 ² | 0.3 | 2.32×10 ³ | 0.4 | NR | N/A | NR | N/A | NR | N/A | NR | N/A | NR | N/A |
| Total^f | 6.00×10⁵ | 100.3 | 1.78×10³ | 97.7 | 9.72×10⁶ | 13.7 | 8.45×10⁴ | 100.5 | 5.98×10⁵ | 100.2 | 2.95×10² | 1.0 | 2.40×10⁻² | 1.0 | 3.45×10⁴ | 1.0 | 1.68×10¹ | 1.0 | 1.11×10⁻² | 1.0 |
| Other Inventory^g | | | | | | | | | | | | | | | | | | | | |
| Rubble, soil, and equipment ^h | 5.86×10 ² | N/A | 2.22 | N/A | 3.93×10 ⁴ | N/A | 3.34×10 ¹ | N/A | 6.60×10 ² | N/A | NR | N/A | NR | N/A | NR | N/A | NR | N/A | NR | N/A |
| Air Emissions | | | | | | | | | | | | | | | | | | | | |
| Treatment air emissions ⁱ | NR | N/A | 2.00×10 ³ | N/A | NR | N/A | NR | N/A | NR | N/A | NR | N/A | NR | N/A | NR | N/A | NR | N/A | NR | N/A |

^a Source of BBI is DOE-ORP-2003-02, Rev. 0, *Inventory and Source Term Data Package* (DOE 2003a).

^b Represents 99.0 percent retrieval. For analysis purposes, waste inventories from tank waste retrieval leaks and ancillary equipment were assumed to be treated in the Waste Treatment Plant.

^c Includes retired HLW melter inventory. IHLW glass would be stored on site until disposition decisions are made and implemented.

^d Includes secondary liquids that would be sent to the ETF and treated; solids would be disposed of in an Integrated Disposal Facility.

^e Includes solid low-level radioactive waste and mixed low-level radioactive waste streams that would be generated by the waste treatment operations. These waste streams would include debris waste, melter consumables, failed process components, analytical laboratory waste, spent resins, spent carbon adsorbent, high-efficiency particulate air filters, and other process-related waste. Excludes contaminated liquid effluent waste streams that would be treated at the ETF.

^f Totals may exceed 100 percent due to conservative estimates or rounded numbers. BBI percentages were rounded to the nearest tenth. The organic chemicals (acetonitrile, benzene, butanol, polychlorinated biphenyls, and 2,4,6-trichlorophenol) may not total 100 percent because they would be destroyed during the thermal treatment processes. Nitrate may not total 100 percent because it would be volatilized and released through the facility stack.

^g No chemical constituents of potential concern have been reported in the cesium and strontium capsule secondary waste streams.

^h Rubble, soil, and equipment would be generated by the removal of 4.6 meters (15 feet) of soil and ancillary equipment at the BX and SX tank farms. This material would be disposed of in the River Protection Project Disposal Facility.

ⁱ Includes air emissions from all waste treatment processes, including those from treatment of the cesium and strontium capsules. For analysis purposes, both mercury capture and air emission releases were assumed.

Key: %=percent; 2,4,6-TCP=2,4,6-trichlorophenol; BBI=Best-Basis Inventory; butanol=n-butyl alcohol; ETF=Effluent Treatment Facility; HLW=high-level radioactive waste; IHLW=immobilized high-level radioactive waste; ILAW=immobilized low-activity waste; kg=kilograms; LAW=low-activity waste; N/A=not applicable; NR=not reported; PCBs=polychlorinated biphenyls.

Source: SAIC 2007g, 2007i, 2008a.

Tank Closure Alternatives 3A, 3B, and 3C involve processing waste to produce IHLW glass and ILAW glass, but they differ in that Alternative 3A would produce a supplemental bulk vitrification glass, Alternative 3B would produce a supplemental cast stone waste form, and Alternative 3C would produce a supplemental steam reforming waste form from a portion of the LAW stream. Technetium-99 would be immobilized in the ILAW and the bulk vitrification glass or steam reforming waste under Tank Closure Alternatives 3A and 3C, respectively; approximately 66 percent of the estimated BBI for technetium-99 would be immobilized in the IHLW under Alternative 3B using a technetium-99 removal process in the WTP. Under Tank Closure Alternatives 3A, 3B, and 3C, the ILAW glass, would contain 5.8 percent of the estimated BBI for iodine-129 and the bulk vitrification glass, cast stone waste and steam reforming waste would contain 14.0 percent, 70.1 percent, and 14.0 percent of the estimated BBI for iodine-129, respectively. Flowsheet schematics for Tank Closure Alternatives 3A, 3B, and 3C are presented as Figures D-4, D-5, and D-6, respectively. Material balances under Alternatives 3A, 3B, and 3C are presented in Tables D-39 through D-44.

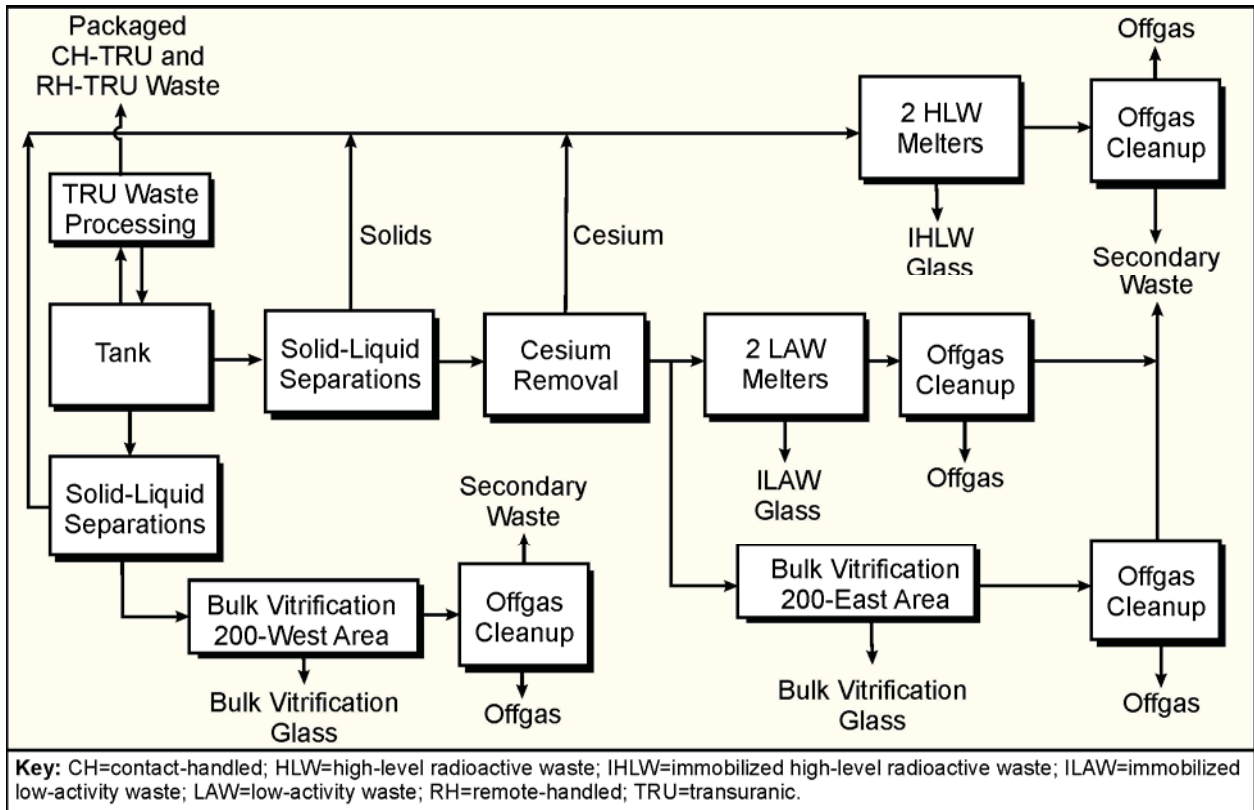

Figure D-4. Tank Closure Alternative 3A Flowsheet

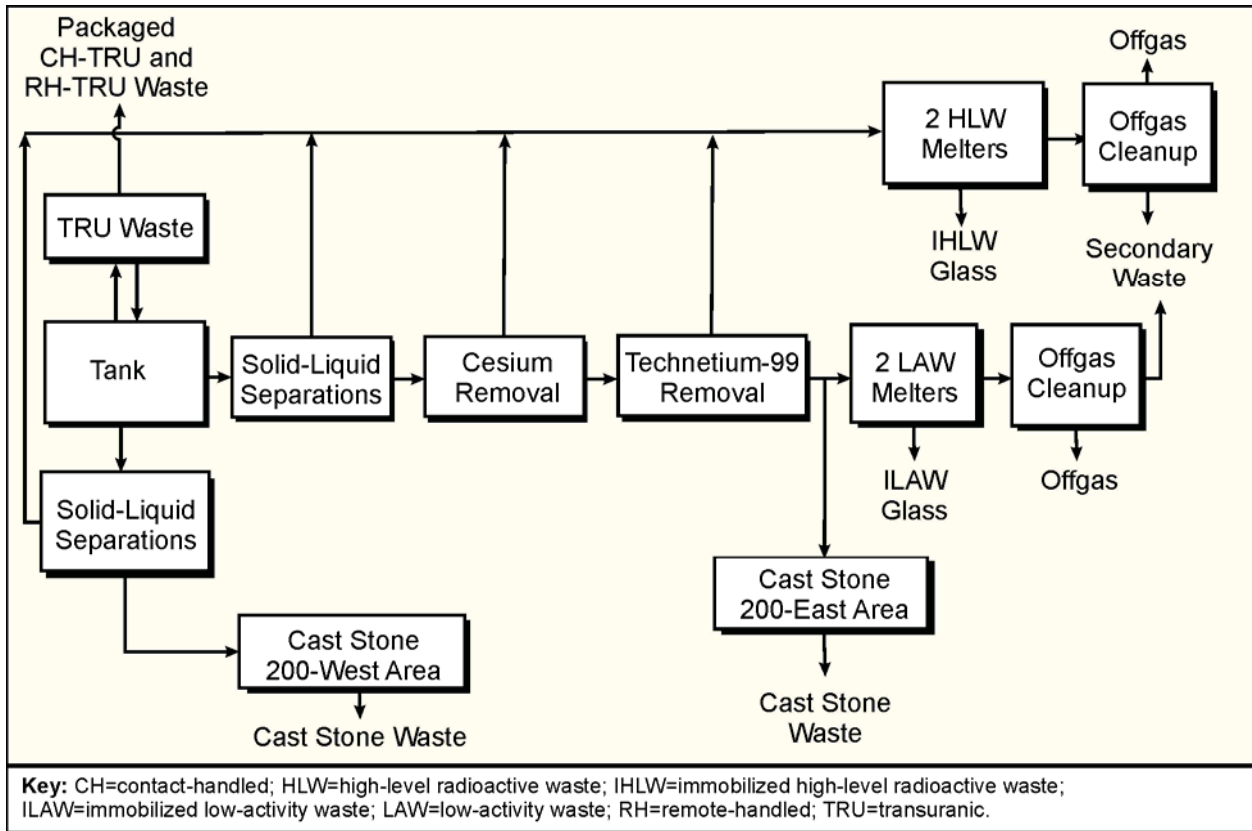

Figure D-5. Tank Closure Alternative 3B Flowsheet

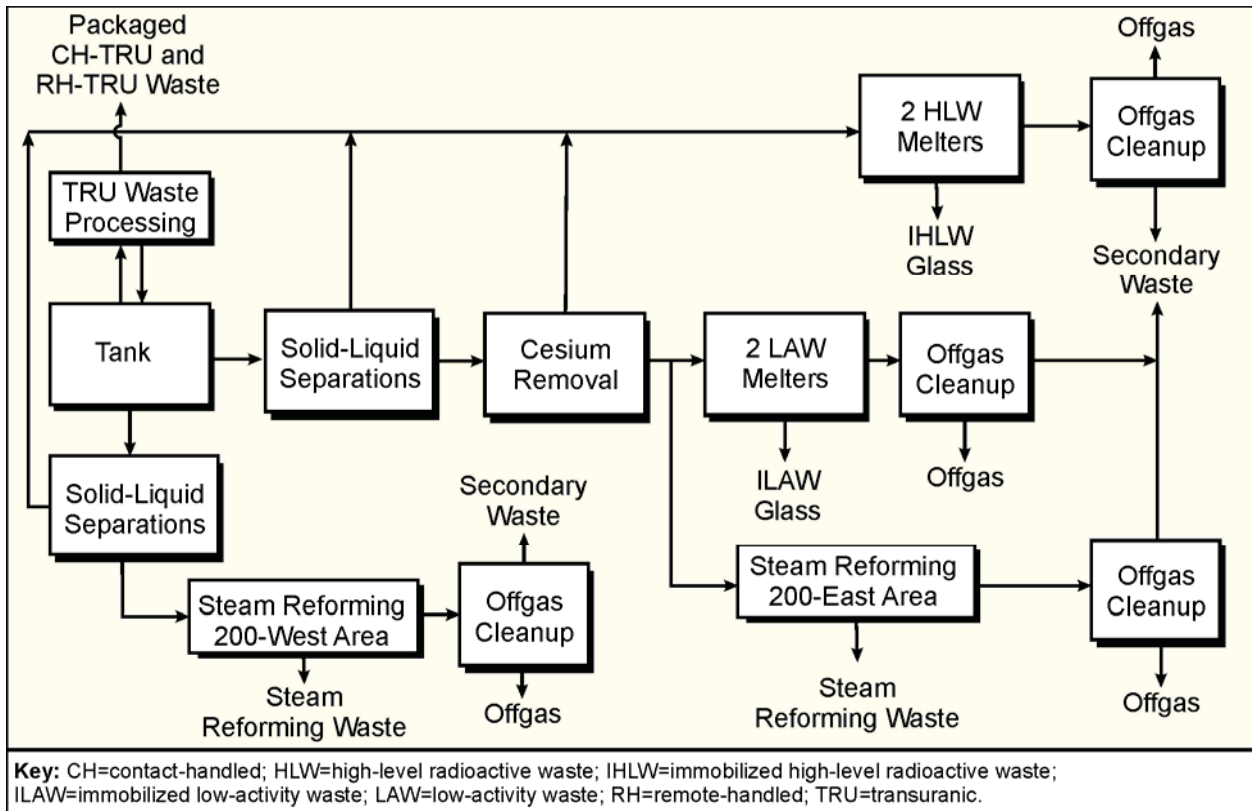

Figure D-6. Tank Closure Alternative 3C Flowsheet

Table D-39. Tank Closure Alternative 3A: Radiological Constituents of Potential Concern Balance

| | Iodine-129 | | Cesium-137 | | Carbon-14 | | Hydrogen-3 (Tritium) | | Uranium-233, -234, -235, -238 | | Neptunium-237 | | Plutonium -239, -240 | | Strontium-90 | | Technetium-99 | |
|---|----------------------------|--------------|----------------------------|--------------|----------------------------|------------|----------------------------|------------|-------------------------------|--------------|----------------------------|--------------|----------------------------|--------------|----------------------------|--------------|----------------------------|--------------|
| | Curies | % of BBI | Curies | % of BBI | Curies | % of BBI | Curies | % of BBI | Curies | % of BBI | Curies | % of BBI | Curies | % of BBI | Curies | % of BBI | Curies | % of BBI |
| Best-Basis Inventory | | | | | | | | | | | | | | | | | | |
| BBI ^a | 4.82×10 ¹ | N/A | 4.58×10 ⁷ | N/A | 3.12×10 ³ | N/A | 1.21×10 ⁴ | N/A | 9.38×10 ² | N/A | 1.41×10 ² | N/A | 8.14×10 ⁴ | N/A | 5.05×10 ⁷ | N/A | 2.97×10 ⁴ | N/A |
| Tank Closure Waste Inventory | | | | | | | | | | | | | | | | | | |
| Tank residual waste ^b | 4.82×10 ¹ | 1.0 | 4.58×10 ⁵ | 1.0 | 3.12×10 ¹ | 1.0 | 1.21×10 ² | 1.0 | 9.38 | 1.0 | 1.41 | 1.0 | 8.14×10 ² | 1.0 | 5.05×10 ⁵ | 1.0 | 2.97×10 ² | 1.0 |
| IHLW glass ^c | 1.32×10 ⁻⁵ | 0.0 | 4.04×10 ⁷ | 88.1 | 0 | 0.0 | 0 | 0.0 | 8.32×10 ² | 88.6 | 1.38×10 ² | 97.8 | 7.31×10 ⁴ | 89.8 | 4.87×10 ⁷ | 96.4 | 1.49×10 ² | 0.5 |
| ILAW glass and retired LAW melters | 2.80 | 5.8 | 1.73×10 ⁵ | 0.4 | 0 | 0.0 | 0 | 0.0 | 1.63×10 ¹ | 1.7 | 2.48×10 ⁻³ | 0.0 | 4.33×10 ⁻¹ | 0.0 | 6.91×10 ² | 0.0 | 8.44×10 ³ | 28.4 |
| ETF-generated solid secondary waste ^d | 3.69×10 ¹ | 76.5 | 1.43×10 ¹ | 0.0 | 4.74 | 0.2 | 0 | 0.0 | 8.72×10 ⁻² | 0.0 | 5.15×10 ⁻² | 0.0 | 9.37×10 ⁻⁴ | 0.0 | 5.45×10 ¹ | 0.0 | 4.63×10 ¹ | 0.2 |
| Solid secondary waste ^e | 1.36 | 2.8 | 1.75×10 ⁵ | 0.4 | 0 | 0.0 | 0 | 0.0 | 3.33 | 0.4 | 2.79×10 ⁻¹ | 0.2 | 1.80×10 ⁻² | 0.2 | 7.67×10 ⁵ | 1.5 | 1.28×10 ² | 0.4 |
| 200-East Area BV glass ^f | 3.67 | 7.6 | 2.27×10 ⁵ | 0.5 | 0 | 0.0 | 0 | 0.0 | 2.13×10 ¹ | 2.3 | 3.25×10 ⁻³ | 0.0 | 5.68×10 ⁻¹ | 0.0 | 9.10×10 ² | 0.0 | 1.12×10 ⁴ | 37.8 |
| 200-West Area BV glass ^f | 3.08 | 6.4 | 4.39×10 ⁶ | 9.6 | 0 | 0.0 | 0 | 0.0 | 3.01×10 ¹ | 3.2 | 9.58×10 ⁻¹ | 0.7 | 1.04×10 ³ | 1.3 | 4.61×10 ⁵ | 0.9 | 9.42×10 ³ | 31.7 |
| Transuranic waste ^g | 5.02×10 ⁻² | 0.1 | 3.41×10 ⁵ | 0.7 | 3.85 | 0.1 | 3.33 | 0.0 | 4.67×10 ¹ | 5.0 | 9.79×10 ⁻¹ | 0.7 | 7.39×10 ³ | 9.1 | 7.52×10 ⁵ | 1.5 | 3.36×10 ² | 1.1 |
| Total^h | 4.83×10¹ | 100.3 | 4.62×10⁷ | 100.7 | 3.98×10¹ | 1.3 | 1.24×10² | 1.0 | 9.59×10² | 102.2 | 1.42×10² | 100.4 | 8.26×10⁴ | 101.4 | 5.12×10⁷ | 101.3 | 3.00×10⁴ | 101.1 |
| Other Inventory | | | | | | | | | | | | | | | | | | |
| Solid and liquid secondary waste from cesium and strontium capsules | 0 | N/A | 1.99×10 ⁵ | N/A | 0 | N/A | 0 | N/A | 0 | N/A | 0 | N/A | 0 | N/A | 3.16×10 ⁵ | N/A | 0 | N/A |
| Cesium and strontium capsules ⁱ | 0 | N/A | 4.59×10 ⁷ | N/A | 0 | N/A | 0 | N/A | 0 | N/A | 0 | N/A | 0 | N/A | 1.98×10 ⁷ | N/A | 0 | N/A |
| Rubble, soil, and equipment ^j | 1.67×10 ⁻² | N/A | 1.31×10 ⁴ | N/A | 1.47 | N/A | 6.03 | N/A | 4.82×10 ⁻¹ | N/A | 3.24×10 ⁻² | N/A | 4.32×10 ¹ | N/A | 3.05×10 ⁴ | N/A | 9.72 | N/A |
| Air Emissions | | | | | | | | | | | | | | | | | | |
| Treatment air emissions ^k | 4.78×10 ¹ | N/A | 7.98×10 ⁴ | N/A | 3.10×10 ³ | N/A | 1.20×10 ⁴ | N/A | 4.52×10 ⁻¹ | N/A | 6.96×10 ⁻² | N/A | 3.73×10 ¹ | N/A | 3.59×10 ⁴ | N/A | 1.47×10 ¹ | N/A |

^a Source of BBI is DOE-ORP-2003-02, Rev. 0, *Inventory and Source Term Data Package* (DOE 2003a).

^b Represents 99.0 percent retrieval. For analysis purposes, waste inventories from tank waste retrieval leaks and ancillary equipment were assumed to be treated in the Waste Treatment Plant and via supplemental treatment processes.

^c To be stored on site until disposition decisions are made and implemented. The inventory would include the retired HLW melters.

^d Includes secondary liquids that would be sent to the ETF and treated; solids would be disposed of in an Integrated Disposal Facility. Excludes liquid secondary waste from the processing of cesium and strontium capsules, which would be reported separately.

^e Includes solid low-level radioactive waste and mixed low-level radioactive waste streams generated by the waste treatment operations. Such waste streams would include debris waste, melter consumables, failed process components, analytical laboratory waste, spent resins, spent carbon adsorbent, high-efficiency particulate air filters, and other process-related waste.

^f Includes technetium-99 inventory that resides in the BV waste container insulating material or waste container.

^g Tank transuranic waste would be disposed of in the Waste Isolation Pilot Plant.

^h Totals may exceed 100 percent due to conservative estimates or rounded numbers. BBI percentages were rounded to the nearest tenth. Carbon-14 and hydrogen-3 (tritium) may not total 100 percent; a portion of each would be released to the offgas streams and stack, and a portion (ETF-generated liquid) would be disposed of in the State-Approved Land Disposal Site.

ⁱ To be treated in the Waste Treatment Plant, resulting in glass waste, which would be stored on site until disposition decisions are made and implemented.

^j Rubble, soil, and equipment would be generated by removal of 4.6 meters (15 feet) of soil and ancillary equipment at the BX and SX tank farms. This material would be disposed of in the River Protection Project Disposal Facility.

^k Includes air emissions from all waste treatment processes, including those from treatment of the cesium and strontium capsules. For analysis purposes both iodine-129 capture and air emission releases were assumed.

Key: %=percent; BBI=Best-Basis Inventory; BV=bulk vitrification; ETF=Effluent Treatment Facility; HLW=high-level radioactive waste; IHLW=immobilized high-level radioactive waste; ILAW=immobilized low-activity waste; LAW=low-activity waste; N/A=not applicable.

Source: SAIC 2007g, 2007h, 2008a.

Table D-40. Tank Closure Alternative 3A: Chemical Constituents of Potential Concern Balance

| | Chromium | | Mercury | | Nitrate | | Lead | | Total Uranium | | Acetonitrile | | Benzene | | Butanol | | PCBs | | 2,4,6-TCP | |
|--|----------------------------|--------------|----------------------------|-------------|----------------------------|-------------|----------------------------|--------------|----------------------------|--------------|----------------------------|------------|-----------------------------|------------|----------------------------|------------|----------------------------|------------|-----------------------------|------------|
| | Kg | % of BBI | Kg | % of BBI | Kg | % of BBI | Kg | % of BBI | Kg | % of BBI | Kg | % of BBI | Kg | % of BBI | Kg | % of BBI | Kg | % of BBI | Kg | % of BBI |
| Best-Basis Inventory | | | | | | | | | | | | | | | | | | | | |
| BBI ^a | 5.98×10 ⁵ | N/A | 1.83×10 ³ | N/A | 7.08×10 ⁷ | N/A | 8.41×10 ⁴ | N/A | 5.97×10 ⁵ | N/A | 2.95×10 ⁴ | N/A | 2.40 | N/A | 3.45×10 ⁶ | N/A | 1.68×10 ³ | N/A | 1.11 | N/A |
| Tank Closure Waste Inventory | | | | | | | | | | | | | | | | | | | | |
| Tank residual waste ^b | 5.98×10 ³ | 1.0 | 1.83×10 ¹ | 1.0 | 7.08×10 ⁵ | 1.0 | 8.41×10 ² | 1.0 | 5.97×10 ³ | 1.0 | 2.95×10 ² | 1.0 | 2.40×10 ⁻² | 1.0 | 3.45×10 ⁴ | 1.0 | 1.68×10 ¹ | 1.0 | 1.11×10 ⁻² | 1.0 |
| IHLW glass ^c | 1.12×10 ⁵ | 18.6 | 0 | 0.0 | 0 | 0.0 | 7.07×10 ⁴ | 84.1 | 5.11×10 ⁵ | 85.5 | 0 | 0.0 | 0 | 0.0 | 0 | 0.0 | 0 | 0.0 | 0 | 0.0 |
| ILAW glass and retired LAW melters | 1.34×10 ⁵ | 22.4 | 0 | 0.0 | 0 | 0.0 | 2.67×10 ³ | 3.2 | 1.13×10 ⁴ | 1.9 | 0 | 0.0 | 0 | 0.0 | 0 | 0.0 | 0 | 0.0 | 0 | 0.0 |
| ETF-generated solid secondary waste ^d | 2.76×10 ¹ | 0.0 | 5.54 | 0.3 | 8.14×10 ⁶ | 11.5 | 7.56×10 ² | 0.9 | 7.00×10 ¹ | 0.0 | NR | N/A | NR | N/A | NR | N/A | NR | N/A | NR | N/A |
| Solid secondary waste ^e | 8.03×10 ² | 0.1 | 1.75×10 ³ | 96.0 | 0 | 0.0 | 2.17×10 ² | 0.3 | 2.05×10 ³ | 0.3 | NR | N/A | NR | N/A | NR | N/A | NR | N/A | NR | N/A |
| 200-East Area BV glass | 1.74×10 ⁵ | 29.2 | 0 | 0 | 0 | 0.0 | 3.14×10 ³ | 3.7 | 1.47×10 ⁴ | 2.5 | 0 | 0.0 | 0 | 0.0 | 0 | 0.0 | 0 | 0.0 | 0 | 0.0 |
| 200-West Area BV glass | 1.48×10 ⁵ | 24.7 | 0 | 0 | 0 | 0.0 | 3.56×10 ³ | 4.2 | 1.98×10 ⁴ | 3.3 | 0 | 0.0 | 0 | 0.0 | 0 | 0.0 | 0 | 0.0 | 0 | 0.0 |
| Transuranic waste ^f | 2.83×10 ⁴ | 4.7 | 3.46×10 ¹ | 1.9 | 1.07×10 ⁶ | 1.5 | 6.43×10 ³ | 7.7 | 5.92×10 ⁴ | 9.9 | 5.93×10 ² | 2.0 | 4.83×10 ⁻² | 2.0 | 6.95×10 ⁴ | 2.0 | 3.51×10 ¹ | 2.1 | 2.23×10 ⁻² | 2.0 |
| Total^g | 6.03×10⁵ | 100.7 | 1.81×10³ | 99.2 | 9.92×10⁶ | 14.0 | 8.83×10⁴ | 105.0 | 6.24×10⁵ | 104.5 | 8.88×10² | 3.0 | 7.24×10⁻² | 3.0 | 1.04×10⁵ | 3.0 | 5.19×10¹ | 3.1 | 3.34×10⁻² | 3.0 |
| Other Inventory^h | | | | | | | | | | | | | | | | | | | | |
| Rubble, soil, and equipment ⁱ | 5.86×10 ² | N/A | 2.22 | N/A | 3.93×10 ⁴ | N/A | 3.34×10 ¹ | N/A | 6.60×10 ² | N/A | NR | N/A | NR | N/A | NR | N/A | NR | N/A | NR | N/A |
| Air Emissions | | | | | | | | | | | | | | | | | | | | |
| Treatment air emissions ^j | NR | N/A | 1.99×10 ³ | N/A | NR | N/A | NR | N/A | NR | N/A | NR | N/A | NR | N/A | NR | N/A | NR | N/A | NR | N/A |

^a Source of BBI is DOE-ORP-2003-02, Rev. 0, *Inventory and Source Term Data Package* (DOE 2003a).

^b Represents 99.0 percent retrieval. For analysis purposes, waste inventories from tank waste retrieval leaks and ancillary equipment were assumed to be treated in the Waste Treatment Plant and via supplemental treatment processes.

^c To be stored on site until disposition decisions are made and implemented. The inventory would include the retired HLW melters.

^d Includes secondary liquids that would be sent to the ETF and treated; solids would be disposed of in an Integrated Disposal Facility.

^e Includes solid low-level radioactive waste and mixed low-level radioactive waste streams that would be generated by the waste treatment operations. Such waste streams would include debris waste, melter consumables, failed process components, analytical laboratory waste, spent resins, spent carbon adsorbent, high-efficiency particulate air filters, and other process-related waste. Excludes contaminated liquid effluent waste streams that would be treated at the ETF.

^f Tank transuranic waste would be disposed of in the Waste Isolation Pilot Plant.

^g Totals may exceed 100 percent due to conservative estimates or rounded numbers. BBI percentages were rounded to the nearest tenth. The organic chemicals (acetonitrile, benzene, butanol, polychlorinated biphenyls, and 2,4,6-trichlorophenol) may not total 100 percent because they would be destroyed during the thermal treatment processes. Nitrate may not total 100 percent because it would be volatilized and released through the facility stack.

^h No chemical constituents of potential concern have been reported in the cesium and strontium capsule secondary waste streams.

ⁱ Rubble, soil, and equipment would be generated by the removal of 4.6 meters (15 feet) of soil and ancillary equipment at the BX and SX tank farms. Disposal would take place in the River Protection Project Disposal Facility.

^j Includes air emissions from all waste treatment processes, including those from treatment of the cesium and strontium capsules. For analysis purposes, both mercury capture and air emission releases were assumed.

Key: %-percent; 2, 4, 6-TCP=2,4,6-trichlorophenol; BBI=Best-Basis Inventory; butanol=n-butyl alcohol; BV=bulk vitrification; ETF=Effluent Treatment Facility; HLW=high-level radioactive waste; IHLW=immobilized high-level radioactive waste; ILAW=immobilized low-activity waste; kg=kilograms; LAW=low-activity waste; N/A=not applicable; NR=not reported; PCBs=polychlorinated biphenyls.

Source: SAIC 2007g, 2007i, 2008a.

Table D-41. Tank Closure Alternative 3B: Radiological Constituents of Potential Concern Balance

| | Iodine-129 | | Cesium-137 | | Carbon-14 | | Hydrogen-3 (Tritium) | | Uranium-233, -234, -235, -238 | | Neptunium-237 | | Plutonium -239, -240 | | Strontium-90 | | Technetium-99 | |
|---|----------------------------|--------------|----------------------------|--------------|----------------------------|-------------|----------------------------|-------------|-------------------------------|--------------|----------------------------|--------------|----------------------------|--------------|----------------------------|--------------|----------------------------|--------------|
| | Curies | % of BBI | Curies | % of BBI | Curies | % of BBI | Curies | % of BBI | Curies | % of BBI | Curies | % of BBI | Curies | % of BBI | Curies | % of BBI | Curies | % of BBI |
| Best-Basis Inventory | | | | | | | | | | | | | | | | | | |
| BBI ^a | 4.82×10 ¹ | N/A | 4.58×10 ⁷ | N/A | 3.12×10 ³ | N/A | 1.21×10 ⁴ | N/A | 9.38×10 ² | N/A | 1.41×10 ² | N/A | 8.14×10 ⁴ | N/A | 5.05×10 ⁷ | N/A | 2.97×10 ⁴ | N/A |
| Tank Closure Waste Inventory | | | | | | | | | | | | | | | | | | |
| Tank residual waste ^b | 4.82×10 ¹ | 1.0 | 4.58×10 ⁵ | 1.0 | 3.12×10 ¹ | 1.0 | 1.21×10 ² | 1.0 | 9.38 | 1.0 | 1.41 | 1.0 | 8.14×10 ² | 1.0 | 5.05×10 ⁵ | 1.0 | 2.97×10 ² | 1.0 |
| IHLW glass ^c | 1.32×10 ⁻⁵ | 0.0 | 4.04×10 ⁷ | 88.1 | 0 | 0.0 | 0 | 0.0 | 8.32×10 ² | 88.6 | 1.38×10 ² | 97.8 | 7.31×10 ⁴ | 89.8 | 4.87×10 ⁷ | 96.4 | 1.96×10 ⁴ | 66.0 |
| ILAW glass and retired LAW melters | 2.80 | 5.8 | 1.73×10 ⁵ | 0.4 | 0 | 0.0 | 0 | 0.0 | 1.63×10 ¹ | 1.7 | 2.48×10 ⁻³ | 0.0 | 4.33×10 ⁻¹ | 0.0 | 6.91×10 ² | 0.0 | 8.44×10 ¹ | 0.3 |
| ETF-generated solid secondary waste ^d | 9.85 | 20.5 | 4.11×10 ⁻¹ | 0.0 | 2.62 | 0.1 | 0 | 0.0 | 3.65×10 ⁻² | 0.0 | 5.05×10 ⁻² | 0.0 | 6.33×10 ⁻⁴ | 0.0 | 6.34 | 0.0 | 5.82×10 ¹ | 0.2 |
| Solid secondary waste ^e | 1.36 | 2.8 | 1.75×10 ⁵ | 0.4 | 0 | 0.0 | 0 | 0.0 | 3.33 | 0.4 | 2.79×10 ⁻¹ | 0.2 | 1.80×10 ⁻² | 0.2 | 7.67×10 ⁵ | 1.5 | 2.90×10 ² | 1.0 |
| 200-East cast stone | 1.84×10 ¹ | 38.1 | 2.28×10 ⁵ | 0.5 | 1.17×10 ³ | 37.3 | 4.59×10 ³ | 38.1 | 2.13×10 ¹ | 2.3 | 3.25×10 ⁻³ | 0.0 | 5.68×10 ⁻¹ | 0.0 | 9.10×10 ² | 0.0 | 1.12×10 ² | 0.4 |
| 200-West cast stone | 1.54×10 ¹ | 32.0 | 4.41×10 ⁶ | 9.6 | 9.79×10 ² | 31.4 | 3.85×10 ³ | 32.0 | 3.01×10 ¹ | 3.2 | 9.59×10 ⁻¹ | 0.7 | 1.04×10 ³ | 1.3 | 4.61×10 ⁵ | 0.9 | 9.43×10 ³ | 31.7 |
| Transuranic waste ^f | 5.02×10 ⁻² | 0.1 | 3.41×10 ⁵ | 0.7 | 3.85 | 0.1 | 3.33 | 0.0 | 4.67×10 ¹ | 5.0 | 9.79×10 ⁻¹ | 0.7 | 7.39×10 ³ | 9.1 | 7.52×10 ⁵ | 1.5 | 3.36×10 ² | 1.1 |
| Totals^g | 4.83×10¹ | 100.3 | 4.62×10⁷ | 100.7 | 2.18×10³ | 69.9 | 8.57×10³ | 71.1 | 9.59×10² | 102.2 | 1.42×10² | 100.4 | 8.26×10⁴ | 101.4 | 5.12×10⁷ | 101.3 | 3.02×10⁴ | 101.7 |
| Other Inventory | | | | | | | | | | | | | | | | | | |
| Solid and liquid secondary waste from cesium and strontium capsules | 0 | N/A | 1.99×10 ⁵ | N/A | 0 | N/A | 0 | N/A | 0 | N/A | 0 | N/A | 0 | N/A | 3.16×10 ⁵ | N/A | 0 | N/A |
| Cesium and strontium capsules ^h | 0 | N/A | 4.59×10 ⁷ | N/A | 0 | N/A | 0 | N/A | 0 | N/A | 0 | N/A | 0 | N/A | 1.98×10 ⁷ | N/A | 0 | N/A |
| Rubble, soil, and equipment ⁱ | 1.67×10 ⁻² | N/A | 1.31×10 ⁴ | N/A | 1.47 | N/A | 6.03 | N/A | 4.82×10 ⁻¹ | N/A | 3.24×10 ⁻² | N/A | 4.32×10 ¹ | N/A | 3.05×10 ⁴ | N/A | 9.72 | N/A |
| Air Emissions | | | | | | | | | | | | | | | | | | |
| Treatment air emissions ^j | 1.40×10 ¹ | N/A | 7.76×10 ⁴ | N/A | 9.53×10 ² | N/A | 3.50×10 ³ | N/A | 4.27×10 ⁻¹ | N/A | 6.91×10 ⁻² | N/A | 3.67×10 ¹ | N/A | 3.56×10 ⁴ | N/A | 1.00×10 ¹ | N/A |

^a Source of BBI is DOE-ORP-2003-02, Rev. 0, *Inventory and Source Term Data Package* (DOE 2003a).

^b Represents 99.0 percent retrieval. For analysis purposes, waste inventories from tank waste retrieval leaks and ancillary equipment were assumed to be treated in the Waste Treatment Plant and via supplemental treatment processes.

^c To be stored on site until disposition decisions are made and implemented. The inventory would include the retired HLW melters.

^d Includes secondary liquids that would be sent to the ETF and treated; solids would be disposed of in an Integrated Disposal Facility. Excludes liquid secondary waste from the processing of cesium and strontium capsules, which would be reported separately.

^e Includes solid low-level radioactive waste and mixed low-level radioactive waste streams that would be generated by the waste treatment operations. Such waste streams would include debris waste, melter consumables, failed process components, analytical laboratory waste, spent resins, spent carbon adsorbent, high-efficiency particulate air filters, and other process-related waste. Excludes contaminated liquid effluent waste streams that would be treated at the ETF, as reported for ETF-generated solid secondary waste in the table above. The value for technetium-99 includes 4.31×10¹ curies of technetium-99 that would remain in the spent resin after the technetium-99 removal process.

^f Tank transuranic waste would be disposed of in the Waste Isolation Pilot Plant.

^g Totals may exceed 100 percent due to conservative estimates or rounded numbers. BBI percentages were rounded to the nearest tenth. Carbon-14 and hydrogen-3 (tritium) may not total 100 percent; a portion of each would be released to the offgas streams and stack, and a portion (ETF-generated liquid) would be disposed of in the State-Approved Land Disposal Site.

^h To be treated in the Waste Treatment Plant, resulting in glass waste, which would be stored on site until disposition decisions are made and implemented.

ⁱ Rubble, soil, and equipment would be generated by the removal of 4.6 meters (15 feet) of soil and ancillary equipment at the BX and SX tank farms. Disposal would take place in the River Protection Project Disposal Facility.

^j Includes air emissions from all waste treatment processes, including those from treatment of the cesium and strontium capsules. For analysis purposes, both iodine-129 capture and air emission releases were assumed.

Key: %=percent; BBI=Best-Basis inventory; ETF=Effluent Treatment Facility; HLW=high-level radioactive waste; IHLW=immobilized high-level radioactive waste; ILAW=immobilized low-activity waste; LAW=low-activity waste; N/A=not applicable.

Source: SAIC 2007g, 2007h, 2008a.

Table D-42. Tank Closure Alternative 3B: Chemical Constituents of Potential Concern Balance

| | Chromium | | Mercury | | Nitrate | | Lead | | Total Uranium | | Acetonitrile | | Benzene | | Butanol | | PCBs | | 2,4,6-TCP | |
|--|----------------------------|--------------|----------------------------|-------------|----------------------------|-------------|----------------------------|--------------|----------------------------|--------------|----------------------------|-------------|-----------------------|-------------|----------------------------|-------------|----------------------------|-------------|-----------------------------|-------------|
| | Kg | % of BBI | Kg | % of BBI | Kg | % of BBI | Kg | % of BBI | Kg | % of BBI | Kg | % of BBI | Kg | % of BBI | Kg | % of BBI | Kg | % of BBI | Kg | % of BBI |
| Best-Basis Inventory | | | | | | | | | | | | | | | | | | | | |
| BBI ^a | 5.98×10 ⁵ | N/A | 1.83×10 ³ | N/A | 7.08×10 ⁷ | N/A | 8.41×10 ⁴ | N/A | 5.97×10 ⁵ | N/A | 2.95×10 ⁴ | N/A | 2.40 | N/A | 3.45×10 ⁶ | N/A | 1.68×10 ³ | N/A | 1.11 | N/A |
| Tank Closure Waste Inventory | | | | | | | | | | | | | | | | | | | | |
| Tank residual waste ^b | 5.98×10 ³ | 1.0 | 1.83×10 ¹ | 1.0 | 7.08×10 ⁵ | 1.0 | 8.41×10 ² | 1.0 | 5.97×10 ³ | 1.0 | 2.95×10 ² | 1.0 | 2.40×10 ⁻² | 1.0 | 3.45×10 ⁴ | 1.0 | 1.68×10 ¹ | 1.0 | 1.11×10 ⁻² | 1.0 |
| IHLW glass ^c | 1.12×10 ⁵ | 18.6 | 0 | 0.0 | 0 | 0.0 | 7.07×10 ⁴ | 84.1 | 5.11×10 ⁵ | 85.5 | 0 | 0.0 | 0 | 0.0 | 0 | 0.0 | 0 | 0.0 | 0 | 0.0 |
| ILAW glass and retired LAW melters | 1.34×10 ⁵ | 22.4 | 0 | 0.0 | 0 | 0.0 | 2.67×10 ³ | 3.2 | 1.13×10 ⁴ | 1.9 | 0 | 0.0 | 0 | 0.0 | 0 | 0.0 | 0 | 0.0 | 0 | 0.0 |
| ETF-generated solid secondary waste ^d | 1.84×10 ¹ | 0.0 | 4.12 | 0.2 | 2.63×10 ⁶ | 3.7 | 5.82 | 0.0 | 3.57×10 ¹ | 0.0 | NR | N/A | NR | N/A | NR | N/A | NR | N/A | NR | N/A |
| Solid secondary waste ^e | 8.03×10 ² | 0.1 | 1.31×10 ³ | 71.5 | 0 | 0.0 | 2.17×10 ² | 0.3 | 2.05×10 ³ | 0.3 | NR | N/A | NR | N/A | NR | N/A | NR | N/A | NR | N/A |
| 200-East Area cast stone | 1.76×10 ⁵ | 29.4 | 2.41×10 ² | 13.2 | 2.08×10 ⁷ | 29.3 | 3.51×10 ³ | 4.2 | 1.48×10 ⁴ | 2.5 | 1.11×10 ⁴ | 37.6 | 9.03×10 ⁻¹ | 37.6 | 1.30×10 ⁶ | 37.6 | 6.33 | 0.4 | 4.16×10 ⁻¹ | 37.6 |
| 200-West Area cast stone | 1.49×10 ⁵ | 24.9 | 2.19×10 ² | 12.0 | 1.74×10 ⁷ | 24.6 | 3.98×10 ³ | 4.7 | 1.99×10 ⁴ | 3.3 | 9.15×10 ³ | 31.0 | 7.45×10 ⁻¹ | 31.0 | 1.07×10 ⁶ | 31.0 | 5.22×10 ² | 31.0 | 3.44×10 ⁻¹ | 31.0 |
| TRU waste ^f | 2.83×10 ⁴ | 4.7 | 3.46×10 ¹ | 1.9 | 1.07×10 ⁶ | 1.5 | 6.43×10 ³ | 7.7 | 5.92×10 ⁴ | 9.9 | 5.93×10 ² | 2.0 | 4.83×10 ⁻² | 2.0 | 6.95×10 ⁴ | 2.0 | 3.51×10 ¹ | 2.1 | 2.23×10 ⁻² | 2.0 |
| Total^g | 6.05×10⁵ | 101.1 | 1.82×10³ | 99.8 | 4.26×10⁷ | 60.1 | 8.84×10⁴ | 105.1 | 6.24×10⁵ | 104.5 | 2.11×10⁴ | 71.6 | 1.72 | 71.6 | 2.47×10⁶ | 71.6 | 5.81×10² | 34.5 | 7.93×10⁻¹ | 71.6 |
| Other Inventory^h | | | | | | | | | | | | | | | | | | | | |
| Rubble, soil, and equipment ⁱ | 5.86×10 ² | N/A | 2.22 | N/A | 3.93×10 ⁴ | N/A | 3.34×10 ¹ | N/A | 6.60×10 ² | N/A | NR | N/A | NR | N/A | NR | N/A | NR | N/A | NR | N/A |
| Air Emissions | | | | | | | | | | | | | | | | | | | | |
| Treatment air emissions ^j | NR | N/A | 1.48×10 ³ | N/A | NR | N/A | NR | N/A | NR | N/A | NR | N/A | NR | N/A | NR | N/A | NR | N/A | NR | N/A |

^a Source of BBI is DOE-ORP-2003-02, Rev. 0, *Inventory and Source Term Data Package* (DOE 2003a).

^b Represents 99.0 percent retrieval. For analysis purposes, waste inventories from tank waste retrieval leaks and ancillary equipment were assumed to be treated in the Waste Treatment Plant and via supplemental treatment processes.

^c To be stored on site until disposition decisions are made and implemented. The inventory would include the retired HLW melters.

^d Includes secondary liquids that would be sent to the ETF and treated; solids would be disposed of in an Integrated Disposal Facility.

^e Includes solid low-level radioactive waste and mixed low-level radioactive waste streams that would be generated by the waste treatment operations. Such waste streams would include debris waste, melter consumables, failed process components, analytical laboratory waste, spent resins, spent carbon adsorbent, high-efficiency particulate air filters, and other process-related waste. Excludes contaminated liquid effluent waste streams, which would be treated at the ETF.

^f Tank TRU waste would be disposed of in the Waste Isolation Pilot Plant.

^g Totals may exceed 100 percent due to conservative estimates or rounded numbers. BBI percentages were rounded to the nearest tenth. The organic chemicals (acetonitrile, benzene, butanol, polychlorinated biphenyls, and 2,4,6-trichlorophenol) may not total 100 percent because they would be destroyed during the thermal treatment processes. Nitrate may not total 100 percent because it would be volatilized and released through the facility stack.

^h No chemical constituents of potential concern have been reported in the cesium and strontium capsule secondary waste streams.

ⁱ Rubble, soil, and equipment would be generated by the removal of 4.6 meters (15 feet) of soil and ancillary equipment at the BX and SX tank farms. Disposal would take place in the River Protection Project Disposal Facility.

^j Includes air emissions from all waste treatment processes, including those from treatment of the cesium and strontium capsules. For analysis purposes, both mercury capture and air emission releases were assumed.

Key: %=percent; 2,4,6-TCP=2,4,6-trichlorophenol; BBI=Best-Basis Inventory; butanol=n-butyl alcohol; ETF=Effluent Treatment Facility; HLW= high-level radioactive waste; IHLW=immobilized high-level radioactive waste; ILAW=immobilized low-activity waste; kg=kilograms; LAW=low-activity waste; N/A=not applicable; NR=not reported; PCBs=polychlorinated biphenyls; TRU=transuranic.

Source: SAIC 2007g, 2007i, 2008a.

Table D-43. Tank Closure Alternative 3C: Radiological Constituents of Potential Concern Balance

| | Iodine-129 | | Cesium-137 | | Carbon-14 | | Hydrogen-3 (Tritium) | | Uranium-233, -234, -235, -238 | | Neptunium-237 | | Plutonium -239, -240 | | Strontium-90 | | Technetium-99 | |
|---|----------------------------|--------------|----------------------------|--------------|----------------------------|------------|----------------------------|------------|-------------------------------|--------------|----------------------------|--------------|----------------------------|--------------|----------------------------|--------------|----------------------------|--------------|
| | Curies | % of BBI | Curies | % of BBI | Curies | % of BBI | Curies | % of BBI | Curies | % of BBI | Curies | % of BBI | Curies | % of BBI | Curies | % of BBI | Curies | % of BBI |
| Best-Basis Inventory | | | | | | | | | | | | | | | | | | |
| BBI ^a | 4.82×10 ¹ | N/A | 4.58×10 ⁷ | N/A | 3.12×10 ³ | N/A | 1.21×10 ⁴ | N/A | 9.38×10 ² | N/A | 1.41×10 ² | N/A | 8.14×10 ⁴ | N/A | 5.05×10 ⁷ | N/A | 2.97×10 ⁴ | N/A |
| Tank Closure Waste Inventory | | | | | | | | | | | | | | | | | | |
| Tank residual waste ^b | 4.82×10 ⁻¹ | 1.0 | 4.58×10 ⁵ | 1.0 | 3.12×10 ¹ | 1.0 | 1.21×10 ² | 1.0 | 9.38 | 1.0 | 1.41 | 1.0 | 8.14×10 ² | 1.0 | 5.05×10 ⁵ | 1.0 | 2.97×10 ² | 1.0 |
| IHLW glass ^c | 1.32×10 ⁻⁵ | 0.0 | 4.04×10 ⁷ | 88.1 | 0 | 0.0 | 0 | 0.0 | 8.32×10 ² | 88.6 | 1.38×10 ² | 97.8 | 7.31×10 ⁴ | 89.8 | 4.87×10 ⁷ | 96.4 | 1.49×10 ² | 0.5 |
| ILAW glass and retired LAW melters | 2.80 | 5.8 | 1.73×10 ⁵ | 0.4 | 0 | 0.0 | 0 | 0.0 | 1.63×10 ¹ | 1.7 | 2.48×10 ⁻³ | 0.0 | 4.33×10 ⁻¹ | 0.0 | 6.91×10 ² | 0.0 | 8.44×10 ³ | 28.4 |
| ETF-generated solid secondary waste ^d | 3.69×10 ¹ | 76.5 | 1.44×10 ¹ | 0.0 | 4.74 | 0.2 | 0 | 0.0 | 7.92×10 ⁻² | 0.0 | 5.13×10 ⁻² | 0.0 | 8.41×10 ⁻⁴ | 0.0 | 5.35×10 ¹ | 0.0 | 4.63×10 ¹ | 0.2 |
| Solid secondary waste ^e | 1.36 | 2.8 | 1.75×10 ⁵ | 0.4 | 0 | 0.0 | 0 | 0.0 | 3.33 | 0.4 | 2.79×10 ⁻¹ | 0.2 | 1.80×10 ² | 0.2 | 7.67×10 ⁵ | 1.5 | 1.28×10 ² | 0.4 |
| 200-East Area steam reforming waste | 3.67 | 7.6 | 2.27×10 ⁵ | 0.5 | 0 | 0.0 | 0 | 0.0 | 2.13×10 ¹ | 2.3 | 3.25×10 ⁻³ | 0.0 | 5.68×10 ⁻¹ | 0.0 | 9.10×10 ² | 0.0 | 1.12×10 ⁴ | 37.8 |
| 200-West Area steam reforming waste | 3.08 | 6.4 | 4.39×10 ⁶ | 9.6 | 0 | 0.0 | 0 | 0.0 | 3.01×10 ¹ | 3.2 | 9.58×10 ⁻¹ | 0.7 | 1.04×10 ³ | 1.3 | 4.61×10 ⁵ | 0.9 | 9.42×10 ³ | 31.7 |
| Transuranic waste ^f | 5.02×10 ⁻² | 0.1 | 3.41×10 ⁵ | 0.7 | 3.85 | 0.1 | 3.33 | 0.0 | 4.67×10 ¹ | 5.0 | 9.79×10 ⁻¹ | 0.7 | 7.39×10 ³ | 9.1 | 7.52×10 ⁵ | 1.5 | 3.36×10 ² | 1.1 |
| Total^g | 4.83×10¹ | 100.3 | 4.62×10⁷ | 100.7 | 3.98×10¹ | 1.3 | 1.24×10² | 1.0 | 9.59×10² | 102.2 | 1.42×10² | 100.4 | 8.26×10⁴ | 101.4 | 5.12×10⁷ | 101.3 | 3.00×10⁴ | 101.1 |
| Other Inventory | | | | | | | | | | | | | | | | | | |
| Solid and liquid secondary waste from cesium and strontium capsules | 0 | N/A | 1.99×10 ⁵ | N/A | 0 | N/A | 0 | N/A | 0 | N/A | 0 | N/A | 0 | N/A | 3.16×10 ⁵ | N/A | 0 | N/A |
| Cesium and strontium capsules ^h | 0 | N/A | 4.59×10 ⁷ | N/A | 0 | N/A | 0 | N/A | 0 | N/A | 0 | N/A | 0 | N/A | 1.98×10 ⁷ | N/A | 0 | N/A |
| Rubble, soil, and equipment ⁱ | 1.67×10 ⁻² | N/A | 1.31×10 ⁴ | N/A | 1.47 | N/A | 6.03 | N/A | 4.82×10 ⁻¹ | N/A | 3.24×10 ⁻² | N/A | 4.32×10 ¹ | N/A | 3.05×10 ⁴ | N/A | 9.72 | N/A |
| Air Emissions | | | | | | | | | | | | | | | | | | |
| Treatment air emissions ^j | 4.78×10 ¹ | N/A | 7.98×10 ⁴ | N/A | 3.10×10 ³ | N/A | 1.20×10 ⁴ | N/A | 4.52×10 ⁻¹ | N/A | 6.96×10 ⁻² | N/A | 3.73×10 ¹ | N/A | 3.59×10 ⁴ | N/A | 1.47×10 ¹ | N/A |

^a Source of BBI is DOE-ORP-2003-02, Rev. 0, *Inventory and Source Term Data Package* (DOE 2003a).

^b Represents 99.0 percent retrieval. For analysis purposes, waste inventories from tank waste retrieval leaks and ancillary equipment were assumed to be treated in the Waste Treatment Plant and via supplemental treatment processes.

^c To be stored on site until disposition decisions are made and implemented. The inventory would include the retired HLW melters.

^d Includes secondary liquids that would be sent to the ETF and treated; solids would be disposed of in an Integrated Disposal Facility. Excludes liquid secondary waste from the processing of cesium and strontium capsules, which would be reported separately.

^e Includes solid low-level radioactive waste and mixed low-level radioactive waste streams that would be generated by the waste treatment operations. Such waste streams would include debris waste, melter consumables, failed process components, analytical laboratory waste, spent resins, spent carbon adsorbent, high-efficiency particulate air filters, and other process-related waste. Excludes contaminated liquid effluent waste streams, which would be treated at the ETF.

^f Tank transuranic waste would be disposed of in the Waste Isolation Pilot Plant.

^g Totals may exceed 100 percent due to conservative estimates or rounded numbers. BBI percentages were rounded to the nearest tenth. Carbon-14 and hydrogen-3 (tritium) may not total 100 percent; a portion of each would be released to the offgas streams and stack, and a portion (ETF-generated liquid) would be disposed of in the State-Approved Land Disposal Site.

^h To be treated in the Waste Treatment Plant, resulting in glass waste, which would be stored on site until disposition decisions are made and implemented.

ⁱ Rubble, soil, and equipment would be generated by the removal of 4.6 meters (15 feet) of soil and ancillary equipment at the BX and SX tank farms. Disposal would take place in the River Protection Project Disposal Facility.

^j Includes air emissions from all waste treatment processes, including those from treatment of the cesium and strontium capsules. For analyses purposes both iodine-129 capture and air emission releases were assumed.

Key: %=percent; BBI=Best-Basis Inventory; ETF=Effluent Treatment Facility; HLW=high-level radioactive waste; IHLW=immobilized high-level radioactive waste; ILAW=immobilized low-activity waste; LAW=low-activity waste; N/A=not applicable.

Source: SAIC 2007g, 2007h, 2008a.

Table D-44. Tank Closure Alternative 3C: Chemical Constituents of Potential Concern Balance

| | Chromium | | Mercury | | Nitrate | | Lead | | Total Uranium | | Acetonitrile | | Benzene | | Butanol | | PCBs | | 2,4,6-TCP | |
|--|----------------------------|--------------|----------------------------|-------------|----------------------------|-------------|----------------------------|--------------|----------------------------|--------------|----------------------------|------------|-----------------------------|------------|----------------------------|------------|----------------------------|------------|-----------------------------|------------|
| | Kg | % of BBI | Kg | % of BBI | Kg | % of BBI | Kg | % of BBI | Kg | % of BBI | Kg | % of BBI | Kg | % of BBI | Kg | % of BBI | Kg | % of BBI | Kg | % of BBI |
| Best-Basis Inventory | | | | | | | | | | | | | | | | | | | | |
| BBI ^a | 5.98×10 ⁵ | N/A | 1.83×10 ³ | N/A | 7.08×10 ⁷ | N/A | 8.41×10 ⁴ | N/A | 5.97×10 ⁵ | N/A | 2.95×10 ⁴ | N/A | 2.40 | N/A | 3.45×10 ⁶ | N/A | 1.68×10 ³ | N/A | 1.11 | N/A |
| Tank Closure Waste Inventory | | | | | | | | | | | | | | | | | | | | |
| Tank residual waste ^b | 5.98×10 ³ | 1.0 | 1.83×10 ¹ | 1.0 | 7.08×10 ⁵ | 1.0 | 8.41×10 ² | 1.0 | 5.97×10 ³ | 1.0 | 2.95×10 ² | 1.0 | 2.40×10 ⁻² | 1.0 | 3.45×10 ⁴ | 1.0 | 1.68×10 ¹ | 1.0 | 1.11×10 ⁻² | 1.0 |
| IHLW glass ^c | 1.12×10 ⁵ | 18.6 | 0 | 0.0 | 0 | 0.0 | 7.07×10 ⁴ | 84.1 | 5.11×10 ⁵ | 85.5 | 0 | 0.0 | 0 | 0.0 | 0 | 0.0 | 0 | 0.0 | 0 | 0.0 |
| ILAW glass and retired LAW melters | 1.34×10 ⁵ | 22.4 | 0 | 0.0 | 0 | 0.0 | 2.67×10 ³ | 3.2 | 1.13×10 ⁴ | 1.9 | 0 | 0.0 | 0 | 0.0 | 0 | 0.0 | 0 | 0.0 | 0 | 0.0 |
| ETF-generated solid secondary waste ^d | 2.72×10 ¹ | 0.0 | 5.54 | 0.3 | 9.18×10 ⁶ | 13.0 | 7.56×10 ² | 0.9 | 6.39×10 ¹ | 0.0 | NR | N/A | NR | N/A | NR | N/A | NR | N/A | NR | N/A |
| Solid secondary waste ^e | 8.03×10 ² | 0.1 | 1.75×10 ³ | 96.0 | 0 | 0.0 | 2.17×10 ² | 0.3 | 2.05×10 ³ | 0.3 | NR | N/A | NR | N/A | NR | N/A | NR | N/A | NR | N/A |
| 200-East Area steam reforming waste | 1.76×10 ⁵ | 29.3 | 0 | 0 | 0 | 0.0 | 3.16×10 ³ | 3.8 | 1.48×10 ⁴ | 2.5 | 0 | 0.0 | 0 | 0.0 | 0 | 0.0 | 0 | 0.0 | 0 | 0.0 |
| 200-West Area steam reforming waste | 1.49×10 ⁵ | 24.9 | 0 | 0 | 0 | 0.0 | 3.58×10 ³ | 4.3 | 1.99×10 ⁴ | 3.3 | 0 | 0.0 | 0 | 0.0 | 0 | 0.0 | 0 | 0.0 | 0 | 0.0 |
| TRU waste ^f | 2.83×10 ⁴ | 4.7 | 3.46×10 ¹ | 1.9 | 1.07×10 ⁶ | 1.5 | 6.43×10 ³ | 7.7 | 5.92×10 ⁴ | 9.9 | 5.93×10 ² | 2.0 | 4.83×10 ⁻² | 2.0 | 6.95×10 ⁴ | 2.0 | 3.51×10 ¹ | 2.1 | 2.23×10 ⁻² | 2.0 |
| Total^g | 6.05×10⁵ | 101.1 | 1.81×10³ | 99.2 | 1.10×10⁷ | 15.5 | 8.84×10⁴ | 105.1 | 6.24×10⁵ | 104.5 | 8.88×10² | 3.0 | 7.24×10⁻² | 3.0 | 1.04×10⁵ | 3.0 | 5.19×10¹ | 3.1 | 3.34×10⁻² | 3.0 |
| Other Inventory^h | | | | | | | | | | | | | | | | | | | | |
| Rubble, soil, and equipment ⁱ | 5.86×10 ² | N/A | 2.22 | N/A | 3.93×10 ⁴ | N/A | 3.34×10 ¹ | N/A | 6.60×10 ² | N/A | NR | N/A | NR | N/A | NR | N/A | NR | N/A | NR | N/A |
| Air Emissions | | | | | | | | | | | | | | | | | | | | |
| Treatment air emissions ^j | NR | N/A | 1.99×10 ³ | N/A | NR | N/A | NR | N/A | NR | N/A | NR | N/A | NR | N/A | NR | N/A | NR | N/A | NR | N/A |

^a Source of BBI is DOE-ORP-2003-02, Rev. 0, *Inventory and Source Term Data Package* (DOE 2003a).

^b Represents 99.0 percent retrieval. For analysis purposes, waste inventories from tank waste retrieval leaks and ancillary equipment were assumed to be treated in the Waste Treatment Plant and via supplemental treatment processes.

^c To be stored on site until disposition decisions are made and implemented. The inventory would include the retired HLW melters.

^d Includes secondary liquids that would be sent to the ETF and treated; solids would be disposed of in an Integrated Disposal Facility.

^e Includes solid low-level radioactive waste and mixed low-level radioactive waste streams that would be generated by the waste treatment operations. Such waste streams would include debris waste, melter consumables, failed process components, analytical laboratory waste, spent resins, spent carbon adsorbent, high-efficiency particulate air filters, and other process-related waste. Excludes contaminated liquid effluent waste streams, which would be treated at the ETF.

^f Tank TRU waste would be disposed of in the Waste Isolation Pilot Plant.

^g Totals may exceed 100 percent due to conservative estimates or rounded numbers. BBI percentages were rounded to the nearest tenth. The organic chemicals (acetonitrile, benzene, butanol, polychlorinated biphenyls, and 2,4,6-trichlorophenol) may not total 100 percent because they would be destroyed during the thermal treatment processes. Nitrate may not total 100 percent because it would be volatilized and released through the facility stack.

^h No chemical constituents of potential concern have been reported in the cesium and strontium capsule secondary waste streams.

ⁱ Rubble, soil, and equipment would be generated by removal of 4.6 meters (15 feet) of soil and ancillary equipment at the BX and SX tank farms. Disposal would take place in the River Protection Project Disposal Facility.

^j Includes only inventories from facility air emissions, including those from treatment of cesium and strontium capsules. For analysis purposes, both mercury capture and air emission releases were assumed.

Key: %=percent; 2,4,6-TCP=2,4,6-trichlorophenol; BBI=Best-Basis Inventory; butanol=n-butyl alcohol; ETF=Effluent Treatment Facility; HLW=high-level radioactive waste; IHLW=immobilized high-level radioactive waste; ILAW=immobilized low-activity waste; kg=kilograms; LAW=low-activity waste; N/A=not applicable; NR=not reported; PCBs=polychlorinated biphenyls; TRU=transuranic.

Source: SAIC 2007g, 2007i, 2008a.

Under Tank Closure Alternative 4, the primary waste forms produced would be IHLW glass, ILAW glass, and a combination of the supplemental waste forms, bulk vitrification glass, and cast stone waste. The majority of technetium-99 would be immobilized in the ILAW glass and supplemental waste forms. Under Tank Closure Alternative 4, the ILAW glass, bulk vitrification glass, cast stone waste, and secondary waste would contain 5.8 percent, 6.5 percent, 38.7 percent, and 49.1 percent of the BBI estimate for iodine-129, respectively. A process flowsheet is presented in Figure D-7, and material balances under Alternative 4 are presented in Tables D-45 and D-46.

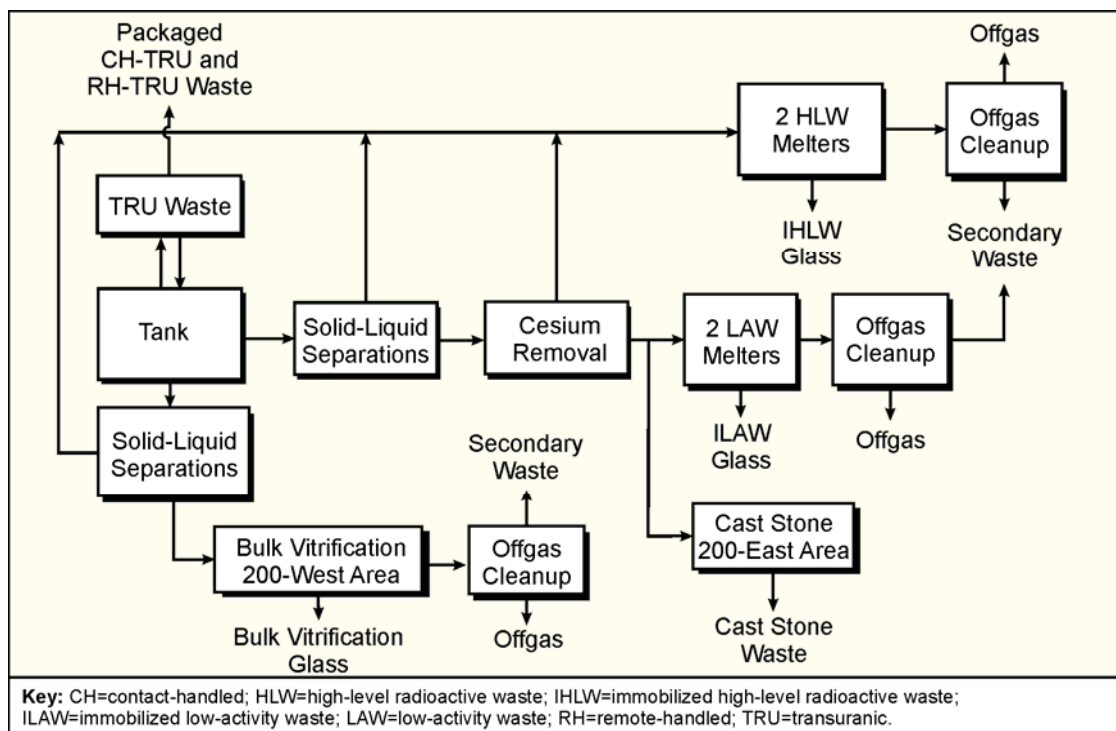

Figure D-7. Tank Closure Alternative 4 Flowsheet

In addition, under Tank Closure Alternative 4 (see Figure D-8 for a simplified flowsheet and Tables D-47 and D-48 for inventories), selected tank farms, represented by the BX and SX tank farms, would undergo clean closure. Under clean closure, the SST, soils contaminated with leaks from retrieval activities, and soils contaminated by past tank leaks in these two tank farms would be removed. The more highly contaminated portions of the removed materials would be sent to a proposed Preprocessing Facility (PPF) for decontamination.

Under this alternative, it was assumed that 95 percent of the radioactive and chemical constituent inventory remaining in the tanks and ancillary equipment and from leaks associated with waste retrieval would be sent to the PPF, while 5 percent of the inventory would be packaged and sent directly to the River Protection Project Disposal Facility (RPPDF) as mixed low-level radioactive waste (MLLW). It was further assumed that the PPF processes would be effective at removing 85 percent of the contaminants from the rubble, soil, and equipment contaminated with tank waste retrieval leaks from retrieval activities. This treated material would be sent to the WTP, where it would be processed with the HLW stream. The remaining 15 percent would remain with the contaminated rubble, soil, and equipment and be disposed of as MLLW in the RPPDF. The resulting value would be 14.25 percent (15 percent of 95 percent), rounded to 14 percent. Thus, 19 percent of the inventory of contaminants from the residual waste in the tanks, ancillary equipment, and soil contaminated by tank waste retrieval leaks would be sent to the RPPDF as MLLW (SAIC 2007g, 2008a).

Table D-45. Tank Closure Alternative 4: Radiological Constituents of Potential Concern Balance

| | Iodine-129 | | Cesium-137 | | Carbon-14 | | Hydrogen-3 (Tritium) | | Uranium-233, -234, -235, -238 | | Neptunium-237 | | Plutonium -239, -240 | | Strontium-90 | | Technetium-99 | |
|---|----------------------------|--------------|----------------------------|--------------|----------------------------|-------------|----------------------------|-------------|-------------------------------|--------------|----------------------------|--------------|----------------------------|--------------|----------------------------|--------------|----------------------------|--------------|
| | Curies | % of BBI | Curies | % of BBI | Curies | % of BBI | Curies | % of BBI | Curies | % of BBI | Curies | % of BBI | Curies | % of BBI | Curies | % of BBI | Curies | % of BBI |
| Best-Basis Inventory | | | | | | | | | | | | | | | | | | |
| BBI ^a | 4.82×10 ¹ | N/A | 4.58×10 ⁷ | N/A | 3.12×10 ³ | N/A | 1.21×10 ⁴ | N/A | 9.38×10 ² | N/A | 1.41×10 ² | N/A | 8.14×10 ⁴ | N/A | 5.05×10 ⁷ | N/A | 2.97×10 ⁴ | N/A |
| Tank Closure Waste Inventory | | | | | | | | | | | | | | | | | | |
| Tank residual waste ^b | 4.82×10 ⁻² | 0.1 | 4.58×10 ⁴ | 0.1 | 3.12 | 0.1 | 1.21×10 ¹ | 0.1 | 9.38×10 ⁻¹ | 0.1 | 1.41×10 ⁻¹ | 0.1 | 8.14×10 ¹ | 0.1 | 5.05×10 ⁴ | 0.1 | 2.97×10 ¹ | 0.1 |
| IHLW glass ^{c, d} | 6.55×10 ⁻³ | 0.0 | 4.08×10 ⁷ | 89.1 | 0 | 0.0 | 0 | 0.0 | 8.41×10 ² | 89.6 | 1.39×10 ² | 98.7 | 7.40×10 ⁴ | 90.9 | 4.93×10 ⁷ | 97.6 | 1.70×10 ² | 0.6 |
| ILAW glass and retired LAW melters | 2.82 | 5.8 | 2.50×10 ⁵ | 0.5 | 0 | 0.0 | 0 | 0.0 | 2.04×10 ¹ | 2.2 | 1.37×10 ⁻¹ | 0.1 | 7.41 | 0.0 | 1.60×10 ⁴ | 0.0 | 8.48×10 ³ | 28.6 |
| ETF-generated solid secondary waste ^e | 2.23×10 ¹ | 46.3 | 1.36×10 ¹ | 0 | 3.60 | 0.1 | 0 | 0.0 | 6.67×10 ⁻² | 0.0 | 5.19×10 ⁻² | 0.0 | 9.45×10 ⁻⁴ | 0.0 | 5.49×10 ¹ | 0.0 | 3.52×10 ¹ | 0.1 |
| Solid secondary waste ^f | 1.36 | 2.8 | 1.77×10 ⁵ | 0.4 | 0 | 0.0 | 0 | 0.0 | 3.36 | 0.4 | 2.82×10 ⁻¹ | 0.2 | 1.82×10 ² | 0.2 | 7.74×10 ⁵ | 1.5 | 1.28×10 ² | 0.4 |
| 200-East Area cast stone waste | 1.86×10 ¹ | 38.7 | 2.31×10 ⁵ | 0.5 | 1.18×10 ³ | 37.9 | 4.66×10 ³ | 38.7 | 2.17×10 ¹ | 2.3 | 3.30×10 ⁻³ | 0.0 | 5.77×10 ⁻¹ | 0.0 | 9.23×10 ² | 0.0 | 1.14×10 ⁴ | 38.4 |
| 200-West Area BV glass ^g | 3.11 | 6.5 | 4.39×10 ⁶ | 9.6 | 0 | 0.0 | 0 | 0.0 | 3.03×10 ¹ | 3.2 | 9.66×10 ⁻¹ | 0.7 | 1.05×10 ³ | 1.3 | 4.65×10 ⁵ | 0.9 | 9.50×10 ³ | 32.0 |
| Transuranic waste ^h | 5.07×10 ⁻² | 0.1 | 3.44×10 ⁵ | 0.8 | 3.88 | 0.1 | 3.36 | 0.0 | 4.71×10 ¹ | 5.0 | 9.88×10 ⁻¹ | 0.7 | 7.46×10 ³ | 9.2 | 7.59×10 ⁵ | 1.5 | 3.39×10 ² | 1.1 |
| Totalⁱ | 4.83×10¹ | 100.3 | 4.63×10⁷ | 100.9 | 1.19×10³ | 38.2 | 4.68×10³ | 38.8 | 9.65×10² | 102.8 | 1.42×10² | 100.5 | 8.28×10⁴ | 101.7 | 5.14×10⁷ | 101.7 | 3.01×10⁴ | 101.3 |
| Other Inventory | | | | | | | | | | | | | | | | | | |
| Solid and liquid secondary waste from cesium and strontium capsules | 0 | N/A | 1.99×10 ⁵ | N/A | 0 | N/A | 0 | N/A | 0 | N/A | 0 | N/A | 0 | N/A | 3.16×10 ⁵ | N/A | 0 | N/A |
| Cesium and strontium capsules ^j | 0 | N/A | 4.59×10 ⁷ | N/A | 0 | N/A | 0 | N/A | 0 | N/A | 0 | N/A | 0 | N/A | 1.98×10 ⁷ | N/A | 0 | N/A |
| PPF secondary waste rubble, soil, and equipment ^k | 1.54×10 ⁻¹ | N/A | 9.06×10 ⁴ | N/A | 4.00 | N/A | 7.19×10 ¹ | N/A | 5.19 | N/A | 1.37×10 ⁻¹ | N/A | 5.65×10 ¹ | N/A | 5.70×10 ⁴ | N/A | 3.23×10 ¹ | N/A |
| Air Emissions | | | | | | | | | | | | | | | | | | |
| Treatment air emissions ^l | 2.96×10 ¹ | N/A | 8.00×10 ⁴ | N/A | 1.95×10 ³ | N/A | 7.46×10 ³ | N/A | 4.48×10 ⁻¹ | N/A | 7.04×10 ⁻² | N/A | 3.77×10 ¹ | N/A | 3.62×10 ⁴ | N/A | 9.26 | N/A |

- ^a Source of BBI is DOE-ORP-2003-02, Rev. 0, *Inventory and Source Term Data Package* (DOE 2003a).
- ^b Represents 99.9 percent retrieval. For analysis purposes, waste inventories from tank waste retrieval leaks and ancillary equipment were assumed to be treated in the Waste Treatment Plant and via supplemental treatment processes.
- ^c To be stored on site until disposition decisions are made and implemented. The inventory would include the retired HLW melters.
- ^d Includes PPF contribution from clean closure of BX and SX tank farms.
- ^e Includes secondary liquids that would be sent to the ETF and treated; solids would be disposed of in an Integrated Disposal Facility. Excludes are liquid secondary waste from processing of cesium and strontium capsules, which would be reported separately.
- ^f Includes solid low-level radioactive waste and mixed low-level radioactive waste streams that would be generated by waste treatment operations. Such waste streams would include debris waste, melter consumables, failed process components, analytical laboratory waste, spent resins, spent carbon adsorbent, high-efficiency particulate air filters, and other process-related waste. Excludes contaminated liquid effluent waste streams, which would be treated at the ETF.
- ^g Includes technetium-99 inventory that resides in the BV waste container insulating material or waste container.
- ^h Tank transuranic waste would be disposed of in the Waste Isolation Pilot Plant.
- ⁱ Totals may exceed 100 percent due to conservative estimates or rounded numbers. BBI of percentages were rounded to the nearest tenth. Carbon-14 and hydrogen-3 (tritium) may not total 100 percent; a portion of each would be released to the offgas streams and stack, and a portion (ETF-generated liquid) would be disposed of in the State-Approved Land Disposal Site.
- ^j To be treated in the Waste Treatment Plant, resulting in glass waste, which would be stored on site until disposition decisions are made and implemented.
- ^k Rubble, soil, and equipment would be generated by removal of 4.6 meters (15 feet) of soil and ancillary equipment at the BX and SX tank farms. Disposal would take place in the River Protection Project Disposal Facility.
- ^l Includes air emissions from all waste treatment processes, including those from treatment of the cesium and strontium capsules. For analysis purposes, both iodine-129 capture and air emission releases were assumed.

Key: %=percent; BBI=Best-Basis Inventory; BV=bulk vitrification; ETF=Effluent Treatment Facility; HLW=high-level radioactive waste; IHLW=immobilized high-level radioactive waste; ILAW=immobilized low-activity waste; LAW=low-activity waste; N/A=not applicable; PPF=Preprocessing Facility.

Source: SAIC 2007g, 2007h, 2008a.

Table D-46. Tank Closure Alternative 4: Chemical Constituents of Potential Concern Balance

| | Chromium | | Mercury | | Nitrate | | Lead | | Total Uranium | | Acetonitrile | | Benzene | | Butanol | | PCBs | | 2,4,6-TCP | |
|---|----------------------------|--------------|----------------------------|-------------|----------------------------|-------------|----------------------------|--------------|----------------------------|--------------|----------------------------|-------------|-----------------------------|-------------|----------------------------|-------------|----------------------------|------------|-----------------------------|-------------|
| | Kg | % of BBI | Kg | % of BBI | Kg | % of BBI | Kg | % of BBI | Kg | % of BBI | Kg | % of BBI | Kg | % of BBI | Kg | % of BBI | Kg | % of BBI | Kg | % of BBI |
| Best-Basis Inventory | | | | | | | | | | | | | | | | | | | | |
| BBI ^a | 5.98×10 ⁵ | N/A | 1.83×10 ³ | N/A | 7.08×10 ⁷ | N/A | 8.41×10 ⁴ | N/A | 5.97×10 ⁵ | N/A | 2.95×10 ⁴ | N/A | 2.40 | N/A | 3.45×10 ⁶ | N/A | 1.68×10 ³ | N/A | 1.11 | N/A |
| Tank Closure Waste Inventory | | | | | | | | | | | | | | | | | | | | |
| Tank residual waste ^b | 5.98×10 ² | 0.1 | 1.83 | 0.1 | 7.08×10 ⁴ | 0.1 | 8.41×10 ¹ | 0.1 | 5.97×10 ² | 0.1 | 2.95×10 ¹ | 0.1 | 2.40×10 ⁻³ | 0.1 | 3.45×10 ³ | 0.1 | 1.68 | 0.1 | 1.11×10 ⁻³ | 0.1 |
| IHLW glass ^{c, d} | 1.14×10 ⁵ | 19.0 | 0 | 0.0 | 0 | 0.0 | 7.15×10 ⁴ | 85.0 | 5.17×10 ⁵ | 86.6 | 0 | 0.0 | 0 | 0.0 | 0 | 0.0 | 0 | 0.0 | 0 | 0.0 |
| ILAW glass and retired LAW melters | 1.39×10 ⁵ | 23.2 | 0 | 0.0 | 0 | 0.0 | 2.68×10 ³ | 3.2 | 1.13×10 ⁴ | 1.9 | 0 | 0.0 | 0 | 0.0 | 0 | 0.0 | 0 | 0.0 | 0 | 0.0 |
| ETF-generated solid secondary waste ^e | 2.28×10 ¹ | 0.0 | 4.84 | 0.3 | 3.99×10 ⁶ | 5.6 | 4.08×10 ² | 0.5 | 5.59×10 ¹ | 0.0 | NR | N/A | NR | N/A | NR | N/A | NR | N/A | NR | N/A |
| Solid secondary waste ^f | 8.07×10 ² | 0.1 | 1.53×10 ³ | 83.9 | 0 | 0.0 | 2.19×10 ² | 0.3 | 2.07×10 ³ | 0.3 | NR | N/A | NR | N/A | NR | N/A | NR | N/A | NR | N/A |
| 200-East Area cast stone waste | 1.78×10 ⁵ | 29.8 | 2.44×10 ² | 13.4 | 2.11×10 ⁷ | 29.7 | 3.57×10 ³ | 4.2 | 1.50×10 ⁴ | 2.5 | 1.12×10 ⁴ | 37.9 | 9.11×10 ⁻¹ | 37.9 | 1.31×10 ⁶ | 37.9 | 6.39 | 0.4 | 4.20×10 ⁻¹ | 37.9 |
| 200-West Area BV glass | 1.49×10 ⁵ | 25.0 | 0 | 0.0 | 0 | 0.0 | 3.59×10 ³ | 4.3 | 1.99×10 ⁴ | 3.3 | 0 | 0.0 | 0 | 0.0 | 0 | 0.0 | 0 | 0.0 | 0 | 0.0 |
| TRU waste ^g | 2.86×10 ⁴ | 4.8 | 3.49×10 ¹ | 1.9 | 9.12×10 ⁵ | 1.3 | 6.49×10 ³ | 7.7 | 5.98×10 ⁴ | 10.0 | 5.99×10 ² | 2.0 | 4.88×10 ⁻² | 2.0 | 7.01×10 ⁴ | 2.0 | 3.54×10 ¹ | 2.1 | 2.25×10 ⁻² | 2.0 |
| Total^h | 6.10×10⁵ | 102.0 | 1.82×10³ | 99.5 | 2.60×10⁷ | 36.8 | 8.85×10⁴ | 105.2 | 6.26×10⁵ | 104.8 | 1.18×10⁴ | 40.1 | 9.62×10⁻¹ | 40.1 | 1.38×10⁶ | 40.1 | 4.35×10¹ | 2.6 | 4.44×10⁻¹ | 40.1 |
| Other Inventoryⁱ | | | | | | | | | | | | | | | | | | | | |
| PPF secondary waste ^j and rubble, soil, and equipment ^k | 1.88×10 ³ | N/A | 7.69 | N/A | 1.16×10 ⁵ | N/A | 4.29×10 ¹ | N/A | 4.86×10 ³ | N/A | NR | N/A | NR | N/A | 2.86 | N/A | 1.64×10 ⁻¹ | N/A | NR | N/A |
| Air Emissions | | | | | | | | | | | | | | | | | | | | |
| Treatment air emissions ^l | NR | N/A | 1.80×10 ³ | N/A | NR | N/A | NR | N/A | NR | N/A | NR | N/A | NR | N/A | NR | N/A | NR | N/A | NR | N/A |

^a Source of BBI is DOE-ORP-2003-02, Rev. 0, *Inventory and Source Term Data Package* (DOE 2003a).

^b Represents 99.9 percent retrieval. For analysis purposes, waste inventories from tank waste retrieval leaks and ancillary equipment were assumed to be treated in the Waste Treatment Plant and via supplemental treatment processes.

^c To be stored on site until disposition decisions are made and implemented. The inventory would include the retired HLW melters.

^d Includes PPF contribution from clean closure of the BX and SX tank farms.

^e Includes secondary liquids that would be sent to the ETF and treated; solids would be disposed of in an Integrated Disposal Facility.

^f Includes solid low-level radioactive waste and mixed low-level radioactive waste streams that would be generated by waste treatment operations. Such waste streams would include debris waste, melter consumables, failed process components, analytical laboratory waste, spent resins, spent carbon adsorbent, high-efficiency particulate air filters, and other process-related waste. Excludes contaminated liquid effluent waste streams, which would be treated at the ETF.

^g Tank transuranic waste would be disposed of in the Waste Isolation Pilot Plant.

^h Totals may exceed 100 percent due to conservative estimates or rounded numbers. BBI percentages were rounded to the nearest tenth. The organic chemicals (acetonitrile, benzene, butanol, polychlorinated biphenyls, and 2,4,6-trichlorophenol) may not total 100 percent because they would be destroyed during the thermal treatment processes. Nitrate may not total 100 percent because it would be volatilized and released through the facility stack.

ⁱ No chemical constituents of potential concern have been reported in the cesium and strontium capsule secondary waste streams.

^j Includes the mixed low-level radioactive waste secondary solid stream generated by the PPF and the solid waste generated from treating PPF liquid and solid secondary waste, as well as solid secondary waste. Disposal would take place in the River Protection Project Disposal Facility.

^k Rubble, soil, and equipment would be generated by the removal of 4.6 meters (15 feet) of soil and ancillary equipment at the BX and SX tank farms. Disposal would take place in the River Protection Project Disposal Facility.

^l Includes air emissions from all waste treatment processes, including those from treatment of the cesium and strontium capsules. For analysis purposes, both mercury capture and air emission releases were assumed.

Key: %=percent; 2,4,6-TCP=2,4,6-trichlorophenol; BBI=Best-Basis Inventory; butanol=n-butyl alcohol; BV=bulk vitrification; ETF=Effluent Treatment Facility; HLW=high-level radioactive waste; IHLW=immobilized high-level radioactive waste; ILAW=immobilized low-activity waste; kg=kilograms; LAW=low-activity waste; N/A=not applicable; NR=not reported; PCBs=polychlorinated biphenyls; PPF=Preprocessing Facility; TRU=transuranic.

Source: SAIC 2007g, 2007i, 2008a.

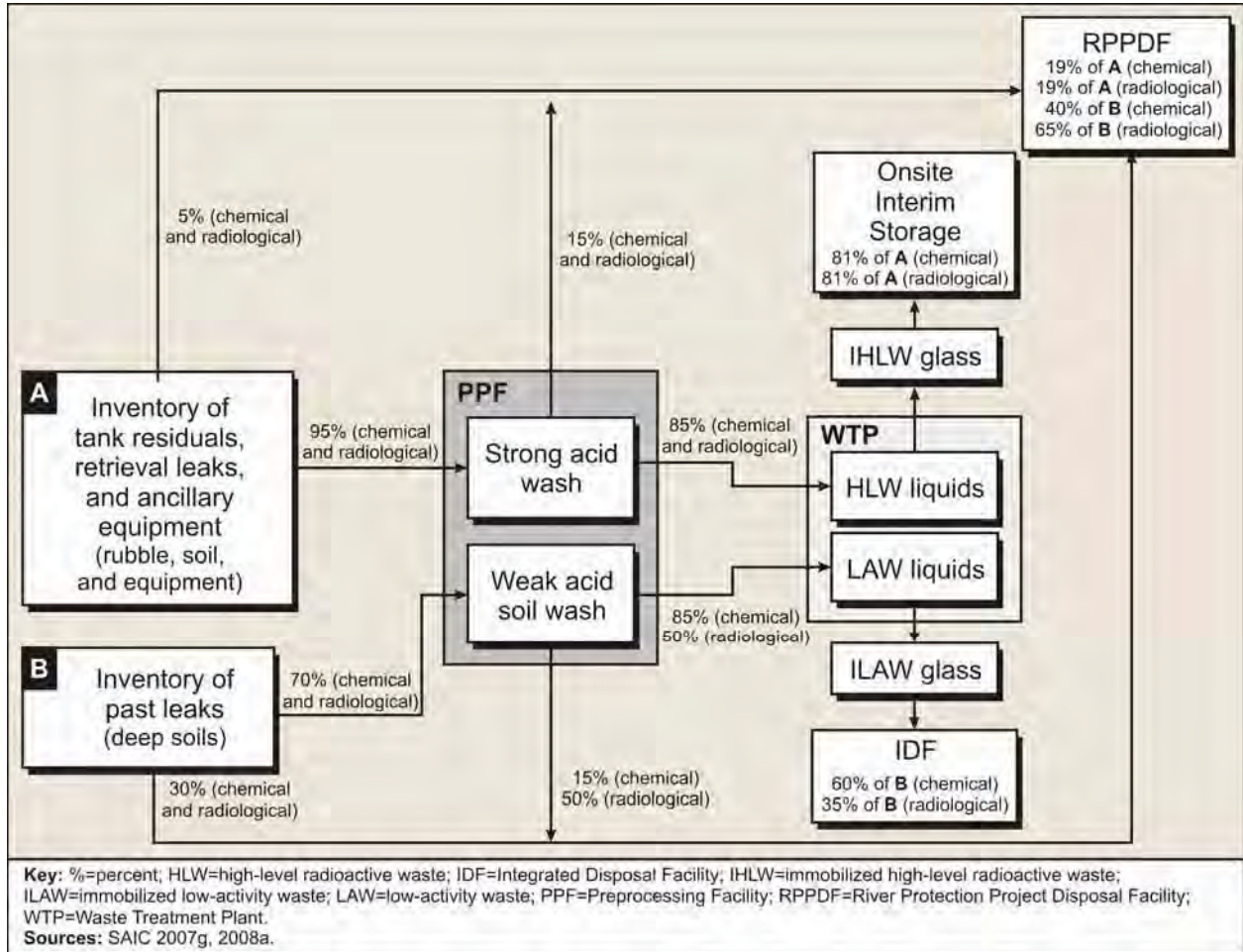

Figure D-8. Tank Closure Alternative 4: Clean Closure of BX and SX Tank Farms Flowsheet

Table D–47. Tank Closure Alternative 4: Radiological Constituents of Potential Concern Inventory from Clean Closure of BX and SX Tank Farms (curies)

| Analyte | MLLW ^a | IHLW Glass ^b | ILAW Glass ^c |
|-------------------------------|-----------------------|-------------------------|-------------------------|
| Hydrogen-3 (tritium) | 7.19×10 ¹ | 0 | 0 |
| Carbon-14 | 3.99 | 0 | 0 |
| Strontium-90 | 5.41×10 ⁴ | 1.69×10 ⁵ | 1.53×10 ⁴ |
| Technetium-99 | 3.14×10 ¹ | 1.99×10 ¹ | 2.84×10 ¹ |
| Iodine-129 | 5.84×10 ⁻² | 6.54×10 ⁻³ | 1.09×10 ⁻² |
| Cesium-137 | 9.01×10 ⁴ | 2.86×10 ⁴ | 7.59×10 ⁴ |
| Uranium-233, -234, -235, -238 | 5.16 | 1.29 | 4.16 |
| Neptunium-237 | 1.36×10 ⁻¹ | 6.36×10 ⁻² | 1.34×10 ⁻¹ |
| Plutonium-239, -240 | 5.59×10 ¹ | 2.29×10 ² | 6.97 |

^a Represents 19.25 percent of the ancillary equipment, tank waste retrieval leak, and tank residual waste inventories, as well as 65 percent of the deep soils inventory for the BX and SX tank farms. Disposal would take place in the River Protection Project Disposal Facility.

^b Represents the portion of the 85 percent of highly contaminated rubble, soil, and equipment (tank and ancillary equipment) inventory from clean closure of the BX and SX tank farms that after treatment in the Waste Treatment Plant resides in the IHLW glass. IHLW would be disposed of off site, however, it may remain on site until disposition decisions are made and implemented.

^c Represents the portion of the 50 percent of highly contaminated rubble and soil (deep soil) inventory from clean closure of the BX and SX tank farms that would reside in the ILAW glass after treatment in the Waste Treatment Plant. Disposal would take place in an Integrated Disposal Facility.

Key: HLW=high-level radioactive waste; IHLW=immobilized high-level radioactive waste; ILAW=immobilized low-activity waste; MLLW=mixed low-level radioactive waste.

Source: SAIC 2007g, 2007j, 2008a.

Table D–48. Tank Closure Alternative 4: Chemical Constituents of Potential Concern Inventory from Clean Closure of BX and SX Tank Farms (kilograms)

| Analyte | MLLW ^a | IHLW Glass ^b | ILAW Glass ^c |
|---------------------------|-----------------------|-------------------------|-------------------------|
| Chromium | 1.86×10 ³ | 1.35×10 ³ | 4.78×10 ³ |
| Mercury | 1.28 | 0 | 0 |
| Nitrate | 7.78×10 ⁴ | 0 | 0 |
| Lead | 4.27×10 ¹ | 9.18×10 ¹ | 4.03×10 ⁻¹ |
| Total Uranium | 4.85×10 ³ | 1.79×10 ³ | 0 |
| Acetonitrile | NR | NR | NR |
| Benzene | NR | NR | NR |
| Butanol (n-butyl alcohol) | 2.68 | NR | NR |
| Polychlorinated biphenyls | 1.64×10 ⁻¹ | NR | NR |
| 2,4,6-Trichlorophenol | NR | NR | NR |

^a Represents 19.25 percent of the ancillary equipment, tank waste retrieval leak and tank residual waste inventories and 40.5 percent of the deep soils inventory for the BX and SX tank farms. Disposal would take place in the River Protection Project Disposal Facility.

^b Represents the portion of the 85 percent of the highly contaminated rubble, soil, and equipment (tank and ancillary equipment) waste inventories resulting from clean closure of the BX and SX tank farms that would reside in the IHLW glass after treatment in the Waste Treatment Plant. IHLW would be disposed of off site, however, it may remain on site until disposition decisions are made and implemented.

^c Represents the portion of the 85 percent of the highly contaminated rubble and soil (deep soil) inventory from clean closure of the BX and SX tank farms that would reside in the ILAW glass after treatment in the Waste Treatment Plant. Disposal would take place in an Integrated Disposal Facility.

Key: HLW=high-level radioactive waste; IHLW=immobilized high-level radioactive waste; ILAW=immobilized low-activity waste; MLLW=mixed low-level radioactive waste; NR=not reported.

Source: SAIC 2007g, 2007i, 2007k, 2008a.

Additionally, it was assumed that, after the soil contaminated from past tank leaks (deep soil) has been removed, 30 percent of the radioactive and chemical constituent inventory would be included in materials that are packaged and sent directly to the RPPDF. The remaining 70 percent of the contaminants would be contained in soils that are routed to the PPF for soil washing. From this 70 percent, it was assumed that the PPF processes would remove 50 percent of the radioactive contaminants and 85 percent of the chemical contaminants. Those radioactive and chemical contaminants removed in the PPF would be sent to the WTP, where they would be processed into ILAW glass. The remaining contaminants (50 percent radionuclide and 15 percent chemical) would reside in the decontaminated soil and be disposed of in the RPPDF. Thus, a total of 65 percent of the radionuclide contaminant inventory from past tank leaks would be disposed of in the RPPDF (30 percent disposed of directly and 35 percent [half of 70 percent] disposed of as MLLW after washing in the PPF). Similarly, a total of 41 percent of the chemical contaminant inventory from past tank leaks would be disposed of in the RPPDF (30 percent disposed of directly and 11 percent [15 percent of 70 percent] disposed of as MLLW after washing in the PPF). The following equations were used to calculate the inventory of contaminants due to contaminated tank materials, rubble, soil, and ancillary equipment from clean closure of the BX and SX SST farms (SAIC 2007g, 2008a).

$$M_{\text{rad}}_{\text{soil}} = 0.19 \times (M_{\text{TR-99.9}} + M_{\text{retrieval}} + M_{\text{anc}}) + 0.65 \times M_{\text{pleak}}$$

$$M_{\text{chem}}_{\text{soil}} = 0.19 \times (M_{\text{TR-99.9}} + M_{\text{retrieval}} + M_{\text{anc}}) + 0.41 \times M_{\text{pleak}}$$

where:

- $M_{\text{rad}}_{\text{soil}}$ = inventory of radioactive constituents in contaminated rubble, soil, and equipment disposed of on site
- $M_{\text{chem}}_{\text{soil}}$ = inventory of chemical constituents in contaminated rubble, soil, and equipment disposed of on site
- $M_{\text{TR-99.9}}$ = inventory of radioactive or chemical constituents in tank residual waste following removal of 99.9 percent of the inventory
- $M_{\text{retrieval}}$ = inventory of radioactive or chemical constituents from tank waste retrieval leaks
- M_{anc} = inventory of radioactive or chemical constituents in ancillary equipment
- M_{pleak} = inventory of radioactive or chemical constituents in past leaks

Processing steps under Tank Closure Alternative 5 would be similar to those under Tank Closure Alternative 4, except that a step for removal of sulfate from the LAW stream feed to the LAW melter is added. The majority of the technetium-99 would be solidified in LAW forms. Under Tank Closure Alternative 5, the ILAW glass, bulk vitrification glass, cast stone waste, and secondary waste would be 9.6 percent, 5.8 percent, 13.2 percent, and 61.5 percent of the BBI estimate for iodine-129, respectively. The process flowsheet for Tank Closure Alternative 5 is presented in Figure D-9, and material balance summaries are presented in Tables D-49 and D-50.

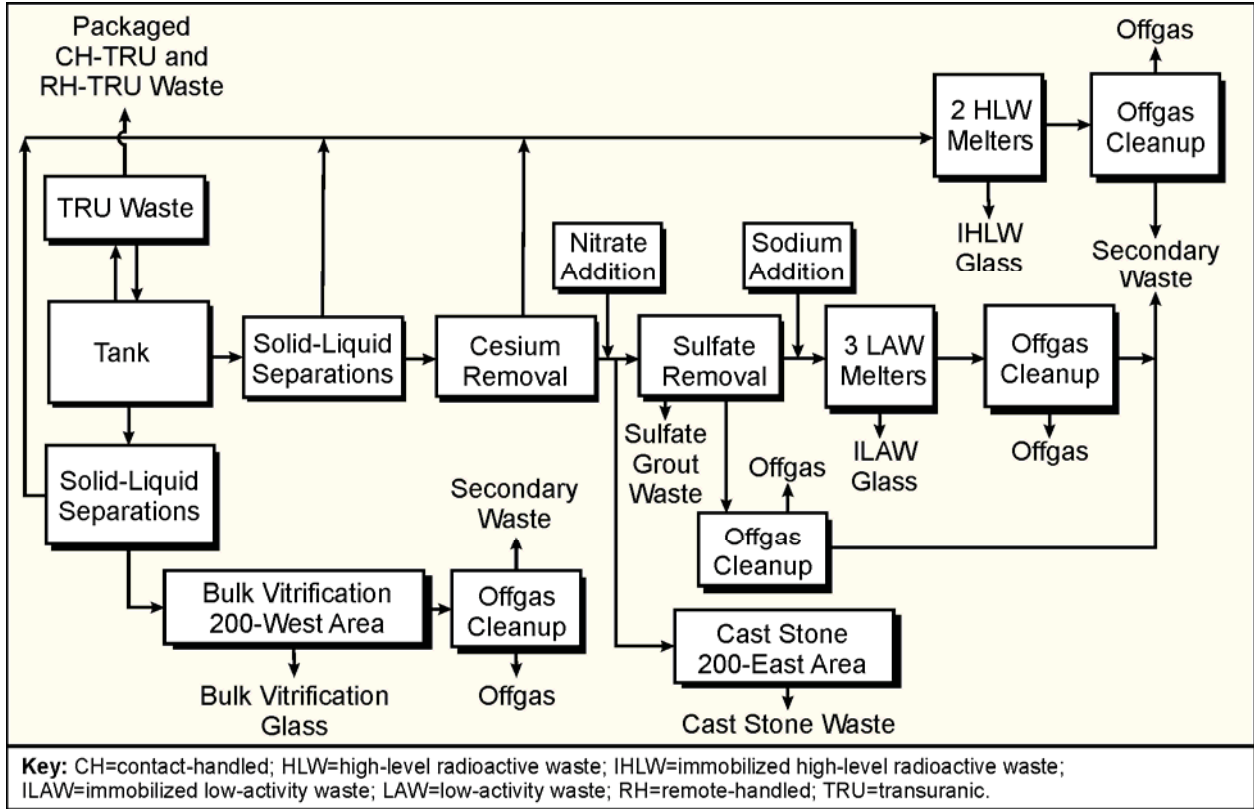

Figure D-9. Tank Closure Alternative 5 Flowsheet

Table D-49. Tank Closure Alternative 5: Radiological Constituents of Potential Concern Balance

| | Iodine-129 | | Cesium-137 | | Carbon-14 | | Hydrogen-3 (Tritium) | | Uranium-233, -234, -235, -238 | | Neptunium-237 | | Plutonium -239, -240 | | Strontium-90 | | Technetium-99 | |
|---|----------------------------|--------------|----------------------------|--------------|----------------------------|-------------|----------------------------|-------------|-------------------------------|------------|----------------------------|--------------|----------------------------|--------------|----------------------------|--------------|-------------------------|--------------|
| | Curies | % of BBI | Curies | % of BBI | Curies | % of BBI | Curies | % of BBI | Curies | % of BBI | Curies | % of BBI | Curies | % of BBI | Curies | % of BBI | Curies | % of BBI |
| Best-Basis Inventory | | | | | | | | | | | | | | | | | | |
| BBI ^a | 4.82×10 ¹ | N/A | 4.58×10 ⁷ | N/A | 3.12×10 ³ | N/A | 1.21×10 ⁴ | N/A | 9.38×10 ² | N/A | 1.41×10 ² | N/A | 8.14×10 ⁴ | N/A | 5.05×10 ⁷ | N/A | 2.97×10 ⁴ | N/A |
| Tank Closure Waste Inventory | | | | | | | | | | | | | | | | | | |
| Tank residual waste ^b | 4.82 | 10.0 | 4.58×10 ⁶ | 10.0 | 3.12×10 ² | 10.0 | 1.21×10 ³ | 10.0 | 9.38×10 ¹ | 10.0 | 1.41×10 ¹ | 10.0 | 8.14×10 ³ | 10.0 | 5.05×10 ⁶ | 10.0 | 2.97×10 ³ | 10.0 |
| IHLW glass ^c | 1.32×10 ⁻⁵ | 0.0 | 3.63×10 ⁷ | 79.2 | 0 | 0.0 | 0 | 0.0 | 7.56×10 ² | 80.6 | 1.25×10 ² | 88.9 | 6.65×10 ⁴ | 81.6 | 4.43×10 ⁷ | 87.6 | 1.35×10 ² | 0.5 |
| ILAW glass and retired LAW melters | 4.61 | 9.6 | 2.51×10 ⁵ | 0.5 | 0 | 0.0 | 0 | 0.0 | 2.67×10 ¹ | 2.8 | 3.92×10 ⁻³ | 0.0 | 6.13×10 ⁻¹ | 0.0 | 1.14×10 ⁻¹ | 0.0 | 1.39×10 ⁴ | 46.8 |
| Sulfate grout waste ^d | 0 | 0.0% | 3.11×10 ⁴ | 0.1 | 0 | 0.0 | 0 | 0.0 | 0 | 0.0 | 1.63×10 ⁻⁴ | 0.0 | 9.98×10 ⁻² | 0.0 | 1.14×10 ³ | 0.0 | 0 | 0.0 |
| ETF-generated solid secondary waste ^e | 2.74×10 ¹ | 56.9 | 1.36×10 ¹ | 0.0 | 1.04 | 0.0 | 0 | 0.0 | 6.07×10 ⁻² | 0.0 | 4.68×10 ⁻² | 0.0 | 8.51×10 ⁻⁴ | 0.0 | 4.95×10 ¹ | 0.0 | 5.03×10 ¹ | 0.2 |
| Solid secondary waste ^f | 2.24 | 4.7 | 1.58×10 ⁵ | 0.3 | 0 | 0.0 | 0 | 0.0 | 3.07 | 0.3 | 2.54×10 ⁻¹ | 0.2 | 1.64×10 ⁻² | 0.2 | 6.97×10 ⁵ | 1.4 | 2.08×10 ² | 0.7 |
| 200-East cast stone waste | 6.38 | 13.2 | 7.82×10 ⁴ | 0.2 | 4.05×10 ² | 13.0 | 1.60×10 ³ | 13.2 | 7.41 | 0.8 | 1.13×10 ⁻³ | 0.0 | 1.97×10 ⁻¹ | 0.0 | 3.16×10 ² | 0.0 | 3.90×10 ³ | 13.1 |
| 200-West BV glass ^g | 2.80 | 5.8 | 4.39×10 ⁶ | 9.6 | 0 | 0.0 | 0 | 0.0 | 2.73×10 ¹ | 2.9 | 8.71×10 ⁻¹ | 0.6 | 9.49×10 ² | 1.2 | 4.19×10 ⁵ | 0.8 | 8.56×10 ³ | 28.8 |
| TRU waste ^h | 4.57×10 ⁻² | 0.1 | 3.10×10 ⁵ | 0.7 | 3.50 | 0.1 | 3.03 | 0.0 | 4.24×10 ¹ | 4.5 | 8.90×10 ⁻¹ | 0.6 | 6.72×10 ³ | 8.2 | 6.84×10 ⁵ | 1.4 | 3.06×10 ² | 1.0 |
| Totalⁱ | 4.83×10¹ | 100.3 | 4.61×10⁷ | 100.6 | 7.22×10² | 23.1 | 2.80×10³ | 23.3 | 9.57×10² | 102 | 1.42×10² | 100.4 | 8.25×10⁴ | 101.2 | 5.11×10⁷ | 101.2 | 3×10⁴ | 101.1 |
| Other Inventory | | | | | | | | | | | | | | | | | | |
| Solid and liquid secondary waste from cesium and strontium capsules | 0 | N/A | 1.99×10 ⁵ | N/A | 0 | N/A | 0 | N/A | 0 | N/A | 0 | N/A | 0 | N/A | 3.16×10 ⁵ | N/A | 0 | N/A |
| Cesium and strontium capsules ^j | 0 | N/A | 4.59×10 ⁷ | N/A | 0 | N/A | 0 | N/A | 0 | N/A | 0 | N/A | 0 | N/A | 1.98×10 ⁷ | N/A | 0 | N/A |
| Air Emissions | | | | | | | | | | | | | | | | | | |
| Treatment air emissions ^k | 3.70×10 ¹ | N/A | 7.77×10 ⁴ | N/A | 9.48×10 ² | N/A | 8.69×10 ³ | N/A | 4.07×10 ⁻¹ | N/A | 6.33×10 ⁻² | N/A | 3.39×10 ¹ | N/A | 3.36×10 ⁴ | N/A | 1.16×10 ¹ | N/A |

^a Source of BBI is DOE-ORP-2003-02, Rev. 0, *Inventory and Source Term Data Package* (DOE 2003a).

^b Represents 90.0 percent retrieval. For analysis purposes, waste inventories from tank waste retrieval leaks and ancillary equipment were assumed to be treated in the Waste Treatment Plant and via supplemental treatment processes.

^c To be stored on site until disposition decisions are made and implemented. The inventory would include the retired HLW melters.

^d Generated by removal of sulfate from the ILAW waste stream. Disposal would take place in an Integrated Disposal Facility.

^e Includes secondary liquids that would be sent to the ETF and treated; solids would be disposed of in an Integrated Disposal Facility. Excludes liquid secondary waste from processing of cesium and strontium capsules, which would be reported separately.

^f Includes solid low-level radioactive waste and mixed low-level radioactive waste streams that would be generated by waste treatment operations. Such waste streams would include debris waste, melter consumables, failed process components, analytical laboratory waste, spent resins, spent carbon adsorbent, high-efficiency particulate air filters, and other process-related waste. Excludes contaminated liquid effluent waste streams, which would be treated at the ETF.

^g Includes technetium-99 inventory that resides in the BV waste container insulating material or waste container.

^h Tank TRU waste disposal would take place in the Waste Isolation Pilot Plant.

ⁱ Totals may exceed 100 percent due to conservative estimates or rounded numbers. BBI of percentages were rounded to the nearest tenth. Carbon-14 and hydrogen-3 (tritium) may not total 100 percent; a portion of each would be released to the offgas streams and stack, and a portion (ETF-generated liquid) would be disposed of in the State-Approved Land Disposal Site.

^j To be treated in the Waste Treatment Plant, resulting in glass waste, which would be stored on site until disposition decisions are made and implemented.

^k Includes air emissions from all waste treatment processes, including those from treatment of the cesium and strontium capsules. For analysis purposes, both iodine-129 capture and air emission releases were assumed.

Key: %=percent; BBI=Best-Basis Inventory; BV=bulk vitrification; ETF=Effluent Treatment Facility; HLW=high-level radioactive waste; IHLW=immobilized high-level radioactive waste; ILAW=immobilized low-activity waste; LAW=low-activity waste; N/A=not applicable; TRU=transuranic.

Source: SAIC 2007g, 2007h, 2008a.

Table D-50. Tank Closure Alternative 5: Chemical Constituents of Potential Concern Balance

| | Chromium | | Mercury | | Nitrate | | Lead | | Total Uranium | | Acetonitrile | | Benzene | | Butanol | | PCB | | 2,4,6-TCP | |
|--|----------------------------|--------------|----------------------------|-------------|----------------------------|-------------|----------------------------|--------------|----------------------------|--------------|----------------------------|-------------|-----------------------------|-------------|----------------------------|-------------|----------------------------|-------------|-----------------------------|-------------|
| | Kg | % of BBI | Kg | % of BBI | Kg | % of BBI | Kg | % of BBI | Kg | % of BBI | Kg | % of BBI | Kg | % of BBI | Kg | % of BBI | Kg | % of BBI | Kg | % of BBI |
| Best-Basis Inventory | | | | | | | | | | | | | | | | | | | | |
| BBI ^a | 5.98×10 ⁵ | N/A | 1.83×10 ³ | N/A | 7.08×10 ⁷ | N/A | 8.41×10 ⁴ | N/A | 5.97×10 ⁵ | N/A | 2.95×10 ⁴ | N/A | 2.40 | N/A | 3.45×10 ⁶ | N/A | 1.68×10 ³ | N/A | 1.11 | N/A |
| Tank Closure Waste Inventory | | | | | | | | | | | | | | | | | | | | |
| Tank residual waste ^b | 5.98×10 ⁴ | 10.0 | 1.83×10 ² | 10.0 | 7.08×10 ⁶ | 10.0 | 8.41×10 ³ | 10.0 | 5.97×10 ⁴ | 10.0 | 2.95×10 ³ | 10.0 | 2.40×10 ⁻¹ | 10.0 | 3.45×10 ⁵ | 10.0 | 1.68×10 ² | 10.0 | 1.11×10 ⁻¹ | 10.0 |
| IHLW glass ^c | 1.01×10 ⁵ | 16.9 | 0 | 0.0 | 0 | 0.0 | 6.43×10 ⁴ | 76.5 | 4.64×10 ⁵ | 77.8 | 0 | 0.0 | 0 | 0.0 | 0 | 0.0 | 0 | 0.0 | 0 | 0.0 |
| ILAW glass and retired LAW melters | 2.20×10 ¹ | 0.0 | 0 | 0.0 | 0 | 0.0 | 4.40×10 ⁻¹ | 0.0 | 1.86×10 ⁴ | 3.1 | 0 | 0.0 | 0 | 0.0 | 0 | 0.0 | 0 | 0.0 | 0 | 0.0 |
| Sulfate grout waste ^d | 2.21×10 ⁵ | 36.9 | 0 | 0.0 | 0 | 0.0 | 4.41×10 ³ | 5.2 | 0 | 0.0 | NR | N/A | NR | N/A | NR | N/A | NR | N/A | NR | N/A |
| ETF-generated solid secondary waste ^e | 1.15×10 ¹ | 0.0 | 4.77 | 0.3 | 9.70×10 ⁶ | 13.7 | 3.67×10 ² | 0.4 | 5.09×10 ¹ | 0.0 | NR | N/A | NR | N/A | NR | N/A | NR | N/A | NR | N/A |
| Solid secondary waste ^f | 3.32×10 ² | 0.1 | 1.51×10 ³ | 82.8 | 0 | 0.0 | 1.90×10 ² | 0.2 | 1.90×10 ³ | 0.3 | NR | N/A | NR | N/A | NR | N/A | NR | N/A | NR | N/A |
| 200-East Area cast stone waste | 6.11×10 ⁴ | 10.2 | 8.36×10 ¹ | 4.6 | 7.21×10 ⁶ | 10.2 | 1.22×10 ³ | 1.5 | 5.15×10 ³ | 0.9 | 3.71×10 ³ | 12.6 | 3.02×10 ⁻¹ | 12.6 | 4.35×10 ⁵ | 12.6 | 2.12 | 0.1 | 1.39×10 ⁻¹ | 12.6 |
| 200-West Area BV glass | 1.35×10 ⁵ | 22.5 | 0 | 0 | 0 | 0.0 | 3.23×10 ³ | 3.8 | 1.80×10 ⁴ | 3.0 | 0 | 0.0 | 0 | 0.0 | 0 | 0.0 | 0 | 0.0 | 0 | 0.0 |
| TRU waste ^g | 2.57×10 ⁴ | 4.3 | 3.15×10 ¹ | 1.7 | 9.69×10 ⁵ | 1.4 | 5.85×10 ³ | 7.0 | 5.38×10 ⁴ | 9.0 | 5.39×10 ² | 1.8 | 4.39×10 ⁻² | 1.8 | 6.32×10 ⁴ | 1.8 | 3.19×10 ¹ | 1.9 | 2.03×10 ⁻² | 1.8 |
| Total^h | 6.03×10⁵ | 100.8 | 1.81×10³ | 99.4 | 2.50×10⁷ | 35.3 | 8.80×10⁴ | 104.6 | 6.21×10⁵ | 104.1 | 7.20×10³ | 24.4 | 5.86×10⁻¹ | 24.4 | 8.43×10⁵ | 24.4 | 2.03×10² | 12.0 | 2.70×10⁻¹ | 24.4 |
| Other Inventoryⁱ | | | | | | | | | | | | | | | | | | | | |
| Treatment air emissions ^j | NR | N/A | 1.72×10 ³ | N/A | NR | N/A | NR | N/A | NR | N/A | NR | N/A | NR | N/A | NR | N/A | NR | N/A | NR | N/A |

^a Source of BBI is DOE-ORP-2003-02, Rev. 0, *Inventory and Source Term Data Package* (DOE 2003a).

^b Represents 90.0 percent retrieval. For analysis purposes, waste inventories from tank waste retrieval leaks and ancillary equipment were assumed to be treated in the WTP and via supplemental treatment processes.

^c To be stored on site until disposition decisions are made and implemented. The inventory would include the retired HLW melters.

^d Generated by removal of sulfate from the ILAW feed stream. Disposal would take place in an Integrated Disposal Facility.

^e Includes secondary liquids that would be sent to the ETF and treated; solids would be disposed of in an Integrated Disposal Facility.

^f Includes solid low-level radioactive waste and mixed low-level radioactive waste streams that would be generated by waste treatment operations. Such waste streams would include debris waste, melter consumables, failed process components, analytical laboratory waste, spent resins, spent carbon adsorbent, high-efficiency particulate air filters, and other process-related waste. Excludes contaminated liquid effluent waste streams, which would be treated at the ETF.

^g Tank transuranic waste would be disposed of in the Waste Isolation Pilot Plant.

^h Totals may exceed 100 percent due to conservative estimates or rounded numbers. BBI percentages were rounded to the nearest tenth. The organic chemicals (acetonitrile, benzene, butanol, polychlorinated biphenyls, and 2,4,6-trichlorophenol) may not total 100 percent because they would be destroyed during thermal treatment processes. Nitrate may not total 100 percent because it would be volatilized and released through the facility stack.

ⁱ No chemical constituents of potential concern have been reported in the cesium and strontium capsule secondary waste streams.

^j Includes air emissions from all waste treatment processes, including those from treatment of the cesium and strontium capsules. For analysis purposes, both mercury capture and air emission releases were assumed.

Key: %=percent; 2,4,6-TCP=2,4,6-trichlorophenol; BBI=Best-Basis Inventory; butanol=n-butyl alcohol; BV=bulk vitrification; ETF=Effluent Treatment Facility; HLW=high-level radioactive waste; IHLW=immobilized high-level radioactive waste; ILAW=immobilized low-activity waste; kg=kilograms; LAW=low-activity waste; N/A=not applicable; NR=not reported; PCBs=polychlorinated biphenyls; TRU=transuranic; WTP=Waste Treatment Plant.

Source: SAIC 2007g, 2007i, 2008a.

Under Tank Closure Alternative 6, there are three subalternatives (6A, 6B, and 6C); two of these alternatives (6A and 6B) have two options: a Base Case and an Option Case. Under the Tank Closure Alternative 6A Base Case, represented in Figure D-10, all waste streams, including those from clean closure of the SSTs, would be managed as IHLW glass. Under the Tank Closure Alternative 6A Option Case, the six sets of contiguous cribs and trenches (ditches) described in Section D.1.5 (the B Cribs; BX Trenches; BY Cribs; T Cribs; T Trenches and TX Trenches [considered to be one set]; and TY Cribs) would be added to the 6A Base Case inventory. Material balance summaries for these two cases are presented in Tables D-51 through D-54.

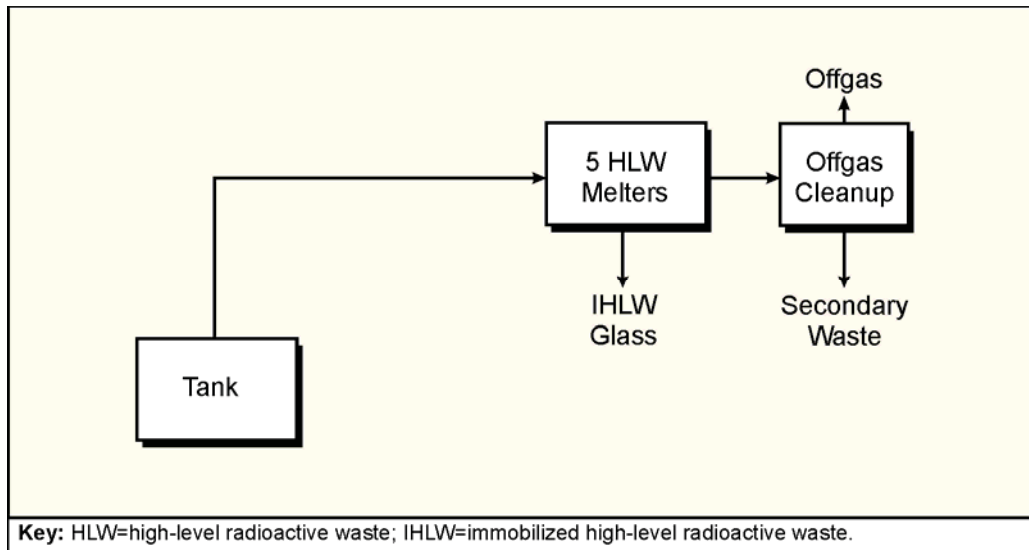

Figure D-10. Tank Closure Alternative 6A Flowsheet

Under the Tank Closure Alternative 6B Base Case, represented in Figure D-11, all waste streams, including those resulting from clean closure of the SSTs, would be managed as IHLW glass. Under the Tank Closure Alternative 6B Option Case, the six sets of contiguous cribs and trenches (ditches) described in Section D.1.5 would be added to the 6B Base Case inventory. Material balance summaries for these two cases are presented in Tables D-55 through D-58. However, Tank Closure Alternative 6B would treat the tank waste in a shorter period of time than Tank Closure Alternative 6A due to the use of LAW melters. The ILAW glass would be managed as IHLW glass.

Under the Tank Closure Alternative 6A and 6B Base Cases (see Figure D-12 for a simplified flowsheet and Tables D-59 and D-60 for inventories), all 12 SST farms would undergo clean closure. Tank residual waste, materials, and highly contaminated rubble, soil, and equipment from tank and ancillary equipment removal activities would be packaged in shielded boxes, stored on site, and managed as IHLW glass. This waste represents 95 percent of the radioactive and chemical constituent inventory remaining in the tanks and the contaminated rubble, soils, and ancillary equipment resulting from leaks associated with waste retrieval. The waste would be managed and stored as IHLW in shielded containers on site. Only 5 percent of the inventory would be packaged and sent directly to the RPPDF.

Table D-51. Tank Closure Alternative 6A, Base Case: Radiological Constituents of Potential Concern Balance

| | Iodine-129 | | Cesium-137 | | Carbon-14 | | Hydrogen-3 (Tritium) | | Uranium-233, -234, -235, -238 | | Neptunium-237 | | Plutonium -239, -240 | | Strontium-90 | | Technetium-99 | | |
|---|----------------------------|--------------|----------------------------|--------------|----------------------------|------------|----------------------------|------------|-------------------------------|--------------|----------------------------|--------------|----------------------------|--------------|----------------------------|--------------|----------------------------|--------------|--|
| | Curies | % of BBI | Curies | % of BBI | Curies | % of BBI | Curies | % of BBI | Curies | % of BBI | Curies | % of BBI | Curies | % of BBI | Curies | % of BBI | Curies | % of BBI | |
| Best-Basis Inventory | | | | | | | | | | | | | | | | | | | |
| BBI ^a | 4.82×10 ¹ | N/A | 4.58×10 ⁷ | N/A | 3.12×10 ³ | N/A | 1.21×10 ⁴ | N/A | 9.38×10 ² | N/A | 1.41×10 ² | N/A | 8.14×10 ⁴ | N/A | 5.05×10 ⁷ | N/A | 2.97×10 ⁴ | N/A | |
| Tank Closure Waste Inventory | | | | | | | | | | | | | | | | | | | |
| Tank residual waste ^b | 4.82×10 ⁻² | 0.1 | 4.58×10 ⁴ | 0.1 | 3.12 | 0.1 | 1.21×10 ¹ | 0.1 | 9.38×10 ⁻¹ | 0.1 | 1.41×10 ⁻¹ | 0.1 | 8.14×10 ¹ | 0.1 | 5.05×10 ⁴ | 0.1 | 2.97×10 ¹ | 0.1 | |
| IHLW glass ^c | 9.64 | 20.0 | 4.57×10 ⁷ | 99.7 | 0 | 0.0 | 0 | 0.0 | 9.36×10 ² | 99.8 | 1.41×10 ² | 99.9 | 8.14×10 ⁴ | 99.9 | 4.98×10 ⁷ | 98.5 | 2.96×10 ⁴ | 99.6 | |
| ETF-generated solid secondary waste ^d | 3.39×10 ¹ | 70.3 | 4.63×10 ⁻¹ | 0.0 | 8.58 | 0.3 | 0 | 0.0 | 4.06×10 ⁻² | 0.0 | 5.16×10 ⁻² | 0.0 | 6.96×10 ⁻⁴ | 0.0 | 6.48 | 0.0 | 8.70×10 ¹ | 0.3 | |
| Solid secondary waste ^e | 4.69 | 9.7 | 1.97×10 ⁵ | 0.4 | 0 | 0.0 | 0 | 0.0 | 3.68 | 0.4 | 2.85×10 ⁻¹ | 0.2 | 2.00×10 ⁻² | 0.2 | 7.83×10 ⁵ | 1.6 | 4.35×10 ² | 1.5 | |
| Total^f | 4.83×10¹ | 100.2 | 4.60×10⁷ | 100.2 | 1.17×10¹ | 0.4 | 1.21×10¹ | 0.1 | 9.41×10² | 100.3 | 1.41×10² | 100.2 | 8.16×10⁴ | 100.2 | 5.06×10⁷ | 100.1 | 3.01×10⁴ | 101.5 | |
| Other Inventory | | | | | | | | | | | | | | | | | | | |
| Solid and liquid secondary waste from cesium and strontium capsules | 0 | N/A | 1.99×10 ⁵ | N/A | 0 | N/A | 0 | N/A | 0 | N/A | 0 | N/A | 0 | N/A | 3.16×10 ⁵ | N/A | 0 | N/A | |
| Cesium and strontium capsules ^g | 0 | N/A | 4.59×10 ⁷ | N/A | 0 | N/A | 0 | N/A | 0 | N/A | 0 | N/A | 0 | N/A | 1.98×10 ⁷ | N/A | 0 | N/A | |
| PPF glass and retired PPF melters ^h | 6.28×10 ⁻² | N/A | 2.71×10 ⁵ | N/A | 0 | N/A | 0 | N/A | 9.30 | N/A | 6.37×10 ⁻¹ | N/A | 3.83×10 ¹ | N/A | 6.86×10 ⁴ | N/A | 1.61×10 ² | N/A | |
| Air Emissions | | | | | | | | | | | | | | | | | | | |
| Treatment air emissions ⁱ | 4.85×10 ¹ | N/A | 8.02×10 ⁴ | N/A | 3.14×10 ³ | N/A | 1.22×10 ⁴ | N/A | 4.74×10 ¹ | N/A | 7.09×10 ⁻² | N/A | 4.07×10 ¹ | N/A | 3.62×10 ⁴ | N/A | 1.49×10 ¹ | N/A | |

a Source of BBI is DOE-ORP-2003-02, Rev. 0, *Inventory and Source Term Data Package* (DOE 2003a).
 b Represents 99.9 percent retrieval. For analysis purposes, waste inventories from tank waste retrieval leaks and ancillary equipment were assumed to be treated in the Waste Treatment Plant and via supplemental treatment processes.
 c To be stored on site until disposition decisions are made and implemented. The inventory would include the retired HLW melters.
 d Includes secondary liquids that would be sent to the ETF and treated; solids would be disposed of in an Integrated Disposal Facility. Excludes liquid secondary waste from the processing of cesium and strontium capsules, which would be reported separately.
 e Includes solid low-level radioactive waste and mixed low-level radioactive waste streams that would be generated by waste treatment operations. Such waste streams would include debris waste, melter consumables, failed process components, analytical laboratory waste, spent resins, spent carbon adsorbent, high-efficiency particulate air filters, and other process-related waste. Excludes contaminated liquid effluent waste streams, which would be treated at the ETF.
 f Totals may exceed 100 percent due to conservative estimates or rounded numbers. BBI percentages were rounded to the nearest tenth. Carbon-14 and hydrogen-3 (tritium) may not total 100 percent; a portion of each would be released to the offgas streams and stack, and a portion (ETF-generated liquid) would be disposed of in the State-Approved Land Disposal Site.
 g To be treated in the Waste Treatment Plant, resulting in glass waste, which would be stored on site until disposition decisions are made and implemented.
 h Derived from clean closure of all single-shell tank farms. Disposal of PPF glass and retired PPF melters would take place in an Integrated Disposal Facility.
 i Includes air emissions from all waste treatment processes, including those from treatment of the cesium and strontium capsules. For analysis purposes, both iodine-129 capture and air emission releases were assumed.
Key: %=percent; BBI=Best-Basis Inventory; ETF=Effluent Treatment Facility; HLW=high-level radioactive waste; IHLW=immobilized high-level radioactive waste; N/A=not applicable; PPF=Preprocessing Facility.
Source: SAIC 2007g, 2007h, 2008a.

Table D-52. Tank Closure Alternative 6A, Base Case: Chemical Constituents of Potential Concern Balance

| | Chromium | | Mercury | | Nitrate | | Lead | | Total Uranium | | Acetonitrile | | Benzene | | Butanol | | PCBs | | 2,4,6-TCP | |
|---|----------------------------|--------------|----------------------------|-------------|----------------------------|-------------|----------------------------|--------------|----------------------------|--------------|----------------------------|------------|-----------------------------|------------|----------------------------|------------|-----------------------|------------|-----------------------------|------------|
| | Kg | % of BBI | Kg | % of BBI | Kg | % of BBI | Kg | % of BBI | Kg | % of BBI | Kg | % of BBI | Kg | % of BBI | Kg | % of BBI | Kg | % of BBI | Kg | % of BBI |
| Best-Basis Inventory | 5.98×10 ⁵ | N/A | 1.83×10 ³ | N/A | 7.08×10 ⁷ | N/A | 8.41×10 ⁴ | N/A | 5.97×10 ⁵ | N/A | 2.95×10 ⁴ | N/A | 2.40 | N/A | 3.45×10 ⁶ | N/A | 1.68×10 ³ | N/A | 1.11 | N/A |
| Tank Closure Waste Inventory | | | | | | | | | | | | | | | | | | | | |
| Tank residual waste ^b | 5.98×10 ² | 0.1 | 1.83 | 0.1 | 7.08×10 ⁴ | 0.1 | 8.41×10 ¹ | 0.1 | 5.97×10 ² | 0.1 | 2.95×10 ¹ | 0.1 | 2.40×10 ⁻³ | 0.1 | 3.45×10 ³ | 0.1 | 1.68 | 0.1 | 1.11×10 ⁻³ | 0.1 |
| IHLW glass ^c | 5.96×10 ⁵ | 99.7 | 0 | 0.0 | 0 | 0.0 | 8.42×10 ⁴ | 100.1 | 5.95×10 ⁵ | 99.7 | 0 | 0.0 | 0 | 0.0 | 0 | 0.0 | 0 | 0.0 | 0 | 0.0 |
| ETF-generated solid secondary waste ^d | 4.47×10 ¹ | 0.0 | 5.60 | 0.3 | 9.10×10 ⁶ | 12.8 | 4.62 | 0.0 | 4.04×10 ¹ | 0.0 | NR | N/A | NR | N/A | NR | N/A | NR | N/A | NR | N/A |
| Solid secondary waste ^e | 1.96×10 ³ | 0.3 | 1.78×10 ³ | 97.3 | 0 | 0.0 | 2.49×10 ² | 0.3 | 2.34×10 ³ | 0.4 | NR | N/A | NR | N/A | NR | N/A | NR | N/A | NR | N/A |
| Total^f | 5.99×10⁵ | 100.1 | 1.78×10³ | 97.7 | 9.17×10⁶ | 12.9 | 8.45×10⁴ | 100.5 | 5.98×10⁵ | 100.2 | 2.95×10¹ | 0.1 | 2.40×10⁻³ | 0.1 | 3.45×10³ | 0.1 | 1.68 | 0.1 | 1.11×10⁻³ | 0.1 |
| Other Inventory^g | | | | | | | | | | | | | | | | | | | | |
| PPF glass and PPF retired melter ^h | 1.03×10 ⁴ | N/A | 0 | N/A | 0 | N/A | 2.61×10 ² | N/A | 7.43×10 ² | N/A | 0 | N/A | 0 | N/A | 0 | N/A | 0 | N/A | 0 | N/A |
| PPF secondary waste ⁱ and rubble, soil, and equipment ^j | 4.23×10 ³ | N/A | 4.37 | N/A | 3.50×10 ⁵ | N/A | 3.40×10 ² | N/A | 1.07×10 ⁴ | N/A | 1.47 | N/A | 1.20×10 ⁻⁴ | N/A | 8.05×10 ² | N/A | 2.82×10 ⁻¹ | N/A | 5.54×10 ⁻⁵ | N/A |
| Air Emissions | | | | | | | | | | | | | | | | | | | | |
| Treatment air emissions ^k | NR | N/A | 2.02×10 ³ | N/A | NR | N/A | NR | N/A | NR | N/A | NR | N/A | N/A | N/A | NR | N/A | NR | N/A | NR | N/A |

a Source of BBI is DOE-ORP-2003-02, Rev. 0, *Inventory and Source Term Data Package* (DOE 2003a).
 b Represents 99.9 percent retrieval. For analysis purposes, waste inventories from tank waste retrieval leaks and ancillary equipment were assumed to be treated in the Waste Treatment Plant and via supplemental treatment processes.
 c To be stored on site until disposition decisions are made and implemented. The inventory would include the retired HLW melter.
 d Includes secondary liquids that would be sent to the ETF and treated; solids would be disposed of in an Integrated Disposal Facility.
 e Includes solid low-level radioactive waste and mixed low-level radioactive waste streams that would be generated by the waste treatment operations. Such waste streams would include debris waste, melter consumables, failed process components, analytical laboratory waste, spent resins, spent carbon adsorbent, high-efficiency particulate air filters, and other process-related waste. Excludes contaminated liquid effluent waste streams, which would be treated at the ETF.
 f Totals may exceed 100 percent due to conservative estimates or rounded numbers. BBI percentages were rounded to the nearest tenth. The organic chemicals (acetonitrile, benzene, butanol, polychlorinated biphenyls, and 2,4,6-trichlorophenol) may not total 100 percent because they would be destroyed during thermal treatment processes. Nitrate may not total 100 percent because it would be volatilized and released through the facility stack.
 g No chemical constituents of potential concern have been reported in the cesium and strontium capsule secondary waste streams.
 h Derived from clean closure of all single-shell tank farms. Disposal of PPF glass and retired PPF melter would take place in an Integrated Disposal Facility.
 i Includes the mixed low-level radioactive waste secondary stream generated by the PPF and the solid waste generated from treating PPF liquid and solid secondary waste. Disposal would take place in the River Protection Project Disposal Facility.
 j Rubble, soil, and equipment would be generated by clean closure of all single-shell tank farms. Disposal would take place in the River Protection Project Disposal Facility.
 k Includes air emissions from all waste treatment processes, including those from treatment of the cesium and strontium capsules. For analysis purposes, both mercury capture and air emission releases were assumed.
Key: %=percent; 2,4,6-TCP=2,4,6-trichlorophenol; BBI=Best-Basis Inventory; butanol=n-butyl alcohol; ETF=Effluent Treatment Facility; HLW=high-level radioactive waste; IHLW=immobilized high-level radioactive waste; kg=kilograms; N/A=not applicable; NR=not reported; PCBs=polychlorinated biphenyls; PPF=Preprocessing Facility.
Source: SAIC 2007g, 2007i, 2008a.

Table D-53. Tank Closure Alternative 6A, Option Case: Radiological Constituents of Potential Concern Balance

| | Iodine-129 | | Cesium-137 | | Carbon-14 | | Hydrogen-3 (Tritium) | | Uranium-233, -234, -235, -238 | | Neptunium-237 | | Plutonium -239, -240 | | Strontium-90 | | Technetium-99 | | |
|---|----------------------------|--------------|----------------------------|--------------|----------------------------|------------|----------------------------|------------|-------------------------------|--------------|----------------------------|--------------|----------------------------|--------------|----------------------------|--------------|----------------------------|--------------|--|
| | Curies | % of BBI | Curies | % of BBI | Curies | % of BBI | Curies | % of BBI | Curies | % of BBI | Curies | % of BBI | Curies | % of BBI | Curies | % of BBI | Curies | % of BBI | |
| Best-Basis Inventory | | | | | | | | | | | | | | | | | | | |
| BBI ^a | 4.82×10 ¹ | N/A | 4.58×10 ⁷ | N/A | 3.12×10 ³ | N/A | 1.21×10 ⁴ | N/A | 9.38×10 ² | N/A | 1.41×10 ² | N/A | 8.14×10 ⁴ | N/A | 5.05×10 ⁷ | N/A | 2.97×10 ⁴ | N/A | |
| Tank Closure Waste Inventory | | | | | | | | | | | | | | | | | | | |
| Tank residual waste ^b | 4.82×10 ⁻² | 0.1 | 4.58×10 ⁴ | 0.1 | 3.12 | 0.1 | 1.21×10 ¹ | 0.1 | 9.38×10 ⁻¹ | 0.1 | 1.41×10 ⁻¹ | 0.1 | 8.14×10 ¹ | 0.1 | 5.05×10 ⁴ | 0.1 | 2.97×10 ¹ | 0.1 | |
| IHLW glass ^c | 9.64 | 20.0 | 4.57×10 ⁷ | 99.7 | 0 | 0.0 | 0 | 0.0 | 9.36×10 ² | 99.8 | 1.41×10 ² | 99.9 | 8.14×10 ⁴ | 99.9 | 4.98×10 ⁷ | 98.5 | 2.96×10 ⁴ | 99.6 | |
| ETF-generated solid secondary waste ^d | 3.39×10 ¹ | 70.3 | 4.63×10 ⁻¹ | 0.0 | 8.58 | 0.3 | 0 | 0.0 | 4.06×10 ⁻² | 0.0 | 5.16×10 ⁻² | 0.0 | 6.96×10 ⁻⁴ | 0.0 | 6.48 | 0.0 | 8.70×10 ¹ | 0.3 | |
| Solid secondary waste ^e | 4.69 | 9.7 | 1.97×10 ⁵ | 0.4 | 0 | 0.0 | 0 | 0.0 | 3.68 | 0.4 | 2.85×10 ⁻¹ | 0.2 | 2.00×10 ⁻² | 0.2 | 7.83×10 ⁵ | 1.6 | 4.35×10 ² | 1.5 | |
| Total^f | 4.83×10¹ | 100.2 | 4.60×10⁷ | 100.2 | 1.17×10¹ | 0.4 | 1.21×10¹ | 0.1 | 9.41×10² | 100.3 | 1.41×10² | 100.2 | 8.16×10⁴ | 100.2 | 5.06×10⁷ | 100.1 | 3.01×10⁴ | 101.5 | |
| Other Inventory | | | | | | | | | | | | | | | | | | | |
| Solid and liquid secondary waste from cesium and strontium capsules | 0 | N/A | 1.99×10 ⁵ | N/A | 0 | N/A | 0 | N/A | 0 | N/A | 0 | N/A | 0 | N/A | 3.16×10 ⁵ | N/A | 0 | N/A | |
| Cesium and strontium capsules ^g | 0 | N/A | 4.59×10 ⁷ | N/A | 0 | N/A | 0 | N/A | 0 | N/A | 0 | N/A | 0 | N/A | 1.98×10 ⁷ | N/A | 0 | N/A | |
| PPF glass and retired PPF melter ^h | 1.07×10 ¹ | N/A | 2.72×10 ⁵ | N/A | 0 | N/A | 0 | N/A | 1.51×10 ¹ | N/A | 2.05 | N/A | 6.40×10 ² | N/A | 7.48×10 ⁴ | N/A | 2.94×10 ² | N/A | |
| Air Emissions | | | | | | | | | | | | | | | | | | | |
| Treatment air emissions ⁱ | 4.86×10 ¹ | N/A | 8.02×10 ⁴ | N/A | 3.15×10 ³ | N/A | 1.49×10 ⁴ | N/A | 7.32×10 ⁻¹ | N/A | 7.12×10 ⁻² | N/A | 4.09×10 ¹ | N/A | 3.62×10 ⁴ | N/A | 1.50×10 ¹ | N/A | |

a Source of BBI is DOE-ORP-2003-02, Rev. 0, *Inventory and Source Term Data Package* (DOE 2003a).
 b Represents 99.9 percent retrieval. For analysis purposes, waste inventories from tank waste retrieval leaks and ancillary equipment were assumed to be treated in the Waste Treatment Plant.
 c To be stored on site until disposition decisions are made and implemented. The inventory would include the retired HLW melter.
 d Includes secondary liquids that would be sent to the ETF and treated; solids would be disposed of in an Integrated Disposal Facility. Excludes liquid secondary waste from the processing of cesium and strontium capsules, which would be reported separately.
 e Includes solid low-level radioactive waste and mixed low-level radioactive waste streams that would be generated by waste treatment operations. Such waste streams would include debris waste, melter consumables, failed process components, analytical laboratory waste, spent resins, spent carbon adsorbent, high-efficiency particulate air filters, and other process-related waste. Excludes contaminated liquid effluent waste streams, which would be treated at the ETF.
 f Totals may exceed 100 percent due to conservative estimates or rounded numbers. BBI percentages were rounded to the nearest tenth. Carbon-14 and hydrogen-3 (tritium) may not total 100 percent because a portion of each would be released to the offgas streams and stack, and a portion (ETF-generated liquid) would be disposed of in the State-Approved Land Disposal Site.
 g To be treated in the Waste Treatment Plant, resulting in glass waste, which would be stored on site until disposition decisions are made and implemented.
 h Derived from clean closure of all single-shell tank farms. Disposal of PPF glass and retired PPF melter would take place in an Integrated Disposal Facility.
 i Includes air emissions from all waste treatment processes, including those from treatment of the cesium and strontium capsules. For analysis purposes, both iodine-129 capture and air emission releases were assumed.
Key: %=percent; BBI=Best-Basis Inventory; ETF=Effluent Treatment Facility; HLW=high-level radioactive waste; IHLW=immobilized high-level radioactive waste; N/A=not applicable; PPF=Preprocessing Facility.
Source: SAIC 2007g, 2007h, 2008a.

Table D-54. Tank Closure Alternative 6A, Option Case: Chemical Constituents of Potential Concern Balance

| | Chromium | | Mercury | | Nitrate | | Lead | | Total Uranium | | Acetonitrile | | Benzene | | Butanol | | PCBs | | 2,4,6-TCP | | |
|---|----------------------------|--------------|----------------------------|-------------|----------------------------|-------------|----------------------------|--------------|----------------------------|--------------|----------------------------|------------|-----------------------------|------------|----------------------------|------------|-----------------------|------------|-----------------------------|------------|--|
| | Kg | % of BBI | Kg | % of BBI | Kg | % of BBI | Kg | % of BBI | Kg | % of BBI | Kg | % of BBI | Kg | % of BBI | Kg | % of BBI | Kg | % of BBI | Kg | % of BBI | |
| Best-Basis Inventory | 5.98×10 ⁵ | N/A | 1.83×10 ³ | N/A | 7.08×10 ⁷ | N/A | 8.41×10 ⁴ | N/A | 5.97×10 ⁵ | N/A | 2.95×10 ⁴ | N/A | 2.40 | N/A | 3.45×10 ⁶ | N/A | 1.68×10 ³ | N/A | 1.11 | N/A | |
| Tank Closure Waste Inventory | | | | | | | | | | | | | | | | | | | | | |
| Tank residual waste ^b | 5.98×10 ² | 0.1 | 1.83 | 0.1 | 7.08×10 ⁴ | 0.1 | 8.41×10 ¹ | 0.1 | 5.97×10 ² | 0.1 | 2.95×10 ¹ | 0.1 | 2.40×10 ⁻³ | 0.1 | 3.45×10 ³ | 0.1 | 1.68 | 0.1 | 1.11×10 ⁻³ | 0.1 | |
| IHLW glass ^c | 5.96×10 ⁵ | 99.7 | 0 | 0.0 | 0 | 0.0 | 8.42×10 ⁴ | 100.1 | 5.95×10 ⁵ | 99.7 | 0 | 0.0 | 0 | 0.0 | 0 | 0.0 | 0 | 0.0 | 0 | 0.0 | |
| ETF-generated solid secondary waste ^d | 4.47×10 ¹ | 0.0 | 5.60 | 0.3 | 9.10×10 ⁶ | 12.8 | 4.62 | 0.0 | 4.04×10 ¹ | 0.0 | NR | N/A | NR | N/A | NR | N/A | NR | N/A | NR | N/A | |
| Solid secondary waste ^e | 1.96×10 ³ | 0.3 | 1.78×10 ³ | 97.3 | 0 | 0.0 | 2.49×10 ² | 0.3 | 2.34×10 ³ | 0.4 | NR | N/A | NR | N/A | NR | N/A | NR | N/A | NR | N/A | |
| Total^f | 5.99×10⁵ | 100.1 | 1.78×10³ | 97.7 | 9.17×10⁶ | 12.9 | 8.45×10⁴ | 100.5 | 5.98×10⁵ | 100.2 | 2.95×10¹ | 0.1 | 2.40×10⁻³ | 0.1 | 3.45×10³ | 0.1 | 1.68 | 0.1 | 1.11×10⁻³ | 0.1 | |
| Other Inventory^g | | | | | | | | | | | | | | | | | | | | | |
| PPF glass and PPF retired melter ^h | 9.16×10 ⁴ | N/A | 0 | N/A | 0 | N/A | 2.76×10 ² | N/A | 4.65×10 ³ | N/A | 0 | N/A | 0 | N/A | 0 | N/A | 0 | N/A | 0 | N/A | |
| PPF secondary waste ⁱ , and rubble, soil, and equipment ^j | 3.73×10 ⁴ | N/A | 5.04×10 ¹ | N/A | 1.37×10 ⁷ | N/A | 3.51×10 ² | N/A | 1.23×10 ⁴ | N/A | 1.47 | N/A | 1.20×10 ⁻⁴ | N/A | 8.05×10 ² | N/A | 2.82×10 ⁻¹ | N/A | 5.54×10 ⁻⁵ | N/A | |
| Air Emissions | | | | | | | | | | | | | | | | | | | | | |
| Treatment air emissions ^k | NR | N/A | 2.02×10 ³ | N/A | NR | N/A | NR | N/A | NR | N/A | NR | N/A | NR | N/A | NR | N/A | NR | N/A | NR | N/A | |

a Source of BBI is DOE-ORP-2003-02, Rev. 0, *Inventory and Source Term Data Package* (DOE 2003a).
 b Represents 99.9 percent retrieval. For analysis purposes, waste inventories from tank waste retrieval leaks and ancillary equipment were assumed to be treated in the Waste Treatment Plant.
 c To be stored on site until disposition decisions are made and implemented. The inventory would include the retired HLW melter.
 d Includes secondary liquids that would be sent to the ETF and treated; solids would be disposed of in an Integrated Disposal Facility.
 e Includes solid low-level radioactive waste and mixed low-level radioactive waste streams that would be generated by the waste treatment operations. Such waste streams would include debris waste, melter consumables, failed process components, analytical laboratory waste, spent resins, spent carbon adsorbent, high-efficiency particulate air filters, and other process-related waste. Excludes contaminated liquid effluent waste streams, which would be treated at the ETF.
 f Totals may exceed 100 percent due to conservative estimates or rounded numbers. BBI percentages were rounded to the nearest tenth. The organic chemicals (acetonitrile, benzene, butanol, polychlorinated biphenyls, and 2,4,6-trichlorophenol) may not total 100 percent because they would be destroyed during thermal treatment processes. Nitrate may not total 100 percent because it would be volatilized and released through the facility stack.
 g No chemical constituents of potential concern have been reported in the cesium and strontium capsule secondary waste streams.
 h Derived from clean closure of all single-shell tank farms and the six sets of contiguous cribs and trenches (ditches). Disposal of PPF glass and retired PPF melter would take place in an Integrated Disposal Facility.
 i Includes the mixed low-level radioactive waste secondary solid stream generated by the PPF and the solid waste generated from treating PPF liquid and solid secondary waste. Disposal would take place in the River Protection Project Disposal Facility.
 j Rubble, soil, and equipment would be generated by clean closure of all single-shell tank farms and six sets of contiguous cribs and trenches (ditches).
 k Includes air emissions from all waste treatment processes, including those from treatment of the cesium and strontium capsules. Disposal would take place in the River Protection Project Disposal Facility. For analysis purposes, both mercury capture and air emission releases were assumed.

Key: %-percent; 2,4,6-TCP=2,4,6-trichlorophenol; BBI=Best-Basis Inventory; butanol=n-butyl alcohol; ETF=Effluent Treatment Facility; HLW=high-level radioactive waste; IHLW=immobilized high-level radioactive waste; kg=kilograms; N/A=not applicable; NR=not reported; PCBs=polychlorinated biphenyls; PPF=Preprocessing Facility.
Source: SAIC 2007g, 2007i, 2008a.

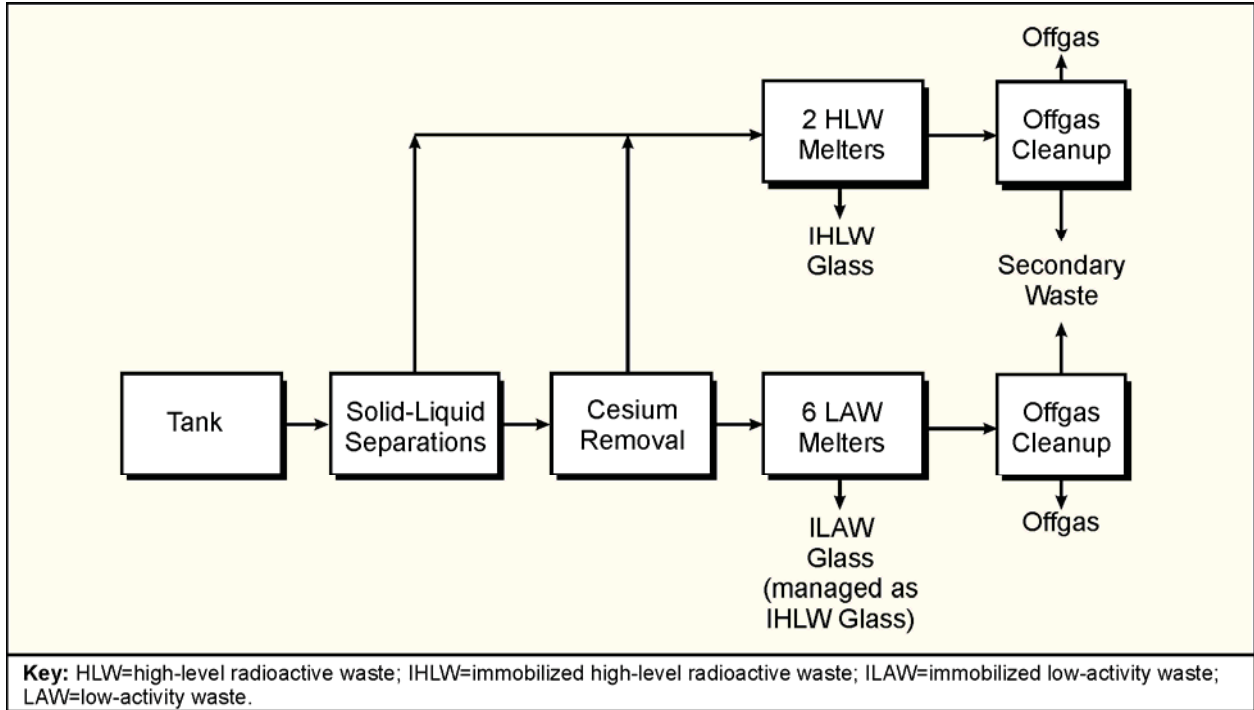

Figure D-11. Tank Closure Alternative 6B or 6C Flowsheet

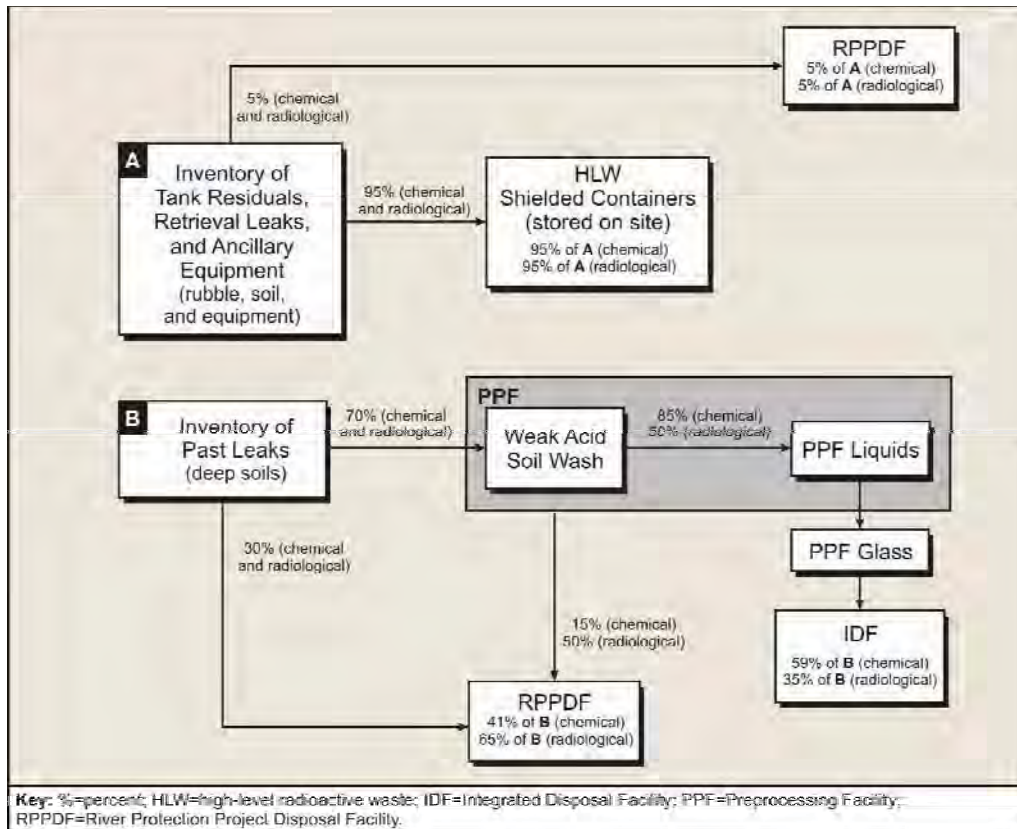

Figure D-12. Tank Closure Alternatives 6A and 6B, Base Cases: Clean Closure of Single-Shell Tank Farms Flowsheet

Table D-55. Tank Closure Alternative 6B, Base Case: Radiological Constituents of Potential Concern Balance

| | Iodine-129 | | Cesium-137 | | Carbon-14 | | Hydrogen-3 (Tritium) | | Uranium-233, -234, -235, -238 | | Neptunium-237 | | Plutonium -239, -240 | | Strontium-90 | | Technetium-99 | | |
|---|----------------------------|--------------|----------------------------|--------------|----------------------------|------------|----------------------------|------------|-------------------------------|--------------|----------------------------|--------------|----------------------------|--------------|----------------------------|--------------|----------------------------|--------------|--------------|
| | Curies | % of BBI | Curies | % of BBI | Curies | % of BBI | Curies | % of BBI | Curies | % of BBI | Curies | % of BBI | Curies | % of BBI | Curies | % of BBI | Curies | % of BBI | |
| Best-Basis Inventory | | | | | | | | | | | | | | | | | | | |
| BBI ^a | 4.82×10 ¹ | N/A | 4.58×10 ⁷ | N/A | 3.12×10 ³ | N/A | 1.21×10 ⁴ | N/A | 9.38×10 ² | N/A | 1.41×10 ² | N/A | 8.14×10 ⁴ | N/A | 5.05×10 ⁷ | N/A | 2.97×10 ⁴ | N/A | N/A |
| Tank Closure Waste Inventory | | | | | | | | | | | | | | | | | | | |
| Tank residual waste ^b | 4.82×10 ⁻² | 0.1 | 4.58×10 ⁴ | 0.1 | 3.12 | 0.1 | 1.21×10 ¹ | 0.1 | 9.38×10 ⁻¹ | 0.1 | 1.41×10 ⁻¹ | 0.1 | 8.14×10 ¹ | 0.1 | 5.05×10 ⁴ | 0.1 | 2.97×10 ¹ | 0.1 | 0.1 |
| IHLW glass ^c | 7.05×10 ⁻³ | 0.0 | 4.53×10 ⁷ | 98.7 | 0 | 0.0 | 0 | 0.0 | 8.81×10 ² | 93.9 | 1.41×10 ² | 99.9 | 8.14×10 ⁴ | 99.9 | 4.97×10 ⁷ | 98.5 | 2.49×10 ² | 0.8 | 0.8 |
| ILAW glass and retired LAW melter ^d | 9.65 | 20.0 | 4.49×10 ⁵ | 1.0 | 0 | 0.0 | 0 | 0.0 | 5.52×10 ¹ | 5.9 | 8.43×10 ⁻³ | 0.0 | 1.47 | 0.0 | 2.33×10 ³ | 0.0 | 2.91×10 ⁴ | 97.8 | 97.8 |
| ETF-generated solid secondary waste ^e | 3.39×10 ¹ | 70.3 | 4.63×10 ⁻¹ | 0.0 | 8.58 | 0.3 | 0 | 0.0 | 4.06×10 ⁻² | 0.0 | 5.16×10 ⁻² | 0.0 | 6.96×10 ⁻⁴ | 0.0 | 6.48 | 0.0 | 8.70×10 ¹ | 0.3 | 0.3 |
| Solid secondary waste ^f | 4.69 | 9.7 | 1.97×10 ⁵ | 0.4 | 0 | 0.0 | 0 | 0.0 | 3.68 | 0.4 | 2.85×10 ⁻¹ | 0.2 | 2.00×10 ² | 0.2 | 7.83×10 ⁵ | 1.6 | 4.35×10 ² | 1.5 | 1.5 |
| Totals^g | 4.83×10¹ | 100.2 | 4.60×10⁷ | 100.2 | 1.17×10¹ | 0.4 | 1.21×10¹ | 0.1 | 9.41×10² | 100.3 | 1.41×10² | 100.2 | 8.16×10⁴ | 100.2 | 5.06×10⁷ | 100.1 | 2.99×10⁴ | 100.5 | 100.5 |
| Other Inventory | | | | | | | | | | | | | | | | | | | |
| Solid and liquid secondary waste from cesium and strontium capsules | 0 | N/A | 1.99×10 ⁵ | N/A | 0 | N/A | 0 | N/A | 0 | N/A | 0 | N/A | 0 | N/A | 3.16×10 ⁵ | N/A | 0 | N/A | N/A |
| Cesium and strontium capsules ^h | 0 | N/A | 4.59×10 ⁷ | N/A | 0 | N/A | 0 | N/A | 0 | N/A | 0 | N/A | 0 | N/A | 1.98×10 ⁷ | N/A | 0 | N/A | N/A |
| PPF glass and retired PPF melter ⁱ | 6.13×10 ⁻² | N/A | 2.65×10 ⁵ | N/A | 0 | N/A | 0 | N/A | 9.09 | N/A | 6.23×10 ⁻¹ | N/A | 3.74×10 ¹ | N/A | 6.70×10 ⁴ | N/A | 1.57×10 ² | N/A | N/A |
| Air Emissions | | | | | | | | | | | | | | | | | | | |
| Treatment air emissions ^j | 4.85×10 ¹ | N/A | 8.02×10 ⁴ | N/A | 3.15×10 ³ | N/A | 1.22×10 ⁴ | N/A | 4.74×10 ⁻¹ | N/A | 7.09×10 ⁻² | N/A | 4.08×10 ¹ | N/A | 3.62×10 ⁴ | N/A | 1.49×10 ¹ | N/A | N/A |

a Source of BBI is DOE-ORP-2003-02, Rev. 0, *Inventory and Source Term Data Package* (DOE 2003a).
b Represents 99.9 percent retrieval. For analysis purposes, waste inventories from tank waste retrieval leaks and ancillary equipment were assumed to be treated in the Waste Treatment Plant.
c To be stored on site until disposition decisions are made and implemented. The inventory would include the retired HLW melter.
d Although processed as ILAW glass, glass and retired melter waste would be managed and disposed of as IHLW glass.
e Includes secondary liquids that would be sent to the ETF and treated; solids would be disposed of in an Integrated Disposal Facility. Excludes liquid secondary waste from the processing of cesium and strontium capsules, which would be reported separately.
f Includes solid low-level radioactive waste and mixed low-level radioactive waste streams that would be generated by the waste treatment operations. Such waste streams would include debris waste, melter consumables, failed process components, analytical laboratory waste, spent resins, spent carbon adsorbent, high-efficiency particulate air filters, and other process-related waste. Excludes contaminated liquid effluent waste streams, which would be treated at the ETF.
g Totals may exceed 100 percent due to conservative estimates or rounded numbers. BBI percentages were rounded to the nearest tenth. Carbon-14 and hydrogen-3 (tritium) may not total 100 percent because a portion of each would be released to the offgas streams and stack, and a portion (ETF-generated liquid) would be disposed of in the State-Approved Land Disposal Site.
h To be treated in the Waste Treatment Plant, resulting in glass waste, which would be stored on site until disposition decisions are made and implemented.
i Derived from clean closure of all single-shell tank farms and the six sets of contiguous cribs and trenches (ditches). Disposal of PPF glass and retired PPF melter waste would take place in an Integrated Disposal Facility.
j Includes the air emissions from all waste treatment processes, including those from treatment of the cesium and strontium capsules. For analysis purposes, both iodine-129 capture and air emission releases were assumed.
Key: %-percent; BBI=Best-Basis Inventory; ETF=Effluent Treatment Facility; HLW=high-level radioactive waste; IHLW=immobilized high-level radioactive waste; ILAW=immobilized low-activity waste; LAW=low-activity waste; N/A=not applicable; PPF=Preprocessing Facility.
Source: SAIC 2007g, 2007h, 2008a.

Table D-56. Tank Closure Alternative 6B, Base Case: Chemical Constituents of Potential Concern Balance

| | Chromium | | Mercury | | Nitrate | | Lead | | Total Uranium | | Acetonitrile | | Benzene | | Butanol | | PCBs | | 2,4,6-TCP | | |
|--|----------------------|----------|----------------------|----------|----------------------|----------|----------------------|----------|----------------------|----------|----------------------|----------|-----------------------|----------|-----------------------|----------|-----------------------|----------|-----------------------|----------|-----|
| | Kg | % of BBI | Kg | % of BBI | Kg | % of BBI | Kg | % of BBI | Kg | % of BBI | Kg | % of BBI | Kg | % of BBI | Kg | % of BBI | Kg | % of BBI | Kg | % of BBI | |
| Best-Basis Inventory | 5.98×10 ⁵ | N/A | 1.83×10 ³ | N/A | 7.08×10 ⁷ | N/A | 8.41×10 ⁴ | N/A | 5.97×10 ⁵ | N/A | 2.95×10 ⁴ | N/A | 2.40 | N/A | 3.45×10 ⁶ | N/A | 1.68×10 ³ | N/A | 1.11 | N/A | |
| Tank Closure Waste Inventory | | | | | | | | | | | | | | | | | | | | | |
| Tank residual waste ^b | 5.98×10 ² | 0.1 | 1.83 | 0.1 | 7.08×10 ⁴ | 0.1 | 8.41×10 ¹ | 0.1 | 5.97×10 ² | 0.1 | 2.95×10 ¹ | 0.1 | 2.40×10 ⁻³ | 0.1 | 3.45×10 ³ | 0.1 | 1.68 | 0.1 | 1.11×10 ⁻³ | 0.1 | |
| IHLW glass ^c | 1.37×10 ⁵ | 22.9 | 0 | 0.0 | 0 | 0.0 | 7.52×10 ⁴ | 89.4 | 5.57×10 ⁵ | 93.4 | 0 | 0.0 | 0 | 0.0 | 0 | 0.0 | 0 | 0.0 | 0 | 0.0 | |
| ILAW glass and retired LAW melter ^d | 4.60×10 ⁵ | 76.9 | 0 | 0.0 | 0 | 0.0 | 8.96×10 ³ | 10.7 | 3.78×10 ⁴ | 6.3 | 0 | 0.0 | 0 | 0.0 | 0 | 0.0 | 0 | 0.0 | 0 | 0.0 | |
| ETF-generated solid secondary waste ^e | 4.47×10 ¹ | 0.0 | 5.60 | 0.3 | 9.10×10 ⁶ | 12.8 | 4.62 | 0.0 | 4.04×10 ¹ | 0.0 | NR | NR | NR | N/A | NR | N/A | NR | N/A | NR | N/A | |
| Solid secondary waste ^f | 1.96×10 ³ | 0.3 | 1.78×10 ³ | 97.3 | 0 | 0.0 | 2.49×10 ² | 0.3 | 2.34×10 ³ | 0.4 | NR | NR | NR | N/A | NR | N/A | NR | N/A | NR | N/A | |
| Totals | | | | | | | | | | | | | | | | | | | | | |
| Other Inventory^h | | | | | | | | | | | | | | | | | | | | | |
| PPF glass and retired melter ⁱ | 1.00×10 ⁴ | N/A | 0 | N/A | 0 | N/A | 2.55×10 ² | N/A | 7.27×10 ² | N/A | 0 | N/A | 0 | N/A | 0 | N/A | 0 | N/A | 0 | N/A | |
| PPF secondary waste and rubble, soil, and equipment ^k | 4.23×10 ³ | N/A | 4.37 | N/A | 3.50×10 ⁵ | N/A | 3.40×10 ² | N/A | 1.07×10 ⁴ | N/A | 1.47 | N/A | 1.20×10 ⁻⁴ | N/A | 8.05×10 ⁻² | N/A | 2.82×10 ⁻¹ | N/A | 5.54×10 ⁻⁵ | N/A | |
| Air Emissions | | | | | | | | | | | | | | | | | | | | | |
| Treatment air emissions ^l | NR | N/A | 2.00×10 ³ | N/A | NR | N/A | NR | N/A | NR | N/A | NR | NR | NR | N/A | NR | N/A | NR | NR | N/A | NR | N/A |

a Source of BBI is DOE-ORP-2003-02, Rev. 0, *Inventory and Source Term Data Package* (DOE 2003a).

b Represents 99.9 percent retrieval. For analysis purposes, waste inventories from tank waste retrieval leaks and ancillary equipment were assumed to be treated in the Waste Treatment Plant.

c To be stored on site until disposition decisions are made and implemented. The inventory would include the retired HLW melter.

d Although processed as ILAW glass, this waste stream would be managed and disposed of as IHLW glass.

e Includes secondary liquids that would be sent to the ETF and treated; solids would be disposed of in an Integrated Disposal Facility.

f Includes solid low-level radioactive waste and mixed low-level radioactive waste streams that would be generated by the waste treatment operations. Such waste streams would include debris waste, melter consumables, failed process components, analytical laboratory waste, spent resins, spent carbon adsorbent, high-efficiency particulate air filters, and other process-related waste. Excludes contaminated liquid effluent waste streams, which would be treated at the ETF.

g Totals may exceed 100 percent due to conservative estimates or rounded numbers. BBI percentages were rounded to the nearest tenth. The organic chemicals (acetonitrile, benzene, butanol, polychlorinated biphenyls, and 2,4,6-trichlorophenol) may not total 100 percent because they would be destroyed during thermal treatment processes. Nitrate may not total 100 percent because it would be volatilized and released through the facility stack.

h No chemical constituents of potential concern have been reported in the cesium and strontium capsule secondary waste streams.

i Derived from clean closure of all single-shell tank farms and the six sets of contiguous cribs and trenches (ditches). Disposal of PPF glass and retired PPF melter would take place in an Integrated Disposal Facility.

j Includes the mixed low-level radioactive waste secondary stream generated by the PPF and the solid waste generated from treating PPF liquid and solid secondary waste. Disposal would take place in the River Protection Project Disposal Facility.

k Rubble, soil, and equipment would be generated by clean closure of all single-shell tank farms and six sets of contiguous cribs and trenches (ditches). Disposal would take place in the River Protection Project Disposal Facility.

l Includes air emissions from all waste treatment processes, including those from treatment of the cesium and strontium capsules. For analysis purposes, both mercury capture and air emission releases were assumed.

Key: % =percent; 2,4,6-TCP=2,4,6-trichlorophenol; BBI=Best-Basis Inventory; butanol=n-butyl alcohol; ETF=Effluent Treatment Facility; HLW=high-level radioactive waste; IHLW=immobilized high-level radioactive waste; ILAW=immobilized low-activity waste; kg=kilograms; LAW=low-activity waste; N/A=not applicable; NR=not reported; PCBs=polychlorinated biphenyls; PPF=Preprocessing Facility.

Source: SAIC 2007g, 2007i, 2008a.

Table D-57. Tank Closure Alternative 6B, Option Case: Radiological Constituents of Potential Concern Balance

| | Iodine-129 | | Cesium-137 | | Carbon-14 | | Hydrogen-3 (Tritium) | | Uranium-233, -234, -235, -238 | | Neptunium-237 | | Plutonium -239, -240 | | Strontium-90 | | Technetium-99 | | |
|---|-----------------------|----------|-----------------------|----------|----------------------|----------|----------------------|----------|-------------------------------|----------|-----------------------|----------|-----------------------|----------|----------------------|----------|----------------------|----------|--|
| | Curies | % of BBI | Curies | % of BBI | Curies | % of BBI | Curies | % of BBI | Curies | % of BBI | Curies | % of BBI | Curies | % of BBI | Curies | % of BBI | Curies | % of BBI | |
| Best-Basis Inventory | | | | | | | | | | | | | | | | | | | |
| BBI ^a | 4.82×10 ¹ | N/A | 4.58×10 ⁷ | N/A | 3.12×10 ³ | N/A | 1.21×10 ⁴ | N/A | 9.38×10 ² | N/A | 1.41×10 ² | N/A | 8.14×10 ⁴ | N/A | 5.05×10 ⁷ | N/A | 2.97×10 ⁴ | N/A | |
| Tank Closure Waste Inventory | | | | | | | | | | | | | | | | | | | |
| Tank residual waste ^b | 4.82×10 ⁻² | 0.1 | 4.58×10 ⁴ | 0.1 | 3.12 | 0.1 | 1.21×10 ¹ | 0.1 | 9.38×10 ⁻¹ | 0.1 | 1.41×10 ⁻¹ | 0.1 | 8.14×10 ¹ | 0.1 | 5.05×10 ⁴ | 0.1 | 2.97×10 ¹ | 0.1 | |
| IHLW glass ^c | 7.05×10 ⁻³ | 0.0 | 4.53×10 ⁷ | 98.7 | 0 | 0.0 | 0 | 0.0 | 8.81×10 ² | 93.9 | 1.41×10 ² | 99.9 | 8.14×10 ⁴ | 99.9 | 4.97×10 ⁷ | 98.5 | 2.49×10 ² | 0.8 | |
| ILAW glass and retired LAW melter ^d | 9.65 | 20.0 | 4.49×10 ⁵ | 1.0 | 0 | 0.0 | 0 | 0.0 | 5.52×10 ¹ | 5.9 | 8.43×10 ⁻³ | 0.0 | 1.47 | 0.0 | 2.33×10 ³ | 0.0 | 2.91×10 ⁴ | 97.8 | |
| ETF-generated solid secondary waste ^e | 3.39×10 ¹ | 70.3 | 4.63×10 ⁻¹ | 0.0 | 8.58 | 0.3 | 0 | 0.0 | 4.06×10 ⁻² | 0.0 | 5.16×10 ⁻² | 0.0 | 6.96×10 ⁻⁴ | 0.0 | 6.48 | 0.0 | 8.70×10 ¹ | 0.3 | |
| Solid secondary waste ^f | 4.69 | 9.7 | 1.97×10 ⁵ | 0.4 | 0 | 0.0 | 0 | 0.0 | 3.68 | 0.4 | 2.85×10 ⁻¹ | 0.2 | 2.00×10 ² | 0.2 | 7.83×10 ⁵ | 1.6 | 4.35×10 ² | 1.5 | |
| Totals | | | | | | | | | | | | | | | | | | | |
| Other Inventory | | | | | | | | | | | | | | | | | | | |
| Solid and liquid secondary waste from cesium and strontium capsules | 0 | N/A | 1.99×10 ⁵ | N/A | 0 | N/A | 0 | N/A | 0 | N/A | 0 | N/A | 0 | N/A | 3.16×10 ⁵ | N/A | 0 | N/A | |
| Cesium and strontium capsules ^h | 0 | N/A | 4.59×10 ⁷ | N/A | 0 | N/A | 0 | N/A | 0 | N/A | 0 | N/A | 0 | N/A | 1.98×10 ⁷ | N/A | 0 | N/A | |
| PPF glass and retired PPF melter ⁱ | 1.07×10 ⁻¹ | N/A | 2.71×10 ⁵ | N/A | 0 | N/A | 0 | N/A | 1.50×10 ¹ | N/A | 2.04 | N/A | 6.36×10 ² | N/A | 7.45×10 ⁴ | N/A | 2.93×10 ² | N/A | |
| Air Emissions | | | | | | | | | | | | | | | | | | | |
| Treatment air emissions ^j | 4.86×10 ¹ | N/A | 8.02×10 ⁴ | N/A | 3.15×10 ³ | N/A | 1.49×10 ⁴ | N/A | 4.76×10 ¹ | N/A | 7.13×10 ⁻² | N/A | 4.09×10 ¹ | N/A | 3.62×10 ⁴ | N/A | 1.50×10 ¹ | N/A | |

a Source of BBI is DOE-ORP-2003-02, Rev. 0, *Inventory and Source Term Data Package* (DOE 2003a).

b Represents 99.9 percent retrieval. For analysis purposes, waste inventories from tank waste retrieval leaks and ancillary equipment were assumed to be treated in the Waste Treatment Plant.

c To be stored on site until disposition decisions are made and implemented. The inventory would include the retired HLW melter.

d Although processed as ILAW glass, glass and retired melter are managed and disposed of as IHLW glass.

e Includes secondary liquids that would be sent to the ETF and treated; solids would be disposed of in an Integrated Disposal Facility. Excludes liquid secondary waste from the processing of cesium and strontium capsules, would be reported separately.

f Includes solid low-level radioactive waste and mixed low-level radioactive waste streams that would be generated by the waste treatment operations. Such waste streams would include debris waste, melter consumables, failed process components, analytical laboratory waste, spent resins, spent carbon adsorbent, high-efficiency particulate air filters, and other process-related waste. Excludes contaminated liquid effluent waste streams, which would be treated at the ETF.

g Totals may exceed 100 percent due to conservative estimates or rounded numbers. BBI percentages were rounded to the nearest tenth. Carbon-14 and hydrogen-3 (tritium) may not total 100 percent because a portion of each would be released to the offgas streams and stack, and a portion (ETF-generated liquid) would be disposed of in the State-Approved Land Disposal Site.

h To be treated in the Waste Treatment Plant, resulting in glass waste, which would be stored on site until disposition decisions are made and implemented.

i Derived from clean closure of all single-shell tank farms and the six sets of contiguous cribs and trenches (ditches). Disposal of PPF glass and retired PPF melter would take place in an Integrated Disposal Facility.

j Includes the air emissions from all waste treatment processes, including those from treatment of the cesium and strontium capsules. For analysis purposes, both iodine-129 capture and air emission releases were assumed.

Key: %-percent; BBI=Best-Basis Inventory; ETF=Effluent Treatment Facility; HLW=high-level radioactive waste; IHLW=immobilized high-level radioactive waste; ILAW=immobilized low-activity waste; LAW=low-activity waste; N/A=not applicable; PPF=Preprocessing Facility.

Source: SAIC 2007g, 2007h, 2008a.

Table D-58. Tank Closure Alternative 6B, Option Case: Chemical Constituents of Potential Concern Balance

| | Chromium | | Mercury | | Nitrate | | Lead | | Total Uranium | | Acetonitrile | | Benzene | | Butanol | | PCB | | 2,4,6-TCP | | |
|--|----------------------------|--------------|----------------------------|-------------|----------------------------|--------------|----------------------------|--------------|----------------------------|--------------|----------------------------|------------|-----------------------------|------------|----------------------------|------------|-----------------------|------------|-----------------------------|------------|--|
| | Kg | % of BBI | Kg | % of BBI | Kg | % of BBI | Kg | % of BBI | Kg | % of BBI | Kg | % of BBI | Kg | % of BBI | Kg | % of BBI | Kg | % of BBI | Kg | % of BBI | |
| Best-Basis Inventory | 5.98×10 ⁵ | N/A | 1.83×10 ³ | N/A | 7.08×10 ⁷ | N/A | 8.41×10 ⁴ | N/A | 5.97×10 ⁵ | N/A | 2.95×10 ⁴ | N/A | 2.40 | N/A | 3.45×10 ⁶ | N/A | 1.68×10 ³ | N/A | 1.11 | N/A | |
| Tank Closure Waste Inventory | | | | | | | | | | | | | | | | | | | | | |
| Tank residual waste ^b | 5.98×10 ² | 0.1 | 1.83 | 0.1 | 7.08×10 ⁴ | 0.1 | 8.41×10 ¹ | 0.1 | 5.97×10 ² | 0.1 | 2.95×10 ¹ | 0.1 | 2.40×10 ⁻³ | 0.1 | 3.45×10 ³ | 0.1 | 1.68 | 0.1 | 1.11×10 ⁻³ | 0.1 | |
| IHLW glass ^c | 1.37×10 ⁵ | 22.9 | 0 | 0.0 | 0 | 0.0 | 7.52×10 ⁴ | 89.4 | 5.57×10 ⁵ | 93.4 | 0 | 0.0 | 0 | 0.0 | 0 | 0.0 | 0 | 0.0 | 0 | 0.0 | |
| ILAW glass and retired LAW melter ^d | 4.60×10 ⁵ | 76.9 | 0 | 0.0 | 7.06×10 ⁷ | 99.8 | 9.00×10 ³ | 10.7 | 3.79×10 ⁴ | 6.3 | 0 | 0.0 | 0 | 0.0 | 0 | 0.0 | 0 | 0.0 | 0 | 0.0 | |
| ETF-generated solid secondary waste ^e | 4.47×10 ¹ | 0.0 | 5.60 | 0.3 | 9.10×10 ⁶ | 12.8 | 4.62 | 0.0 | 4.04×10 ¹ | 0.0 | NR | N/A | NR | N/A | NR | N/A | NR | N/A | NR | N/A | |
| Solid secondary waste ^f | 1.96×10 ³ | 0.3 | 1.78×10 ³ | 97.3 | 0 | 0.0 | 2.49×10 ² | 0.3 | 2.34×10 ³ | 0.4 | NR | N/A | NR | N/A | NR | N/A | NR | N/A | NR | N/A | |
| Totals^g | 6.00×10⁵ | 100.2 | 1.78×10³ | 97.7 | 7.98×10⁷ | 112.7 | 8.46×10⁴ | 100.5 | 5.98×10⁵ | 100.2 | 2.95×10¹ | 0.1 | 2.40×10⁻³ | 0.1 | 3.45×10³ | 0.1 | 1.68 | 0.1 | 1.11×10⁻³ | 0.1 | |
| Other Inventory^h | | | | | | | | | | | | | | | | | | | | | |
| PPF glass and PPF retired melter ⁱ | 9.11×10 ⁴ | N/A | 0 | N/A | 0 | N/A | 2.75×10 ² | N/A | 4.62×10 ³ | N/A | 0 | N/A | 0 | N/A | 0 | N/A | 0 | N/A | 0 | N/A | |
| PPF secondary waste and rubble, soil, and equipment ^k | 3.73×10 ⁴ | N/A | 5.04×10 ¹ | N/A | 1.37×10 ⁷ | N/A | 3.51×10 ² | N/A | 1.23×10 ⁴ | N/A | 1.47 | N/A | 1.20×10 ⁻⁴ | N/A | 8.05×10 ² | N/A | 2.82×10 ⁻¹ | N/A | 5.54×10 ⁻⁵ | N/A | |
| Air Emissions | | | | | | | | | | | | | | | | | | | | | |
| Treatment air emissions ^l | NR | N/A | 2.00×10 ³ | N/A | NR | N/A | NR | N/A | NR | N/A | NR | N/A | NR | N/A | NR | N/A | NR | N/A | NR | N/A | |

a Source of BBI is DOE-ORP-2003-02, Rev. 0, *Inventory and Source Term Data Package* (DOE 2003a).
 b Represents 99.9 percent retrieval. For analysis purposes, waste inventories from tank waste retrieval leaks and ancillary equipment were assumed to be treated in the Waste Treatment Plant.
 c To be stored on site until disposition decisions are made and implemented. The inventory would include the retired IHLW melter.
 d Although processed as ILAW glass, this waste stream would be managed and disposed of as IHLW glass.
 e Includes secondary liquids that would be sent to the ETF and treated; solids would be disposed of in an Integrated Disposal Facility.
 f Includes solid low-level radioactive waste and mixed low-level radioactive waste streams that would be generated by the waste treatment operations. Such waste streams would include debris waste, melter consumables, failed process components, analytical laboratory waste, spent resins, spent carbon adsorbent, high-efficiency particulate air filters, and other process-related waste. Excludes contaminated liquid effluent waste streams, which would be treated at the ETF.
 g Totals may exceed 100 percent due to conservative estimates or rounded numbers. BBI percentages were rounded to the nearest tenth. The organic chemicals (acetonitrile, benzene, butanol, polychlorinated biphenyls, and 2,4,6-trichlorophenol) may not total 100 percent because they would be destroyed during thermal treatment processes. Nitrate may not total 100 percent because it would be volatilized and released through the facility stack.
 h No chemical constituents of potential concern have been reported in the cesium and strontium capsule secondary waste streams.
 i Derived from clean closure of all single-shell tank farms and the six sets of contiguous cribs and trenches (ditches). Disposal of PPF glass and retired PPF melter would take place in an Integrated Disposal Facility.
 j Includes the mixed low-level radioactive waste secondary solid stream generated by the PPF and the solid waste generated from treating PPF liquid and solid secondary waste. Disposal would take place in the River Protection Project Disposal Facility.
 k Rubble, soil, and equipment would be generated by clean closure of all single-shell tank farms and six sets of contiguous cribs and trenches (ditches). Disposal would take place in the River Protection Project Disposal Facility.
 l Includes the air emissions from all waste treatment processes, including those from treatment of the cesium and strontium capsules. For analysis purposes, both mercury capture and air emission releases were assumed.
Key: % =percent; 2,4,6-TCP=2,4,6-trichlorophenol; BBI=Best-Basis Inventory; butanol=n-butyl alcohol; ETF=Effluent Treatment Facility; HLW=high-level radioactive waste; IHLW=immobilized high-level radioactive waste; ILAW=immobilized low-activity waste; kg=kilograms; LAW=low-activity waste; N/A=not applicable; NR=not reported; PCBs=polychlorinated biphenyls; PPF=Preprocessing Facility.
Source: SAIC 2007g, 2007i, 2008a.

Table D–59. Tank Closure Alternatives 6A and 6B, Base Cases: Radiological Constituents of Potential Concern Inventory from Clean Closure of the SST Farms (curies)

| Analyte | MLLW ^a | PPF Glass ^b |
|-------------------------------|-----------------------|------------------------|
| Hydrogen-3 (tritium) | 2.16×10 ² | 0 |
| Carbon-14 | 2.90×10 ¹ | 0 |
| Strontium-90 | 1.47×10 ⁵ | 6.43×10 ⁴ |
| Technetium-99 | 2.09×10 ² | 1.51×10 ² |
| Iodine-129 | 4.01×10 ⁻¹ | 5.88×10 ⁻² |
| Cesium-137 | 3.75×10 ⁵ | 2.54×10 ⁵ |
| Uranium-233, -234, -235, -238 | 1.34×10 ¹ | 8.72 |
| Neptunium-237 | 7.95×10 ⁻¹ | 5.97×10 ⁻¹ |
| Plutonium-239, -240 | 1.03×10 ² | 3.59×10 ¹ |

^a Represents 5 percent of the ancillary equipment, tank waste retrieval leak, and tank residual waste inventories, as well as 65 percent of the deep soils inventory for the single-shell tank farms. Disposal would take place in the River Protection Project Disposal Facility.

^b Represents 50 percent of the highly contaminated deep soil inventory that would be removed from clean closure of all of the single-shell tank farms and treated in the PPF, resulting in PPF glass. Disposal would take place in an Integrated Disposal Facility.

Key: MLLW=mixed low-level radioactive waste; PPF=Preprocessing Facility; SST=single-shell tank.

Source: SAIC 2007g, 2007j, 2008a.

Table D–60. Tank Closure Alternatives 6A and 6B, Base Cases: Chemical Constituents of Potential Concern Inventory from Clean Closure of the SST Farms (kilograms)

| Analyte | MLLW ^a | PPF Glass ^b |
|---------------------------|-----------------------|------------------------|
| Chromium | 4.20×10 ³ | 9.60×10 ³ |
| Mercury | 2.38 | 0 |
| Nitrate | 2.83×10 ⁵ | 0 |
| Lead | 3.39×10 ² | 2.45×10 ² |
| Total Uranium | 1.07×10 ⁴ | 6.96×10 ² |
| Acetonitrile | 1.47 | 0 |
| Benzene | 1.20×10 ⁻⁴ | 0 |
| Butanol (n-butyl alcohol) | 8.05×10 ² | 0 |
| Polychlorinated biphenyls | 2.82×10 ⁻¹ | 0 |
| 2,4,6-Trichlorophenol | 5.54×10 ⁻⁵ | 0 |

^a Represents 5 percent of the ancillary equipment, tank waste retrieval leak, and tank residual waste inventories and 40.5 percent of the deep soils inventory for the single-shell tank farms. Disposal would take place in the River Protection Project Disposal Facility.

^b Represents 85 percent of the highly contaminated deep soil inventory that would be removed during clean closure of all of the single-shell tank farms and treated in the PPF, resulting in PPF glass. Disposal would take place in an Integrated Disposal Facility.

Key: MLLW=mixed low-level radioactive waste; PPF=Preprocessing Facility; SST=single-shell tank.

Source: SAIC 2007g, 2007i, 2007k, 2008a.

Soils contaminated from past tank leaks would be removed and managed as described above for Tank Closure Alternative 4. Moderately contaminated soil containing 30 percent of the radiological and chemical inventories would be packaged for direct disposal in the RPPDF. Heavily contaminated soil containing 70 percent of the radiological and chemical inventories would be processed through soil washing in the PPF. In the PPF, 85 percent of the chemical constituents and 50 percent of the radioactive constituents would be removed from the soil in a liquid waste stream. This liquid waste stream would be further processed in the PPF into PPF glass for onsite storage in an Integrated Disposal Facility (IDF). This liquid waste stream represents 35 percent of the radioactive constituents and 59 percent of the chemical constituents from past leaks. The remaining inventory of contaminants, 35 percent of the initial contaminated soil radioactive inventory (50 percent of the 70 percent sent to the PPF), and 11 percent of the initial contaminated chemical inventory (15 percent of the 70 percent sent to the PPF) would be managed as MLLW generated by PPF operations. Thus, a total of 65 percent of the inventory of radioactive constituents and 41 percent of the inventory of chemical constituents from past tank leaks would be disposed of in the RPPDF.

The inventories associated with the soil disposed of on site are determined as shown in the following equations.

$$M_{\text{rad}_{\text{soil}}} = 0.65 \times M_{\text{pleak}}$$

$$M_{\text{chem}_{\text{soil}}} = 0.41 \times M_{\text{pleak}}$$

where:

- $M_{\text{rad}_{\text{soil}}}$ = inventory of radioactive constituents in contaminated soil disposed of on site
- $M_{\text{chem}_{\text{soil}}}$ = inventory of chemical constituents in contaminated soil disposed of on site
- M_{pleak} = inventory of radioactive or chemical constituents from past leaks

For the Option Cases under Tank Closure Alternatives 6A and 6B, the soils contaminated from intentional discharges to the six sets of cribs and trenches (ditches) would be added to the inventories from the 12 SST farms. Tables D-61 and D-62 show estimates of radioactive and chemical constituent inventories from clean closure of the SST Farms and the six sets of cribs and trenches (ditches), respectively.

Waste would be treated the same under Tank Closure Alternatives 6B and 6C; however, the SSTs would be landfill-closed, not clean-closed, under Alternative 6C. The process schematic and material balance summaries under Alternative 6C are presented in Figure D-11 and Tables D-63 and D-64.

Table D–61. Tank Closure Alternatives 6A and 6B, Option Cases Radiological Constituents of Potential Concern Inventory from Clean Closure of the Single-Shell Tank Farms and Six Sets of Cribs and Trenches (Ditches) (curies)

| Analyte | MLLW ^a | PPF Glass ^b |
|-------------------------------|-----------------------|------------------------|
| Hydrogen-3 (tritium) | 5.72×10 ³ | 0 |
| Carbon-14 | 4.43×10 ¹ | 0 |
| Strontium-90 | 1.57×10 ⁵ | 7.38×10 ⁴ |
| Technetium-99 | 3.51×10 ² | 2.90×10 ² |
| Iodine-129 | 6.37×10 ⁻¹ | 1.06×10 ⁻¹ |
| Cesium-137 | 3.90×10 ⁵ | 2.69×10 ⁵ |
| Uranium-233, -234, -235, -238 | 1.96×10 ¹ | 1.49×10 ¹ |
| Neptunium-237 | 2.23 | 2.02 |
| Plutonium-239, -240 | 6.96×10 ² | 6.31×10 ² |

^a Represents 5 percent of the ancillary equipment, tank waste retrieval leak, and tank residual waste inventories and 65 percent of the deep soils inventory for the single-shell tank farms and the six sets of contiguous cribs and trenches (ditches). Disposal would take place in the River Protection Project Disposal Facility.

^b Represents 50 percent of the highly contaminated deep soil inventory that would be removed during clean closure of all of the single-shell tank farms and the six sets of contiguous cribs and trenches (ditches) and treated in the PPF, resulting in PPF glass. Disposal would take place in an Integrated Disposal Facility.

Key: MLLW=mixed low-level radioactive waste; PPF=Preprocessing Facility.

Source: SAIC 2007g, 2007i, 2007j, 2008a.

Table D–62. Tank Closure Alternatives 6A and 6B, Option Cases Chemical Constituents of Potential Concern Inventory from Clean Closure of the Single-Shell Tank Farms and Six Sets of Cribs and Trenches (Ditches) (kilograms)

| Analyte | MLLW ^a | PPF Glass ^b |
|---------------------------|-----------------------|------------------------|
| Chromium | 3.70×10 ⁴ | 9.03×10 ⁴ |
| Mercury | 1.59×10 ¹ | 0 |
| Nitrate | 1.04×10 ⁷ | 0 |
| Lead | 3.50×10 ² | 2.73×10 ² |
| Total Uranium | 1.22×10 ⁴ | 4.58×10 ³ |
| Acetonitrile | 1.47 | 0 |
| Benzene | 1.20×10 ⁻⁴ | 0 |
| Butanol (n-butyl alcohol) | 8.05×10 ² | 0 |
| Polychlorinated biphenyls | 2.82×10 ⁻¹ | 0 |
| 2,4,6-Trichlorophenol | 5.54×10 ⁻⁵ | 0 |

^a Represents 5 percent of the ancillary equipment, tank waste retrieval leak, and tank residual waste inventories and 40.5 percent of the deep soils inventory for the single-shell tank farms and the six sets of contiguous cribs and trenches (ditches). Disposal would take place in the River Protection Project Disposal Facility.

^b Represents 85 percent of the highly contaminated deep soil inventory that would be removed during clean closure of all of the single-shell tank farms and the six sets of contiguous cribs and trenches (ditches) and treated in the PPF, resulting in PPF glass. Disposal would take place in an Integrated Disposal Facility.

Key: MLLW=mixed low-level radioactive waste; PPF=Preprocessing Facility.

Source: SAIC 2007g, 2007i, 2007k, 2008a.

Table D-63. Tank Closure Alternative 6C Radiological Constituents of Potential Concern Balance

| | Iodine-129 | | Cesium-137 | | Carbon-14 | | Hydrogen-3 (Tritium) | | Uranium-233, -234, -235, -238 | | Neptunium-237 | | Plutonium -239, -240 | | Strontium-90 | | Technetium-99 | | |
|---|----------------------------|--------------|----------------------------|--------------|----------------------------|------------|----------------------------|------------|-------------------------------|--------------|----------------------------|--------------|----------------------------|--------------|----------------------------|--------------|----------------------------|--------------|-------|
| | Curies | % of BBI | Curies | % of BBI | Curies | % of BBI | Curies | % of BBI | Curies | % of BBI | Curies | % of BBI | Curies | % of BBI | Curies | % of BBI | Curies | % of BBI | |
| Best-Basis Inventory | | | | | | | | | | | | | | | | | | | |
| BBI ^a | 4.82×10 ¹ | N/A | 4.58×10 ⁷ | N/A | 3.12×10 ³ | N/A | 1.21×10 ⁴ | N/A | 9.38×10 ² | N/A | 1.41×10 ² | N/A | 8.14×10 ⁴ | N/A | 5.05×10 ⁷ | N/A | 2.97×10 ⁴ | N/A | N/A |
| Tank Closure Waste Inventory | | | | | | | | | | | | | | | | | | | |
| Tank residual waste ^b | 4.82×10 ⁻¹ | 1.0 | 4.58×10 ⁵ | 1.0 | 3.12×10 ¹ | 1.0 | 1.21×10 ² | 1.0 | 9.38 | 1.0 | 1.41 | 1.0 | 8.14×10 ² | 1.0 | 5.05×10 ⁵ | 1.0 | 2.97×10 ² | 1.0 | 1.0 |
| IHLW glass ^c | 6.99×10 ⁻³ | 0.0 | 4.49×10 ⁷ | 97.9 | 0 | 0.0 | 0 | 0.0 | 8.73×10 ² | 93.1 | 1.40×10 ² | 99.0 | 8.06×10 ⁴ | 99.0 | 4.93×10 ⁷ | 97.6 | 2.73×10 ² | 0.9 | 0.9 |
| ILAW glass and retired LAW melter ^d | 9.56 | 19.8 | 4.45×10 ⁵ | 1.0 | 0 | 0.0 | 0 | 0.0 | 5.47×10 ¹ | 5.8 | 8.35×10 ⁻³ | 0.0 | 1.45 | 0.0 | 2.30×10 ³ | 0.0 | 2.88×10 ⁴ | 96.9 | 0.3 |
| ETF-generated solid secondary waste ^e | 3.36×10 ¹ | 69.7 | 4.59×10 ⁻¹ | 0.0 | 8.51 | 0.3 | 0 | 0.0 | 4.03×10 ⁻² | 0.0 | 5.11×10 ⁻² | 0.0 | 6.90×10 ⁻⁴ | 0.0 | 6.42 | 0.0 | 8.63×10 ¹ | 0.3 | 1.5 |
| Solid secondary waste ^f | 4.65 | 9.7 | 1.95×10 ⁵ | 0.4 | 0 | 0.0 | 0 | 0.0 | 3.64 | 0.4 | 2.83×10 ⁻¹ | 0.2 | 1.98×10 ² | 0.2 | 7.76×10 ⁵ | 1.5 | 4.31×10 ² | 1.5 | 100.5 |
| Totals | 4.83×10¹ | 100.2 | 4.60×10⁷ | 100.2 | 3.97×10¹ | 1.3 | 1.21×10² | 1.0 | 9.41×10² | 100.3 | 1.41×10² | 100.2 | 8.16×10⁴ | 100.2 | 5.06×10⁷ | 100.1 | 2.99×10⁴ | 100.5 | |
| Other Inventory | | | | | | | | | | | | | | | | | | | |
| Solid and liquid secondary waste from cesium and strontium capsules | 0 | N/A | 1.99×10 ⁵ | N/A | 0 | N/A | 0 | N/A | 0 | N/A | 0 | N/A | 0 | N/A | 3.16×10 ⁵ | N/A | 0 | N/A | N/A |
| Cesium and strontium capsules ^h | 0 | N/A | 4.59×10 ⁷ | N/A | 0 | N/A | 0 | N/A | 0 | N/A | 0 | N/A | 0 | N/A | 1.98×10 ⁷ | N/A | 0 | N/A | N/A |
| Rubble, soil, and equipment ⁱ | 1.67×10 ⁻² | N/A | 1.31×10 ⁴ | N/A | 1.47 | N/A | 6.03 | N/A | 4.82×10 ⁻¹ | N/A | 3.24×10 ⁻² | N/A | 4.32×10 ⁻¹ | N/A | 3.05×10 ⁴ | N/A | 9.72 | N/A | N/A |
| Air Emissions | | | | | | | | | | | | | | | | | | | |
| Treatment air emissions ^j | 4.78×10 ¹ | N/A | 7.99×10 ⁴ | N/A | 3.10×10 ³ | N/A | 1.20×10 ⁴ | N/A | 4.66×10 ⁻¹ | N/A | 7.00×10 ⁻² | N/A | 4.04×10 ¹ | N/A | 3.59×10 ⁴ | N/A | 1.47×10 ¹ | N/A | N/A |

a Source of BBI is DOE-ORP-2003-02, Rev. 0, *Inventory and Source Term Data Package* (DOE 2003a).
 b Represents 99.0 percent retrieval. For analysis purposes, waste inventories from tank waste retrieval leaks and ancillary equipment were assumed to be treated in the Waste Treatment Plant.
 c To be stored on site until disposition decisions are made and implemented. The inventory would include the retired HLW melter.
 d Although processed as ILAW glass, glass and retired melter waste are managed and disposed of as IHLW.
 e Includes secondary liquids that would be sent to the ETF and treated; solids would be disposed of in an Integrated Disposal Facility. Excludes liquid secondary waste from the processing of cesium and strontium capsules, which would be reported separately.
 f Includes solid low-level radioactive waste and mixed low-level radioactive waste streams that would be generated by waste treatment operations. Such waste streams would include debris waste, melter consumables, failed process components, analytical laboratory waste, spent resins, spent carbon adsorbent, high-efficiency particulate air filters, and other process-related waste. Excludes contaminated liquid effluent waste streams, which would be treated at the ETF.
 g Totals may exceed 100 percent due to conservative estimates or rounded numbers. BBI percentages were rounded to the nearest tenth. Carbon-14 and hydrogen-3 (tritium) may not total 100 percent because a portion of each would be released to the offgas streams and stack, and a portion (ETF-generated liquid) would be disposed of in the State-Approved Land Disposal Site.
 h To be treated in the Waste Treatment Plant, resulting in glass waste, which would be stored on site until disposition decisions are made and implemented.
 i Rubble, soil, and equipment would be generated by the removal of 4.6 meters (15 feet) of soil and ancillary equipment at the BX and SX tank farms. Disposal would take place in the River Protection Project Disposal Facility.
 j Includes air emissions from all waste treatment processes, including those from treatment of the cesium and strontium capsules. For analysis purposes, both iodine-129 capture and air emission releases were assumed.
Key: %-percent; BBI=Best-Basis Inventory; ETF=Effluent Treatment Facility; HLW=high-level radioactive waste; IHLW=immobilized high-level radioactive waste; ILAW=immobilized low-activity waste; LAW=low-activity waste; N/A=not applicable.
Source: SAIC 2007g, 2007h, 2008a.

Table D-64. Tank Closure Alternative 6C Chemical Constituents of Potential Concern Balance

| | Chromium | | Mercury | | Nitrate | | Lead | | Total Uranium | | Acetonitrile | | Benzene | | Butanol | | PCBs | | 2,4,6-TCP | | |
|--|----------------------------|--------------|----------------------------|-------------|----------------------------|-------------|----------------------------|--------------|----------------------------|--------------|----------------------------|------------|-----------------------------|------------|----------------------------|------------|----------------------------|------------|-----------------------------|------------|-----|
| | Kg | % of BBI | Kg | % of BBI | Kg | % of BBI | Kg | % of BBI | Kg | % of BBI | Kg | % of BBI | Kg | % of BBI | Kg | % of BBI | Kg | % of BBI | Kg | % of BBI | |
| Best-Basis Inventory | | | | | | | | | | | | | | | | | | | | | |
| BBI ^a | 5.98×10 ⁵ | N/A | 1.83E+03 | N/A | 7.08×10 ⁷ | N/A | 8.41×10 ⁴ | N/A | 5.97×10 ⁵ | N/A | 2.95×10 ⁴ | N/A | 2.40 | N/A | 3.45×10 ⁶ | N/A | 1.68×10 ³ | N/A | 1.11 | N/A | |
| Tank Closure Waste Inventory | | | | | | | | | | | | | | | | | | | | | |
| Tank residual waste ^b | 5.98×10 ³ | 1.0 | 1.83×10 ¹ | 1.0 | 7.08×10 ⁵ | 1.0 | 8.41×10 ² | 1.0 | 5.97×10 ³ | 1.0 | 2.95×10 ² | 1.0 | 2.40×10 ⁻² | 1.0 | 3.45×10 ⁴ | 1.0 | 1.68×10 ¹ | 1.0 | 1.11×10 ⁻² | 1.0 | |
| IHLW glass ^c | 1.36×10 ⁵ | 22.7 | 0 | 0.0 | 0 | 0.0 | 7.45×10 ⁴ | 88.6 | 5.52×10 ⁵ | 92.5 | 0 | 0.0 | 0 | 0.0 | 0 | 0.0 | 0 | 0.0 | 0 | 0.0 | 0.0 |
| ILAW glass and retired LAW melter ^d | 4.56×10 ⁵ | 76.2 | 0 | 0.0 | 0 | 0.0 | 8.88×10 ³ | 10.6 | 3.74×10 ⁴ | 6.3 | 0 | 0.0 | 0 | 0.0 | 0 | 0.0 | 0 | 0.0 | 0 | 0.0 | 0.0 |
| ETF-generated solid secondary waste ^e | 4.43×10 ¹ | 0.0 | 5.55 | 0.3 | 9.01×10 ⁶ | 12.7 | 4.58 | 0.0 | 4.00×10 ¹ | 0.0 | NR | N/A | NR | N/A | NR | N/A | NR | N/A | NR | N/A | N/A |
| Solid secondary waste ^f | 1.94×10 ³ | 0.3 | 1.76×10 ³ | 96.4 | 0 | 0.0 | 2.47×10 ² | 0.3 | 2.32×10 ³ | 0.4 | NR | N/A | NR | N/A | NR | N/A | NR | N/A | NR | N/A | N/A |
| Totals^g | 6.00×10⁵ | 100.3 | 1.78×10³ | 97.7 | 9.72×10⁶ | 13.7 | 8.45×10⁴ | 100.5 | 5.98×10⁵ | 100.2 | 2.95×10² | 1.0 | 2.40×10⁻² | 1.0 | 3.45×10⁴ | 1.0 | 1.68×10¹ | 1.0 | 1.11×10⁻² | 1.0 | |
| Other Inventory^h | | | | | | | | | | | | | | | | | | | | | |
| Rubble, soil, and equipment ⁱ | 5.86×10 ² | N/A | 2.22 | N/A | 3.93×10 ⁴ | N/A | 3.34×10 ¹ | N/A | 6.60×10 ² | N/A | NR | N/A | NR | N/A | NR | N/A | NR | N/A | NR | N/A | N/A |
| Air Emissions | | | | | | | | | | | | | | | | | | | | | |
| Treatment air emissions ^j | NR | N/A | 2.00×10 ³ | N/A | NR | N/A | NR | N/A | NR | N/A | NR | N/A | NR | N/A | NR | N/A | NR | N/A | NR | N/A | N/A |

a Source of BBI is DOE-ORP-2003-02, Rev. 0, *Inventory and Source Term Data Package* (DOE 2003a).
 b Represents 99.0 percent retrieval. For analysis purposes, waste inventories from tank waste retrieval leaks and ancillary equipment were assumed to be treated in the Waste Treatment Plant.
 c To be stored on site until disposition decisions are made and implemented. The inventory would include the retired HLW melter.
 d Although processed as ILAW glass, this waste stream would be managed and disposed of as IHLW.
 e Includes secondary liquids that would be sent to the ETF and treated; solids would be disposed of in an Integrated Disposal Facility.
 f Includes solid low-level radioactive waste and mixed low-level radioactive waste streams that would be generated by the waste treatment operations. Such waste streams would include debris waste, melter consumables, failed process components, analytical laboratory waste, spent resins, spent carbon adsorbent, high-efficiency particulate air filters, and other process-related waste. Excludes contaminated liquid effluent waste streams, which would be treated at the ETF.
 g Totals may exceed 100 percent due to conservative estimates or rounded numbers. BBI percentages were rounded to the nearest tenth. The organic chemicals (acetonitrile, benzene, butanol, polychlorinated biphenyls, and 2,4,6-trichlorophenol) may not total 100 percent because they would be destroyed during thermal treatment processes. Nitrate may not total 100 percent because it would be volatilized and released through the facility stack.
 h No chemical constituents of potential concern have been reported in the cesium and strontium capsule secondary waste streams.
 i Rubble, soil, and equipment would be generated by the removal of 4.6 meters (15 feet) of soil and ancillary equipment at the BX and SX tank farms. Disposal would take place in the River Protection Project Disposal Facility.
 j Includes the air emissions from all waste treatment processes, including those from treatment of the cesium and strontium capsules. For analysis purposes, both mercury capture and air emission releases were assumed.
Key: %-percent; 2,4,6-TCP=2,4,6-trichlorophenol; BBI=Best-Basis Inventory; butanol=n-butyl alcohol; ETF=Effluent Treatment Facility; HLW=high-level radioactive waste; IHLW=immobilized high-level radioactive waste; ILAW=immobilized low-activity waste; kg=kilograms; LAW=low-activity waste; N/A=not applicable; NR=not reported; PCBs=polychlorinated biphenyls; WTP=Waste Treatment Plant.
Source: SAIC 2007g, 2007i, 2008a.

For the purpose of long-term impact assessment, constituent inventory estimates are required for three categories of soil: surface, near surface, and deep soil. Surface soil is defined as soil located within 0.15 to 0.3 meters (0.5 to 1 foot) of the surface. For long-term impacts, surface soil constituent inventories are expected to be minor for three reasons. First, surface contamination occurs primarily due to spills, and current operating procedures call for prompt remediation. Second, during the 1990s, a layer of clean soil was placed over the tank farms to reduce the dose to workers. Third, under all Tank Closure alternatives except Alternatives 1 and 2A, all tank farms would be capped or backfilled with clean soil. Near-surface soil is defined as soil located within 0.3 to 4.6 meters (1 to 15 feet) of the surface. Inventories in this category are dominated by the contributions of ancillary equipment, as described in Section D.1.2. Finally, deep soil is defined as soil located at depths greater than 4.6 meters (15 feet). Contamination of deep soil is expected to be due to past leaks, discharges to cribs and trenches (ditches), and tank waste retrieval leaks, for which inventory estimates are presented in Sections D.1.4, D.1.5, and D.1.6, respectively.

During closure of the tank farms, combinations of the three categories of soil would be disposed of on site, either with or without additional cleaning. Inventories of radioactive and chemical constituents projected under each of the Tank Closure alternatives are presented in the following section in conjunction with inventories of the waste forms proposed for waste disposal.

As discussed in Chapter 2, Tank Closure Alternatives 2B, 3A, 3B, 3C, and 6C would remove contaminated soil (upper 4.6 meters [15 feet]) at the BX and SX tank farms only. Tank Closure Alternative 4 would include clean closure of the BX and SX tank farms, including disposal of ancillary equipment and contaminated soils. The Tank Closure Alternative 6A and 6B Base Cases would include clean closure of all SST farms, including disposal of ancillary equipment and contaminated soils. In addition, Tank Closure Alternatives 6A and 6B analyze the option of expanding clean closure to include the six sets of contiguous cribs and trenches (ditches) in addition to the SST farms. Therefore, three contaminated-soil onsite disposal analyses were conducted using current tank, ancillary equipment, tank residual, retrieval, and past leak inventory data. The bases for these calculations are the process options described in the scaled data documentation prepared for this *TC & WM EIS* (SAIC 2007g, 2008a). These options involve the different types of waste, recovery efficiencies, and combinations of processing under each alternative. Material balances reflecting these process options were developed using the analysis described in the following paragraphs.

For Tank Closure Alternatives 2B, 3A, 3B, 3C, and 6C (see Figure D–13 for a simplified flowsheet and Tables D–65 and D–66 for inventories), the following calculation was used to determine the radioactive and chemical constituent inventories that would be associated with removal of soil and ancillary equipment within 4.6 meters (15 feet) of the ground surface at the BX and SX tank farms. The calculation is based on the assumptions that the inventory of contaminants excluding ancillary equipment would be minor compared to the inventory of contaminants including ancillary equipment, and that all of the recovered soil, ancillary equipment, and associated inventory of contaminants would be packaged for disposal in the RPPDF. The inventory of contaminants was calculated as follows:

$$M_{\text{soil}} = 1.0 \times M_{\text{anc}}$$

where:

M_{soil} = inventory of radioactive or chemical constituents in contaminated equipment and soil disposed of on site

M_{anc} = inventory of radioactive or chemical constituents in ancillary equipment

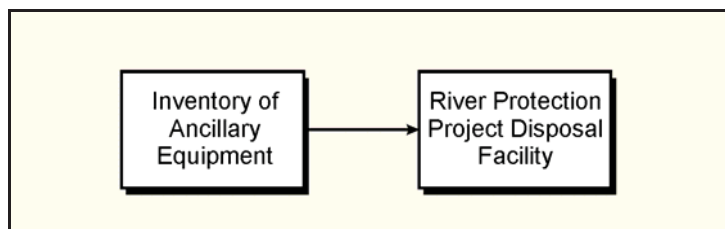

Figure D-13. Tank Closure Alternatives 2B, 3A, 3B, 3C, and 6C: Contaminated Soil Removal at BX and SX Tank Farms Flowsheet

Table D-65. Tank Closure Alternatives 2B, 3A, 3B, 3C, and 6C Radiological COPC Inventory from Removal of 4.6 Meters (15 Feet) of Soil at the BX and SX Tank Farms (curies)

| Analyte | MLLW ^a |
|-------------------------------|-----------------------|
| Hydrogen-3 (tritium) | 6.03 |
| Carbon-14 | 1.47 |
| Strontium-90 | 3.05×10 ⁴ |
| Technetium-99 | 9.72 |
| Iodine-129 | 1.67×10 ⁻² |
| Cesium-137 | 1.31×10 ⁴ |
| Uranium-233, -234, -235, -238 | 4.82×10 ⁻¹ |
| Neptunium-237 | 3.24×10 ⁻² |
| Plutonium-239, -240 | 4.32×10 ¹ |

^a Represents 100 percent of the ancillary equipment inventory in BX and SX tank farms. Disposal would take place in the River Protection Project Disposal Facility.

Key: MLLW=mixed low-level radioactive waste.

Source: SAIC 2007g, 2007j, 2008a.

Table D-66. Tank Closure Alternatives 2B, 3A, 3B, 3C, and 6C Chemical COPC Inventory from Removal of 4.6 Meters (15 Feet) of Soil at the BX and SX Tank Farms (kilograms)

| Analyte | MLLW ^a |
|---------------------------|----------------------|
| Chromium | 5.86×10 ² |
| Mercury | 2.22 |
| Nitrate | 3.93×10 ⁴ |
| Lead | 3.34×10 ¹ |
| Total Uranium | 6.60×10 ² |
| Acetonitrile | NR |
| Benzene | NR |
| Butanol (n-butyl alcohol) | NR |
| Polychlorinated biphenyls | NR |
| 2,4,6-Trichlorophenol | NR |

^a Represents 100 percent of the ancillary equipment inventory in BX and SX tank farms. Disposal would take place in the River Protection Project Disposal Facility.

Key: MLLW=mixed low-level radioactive waste; NR=not reported.

Source: SAIC 2007g, 2007k, 2008a.

D.1.8 Distribution of Radiological Constituents of Potential Concern for Tank Closure Alternatives

As discussed in Section D.1.7, the retrieval of tank wastes, treatment and stabilization of waste streams, and closure of the tank farms would generate a number of waste forms for both on- and offsite disposal. This section provides both a graphical representation and tabular information on the radiological COPC inventories for each of the Tank Closure alternatives. Figures D-14 through D-63 (a total of 50 figures) below show the distribution of the nine radiological COPCs for Tank Closure Alternatives 2A, 2B, 3A, 3B, 3C, 4, 5, the 6A Base and Option Cases, the 6B Base and Option Cases, and 6C (SAIC 2007g, 2007l, 2008a). These figures include the following for each of the Tank Closure action alternatives:

- A histogram that provides a graphic display of the distribution of the nine radiological COPCs (iodine-129; cesium-137; carbon-14; tritium; uranium [including uranium-233, -234, -235, and -238]; neptunium-237; plutonium [including plutonium-239 and -240]; strontium-90; and technetium-99). For each of these COPCs, the histogram provides the total curies in the tank farms (BBI estimate) and the estimated BBI percentage (curie basis) that would be disposed of on site in an IDF as either a glass waste form (ILAW glass, bulk vitrification glass), a grout (cast stone waste, retired LAW melters [grout-filled], Effluent Treatment Facility [ETF]-generated secondary solid waste, sulfate grout waste, or tank residual waste), or steam reforming waste. As noted on the histograms, only tank closure waste is included. The histogram excludes waste generated by the Fast Flux Test Facility (FFTF) Decommissioning and Waste Management alternatives; offsite waste; onsite, non-Comprehensive Environmental Response, Compensation, and Liability Act (CERCLA), nontank waste; cesium and strontium capsule waste; waste forms that would be disposed of in the RPPDF; and PPF-generated waste that would contribute to the IHLW glass and ILAW glass.
- Three pie charts that graphically display the disposition of three radiological COPCs (iodine-129; uranium [including uranium-233, -234, -235, and -238]; and technetium-99) under each Tank Closure alternative. As noted on the pie charts, only tank closure waste is included. The pie charts exclude waste generated by the FFTF Decommissioning and Waste Management alternatives; offsite waste; onsite, non-CERCLA, nontank waste; cesium and strontium capsule waste; the waste forms that would be disposed of in the RPPDF; and PPF-generated waste that would contribute to the IHLW glass and ILAW glass.
- One summary pie chart that includes all nine radiological COPCs (iodine-129; cesium-137; carbon-14; tritium; uranium [including uranium-233, -234, -235, and -238]; neptunium-237; plutonium [including plutonium-239 and -240]; strontium-90; and technetium-99) and displays the disposition of the total of these COPCs under each Tank Closure alternative. As noted on the pie charts, only tank closure waste is included. This pie chart excludes waste generated by the FFTF Decommissioning and Waste Management alternatives; offsite waste; onsite, non-CERCLA, nontank waste; cesium and strontium capsule waste; the waste forms that would be disposed of in the RPPDF; and PPF-generated waste that would contribute to the IHLW glass and ILAW glass.
- The figures in the following section reflect the assumption that IHLW would be disposed of off site (however, this IHLW would be stored on site until disposition decisions are made and implemented). As indicated in the Administration's fiscal year 2010 budget request, the Administration intends to terminate the Yucca Mountain program while developing nuclear waste disposal alternatives. Notwithstanding the decision to terminate the Yucca Mountain program, DOE remains committed to meeting its obligations to manage and ultimately dispose of HLW and SNF. The Administration intends to convene a blue ribbon commission to evaluate alternative approaches for meeting these objectives. The commission will provide the opportunity for a meaningful dialogue on how best to address this challenging issue and will provide recommendations that will form the basis for working with Congress to revise the statutory framework for managing and disposing of HLW and SNF.

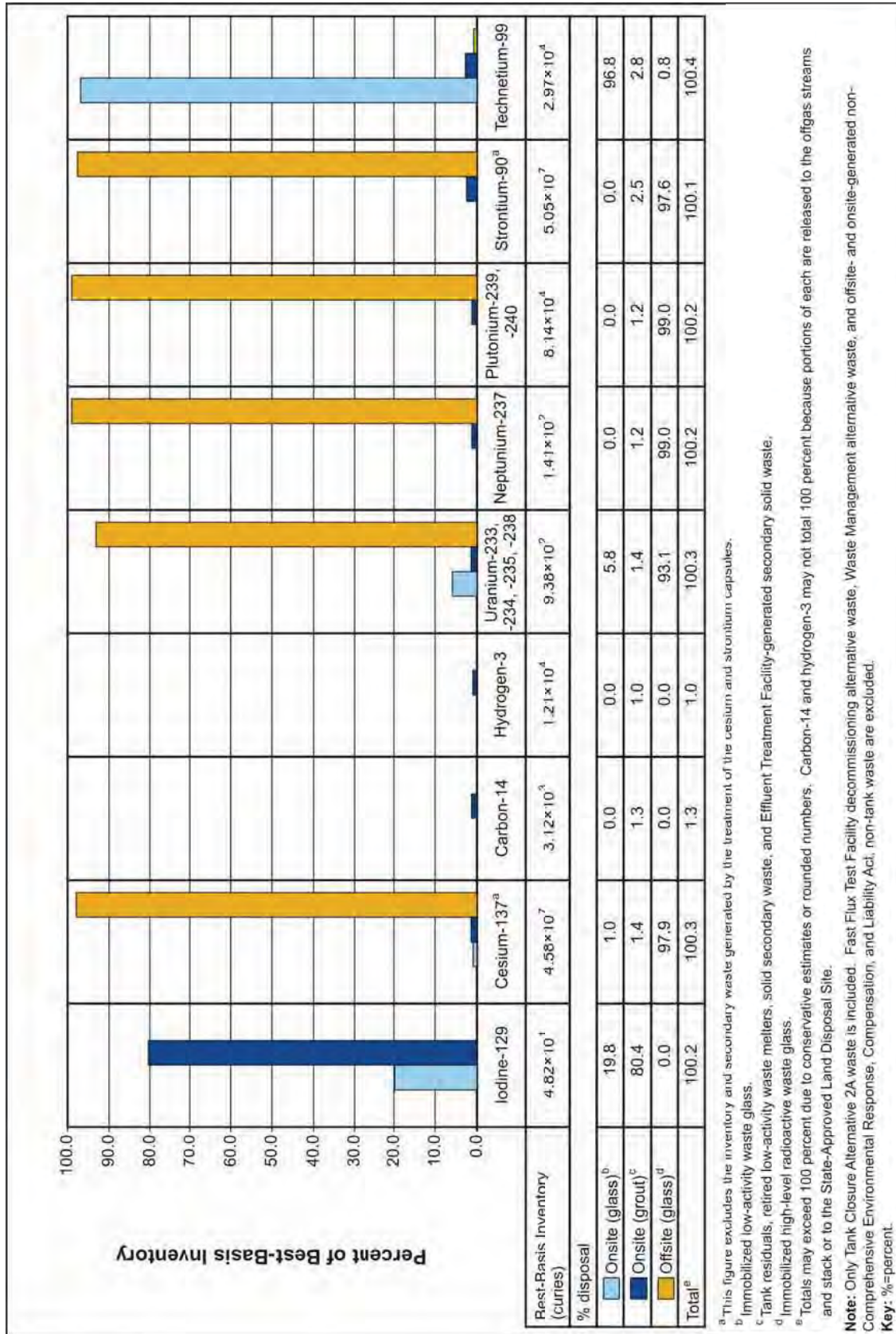

Figure D-14. Tank Closure Alternative 2A: Distribution of Radiological Constituents of Potential Concern

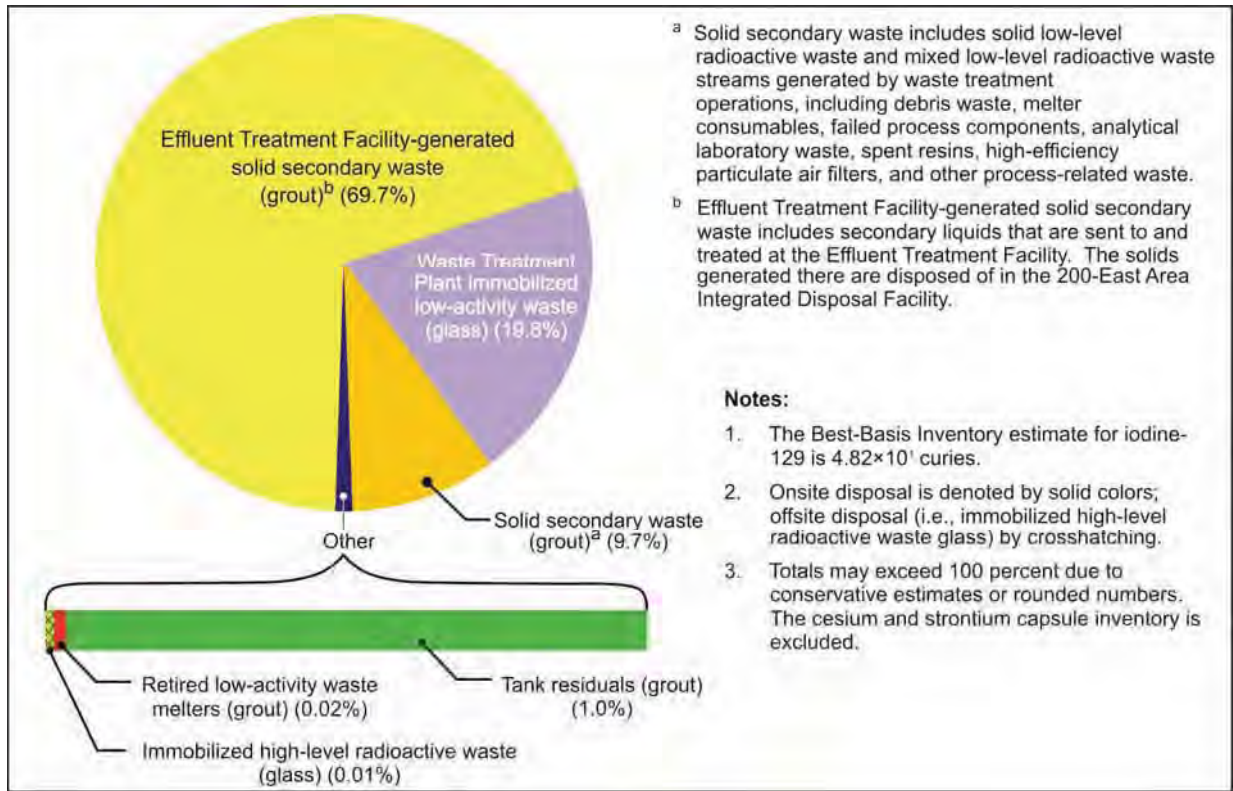

Figure D-15. Tank Closure Alternative 2A: Iodine-129 Distribution

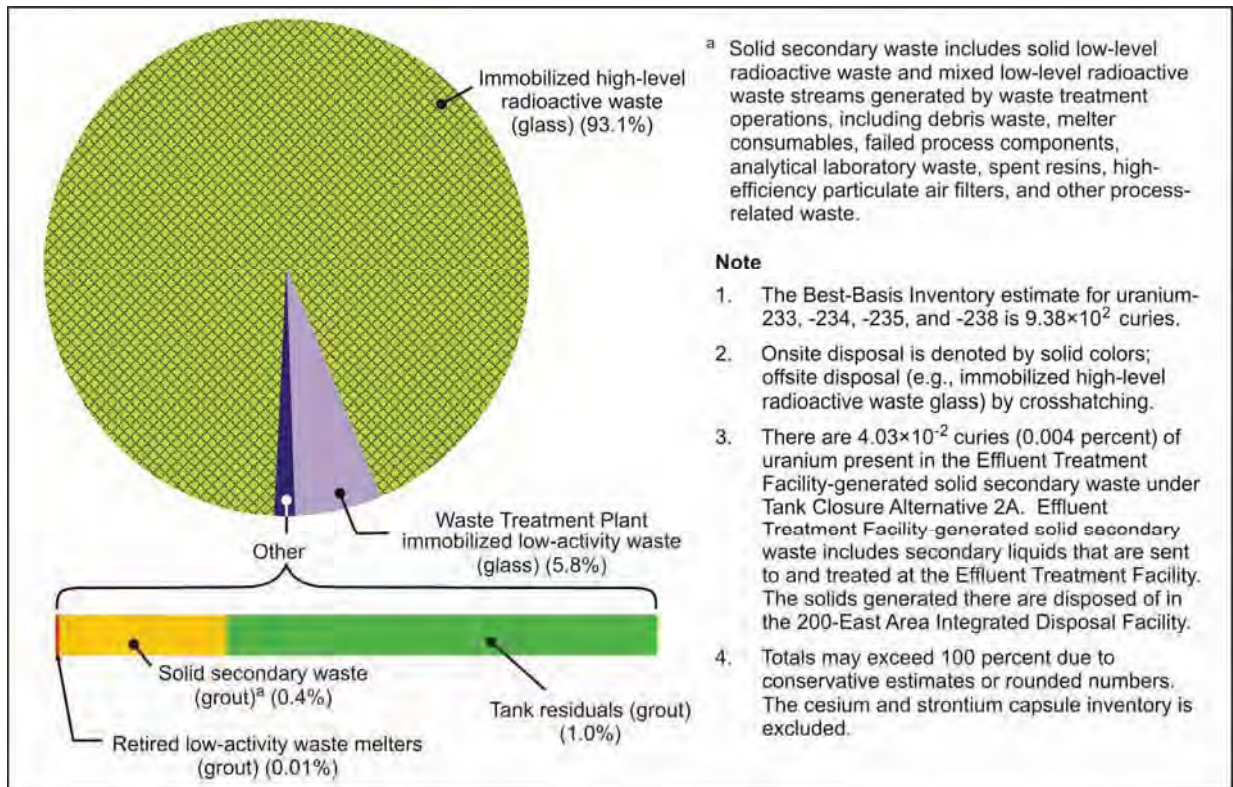

Figure D-16. Tank Closure Alternative 2A: Uranium Distribution

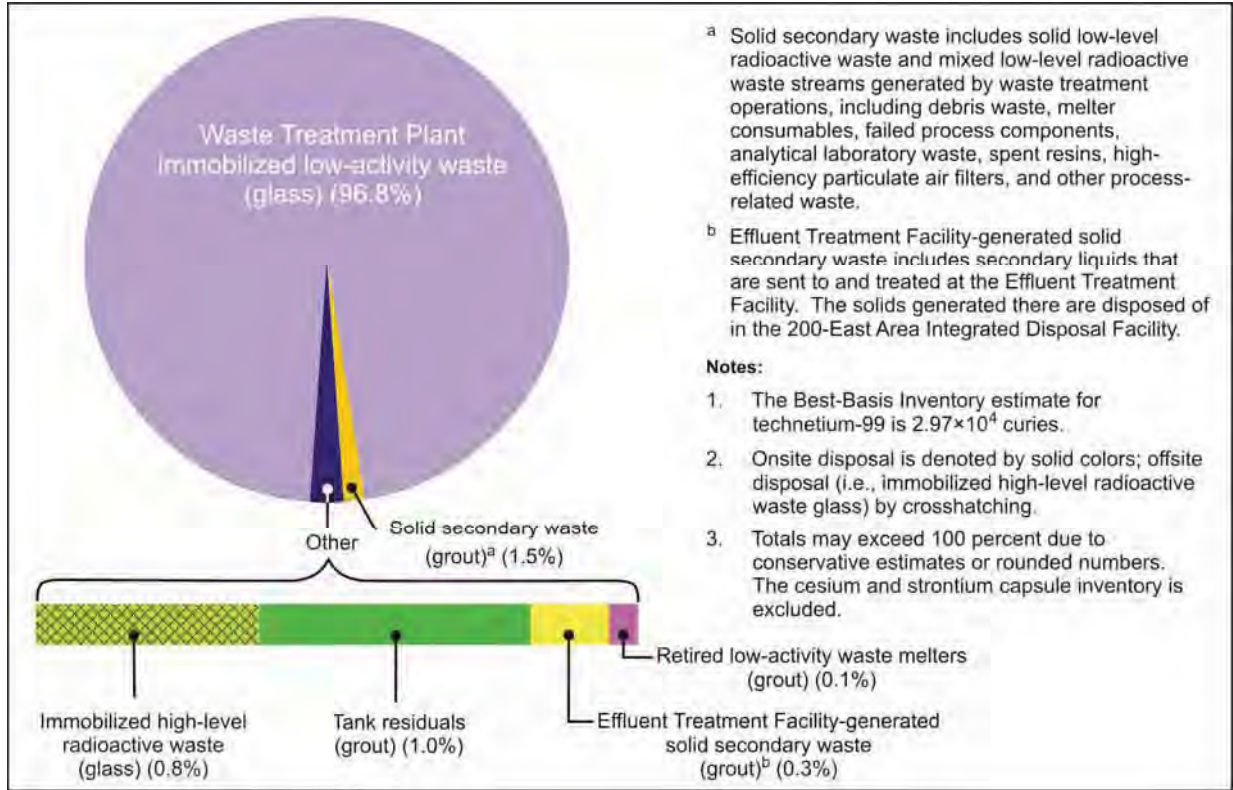

Figure D-17. Tank Closure Alternative 2A: Technetium-99 Distribution

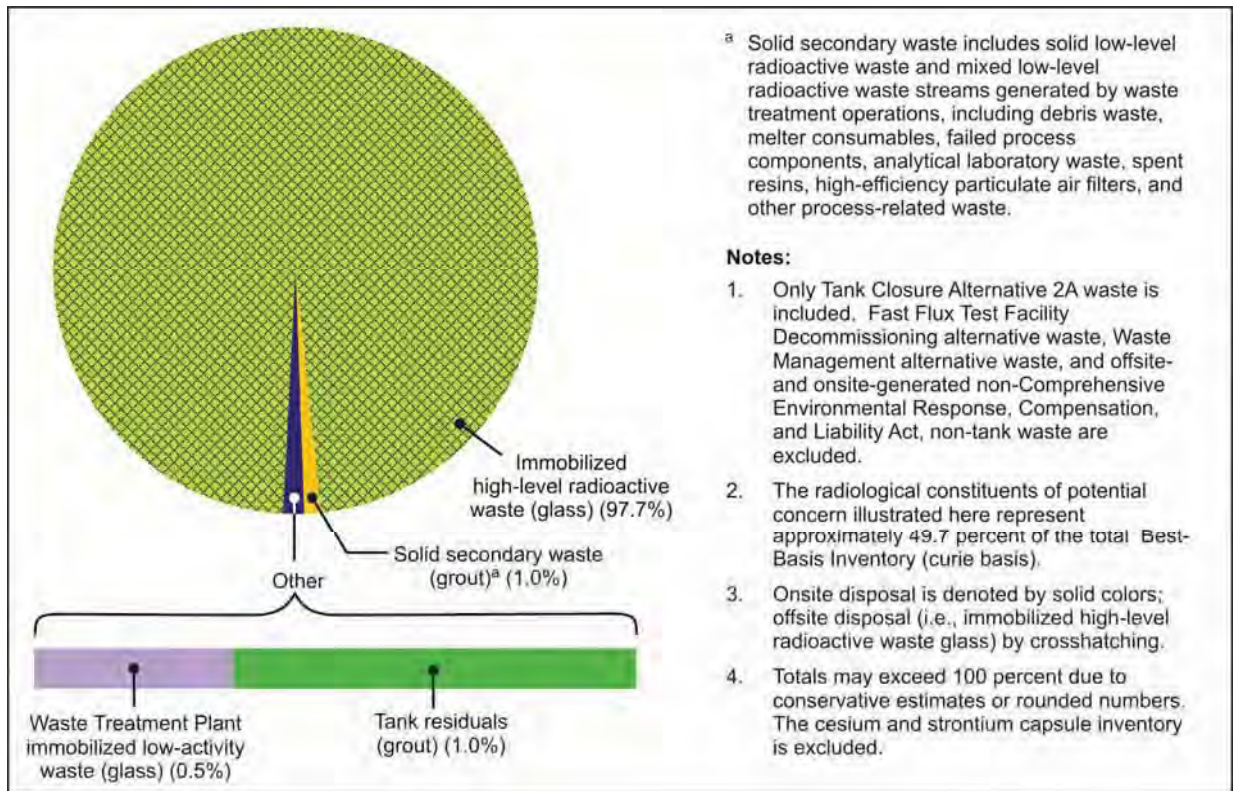

Figure D-18. Tank Closure Alternative 2A: Distribution of Total Radiological Constituents of Potential Concern

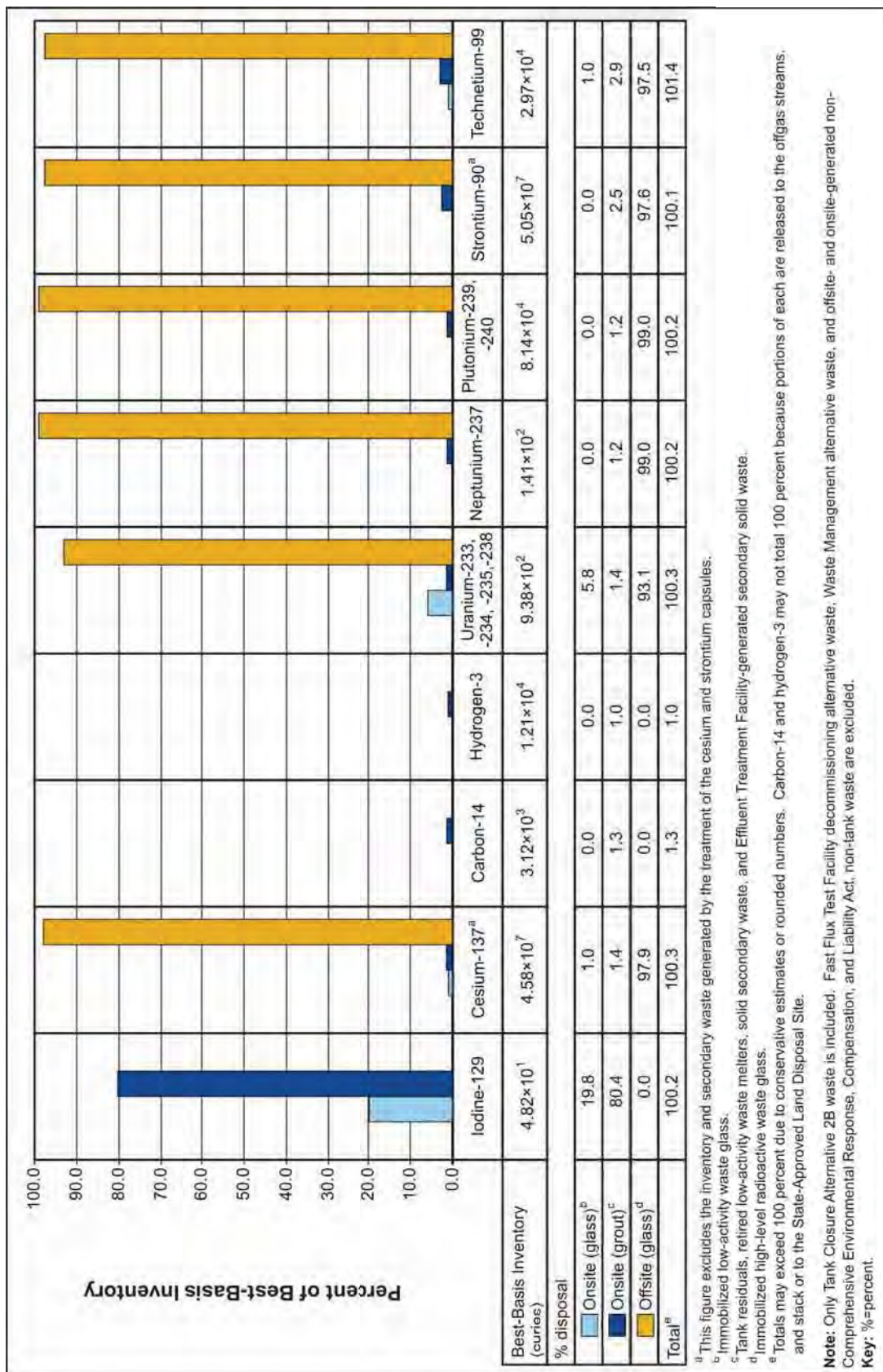

Figure D-19. Tank Closure Alternative 2B: Distribution of Radiological Constituents of Potential Concern

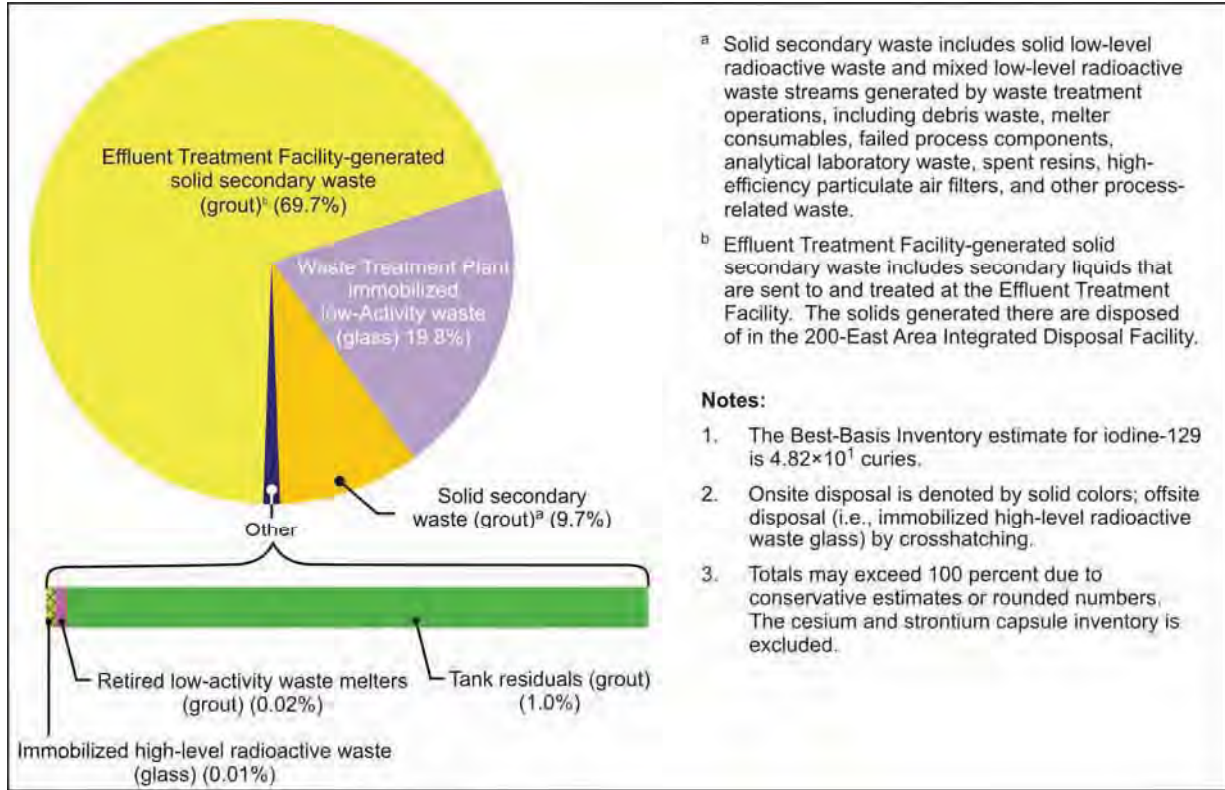

Figure D-20. Tank Closure 2B: Iodine-129 Distribution

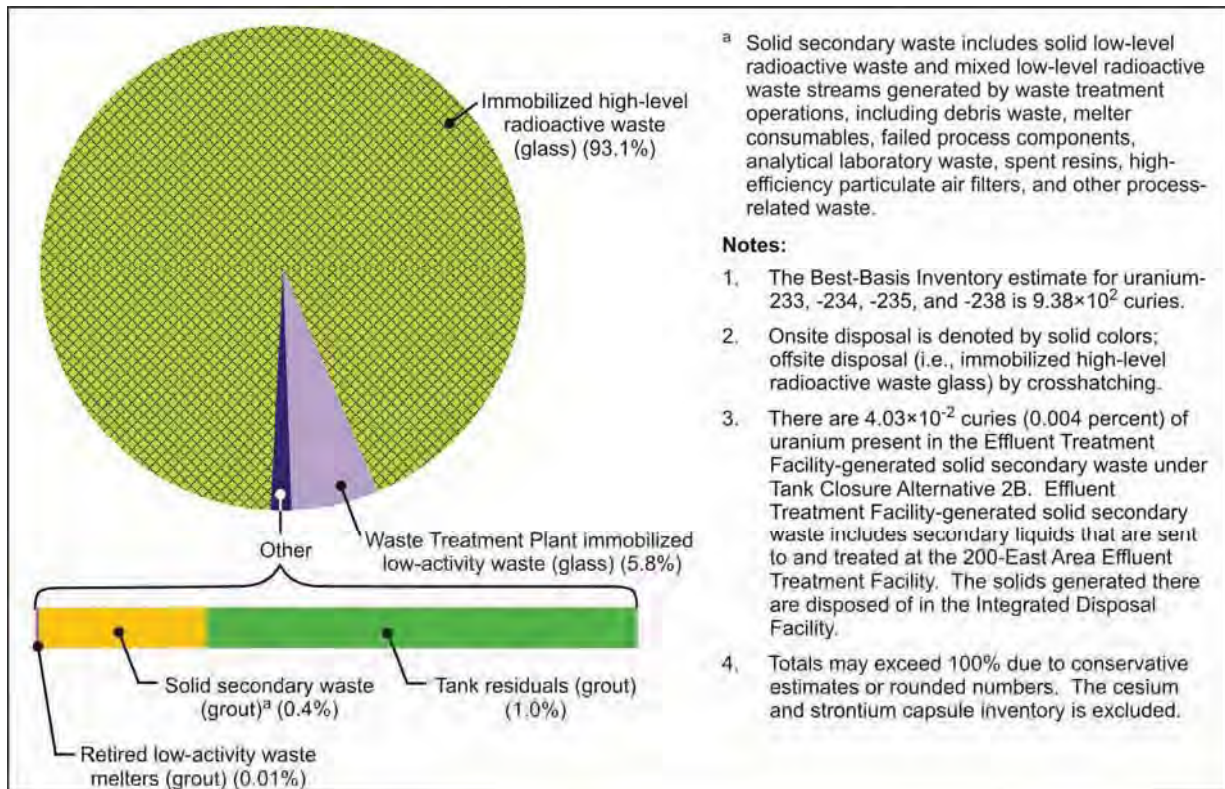

Figure D-21. Tank Closure Alternative 2B: Uranium Distribution

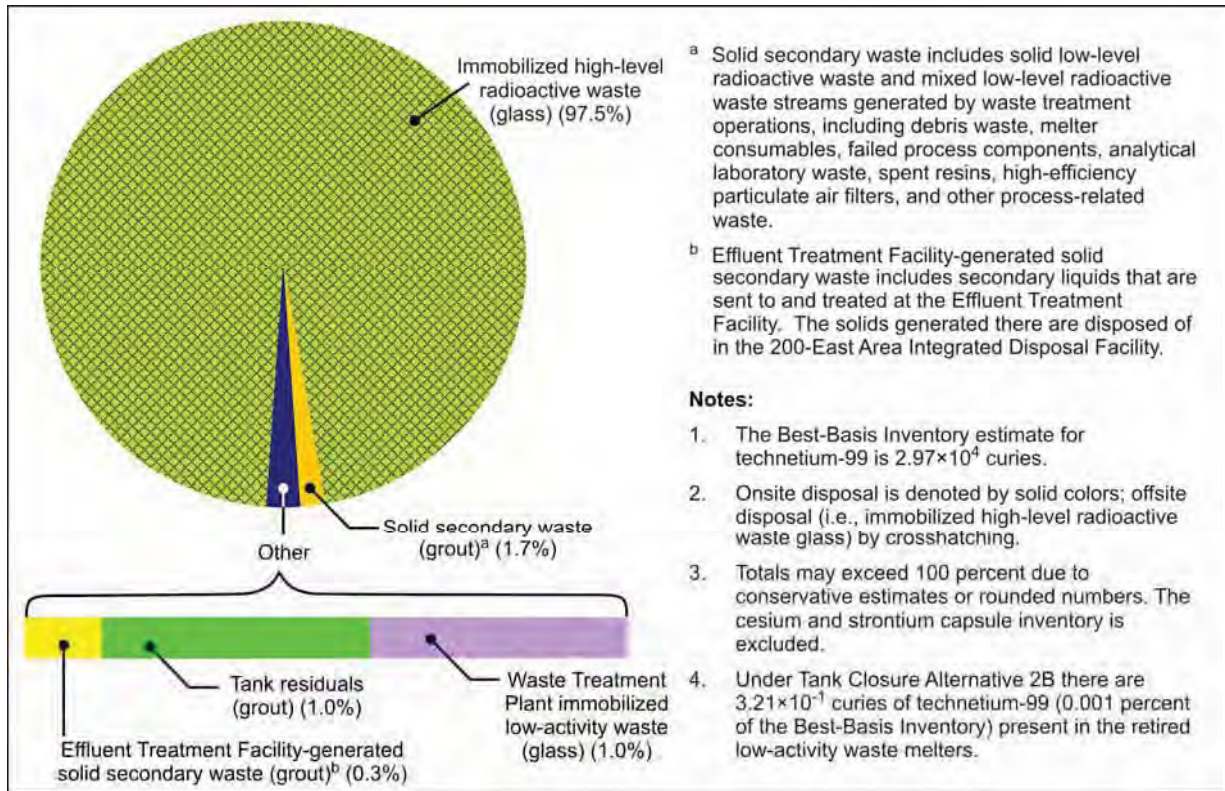

Figure D-22. Tank Closure Alternative 2B: Technetium-99 Distribution

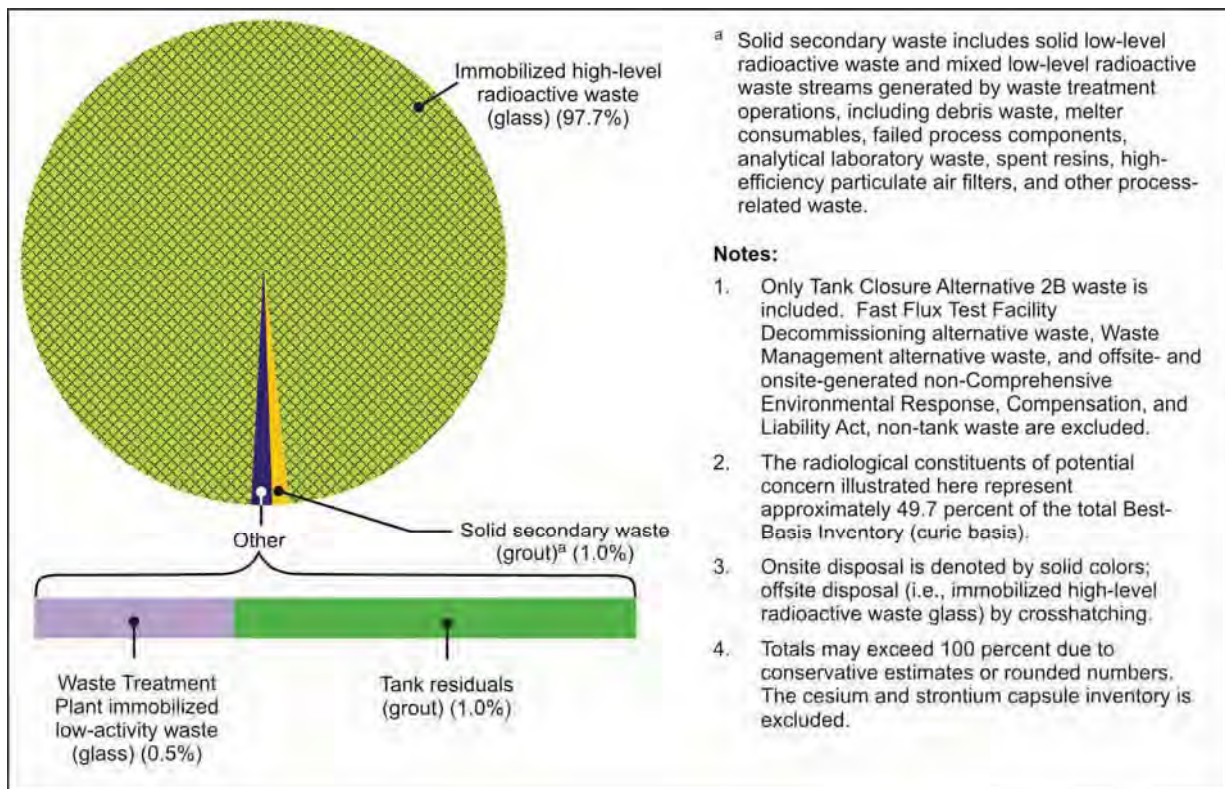

Figure D-23. Tank Closure Alternative 2B: Distribution of Total Radiological Constituents of Potential Concern

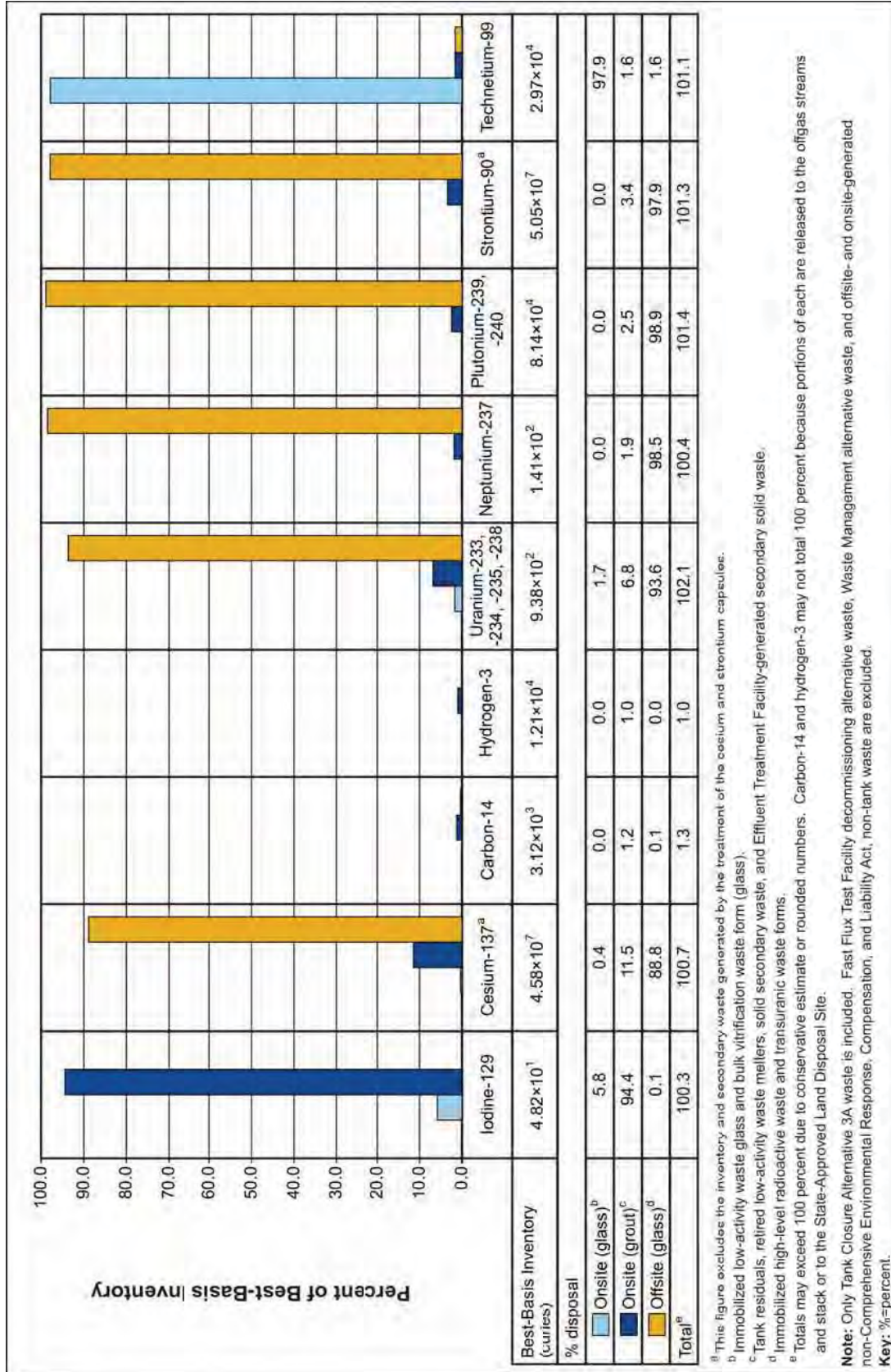

Figure D-24. Tank Closure Alternative 3A: Distribution of Radiological Constituents of Potential Concern

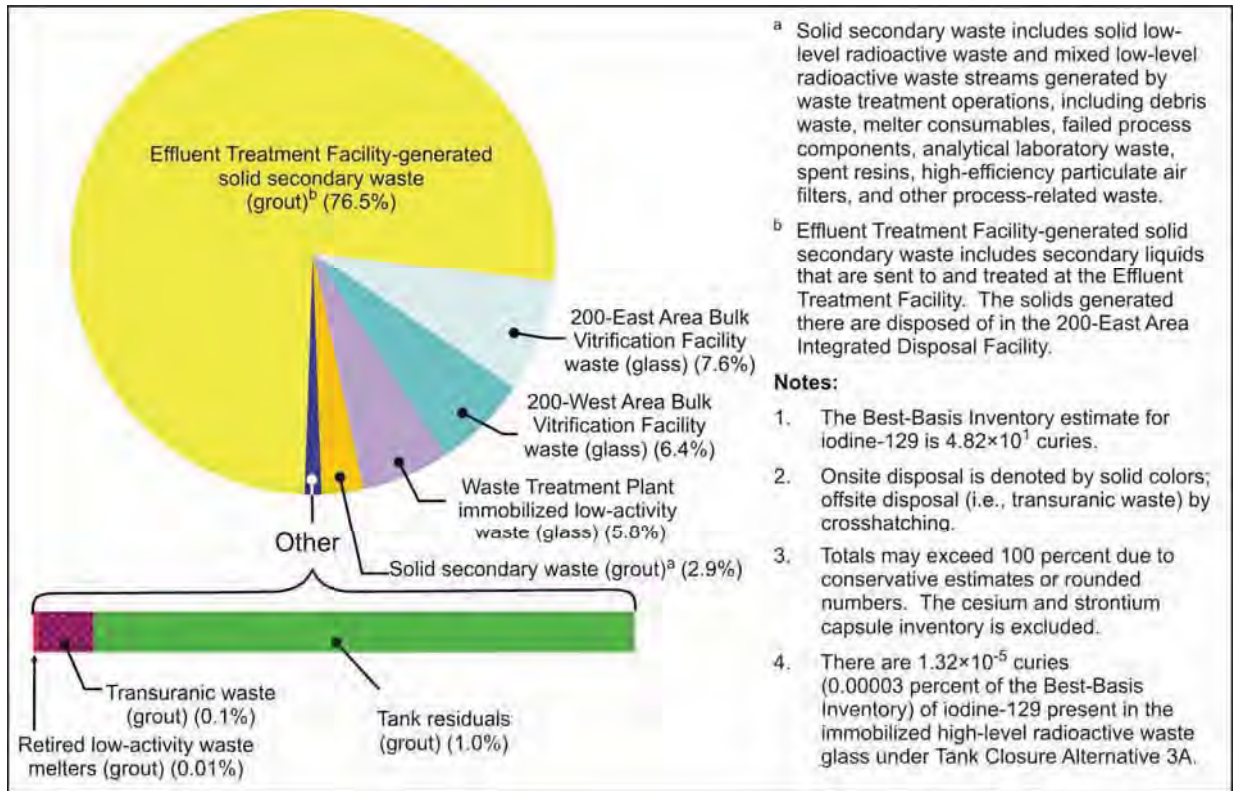

Figure D-25. Tank Closure Alternative 3A: Iodine-129 Distribution

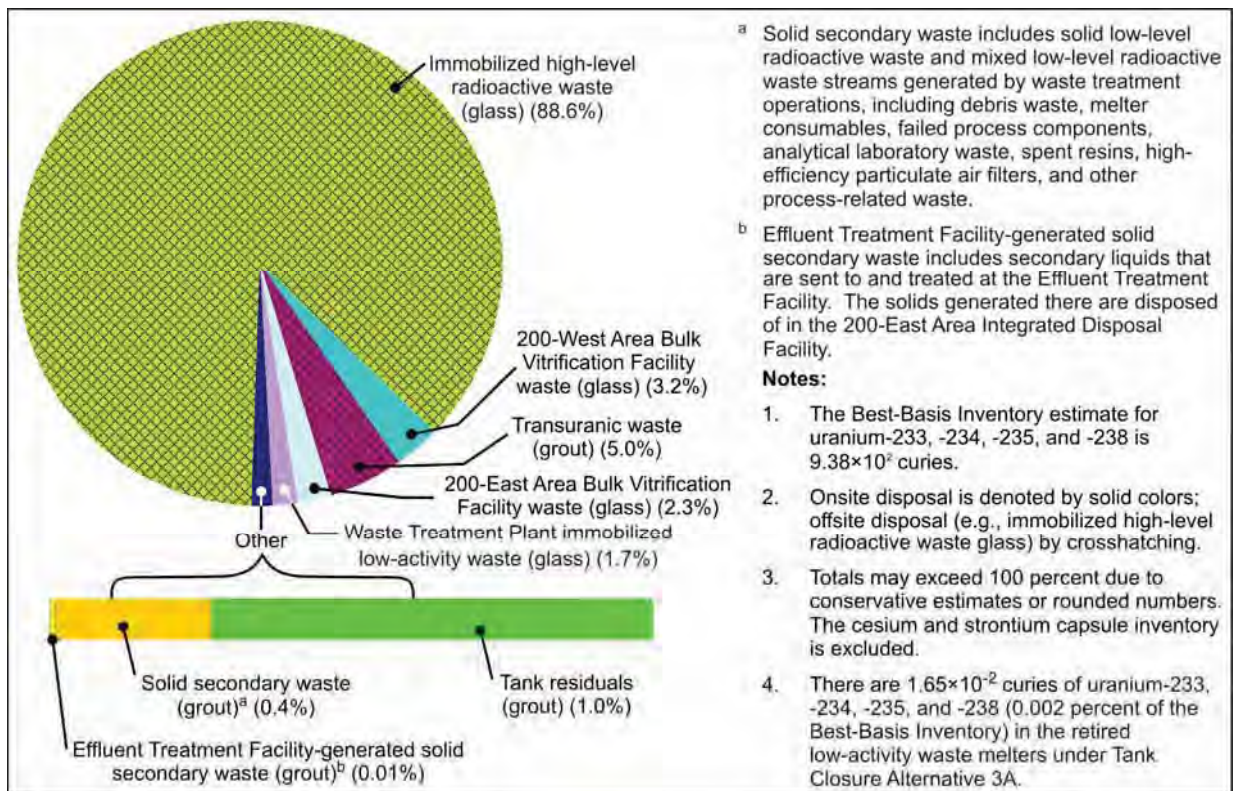

Figure D-26. Tank Closure Alternative 3A: Uranium Distribution

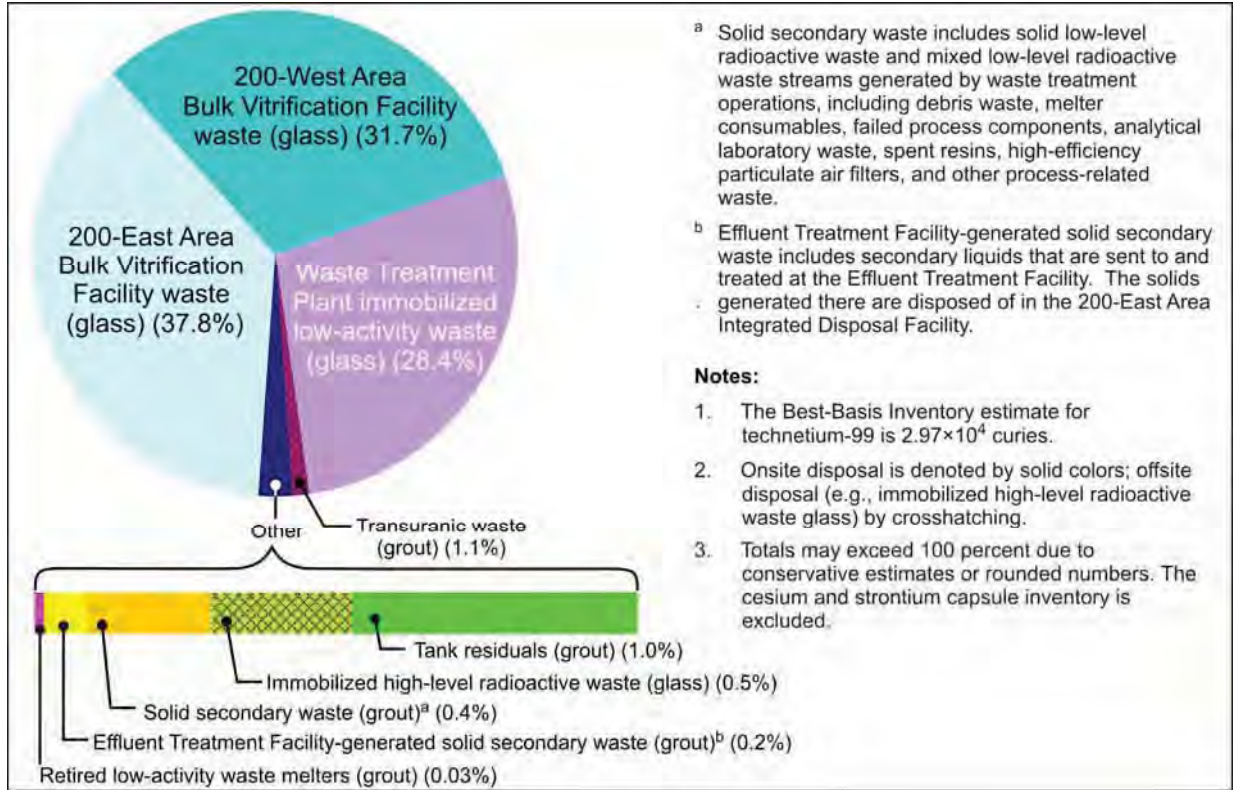

Figure D-27. Tank Closure Alternative 3A: Technetium-99 Distribution

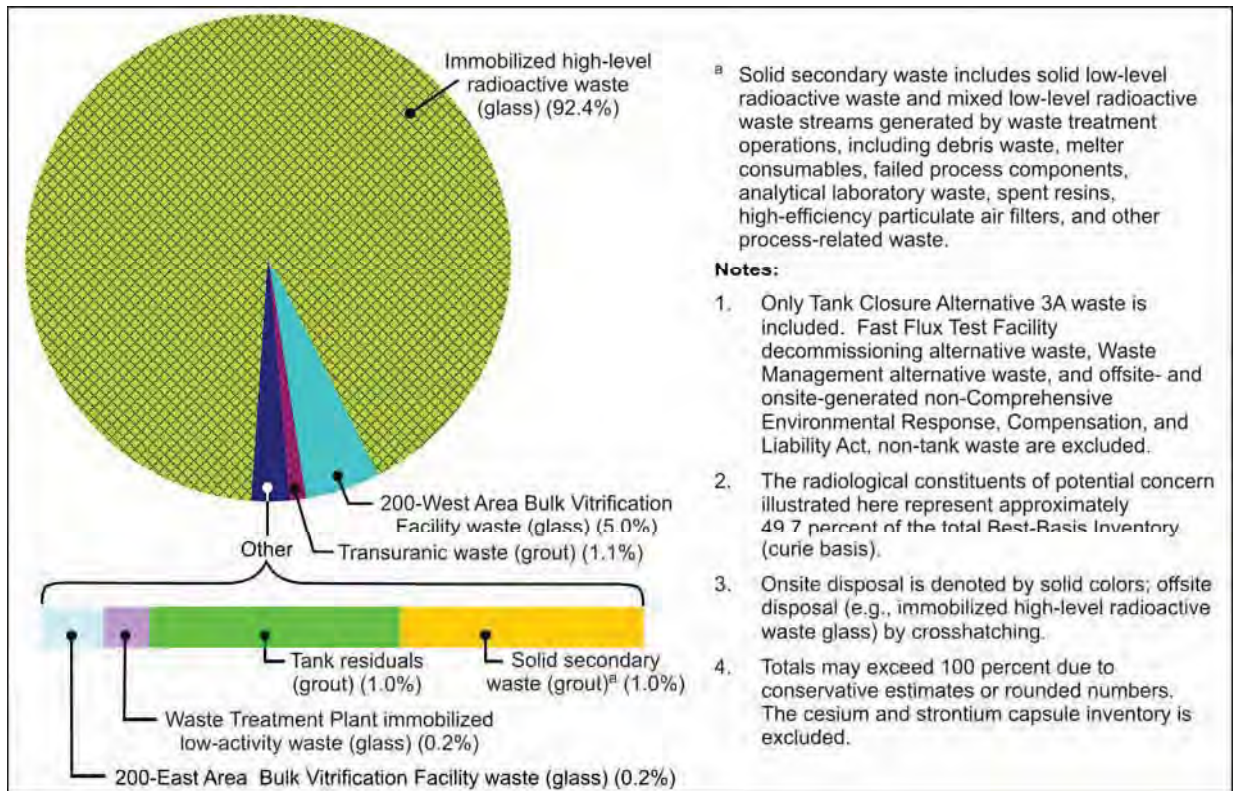

Figure D-28. Tank Closure Alternative 3A: Distribution of Total Radiological Constituents of Potential Concern

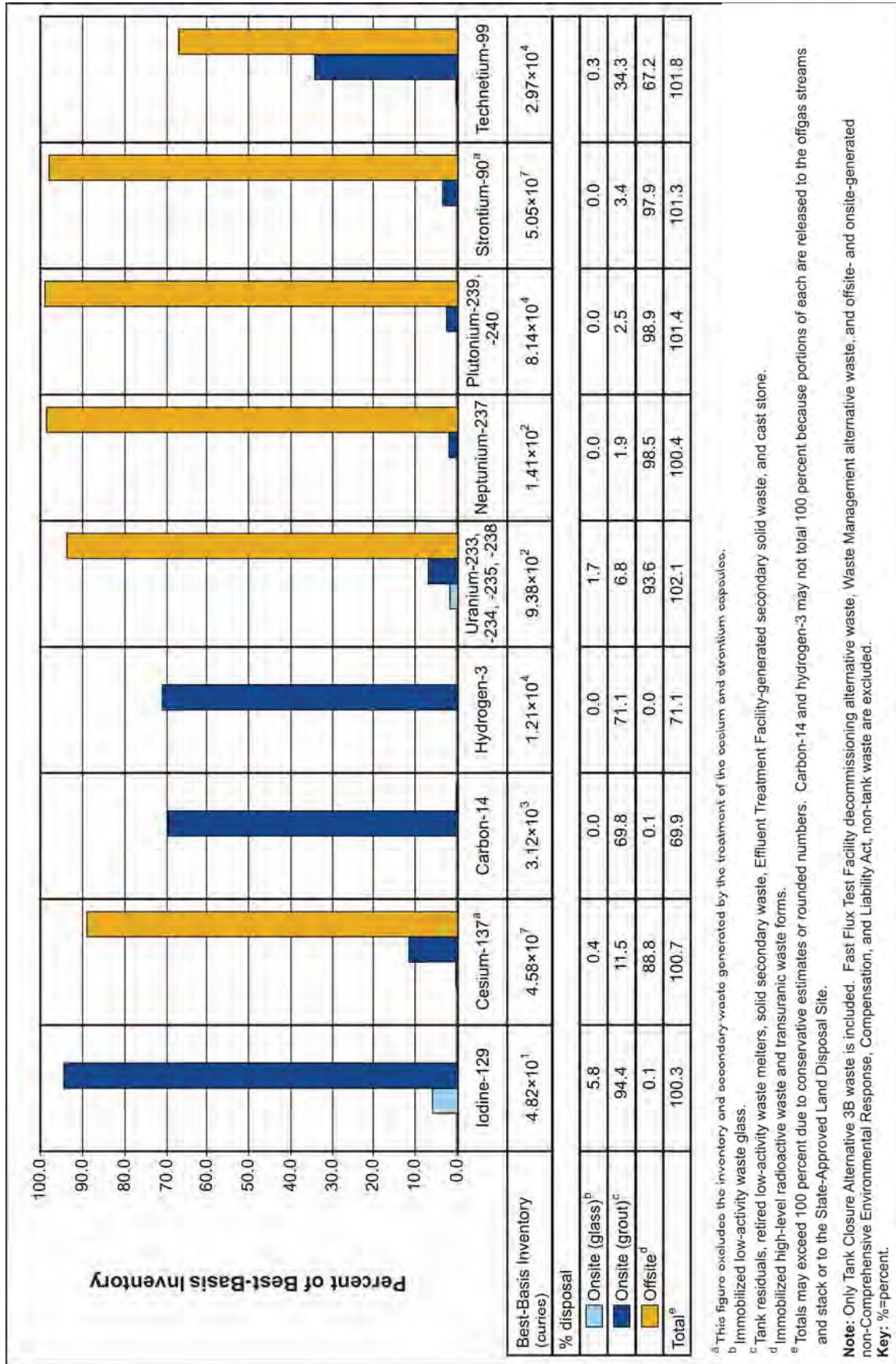

Figure D-29. Tank Closure Alternative 3B: Distribution of Radiological Constituents of Potential Concern

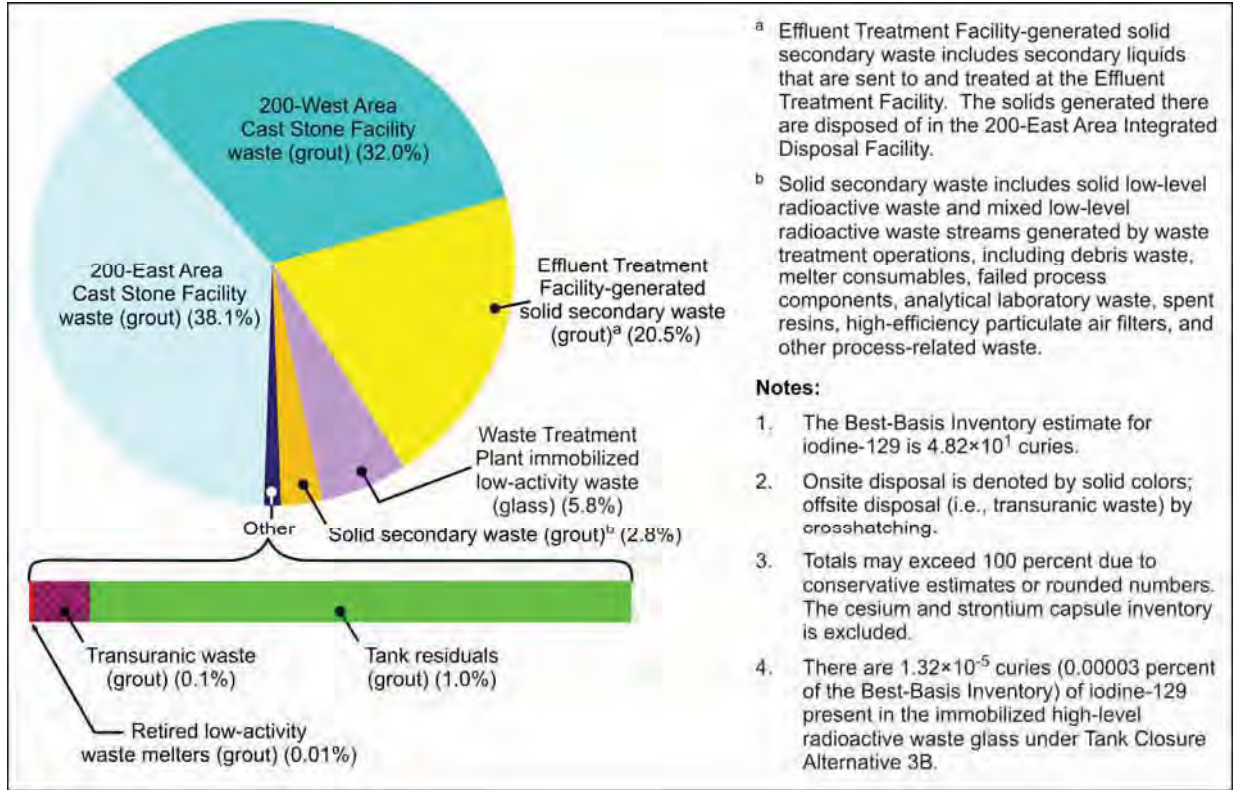

Figure D-30. Tank Closure Alternative 3B: Iodine-129 Distribution

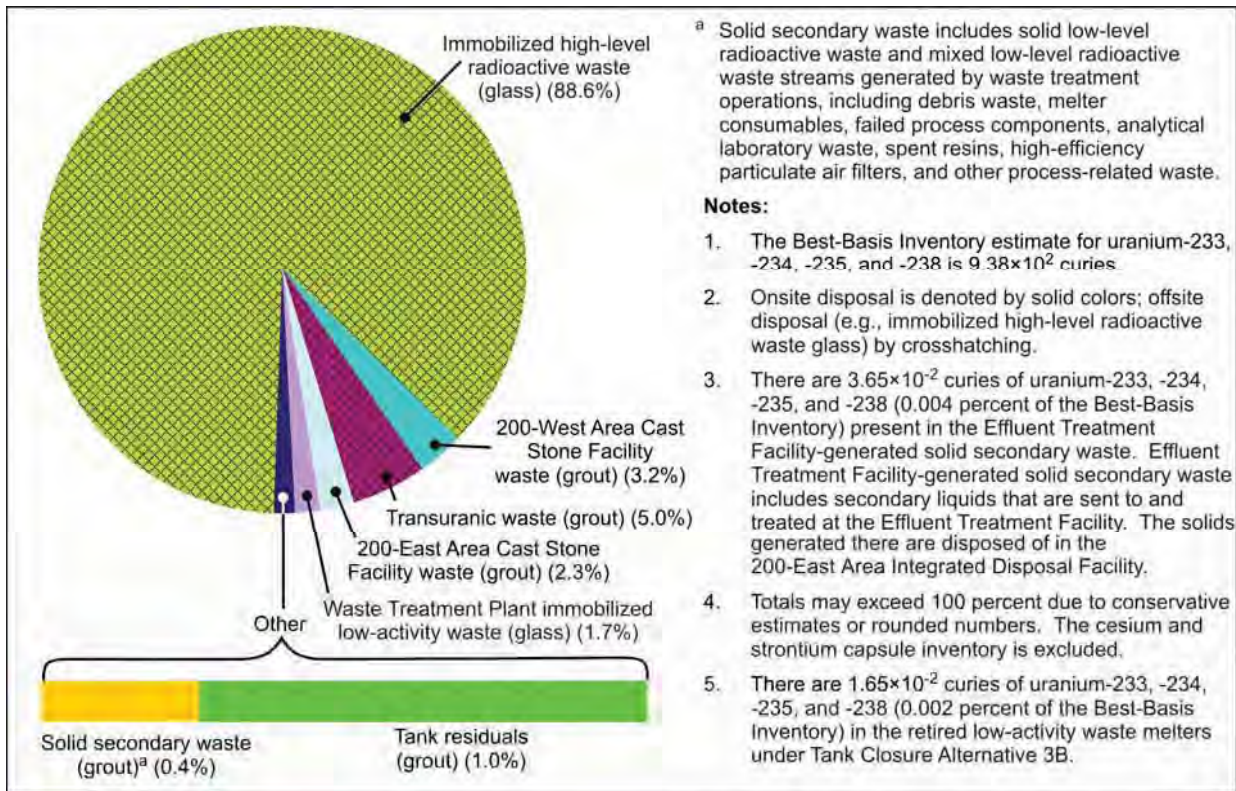

Figure D-31. Tank Closure Alternative 3B: Uranium Distribution

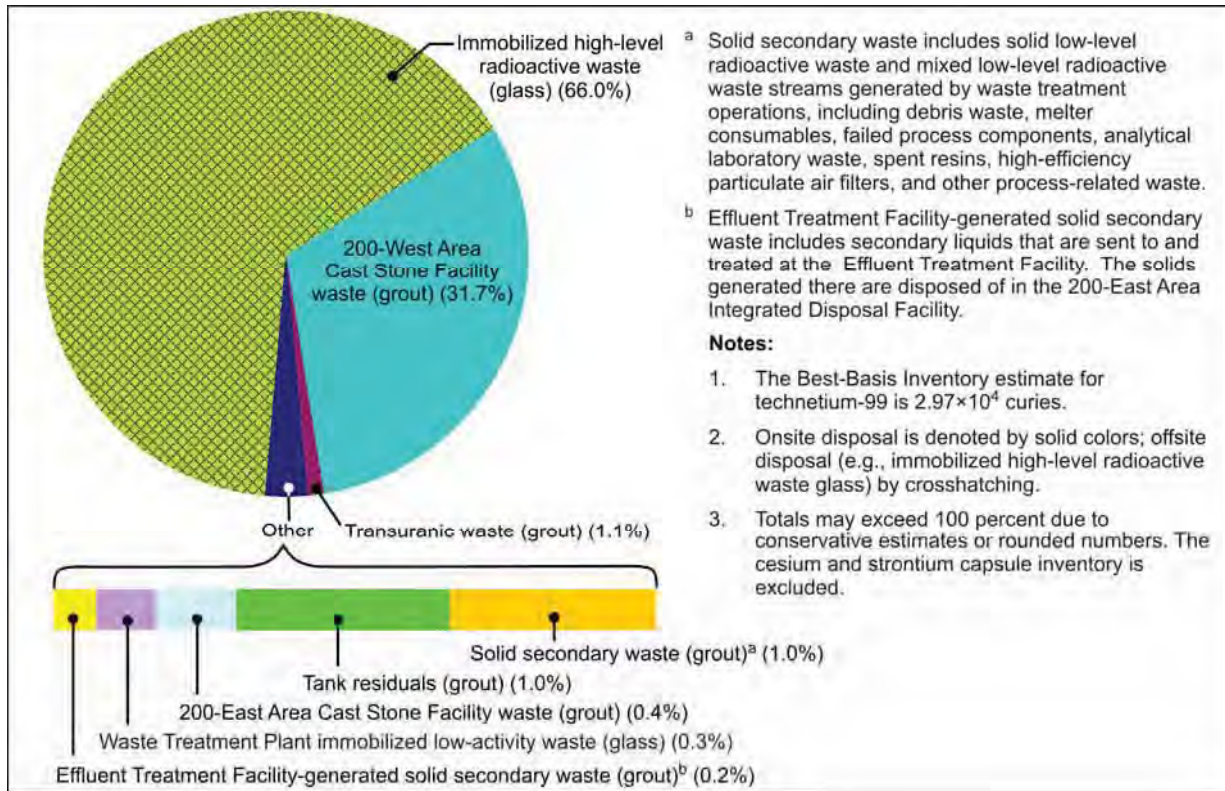

Figure D-32. Tank Closure Alternative 3B: Technetium-99 Distribution

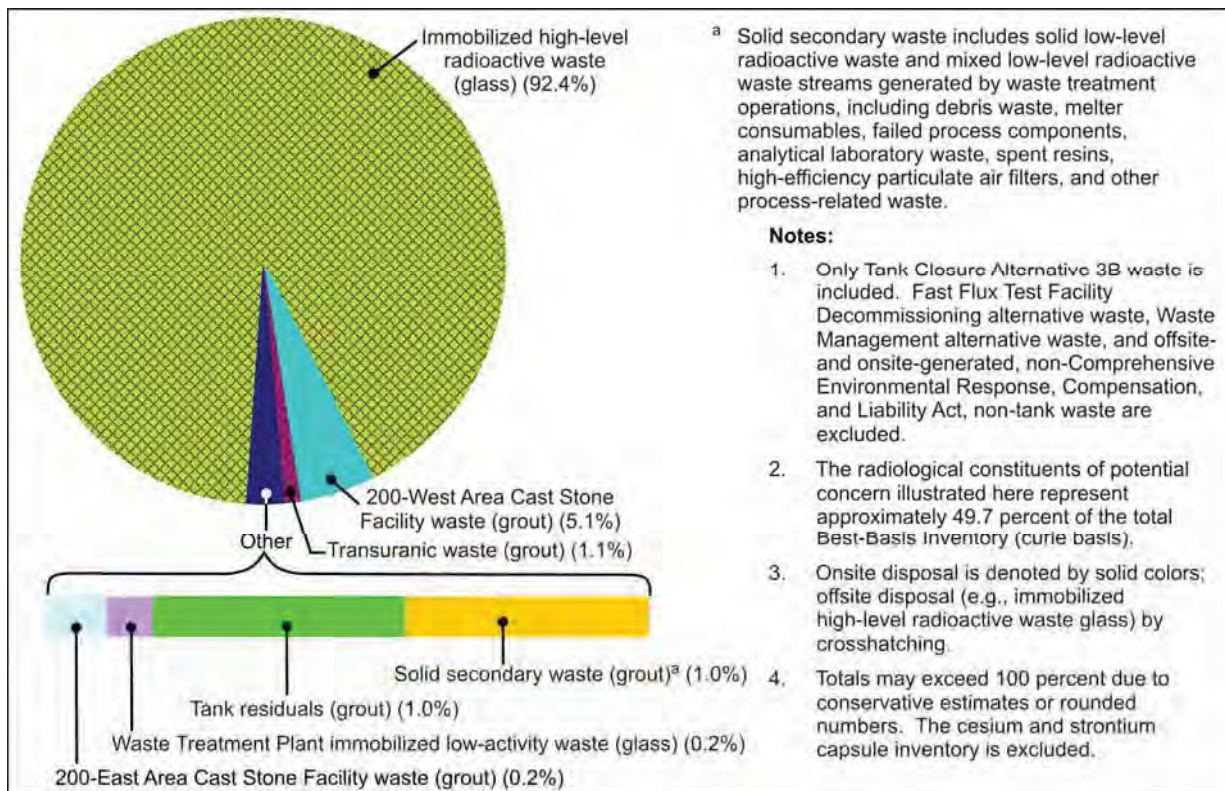

Figure D-33. Tank Closure 3B: Distribution of Total Radiological Constituents of Potential Concern

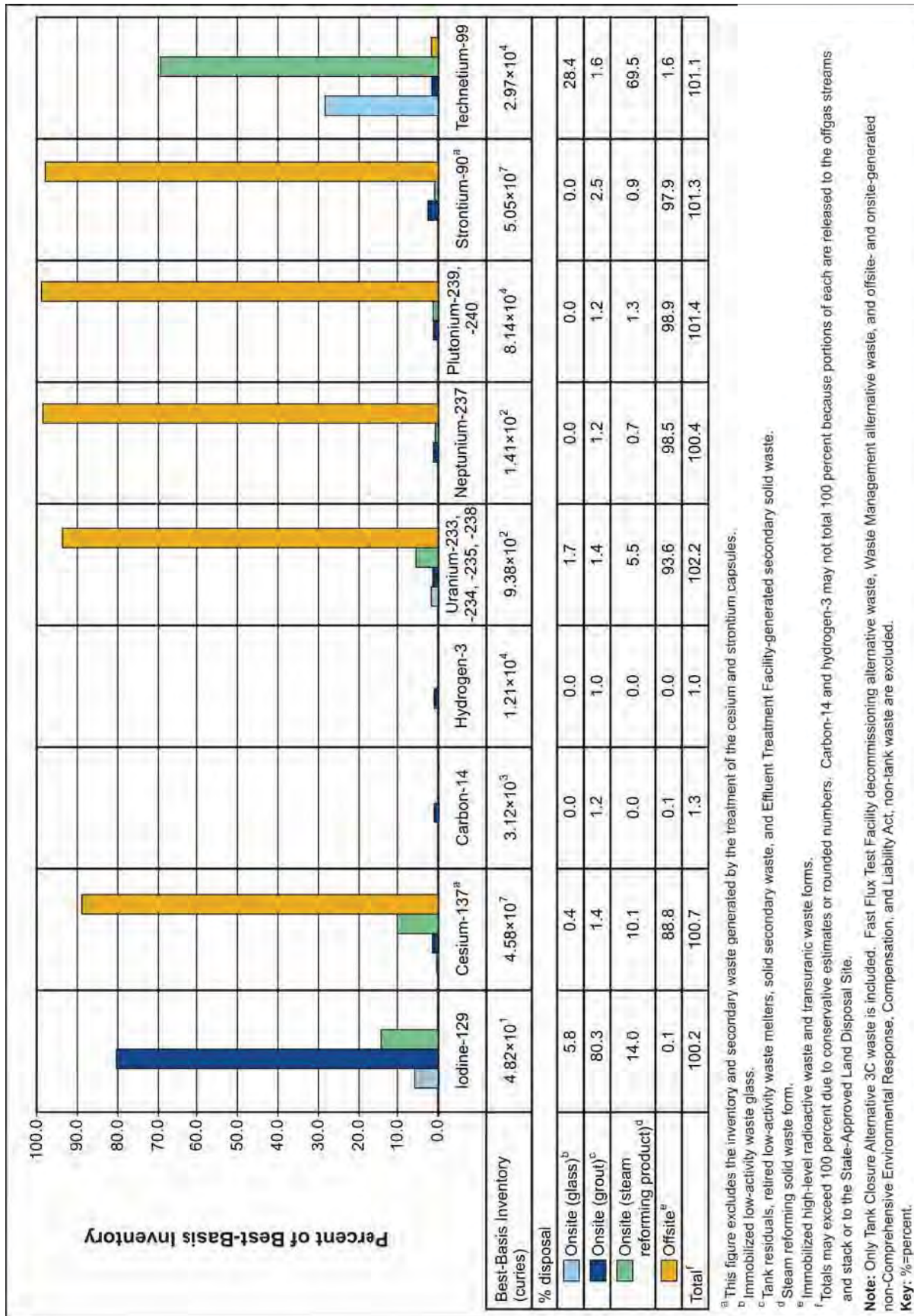

Figure D-34. Tank Closure Alternative 3C: Distribution of Radiological Constituents of Potential Concern

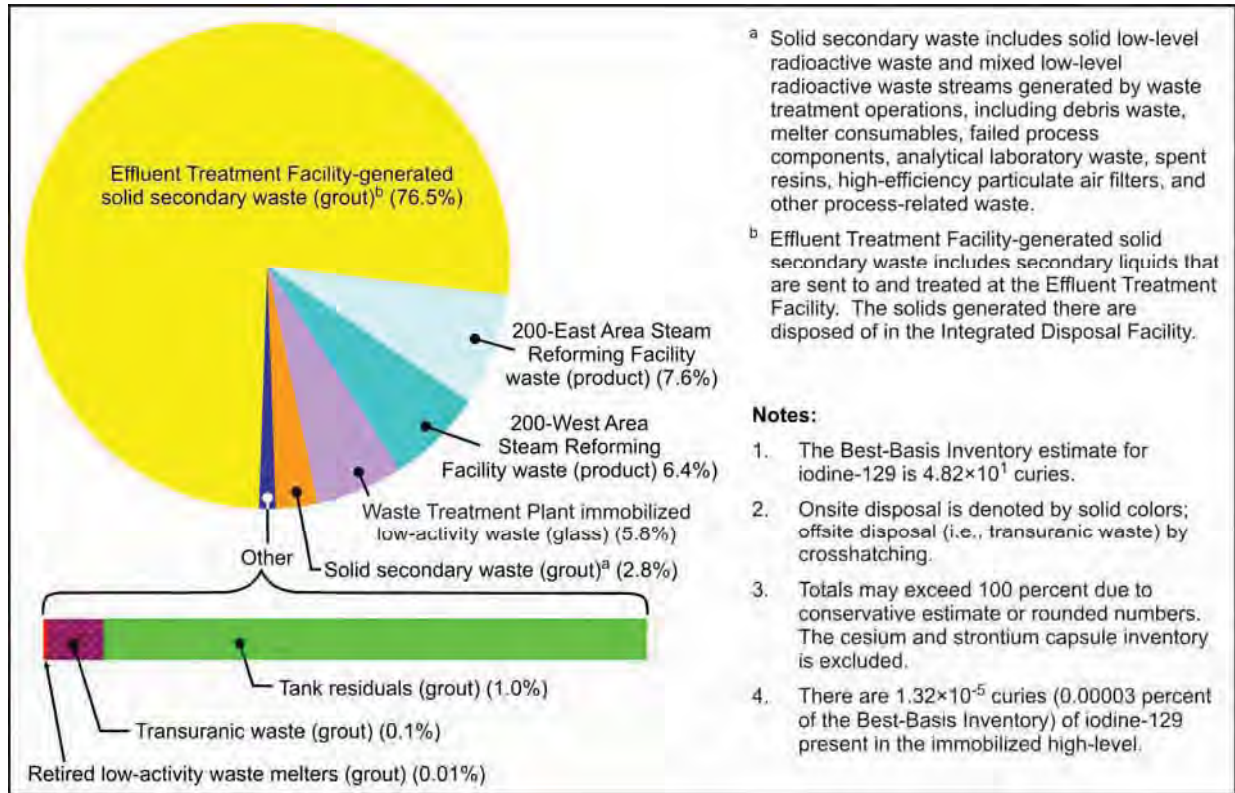

Figure D-35. Tank Closure Alternative 3C: Iodine-129 Distribution

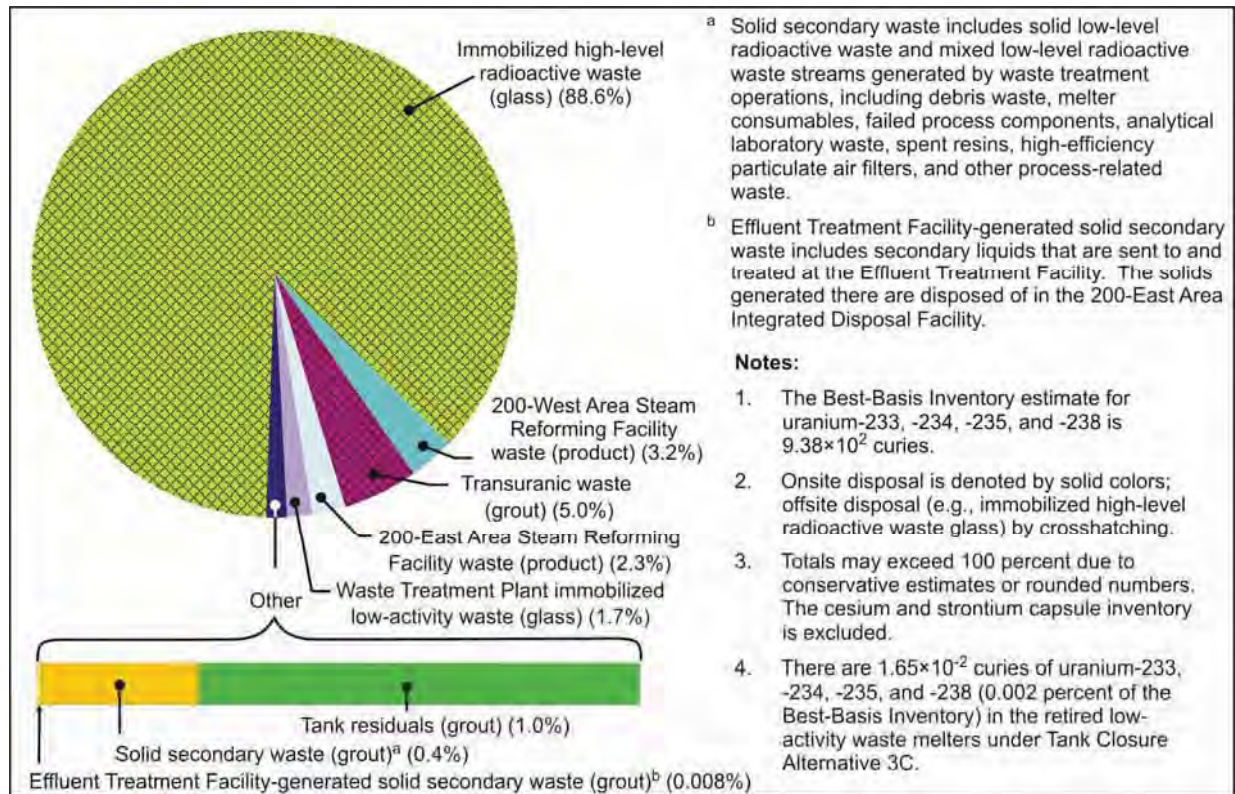

Figure D-36. Tank Closure Alternative 3C: Uranium Distribution

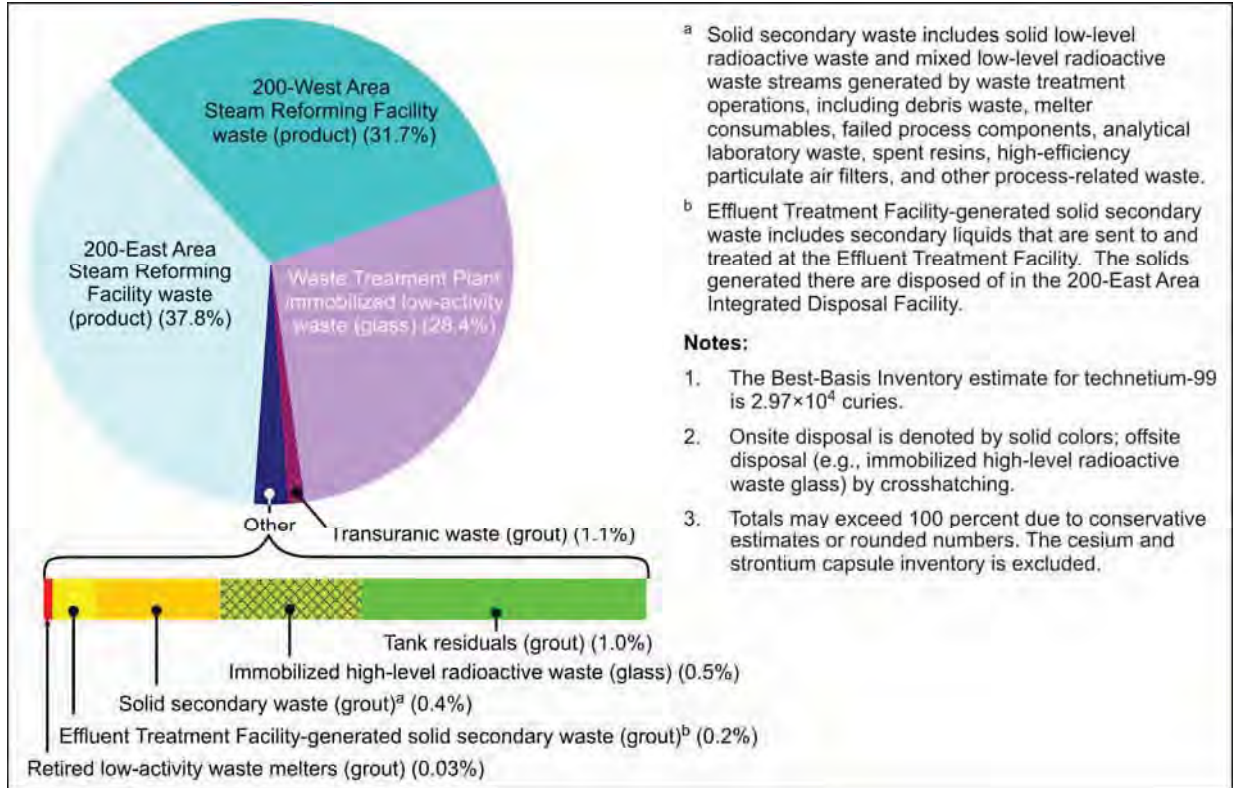

Figure D-37. Tank Closure Alternative 3C: Technetium-99 Distribution

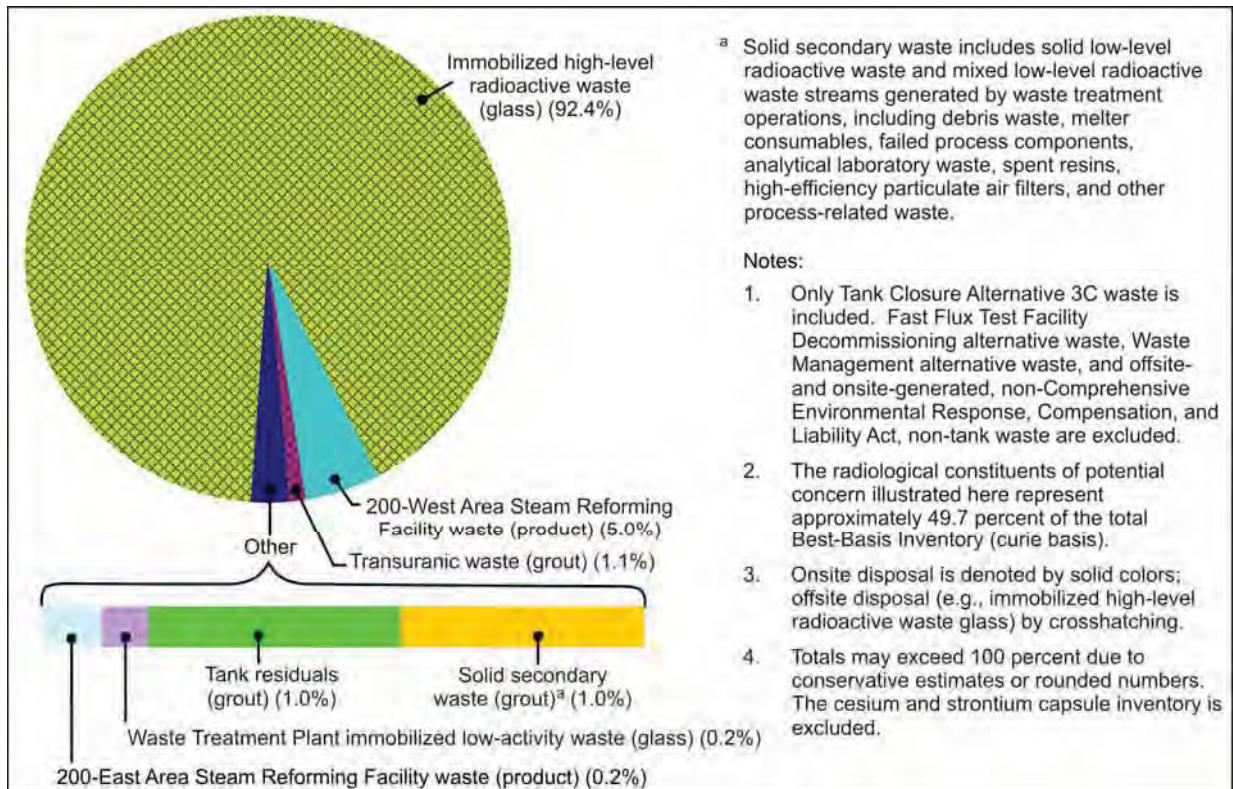

Figure D-38. Tank Closure Alternative 3C: Distribution of Total Radiological Constituents of Potential Concern

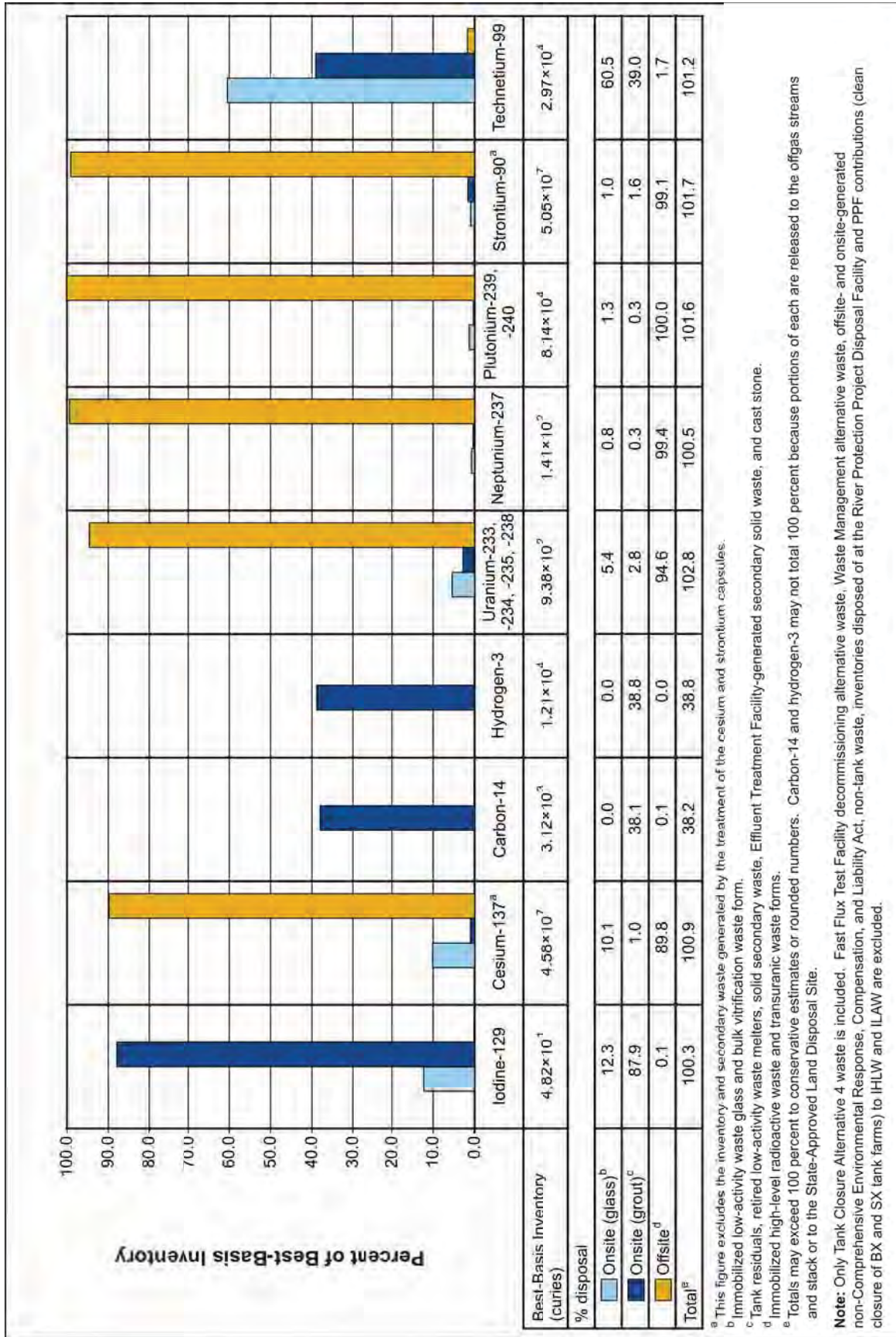

Figure D-39. Tank Closure Alternative 4: Distribution of Radiological Constituents of Potential Concern

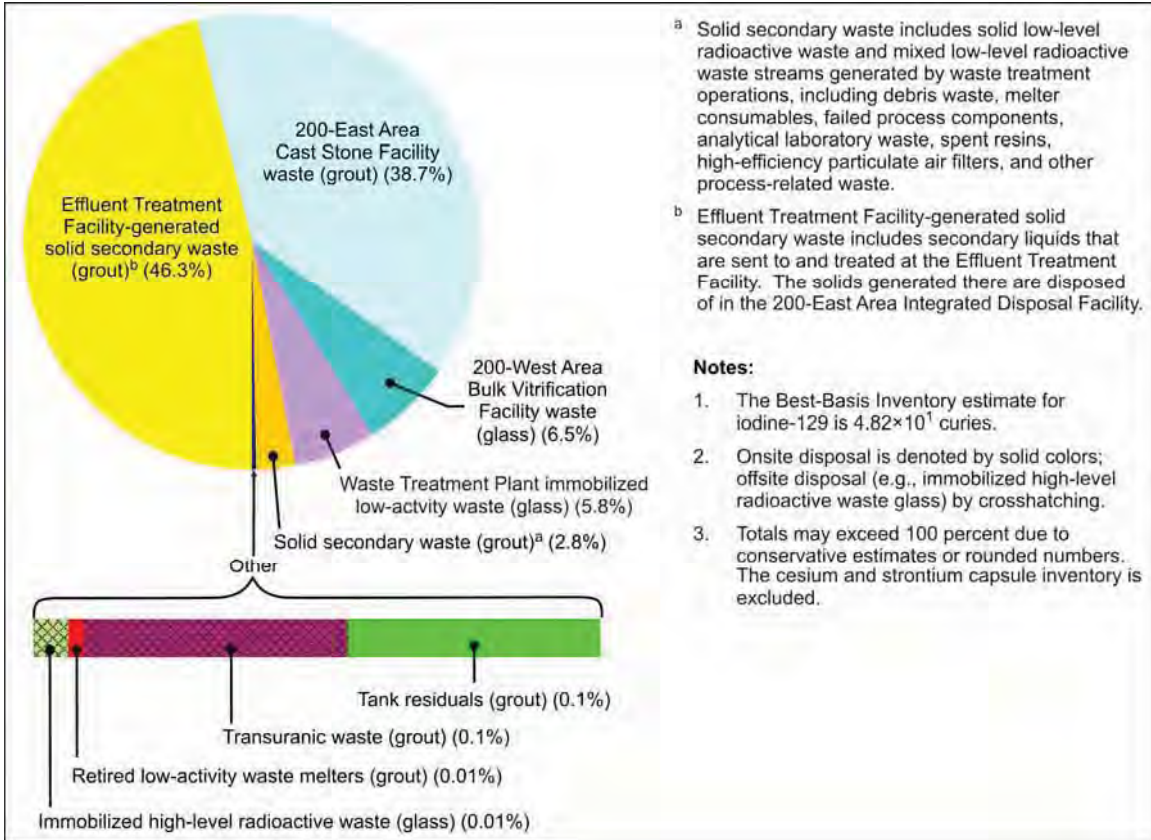

Figure D-40. Tank Closure Alternative 4: Iodine-129 Distribution

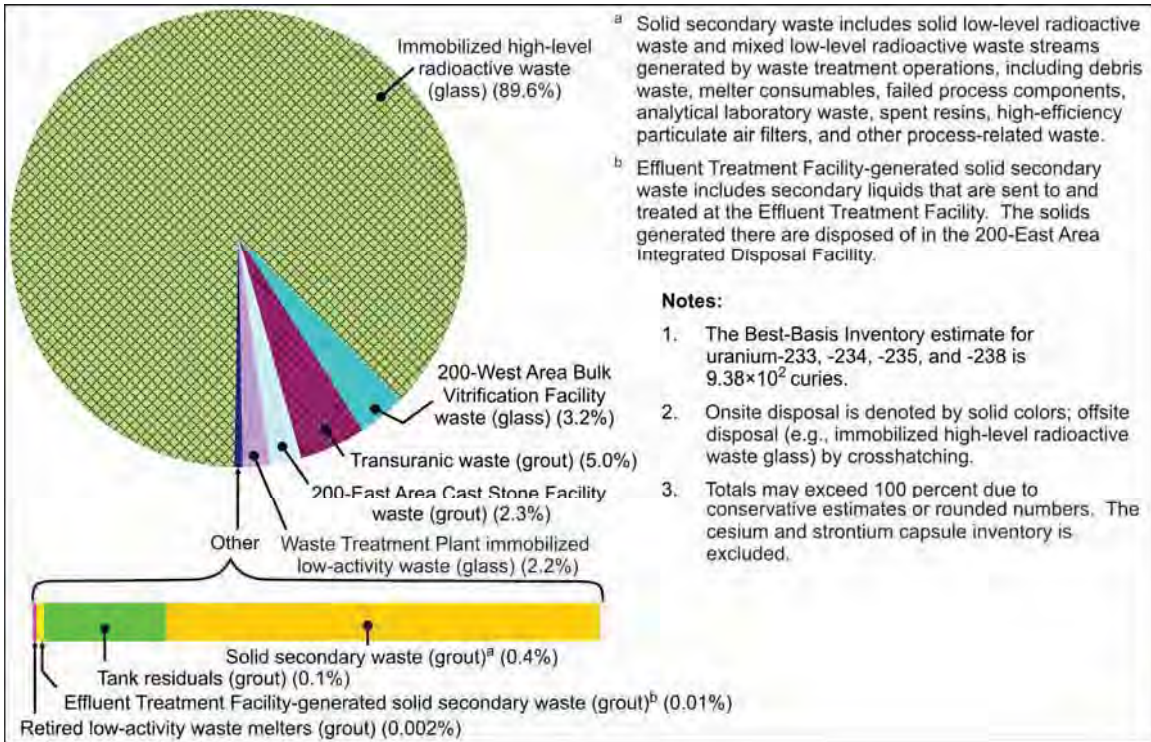

Figure D-41. Tank Closure Alternative 4: Uranium Distribution

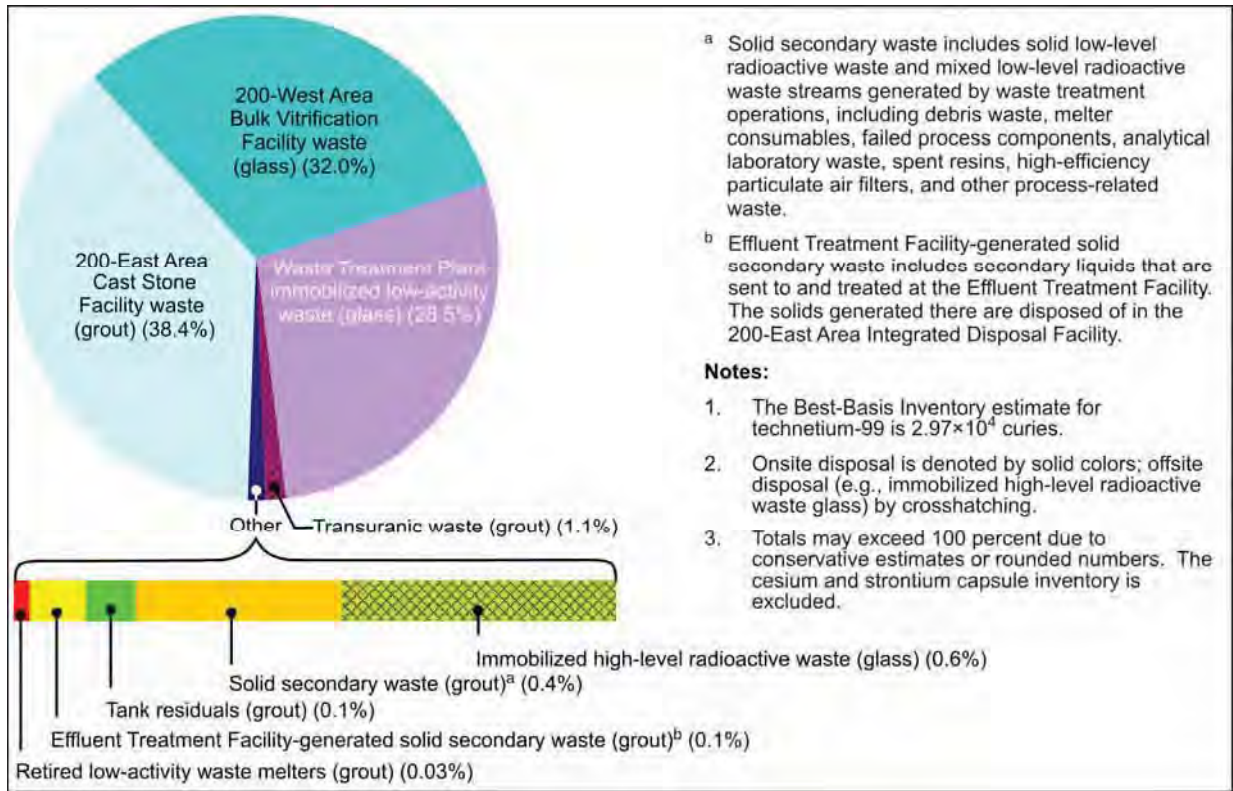

Figure D-42. Tank Closure Alternative 4: Technetium-99 Distribution

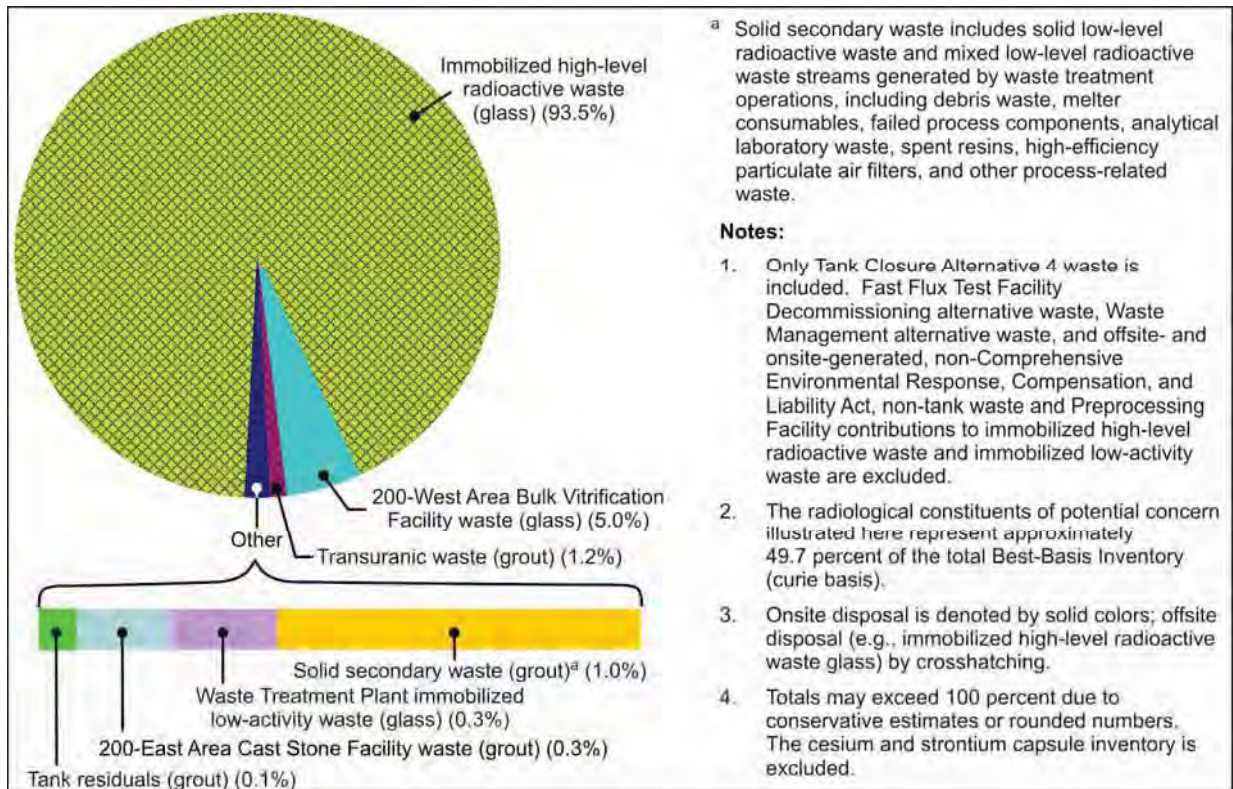

Figure D-43. Tank Closure Alternative 4: Distribution of Total Radiological Constituents of Potential Concern

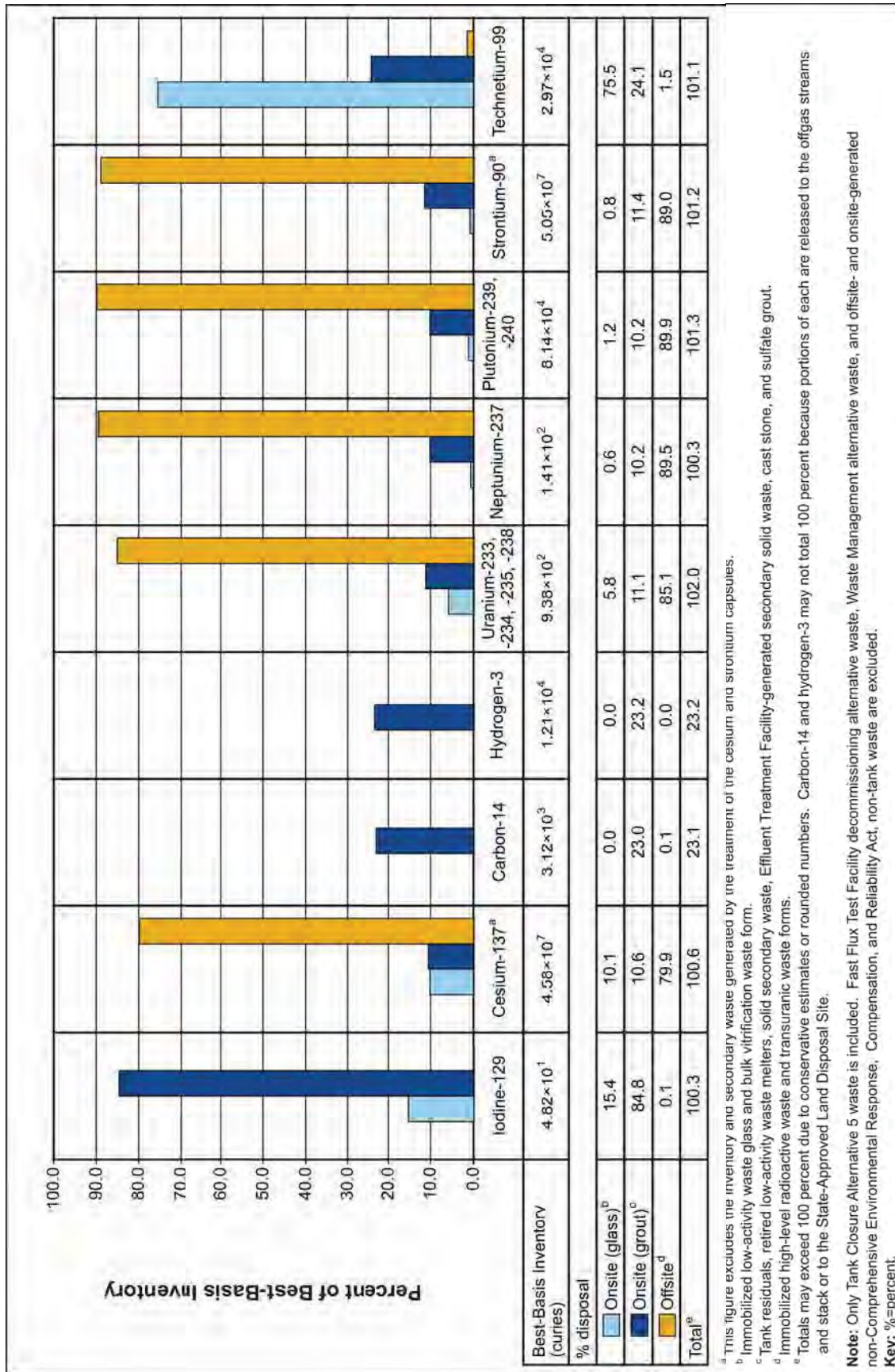

Figure D-44. Tank Closure Alternative 5: Distribution of Radiological Constituents of Potential Concern

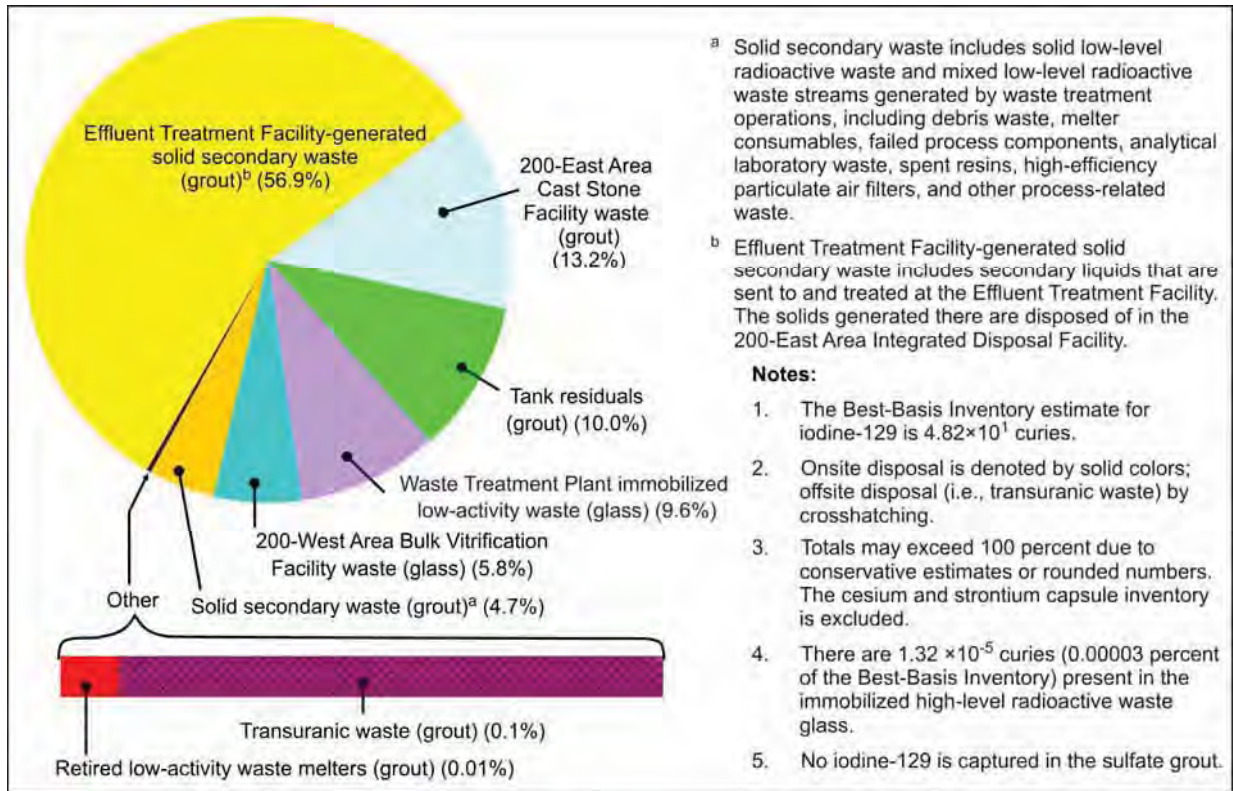

Figure D-45. Tank Closure Alternative 5: Iodine-129 Distribution

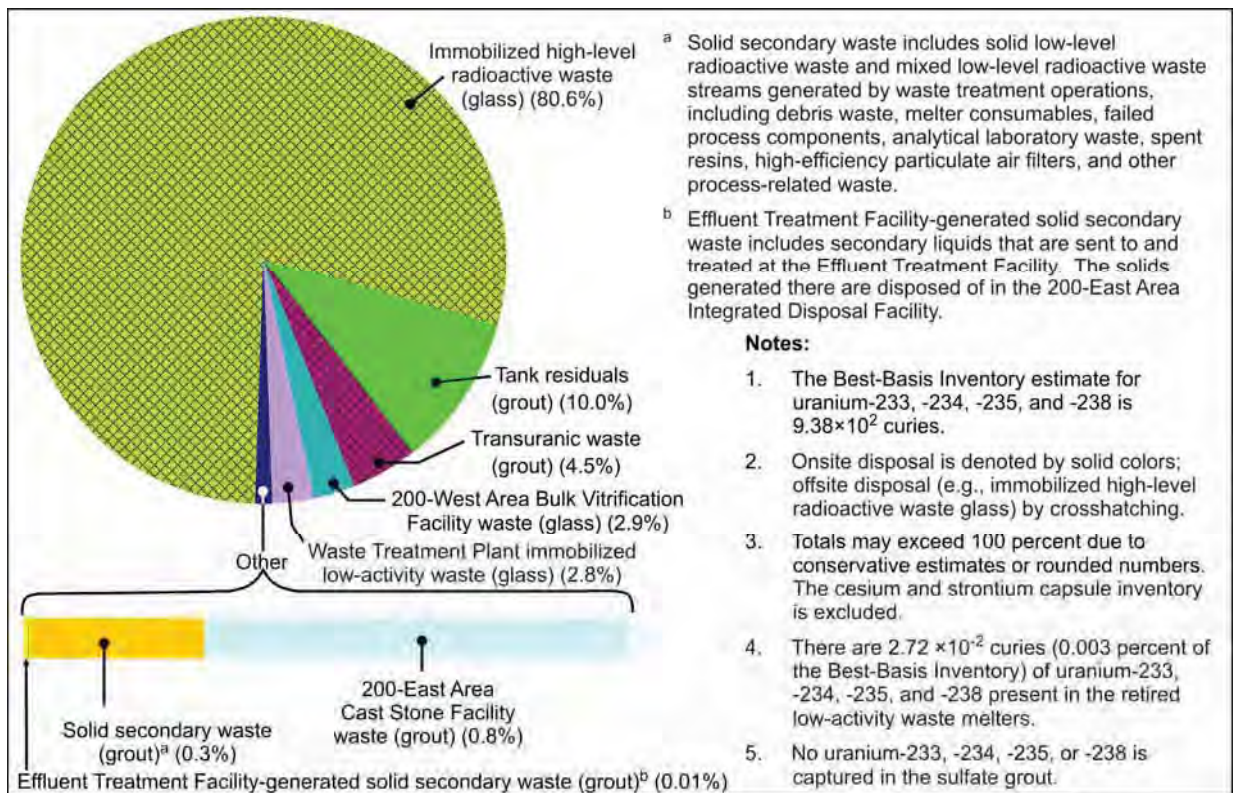

Figure D-46. Tank Closure Alternative 5: Uranium Distribution

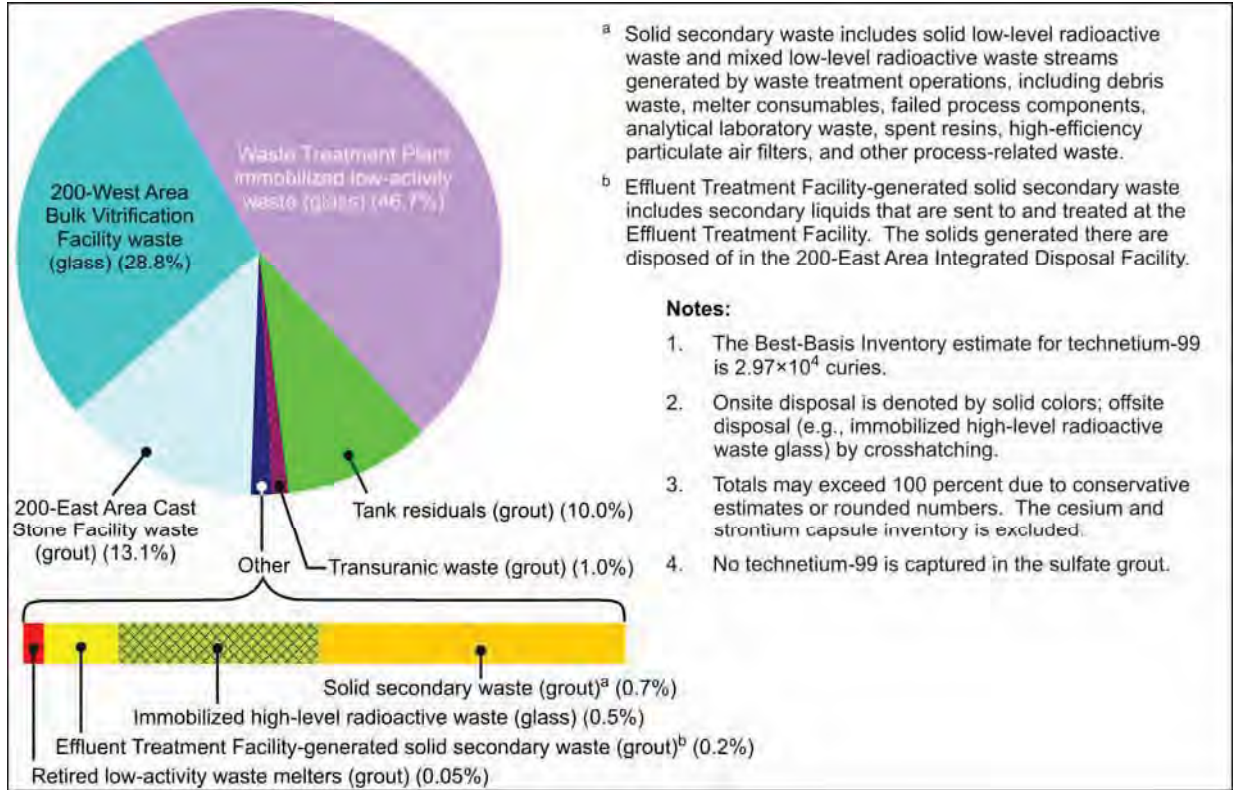

Figure D-47. Tank Closure Alternative 5: Technetium-99 Distribution

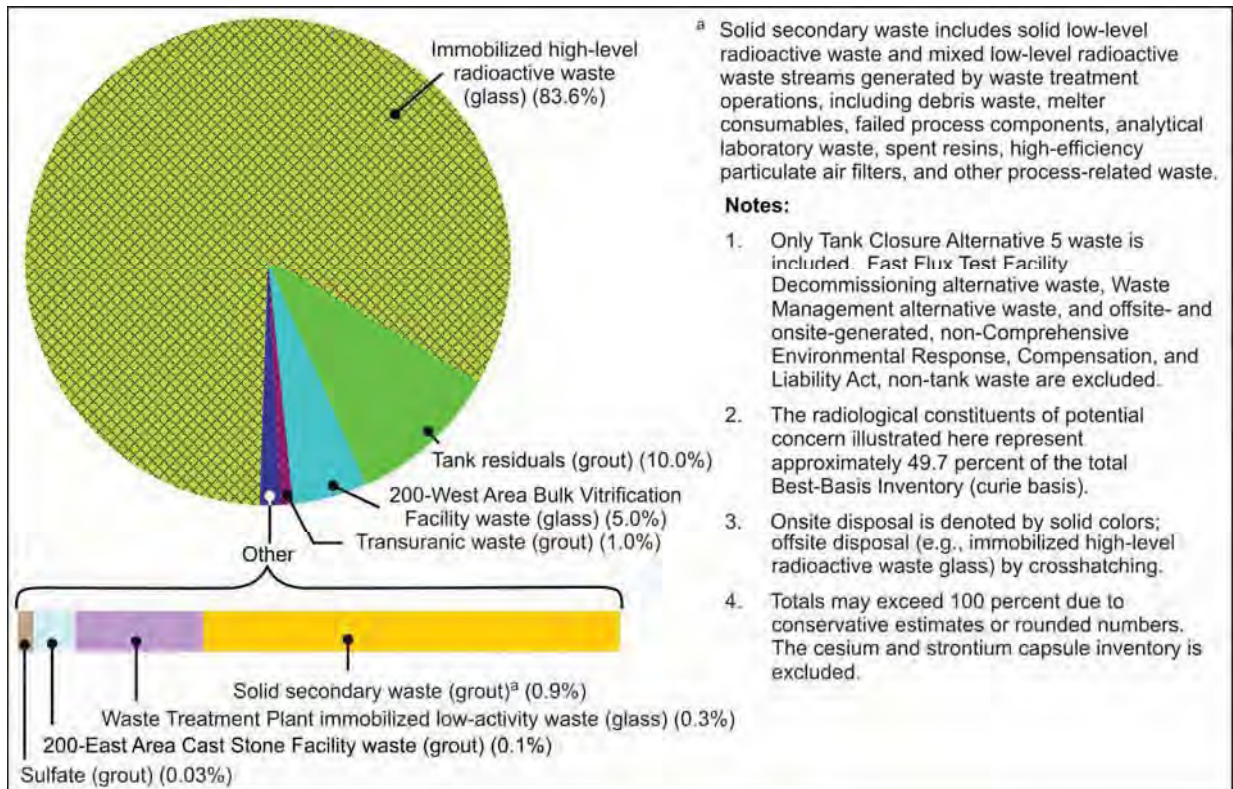

Figure D-48. Tank Closure Alternative 5: Distribution of Total Radiological Constituents of Potential Concern



Figure D-49. Tank Closure Alternative 6A, Base Case or Option Case: Distribution of Radiological Constituents of Potential Concern

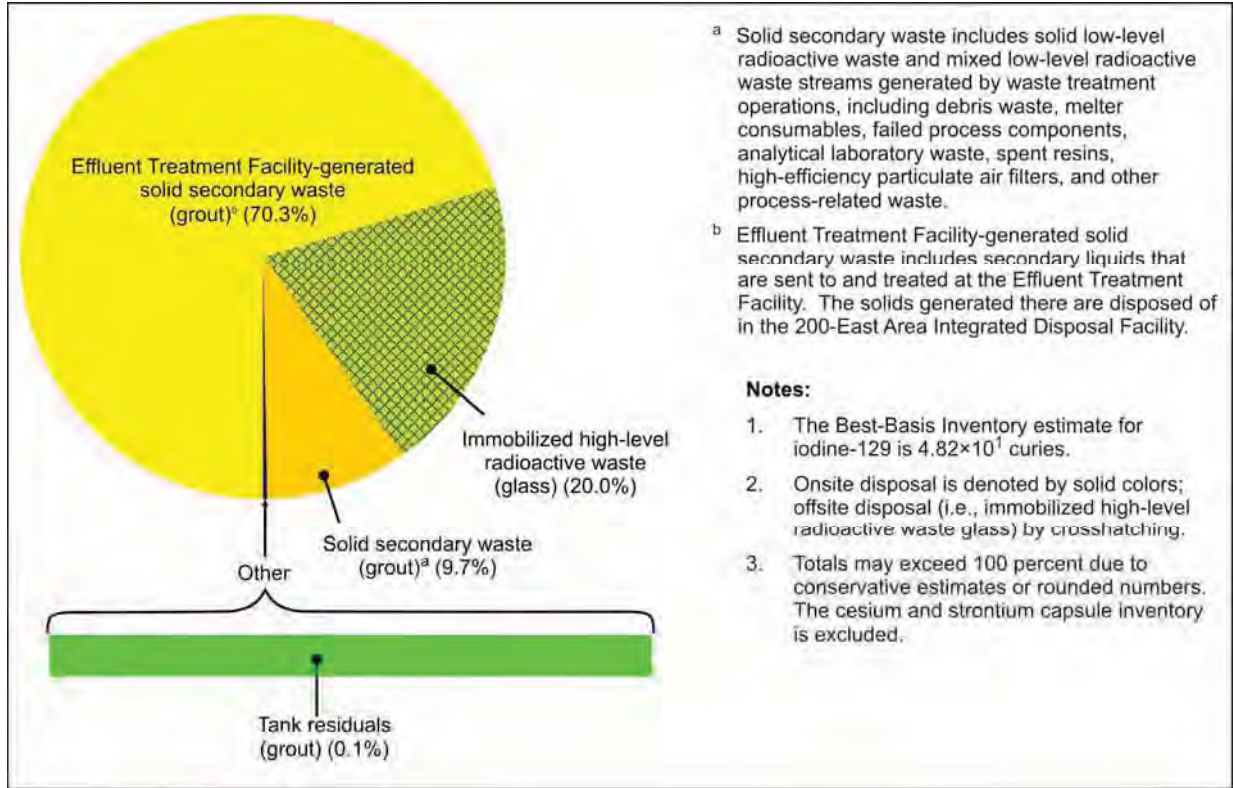

Figure D-50. Tank Closure Alternative 6A, Base Case or Option Case: Iodine-129 Distribution

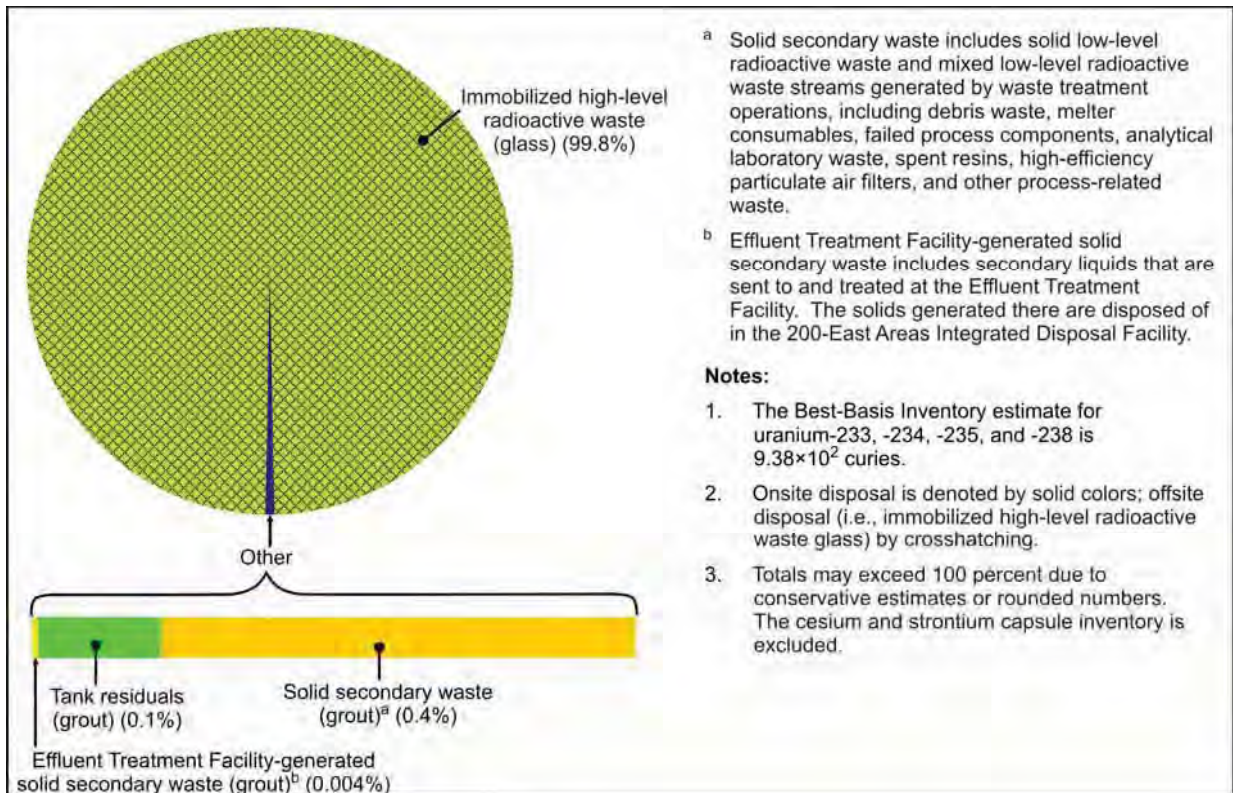

Figure D-51. Tank Closure Alternative 6A, Base Case or Option Case: Uranium Distribution

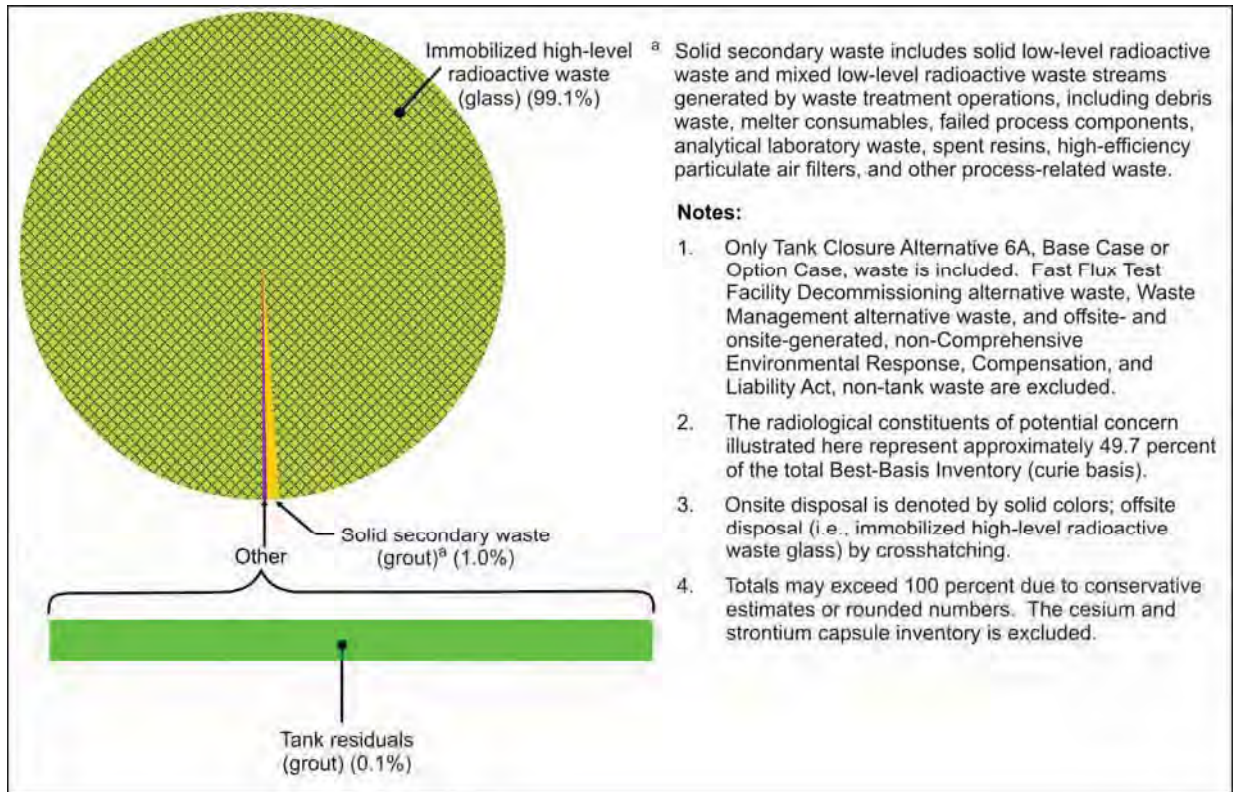
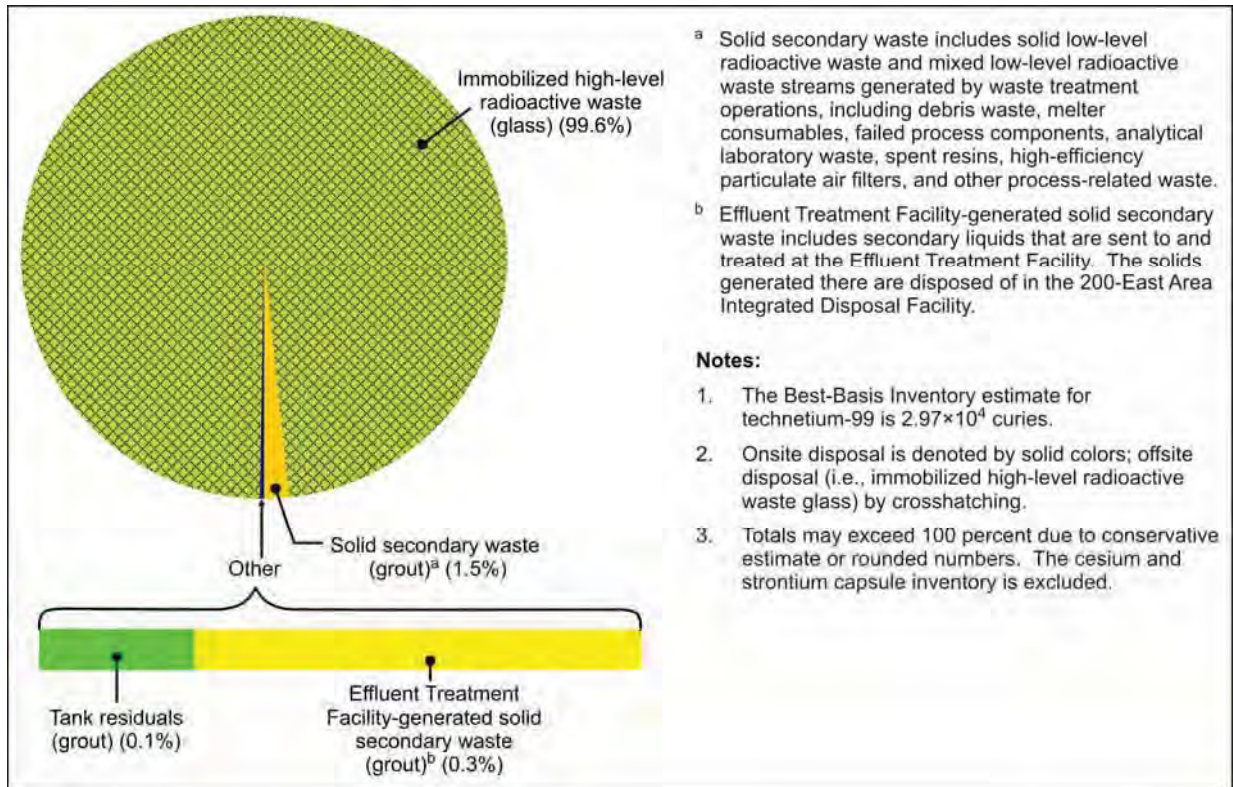



Figure D-54. Tank Closure Alternative 6B, Base Case or Option Case: Distribution of Radiological Constituents of Potential Concern

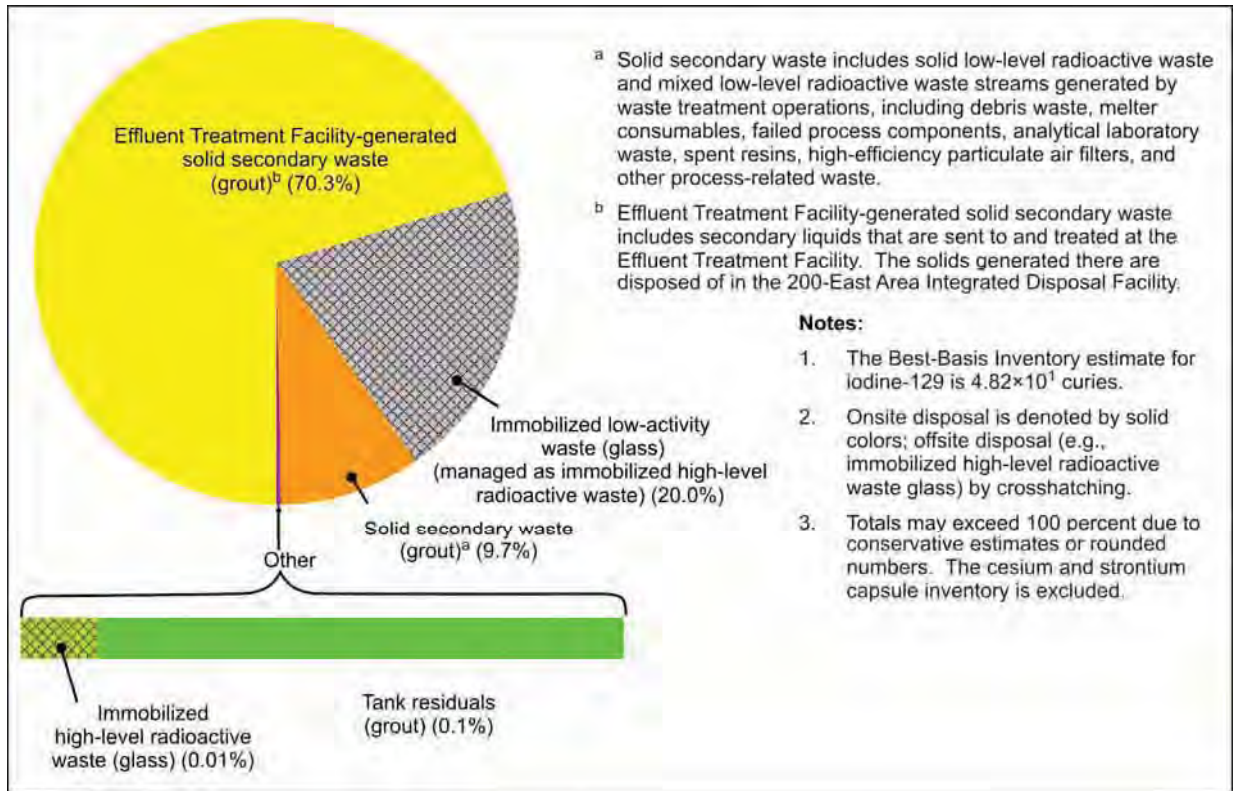

Figure D-55. Tank Closure Alternative 6B, Base Case or Option Case: Iodine-129 Distribution

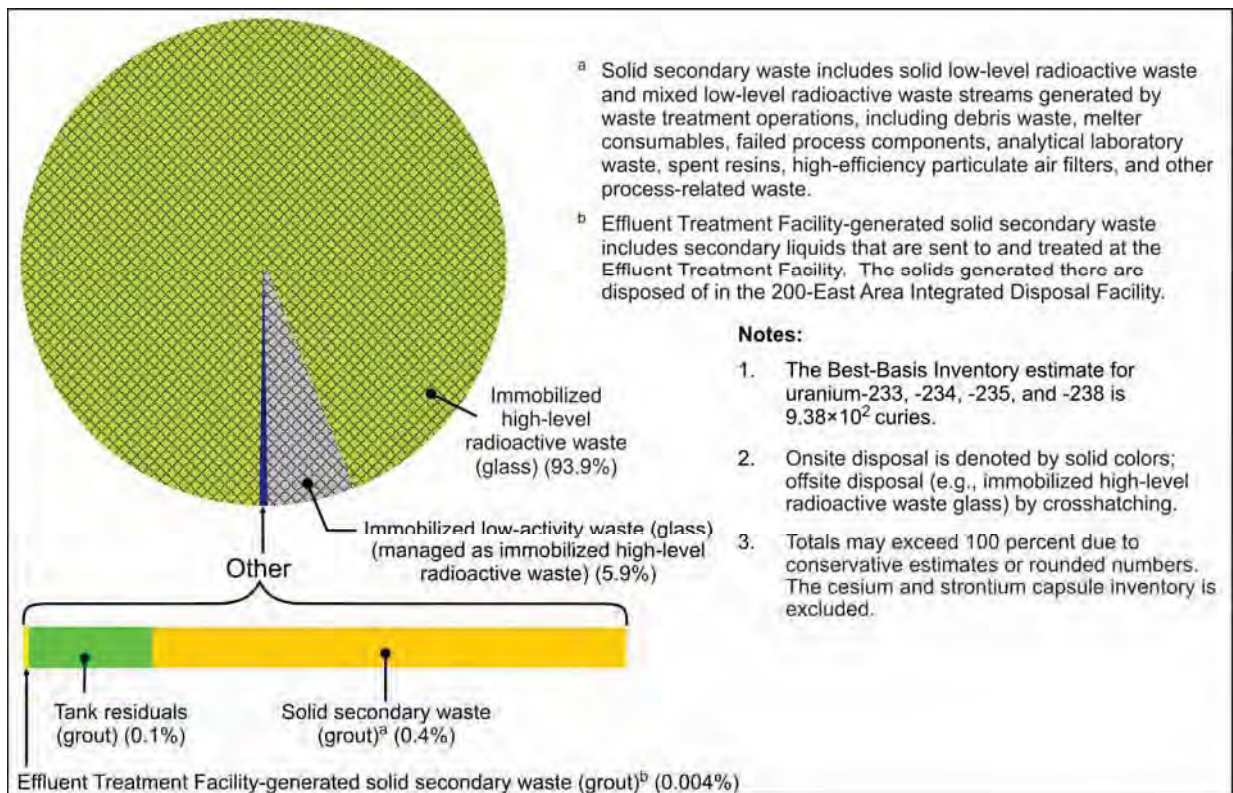

Figure D-56. Tank Closure Alternative 6B, Base Case or Option Case: Uranium Distribution

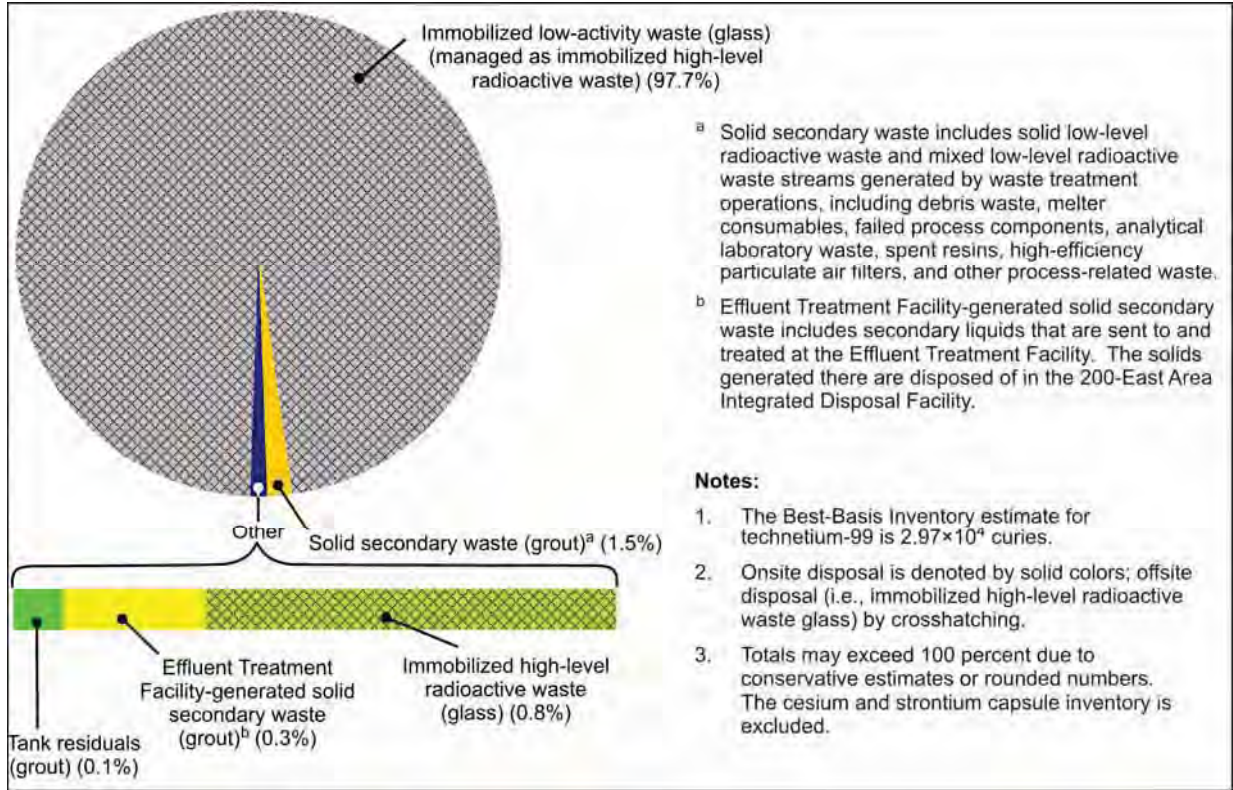

Figure D-57. Tank Closure Alternative 6B, Base Case or Option Case: Tchnetium-99 Distribution

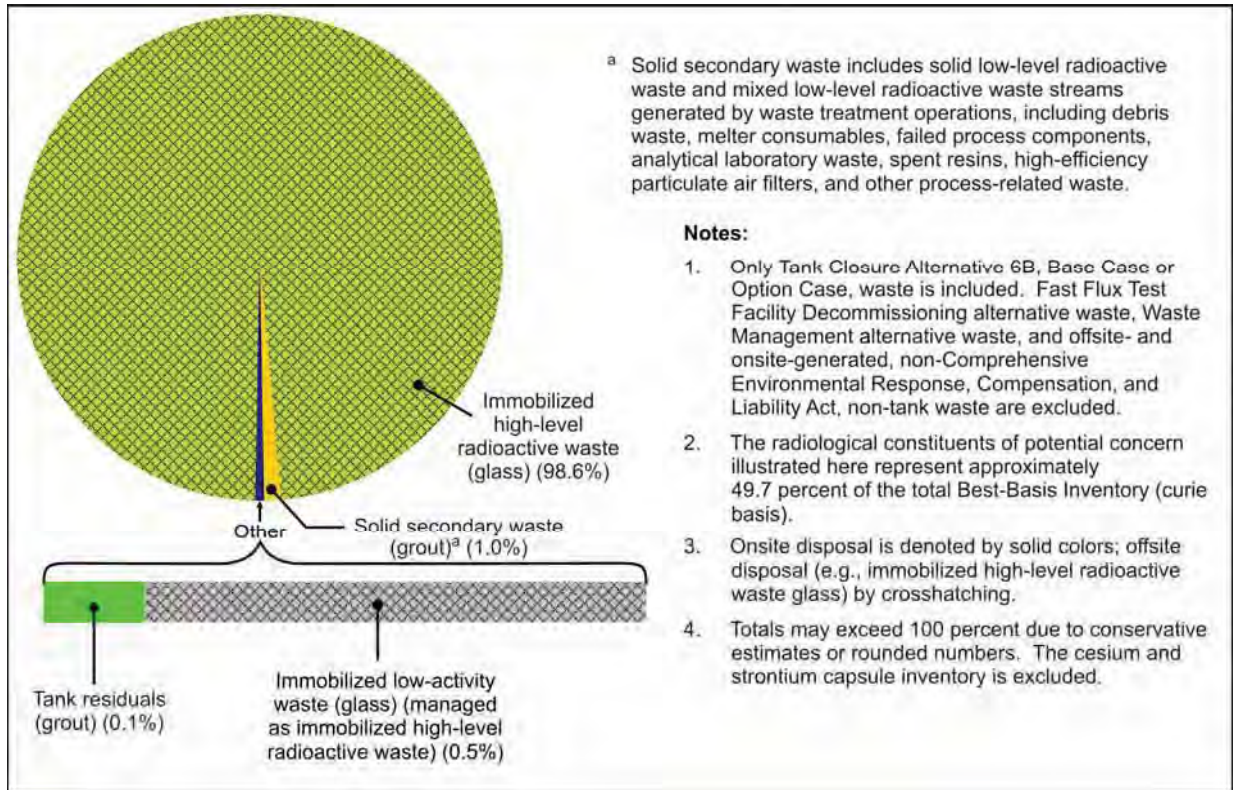

Figure D-58. Tank Closure Alternative 6B, Base Case or Option Case: Distribution of Total Radiological Constituents of Potential Concern

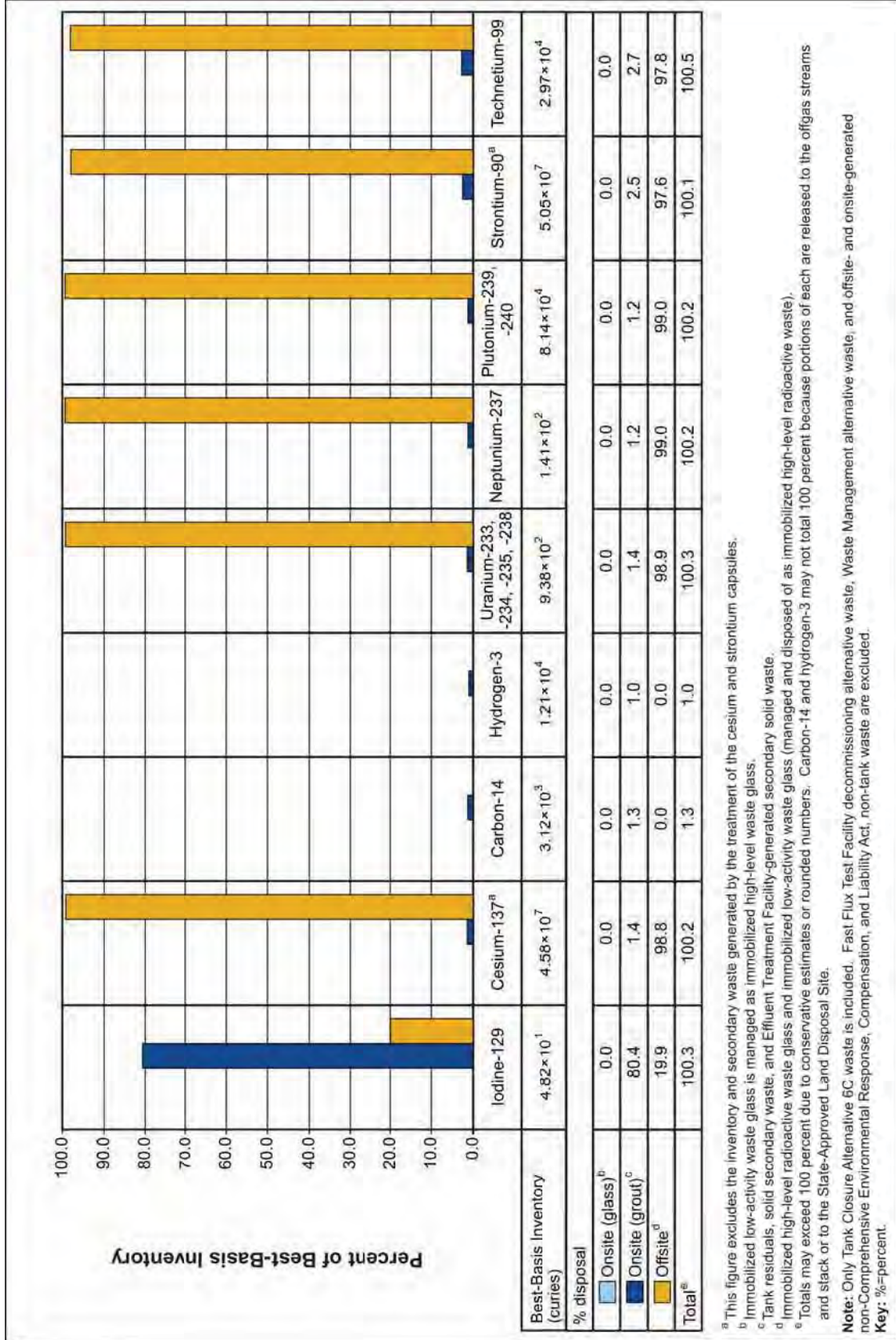

Figure D-59. Tank Closure Alternative 6C: Distribution of Radiological Constituents of Potential Concern

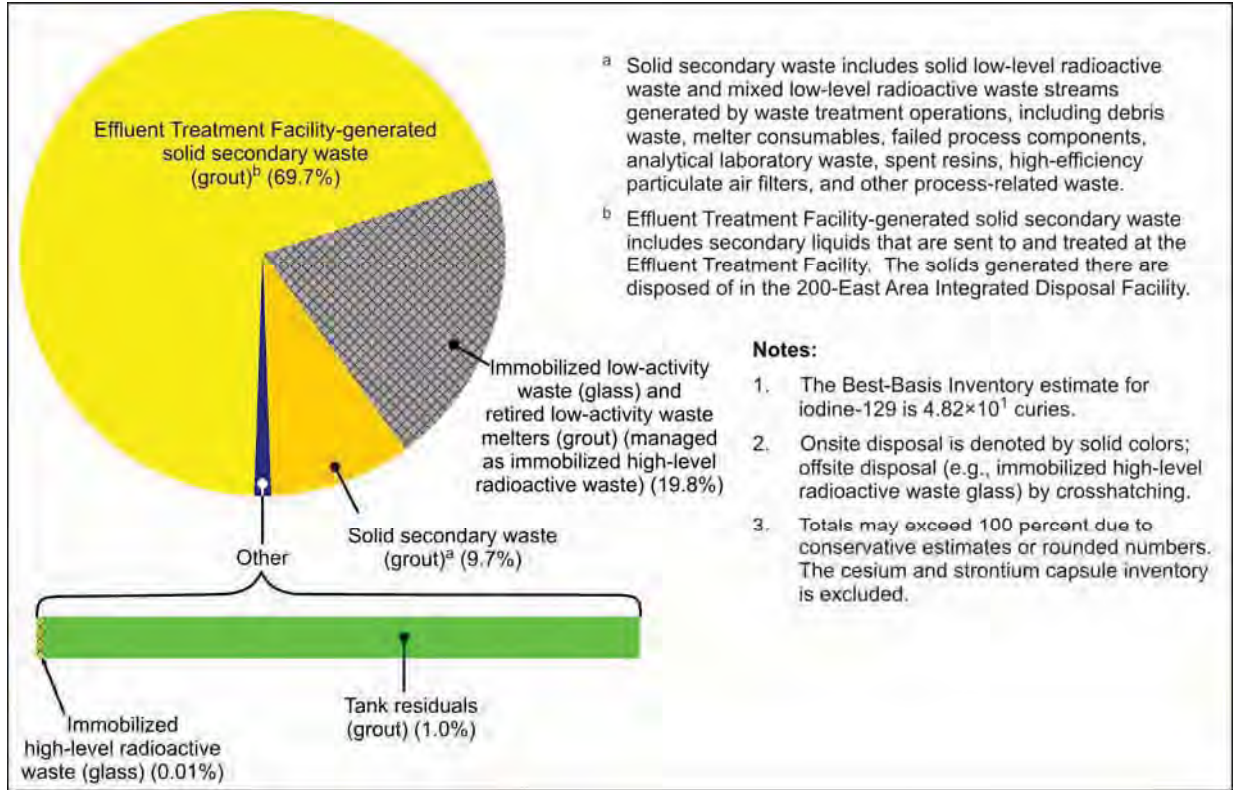

Figure D-60. Tank Closure Alternative 6C: Iodine-129 Distribution

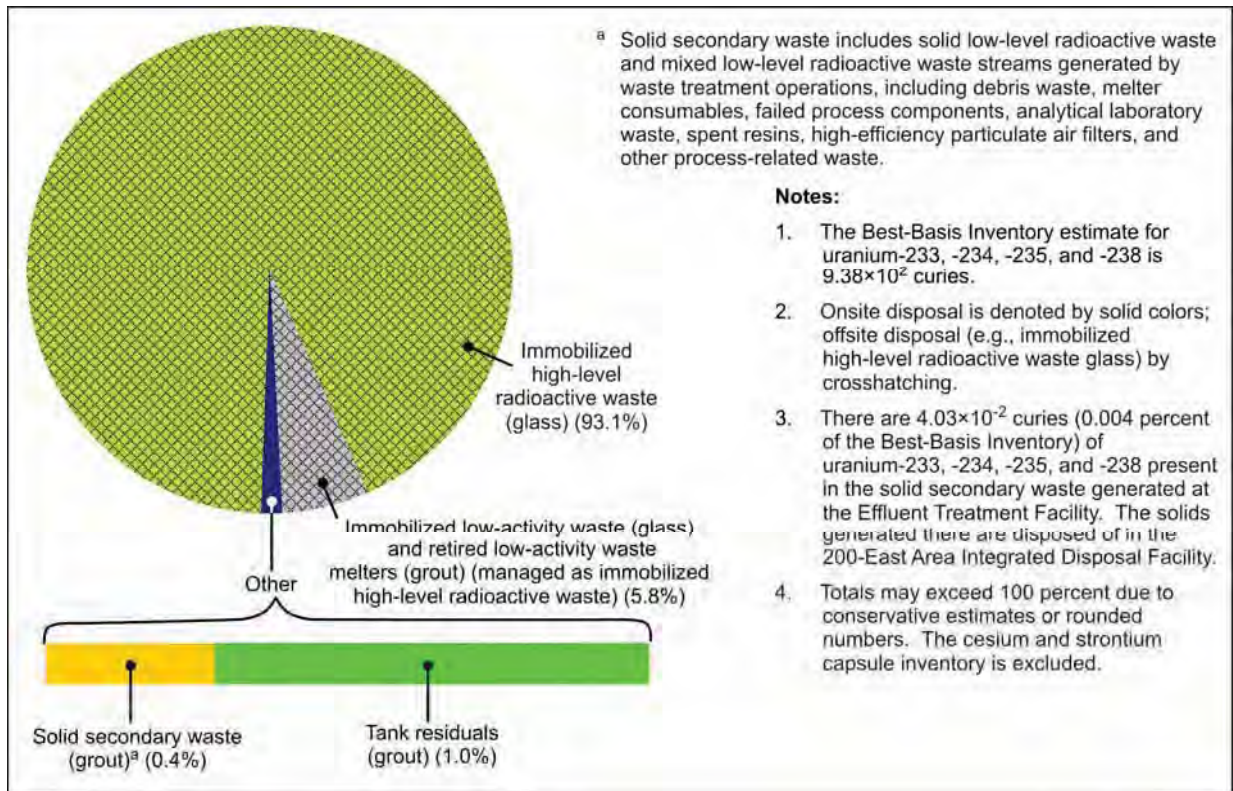

Figure D-61. Tank Closure Alternative 6C: Uranium Distribution

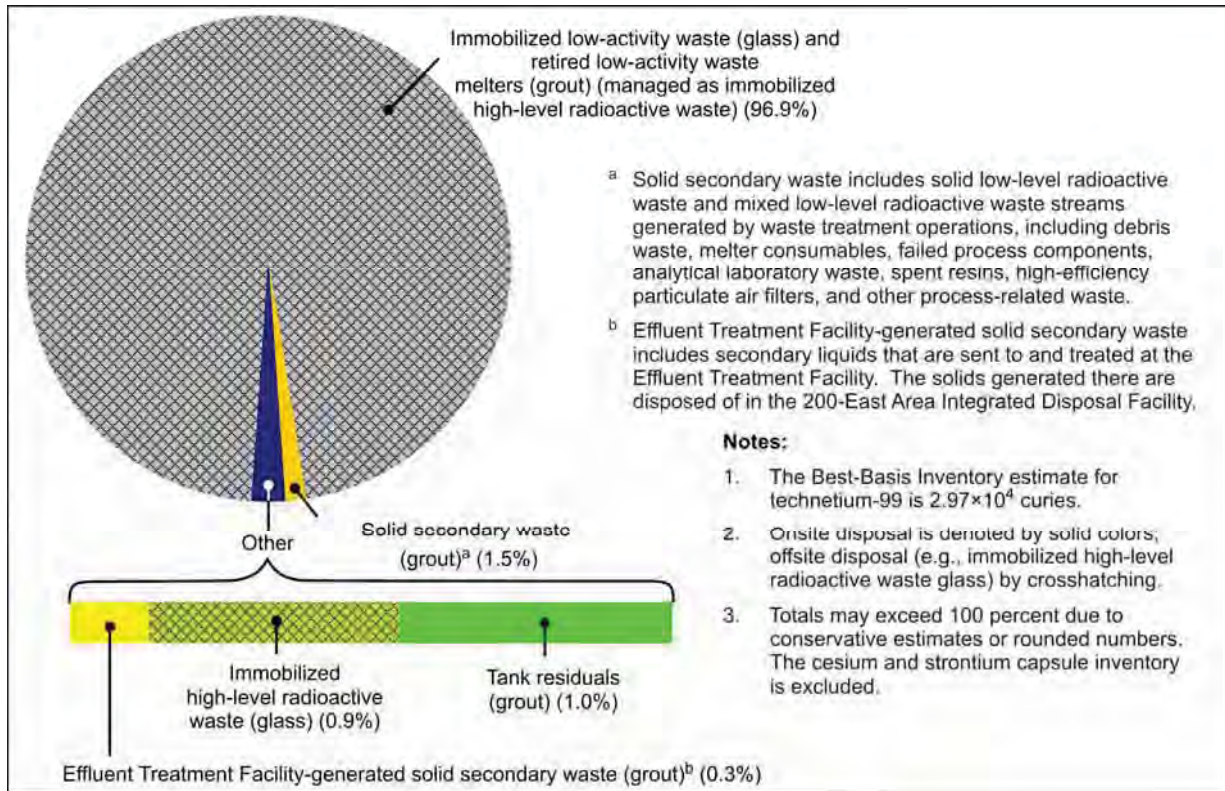

Figure D-62. Tank Closure Alternative 6C: Technetium-99 Distribution

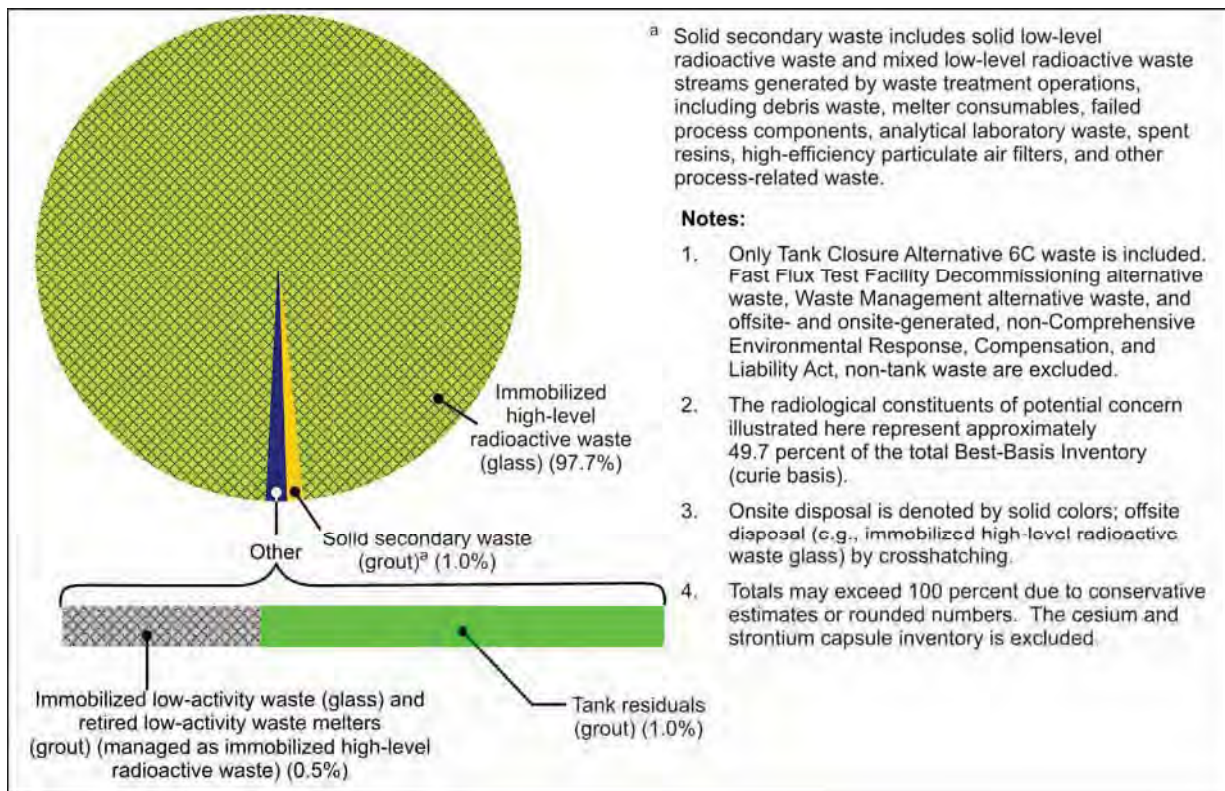

Figure D-63. Tank Closure Alternative 6C: Distribution of Total Radiological Constituents of Potential Concern

D.2 FTFF DECOMMISSIONING ALTERNATIVES

D.2.1 Radioactive and Chemical Inventories

This section summarizes the radioactive and chemical inventories that were analyzed for each of the three FTFF Decommissioning alternatives. Appendix E, Section E.2.3, provides a summary description of the FTFF Decommissioning alternatives analyzed in this *TC & WM EIS* and is partially reproduced in this section for the reader's convenience. The primary documentation prepared in support of the inventories presented in this section is *FTFF Radioactive and Hazardous Materials Inventory* (CEES 2006).

The following data supported the development of the radioactive and chemical inventories for each FTFF Decommissioning alternative.

D.2.1.1 Assumptions

Materials that were assumed to be removed during FTFF deactivation activities include:

- Special nuclear materials (associated with flux monitors)
- Nuclear fuel (SNF, nonirradiated fuel)
- Ethylene glycol (approximately 355,830 liters [94,000 gallons])
- Cooling tower chemicals
- Transformer oils containing PCBs (approximately 32,180 liters [8,500 gallons])
- Freon^{TM1} R-12 and R-22 (approximately 13,150 kilograms [29,000 pounds])
- Sulfuric acid (approximately 5,700 liters [1,500 gallons])
- Depleted ion exchange resins (approximately 8.5 cubic meters [300 cubic feet])
- Fuel oil (approximately 374,750 liters [99,000 gallons])
- Mobiltherm^{TM2} oil (approximately 7,750 liters [2,000 gallons])
- Chemical inventories identified in Attachment 2 the *Technical Information Document for the Fast Flux Test Facility Closure Project Environmental Impact Statement* (Fluor Hanford 2005a)
- Materials containing asbestos (approximately 76.5 cubic meters [100 cubic yards]) (DOE 1995, 2006a).

¹ Freon is a registered trademark of E.I. du Pont de Nemours and Company, Wilmington, Delaware.

² Mobiltherm is a registered trademark of Socony Mobil Oil Company, Inc., New York, New York.

D.2.1.2 Fast Flux Test Facility Inventory

The FFTF radionuclide and hazardous materials inventory is summarized in this section according to the following categories:

1. Sodium Inventory
 - a. Volumetric inventory of sodium
 - b. Radionuclide inventory of sodium
2. Radionuclide inventory from activation
 - a. Activated reactor vessel and hardware
 - b. Activated concrete bioshield
3. Radionuclide inventory from contamination
4. Nonradioactive hazardous materials inventory

D.2.1.3 FFTF Bulk Sodium Inventory

The FFTF sodium inventory includes (1) the sodium from the FFTF primary and secondary cooling systems, (2) the sodium in the Fuel Storage Facility and interim decay storage vessel, and (3) the sodium-potassium alloy from the secondary auxiliary cooling systems (for the primary cold trap filter and Fuel Storage Facility pool) and pressure transducers. The other Hanford bulk sodium, from the Hallam Reactor and Sodium Reactor Experiment, is described in Appendix E, Section E.2.4.1.

The total FFTF sodium inventory has been reported as approximately 984,200 liters (260,000 gallons). The volumes associated with this reported volume for the different FFTF systems are shown in Table D–67. Current estimates have reduced this sodium volume to 958,000 liters (253,000 gallons). As of June 2007, approximately 916,000 liters (242,000 gallons) of radioactively contaminated bulk sodium have been drained from the FFTF reactor vessel, three primary and three secondary heat transport system loops, the Fuel Storage Facility, and the interim decay storage vessel and associated auxiliary systems; this bulk sodium was transferred to the Sodium Storage Facility. Also, the sodium-potassium alloy, contained in pressure transducers, was removed from FFTF. Additional drainage activities that are planned would result in an estimated volume of approximately 15,140 liters (4,000 gallons) of sodium residuals remaining in the drained systems. Appendix E, Section E.2.4.1, of this EIS contains additional descriptions of the FFTF sodium inventory (Chapin 2007).

Table D–67. Fast Flux Test Facility Systems Bulk Sodium Volumes

| Fast Flux Test Facility System | Volume (liters) |
|--------------------------------|-----------------|
| Primary cooling system | 530,000 |
| Secondary cooling system | 249,800 |
| Fuel Storage Facility | 117,300 |
| Interim decay storage vessel | 87,100 |
| Total^a | 984,200 |

^a The total excludes a nominal 2,271 liters of sodium-potassium alloy that was removed from FFTF.

Note: To convert liters to gallons, multiply by 0.26417.

Source: CEES 2006.

The constituent concentrations and quantities remaining in the FFTF primary and secondary sodium loops are provided in Table D–68. At a minimum, these constituents would be present in the various components in proportion to their sodium residuals volume. Additional quantities of these constituents

may be present in the components based on their function (e.g., cold traps); however, the additional quantities in the specific components are unknown.

Table D-68. Fast Flux Test Facility Sodium Contaminant Constituents

| Constituent | Sodium Analysis | | | Constituent Inventory | | |
|----------------------|-----------------------|------------------|-----------------|--|--|--------|
| | Primary Sodium | Secondary Sodium | Units | Quantity in Sodium Residuals (15,140 liters) (4,000 gallons) | Quantity in Total FFTF Sodium (984,200 liters) (260,000 gallons) | Units |
| Silver | < 0.02 | 0.01 | ppm by wt | 2.86×10^{-4} | 1.86×10^{-2} | kg |
| Aluminum | 0.2 | 0.5 | ppm by wt | 7.17×10^{-3} | 4.67×10^{-1} | kg |
| Boron | < 0.04 | 0.3 | ppm by wt | 4.30×10^{-3} | 2.79×10^{-1} | kg |
| Barium | < 0.02 | 0.03 | ppm by wt | 4.30×10^{-4} | 2.79×10^{-2} | kg |
| Bismuth | < 0.2 | 0.03 | ppm by wt | 2.86×10^{-3} | 1.86×10^{-1} | kg |
| Calcium | 0.3 | 0.5 | ppm by wt | 7.17×10^{-3} | 4.67×10^{-1} | kg |
| Cadmium | < 0.01 | < 0.1 | ppm by wt | 1.43×10^{-3} | 9.30×10^{-2} | kg |
| Chlorine | — | 0.5 | ppm by wt | 7.17×10^{-3} | 4.67×10^{-1} | kg |
| Cobalt | < 0.02 | 0.4 | ppm by wt | 5.72×10^{-3} | 3.72×10^{-1} | kg |
| Chromium | 0.4 | 0.4 | ppm by wt | 5.72×10^{-3} | 3.72×10^{-1} | kg |
| Cesium-137 | $< 1 \times 10^{-10}$ | — | curies per gram | 1.43×10^{-3} | 9.30×10^{-2} | curies |
| Copper | 0.03 | 0.15 | ppm by wt | 2.15×10^{-3} | 1.40×10^{-1} | kg |
| Iron | 2.9 | 39 | ppm by wt | 5.58×10^{-1} | 3.63×10^1 | kg |
| Hydrogen-3 (tritium) | 1.6×10^{-7} | — | curies per gram | 2.29 | 1.49×10^2 | curies |
| Potassium | 2312(2) | 287 | ppm by wt | 3.31×10^1 | 2.15×10^3 | kg |
| Lithium | 0.1 | < 0.01 | ppm by wt | 1.43×10^{-3} | 9.30×10^{-2} | kg |
| Magnesium | 0.7 | 0.05 | ppm by wt | 1.00×10^{-2} | 6.53×10^{-1} | kg |
| Manganese | 0.4 | 0.24 | ppm by wt | 5.72×10^{-3} | 3.72×10^{-1} | kg |
| Molybdenum | < 0.04 | 1 | ppm by wt | 1.43×10^{-2} | 9.30×10^{-1} | kg |
| Sodium-22 | 5.2×10^{-7} | — | curies per gram | 7.44 | 4.84×10^2 | curies |
| Nickel | 0.25 | 22 | ppm by wt | 3.15×10^{-1} | 2.05×10^1 | kg |
| Lead | 0.06 | 0.3 | ppm by wt | 4.30×10^{-3} | 2.79×10^{-1} | kg |
| Silicon | 0.1 | 2 | ppm by wt | 2.86×10^{-2} | 1.86 | kg |
| Tin | 5 | 0.02 | ppm by wt | 7.17×10^{-2} | 4.67 | kg |
| Strontium | < 0.01 | — | ppm by wt | 1.43×10^{-4} | 9.30×10^{-3} | kg |
| Titanium | 0.04 | — | ppm by wt | 5.72×10^{-4} | 3.72×10^{-2} | kg |
| Total Alpha | 1.2×10^{-12} | — | curies per gram | 1.72×10^{-5} | 1.12×10^{-3} | curies |
| Uranium | < 2 | 01 | ppm by wt | 2.86×10^{-2} | 1.86 | kg |
| Vanadium | < 0.02 | — | ppm by wt | 2.86×10^{-4} | 1.86×10^{-2} | kg |

Note: To convert kilograms to pounds, multiply by 2.2046.

Key: FFTF=Fast Flux Test Facility; kg=kilograms; ppm=parts per million; wt=weight.

Source: CEES 2006.

Gamma energy analyses of the wastewater from cleaning sodium residuals from fuel and fuel-handling components indicated that there are five primary radionuclides present; that the beta to alpha ratio is greater than 700; and that cesium-137 and cobalt-60 account for greater than 70 percent of the radionuclides in the waste stream (Fluor Hanford 2005a). The five primary radionuclides in the wash wastewater and their volume percentages are:

- Cesium-137: 94 to 97 percent
- Cesium-134: 2 to 3 percent
- Sodium-22: less than 1 percent
- Cobalt-60: less than 1 percent

- Manganese-54: less than 1 percent

D.2.1.4 Radionuclide Inventory from Activation

The radionuclide inventory from activation of the reactor vessel and in-vessel components and the concrete bioshield immediately surrounding the reactor vessel is provided in the following sections.

The reactor vessel and in-vessel components have a total of 900,000 curies of activation products, as shown in Table D–69. Table D–70 summarizes the data in Table D–69 and additionally reports the inventory for the interim examination and maintenance (IEM) cell items and non-fueled hardware that have become activated.

Table D–69. Activated Reactor Vessel and In-Vessel Component Inventory, Decayed to September 2003

| | C-14 | Co-60 | Mo-93 | Nb-94 | Ni-59 | Ni-63 | Tc-99 | Total |
|--------------------------------|----------------------------|----------------------------|----------------------------|----------------------------|----------------------------|----------------------------|----------------------------|----------------------------|
| Inner radial shield | 3.09×10 ¹ | 1.48×10 ⁵ | 0 | 7.91 | 1.17×10 ² | 1.13×10 ⁴ | 0 | 1.59×10 ⁵ |
| Outer radial shield | 1.31×10 ¹ | 6.49×10 ⁴ | 0 | 3.78 | 5.45×10 ¹ | 5.26×10 ³ | 0 | 7.02×10 ⁴ |
| Radial shield support | 8.02×10 ⁻² | 3.84×10 ² | 0 | 1.74×10 ⁻² | 3.18×10 ⁻¹ | 3.12×10 ¹ | 0 | 4.16×10 ² |
| Core basket | 2.00×10 ⁻¹ | 8.49×10 ² | 0 | 3.20×10 ⁻² | 7.51×10 ⁻¹ | 7.48×10 ¹ | 0 | 9.25×10 ² |
| Grid plate | 4.67×10 ⁻¹ | 2.44×10 ³ | 0 | 1.13×10 ⁻¹ | 1.86 | 1.83×10 ² | 0 | 2.63×10 ³ |
| Core support structure | 8.48×10 ⁻² | 1.99×10 ² | 0 | 4.32×10 ⁻³ | 3.00×10 ⁻¹ | 2.99×10 ¹ | 0 | 2.29×10 ² |
| Reactor vessel | 6.84×10 ⁻² | 1.66×10 ² | 0 | 3.91×10 ⁻³ | 2.42×10 ⁻¹ | 2.41×10 ¹ | 0 | 1.90×10 ² |
| Thermal liner | 5.28×10 ⁻² | 1.28×10 ² | 0 | 2.94×10 ⁻³ | 1.87×10 ⁻¹ | 1.85×10 ¹ | 0 | 1.47×10 ² |
| Guard vessel | 1.63×10 ⁻² | 2.88×10 ¹ | 0 | 8.01×10 ⁻⁴ | 5.76×10 ⁻² | 5.71 | 0 | 3.46×10 ¹ |
| Core barrel | 4.31×10 ⁻¹ | 1.95×10 ³ | 0 | 7.68×10 ⁻² | 1.63 | 1.64×10 ² | 0 | 2.12×10 ³ |
| In-vessel storage modules | 9.95×10 ⁻² | 3.37×10 ² | 0 | 1.34×10 ⁻² | 3.45×10 ⁻¹ | 3.31×10 ¹ | 0 | 3.71×10 ² |
| Baffle plate | 1.41×10 ⁻² | 3.03×10 ¹ | 0 | 7.16×10 ⁻⁴ | 5.01×10 ⁻² | 4.97 | 0 | 3.53×10 ¹ |
| Instrument trees | 7.28×10 ⁻² | 3.07×10 ² | 3.86×10 ⁻⁹ | 1.11×10 ⁻² | 2.73×10 ⁻¹ | 2.69×10 ¹ | 2.02×10 ⁻⁹ | 3.34×10 ² |
| In-vessel handling machines | 4.62×10 ⁻³ | 7.75 | 6.13×10 ⁻⁹ | 1.60×10 ⁻⁴ | 1.63×10 ⁻² | 1.61 | 3.21×10 ⁻⁹ | 9.38 |
| Closure head assembly | 1.60×10 ⁻⁵ | 1.32×10 ⁻² | 9.58×10 ⁻⁸ | 4.57×10 ⁻⁷ | 1.27×10 ⁻⁴ | 1.21×10 ⁻² | 5.66×10 ⁻⁸ | 2.54×10 ⁻² |
| Z ring | 6.79×10 ⁻⁶ | 1.57×10 ⁻² | 0 | 5.37×10 ⁻⁷ | 2.44×10 ⁻⁵ | 2.45×10 ⁻³ | 0 | 1.82×10 ⁻² |
| Boron carbide shield | 3.26×10 ⁻⁸ | 0 | 0 | 0 | 0 | 0 | 0 | 3.26×10 ⁻⁸ |
| Steel roof | 2.03×10 ⁻³ | 4.19×10 ⁻⁷ | 0 | 4.50×10 ⁻⁹ | 0 | 0 | 3.41×10 ⁻⁹ | 4.27×10 ⁻⁷ |
| Row 7 radial reflectors | 2.46 | 1.96×10 ⁵ | 1.06×10 ² | 1.20×10 ¹ | 5.77×10 ² | 7.86×10 ⁴ | 9.63 | 2.75×10 ⁵ |
| Row 8 and 9 radial reflectors | 2.88 | 2.70×10 ⁵ | 1.17×10 ² | 1.62×10 ¹ | 7.96×10 ² | 1.02×10 ⁵ | 1.31×10 ¹ | 3.73×10 ⁵ |
| Control and safety rods | 9.40×10 ⁻¹ | 8.02×10 ³ | 3.32×10 ¹ | 3.53 | 2.32×10 ¹ | 1.64×10 ³ | 2.70 | 9.72×10 ³ |
| In-core shim assemblies | 4.40×10 ⁻¹ | 3.01×10 ³ | 1.83×10 ¹ | 1.93 | 1.13×10 ¹ | 8.10×10 ² | 1.49 | 3.85×10 ³ |
| Peripheral shim rod assemblies | 8.66×10 ⁻³ | 2.12×10 ¹ | 2.45×10 ⁻¹ | 2.56×10 ⁻² | 1.60×10 ⁻¹ | 1.10×10 ¹ | 1.90×10 ⁻² | 3.27×10 ¹ |
| Totals | 5.23×10¹ | 6.97×10⁵ | 2.75×10² | 4.56×10¹ | 1.59×10³ | 2.00×10⁵ | 2.69×10¹ | 8.99×10⁵ |

Key: C=carbon; Co=cobalt; Mo=molybdenum; Nb=niobium; Ni=nickel; Tc=technetium.

Source: CEES 2006.

Table D-70. Activated Reactor Hardware, Core Components, Non-Fueled Hardware, and Interim Examination and Maintenance Cell Items Inventory, Decayed to September 2003

| | C-14 | Co-60 | Mo-93 | Nb-94 | Ni-59 | Ni-63 | Tc-99 | Total |
|---------------------|----------------------------|----------------------------|----------------------------|----------------------------|----------------------------|----------------------------|----------------------------|----------------------------|
| Reactor hardware | 4.56×10 ¹ | 2.19×10 ⁵ | 1.06×10 ⁻⁷ | 1.20×10 ¹ | 1.77×10 ² | 1.72×10 ⁴ | 6.52×10 ⁻⁸ | 2.37×10 ⁵ |
| Core components | 6.73 | 4.77×10 ⁵ | 2.75×10 ² | 3.37×10 ¹ | 1.41×10 ³ | 1.83×10 ⁵ | 2.69×10 ¹ | 6.62×10 ⁵ |
| Non-fueled hardware | 4.09×10 ⁻² | 2.90×10 ³ | 1.67 | 2.05×10 ⁻¹ | 6.93 | 1.11×10 ³ | 1.63×10 ⁻¹ | 4.02×10 ³ |
| IEM cell items | 4.01×10 ⁻² | 2.84×10 ³ | 1.63 | 2.10×10 ⁻¹ | 6.79 | 1.08×10 ³ | 1.60×10 ⁻¹ | 3.93×10 ³ |
| Totals | 5.24×10¹ | 7.02×10⁵ | 2.78×10² | 4.61×10¹ | 1.60×10³ | 2.02×10⁵ | 2.72×10¹ | 9.07×10⁵ |

Key: C=carbon; Co=cobalt; IEM=interim examination and maintenance; Mo=molybdenum; Nb=niobium; Ni=nickel; Tc=technetium.

Source: CEES 2006.

The FFTF reactor operated from April 1982 to March 1992 at a time-averaged power level of 206 megawatts. The bioshield surrounding the FFTF reactor vessel is constructed of magnetite concrete with carbon steel rebar and liner. The calculated radionuclide activation products in the bioshield are presented in Table 4.16 of *Activation of the FFTF Biological Shield Wall* (Kidd 2005), which shows them decayed for 13.5 years (September 2006 values) (CEES 2006). These data are reproduced in Table D-71.

Table D-71. Activation Inventory of Fast Flux Test Facility Bioshield, Decayed to September 2006

| | Liner | Rebar | Concrete | Total |
|----------------------|------------------------|------------------------|------------------------|------------------------|
| Hydrogen-3 (tritium) | 2.28×10 ⁻⁸ | 2.34×10 ⁻⁸ | 1.73×10 ⁻⁵ | 1.73×10 ⁻⁵ |
| Argon-39 | — | — | 1.58×10 ⁻⁵ | 1.58×10 ⁻⁵ |
| Argon-42 | — | — | 1.67×10 ⁻⁹ | 1.67×10 ⁻⁹ |
| Beryllium-10 | 9.24×10 ⁻¹² | 2.81×10 ⁻¹¹ | — | 3.73×10 ⁻¹¹ |
| Carbon-14 | 4.36×10 ⁻⁸ | 1.81×10 ⁻⁷ | 7.65×10 ⁻⁴ | 7.65×10 ⁻⁴ |
| Calcium-41 | — | — | 1.54×10 ⁻² | 1.54×10 ⁻² |
| Calcium-48 | — | — | 4.32×10 ⁻²⁷ | 4.32×10 ⁻²⁷ |
| Cobalt-60 | 2.15×10 ⁻¹ | 3.07×10 ⁻¹ | 4.66×10 ⁻⁴ | 5.22×10 ⁻¹ |
| Cobalt-60m | — | 3.50×10 ⁻¹⁶ | 1.89×10 ⁻¹³ | 1.90×10 ⁻¹³ |
| Chromium-50 | 1.81×10 ⁻²⁵ | 1.68×10 ⁻²⁵ | 5.06×10 ⁻²⁵ | 8.55×10 ⁻²⁵ |
| Iron-55 | 1.99 | 3.57 | 1.19×10 ¹ | 1.74×10 ¹ |
| Iron-60 | — | 3.50×10 ⁻²⁶ | 1.89×10 ⁻¹³ | 1.90×10 ⁻¹³ |
| Potassium-40 | — | — | 1.24×10 ⁻⁸ | 1.24×10 ⁻⁸ |
| Potassium-42 | — | — | 1.67×10 ⁻⁹ | 1.67×10 ⁻⁹ |
| Manganese-53 | 2.24×10 ⁻¹⁰ | 1.99×10 ⁻¹⁰ | 6.13×10 ⁻¹⁰ | 1.04×10 ⁻⁹ |
| Molybdenum-100 | — | 8.16×10 ⁻²⁹ | — | 8.16×10 ⁻²⁹ |
| Molybdenum-93 | — | 1.85×10 ⁻⁵ | — | 1.85×10 ⁻⁵ |
| Niobium-91 | — | 9.92×10 ⁻¹⁰ | — | 9.92×10 ⁻¹⁰ |
| Niobium-92 | — | 3.92×10 ⁻¹³ | — | 3.92×10 ⁻¹³ |
| Niobium-93m | — | 1.01×10 ⁻⁵ | — | 1.01×10 ⁻⁵ |
| Niobium-94 | — | 1.34×10 ⁻¹¹ | — | 1.34×10 ⁻¹¹ |
| Nickel-59 | — | 3.94×10 ⁻⁴ | 2.47×10 ⁻¹ | 2.47×10 ⁻¹ |

Table D-71. Activation Inventory of Fast Flux Test Facility Bioshield, Decayed to September 2006 (curies) (continued)

| | Liner | Rebar | Concrete | Total |
|---------------|------------------------|------------------------|--------------------------------------|--------------------------------------|
| Nickel-63 | — | 4.25×10^{-2} | 2.67×10^1 | 2.68×10^1 |
| Phosphorus-32 | 2.36×10^{-11} | 5.71×10^{-11} | — | 8.07×10^{-11} |
| Scandium-48 | — | — | 6.91×10^{-28} | 6.91×10^{-28} |
| Silicon-32 | 2.36×10^{-11} | 5.71×10^{-11} | — | 8.07×10^{-11} |
| Technetium-99 | — | 4.52×10^{-6} | — | 4.52×10^{-6} |
| Vanadium-50 | — | 3.00×10^{-21} | 1.76×10^{-18} | 1.76×10^{-18} |
| Zinc-70 | — | — | 2.49×10^{-22} | 2.49×10^{-22} |
| Zirconium-93 | — | 2.33×10^{-12} | — | 2.33×10^{-12} |
| Zirconium-96 | — | 5.02×10^{-31} | — | 5.02×10^{-31} |
| Total | 2.21 | 3.92 | 3.89×10^1 | 4.50×10^1 |

Source: CEES 2006.

D.2.1.5 Radionuclide Inventory from Contamination

Contamination within FFTF is primarily confined to the reactor containment vessel, internal surfaces of system components that handled primary sodium and radioactive argon, cells within the Reactor Containment Building (RCB), decontamination areas, liquid radioactive waste holding and exporting systems, sodium removal and sampling systems, fuel handling systems, IEM cell, and contaminated equipment repair shop. The contaminated areas within the FFTF facilities are listed in Table D-72.

Table D-72. Contaminated Areas Within Fast Flux Test Facility

| Building | Cell Number | Description | Average Contamination Level (dpm/100 cm ²) |
|--|-------------|------------------------------------|--|
| Reactor Containment Building | 524 | Heat compartment | No data |
| | 528 | Fuel transfer port adapter storage | 0 |
| | 544 | CLEM grapple change box pit | No data |
| | 548 | IEM cell | 5.16×10^4 (1998) |
| | 549 | Radioactive argon gas pipeway | 0 |
| | 567 | Electromagnetic pump cell | No data |
| | FTP 1 | — | 8.72×10^4 (2002) |
| | FTP 2 | — | 3.75×10^4 (1997) |
| | FTP 3 | — | 7.00×10^3 (1997) |
| Heat Transport System Service Building South | 490 | Sodium sampling cell | No data |
| Reactor Service Building | 201 | Sodium Removal System | No data |
| | 205 | Sodium Removal System | No data |
| Maintenance and Storage Facility | — | Decontamination I | No data |
| | — | Decontamination II | No data |
| | — | Contaminated Equipment Repair Shop | No data |
| | 17 | Radioactive Liquid Waste Tank Area | No data |

Key: CLEM=Closed Loop Ex-Vessel Machine; dpm/100 cm²=disintegrations per minute per 100 square centimeters; FTP=fuel transfer port; IEM=interim examination and maintenance.

Source: CEES 2006.

A hot spot of 150 roentgens per hour on contact was identified in the piping downstream of the 5-standard-cubic-foot-per-minute vapor trap (York 2005). This radiation level correlates with an estimated source of 3.5 curies of cesium-137.

The *Technical Information Document for the Fast Flux Test Facility Closure Project Environmental Impact Statement* (Fluor Hanford 2005a) identifies the IEM cell as the cell with the greatest amount of contamination. The FFTF Alternatives scaled data sets (SAIC 2007m) estimate that contamination within the IEM cell equates to 9.95×10^{-4} curies of cesium-137, decayed to 2005. This indicates that the inventory due to contamination makes up a very small fraction of the inventory associated with activated structure and components.

D.2.1.6 Hazardous Materials Inventory

The following materials are either planned for removal or have been removed from FFTF during the deactivation activities: ethylene glycol, Mobiltherm™ oil, transformer oils containing PCBs, cooling tower chemicals, sulfuric acid, Freon™ R-12 and R-22, depleted ion exchange resins, fuel oil, and asbestos-containing materials. The balance of the chemical inventory is identified in Attachment 2 the *Technical Information Document for the Fast Flux Test Facility Closure Project Environmental Impact Statement* (Fluor Hanford 2005a).

The remaining hazardous materials include approximately 47,900 kilograms (105,600 pounds) of lead and 37,694 kilograms (83,100 pounds) of depleted uranium. These materials would be removed to the extent practicable during FFTF deactivation activities (DOE 2006a).

D.2.2 FFTF Decommissioning Alternative 1: No Action

CEQ regulations require that National Environmental Policy Act (NEPA) analyses include a No Action Alternative. Under this alternative, deactivation of the FFTF complex and support buildings would be completed, as specified by previous FFTF NEPA decisions (*Environmental Assessment, Sodium Residuals Reaction/Removal and Other Deactivation Work Activities, Fast Flux Test Facility (FFTF) Project, Hanford Site, Richland, Washington*) (DOE 2006a), and maintained in a long-term surveillance and maintenance (S&M) condition for the foreseeable future. The facility would be monitored and periodic S&M would be performed to ensure that the environmental and safety issues are minimized and addressed.

D.2.2.1 Facility Disposition

The FFTF RCB, along with the rest of the buildings within the 400 Area Property Protected Area (PPA), would be maintained in a long-term S&M condition after completion of all deactivation activities. The buildings would be left standing with a maintained exterior that would be capable of protecting them from the elements. They would be unoccupied, with essential safety-related systems left operational. Such systems could include, but would not be limited to, fire protection, emergency lighting, ventilation, air monitoring, and inert gas systems used to isolate piping and equipment containing sodium residuals. Other radioactive or chemical waste and materials would be removed during deactivation.

D.2.2.2 Process Components

The reactor vessel, piping systems, and tanks (contained above and below grade within the RCB and immediately adjacent buildings) would be left in place under an inert gas blanket. Deactivation activities would be complete, including draining of the bulk sodium and removal of SNF, depleted uranium, lead shielding, remote-handled special components (RH-SCs), small-bore piping, valves, and other

components. Some systems would be deactivated/de-energized and isolated (e.g., those not associated with maintaining safety-related functions) per the deactivation plans.

D.2.2.3 Sodium Residuals

Sodium residuals in the RCB vessels and cooling systems' piping would be left in place untreated, but under an inert gas blanket. During deactivation activities, the FFTF bulk sodium would be drained from the reactor systems and stored as a solid in tanks in the Sodium Storage Facility within the 400 Area. The small amount of sodium-potassium alloy would be blended with the content of the bulk sodium storage containers. The Hallam Reactor and Sodium Reactor Experiment sodium would remain in its current storage location (Hanford 200-West Area).

D.2.2.4 Demolition and Other Waste

There would be no demolition under the No Action Alternative; therefore, no demolition waste would be generated. Solid and liquid radioactive and/or hazardous waste generated during deactivation would be managed and disposed of on site. Activities associated with the No Action Alternative would not generate substantial additional quantities of solid waste for disposal. The small amounts of radioactive solid waste generated during S&M activities would be disposed of on site in disposal facilities approved for Hanford's operational waste at the low-level radioactive waste burial ground (LLBG) 218-W-5, trenches 31 and 34. Other regulated waste, such as PCBs, asbestos, and hazardous waste, would be handled in a similar manner under all of the alternatives. The volume of this waste is expected to be small, and it would be dispositioned in accordance with existing *Hanford Site Solid Waste Acceptance Criteria* (Fluor Hanford 2005b) or offsite treatment contracts.

D.2.2.5 End State

The facilities and infrastructure within the 400 Area PPA, including the RCB, would be maintained in a 100-year administrative control condition with appropriate monitoring and controls (to ensure that environmental or safety concerns are minimized) (SAIC 2007m, 2008a).

Matching the list of radionuclides and chemicals identified in the above tables with the COPCs identified in Appendix D, Section D.1.1, resulted in a report of the following radionuclides (in curies): tritium, carbon-14, technetium-99, and cesium-137, as well as the following chemicals (in kilograms): chromium, lead, and uranium. Table D-73 summarizes each of these radiological and chemical COPCs under FFTF Decommissioning Alternative 1.

**Table D-73. FFTF Decommissioning Alternative 1 Radiological and Chemical
Constituents of Potential Concern Balance**

| | Cesium-137 | Carbon-14 | Hydrogen-3 (Tritium) | Technetium-99 | Chromium | Lead | Total Uranium |
|--|-----------------------------|----------------------------|-------------------------|----------------------------|-----------------------------|-----------------------------|-----------------------------|
| | Curies | | | | Kilograms | | |
| Inventory Remaining at the Fast Flux Test Facility Site | | | | | | | |
| Sodium residuals ^a | 1.43×10 ⁻³ | 0 | 2.29 | 0 | 5.72×10 ⁻³ | 4.30×10 ⁻³ | 2.86×10 ⁻² |
| Hardware ^b | 0 | 5.24×10 ¹ | 0 | 2.72×10 ¹ | 0 | 0 | 0 |
| Bioshield | 0 | 7.65×10 ⁻⁴ | 1.73×10 ⁻⁵ | 4.52×10 ⁻⁶ | 0 | 0 | 0 |
| Total Remaining Inventory | 1.43×10⁻³ | 5.24×10¹ | 2.29 | 2.72×10¹ | 5.72×10⁻³ | 4.30×10⁻³ | 2.86×10⁻² |
| Inventory Disposed of in LLBG 218-W-5, Mixed Waste Trenches 31 and 34 | | | | | | | |
| Secondary waste ^c | 1.43×10 ⁻³ | 5.31×10 ⁻⁵ | 1.88×10 ⁻⁶ | 1.19×10 ⁻³ | 1.42×10 ⁻⁴ | 1.07×10 ⁻⁴ | 7.14×10 ⁻⁴ |

^a The inventory for the approximately 15,142 liters (4,000 gallons) of sodium residuals includes FFTF components, e.g., the reactor and miscellaneous traps.

^b Hardware includes activated reactor hardware, core components, non-fueled hardware, and interim examination and maintenance cell items.

^c Secondary waste inventories were estimated from 2006 *Solid Waste Integrated Forecast Technical (SWIFT) Report, FY2006–FY2035* database information (Barcot 2005). For analysis purposes, it was conservatively assumed that 100 percent of the cesium-137 inventory would be captured in the secondary waste.

Key: FFTF=Fast Flux Test Facility; LLBG=low-level radioactive waste burial ground.

Source: SAIC 2007m.

D.2.3 FFTF Decommissioning Alternative 2: Entombment

Under this alternative, the FFTF RCB (and structures within) that are above grade level (i.e., 168 meters [550 feet] above mean sea level) would be decontaminated as necessary, dismantled, and removed. The RCB structures below grade level, as well as the FFTF reactor vessel and radioactive and contaminated equipment, piping, and other materials and components that have become radioactive or otherwise contaminated, would remain in place. Sodium residuals would be removed from the RCB and treated either in existing 400 Area facilities or in place. In addition, the below-grade RCB structures would be filled with grout or other suitable fill material to immobilize remaining hazardous chemicals and radiological materials to the maximum extent practicable and to prevent subsidence. The RCB fill material may include other demolition debris containing hazardous or radioactive materials, as allowed by regulations. A regulatory compliant, engineered, modified Resource Conservation and Recovery Act (RCRA) Subtitle C barrier would be constructed over the filled area. The entombed area would include the barrier together with the lower RCB and adjacent structures and immobilized internal structures.

The FFTF support buildings would be decontaminated as necessary and demolished. The area previously occupied by the facilities would be backfilled with soil to eliminate void spaces, compacted such that natural settling would not result in depressions (to avoid potential ponding of water), recontoured, and revegetated. An appropriate monitoring program for the PPA would also be established. The following sections provide additional descriptions of the activities that would be conducted under FFTF Decommissioning Alternative 2.

D.2.3.1 Facility Disposition

Appendix E, Table E–13, summarizes the proposed decommissioning activities for each building under both FFTF Decommissioning Alternative 2: Entombment, and FFTF Decommissioning Alternative 3: Removal. For the Entombment Alternative, all above-grade structures that are part of the main RCB and the two immediately adjacent support facilities (Buildings 491E and 491W) would be dismantled, and the demolition waste would be disposed of in an IDF or consolidated in the below-grade spaces. Below-grade structures would be filled with demolition waste, as practicable, and stabilized with suitable fill material (e.g., grout) to immobilize hazardous chemical and radiological materials and prevent subsidence in the future.

All other ancillary buildings, including their internal equipment and components, would be demolished, as noted in Appendix E, Table E–13, and the contaminated demolition debris would be disposed of in an IDF or consolidated within available below-grade spaces within the RCB or Buildings 491E and 491W. All radioactive and/or hazardous material would be removed. Wood and large steel components would also be removed. Foundation rubble (e.g., concrete and rebar) could remain. The area previously occupied by these facilities would be backfilled with soil, compacted, contoured, and revegetated. As indicated in Appendix E, Table E–13, some of these buildings would be either completely or partially within the footprint (including the side slope) of the engineered barrier over the RCB.

D.2.3.2 Process Components

The reactor vessel, piping systems, and tanks located above grade within the RCB and immediately adjacent buildings would be dismantled and placed in below-grade spaces as practicable or transported to an IDF for disposal. Deactivation activities would be complete, including draining of the bulk sodium and removal of SNF, depleted uranium, lead shielding, RH-SCs, small-bore piping, valves, and other components. Systems located below grade (including regulated waste) would be grouted in place after treatment of any SNF sodium residuals. The small-diameter (less than 20.3 centimeters [8 inches] in diameter) piping would be removed, treated (cleaned of sodium) in the 400 Area, and disposed of on site in an IDF or placed in below-grade spaces within the RCB.

D.2.3.3 Sodium Residuals

All sodium residuals would be removed from the RCB systems or treated in place. It was assumed that sodium would be drained from plant systems to the extent practicable, followed by moist gas passivation and/or flushing with water to stabilize sodium residuals. Sodium residuals in small-diameter piping would be treated in the 400 Area after removal of the components from the reactor plant.

D.2.3.4 Demolition and Other Waste

Demolition debris from facility decommissioning (chemically hazardous or radioactive solid waste) would be handled in the same way for both action alternatives, except that the disposition of the volumes of debris would change. Under FFTF Decommissioning Alternative 2, the debris not placed in the RCB or other voids or used as backfill would be transported to an IDF for disposal. Solid waste resulting from any of the processing options (for sodium residual waste, bulk sodium, etc.) would be included with the analyses of those options.

Radioactive liquid waste resulting from treatment of the sodium residuals also would be handled in the same way under both action alternatives. The liquid volume would be reduced at FFTF (through either ion exchange and reuse or evaporation), and the remaining liquids would be transported to the 200-Area ETF for processing and disposal. For the analyses in this *TC & WM EIS*, it was assumed that a 90 percent reduction in volume could be achieved prior to shipment of the liquid to the ETF for processing. Any

other sources of radioactive waste (such as decontamination solutions) are expected to result in very small volumes compared to waste produced as a result of treating sodium residuals.

Other regulated waste, such as PCBs, asbestos, and nonradioactive hazardous waste, would be handled in a similar manner for all the alternatives. The volume of this waste is expected to be small, and it would be dispositioned in accordance with existing *Hanford Site Solid Waste Acceptance Criteria* (Fluor Hanford 2005b) or offsite treatment contracts.

D.2.3.5 End State

For analysis in this *TC & WM EIS*, it was assumed that a modified RCRA Subtitle C barrier would be constructed over the RCB and Buildings 491E and 491W, which contain residual radioactive and/or hazardous waste.

In addition, the barrier would extend over part or all of the immediately adjacent facility footprints. The barrier would be circular with a radius of about 39.2 meters (128.5 feet), not including the side slope used for drainage. The side slope would be about 5.2 meters (17.1 feet) using a 3H:1V slope. Minimal postclosure care would be required. The remainder of the PPA would be backfilled with soil, compacted, recontoured, and revegetated.

The modified RCRA Subtitle C barrier would be designed to provide containment and hydrologic protection for a performance period of 500 years. This performance period is conservatively based on radionuclide concentration and activity limits for Category 3 low-level radioactive waste (LLW). The modified RCRA Subtitle C barrier would be composed of eight layers of durable material with a combined minimum thickness of about 1.7 meters (5.7 feet), excluding the grading fill layer, which would range from zero at the edge to approximately 0.8 meters (2.6 feet) at the center for a 2 percent drainage slope. The design would also incorporate an asphaltic concrete layer to reduce the likelihood of bio-intrusion or inadvertent human intrusion (SAIC 2007m, 2008a). Further information on the modified RCRA Subtitle C barrier can be found in Appendix E, Section E.1.2.5.4.1.

Matching the list of radionuclides and chemicals identified in Tables D-68 through D-71 with the COPCs identified in Appendix D, Section D.1.1 resulted in a report of the following radionuclides (in curies): tritium, carbon-14, technetium-99, and cesium-137, as well as the following chemicals (in kilograms): chromium, lead, and uranium. Table D-74 is a summary of each of the radiological and chemical COPCs under FFTF Decommissioning Alternative 2.

Table D–74. FFTF Decommissioning Alternative 2: Radiological and Chemical Constituents of Potential Concern Balance

| | Cesium-137 | Carbon-14 | Hydrogen-3 (Tritium) | Technetium-99 | Chromium | Lead | Total Uranium |
|---|-----------------------------|-----------------------------|-----------------------------|-----------------------------|-----------------------------|-----------------------------|-----------------------------|
| | Curies | | | | Kilograms | | |
| Inventory Remaining at the Fast Flux Test Facility Site | | | | | | | |
| Hardware ^a | 0 | 5.24×10 ¹ | 0 | 2.72×10 ¹ | 0 | 0 | 0 |
| Bioshield | 0 | 7.65×10 ⁻⁴ | 1.73×10 ⁻⁵ | 4.52×10 ⁻⁶ | 0 | 0 | 0 |
| Total Remaining Inventory | 0 | 5.24×10¹ | 1.73×10⁻⁵ | 2.72×10¹ | 0 | 0 | 0 |
| Inventory Disposed of in an Integrated Disposal Facility | | | | | | | |
| Sodium residuals ^b | 1.43×10 ⁻³ | 0 | 2.29 | 0 | 5.72×10 ⁻³ | 4.30×10 ⁻³ | 2.86×10 ⁻² |
| Secondary waste ^c | 1.43×10 ⁻³ | 6.33×10 ⁻⁴ | 3.58×10 ⁻⁷ | 1.48×10 ⁻² | 1.79×10 ⁻³ | 1.34×10 ⁻³ | 8.95×10 ⁻³ |
| Total Inventory Disposed of in an Integrated Disposal Facility | 2.86×10⁻³ | 6.33×10⁻⁴ | 2.29 | 1.48×10⁻² | 7.50×10⁻³ | 5.64×10⁻³ | 3.76×10⁻² |

^a Hardware includes activated reactor hardware, core components, non-fueled hardware, and interim examination and maintenance cell items.

^b The inventory for the approximately 15,142 liters (4,000 gallons) of sodium residuals includes FFTF components, e.g., the reactor and miscellaneous traps.

^c Secondary waste inventories were estimated from 2006 *Solid Waste Integrated Forecast Technical (SWIFT) Report, FY2006–FY2035* database information (Barcot 2005). For analysis purposes, it was conservatively assumed that 100 percent of the cesium-137 inventory would be captured in the secondary waste.

Key: FFTF=Fast Flux Test Facility.

Source: SAIC 2007m.

D.2.4 FFTF Decommissioning Alternative 3: Removal

Under this alternative, the RCB (and structures within) that are above grade level would be decontaminated as necessary, dismantled, and removed. All sodium residuals would be removed from the RCB or treated in place to neutralize its chemical reactivity. Below grade level, the reactor vessel and contaminated reactor vessel internals, other radioactively contaminated equipment, piping, materials, and other components, along with any asbestos, depleted uranium shielding, and lead shielding, would also be removed. Such radioactively contaminated equipment, piping, materials, and components would include the intermediate heat exchangers, primary pumps, primary isolation valves, primary overflow tanks, IEM cell equipment, 8.5- to 12.2-meter (28- to 40-foot) test assembly hardware, and the interim decay storage vessel. Additional radioactively contaminated equipment from the RCB and FFTF heat transport system would also be removed. Upon removal, this equipment would be disposed of in an IDF. The below-grade RCB and the FFTF support buildings outside the RCB area would be decontaminated as necessary and demolished. The area previously occupied by the facilities would then be backfilled with soil, compacted, recontoured, and revegetated. An appropriate monitoring program would also be established. The following sections describe the activities to be conducted under the Removal Alternative.

D.2.4.1 Facility Disposition

All above-grade structures that are part of the RCB and the immediately adjacent support facilities with substructures (basements) would be dismantled, and the contaminated demolition debris would be disposed of in an IDF. The RCB would be demolished down to grade level and the support facilities would be demolished to 0.91 meters (3 feet) below grade. Below-grade radioactively contaminated components and equipment (including the reactor vessel) would be removed. However, the reinforced concrete shell in the RCB would remain and be backfilled with either soil or grout, compacted, recontoured, and revegetated. Small amounts of radioactive activation products in structural concrete and steel would remain. All small-diameter piping would be removed, and sodium residuals would be either treated in place or removed from the RCB for treatment at an onsite facility to neutralize the chemical reactivity of the metallic sodium.

All other ancillary buildings, including their internal equipment and components, would be demolished and removed (down to a depth of 0.91 meters [3 feet] below grade). The contaminated demolition debris would be disposed of in an IDF, and the vacated spaces would be backfilled, compacted, recontoured, and revegetated. All radioactive and/or hazardous material would be removed. Wood and large steel components would also be removed. Foundation rubble, e.g., concrete and rebar, would remain.

D.2.4.2 Process Components

The above- and below-grade reactor vessel, piping systems, and tanks within the RCB and the immediately adjacent buildings would be dismantled and transported to an IDF for disposal. Deactivation activities would be complete, including draining of the bulk sodium and removal of SNF, depleted uranium, lead shielding, RH-SCs, small-bore piping, valves, and other components. Radioactively contaminated equipment, piping, tanks, hazardous materials (including asbestos and lead shielding), and other components would also be removed for disposal in an IDF. The reactor vessel (along with any attached depleted uranium shielding and/or internal piping and equipment) would be filled with grout, removed, packaged, and transported to an IDF for disposal. Uncontaminated material (i.e., material that is clean of radioactive or hazardous substances) would not be removed and, as previously stated, the reinforced concrete shell would remain. All small-diameter piping would be removed. The small-diameter piping would be treated in the 400 Area to remove sodium residuals and be disposed of on site in an IDF.

D.2.4.3 Sodium Residuals

Sodium residuals would be treated the same under both FFTF Decommissioning action alternatives. All sodium residuals would be removed from the RCB systems or treated in place. It was assumed that sodium would be drained from the plant systems to the extent practicable, followed by moist gas passivation and/or flushing with water to stabilize sodium residuals. Sodium residuals in small-diameter piping would be treated in the 400 Area after the piping has been removed from the reactor plant.

D.2.4.4 Demolition and Other Waste

Demolition debris, radioactive solid waste, radioactive liquid waste, and other regulated hazardous waste would be handled in the same manner under both FFTF Decommissioning action alternatives; only the disposition of the volume of waste would change. The approaches to waste handling also would be the same, and demolition waste would be disposed of in an IDF under both action alternatives.

D.2.4.5 End State

Below-grade portions of structures would be backfilled with soil, compacted, recontoured, and revegetated. Although there would be no anticipated need for an engineered barrier, it was assumed for analysis purposes that an appropriate postclosure care program would be established (SAIC 2007m, 2008a).

Matching the list of radionuclides and chemicals identified in the previous tables with the COPCs identified in Section D.1.1 resulted in a report of the following radionuclides (in curies): tritium, carbon-14, technetium-99, and cesium-137, as well as the following chemicals (in kilograms): chromium, lead, and uranium. Table D-75 is a summary of each of the radiological and chemical COPCs under FFTF Decommissioning Alternative 3.

Table D-75. FFTF Decommissioning Alternative 3 Radiological and Chemical Constituents of Potential Concern Balance

| | Cesium-137 | Carbon-14 | Hydrogen-3 (Tritium) | Technetium-99 | Chromium | Lead | Total Uranium |
|---|---|--------------------------------------|-------------------------|--------------------------------------|---|---|---|
| | Curies | | | | Kilograms | | |
| Inventory Remaining at the Fast Flux Test Facility Site | | | | | | | |
| Bioshield | 0 | 7.65×10^{-4} | 1.73×10^{-5} | 4.52×10^{-6} | 0 | 0 | 0 |
| Inventory Disposed of in an Integrated Disposal Facility | | | | | | | |
| Sodium residuals ^a | 1.43×10^{-3} | 0 | 2.29 | 0 | 5.72×10^{-3} | 4.30×10^{-3} | 2.86×10^{-2} |
| Hardware ^b | 0 | 5.24×10^1 | 0 | 2.72×10^1 | 0 | 0 | 0 |
| Secondary waste ^c | 1.43×10^{-3} | 6.41×10^4 | 1.27×10^{-6} | 1.50×10^{-2} | 1.81×10^{-3} | 1.36×10^{-3} | 9.05×10^{-3} |
| Total inventory disposed of in an IDF | 2.86×10^{-3} | 5.24×10^1 | 2.29 | 2.72×10^1 | 7.52×10^{-3} | 5.65×10^{-3} | 3.77×10^{-2} |

^a The inventory for the approximately 15,142 liters (4,000 gallons) of sodium residuals waste includes four Fast Flux Test Facility special components (the reactor and miscellaneous traps).

^b Hardware includes activated reactor hardware, core components, non-fueled hardware, and interim examination and maintenance cell items.

^c Secondary waste inventories were estimated from 2006 *Solid Waste Integrated Forecast Technical (SWIFT) Report, FY2006–FY2035* database information (Barcot 2005). For analysis purposes, it was conservatively assumed that 100 percent of the cesium-137 inventory would be captured in the secondary waste.

Key: IDF=Integrated Disposal Facility.

Source: SAIC 2007m.

D.2.5 Distribution of Fast Flux Test Facility Waste

As discussed above, each of the three FFTF Decommissioning alternatives generates a number of waste streams and disposes of this waste differently. This section provides histograms (see Figures D-64, D-65, and D-66) depicting the distribution of the radiological COPCs between the FFTF site and an IDF under each of the FFTF Decommissioning alternatives. The COPCs shown include both radionuclides (cesium-137, tritium, and technetium-99) and chemicals (chromium, lead, and total uranium).

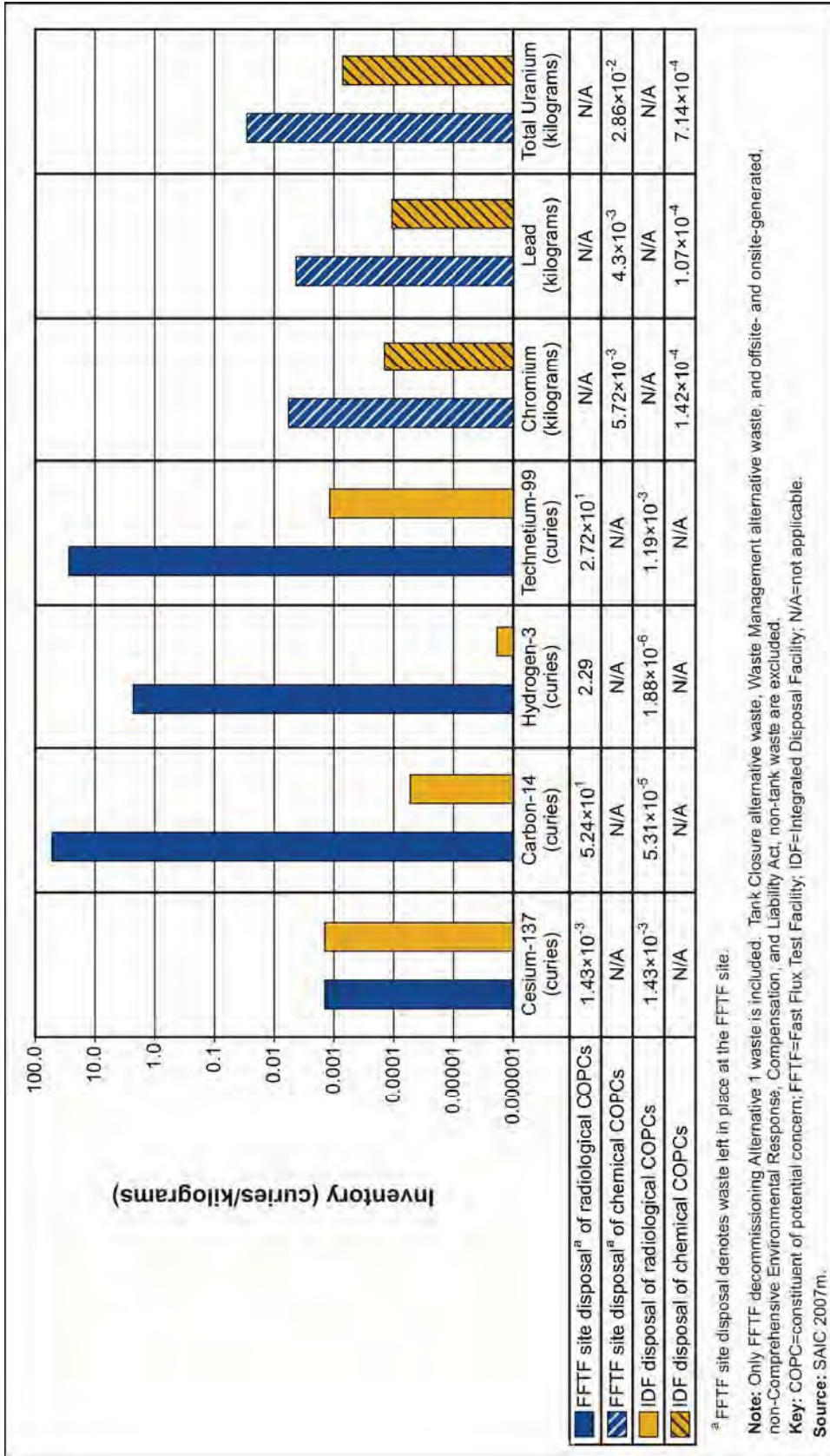

Figure D-64. FFTF Decommissioning Alternative 1: Distribution of Radiological and Chemical Constituents of Potential Concern

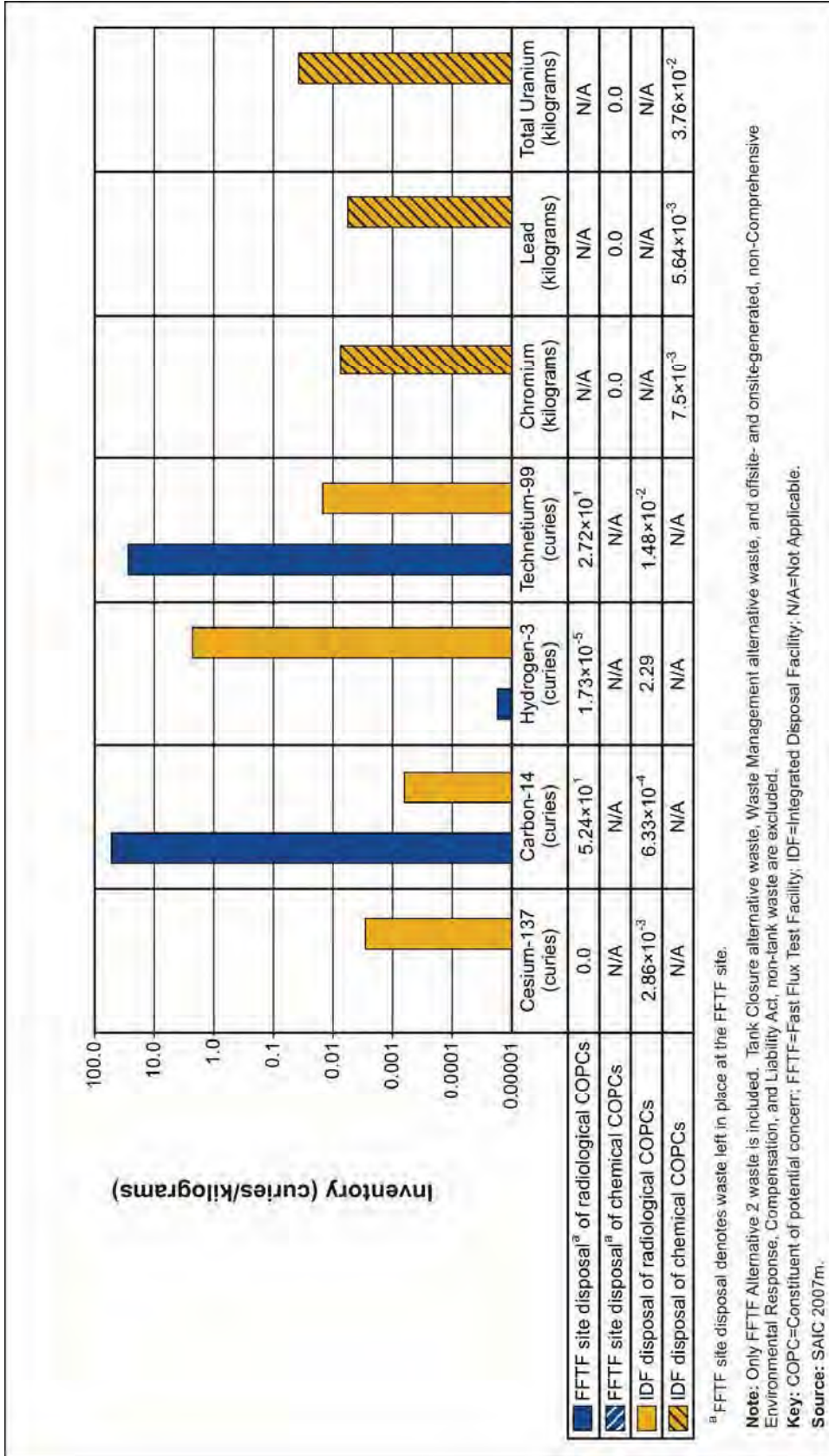

Figure D-65. FFFTF Decommissioning Alternative 2: Distribution of Radiological and Chemical Constituents of Potential Concern

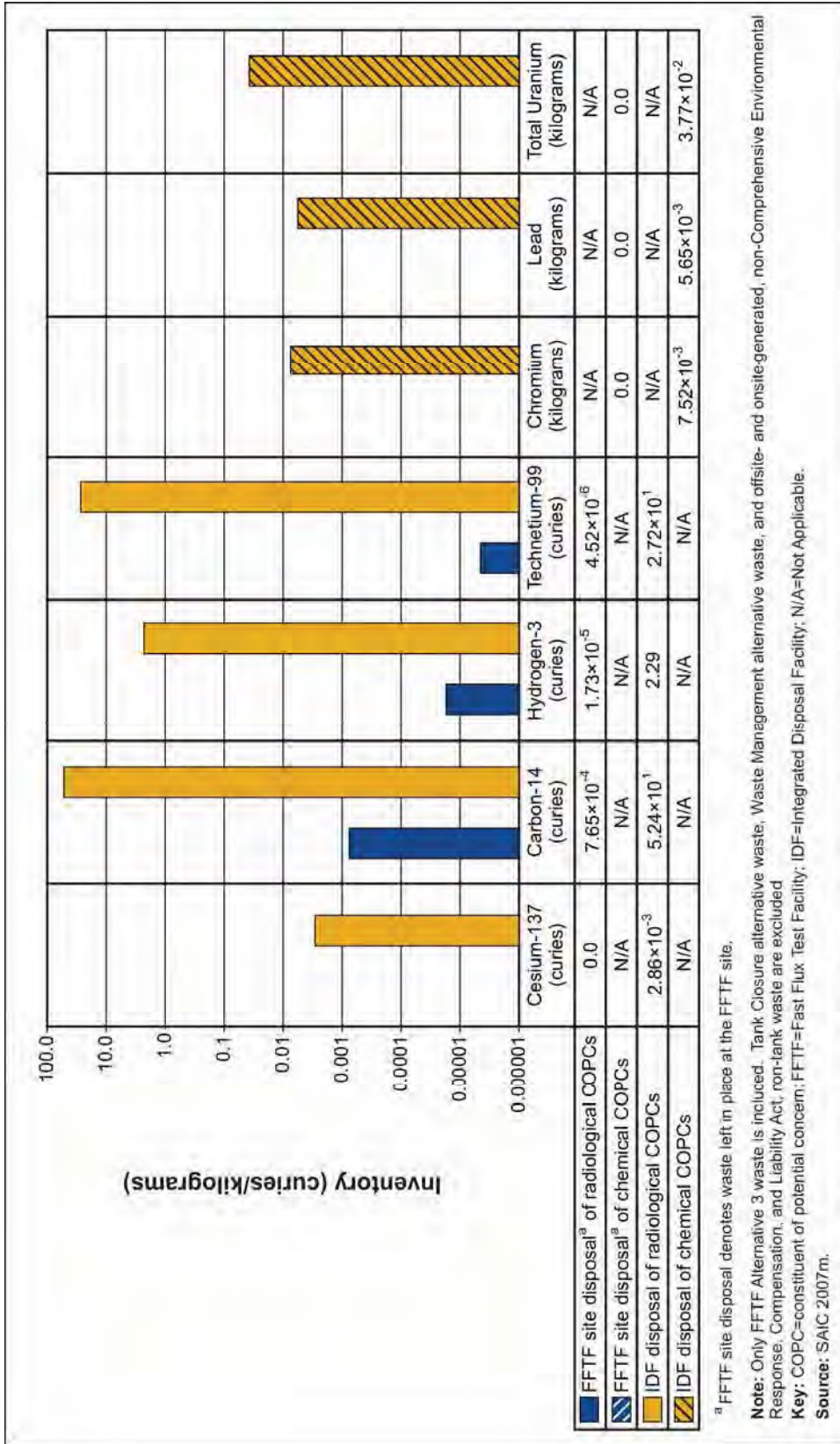

Figure D-66. FFFTF Decommissioning Alternative 3: Distribution of Radiological and Chemical Constituents of Potential Concern

D.3 WASTE MANAGEMENT ALTERNATIVES

D.3.1 Radioactive and Chemical Inventories

This section summarizes of the radioactive and chemical inventories analyzed for each of the three Waste Management alternatives. Appendix E, Section E.3.1, provides a summary description of the Waste Management alternatives analyzed in this *TC & WM EIS* and is partially reproduced in this section for the reader's convenience. Within the Waste Management alternatives, only three waste generators were identified for inclusion in the *TC & WM EIS* alternatives analyses:

- Secondary LLW and MLLW from operation of LLBG 218-W-5, trenches 31 and 34
- Secondary LLW and MLLW from operation of the Waste Receiving and Processing Facility (WRAP)
- Secondary LLW and MLLW from operation of the T Plant complex

Operation of an IDF and the RPPDF were estimated to generate insignificant quantities of secondary waste (e.g., workers' personal protective equipment and other contaminated waste materials). Data found for operation of the Central Waste Complex (CWC) concluded that it also generates insignificant quantities of secondary waste (SAIC 2007n, 2008a). Generators for onsite-generated, non-CERCLA, non-tank-activity wastes and offsite-generated wastes are identified in Section D.3.5 and D.3.6, respectively.

D.3.1.1 Assumptions

Assumptions for the Waste Management alternatives include:

- Due to uncertainties regarding the future needs of the waste management facilities at Hanford, the scope of the Waste Management alternatives assumed that expanded capabilities of the current treatment operations at the T Plant complex, CWC, and WRAP would be necessary.
- Tank closure activities would generate the following waste streams, which would be disposed of on site in an IDF: ILAW glass; retired LAW melters; bulk vitrification glass; steam reforming waste; cast stone waste; sulfate grout waste; ETF-generated solid secondary waste; other solid secondary waste from tank farm and treatment processes, including treatment of the cesium and strontium capsules; and PPF glass. Rubble, soil, and equipment generated from clean closure activities would be disposed of in the RPPDF.
- Treatment of offsite-generated LLW and MLLW would be completed off site either at the generator site or at a commercial treatment facility prior to shipment to Hanford. Section D.3.6 provides the offsite waste inventories and the basis for the inventory estimates.
- No additional offsite TRU or mixed TRU waste would be received at Hanford.
- Non-CERCLA, nontank LLW and MLLW would be generated at Hanford through 2035. Section D.3.5 provides this inventory and the basis for the inventory estimates.
- For analysis purposes, continued operation of LLBG 218-W-5, trenches 31 and 34, were analyzed under the Waste Management alternatives; however, it was assumed that IDF operations would commence in 2009 and that all waste generated that is appropriate for IDF disposal would be disposed of in an IDF.

- Activities proposed under the Tank Closure alternatives were assumed to determine the requirements for the ETF, 242-A Evaporator, and Borrow Area C; therefore, operations and replacement of these facilities were analyzed under the Tank Closure alternatives and not the Waste Management alternatives.
- Packaging and shipment of waste currently stored in a glass or ceramic form (commonly referred to as “German Logs”) was not analyzed in this *TC & WM EIS* (SAIC 2007n, 2008a).

D.3.2 Waste Management Alternative 1: No Action

Under this alternative, storage and treatment of LLW, MLLW, and TRU waste would continue at the CWC, and disposal would continue at LLBG 218-W-5, trenches 31 and 34, until an estimated operational closure date of 2035. Likewise, storage and treatment of onsite-generated LLW, MLLW, and TRU waste would continue at WRAP and the T Plant complex. No offsite shipments of LLW, MLLW, or TRU waste would be accepted. For analysis purposes, this EIS assumed that construction of the 200-East Area IDF (IDF-East) would be discontinued in 2008 and no closure barriers would be constructed over the disposal trenches and waste treatment facilities. Administrative controls would be carried on for 100 years following operational closure of the disposal trenches.

Table D–76 shows the radiological and chemical COPC inventories for Waste Management Alternative 1. These inventories would be disposed of in lined trenches 31 and 34 at LLBG 218-W-5.

Table D–76. Waste Management Alternative 1 Inventory^a

| | I-129 | Cs-137 | C-14 | H-3 (Tritium) | U-233, -234, -235, -238 | Np-237 | Pu-239, -240 | Sr-90 | Tc-99 | Cr | Hg | Pb |
|------------------------------|--------|-----------------------|------|------------------|----------------------------|--------|-----------------|-----------------------|-----------------------|-----------|----|----|
| | Curies | | | | | | | | | Kilograms | | |
| Secondary waste ^b | NR | 2.39×10 ⁻³ | NR | NR | NR | NR | NR | 1.63×10 ⁻³ | 2.13×10 ⁻³ | NR | NR | NR |

^a Only three chemicals were reported (nitrate, total uranium, acetonitrile, benzene, butanol [n-butyl alcohol], 2,4,6-trichlorophenol, and polychlorinated biphenyls were not reported).

^b Secondary waste includes workers’ personal protective equipment and other contaminated materials. Disposal would be Low-Level Radioactive Waste Burial Ground 218-W-5, trenches 31 and 34.

Key: C=carbon; Cs=cesium; Cr=chromium; H=hydrogen; Hg=mercury; I=iodine; Np=neptunium; NR=not reported; Pb=lead; Pu=plutonium; Sr=strontium; Tc=technetium; U=uranium.

Source: SAIC 2007n.

D.3.3 Waste Management Alternative 2: Disposal in IDF, 200-East Area Only

Under this alternative, storage and treatment of LLW, MLLW, and TRU waste would continue using both the existing and the proposed expanded capabilities at the CWC, T Plant complex, and WRAP. Appendix E, Sections E.3.2, E.3.3 and E.3.4, describe in detail the expanded CWC, T Plant complex, and WRAP facilities, respectively. Offsite waste would be limited to 62,000 cubic meters (81,000 cubic yards) of LLW and 20,000 cubic meters (26,000 cubic yards) of MLLW, with reception of shipments estimated to occur from 2010 through 2046. Onsite (Hanford)-generated, non-CERCLA, nontank waste would be generated through 2035. For analysis purposes, operation of LLBG 218-W-5, trenches 31 and 34, would continue through 2050. IDF-East would begin operations in 2009. Under this alternative, IDF-East would accept the following waste: tank closure activity waste, FFTF decommissioning waste, waste management facility-generated (secondary) waste, site-generated, non-CERCLA, non-tank-activity waste, and offsite-generated waste. A new disposal facility, the RPPDF, would be constructed for disposal of lightly contaminated rubble, soil, and equipment resulting from clean closure of tank farm facilities.

To reduce the combinations of IDF and RPPDF configurations that would require analysis in this TC & WM EIS, three disposal groups were developed and analyzed:

- *Disposal Group 1:* This group supports Tank Closure Alternatives 2B, 3A, 3B, 3C, 4, 5, and 6C; FFTF Decommissioning Alternatives 2 and 3; and Waste Management Alternative 2 for onsite-generated, non-CERCLA, non-tank-activity waste and offsite-generated waste. Both IDF-East and the RPPDF would operate through 2050, with capacities of 1.2 million cubic meters (1.57 million cubic yards) and 1.08 million cubic meters (1.41 million cubic yards), respectively.
- *Disposal Group 2:* This group supports Tank Closure Alternatives 2A and 6B, both the Base and Option Cases; FFTF Decommissioning Alternatives 2 and 3; and Waste Management Alternative 2 for onsite-generated, non-CERCLA, non-tank-activity waste and offsite-generated waste. Both IDF-East and the RPPDF would operate through 2100, with capacities of 425,000 cubic meters (556,000 cubic yards) and 8.37 million cubic meters (10.9 million cubic yards), respectively.
- *Disposal Group 3:* This group supports Tank Closure Alternative 6A, Base and Option Cases; FFTF Decommissioning Alternatives 2 and 3; and Waste Management Alternative 2 for onsite-generated, non-CERCLA, non-tank-activity waste and offsite-generated waste. Both IDF-East and the RPPDF would operate through 2165, with capacities of 425,000 cubic meters (556,000 cubic yards) and 8.37 cubic meters (10.9 million cubic yards), respectively.

Table D-77 shows the radiological and chemical COPC inventories for Waste Management Alternatives 2 and 3 (discussed below). Under Waste Management Alternative 2, disposal of these inventories would occur in IDF-East.

Table D-77. Waste Management Alternatives 2 and 3 Radiological and Chemical Constituents of Potential Concern Balance^a

| | I-129 | Cs-137 | C-14 | H-3 (Tritium) | U-233, -234, -235, -238 | Np-237 | Pu-239, -240 | Sr-90 | Tc-99 | Cr | Hg | Pb |
|------------------------------|-----------------------|--------|-----------------------|----------------------|----------------------------|-----------------------|-----------------|-------|-----------------------|----------------------|------|----------------------|
| | Curies | | | | | | | | | Kilograms | | |
| Secondary waste ^b | 1.43×10 ⁻⁵ | 1.04 | 4.04×10 ⁻⁵ | 3.03×10 ¹ | 1.05×10 ⁻³ | 6.17×10 ⁻⁶ | 1.86 | 6.28 | 9.95×10 ⁻² | 1.39×10 ¹ | 2.29 | 2.32×10 ² |

^a Only three chemicals were reported (nitrate, total uranium, acetonitrile, benzene, butanol [n-butyl alcohol], 2,4,6-trichlorophenol, and polychlorinated biphenyls were not reported).

^b Secondary waste includes workers' personal protective equipment and other contaminated materials, as well as Waste Receiving and Processing Facility and T Plant complex low-level radioactive waste and mixed low-level radioactive waste, which would be disposed of in an Integrated Disposal Facility in the 200-East Area under Waste Management Alternative 2 and in the 200-West Area under Waste Management Alternative 3.

Key: C=carbon; Cs=cesium; Cr=chromium; H=hydrogen; Hg=mercury; I=iodine; Np=neptunium; Pb=lead; Pu=plutonium; second=secondary; Sr=strontium; Tc=technetium; U=uranium.

Source: SAIC 2007n.

D.3.4 Waste Management Alternative 3: Disposal in IDF, 200-East and 200-West Areas

Under this alternative, activities would be the same as those under Waste Management Alternative 2, except disposal of the waste would be split between IDF-East and a new IDF site in the 200-West Area (IDF-West). With the exception of the waste from tank closure activities, all of the waste streams discussed under Waste Management Alternative 2 would be disposed of in IDF-West. Only the tank closure waste would be disposed of in IDF-East.

The three disposal groups under Waste Management Alternative 3 are:

- *Disposal Group 1:* This group supports Tank Closure Alternatives 2B, 3A, 3B, 3C, 4, 5, and 6C; FFTF Decommissioning Alternatives 2 and 3; and Waste Management Alternative 3 for onsite-generated, non-CERCLA, non-tank-activity waste and offsite-generated waste. IDF-East would have a capacity of 1.1 million cubic meters (1.43 million cubic yards), IDF-West would have a capacity of 90,000 cubic meters (118,000 cubic yards), and the RPPDF would have a capacity of 1.08 million cubic meters (1.41 million cubic yards). All three facilities would operate through 2050.
- *Disposal Group 2:* This group supports Tank Closure Alternatives 2A and 6B, both the Base and Option Cases; FFTF Decommissioning Alternatives 2 and 3; and Waste Management Alternative 3 for onsite-generated, non-CERCLA, non-tank-activity waste and offsite-generated waste. IDF-East would have a capacity of 340,000 cubic meters (445,000 cubic yards), IDF-West would have a capacity of 90,000 cubic meters (118,000 cubic yards); and the RPPDF would have a capacity of 8.37 million cubic meters (10.9 million cubic yards). IDF-East and the RPPDF would operate through 2100. IDF-West would operate through 2050.
- *Disposal Group 3:* This group supports Tank Closure Alternative 6A, Base and Option Cases; FFTF Decommissioning Alternatives 2 and 3; and Waste Management Alternative 3 for onsite-generated, non-CERCLA, non-tank-activity waste and offsite-generated waste. IDF-East would have a capacity of 340,000 cubic meters (445,000 cubic yards), IDF-West would have a capacity of 90,000 cubic meters (118,000 cubic yards), and the RPPDF would have a capacity of 8.37 million cubic meters (10.9 million cubic yards). IDF-East and the RPPDF would operate through 2165. IDF-West would operate through 2050.

Table D-77 shows the radiological and chemical COPC inventories for Waste Management Alternatives 2 (discussed above) and 3. Under Waste Management Alternative 3, disposal of these inventories would occur in IDF-West.

D.3.5 Radioactive and Chemical Inventory Estimates for Onsite-Generated, Non-CERCLA, Non-Tank-Activity Waste

This section summarizes the non-CERCLA, non-tank-waste-related radiological and chemical waste inventories that would be generated at Hanford. Examples of facilities and operations that are expected to generate such waste include the Plutonium Finishing Plant; the T Plant complex; the Waste Encapsulation and Storage Facility; WRAP; the Waste Sampling and Characterization Facility; groundwater sampling activities; Pacific Northwest National Laboratory; the Cold Vacuum Drying Facility; the Canister Storage Building; and the Liquid Waste Processing Facilities, which include the Liquid Effluent Retention Facility, ETF, State-Approved Land Disposal Site, and the Treatment Effluent Disposal Facility.

Estimates of the radiological and chemical inventories for the above sources were developed from the Hanford *Solid Waste Integrated Forecast Technical (SWIFT) Report, FY2006–FY2035* database (Barcot 2005). From this source, the volume of LLW and MLLW for the period of 2006 through 2035 was estimated to be approximately 5,300 cubic meters (6,930 cubic yards) (SAIC 2008b).

Table D-78 is a summary of the radiological COPC inventory for the onsite-generated, non-CERCLA, non-tank-activity waste. Table D-79 is a summary of the chemical COPC inventory for the onsite-generated, non-CERCLA, non-tank-activity waste.

Table D-78. Onsite-Generated, Non-CERCLA, Non-Tank-Activity Waste Radiological Constituents of Potential Concern Inventory^a

| | Iodine-129 | Cesium-137 | Carbon-14 | Hydrogen-3 (Tritium) | Uranium-233, -234, -235, -238 | Neptunium-237 | Plutonium -239, -240 | Strontium-90 | Technetium-99 |
|-----------------|-----------------------------|----------------------------|-----------------------------|----------------------------|-------------------------------|-----------------------------|----------------------|----------------------------|-----------------------|
| Curies | | | | | | | | | |
| CH- and RH-LLW | 9.98×10 ⁻⁵ | 1.36×10 ³ | 8.17×10 ⁻¹ | 2.68×10 ³ | 2.24×10 ⁻¹ | 4.38×10 ⁻⁵ | 4.22 | 1.75×10 ³ | 7.95×10 ⁻¹ |
| CH- and RH-MLLW | 1.22×10 ⁻³ | 1.35×10 ³ | 6.88×10 ⁻³ | 8.28×10 ² | 5.12×10 ⁻¹ | 7.33×10 ⁻³ | 3.81 | 1.73×10 ³ | 4.17×10 ⁻¹ |
| Total | 1.32×10⁻³ | 2.71×10³ | 8.24×10⁻¹ | 3.51×10³ | 7.36×10⁻¹ | 7.37×10⁻³ | 8.03 | 3.48×10³ | 1.21 |

^a Onsite generators only, including the Plutonium Finishing Plant; T Plant complex; Waste Encapsulation Storage Facility; Waste Receiving and Processing Facility; Waste Sampling and Characterization Facility; groundwater sampling activities; Pacific Northwest National Laboratory; Cold Vacuum Drying Facility; Canister Storage Building; and Liquid Waste Processing Facilities (Liquid Effluent Retention Facility, Effluent Treatment Facility, State-Approved Land Disposal Site, and Treatment Effluent Disposal Facility).

Key: CERCLA=Comprehensive Environmental Response, Compensation, and Liability Act; CH=contact-handled; LLW=low-level radioactive waste; MLLW=mixed low-level radioactive waste; RH=remote-handled.

Source: SAIC 2008b.

Table D-79. Onsite-Generated, Non-CERCLA, Non-Tank-Activity Waste Chemical Constituents of Potential Concern Inventory^a

| | Acetonitrile | Arsenic (As) | Benzene | Boron (B) | Butanol (n-butyl alcohol) | Cadmium (Cd) | Chromium (Cr) | Fluorine (F) | Lead (Pb) | Manganese (Mn) | Mercury (Hg) | Molybdenum (Mo) | Nickel (Ni) | NO ₃ (Nitrate) | PCBs | Silver (Ag) | Strontium (Sr) | Total Uranium (U) | 2,4,6-Trichlorophenol |
|------------------|--------------|--------------|---------|-----------|---------------------------|----------------------|----------------------|----------------------|----------------------|----------------------|----------------------|-----------------------|-------------|---------------------------|----------------------|----------------------|----------------|-----------------------|-----------------------|
| Kilograms | | | | | | | | | | | | | | | | | | | |
| CH- and RH-MLLW | 3.91 | 6.70 | 1.02 | 3.66 | 1.39×10 ⁻³ | 4.95×10 ¹ | 1.80×10 ² | 2.74×10 ² | 2.58×10 ⁴ | 4.76×10 ¹ | 8.99×10 ¹ | 9.39×10 ⁻⁵ | 1.97 | 2.97×10 ³ | 2.50×10 ¹ | 7.80×10 ¹ | 3.13 | 9.48×10 ⁻¹ | NR |

^a Onsite generators only, including the Plutonium Finishing Plant; T Plant complex; Waste Encapsulation Storage Facility; Waste Receiving and Processing Facility; Waste Sampling and Characterization Facility; groundwater sampling activities; Pacific Northwest National Laboratory; Cold Vacuum Drying Facility; Canister Storage Building; and Liquid Waste Processing Facilities (Liquid Effluent Retention Facility, Effluent Treatment Facility, State-Approved Land Disposal Site, and Treatment Effluent Disposal Facility).

Key: CERCLA=Comprehensive Environmental Response, Compensation, and Liability Act; CH=contact-handled; MLLW=mixed low-level radioactive waste; NR=not reported; PCBs=polychlorinated biphenyls; RH=remote-handled.

Source: SAIC 2008b.

D.3.6 Projected Volumes, Radioactive and Chemical Inventories for Offsite Waste

As part of the Settlement Agreement among the DOE, the Washington State Department of Ecology, and the Washington State Attorney General's Office (*State of Washington v. Bodman*, Civil No. 2:03-cv-05018-AAM, January 6, 2006), this *TC & WM EIS* evaluated the transportation of LLW and MLLW from other DOE sites to Hanford for disposal. The volume of this offsite waste is established in existing stipulations that were agreed upon with the State of Washington, entered as orders of the court in the Settlement Agreement, and recorded in the "Record of Decision for the *Solid Waste Program, Hanford Site, Richland, WA: Storage and Treatment of Low-Level Waste and Mixed Low-Level Waste; Disposal of Low-Level Waste and Mixed Low-Level Waste, and Storage, Processing, and Certification of Transuranic Waste for Shipment to the Waste Isolation Pilot Plant*" (69 FR 39449). The volumes are limited to 62,000 cubic meters (81,100 cubic yards) of LLW and 20,000 cubic meters (26,200 cubic yards) of MLLW. These upper limit volumes were used for analysis purposes only in this *TC & WM EIS*.

The DOE Office of River Protection and the *TC & WM EIS* team, in coordination with the DOE Office of Environmental Management, developed a report, *Analysis of Offsite-Generated Waste Projections, "Tank Closure and Waste Management Environmental Impact Statement for the Hanford Site,"* dated July 13, 2006 (DOE 2006b), which documents the methodology and analysis related to offsite-generated LLW and MLLW potentially requiring disposal at Hanford. The following is an excerpt from this, followed by a summary of the projected waste characteristics, volumes, and radionuclide and chemical inventories. Offsite waste is analyzed under Waste Management Alternatives 2 and 3 only. It was assumed no offsite waste would be accepted under Waste Management Alternative 1, the No Action Alternative.

BACKGROUND

"The Hanford Site hosts one of two regional disposal facilities for the Department of Energy's (DOE) low-level radioactive waste (LLW) and mixed LLW (MLLW) resulting from a February 2000 Record of Decision on the *Waste Management Programmatic Environmental Impact Statement (WMPEIS)*. The *Hanford Solid Waste Environmental Impact Statement (2004)* is the site-specific National Environmental Policy Act document that analyzed specific impacts resulting from disposal of onsite- and offsite-generated LLW and MLLW at Hanford. In January 2006, as a result of a settlement agreement with the State of Washington, the DOE agreed to prepare a new, expanded, comprehensive environmental impact statement (EIS) that combines the scope of the 2004 *Solid Waste EIS* and the developing *TC & WM EIS*. The Environmental Management (EM) Office of Disposal Operations, formerly the Office of Commercial Disposition Options, was asked to compile offsite-generated waste data as input to this new EIS. Waste data, e.g., projected waste volumes, radionuclide inventories, and hazardous chemical constituents are needed for analysis of impacts to humans and the environment within the EIS.

The information needed for the EIS was not readily available, so efforts were undertaken to use existing corporate information, supplemented by information from DOE waste managers. The EM program has corporate performance metrics that capture the actual and projected volume of LLW and MLLW for disposal from "baselined" projects. The information was not sufficiently detailed for modeling purposes, e.g. LLW and MLLW are combined, and data on radionuclide or hazardous chemical constituents is not collected and maintained corporately.

Waste volume projections and “disposition maps” were developed for the EM program in 1999 and 2000 as part of the EM Integration Project. At that time the EM Corporate Information System (Integrated Planning, Accountability, and Budgeting System or IPABS) was developed, including a “stream disposition data” module that provided detail on where individual waste streams were treated and disposed. Largely because of the resource requirements to supply and maintain the stream disposition data, EM management decided to forgo collection of waste volume information at the stream level as a corporate performance metric, in favor of waste volume disposed at the site or project level. Disposition maps, which schematically showed waste streams both within a site and between sites, were not produced between 2001 and 2005.

Due to various program planning needs associated with waste disposition, the Office of Commercial Disposition Options developed a new complex-wide LLW and MLLW data set and new, simplified disposition maps. The data requirements were significantly streamlined with the assistance of EM and other DOE waste managers. A new data collection module was constructed in September 2005, and data was compiled in late 2005 and early 2006. This data was readily available for analysis. Since the new data reflects only currently planned activities within EM, additional information was required to forecast LLW and MLLW that might be sent to Hanford from all offsite sources, e.g., unplanned EM projected waste volumes and waste from other DOE programs.

LLW and MLLW is generated at numerous DOE sites across the complex. Most of the volume of LLW and MLLW is generated from cleanup projects, versus ongoing operations. Over the past several years waste inventories that had been historically stored waiting for treatment and disposal, often called “legacy waste,” have nearly all been disposed due to contract incentives aimed at reducing life-cycle waste management infrastructure and costs. Estimates of potential, future offsite generated LLW and MLLW volumes requiring disposal in DOE regional disposal facilities are comprised primarily of waste generated in cleanup and decommissioning projects, rather than legacy waste. Much of this work is yet to be planned. Therefore, there are significant uncertainties in waste volume projections because waste is yet to be generated, and little characteristic information is available as previously discussed. This is a change from the situation during the early years of the EM program when most MLLW was in storage awaiting treatment and disposition.

In addition to uncertainties in waste volume, the newly collected LLW and MLLW waste data did not include radionuclide or hazardous chemical data needed for EIS modeling. EM has not collected radionuclide and hazardous constituent information since the 1990’s, when data was collected to support the Federal Facilities Task Force and the WMPEIS development. Documented information on radionuclides is found in the *Low-Level Waste Capacity Report*, Revision 2, produced in 2000. This document continues to serve as a source for waste characteristics.

It is difficult to predict the radionuclide and hazardous chemical composition of waste projected in the future, particularly from cleanup programs, because the waste does not exist until the cleanup work progresses. Forecasts are based on best available characterization of the site or facility, the technology selected for cleanup, and the work plans. For this reason, the forecast waste characteristics data in most instances relies on representative information from similar waste streams recently sent to disposal. Actual LLW and MLLW disposal profiles were requested from waste managers and several were judged to have the necessary data for modeling and be suitable for projected waste

streams. The Rocky Flats Environmental Technology Site was a source of recent waste profiles for MLLW, one of which covered debris including metals, solvents, and waste requiring macro-encapsulation. The characteristics of this stream were judged to be a reasonable representation for radiological and hazardous chemical constituents of MLLW from future cleanup projects.

DISCUSSION

For the purposes of the new consolidated EIS, the volumes of offsite-generated LLW and MLLW in the existing *Hanford Solid Waste EIS* Record of Decision, namely 62,000 cubic meters for LLW and 20,000 cubic meters for MLLW, should continue to be used in the new EIS. These values sufficiently accommodate current projections and include anticipated new projections for sites where significant cleanup activities and operations are not yet fully scoped. Due to the timing of the EIS and the implementation of resulting record of decision, offsite waste forecasts are largely assumed to begin in 2010, so examination of post 2010 waste volume data collected by EM was the starting point of the analysis. The makeup of the waste volume forecast is discussed below and the attached table summarizes the information.

Environmental Management

A high degree of uncertainty exists in how much LLW could be shipped from EM sites to Hanford after 2010. Based on current practices, waste from EM sites without onsite disposal capacity can be expected to utilize both DOE regional and commercial disposal facilities. Only EM sites completing cleanup beyond 2010 are considered in this forecast. Sites that are major EM contributors to EM LLW disposal projections in 2011 to 2035 (over 1,000 cubic meters) are: Idaho National Laboratory (INL), Paducah, and Oak Ridge. Future waste projections from expected decommissioning at Portsmouth and West Valley, and additional work at Paducah have not yet been developed and reported to EM, but must also be considered.

The recently collected planning data includes no EM offsite shipments of LLW and MLLW projected for the Hanford regional disposal facility. It is not surprising that current baselines do not include shipments to Hanford because, due to the current suspension of off-site shipments, EM projects were replanned to utilize alternate sites. About 112,000 cubic meters of LLW are projected to go to the regional disposal site at Nevada Test Site (NTS) between 2011 and 2035. No MLLW is currently proposed to be disposed at NTS after closure of the current facility at the end of 2010. About 11,700 cubic meters of LLW and 900 cubic meters of MLLW were identified as needing a disposal facility to be determined (TBD) after 2010, some of which may be disposed in a commercial facility. DOE policy, economic factors, and waste acceptance criteria are key to waste management decisions. Coincidentally, the 62,000 cubic meters in the *Hanford Solid Waste EIS* Record of Decision equates to about half of the life-cycle LLW projection for offsite disposal for NTS and TBD combined.

West Valley Demonstration Project is at the site of a former commercial reprocessing plant where DOE and the State of New York are responsible for cleanup. West Valley has a site-wide *Decommissioning and Long-Term Stewardship* EIS in preparation, but agreement on the end state has not occurred. Thus, there is no “baselined” scope of work beyond 2010 and no baseline estimate of future waste from West Valley, although a draft EIS is available with a range of waste projections. LLW from West Valley is expected to contain a variety of radionuclides, including transuranics and fission products, and be in a

variety of forms. West Valley is expected to produce significant volumes of waste for offsite disposal between 2010 and 2030 through facility decommissioning activities. Based on discussions with site waste managers and information in the draft EIS, waste volumes associated with Alternative 4, a “delayed in-place” decommissioning were assumed for this forecast. A LLW volume of 12,000 cubic meters was judged to be a reasonable forecast. Although Alternative 4 in the draft EIS does not have an estimate of MLLW volumes, other alternatives indicated that MLLW debris might be generated during decommissioning at West Valley. Due to the distinct possibility of MLLW generation at West Valley, 500 cubic meters of MLLW was judged to be a reasonable forecast. No radiological or hazardous chemical information was available for modeling, so representative information was selected. For LLW, the complex-wide radiological profile in the DOE Capacity Report was selected as representative; for MLLW a representative Rocky Flats debris stream profile with radiological and hazardous chemical data was selected which included metals, solvents, and waste requiring macro-encapsulation.

Idaho National Laboratory (INL) is managed by the Office of Nuclear Energy (NE); however, EM has a large cleanup project that generates waste at that site during the first several years of the period of concern. EM currently operates the low-level waste disposal area for operational LLW and the Idaho CERCLA Disposal Facility for Comprehensive Environmental Response, Cleanup, and Liability Act (CERCLA) waste at INL. The INL is examining future alternatives for closure of their onsite disposal facility for LLW from operations. Closure may be required to implement the terms of their final remedy decision currently being developed. Closure of this INL disposal facility would require another disposal option for the LLW currently disposed there which is generated by NE, EM, and Naval Reactors; therefore, modeling of a Hanford alternative is appropriate.

The existing NE programs at INL estimated approximately 1,100 cubic meters of remote-handled LLW and approximately 10 cubic meters of MLLW shipped to Hanford after 2010. Because of the proximity of Hanford versus NTS, Hanford disposal would be a logical place for this and other future waste not capable of being disposed of commercially due to higher activity levels (e.g., equivalent of Class B and C commercial LLW). The annual waste quantities are consistent with those reported between 2010 and 2035 to EM’s planning data base. After discussions with waste managers at DOE-Idaho Operations, a representative radiological profile for modeling LLW consisting of Test Reactor Area depleted demineralizer resins was used for the radiological characteristics. This is an existing and ongoing post-2010 remote-handled LLW stream disposed of at INL. The same discussions suggested use of an INL MLLW debris waste stream from the INTEC facility for radiological characteristics and tank farm-related waste information for the chemical characteristics for the small MLLW stream.

The INL plans to play a prominent role in development of the Generation IV prototype nuclear reactor, piloting of an Advanced Fuel Cycle Facility, and expansion for the Center of Advanced Energy Studies generating waste far into the future. In addition, some EM MLLW was historically managed as transuranic waste, but when surveyed has a radionuclide concentration of 10 to 100 nanocuries per gram. The forecast includes future new LLW and MLLW streams from INL. No characteristics information is available, but the waste projected between 2010 and 2020 is assumed to be similar to other waste at INL. The existing profile for Test Reactor Area depleted demineralizer resins is appropriate for the LLW stream of 6,500 cubic meters, while the Rocky Flats

radiological and chemical characteristics are representative for the MLLW stream of 6,330 cubic meters.

Portsmouth and Paducah sites are home to large enrichment plants that will be decommissioned after 2010 by the EM program. Significant volumes of waste are expected to be generated and disposed then at DOE and/or commercial disposal facilities. However, no data is available from these projects, because they are in the early design stage and work scope is not yet planned. The forecast includes 6,500 cubic meters of LLW from each site. Portsmouth waste is forecast between 2010 and 2020, while Paducah waste is forecast between 2015 and 2035. No MLLW was assumed from these sites, since the waste is largely debris from large enrichment plants contaminated primarily with uranium. Representative waste characteristics were selected from existing cleanup waste profiles from the Oak Ridge Gaseous Diffusion Plant (East Tennessee Technology Park) where decommissioning a similar site is progressing and is scheduled to be complete by 2010. Four representative profiles were judged to be appropriate and applied proportionally to the projected waste volumes at Portsmouth and Paducah.

Los Alamos National Laboratory (LANL) is operated by the National Nuclear Security Administration and has onsite disposal facilities for its LLW. The EM program at LANL is currently characterizing waste historically managed as TRU waste. A portion of this waste when characterized does not meet the definition of TRU waste and cannot be disposed on site at LANL because MLLW disposal is not permitted. Projected MLLW that falls between 10 and 100 nanocuries per gram is a candidate for the Hanford forecast after closure of the NTS MLLW facility. The forecast volume of LANL MLLW between 2010 and 2020, when all TRU characterization work is expected to be complete, is 400 cubic meters. As a result of discussions with waste managers at LANL, radiological profiles were obtained for inorganic cemented sludge from an on-site water treatment plant. No chemical profile was available for the LANL sludge, so comparable INL chemical characterization data for two batches of MLLW sludge was obtained and judged as representative.

Savannah River Site (SRS) utilizes both onsite and commercial disposal facilities for its LLW. No LLW is forecast to be shipped to Hanford. In discussions with waste managers at SRS, a waste stream with 100 cubic meters of MLLW was identified as a candidate for disposal at Hanford in 2010-2012 following the NTS MLLW facility closure. SRS waste managers provided a radiological profile for the MLLW which contains some Pu-238 and Pu-239 constituents. No chemical characteristics were available, so the chemical profile for Rocky Flats debris MLLW waste was judged as representative. To accommodate future, as yet unplanned MLLW generation at SRS, another MLLW stream is included in the forecast with 6,330 cubic meters between 2010 and 2035. The same Rocky Flats debris waste profile was judged as representative for the radiological and hazardous chemical constituents.

Office of Science Waste

The Office of Science (SC) is responsible for ongoing operations at eight DOE laboratory sites. Historically, the SC laboratories shipped LLW to Hanford for disposal, but were prevented from doing so recently due to legal impediments. SC waste managers indicated most waste generated from operations is now planned for NTS or commercial disposal.

Three SC-operated laboratories: Argonne National Laboratory (ANL), Brookhaven National Laboratory (BNL), and Oak Ridge National Laboratory (ORNL) forecasted future waste that could be disposed at Hanford. ANL forecasted 100 cubic meters of LLW from decommissioning of facilities between 2011 and 2018. Radiological characteristics of this future LLW volume was not available from waste managers, so the Capacity Report complex wide profile was judged to be appropriate due to the variety of nuclear applications at ANL. BNL waste managers identified two LLW streams totaling 70 cubic meters with corresponding radioactive waste profiles. The streams include sealed sources (disposed between 2010 and 2015) and decommissioning waste from the Brookhaven Linear Isotope Production facility between 2030 and 2035.

SC waste managers estimated 730 cubic meters of LLW between 2010 and 2035 timeframe from ongoing operations in Oak Ridge. Radiological characteristics of this future LLW volume was not available from waste managers, so the Capacity Report complex wide profile was judged to be appropriate due to the variety of nuclear applications at ORNL. In addition to operations waste, there are a number of facilities at the Oak Ridge Reservation that have not yet been scheduled for decommissioning by SC, EM, or NNSA. The scope of the work and resulting waste is uncertain, but additional waste is likely after 2010. Some of this waste will be disposed off site at DOE regional disposal facilities and commercial facilities, consistent with the Oak Ridge experience to date. The forecast includes a LLW stream of 6,500 cubic meters and a MLLW stream of 6,330 cubic meters for future waste from Oak Ridge. For LLW, the Capacity Report complex-wide profile was judged appropriate due to the variety of waste from cleanup. For MLLW, the Rocky Flats debris stream also applied at West Valley, INL, and SRS forecasts was judged appropriate for the variety of waste expected from cleanup.

Naval Reactors

Naval Reactors (a part of NNSA) produces LLW as a result of operations of various shipyards and laboratories across the nation. In addition to Naval Reactors LLW already disposed at Hanford, a new Naval Reactors waste stream is included in the forecast for analytical purposes. As mentioned previously, LLW generated at the Naval Reactors Facility (NRF) at INL is currently disposed onsite at INL, but the LLW disposal facility used by Naval Reactors at INL may close in the near future as a result of the site cleanup agreement. Discussions with Naval Reactors waste managers resulted in a projected volume of 22,000 cubic meters of routine LLW from the NRF at INL that is included in the Hanford forecast between 2008 and 2046. A radiological profile has been provided by Naval Reactors for this LLW.

CONCLUSIONS

DOE used available waste volume projections to frame the forecast for the *Hanford Tank Closure and Waste Management EIS*. The analysis focused on ongoing operations and post-2010 cleanup activities that will generate wastes requiring or utilizing DOE regional disposal facilities. After contacting waste managers, expert judgment was applied to waste projection and characteristics data to develop a waste forecast for the new Hanford EIS. Considerable uncertainty remains in the waste projections, due to limited planning data and the uncertainties in the cleanup program scope from where most waste volumes arise. However, conservative assumptions were employed to support EIS analyses. This analysis confirms the need to maintain the waste volumes included in the record of decision from the 2004 *Hanford Solid Waste EIS* (62,000 cubic meters for LLW and

20,000 cubic meters of MLLW) and provides assumptions for modeling purposes, including offsite sources, timing, and sources of radiological/chemical characteristics.” (DOE 2006b)

The process described above resulted in estimated waste volumes, waste characteristics, final waste forms, and shipment dates for the waste generated by other DOE sites that would be shipped to Hanford for disposal. Radioactivity estimates (measured in curies) for over 110 isotopes and chemical estimates (measured in kilograms) for 41 chemical compounds also were developed. These data formulate the *Inventory Data for Hanford Offsite Waste Projections* (SAIC 2006b).

As stated above, the *Analysis of Offsite-Generated Waste Projections, “Tank Closure and Waste Management Environmental Impact Statement for the Hanford Site”* report (DOE 2006b) includes estimates for wastes generated at the West Valley Demonstration Project that may require disposal at Hanford. The estimates were 12,000 cubic meters (15,700 cubic yards) of LLW and 500 cubic meters (650 cubic yards) of MLLW. Since then, DOE has prepared the *Revised Draft Environmental Impact Statement for Decommissioning and/or Long-Term Stewardship at the West Valley Demonstration Project and Western New York Nuclear Service Center* (DOE and NYSERDA 2008), which slightly revises these estimates. Under the Sitewide Removal Alternative, which is the alternative resulting in the largest waste volume requiring offsite disposal, the revised estimated volumes are approximately 13,710 cubic meters (17,930 cubic yards) of LLW and 510 cubic meters (670 cubic yards) of MLLW. Due to the high degree of uncertainty involved in estimating waste shipments to Hanford after 2010, the current estimates of 12,000 cubic meters (15,700 cubic yards) of LLW and 500 cubic meters (650 cubic yards) of MLLW are considered reasonable estimates and appropriate for analysis purposes in this *TC & WM EIS*. Additionally, since the above analysis was performed, DOE has initiated planning for a new MLLW disposal facility at NTS to continue to provide two DOE residual disposal facilities consistent with the *Final Waste Management Programmatic Environmental Impact Statement for Managing Treatment, Storage, and Disposal of Radioactive and Hazardous Waste* (DOE/EIS-0200-F, May 1997) (DOE 1997) and the LLW and MLLW ROD (65 FR 10061).

Table D–80 summarizes the DOE sites, waste form characteristics, and volumes and years of shipment projected for waste shipments from other DOE sites to Hanford. Table D–81 summarizes the nine radiological COPC inventories associated with the potential wastes from each DOE site. Table D–82 summarizes the 15 chemical COPC inventories associated with the potential wastes from each DOE site.

Table D–80. Offsite Waste Projection Characteristics by U.S. Department of Energy Site

| DOE Site and Waste Category | Waste Category ^a | Final Waste Form | Waste Form Volume (cubic meters) | Year of Shipment | |
|----------------------------------|-----------------------------|------------------|----------------------------------|------------------|------|
| | | | | Start | End |
| West Valley | | | | | |
| WV-Class A | LLW-Class A | Grouted | 11,000 | 2010 | 2030 |
| WV-Class B | LLW-Class B | Grouted | 200 | 2010 | 2030 |
| WV-Class C | LLW-Class C | Grouted | 800 | 2010 | 2030 |
| Idaho National Laboratory | | | | | |
| RH-LLW | RH-LLW | Resins | 30 | 2010 | 2010 |
| RH-LLW | RH-LLW | Resins | 200 | 2011 | 2015 |
| RH-LLW | RH-LLW | Resins | 200 | 2016 | 2020 |
| RH-LLW | RH-LLW | Resins | 200 | 2021 | 2025 |
| RH-LLW | RH-LLW | Resins | 200 | 2026 | 2030 |
| RH-LLW | RH-LLW | Resins | 270 | 2030 | 2035 |

**Table D–80. Offsite Waste Projection Characteristics by U.S. Department of Energy Site
(continued)**

| DOE Site and Waste Category | Waste Category ^a | Final Waste Form | Waste Form Volume (cubic meters) | Year of Shipment | |
|---|-----------------------------|--|----------------------------------|------------------|------|
| | | | | Start | End |
| Brookhaven National Laboratory | | | | | |
| BNL Sealed Sources | LLW | Sealed sources | 5 | 2010 | 2015 |
| BNL-2 – Brookhaven Linear Isotope Production Facility | LLW | Encapsulated activated metals, concrete debris, lead (solid) | 65 | 2030 | 2035 |
| Oak Ridge National Laboratory – LLW | LLW | Grout | 730 | 2010 | 2035 |
| Argonne National Laboratory – LLW | LLW | Grout | 100 | 2011 | 2018 |
| Naval Reactors | | | | | |
| LLW – Bettis, Idaho | LLW | Solid | 22,000 | 2008 | 2046 |
| Paducah | | | | | |
| LLW #1 | LLW | Solids (metal) | 845 | 2015 | 2035 |
| LLW #2 | LLW | Solids (metal) | 195 | 2015 | 2035 |
| LLW #3 | LLW | Solids (metal) | 1,690 | 2015 | 2035 |
| LLW #4 | LLW | Solids (metal) | 3,770 | 2015 | 2035 |
| Portsmouth | | | | | |
| LLW #1 | LLW | Solids (metal) | 845 | 2010 | 2020 |
| LLW #2 | LLW | Solids (metal) | 195 | 2010 | 2020 |
| LLW #3 | LLW | Solids (metal) | 1,690 | 2010 | 2020 |
| LLW #4 | LLW | Solids (metal) | 3,770 | 2010 | 2020 |
| Idaho – RH-LLW | RH-LLW | Resins | 6,500 | 2010 | 2020 |
| Oak Ridge – LLW | LLW | Grout | 6,500 | 2010 | 2035 |
| Total LLW | | | 62,000 | | |
| West Valley – MLLW | MLLW | Debris | 500 | 2010 | 2030 |
| Los Alamos National Laboratory – MLLW | MLLW | Cemented sludges | 400 | 2010 | 2020 |
| Savannah River Site – MLLW | RH-MLLW | Grout | 100 | 2010 | 2012 |
| Idaho | | | | | |
| RH-MLLW | RH-MLLW | Debris | 1 | 2010 | 2010 |
| RH-MLLW | RH-MLLW | Debris | 2 | 2011 | 2016 |
| RH-MLLW | RH-MLLW | Debris | 2 | 2016 | 2021 |
| RH-MLLW | RH-MLLW | Debris | 2 | 2021 | 2025 |
| RH-MLLW | RH-MLLW | Debris | 2 | 2026 | 2030 |
| RH-MLLW | RH-MLLW | Debris | 1 | 2030 | 2035 |

Table D–80. Offsite Waste Projection Characteristics by U.S. Department of Energy Site (continued)

| DOE Site and Waste Category | Waste Category ^a | Final Waste Form | Waste Form Volume (cubic meters) | Year of Shipment | |
|-----------------------------|-----------------------------|------------------|----------------------------------|------------------|------|
| | | | | Start | End |
| Idaho – MLLW | MLLW-D&D | Debris | 6,330 | 2010 | 2035 |
| Savannah River Site – MLLW | MLLW-D&D | Debris | 6,330 | 2010 | 2035 |
| Oak Ridge – MLLW | MLLW-D&D | Debris | 6,330 | 2010 | 2035 |
| Total MLLW | | | 20,000 | | |

^a Per Hanford Site Solid Waste Acceptance Criteria, Rev. 12 (Fluor Hanford 2005b).

Note: To convert cubic meters to cubic yards, multiply by 1.308.

Key: BNL=Brookhaven National Laboratory; D&D=decontamination and decommissioning; DOE=U.S. Department of Energy; LLW=low-level radioactive waste; MLLW=mixed low-level radioactive waste; RH=remote-handled; WV=West Valley.

Source: SAIC 2006b.

Table D–81. Summary of Offsite Radioactive Constituents of Potential Concern Inventories by U.S. Department of Energy Site

| Radionuclide Inventory (Curies) | | | | | | | | | |
|---------------------------------------|----------------------------|----------------------------|----------------------------|----------------------------|-------------------------------|-----------------------------|----------------------------|----------------------------|----------------------------|
| DOE Site and Waste Category | Iodine-129 | Cesium-137 | Carbon-14 | Hydrogen-3 (Tritium) | Uranium-233, -234, -235, -238 | Neptunium--237 | Plutonium-239, -240 | Strontium-90 | Technetium-99 |
| West Valley – LLW | 3.04×10 ⁻² | 3.71×10 ⁵ | 2.90×10 ¹ | 3.42×10 ⁴ | 1.07×10 ¹ | 1.22×10 ⁻² | 1.09×10 ¹ | 4.28×10 ⁵ | 2.99 |
| Idaho National Laboratory – RH-LLW | 2.20 | 2.20×10 ³ | 8.80×10 ² | 5.50×10 ² | NR | NR | 7.40 | 8.25×10 ² | 5.72×10 ¹ |
| Brookhaven National Laboratory – LLW | NR | 9.20×10 ³ | NR | 2.44×10 ⁻⁴ | NR | NR | 2.44×10 ⁻⁴ | 4.04 | NR |
| Oak Ridge National Laboratory – LLW | 1.85×10 ⁻³ | 2.26×10 ⁴ | 1.77 | 2.08×10 ³ | 6.48×10 ⁻¹ | 7.45×10 ⁻⁴ | 6.64×10 ⁻¹ | 2.61×10 ⁴ | 1.82×10 ⁻¹ |
| Argonne National Laboratory – LLW | 2.53×10 ⁻⁴ | 3.09×10 ³ | 2.42×10 ⁻¹ | 2.85×10 ² | 8.88×10 ⁻² | 1.02×10 ⁻⁴ | 9.10×10 ⁻² | 3.57×10 ³ | 2.49×10 ⁻² |
| Naval Reactors – LLW | NR | 3.85×10 ¹ | 1.46 | 3.26 | 4.30×10 ⁻⁴ | NR | 5.06×10 ⁻² | 2.06×10 ¹ | 1.16 |
| Paducah – LLW | NR | NR | NR | NR | 2.03 | 1.79×10 ⁻² | 2.31×10 ⁻² | NR | 6.95×10 ² |
| Portsmouth – LLW | NR | NR | NR | NR | 2.03 | 1.79×10 ⁻² | 2.31×10 ⁻² | NR | 6.95×10 ² |
| Idaho – RH-LLW | 1.30×10 ¹ | 1.30×10 ⁴ | 5.20×10 ³ | 3.25×10 ³ | NR | NR | 4.37×10 ¹ | 4.88×10 ³ | 3.38×10 ² |
| Oak Ridge – LLW | 1.64×10 ⁻² | 2.01×10 ⁵ | 1.57×10 ¹ | 1.85×10 ⁴ | 5.77 | 6.63×10 ⁻³ | 5.92 | 2.32×10 ⁵ | 1.62 |
| Total LLW | 1.52×10¹ | 6.22×10⁵ | 6.13×10³ | 5.89×10⁴ | 2.12×10¹ | 5.55×10⁻² | 6.88×10¹ | 6.96×10⁵ | 1.79×10³ |
| West Valley – MLLW | NR | NR | NR | NR | 7.93×10 ⁻¹ | NR | 1.14×10 ¹ | NR | NR |
| Los Alamos National Laboratory – MLLW | NR | 1.28×10 ⁻² | NR | NR | 1.54×10 ⁻¹ | 1.28×10 ⁻² | 1.28 | 1.28×10 ⁻² | NR |
| Savannah River Site – RH-MLLW | NR | NR | NR | NR | NR | 2.05×10 ⁻⁵ | 1.16×10 ¹ | NR | NR |
| Idaho – RH-MLLW | 1.60×10 ⁻² | 1.60×10 ⁴ | 4.80×10 ⁻² | 8.00×10 ¹ | 1.13 | 8.64×10 ⁻¹ | 1.90×10 ¹ | 1.60×10 ⁴ | 3.04 |

| Radionuclide Inventory (Curies) | | | | | | | | | |
|--|-----------------------|--------------------|-----------------------|-----------------------------|--------------------------------------|-----------------------|----------------------------|---------------------|----------------------|
| DOE Site and Waste Category | Iodine-129 | Cesium-137 | Carbon-14 | Hydrogen-3 (Tritium) | Uranium-233, -234, -235, -238 | Neptunium--237 | Plutonium-239, -240 | Strontium-90 | Technetium-99 |
| Idaho – MLLW | NR | NR | NR | NR | 1.00×10^1 | NR | 1.44×10^2 | NR | NR |
| Savannah River Site – MLLW | NR | NR | NR | NR | 1.00×10^1 | NR | 1.44×10^2 | NR | NR |
| Oak Ridge – MLLW | NR | NR | NR | NR | 1.00×10^1 | NR | 1.44×10^2 | NR | NR |
| Total MLLW | 1.60×10^{-2} | 1.60×10^4 | 4.80×10^{-2} | 8.00×10^1 | 3.22×10^1 | 8.77×10^{-1} | 4.76×10^2 | 1.60×10^4 | 3.04 |
| Total LLW and MLLW | 1.53×10^1 | 6.38×10^5 | 6.13×10^3 | 5.90×10^4 | 5.34×10^1 | 9.32×10^{-1} | 5.45×10^2 | 7.12×10^5 | 1.80×10^3 |

Key: DOE=U.S. Department of Energy; LLW=low-level radioactive waste; MLLW=mixed low-level radioactive waste; NR=not reported; RH=remote-handled.

Source: SAIC 2006b.

Table D-82. Summary of Offsite Chemical Constituents of Potential Concern Inventories by U.S. Department of Energy Site

| DOE Site and Waste Category | Arsenic (As) | Boron (B) | Cadmium (Cd) | Chromium (Cr) | Fluorine (F) | Lead (Pb) | Manganese (Mn) | Mercury (Hg) | Molybdenum (Mo) | Nickel (Ni) | Nitrate (NO ₃) | PCBs | Silver (Ag) | Strontium (Sr) | Total Uranium (U) |
|---------------------------------------|-----------------------|-----------|-----------------------------|----------------------------|--------------|-----------------------|----------------|-----------------------|-----------------|-----------------------|----------------------------|-----------|-----------------------------|----------------|-------------------|
| | | | | | | | | | | | | | | | |
| West Valley - LLW | NR | NR | NR | NR | NR | NR | NR | NR | NR | NR | NR | NR | NR | NR | NR |
| Idaho National Laboratory RH-LLW | 5.06×10 ⁻¹ | NR | 3.30×10 ⁻³ | 2.24 | NR | NR | NR | NR | NR | NR | NR | NR | 6.93×10 ⁻³ | NR | NR |
| Brookhaven National Laboratory - LLW | NR | NR | NR | NR | NR | NR | NR | NR | NR | NR | NR | NR | NR | NR | NR |
| Oak Ridge National Laboratory - LLW | NR | NR | NR | NR | NR | NR | NR | NR | NR | NR | NR | NR | NR | NR | NR |
| Argonne National Laboratory - LLW | NR | NR | NR | NR | NR | NR | NR | NR | NR | NR | NR | NR | NR | NR | NR |
| Naval Reactors - LLW | NR | NR | NR | NR | NR | NR | NR | NR | NR | NR | NR | NR | NR | NR | NR |
| Paducah - LLW | 3.77×10 ⁻³ | NR | 5.95×10 ⁻² | 2.15 | NR | 5.26×10 ⁻¹ | NR | NR | NR | NR | NR | NR | 3.77×10 ⁻³ | NR | NR |
| Portsmouth - LLW | 3.77×10 ⁻³ | NR | 5.95×10 ⁻² | 2.15 | NR | 5.26×10 ⁻¹ | NR | NR | NR | NR | NR | NR | 3.77×10 ⁻³ | NR | NR |
| Idaho - RH-LLW | 2.99 | NR | 1.95×10 ⁻² | 1.33×10 ¹ | NR | NR | NR | NR | NR | NR | NR | NR | 4.10×10 ⁻² | NR | NR |
| Oak Ridge - LLW | NR | NR | NR | NR | NR | NR | NR | NR | NR | NR | NR | NR | NR | NR | NR |
| Total LLW | 3.50 | NR | 1.42×10⁻¹ | 1.98×10¹ | NR | 1.05 | NR | NR | NR | NR | NR | NR | 5.54×10⁻² | NR | NR |
| West Valley - MLLW | 4.67×10 ⁻² | NR | 4.34×10 ⁻² | 1.68×10 ⁻² | NR | 1.49×10 ⁻² | NR | 8.70×10 ⁻³ | NR | 7.75×10 ⁻¹ | NR | NR | 5.15×10 ⁻² | NR | NR |
| Los Alamos National Laboratory - MLLW | 2.19 | NR | 3.13 | 6.43×10 ¹ | NR | 1.34×10 ² | NR | 8.04 | NR | NR | NR | NR | 1.83×10 ¹ | NR | NR |
| Savannah River Site - RH-MLLW | 9.34×10 ⁻³ | NR | 8.68×10 ⁻³ | 3.35×10 ⁻³ | NR | 2.97×10 ⁻³ | NR | 1.74×10 ⁻³ | NR | 1.55×10 ⁻¹ | NR | NR | 1.03×10 ⁻² | NR | NR |

Table D-82. Summary of Offsite Chemical Constituents of Potential Concern Inventories by U.S. Department of Energy Site (continued)

| DOE Site and Waste Category | Arsenic (As) | Boron (B) | Cadmium (Cd) | Chromium (Cr) | Fluorine (F) | Lead (Pb) | Manganese (Mn) | Mercury (Hg) | Molybdenum (Mo) | Nickel (Ni) | Nitrate (NO ₃) | PCBs | Silver (Ag) | Strontium (Sr) | Total Uranium (U) |
|--------------------------------|-----------------------|-----------|----------------------------|----------------------------|--------------|----------------------------|----------------|----------------------------|-----------------|----------------------------|----------------------------|-----------|----------------------------|----------------|-------------------|
| Chemical Inventory (kilograms) | | | | | | | | | | | | | | | |
| Idaho – RH-MLLW | 5.50×10 ⁻¹ | NR | 1.26×10 ² | 9.00 | NR | 4.41 | NR | 2.08×10 ¹ | NR | NR | NR | NR | 2.70 | NR | NR |
| Idaho – MLLW | 5.91×10 ⁻¹ | NR | 5.49×10 ¹ | 2.12×10 ⁻¹ | NR | 1.88×10 ⁻¹ | NR | 1.10×10 ⁻¹ | NR | 9.81 | NR | NR | 6.52×10 ⁻¹ | NR | NR |
| Savannah River Site – MLLW | 5.91×10 ⁻¹ | NR | 5.49×10 ¹ | 2.12×10 ⁻¹ | NR | 1.88×10 ⁻¹ | NR | 1.10×10 ⁻¹ | NR | 9.81 | NR | NR | 6.52×10 ⁻¹ | NR | NR |
| Oak Ridge – MLLW | 5.91×10 ⁻¹ | NR | 5.49×10 ¹ | 2.12×10 ⁻¹ | NR | 1.88×10 ⁻¹ | NR | 1.10×10 ⁻¹ | NR | 9.81 | NR | NR | 6.52×10 ⁻¹ | NR | NR |
| Total MLLW | 4.57 | NR | 1.31×10² | 7.39×10¹ | NR | 1.39×10² | NR | 2.91×10¹ | NR | 3.04×10¹ | NR | NR | 2.30×10¹ | NR | NR |
| Totals LLW and MLLW | 8.08 | NR | 1.31×10² | 9.37×10¹ | NR | 1.40×10² | NR | 2.91×10¹ | NR | 3.04×10¹ | NR | NR | 2.31×10¹ | NR | NR |

Note: To convert kilograms to pounds, multiply by 2.2046.

Key: DOE=U.S. Department of Energy; LLW=low-level radioactive waste; MLLW=mixed low-level radioactive waste; NR=not reported; PCBs=polychlorinated biphenyls; RH=remote-handled.

Source: SAIC 2006b.

D.4 REFERENCES

Agnew, S.F., J. Boyer, R.A. Corbin, T.B. Duran, J.R. FitzPatrick, K.A. Jurgensen, T.P. Ortiz, and B.L. Young, 1997, *Hanford Tank Chemical and Radionuclide Inventories: HDW Model Rev. 4*, LA-UR-96-3860, Los Alamos National Laboratory, Chemical Science and Technology Division, Los Alamos, New Mexico, January.

Barcot, R.A., 2005, *Solid Waste Integrated Forecast Technical (SWIFT) Report, FY2006–FY2035, 2006.0, Volume 1*, HNF-EP-0918, Rev. 16, Fluor Hanford, Inc., Richland, Washington, December.

Barnett, D.B., G.W. Gee, M.D. Sweeney, M.D. Johnson, V.F. Medina, D.P. Mendoza, B.G. Fritz et al., 2003, *Results of Performance Evaluation of Electrical Leak-Detection Methods at the Hanford Site Mock Tank – FY 2002–2003*, PNNL-14192, Pacific Northwest National Laboratory, Richland, Washington, February.

BNI (Bechtel National, Inc.), 2002, *Revised Severity Level Calculations for the LAW Facility*, 24590-LAW-Z0C-W14T-00003, Rev. B, Richland, Washington, January 26.

CEES (Columbia Energy & Environmental Services, Inc.), 2006, *FFTF Radioactive and Hazardous Materials Inventory*, 6734-FFTF-Inventory-002, Rev. 1, Richland, Washington, July.

CEES (Columbia Energy & Environmental Services, Inc.), 2007a, *Revision of PCAL 17284-2 Mass Balance, WT-ST-056*, WT-ST-056, Rev. 2, Richland, Washington, March.

CEES (Columbia Energy & Environmental Services, Inc.), 2007b, *Curie Distribution for Alternatives 1, 2A, 2B, 3A, 3B, 3C, 4, 5, 6A, 6B and 6C*, WT-ST-042, WT-ST-042, Rev. 8, Richland, Washington, July 24.

Chapin, D.H., 2007, U.S. Department of Energy, Richland Operations Office, Richland, Washington, personal communication (email to C.L. Johnson, Science Applications International Corporation, Germantown, Maryland, “DOE-RL/FFTF Project Response to SAIC (Charlotte Johnson) Re: Status of FFTF Deactivation,” Attachment, “Status of FFTF Project Deactivation (June 2007),” June 6.

CH2M HILL (CH2M HILL Hanford Group, Inc.), 2002, *Field Investigation Report for Waste Management Area S-SX*, RPP-7884, Rev. 0, Richland, Washington, January 31.

CH2M HILL (CH2M HILL Hanford Group, Inc.), 2008, *Quarterly Comparison of Best-Basis Global Inventories*, Emerging Data Form No. 303, Richland, Washington, August 12.

Corbin, R.A., B.C. Simpson, M.J. Anderson, W.F. Danielson, III, J.G. Field, T.E. Jones, and C.T. Kincaid, 2005, *Hanford Soil Inventory Model, Rev. 1*, RPP-26744, Rev. 0, CH2M HILL Hanford Group, Inc., Richland, Washington, September.

Croff, A.G., 1980, *ORIGEN2—A Revised and Updated Version of the Oak Ridge Isotope Generation and Depletion Code*, ORNL-5621, Oak Ridge National Laboratory, Oak Ridge, Tennessee, July.

DOE (U.S. Department of Energy), 1995, *Environmental Assessment, Shutdown of the Fast Flux Test Facility, Hanford Site, Richland, Washington*, DOE/EA-0993, Richland Operations Office, Richland, Washington, May.

DOE (U.S. Department of Energy), 1997, *Final Waste Management Programmatic Environmental Impact Statement for Managing Treatment, Storage, and Disposal of Radioactive and Hazardous Waste*, DOE/EIS-0200-F, Office of Environmental Management, Washington, D.C., May.

DOE (U.S. Department of Energy), 2003a, *Environmental Impact Statement for Retrieval, Treatment, and Disposal of Tank Waste and Closure of Single-Shell Tanks at the Hanford Site, Richland, WA: Inventory and Source Term Data Package*, DOE/ORP-2003-02, Rev. 0, Office of River Protection, Richland, Washington, April 17.

DOE (U.S. Department of Energy), 2003b, *Environmental Impact Statement for Retrieval, Treatment, and Disposal of Tank Waste and Closure of Single-Shell Tanks at the Hanford Site, Richland, WA: Waste Retrieval and Storage Data Package*, DOE/ORP-2003-06, Rev. 0, Office of River Protection, Richland, Washington, April 17.

DOE (U.S. Department of Energy), 2005, *Technical Guidance Document for Tank Closure Environmental Impact Statement, Vadose Zone and Groundwater Revised Analyses*, Final Rev. 0, Office of River Protection, Richland, Washington, March 25.

DOE (U.S. Department of Energy), 2006a, *Environmental Assessment, Sodium Residuals Reaction/Removal and Other Deactivation Work Activities, Fast Flux Test Facility (FFTF) Project, Hanford Site, Richland, Washington*, DOE/EA-1547F, Richland Operations Office, Richland, Washington, March.

DOE (U.S. Department of Energy), 2006b, *Analysis of Offsite-Generated Waste Projections, "Tank Closure and Waste Management Environmental Impact Statement for the Hanford Site,"* Office of Environmental Management, Office of Disposal Operations, July 13.

DOE and Ecology (U.S. Department of Energy, Richland Operations Office, Richland, Washington, and Washington State Department of Ecology, Olympia, Washington), 1996, *Tank Waste Remediation System, Hanford Site, Richland, Washington, Final Environmental Impact Statement*, DOE/EIS-0189, August.

DOE and NYSERDA (U.S. Department of Energy and New York State Energy Research and Development Authority), 2008, *Revised Draft Environmental Impact Statement for Decommissioning and/or Long-Term Stewardship at the West Valley Demonstration Project and Western New York Nuclear Service Center*, DOE/EIS-0226-D (Revised), West Valley, New York, November.

Ecology, EPA, and DOE (Washington State Department of Ecology, Olympia, Washington; U.S. Environmental Protection Agency, Washington, D.C.; and U.S. Department of Energy, Richland, Washington), 1989, Hanford Federal Facility Agreement and Consent Order, 89-10, as amended, accessed through <http://www.hanford.gov/tpa/tpahome.htm>, May 15.

Field, J.G., and K.M. Bowen, 2003, *Best-Basis Inventory Process Requirements*, RPP-7625, Rev. 4, CH2M HILL Hanford Group, Inc., Richland, Washington, October.

Fluor Hanford (Fluor Hanford, Inc.), 2005a, *Technical Information Document for the Fast Flux Test Facility Closure Project Environmental Impact Statement*, FFTF-18346, Rev. 1, Richland, Washington, April.

Fluor Hanford (Fluor Hanford, Inc.), 2005b, *Hanford Site Solid Waste Acceptance Criteria*, HNF-EP-0063 Rev. 12, Richland, Washington, July 6.

Hanlon, B.M., 2003, *Waste Tank Summary Report for Month Ending December 31, 2002*, HNF-EP-0182, Rev. 177, CH2M HILL Hanford Group, Inc., Richland, Washington, February.

Hanson, C.E., 2003, *Tank S-112 Saltcake Waste Retrieval Demonstration Project Leak Detection, Monitoring, and Mitigation Strategy*, RPP-10413, Rev. 0, CH2M HILL Hanford Group, Inc., Richland, Washington, February.

Hedges, J.A., 2008, Washington State Department of Ecology, Richland, Washington, personal communication (letter) to S.J. Olinger, U.S. Department of Energy, Office of River Protection, Richland, Washington, D.A. Brockman, U.S. Department of Energy, Richland Operations Office, Richland, Washington, and W.S. Elkins, Bechtel National, Inc., Richland, Washington, "Draft Waste Treatment and Immobilization Plant (WTP) Dangerous Waste Permit," October 15.

Jones, T.E., B.C. Simpson, M.I. Wood, and R.A. Corbin, 2000, *Preliminary Inventory Estimates for Single-Shell Tank Leaks in T, TX, and TY Tank Farms*, RPP-7218, Rev. 0, CH2M HILL Hanford Group, Inc., Richland, Washington, November.

Jones, T.E., B.C. Simpson, M.I. Wood, and R.A. Corbin, 2001, *Preliminary Inventory Estimates for Single-Shell Tank Leaks in B, BX, and BY Tank Farms*, RPP-7389, Rev. 0, CH2M HILL Hanford Group, Inc., Richland, Washington, February.

Kidd, C.C., 2005, *Activation of the FFTF Biological Shield Wall*, FFTF-26790, Rev. 0, Fluor Hanford, Inc., Richland, Washington, October.

Kirkbride, R.A., G.K. Allen, B.A. Higley, T.M. Hohl, S.L. Lambert, R.M. Orme, D.E. Place et al., 2002, *Tank Farm Contractor Operation and Utilization Plan*, Vol. I, HNF-SD-WM-SP-012, Rev. 4, U.S. Department of Energy, Office of River Protection, Richland, Washington, September.

Mahoney, L.A., Z.I. Antoniak, J.M. Bates, and M.E. Dahl, 1999, *Retained Gas Sampling Results for the Flammable Gas Program*, PNNL-13000, Rev. 0, Pacific Northwest National Laboratory, Richland, Washington, November.

Myers, D.A., 2005, *Field Investigation Report for Waste Management Areas T and TX-TY*, RPP-23752, Rev. 0, CH2M HILL Hanford Group, Inc., Richland, Washington, June.

SAIC (Science Applications International Corporation), 2006a, *Retrieval Leaks (Radiological Inventory-Sept 28-2006)/Retrieval*, Germantown, Maryland, September 28.

SAIC (Science Applications International Corporation), 2006b, *Inventory Data for Hanford Offsite Waste Projections – "TC & WM EIS": LLW/MLLW Offsite Waste Projections for Hanford*, Rev. 1, Germantown, Maryland, July 7.

SAIC (Science Applications International Corporation), 2007a, *Tank Residuals, Chemical Inventory, Tank Residuals-Chemical Inventory-Sept-2007 (in kg).xls*, Germantown, Maryland, September.

SAIC (Science Applications International Corporation), 2007b, *Organic Chemical Mass Balance, Organic Chem TC Mass Balance calculations-Oct-2007.xls*, Germantown, Maryland, October.

SAIC (Science Applications International Corporation), 2007c, *Ancillary Equipment Inventories ANCeq_JUNE-07.XLS*, Germantown, Maryland, June.

SAIC (Science Applications International Corporation), 2007d, *Tank Residuals, Radiological Inventory, Tank Residuals (Radiological Inventory-Sept28-2006).xls*, Germantown, Maryland, September.

SAIC (Science Applications International Corporation), 2007e, *Alternative Cribs and Trenches_June-07.xls*, Germantown, Maryland, June.

SAIC (Science Applications International Corporation), 2007f, *Chemical Retrieval Leaks-Aug-2007.xls*, Germantown, Maryland, August.

SAIC (Science Applications International Corporation), 2007g, *Tank Closure Alternatives, Scaled Data Sets to Support the “Tank Closure and Waste Management Environmental Impact Statement for the Hanford Site, Richland, Washington,”* Germantown, Maryland, July 12.

SAIC (Science Applications International Corporation), 2007h, *Mass Balance Radiological Inventory Tables*, Germantown, Maryland, November.

SAIC (Science Applications International Corporation), 2007i, *Mass Balance Chemical Inventory Tables*, Germantown, Maryland, November.

SAIC (Science Applications International Corporation), 2007j, *Rubble, Soil and Equipment Radiological Inventories*, Rubble Soil and Equipment Rad Inventory-June 2007.xls, Germantown, Maryland, June.

SAIC (Science Applications International Corporation), 2007k, *Rubble, Soil and Equipment Chemical Inventories*, Rubble Soil & Equipment Chem Inventory-Sept-2007.xls, Germantown, Maryland, September.

SAIC (Science Applications International Corporation), 2007l, *Tank Closure Curie Pies* December 31, 2007.xls, Germantown, Maryland, December.

SAIC (Science Applications International Corporation), 2007m, *Fast Flux Test Facility Alternatives, Scaled Data Sets to Support the “Tank Closure and Waste Management Environmental Impact Statement for the Hanford Site, Richland, Washington,”* Germantown, Maryland, July 12.

SAIC (Science Applications International Corporation), 2007n, *Waste Management Alternatives, Scaled Data Sets to Support the “Tank Closure and Waste Management Environmental Impact Statement for the Hanford Site, Richland, Washington,”* Germantown, Maryland, July 12.

SAIC (Science Applications International Corporation), 2008a, *Revised Scaled Data Sets to Support the “Tank Closure and Waste Management Environmental Impact Statement for the Hanford Site, Richland, Washington,”* Germantown, Maryland, October 9.

SAIC (Science Applications International Corporation), 2008b, *Onsite-Generated, Non-CERCLA, Non-Tank Activity Waste Radiological and Chemical COPC Inventory 10232008.xls*, Germantown, Maryland, October.

Simpson, B.C., R.A. Corbin, and S.F. Agnew, 2001, *Groundwater/Vadose Zone Integration Project: Hanford Soil Inventory Model*, BHI-01496, Rev. 0, Bechtel Hanford, Inc., Richland, Washington, March.

Simpson, B.C., C. DeFigh-Price, and D.L. Banning, 1999, *Technical Basis for the Determination That Current Characterization Data and Processes Are Sufficient to Ensure Safe Storage and to Design Waste Disposal Facilities*, HNF-4232, Rev. 0, Lockheed Martin Hanford Corp., Richland, Washington, June.

Whyatt, G.A., J.W. Shade, and G.E. Stegen, 1996, *Volatility and Entrainment of Feed Components and Product Glass Characteristics during Pilot-Scale Vitrification of Simulated Hanford Site Low-Level Waste*, WHC-SA-3093-FP, Westinghouse Hanford Company, Richland, Washington, April.

Wood, M.I., and T.E. Jones, 2003, *Subsurface Conditions Description of the U Waste Management Area*, RPP-15808, Rev. 0, CH2M HILL Hanford Group, Inc., Richland, Washington, April.

Wood, M.I., T.E. Jones, B.N. Bjornstad, D.G. Horton, S.M. Narbutovskih, and R. Schalla, 2003, *Subsurface Conditions Description of the C and A-AX Waste Management Area*, RPP-14430, Rev. 0, CH2M HILL Hanford Group, Inc., Richland, Washington, April.

York, M.T., 2005, Fluor Hanford, Inc., Richland, Washington, personal communication (email) to T.W. Ferns, U.S. Department of Energy, Richland Operations Office, Richland, Washington, "Special Components," March 16.

Zamecnik, J.R., and C.L. Crawford, 2003, *Offgas Emissions from the Vitrification of Hanford Envelope C Low Activity Waste*, WSRC-MS-2003-00072, Rev. 0, Westinghouse Savannah River Company, LLC, Aiken, South Carolina, January 14.

Federal Register

65 FR 10061, U.S. Department of Energy, 2000, "Record of Decision for the Department of Energy's Waste Management Program: Treatment and Disposal of Low-Level Waste and Mixed Low-Level Waste; Amendment of the Record of Decision for the Nevada Test Site," February 25.

69 FR 39449, U.S. Department of Energy, 2004, "Record of Decision for the *Solid Waste Program, Hanford Site, Richland, WA: Storage and Treatment of Low-Level Waste and Mixed Low-Level Waste; Disposal of Low-Level Waste and Mixed Low-Level Waste, and Storage, Processing, and Certification of Transuranic Waste for Shipment to the Waste Isolation Pilot Plant,*" June 30.

APPENDIX E

DESCRIPTIONS OF FACILITIES, OPERATIONS, AND TECHNOLOGIES

Appendix E provides additional information about the technologies, processes, and facilities for the three key activities of this *Tank Closure and Waste Management Environmental Impact Statement for the Hanford Site, Richland, Washington*: tank closure, Fast Flux Test Facility decommissioning, and waste management. Section E.1 includes this information for tank closure, Section E.2 includes this information for Fast Flux Test Facility decommissioning, and Section E.3 includes this information for waste management.

E.1 TANK CLOSURE

This section provides additional information about the technologies, processes, and facilities that would be used under the proposed alternatives for closure of the Hanford Site (Hanford) single-shell tank (SST) system, as described in Chapter 2 of this **Tank Closure and Waste Management Environmental Impact Statement for the Hanford Site, Richland, Washington (TC & WM EIS)**. Information provided in this appendix forms the basis for determining the environmental impacts of each alternative, as described in Chapter 4.

Each alternative relies on a combination of technologies, processes, and facilities that could accomplish the desired outcome for that alternative. Distribution of the radioactive and chemical constituents of the tank waste among the various waste form storage and management options depends on which technologies and processes the alternative includes. Appendix D provides information on the basis for the chemical and radionuclide composition in the tanks, as well as equipment, soils, and waste forms. These data, along with information concerning which technologies and processes would be used under a particular alternative, formed the basis for modeling transport of contaminants in air, water, and soil media.

Sections E.1.1 and E.1.2 provide detailed descriptions of the technologies, processes, and facilities utilized in one or more of the alternatives described in Chapter 2. A matrix showing the technologies and processes that were assumed to be implemented for each alternative is provided. In many cases, those technologies were selected to provide bounding environmental consequences and do not necessarily represent the exact technologies or processes that could be implemented to achieve the desired outcome. Furthermore, this **TC & WM EIS** does not attempt to analyze all possible permutations of the alternatives using available technologies and processes, but instead attempts to group activities logically into reasonable alternatives for analysis. The technologies, processes, and facilities analyzed in detail in this environmental impact statement (EIS) have sufficient performance data to make conservative assumptions regarding construction, operations, and decommissioning impacts. However, comprehensive and specific engineering designs may still need to be developed once a series of technologies is selected for implementation.

Section E.1.3 discusses technology options that were initially considered, but were not analyzed in detail, as well as the rationale for selecting the technologies that were analyzed. The former are technologies that, due to their lack of maturity, cannot be analyzed in detail at this time using reasonable and conservative engineering estimates regarding construction, operations, and decommissioning impacts. Should continued research and development (R&D) indicate additional benefits over the technologies analyzed in detail, these maturing technologies can then be analyzed in further detail and incorporated into the tank closure program.

E.1.1 Current River Protection Project

This section describes the current River Protection Project's (RPP's) activities for storage, retrieval, treatment, and disposal of waste in the Hanford tanks. The current program is based primarily on

implementing Phase I of the Preferred Alternative as identified in the **Tank Waste Remediation System, Hanford Site, Richland, Washington, Final Environmental Impact Statement (TWRS EIS)** (DOE and Ecology 1996). Phase I was initiated to treat approximately 10 percent by volume of the tank waste, which contains 25 percent of the total radioactivity in the waste, by the year 2018. Without providing additional waste treatment capacity, it would be possible to continue waste treatment at the same rate as in Phase I until the major facilities reach the end of their design lives. However, such an action would not achieve the objective of treating all of the waste; thus, it was not considered a reasonable alternative for this **TC & WM EIS**. The alternatives evaluated in this **TC & WM EIS** involve various activities in addition to the current program (with the exception of the No Action Alternative) to complete treatment of the tank waste and provide for final disposition of the SSTs. Those activities are described in Section E.1.2.

The current RPP activities can be divided into three main areas: (1) routine tank farm operations (operations and maintenance of the tank farm system), (2) tank system upgrades, and (3) planned Waste Treatment Plant (WTP) operations (WTP construction and operations).

E.1.1.1 Routine Tank Farm Operations

Routine tank farm operations include waste retrieval and transfer operations, evaporation, SST system closure activities, double-shell tank (DST) integrity assessments, and tank farm system maintenance and life extension activities. Also included in routine tank system operations are the ongoing monitoring activities necessary to ensure compliance with nuclear safety Authorization Basis (AB)¹ requirements and environmental, occupational safety and health, and other applicable regulatory requirements. Administrative and technical support required to accomplish this work is also included.

E.1.1.1.1 Tank Farm Facilities

The primary components of the tank farm system are the 177 SSTs and DSTs located in the 200-East and 200-West Areas of Hanford. The tanks are grouped in tank farms with common support equipment such as primary tank ventilation systems; shielded concrete pits for pumps, valves, and jumpers; buildings for monitoring and control instrumentation; and change houses for operators, maintenance personnel, and radiological control technicians.

E.1.1.1.1.1 Single-Shell Tanks

The SSTs were built from 1943 to 1964 to hold the liquid radioactive waste created by the production and separation of plutonium. The number and capacities of the SSTs are as follows:

- 16 of 208,000-liter (55,000-gallon) capacity
- 60 of 2.0-million-liter (530,000-gallon) capacity
- 48 of 2.9-million-liter (758,000-gallon) capacity
- 25 of 3.8-million-liter (1-million-gallon) capacity

The total nominal holding capacity of the SSTs is approximately 356 million liters (94 million gallons) (DOE 2003a). The tanks currently contain approximately 120 million liters (32 million gallons) of radioactive and hazardous waste. These tanks contain salt cake and sludge; most of their free liquids were evaporated or transferred to the newer DSTs to reduce the chance of leaks. Table E-1 shows the distribution of the SSTs among the tank farms.

¹ The nuclear safety AB, often referred to as the “Authorization Basis,” or “AB,” consists of a set of operating limits that define the envelope of safe operations for U.S. Department of Energy nuclear facilities. The AB is established through rigorous analysis of possible accident scenarios and impacts on the public, workers, and facilities. Changes to the design or operation of the facility must be evaluated against the AB to ensure that safe conditions are maintained as a result of the change.

Table E–1. Distribution of Single-Shell Tanks Among Tank Farms

| Tank Farm | Number of Tanks | Tank Capacity (liters) | Location | Years Constructed |
|-----------|-----------------|------------------------|---------------|-------------------|
| A | 6 | 3.8×10^6 | 200-East Area | 1954–55 |
| AX | 4 | 3.8×10^6 | | 1963–64 |
| B | 12 | 2.0×10^6 | | 1943–44 |
| | 4 | 2.1×10^5 | | 1943–44 |
| BX | 12 | 2.0×10^6 | | 1946–47 |
| BY | 12 | 2.9×10^6 | | 1948–49 |
| C | 12 | 2.0×10^6 | | 1943–44 |
| | 4 | 2.1×10^5 | | 1943–44 |
| S | 12 | 2.9×10^6 | 200-West Area | 1950–51 |
| SX | 15 | 3.8×10^6 | | 1953–54 |
| T | 12 | 2.0×10^6 | | 1943–44 |
| | 4 | 2.1×10^5 | | 1943–44 |
| TX | 18 | 2.9×10^6 | | 1947–48 |
| TY | 6 | 2.9×10^6 | | 1951–52 |
| U | 12 | 2.0×10^6 | | 1943–44 |
| | 4 | 2.1×10^5 | | 1943–44 |

Note: To convert liters to gallons, multiply by 0.26417.

E.1.1.1.1.2 Double-Shell Tanks

The DSTs were built from 1968 to 1986 to support fuel reprocessing, isotope recovery, and tank waste management operations. The numbers and nominal capacities of the DSTs are as follows:

- 4 of approximately 3.8-million-liter (1-million-gallon) capacity
- 24 of approximately 4.4-million-liter (1.16-million-gallon) capacity

The DSTs have a total nominal holding capacity of approximately 117 million liters (31 million gallons). They contain approximately 85 million liters (22.5 million gallons) of radioactive and hazardous waste (DOE 2003a). Generally, the tanks contain liquids and settled salts. Some tanks also contain a bottom layer of sludge. Distribution of the DSTs among the tank farms is shown in Table E–2.

Table E–2. Distribution of Double-Shell Tanks Among Tank Farms

| Tank Farm | Number of Tanks | Tank Capacity (liters) | Location | Years Constructed |
|-----------|-----------------|------------------------|---------------|-------------------|
| AY | 2 | 3.8×10^6 | 200-East Area | 1968–70 |
| AZ | 2 | 3.8×10^6 | | 1971–77 |
| AW | 6 | 4.4×10^6 | | 1978–80 |
| AN | 7 | 4.4×10^6 | | 1980–82 |
| AP | 8 | 4.4×10^6 | | 1983–86 |
| SY | 3 | 4.4×10^6 | 200-West Area | 1973–76 |

Note: To convert liters to gallons, multiply by 0.26417.

E.1.1.1.2 Operations and Maintenance

Waste retrieval and transfer operations are conducted to support staging and preparation of waste for eventual delivery to the WTP. Activities include planning the sequence for transferring waste currently stored in the DSTs to the WTP and retrieving and transferring waste from the SSTs to the DST system for eventual treatment. Transfer operations involve determining the compatibility of the wastes to be

transferred, establishing pipeline transfer routes, monitoring the waste volumes in the sending and the receiving tanks, flushing the lines when the transfers are complete, and documenting the entire process.

DST integrity assessments involve nondestructive examination (NDE) of the DST systems to assess fitness for storing waste. Chemical adjustments of the tank contents are conducted as required to meet corrosion control specifications. Periodic assessment reports are required under the Hanford Federal Facility Agreement and Consent Order (also known as the Tri-Party Agreement [TPA]) (Ecology, EPA, and DOE 1989) Milestone Series M-48.

Tank farm maintenance and life extension activities involve any physical maintenance required to ensure continued operation of the tanks and associated systems as designed. Upgrades to extend the useful life of various tank farm systems and facilities have been identified. One important facility is the 242-A Evaporator, which would be needed for volume reduction of the waste to be stored in the DSTs. The 242-A Evaporator is described in Section E.1.2.3.2. DST space is limited, and volume reduction by evaporating excess water has been used extensively at Hanford to avoid the need for new storage tanks. Upgrades to the 222-S Laboratory also are needed to characterize waste for safe storage and treatment but are not analyzed in this EIS.

E.1.1.1.2.1 Waste Retrieval and Transfer Operations

The primary objectives of waste retrieval and transfer operations are to retrieve waste from the SSTs and deliver waste feed to the WTP for treatment. Current tank space within the DSTs is limited, and some space must be held in reserve in the event one of the tanks leak, which would require immediate transfer of its contents to other tanks that are sound. The following activities support waste transfer and tank space operations.

- Develop and maintain operating procedures for waste retrieval and transfer operations.
- Perform waste compatibility analyses to ensure that waste meets applicable requirements.
- Establish routes (pipelines) for receipt of waste from the SSTs and transfer of waste within the DST system, including double-contained receiver tanks, cross-site transfers, transfers to support evaporator operations, and receipt of waste from other Hanford facilities (e.g., changing jumpers in pits and setting valves in preparation to transfer or receive waste).
- Fabricate and maintain piping jumpers necessary to route waste as needed.
- Perform operations as necessary to transfer waste, monitor systems during the transfers, and perform post-transfer line flushes.

At the end of each transfer, a material balance calculation based on the liquid-level reduction in the sending tank and liquid-level rise in the receiving tank is performed to verify that all of the waste has been transferred. This material balance, combined with analytical measurements of the transferred waste, allows a determination of radionuclide/chemical-specific retrieval efficiencies. The results can be evaluated to determine any deviations from the uniform (i.e., nonselective) retrieval efficiencies assumed for the purpose of analysis in this TC & WM EIS.

E.1.1.1.2.2 Maintenance

Maintenance consists primarily of preventive and corrective maintenance activities that are needed to provide operable and functional equipment to support system operations. This includes maintenance of all SST and DST system components, as well as maintenance of the waste feed delivery system being

constructed to supply waste feed to the WTP. Maintenance also includes the administrative and technical support required to perform maintenance work.

A safe and effective maintenance program is necessary to support tank farm operations designed for safe storage of waste and retrieval of waste to be processed by the WTP. Preventive and corrective maintenance measures are necessary to ensure operable equipment is calibrated, functionally tested, and thus compliant with AB and regulatory requirements. Preventive and corrective maintenance activities include the following:

- Calibration of all process instrumentation, such as liquid-level detectors, leak detection probes, flowmeters, and temperature indicators
- Maintenance of tank-related equipment, such as pumps, valves, and jumpers
- Maintenance of tank farm ventilation equipment, such as high-efficiency particulate air (HEPA) filters, pressure gauges, fans, and portable exhausters

Maintenance involves repair or removal and replacement of parts and equipment. As with any industrial process, this entails technical and administrative support for design, procurement, installation, and operability testing. Because the process involves managing both hazardous and radioactive waste, these functions have additional safety and regulatory considerations that must be taken into account.

E.1.1.1.2.3 Contaminated Equipment Removal

As a result of routine tank farm operations and maintenance activities, equipment becomes worn out, broken, or otherwise no longer fit for its intended use. The various tank farms contain equipment that is no longer required and has been contaminated with hazardous waste, radioactive materials, or both. Contaminated equipment is dispositioned according to appropriate Hanford procedures. Contaminated equipment characterized as dangerous or extremely hazardous is removed and may require treatment and disposal (WAC 173-303). Radioactive waste must meet the U.S. Department of Energy's (DOE's) Atomic Energy Act (42 U.S.C. 2011 et seq.) radioactive waste management criteria via the **Hanford Site Solid Waste Acceptance Criteria (HSSWAC)** (Fluor Hanford 2005a) prior to onsite disposal. The structural equipment is characterized, inventoried, and dispositioned as either reusable equipment or waste. Aboveground, out-of-service contaminated equipment that is not reusable and is inaccessible or difficult to remove (based on the risk and cost involved) is sealed to prevent contamination spread.

E.1.1.1.2.4 Contamination Zone Reduction

This activity provides a systematic method for implementing a graded approach to characterizing, cleaning up, and reposting tank farm outdoor areas that are currently radiological contamination or buffer areas. The graded approach prioritizes areas in which to eliminate habitat, reduce access to contaminated components, perform necessary surveys, and clean up areas to release. Localized high-contamination areas are immediately stabilized with a fixant.

Zone reduction of a tank farm involves all areas within the fence perimeter and extending to approximately 15 meters (50 feet) outside the fence perimeter. Decontamination of structures is not planned. Above-grade components, buildings, and structures are surveyed only on the exterior surfaces and verified as sealed or isolated to prevent spread of radioactive contamination. Examples of items typically removed include the following:

- Miscellaneous equipment, jumpers, and tools
- Low-level radioactive waste (LLW), lead shielding plates, and shielded sample holders

- Exhausters, exhauster parts, and diesel generators
- Old change trailers, industrial vacuums, and telescopic lighting towers

E.1.1.1.2.5 Routine Surveillance and Monitoring

Routine surveillance and monitoring activities are conducted to ensure compliance with AB requirements and environmental, occupational safety and health, and other applicable regulatory requirements. Surveillance and monitoring conducted for all tank farms and facilities includes daily, weekly, monthly, quarterly, and semiannual surveillances.

Routine radiological and chemical control surveys are conducted to characterize workplace conditions including vapor monitoring, identify areas requiring changes in radiological posting, control sources of radiation exposure, and verify control of radiological contamination.

Surveillance and monitoring are conducted to verify compliance with Resource Conservation and Recovery Act (RCRA) requirements; leak detection, monitoring, and mitigation requirements; Clean Air Act requirements for air emissions control and monitoring; and DOE's Atomic Energy Act requirements.

The tank monitoring and control system remotely monitors field equipment and automatically collects surveillance data to ensure AB controls and environmental requirements are met. Actions required to operate and maintain the tank monitoring and control system include performing routine system maintenance, resolving hardware and software issues, performing hardware and software upgrades, performing data backups and data management, and maintaining system operating procedures and specifications.

The Surveillance Analysis Computer System is a data management system for processing and reviewing data collected from the waste tanks regarding interstitial liquid levels, surface levels, and temperatures. Operation and maintenance of the Surveillance Analysis Computer System involves the following activities: performing routine system maintenance, resolving hardware and software issues, performing hardware and software upgrades, performing data backups and data management, and maintaining system operating procedures and specifications. In addition, Surveillance Analysis Computer System operation involves data quality verification and validation, as well as operation and maintenance of a personal computing Surveillance Analysis Computer System, which enables Hanford users to access the database and generate graphical reports.

An important element of tank farm surveillance and monitoring is the system engineer's function of data surveillance and evaluation. It is within this function that data on tank liquid levels (surface and interstitial) are analyzed to establish a baseline for each tank, as well as alarm limits that indicate a significant change in liquid-level readings. Anomalies in tank waste levels and interstitial liquid levels are investigated and reported to operations, and potential tank leaks are identified.

In addition to the activities mentioned above, staff coverage is required to respond to plant conditions that can affect compliance with the AB safety envelope and environmental requirements. This element covers continuity of operations, unusual or off-normal event monitoring and mitigation, responses to alarms, and emergency responses and participation in emergency drills (DOE 2003a).

E.1.1.1.2.6 Safety

Applicable requirements from the AB and controls derived from analysis of facility-specific work scope, operating conditions, hazards, and impacts are implemented to ensure the facility operates within the established safety envelope. Implementation of the safety basis for safe storage and management of legacy and new waste, operation and maintenance of tank farm facilities, waste retrieval and disposal, and

closure of the tank farm facilities is required. The Safety Basis Implementation Improvement Project is a discrete set of activities designed to raise the level of rigor associated with safety basis implementation.

Activities for AB compliance verification include the following:

- Performing AB compliance assessments and documenting results
- Addressing questions on current AB implementation
- Tracking, trending, and monitoring technical safety requirement compliance and corrective action management support
- Developing and maintaining procedures for AB implementation
- Providing an interface for AB implementation within the tank farm contractor and with outside organizations

Activities for ensuring implementation of changes to the AB include the following:

- Identifying items affected by an AB change (e.g., technical safety requirements, procedures, equipment, training, operations, surveillance and maintenance [S&M], and administrative controls)
- Verifying adequate implementation of the AB changes

E.1.1.2 Tank System Upgrades

Tank farm upgrade and construction projects are under way to provide systems necessary for the retrieval and transfer of waste to the WTP and for the storage or disposal of waste produced by the treatment process. Included in the construction projects is the administrative and technical support required to conduct these activities. The following list provides a description of ongoing or recently completed tank farm upgrade and construction projects (DOE 2003a).

- ***Project W-211, Initial Tank Retrieval System.*** Provides new pumps (mixer, decant, slurry, and supernatant pumps), electrical system upgrades, instrumentation and control system upgrades, chemical addition system, and valving upgrades.
- ***Project W-464, Immobilized High-Level Waste Interim Storage Facility.*** Provides storage capacity for the first 880 canisters of immobilized high-level radioactive waste (IHLW) through a retrofit of the Canister Storage Building (CSB).
- ***Project W-520, Integrated Disposal Facility.*** Provides a disposal facility for the permanent, environmentally safe disposal of mixed low-level radioactive waste (MLLW) and immobilized low-activity waste (ILAW).
- ***Project W-521, Waste Feed Delivery Systems.*** Provides retrieval, transfer, and feed delivery systems to connect tank farms to the WTP.
- ***Project W-522, Seven DST Retrieval Systems.*** Provides retrieval systems for seven DSTs to enable retrieval and delivery of waste to the WTP.
- ***Project E-525, DST Transfer System Modifications.*** Designs and constructs modifications to DST farm structures, systems, and components not addressed by other projects to ensure that they comply with regulatory, safety, and contractual requirements.

E.1.1.3 Planned Waste Treatment Plant Operations

A major aspect of the RPP's current program is treatment of waste in the WTP. The WTP, currently under construction, would be used to pretreat and immobilize (by vitrification to borosilicate glass) waste currently stored in the SSTs and DSTs. The waste that would be treated in the WTP is radioactive and dangerous waste, as defined by WAC 173-303, "Dangerous Waste Regulations."

The WTP, as designed, consists of waste treatment facilities, an Analytical Laboratory, and support facilities commonly referred to as the "balance of facilities" (BOF). The WTP is currently under construction in the 200-East Area of Hanford. The three waste treatment facilities are the Pretreatment Facility, the Low-Activity Waste (LAW) Vitrification Facility, and the High-Level Radioactive Waste (HLW) Vitrification Facility.

Waste would be transferred to the WTP by pipeline for pretreatment and vitrification. The pretreatment process is designed to separate the solid and liquid fractions of the waste into HLW and LAW streams. The solids would be washed and/or leached to remove chemical constituents that would result in increased IHLW glass volume. The liquid fraction forms the LAW stream once selected radionuclides have been removed. The separated radionuclides would be combined with the pretreated solids to form the HLW stream.

In the HLW and LAW vitrification processes, the HLW and LAW streams would be combined with glass-forming materials and melted to form a liquid about the consistency of molasses that can be poured into stainless steel containers. After the glass cools and solidifies, the containers would be sealed and decontaminated in preparation for storage or permanent disposal. The dangerous waste constituents would be removed or destroyed during the melting process or, along with the radioactive constituents; they would be immobilized in the durable glass matrix. The WTP is designed to accommodate a theoretical maximum capacity (TMC) of 6 metric tons of glass IHLW per day and 30 metric tons of glass ILAW per day.

The WTP processes would generate secondary waste, including offgas, liquid effluents, and miscellaneous solid wastes. The offgas streams would be treated to a level that protects human health and the environment in accordance with air emission regulations and permits. Liquid effluents would be directed to the Liquid Waste Processing Facilities (LWPFs) for treatment and/or onsite disposal in permitted facilities. The LWPFs are discussed in Section E.1.2.3.3. Miscellaneous solid wastes such as used equipment, laboratory waste, and other chemically and radiologically contaminated materials would be transferred to permitted disposal facilities on site. Certain wastes would be designated transuranic (TRU) waste and packaged for disposal at the Waste Isolation Pilot Plant (WIPP) near Carlsbad, New Mexico. Nonradioactive dangerous waste would be transferred to a permitted offsite disposal facility.

E.1.1.3.1 Waste Treatment Plant Facilities

The WTP, currently under construction, would be a newly constructed facility on Hanford property owned by the DOE. The site lies at the eastern end of the 200-East Area of Hanford. Figure E-1 shows the WTP site plot plan with all of the major facilities identified. The following summarizes characteristics of the main WTP facilities, with details provided later in Section E.1.2.3.1.

Pretreatment. The Pretreatment Facility would be a five-story concrete and steel building that houses the necessary tanks and process equipment for separating the waste into high- and low-activity fractions. Most of the equipment would be inside process cells with thick concrete walls for radiation shielding. The facility would include a set of four large tanks (1,438,300 liters [380,000 gallons] each) for receipt of waste feed from the DSTs.

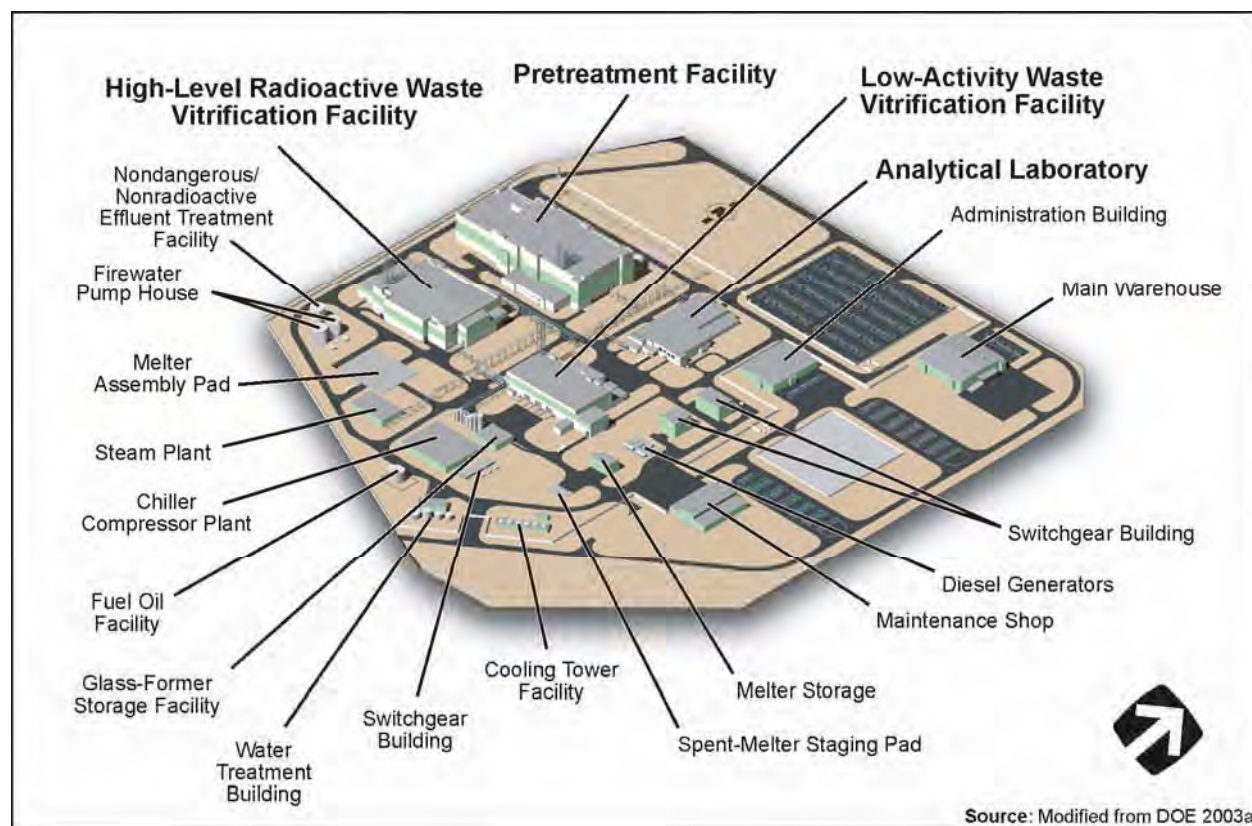

Figure E-1. Waste Treatment Plant Facilities

LAW Vitrification. The LAW Vitrification Facility would house feed preparation tanks, two large melters, and equipment for sealing and decontaminating containers filled with ILAW glass. The feed preparation tanks would be housed in a shielded cell, while the melters would be equipped with 2.54-centimeter-thick (1-inch-thick) steel panels for radiation shielding.

HLW Vitrification. The HLW Vitrification Facility would house feed preparation tanks and two separate HLW melter cells. Shared cells would be included for canister welding, decontamination, and lag storage of filled canisters. All process areas would be within shielded cells for radiation protection. Process and maintenance operations would be carried out with remote equipment.

Analytical Laboratory. The Analytical Laboratory would support the three treatment facilities described above. It is equipped with hot cells for handling highly radioactive samples and capable of characterizing samples of tank waste (DOE 2003a). The WTP BOF would include systems, utilities, and infrastructure required to support plant operations.

E.1.2 Descriptions of Tank Closure Alternative Facilities and Operations

Each of the alternatives evaluated in this TC & WM EIS comprises a set of technologies or activities that would enable specific outcomes under that alternative. Some technologies and activities are common to more than one alternative, while others have commonality but differ in the extent of implementation. A brief description of each Tank Closure alternative is included in the **Draft Tank Closure and Waste Management Environmental Impact Statement for the Hanford Site, Richland, Washington – Reader’s Guide**. Also included in the Reader’s Guide is a simplified process flow diagram of the major facilities and operations analyzed in this TC & WM EIS. Table E-3 provides a comparison of key parameters for each of the Tank Closure alternatives.

Each of the technologies and activities is described in greater detail in the following sections. The descriptions are intended to delineate the technical basis for the alternatives in this **TC & WM EIS** and to provide supporting information regarding the basis for analysis of impacts. Much of the information presented is drawn from more-detailed data packages that are available in the administrative record for this **TC & WM EIS**.

E.1.2.1 Facility Upgrades

Storage upgrades required to support planned tank farm and WTP operations include tank farm infrastructure upgrades, upgrades to the CSB for interim storage of IHLW glass, and construction of additional IHLW Interim Storage Modules.

E.1.2.1.1 Tank Space Upgrades and Replacement Double-Shell Tanks

This section discusses options for storage of waste retrieved from SSTs and miscellaneous underground storage tanks (MUSTs). Additional waste storage is included in the **TC & WM EIS** alternatives where sufficient DST space would not be available within the existing tank farms or where treatment extends beyond the useful life of the existing DSTs and replacements are required.

E.1.2.1.1.1 Waste Volumes and Available Capacity

This section presents an analysis of current and future DST capacities and waste volumes. The quantities of waste and available DST space were taken from current sources and are accurate to the limitations cited in the referenced documentation.

Active waste storage currently takes place in the existing DST system. Storage is provided by 28 DSTs with an approximate capacity of 4.3 million liters (1.14 million gallons) each. Of these tanks, 25 are located in the 200-East Area and 3 are located in the 200-West Area. None of the DSTs has leaked to date.

Waste is also stored in 149 older, inactive SSTs. Of these 149 SSTs, 67 are known or suspected to have leaked. There are also 66 smaller underground MUSTs associated with the SST and DST systems, 61 of which are under the jurisdiction of the DOE RPP. They vary in size from approximately 3,000 to 190,000 liters (800 to 50,000 gallons), contain sludge and process materials similar to the waste in the SSTs and DSTs, and have a total waste volume that is less than 1 percent of the SST waste. Of these 61 MUSTs, 13 are part of the DST system and therefore are not included within the scope of the closure action analyzed in this EIS (DOE 2003b; Hebdon 2001).

Table E-3. Comparison of Tank Closure Alternatives

| | Alternative 1: No Action | Alternative 2A: Existing WTP Verification; No Closure | Alternative 2B: Expanded WTP Verification; Landfill Closure | Alternative 3A: Existing WTP Verification with Thermal Supplemental Treatment (Bulk, Vitrification); Landfill Closure | Alternative 3B: Existing WTP Verification with Nonthermal Supplemental Treatment (Cast Stone); Landfill Closure | Alternative 3C: Existing WTP Verification with Thermal Supplemental Treatment (Steam Reforming); Landfill Closure | Alternative 4: Existing WTP Verification with Supplemental Treatment Technologies; Selective Clean Closure/Landfill Closure | Alternative 5: Expanded WTP Verification with Supplemental Treatment Technologies; Landfill Closure | Alternative 6A: All Vitrification/No Separations; Clean Closure | Alternative 6B: All Vitrification with Separations; Clean Closure | Alternative 6C: All Vitrification with Separations; Landfill Closure |
|--|-----------------------------|--|--|---|--|---|--|--|--|--|---|
| Storage | | | | | | | | | | | |
| Existing | ✓ | | | | | | | | | | |
| New WRFs | | | ✓ | | ✓ | | | ✓ | | ✓ | ✓ |
| New DSTs | | ✓ | | | | | | ✓ | ✓ | | |
| Retrieval | | | | | | | | | | | |
| 90 percent | | | ✓ | | | | | ✓ | | | ✓ |
| 99 percent | | | ✓ | | | | | | | | |
| 99.9 percent | | | ✓ | | | | | | | | |
| Treatment | | | | | | | | | | | |
| WTP | | | | | | | | | | | |
| Existing vitrification only | | ✓ | | ✓ | | ✓ | | | | | ✓ |
| Expanded LAW vitrification | | | ✓ | | | | | ✓ | | ✓ | ✓ |
| Expanded HLW vitrification | | | | | | | | | | | |
| Replacement of WTP | | ✓ | | | | | | | ✓ | | ✓ |
| Technetium-99 removal | | | ✓ | | | | | | | | |
| Sulfate removal | | | | | | | | | | | |
| Cesium and strontium capsules | | ✓ | | ✓ | | ✓ | | | | ✓ | ✓ |
| Non-WTP | | | | | | | | | | | |
| Tank mixed TRU waste supplemental treatment | | | ✓ | | | ✓ | | | | | |
| Thermal supplemental treatment | | | ✓ | | | ✓ | | | | | |
| Nonthermal supplemental treatment | | | ✓ | | | ✓ | | | | | |
| Disposal (including post-treatment storage) | | | | | | | | | | | |
| On Site | | | | | | | | | | | |
| ILAW | | ✓ | ✓ | ✓ | ✓ | ✓ | ✓ | ✓ | ✓ | a | a |
| IHLW ^b | | ✓ | ✓ | ✓ | ✓ | ✓ | ✓ | ✓ | ✓ | ✓ | ✓ |
| Grouted sulfate | | | | | | | | | | | |
| Contaminated soil | | ✓ | ✓ | ✓ | ✓ | ✓ | ✓ | ✓ | ✓ | ✓ | ✓ |
| SSTs | | | | | | | c | | d | d | |
| Off Site | | | | | | | | | | | |
| Tank mixed TRU waste to WIPP | | | ✓ | ✓ | ✓ | ✓ | ✓ | ✓ | ✓ | ✓ | ✓ |
| Closure | | | | | | | | | | | |
| Clean closure | | | | | | | | | | ✓ | ✓ |
| Selective clean closure/landfill closure | | | | | | | ✓ | | | | |
| Landfill closure | | | ✓ | ✓ | ✓ | ✓ | ✓ | ✓ | | | ✓ |
| Modified RCRA Subtitle C barrier | | | ✓ | ✓ | ✓ | ✓ | ✓ | | e | e | ✓ |
| Hanford barrier | | | | | | | | ✓ | | | |

a Under Alternatives 6B and 6C, ILAW glass would be interim-stored on site and managed as IHLW glass.
 b Although disposition decisions have not been made and implemented, these alternatives do not assume the inventory in the IHLW canisters remains on site. However, the number of storage facilities needed to store all the IHLW is one more than the number of canister storage facilities analyzed under Tank Closure Alternative 2B.
 c Under Alternative 4, SSTs at the BX and SX tank farms would be removed and treated in the Preprocessing Facility.
 d Under Alternatives 6A and 6B, all SSTs would be removed and packaged in shielded boxes for onsite storage pending disposition.
 e Base Case: Modified RCRA Subtitle C barrier over six sets of cribs and trenches (ditches) in B and T Areas. Option Case: Remove six sets of cribs and trenches (ditches) in B and T tank farm areas and remediate their deep-soil plumes.
Key: DSTs=double-shell tanks; HLW=high-level radioactive waste; IHLW=immobilized high-level radioactive waste; ILAW=immobilized low-activity waste; LAW=low-activity waste; RCRA=Resource Conservation and Recovery Act; SST=single-shell tank; TRU=transuranic; WIPP=Waste Isolation Pilot Plant; WRFs=waste receiver facilities; WTP=Waste Treatment Plant.

Currently the availability of DST tank space limits retrieval from SSTs and MUSTs. SSTs and MUSTs cannot be used for long-term storage of retrieved waste because of their age, suspect integrity, and lack of secondary containment capability. The total available tank volume in the DSTs is 117 million liters (31 million gallons). Deducting the tank volume set aside for administrative controls (emergency reserve, WTP feed staging, and restricted tank space), the effective capacity of the DST system is approximately 102 million liters (27 million gallons). The DSTs currently contain approximately 85 million liters (22.5 million gallons) of waste, leaving an available capacity of about 17 million liters (4.5 million gallons). Additional capacity of 15 million liters (4 million gallons) could be achieved by evaporating waste to reduce volume and raising tank capacity administrative control limits. Even with this additional available capacity, all of the alternatives, with the exception of Tank Closure Alternative 1, would require additional storage capacity to support retrieval and WTP operations. Waste receiver facilities (WRFs), as discussed in Section E.1.2.2.8, would be provided under Tank Closure Alternatives 2B through 5 and 6B and 6C. Storage facility upgrades in the way of new or replacement DSTs would be provided under Alternatives 2A, 5, and 6A.

E.1.2.1.1.2 Storage Requirements

Under Tank Closure Alternative 5, the construction of four new DSTs would be required to provide sufficient DST storage capacity to match the rate at which waste would need to be removed for treatment to complete all treatment of tank waste by 2033.

An analysis of the additional DST storage capacity necessary under Tank Closure Alternative 5 was performed. However, that analysis did not account for operational upsets such as temporary decreases in treatment throughput or DST failures. Therefore, 15 million liters (4 million gallons) of new storage capacity was selected for analysis of Alternative 5 (Fredenburg 2003). New, below-grade DSTs, similar to existing DSTs, would be constructed, as depicted in Figure E-2.

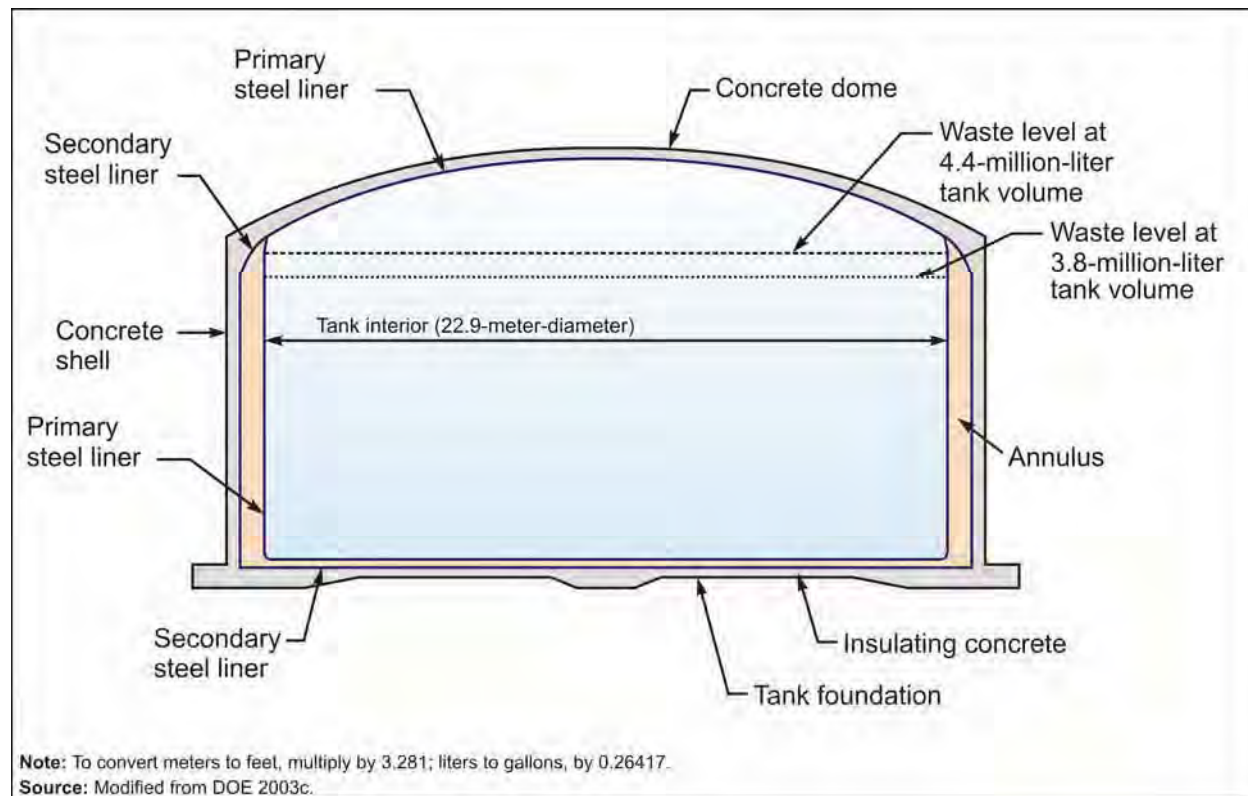

Figure E-2. Cross-Sectional View of Representative Hanford Site Double-Shell Tank

Under Tank Closure Alternatives 2A and 6A, replacement of existing DSTs would be required due to useful life constraints and the potential for integrity failure of the DSTs. Tank Closure Alternative 2A assumes the 28 DSTs would have to be replaced once to extend storage and treatment of tank waste to 2093 because WTP expansion and supplemental technologies would not be used to expedite treatment. Tank Closure Alternative 6A, which treats all tank waste as HLW, requires replacement of the 28 DSTs three times (e.g., construction of 84 new DSTs) in order to extend storage and treatment of tank waste to 2163.

All other alternatives analyzed in this TC & WM EIS provide sufficient treatment capacity by expanding WTP or supplemental technologies to allow the use of existing DST storage capacities, thereby eliminating the need to construct new or replacement DSTs.

E.1.2.1.2 Interfacing Facilities

The following facilities would interface with storage, retrieval, and treatment of tank waste.

- **242-A Evaporator.** Services include evaporating the liquid fraction of DST waste. Operation of the existing evaporator is planned to continue until fiscal year 2018. Replacement evaporators would need to be constructed and operated to support the Tank Closure alternatives. The 242-A Evaporator is described in Section E.1.2.3.2.
- **222-S Analytical Laboratory.** Services include providing a dedicated laboratory facility to deliver analytical chemistry services in support of characterization. The laboratory is expected to operate as long as required to support tank waste characterization, tank waste retrieval, and waste feed delivery to the WTP. Upgrades or replacements to the 222-S Analytical Laboratory are not analyzed in this EIS because its use is expected to be limited following the start of operations of the WTP Analytical Laboratory.
- **Effluent Treatment Facility (ETF)/Liquid Effluent Retention Facility (LERF).** Services include processing of liquid effluents designated as radioactive and dangerous wastes. The LERF would need a life extension upgrade in 2015. Operation of the ETF is planned to continue until fiscal year 2025. After the life extension upgrade, the LERF would operate through the end of the WTP service life. Replacement ETFs would need to be constructed and operated to support the Tank Closure alternatives. The LWPFs, including the LERF and ETF, are described in Section E.1.2.3.3.
- **Treated Effluent Disposal Facility (TEDF).** The 200 Area TEDF is permitted for disposal of nonradioactive, nondangerous liquid effluents. A life extension project is planned for fiscal year 2009, after which the facility was assumed to be operational through the end of the WTP operation. The TEDF is described in Section E.1.2.3.3.

E.1.2.1.3 Interim Storage of Immobilized High-Level Radioactive Waste

Safe interim onsite storage of IHLW glass would be necessary until disposition decisions are made and implemented. The TWRS EIS anticipated that the canisters would be stored in the CSB, along with multiccanister overpacks of spent nuclear fuel from Hanford's K Basins (DOE and Ecology 1996).

Interim storage capacity, including that of the CSB, would be expanded through construction of a new IHLW Shipping/Transfer Facility and IHLW Interim Storage Modules. These facilities would include load-out capabilities for transferring IHLW glass canisters to overpacks for potential future shipment and new IHLW Interim Storage Modules similar to the CSB that can be individually constructed as additional capacity is required (DOE 2003d).

The IHLW Shipping/Transfer Facility would be constructed concurrently to support IHLW glass canister shipments. Construction of additional storage modules is included under each of the TC & WM EIS alternatives to provide storage capacity for IHLW glass produced in the WTP. In the case of Tank Closure Alternatives 6A, 6B, and 6C, all of the waste would be managed as IHLW glass, and appropriate storage facilities are considered for IHLW glass, ILAW glass, and waste from closure of the tank farms.

E.1.2.1.3.1 Assumptions and Uncertainties

Due to uncertainties regarding the timing for shipment of IHLW glass canisters off site and the capacity for receiving all waste managed as HLW (Tank Closure Alternatives 6A, 6B, and 6C), it was assumed that onsite storage facilities would be required for all IHLW glass.

E.1.2.2 Waste Retrieval and Storage

The following sections describe the technologies, facilities, assumptions, and uncertainties associated with options for retrieval of waste from SSTs and transfer to DSTs and WRFs for storage and eventual treatment. Depending on the alternative, retrieved waste may be transferred directly to a supplemental treatment facility.

The SST design details are presented in four groups as described below and as shown in Figure E-3.

- B, C, T, and U tank farm 200-series tanks (6-meter-diameter [20-foot-diameter]) with 210,000-liter (55,000-gallon) nominal tank capacity.
- B, BX, C, T, and U tank farm 100-series tanks (22.9-meter-diameter [75-foot-diameter]) with 1.9-million-liter (500,000-gallon) nominal tank capacity.
- BY, S, TX, and TY tank farm 100-series tanks (22.9-meter-diameter [75-foot-diameter]) with 2.8-million-liter (750,000-gallon) nominal tank capacity.
- A, AX, and SX tank farm 100-series tanks (22.9-meter-diameter [75-foot-diameter]) with 3.8-million-liter (1-million-gallon) nominal tank capacity.

Retrieval technologies are evaluated with respect to their ability to achieve certain waste retrieval benchmarks established to allow assessment of the environmental impacts associated with the degree of waste retrieval proposed under the various Tank Closure alternatives. The four waste retrieval benchmarks considered in this TC & WM EIS are as follows:

- A **0 percent retrieval** involves no removal of tank waste. The 0 percent retrieval was analyzed for the No Action Alternative.
- A **90 percent retrieval** involves removing tank waste to achieve a residual waste volume equal to 102 cubic meters (3,600 cubic feet) for the 100-series SSTs and 8.5 cubic meters (300 cubic feet) for the 200-series SSTs.
- A **99 percent retrieval** involves removing tank waste to achieve a residual waste volume equal to 10.2 cubic meters (360 cubic feet) for the 100-series SSTs and 0.85 cubic meters (30 cubic feet) for the 200-series SSTs.

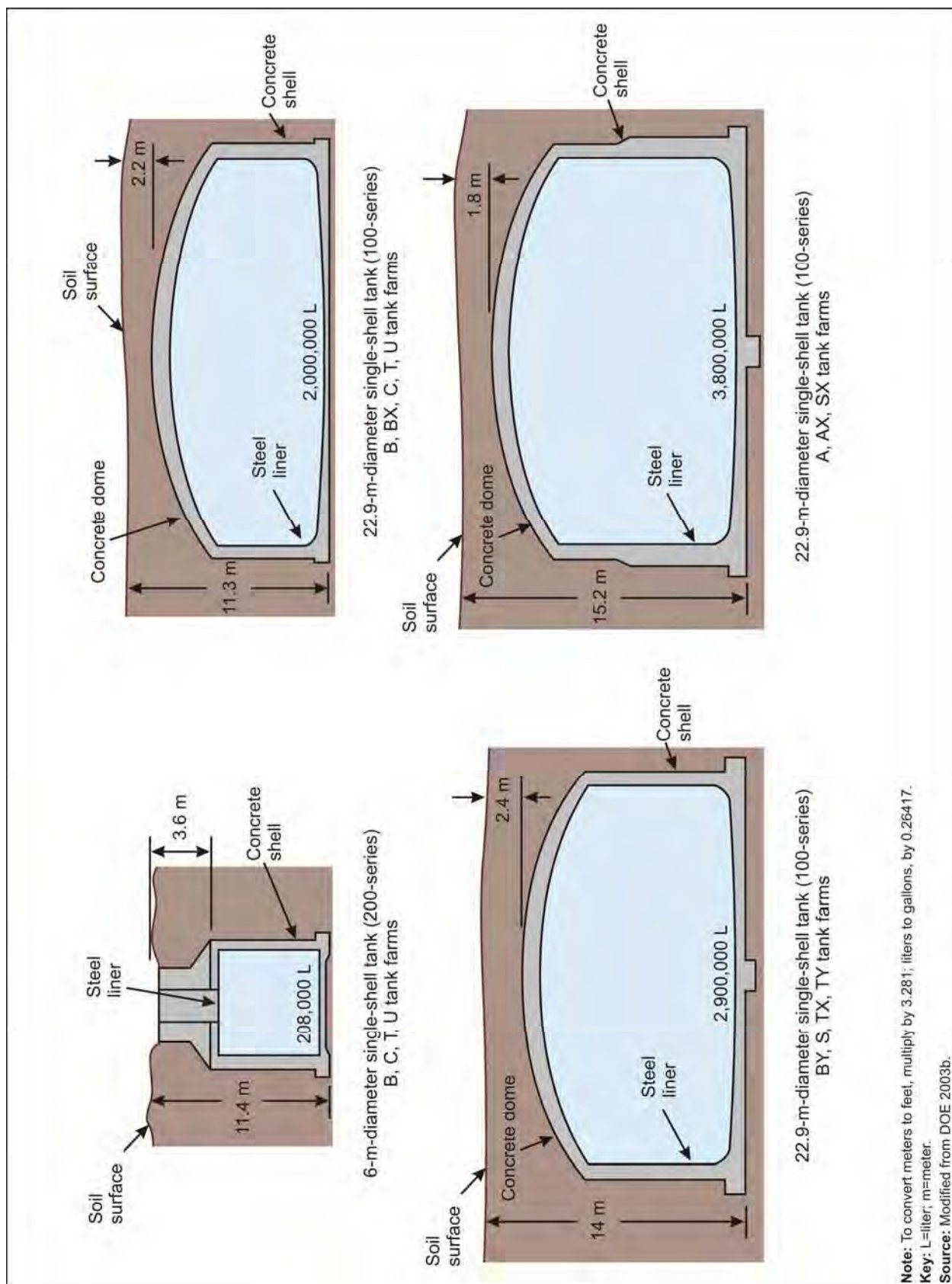

Figure E-3. Cross-Sectional Views of Hanford Site Single-Shell Tanks

- A **99.9 percent retrieval** involves removing tank waste to achieve a residual waste volume equal to 1 cubic meter (36 cubic feet) for the 100-series SSTs and 0.08 cubic meters (3 cubic feet) for the 200-series SSTs. The 99.9 percent retrieval rate was used in cases where tank removal was analyzed to limit worker exposure. It also reflects multiple uses of retrieval technologies.

Zero percent retrieval was analyzed under Tank Closure Alternative 1; 90 percent retrieval was analyzed under Tank Closure Alternative 5; 99 percent retrieval was analyzed under Tank Closure Alternatives 2A, 2B, 3A, 3B, 3C, and 6C; and 99.9 percent retrieval was analyzed under Tank Closure Alternatives 4, 6A, and 6B.

E.1.2.2.1 Modified Sluicing

Modified sluicing has been identified as an option for retrieval of 99 percent of the waste from DSTs and from SSTs not designated as known or suspected leakers. Modified sluicing is similar to past-practice sluicing, in which nozzles were used to spray liquid into the tanks to dissolve and dislodge the waste, then pump it out for processing. Although modified sluicing uses less water, it would not be used to retrieve waste from SSTs that are known or suspected to have leaked in the past.

E.1.2.2.1.1 Technology Description

A modified sluicing retrieval system has been used as described below. Actual equipment types, locations, and quantities may vary on a tank-by-tank basis.

E.1.2.2.1.2 Process

Modified sluicing is the introduction of liquid into the waste at low-to-moderate pressures and volumes. Pressures of 345,000 to 1.38 million pascals (50 to 200 pounds per square inch) and flow rates from 300 to 910 liters (80 to 240 gallons) per minute are typical (DOE 2003c). At lower pressures and flow rates, the retrieval action is primarily dissolution and retrieval of soluble species. At higher pressures and flow rates, the retrieval action is due to both dissolution of soluble species and the breaking apart of solid materials and suspension into a waste slurry. A transfer pump inside the tank pumps the waste to a receiver tank.

Modified sluicing differs from past-practice sluicing in the following ways:

- Past-practice sluicing introduces sluicing liquid from a single sluice nozzle in bulk fashion by a flooding-type action. Modified sluicing introduces sluice liquid in a controlled fashion using two to three sluicing nozzles and then pumps out the resultant waste slurry at approximately the same rate that the sluice liquid is introduced. This operating strategy maintains a minimal liquid inventory within the tank at all times.
- The use of two to three sluice nozzles in modified sluicing allows a more thorough distribution of sluicing liquid over the tank contents.

The modified sluicing waste retrieval system could potentially be used to retrieve 99 percent of the waste from the DSTs and nonleaking 100-series SSTs. The DSTs would have pumps installed to help dislodge waste solids and thereby aid retrieval.

E.1.2.2.1.3 Facilities

The equipment used for modified sluicing is shown in Figure E-4. The major equipment items and their functions are discussed below.

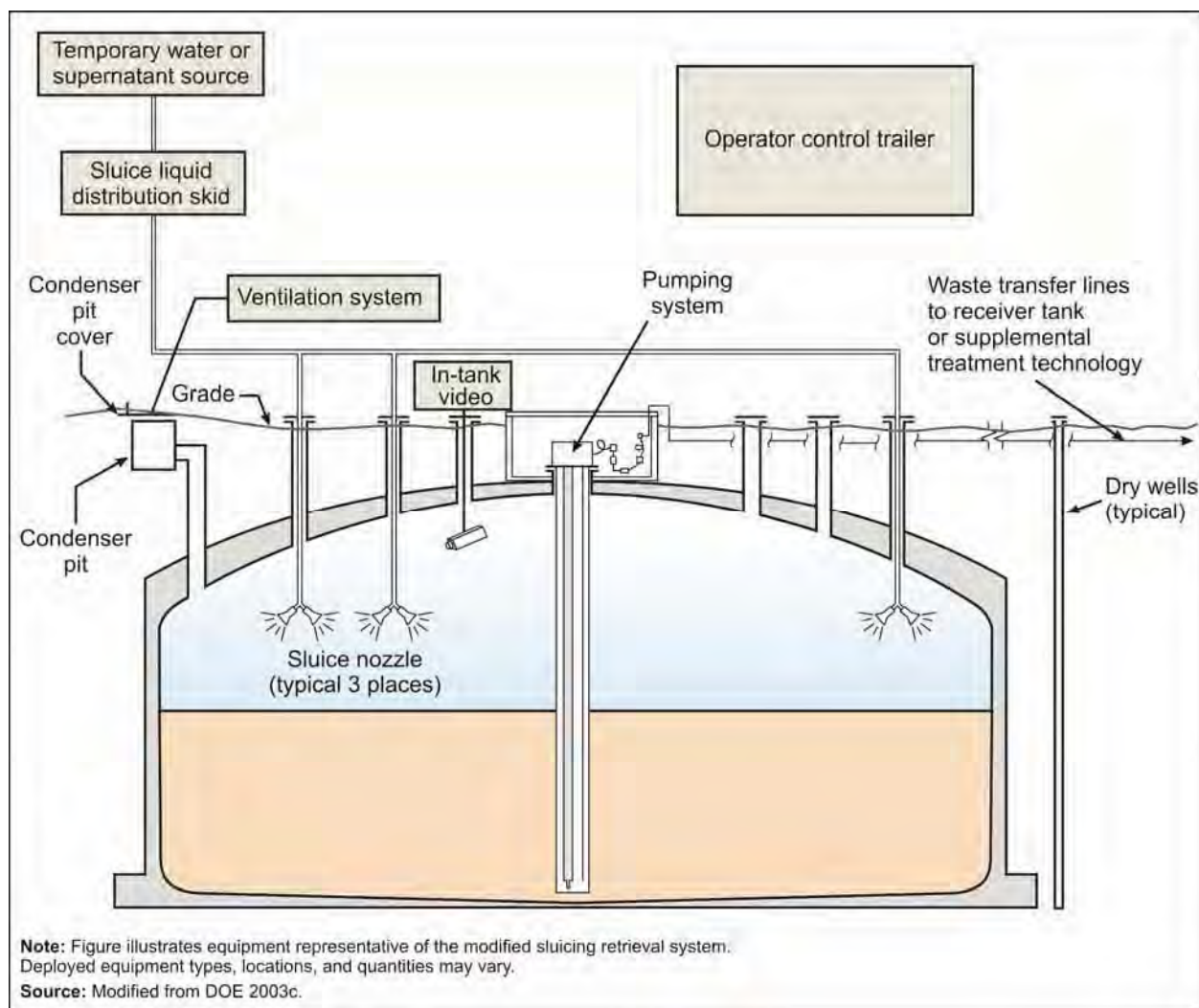

Figure E-4. Modified Sluicing Equipment Schematic

The sluice nozzles (typically three) discharge sluice liquid in a concentrated stream onto the waste surface. The sluice nozzles are placed through risers around the perimeter of the tank and are remotely manipulated. The nozzles can typically be rotated 360 degrees horizontally and adjusted 90 degrees vertically (between pointing straight down and horizontal). Depending on the waste type, sluicing systems may use water or supernatant from a DST as the retrieval liquid.

The sluice liquid distribution skid provides the structural support, confinement, and leak detection (as required) for the sluice liquid distribution manifold (piping, valves, flowmeters, filters, and various fittings); the instrumentation/power enclosures; and a pump. Sluice liquid is piped to the sluice liquid distribution skid, where it is pumped to the various sluice nozzles.

The ventilation system maintains the tank pressure within specified limits during the retrieval operation. The ventilation system consists of an inlet filter assembly and a portable exhauster skid that includes HEPA filters, air emission monitors/samplers, and associated ductwork. The inlet filter connects to an existing riser on the tank. Collectively, the tank ventilation primary assembly performs the following functions:

- Maintains a negative pressure within the tank to prevent the release of airborne radioactive particulates to the environment

- Controls emissions of the air/gas stream before the effluents are discharged to the environment
- Minimizes the amount of condensation in the tank headspace

The field instrument electrical skid includes receptacles that provide power to the ventilation system and the water distribution skid, as well as a power center that provides single-phase power for transfer line heat tracing and various instrumentation.

In-tank video systems are installed to allow operators to monitor and assess the tank retrieval operations and performance.

The pumping system consists of a pump located in the tank. The system pumps waste slurry from the tank.

The operator control trailer contains the instrumentation, video, and power capability necessary for monitoring and controlling the waste retrieval operation.

Prior to initiating modified sluicing, the proper configuration of all equipment is established. All of the necessary portable equipment and instrumentation are delivered to the tank and set up. Jumpers are set and hose-in-hose transfer lines (HIHTL) are installed (if required) to establish a waste transfer route. A waste transfer pump is installed, sluice nozzles are positioned for delivering the sluice water, and the receiving tank is made ready to receive the waste.

Sluicing is initiated by starting the sluice liquid delivery pump. This introduces the sluice liquid into the tank through the in-tank sluice nozzles. The sluice liquid affects the surface of the waste, dislodging and suspending waste particles, dissolving soluble species, and creating a waste slurry. Liquid is delivered to the SST until the waste slurry level rises and covers the inlet to the waste transfer pump, which is located near the floor of the tank. The waste transfer pump is then started. The waste transfer pump delivers the waste slurry to the receiver tank. To mitigate the potential for leakage to occur during waste retrieval, the liquid volumes are minimized.

Sluice liquid is delivered to the SST simultaneously with waste slurry being removed from the SST until preestablished conditions for the extent of waste retrieval are met. The in-tank video system is used to observe retrieval progress and make adjustments as necessary. The transfer line between the SST and the receiver tank is periodically flushed to prevent potential line blockages.

This process is continued until either the waste retrieval goals are met or the equipment has retrieved waste to the extent of its design and functional capability.

E.1.2.2.1.4 Assumptions and Uncertainties

- For the purposes of analysis, it was assumed that the construction, operations, and deactivation impacts assessed for tank 241-S-112 waste retrieval were representative of the proposed modified sluicing system.
- Temporary facilities associated with modified sluicing would be moved and reused for four tank retrievals.

Key uncertainties with modified sluicing include the following:

- Ability to retrieve hard heels (i.e., dense, highly compacted waste on the tank bottom)
- Ability to remove waste from tank walls and in-tank equipment

- Effectiveness of sluicing regarding both retrieval rates and the ability to meet retrieval goals (e.g., 99 percent)
- Ability to retrieve all types of sludge

Modified sluicing concepts have been used at the Hanford Cold Test Facility (**S-112 Project Proof-of-Principle Test Plan/Procedure for Cold Test Facility** [CH2M HILL 2002]). Modified sluicing is also similar to the process used to retrieve waste from tank 241-C-106, which was based in large part on past-practice sluicing at Hanford (Carpenter 2002). Based on the results of testing at the Hanford Cold Test Facility and the similarity of modified sluicing to past-practice sluicing, no significant technical implementation issues are foreseen for construction and use of modified sluicing systems.

E.1.2.2.2 Mobile Retrieval System

The mobile retrieval system (MRS) has been identified as an option for retrieving 99 percent of the waste from the 100-series SSTs designated as known or suspected leakers. The MRS with a chemical wash has been identified as an option for retrieving 99.9 percent of the waste from all DSTs and all 100-series SSTs. The MRS employs vacuum-assisted retrieval to retrieve waste with a minimum amount of water added. This minimizes the potential for leaks during retrieval.

E.1.2.2.2.1 Technology Description

The following is a description of a typical MRS that would be used. Actual equipment types, locations, and quantities may vary on a tank-by-tank basis.

E.1.2.2.2.2 Process

The MRS is a vacuum-driven system that uses mostly air and a small amount of water to retrieve waste. The MRS uses two major pieces of equipment: an articulated-mast system (AMS) and an in-tank vehicle (ITV). The AMS is typically located in the central region of the tank because it requires a relatively large-diameter access riser, 30.5 centimeters (12 inches), that typically does not exist in other locations of the tank. The mast contains a waste vacuum system on an articulated arm that can be extended horizontally and rotated up to 360 degrees to access a circular area in the center of the tank that measures approximately 9.1 meters (30 feet) in diameter. The arm carries a vacuum-operated unit that sucks up the waste and lifts it from the tank to a skid-mounted vessel on the tank farm surface. The ITV can be moved around the entire tank to physically push the waste, carry a sluice nozzle, and carry a vacuum hose-and-nozzle assembly.

A typical retrieval campaign involves first using the AMS to retrieve waste from the central area of the tank. The ITV can then be used to plow, push, or jet waste from the outer areas of the tank toward the center of the tank. Sluice water can be added to aid this process. The ITV can also be used to remove waste from the tank using its vacuum nozzle and hose assembly. At the end of the retrieval campaign, the ITV can be used for rinsing the tank walls and in-tank equipment.

The AMS and ITV systems retrieve waste from the tank into a skid-mounted vessel in approximately 3,000-liter (800-gallon) batches. The waste is then pumped from this vessel to the waste receiver tank. Water is added to the waste as it is pumped from the vessel to form a slurry suitable for pipeline transfer. An ultrasonic de-agglomeration system may be used to prevent particulates from clustering and plugging the transfer lines.

For retrieval operations from SSTs known or suspected to have leaks, leak detection and monitoring systems and procedures are used to help ensure that little or no waste is leaked to the tank farm soil.

An MRS was designed, built, and tested in the Cold Test Facility at Hanford (241-C-104 Waste Retrieval System Preliminary Design Report (Project W-523) [Carpenter 2002]). The testing showed that the MRS can potentially be used to retrieve 99 percent of waste from leaking 100-series SSTs, and the MRS with a chemical wash can be used to retrieve 99.9 percent of waste from all DSTs and all 100-series SSTs.

E.1.2.2.2.3 Facilities

The MRS consists of two primary pieces of equipment, the AMS and the ITV. Additional above-tank support equipment is required for each. Supporting the AMS are a vessel vacuum and pump skids and a decontamination unit. Supporting the ITV are an umbilical management system and associated decontamination units. Each component is described in greater detail below (DOE 2003c). Major equipment required for the MRS is shown in Figure E-5.

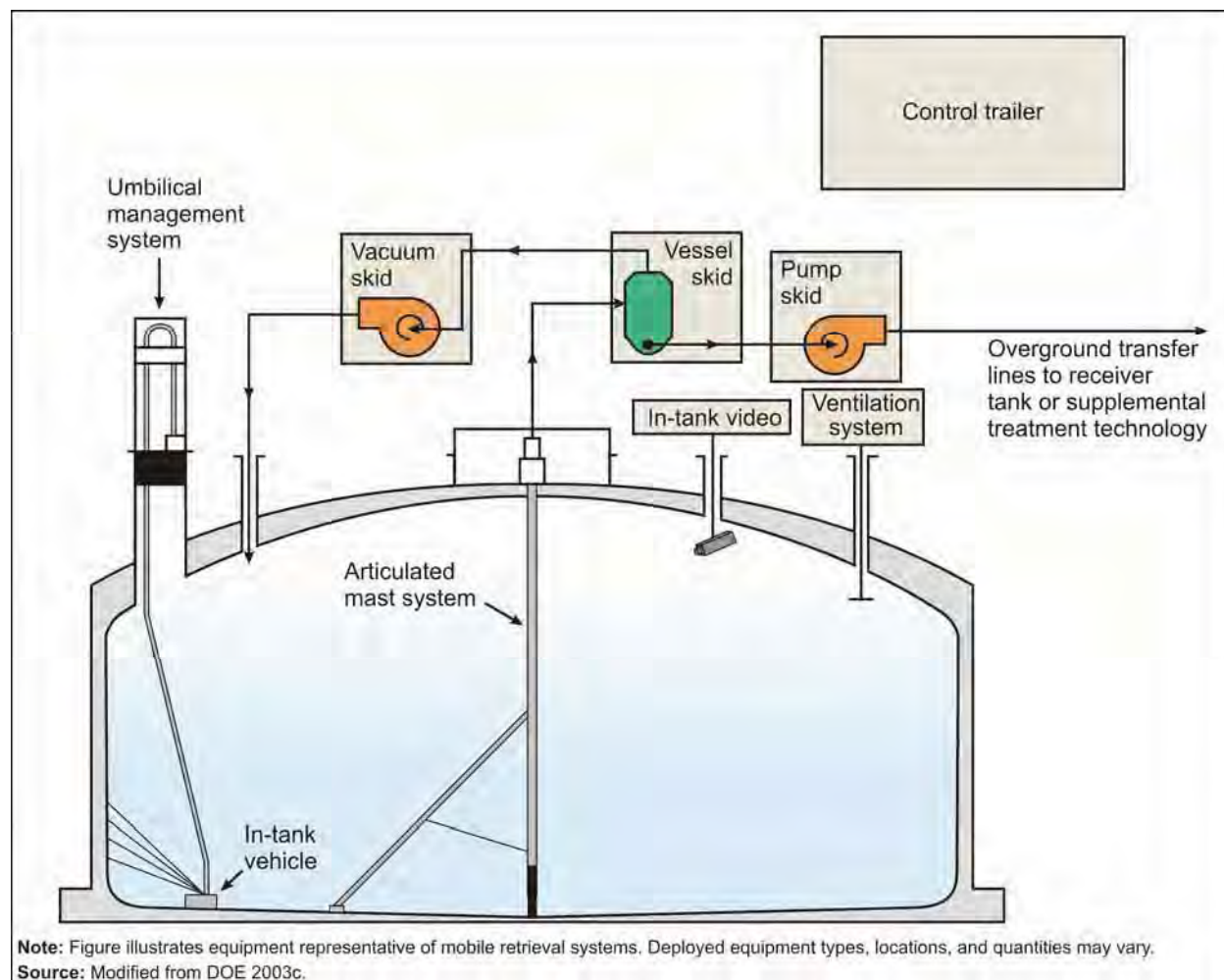

Figure E-5. Mobile Retrieval System Schematic

The AMS is a mast-deployed system used to retrieve and convey waste out of the tank. An articulated arm can be extended from the mast for an effective cleaning radius of nominally 4.6 meters (15 feet). At the end of the arm is a fluid-kinetics-driven unit that dislodges waste and provides the kinetic assist to vacuum-induced forces sufficient to draw waste out of the tank.

The vessel skid holds a waste batch vessel connected to the AMS. The vessel is nominally 3,500 liters (925 gallons) in size and can accumulate nominally about 3,000 liters (800 gallons) of waste. The waste batch vessel is placed under a vacuum created by the vacuum skid. This vacuum draws waste into the

vessel, where the waste is separated from the gas stream. The gas stream continues to the vacuum skid and back to the tank. When the waste batch vessel is full, the waste is pumped to a receiver tank. Water is mixed with the waste as it is being pumped to achieve a target specific gravity.

The vacuum skid holds two liquid-ring vacuum pumps, along with a seal tank. Only one pump is needed to obtain the vacuum to retrieve waste from the tank; the second pump provides redundancy. The seal tank collects entrained liquid separated from the gas stream at the pump discharge and provides sealing liquid for vacuum pump operation.

A pump skid holds booster pumps and associated equipment for transferring retrieved waste from the vessel skid to the waste receiver tank through double-encased pipelines. The booster pump draws the conditioned waste slurry from the vessel skid through an ultrasonic deagglomeration unit. The ultrasonic unit is about 1.8 meters (6 feet) long and is fitted with transducer banks on the outside of the unit. Ultrasonic energy (nominally 30- to 40-kilohertz frequency) is transmitted through the pipe wall to the waste slurry to break the binding force of agglomerated waste particles. Two booster pumps are provided on the skid for redundancy. The nominal operating conditions for a single pump are a pressure of 1.17 million pascals (170 pounds per square inch) with a flow rate of 320 liters (85 gallons) per minute. Each pump is nominally capable of producing a pressure of 1.72 million pascals (250 pounds per square inch) at the pump outlet.

The ITV is an adaptation of a commercially available crawler-type vehicle. A platform on the unit contains a pump and a jetting system for moving waste toward the AMS. The ITV is deployed after the waste within the effective cleaning radius of the AMS has been removed. Waste is either jetted or pushed by the ITV toward the AMS for retrieval. At the end of the retrieval campaign, clean water is supplied to the ITV for rinsing the tank walls and in-tank equipment.

The umbilical management system, located within the upper module of the ITV, stores, deploys, and withdraws hoses connected to the ITV. It consists of a reel used to manage the ITV hose and hydraulic lines. Water supply and hydraulic lines are connected to the umbilical management system in the upper module of the ITV. Water and hydraulic fluid are then conveyed to the ITV through the umbilical tethered to the ITV.

Decontamination systems use heated water to decontaminate the ITV as it is removed from the tank. Decontamination of the ITV is performed in three stages. Stage 1 is a low-pressure spray ring located in the riser where the ITV is installed. Stage 2 involves high-pressure spray rings located in a lower module. Stage 3 is an ultrasonic unit inside an upper module that performs final decontamination. This decontamination unit consists of a tank nominally 3,400 liters (900 gallons) in capacity. The decontamination water from the system drains back into the SST and may be removed using the AMS.

In-tank video systems are installed to allow tank farm operators to monitor the retrieval process and assess MRS performance for meeting retrieval objectives.

A ventilation system maintains a negative tank pressure (below atmospheric) within the specified limits during the retrieval operation. This ensures that airflow is pulled into the tank at all times and airborne contamination is not released from the tank. The ventilation system consists of an inlet filter assembly and a skid-mounted portable exhauster with HEPA filters, air emission monitors/samplers, and associated ductwork. The tank inlet filter and portable exhauster inlet ductwork are connected to existing risers on the tank. Collectively, the tank ventilation system performs the following functions:

- Prevents release of airborne radioactive particulates to the environment
- Controls emissions of the air/gas stream before the effluents are discharged to the environment
- Minimizes the amount of condensation in the tank headspace

A control trailer is located near the tank from which waste is retrieved. Operation and monitoring of the system are performed from the control trailer. The closed-circuit television monitors and camera manipulation controls are also located within the control trailer.

Prior to initiating retrieval, proper configuration of all equipment is established. All of the necessary portable equipment and instrumentation are delivered to the tank and set up. Jumpers are set and HIHTL lines are installed (if required) to establish a waste transfer route. The AMS and ITV systems are installed, and the receiving tank is made ready to receive the waste.

E.1.2.2.2.4 Assumptions and Uncertainties

For purposes of analysis, it was assumed that the construction, operations, and deactivation impacts assessed for tank 241-C-104 retrieval were representative of the proposed MRS.

Temporary facilities associated with the MRS would be moved and reused for four tank retrievals.

The ITV is an adaptation of a commercially available system. This technology has a proven track record in the commercial petroleum and chemical manufacturing industries. The AMS and support equipment have been tested at the Hanford Cold Test Facility with simulated waste. However, it is not certain how well they would function when used for retrieval of actual SST waste. For retrieval analysis, this TC & WM EIS assumed that this retrieval technology would function as designed and tested.

The MRS was designed to be placed through existing SST risers. It is uncertain whether all SSTs have enough risers to use the MRS. New risers may be required for some tanks.

Key uncertainties with the MRS include the following:

- Ability to remove hard heels (i.e., dense, highly compacted waste on the tank bottom)
- Ability to remove waste from tank walls, air-lift circulators, and other in-tank equipment
- Effectiveness in meeting retrieval goals (i.e., 99 percent or 99.9 percent with a chemical wash)
- Ability to maneuver around in-tank structures and debris

E.1.2.2.3 Vacuum-Based Retrieval

For purposes of analysis, vacuum-based retrieval (VBR) was assumed for removal of 99 percent of the waste from 200-series SSTs, MUSTs, and WRF tanks. VBR with a chemical wash has been identified for removal of 99.9 percent of the waste from all 200-series SSTs, MUSTs, and WRF tanks.

E.1.2.2.3.1 Technology Description

The following is a description of a typical VBR system that has been used. Actual equipment types, locations, and quantities may vary on a tank-by-tank basis.

E.1.2.2.3.2 Process

VBR uses little liquid and is accomplished using a vacuum system, with air as the conveyance medium. The vacuum system would be deployed on an AMS located in the central region of the tank. The VBR system is essentially an MRS without the ITV.

The AMS has a 4.6-meter (15-foot) reach from the stationary vertical mast. It is thus capable of reaching the entire tank base of 200-series SSTs (6-meter [20-foot] diameter), but only a portion of the tank base of the 100-series SSTs, which have a 22.9-meter (75-foot) internal diameter.

VBR can potentially be used to retrieve 99 percent of the waste from 200-series SSTs, MUSTs, and WRF tanks, and VBR with a chemical wash can potentially be used to retrieve 99.9 percent of the waste from all 200-series SSTs, MUSTs, and WRF tanks.

E.1.2.2.3.3 Facilities

The VBR system was identified for retrieving waste from the 200-series SSTs, MUSTs, and WRFs. The VBR system consists of one primary piece of equipment, the AMS. Additional above-tank support equipment is required for the AMS, including vessel, vacuum, and pump skids and a decontamination unit. The facilities are described in greater detail below. The descriptions for the AMS facilities were derived from the **Waste Retrieval and Storage Data Package** (DOE 2003c). Major equipment required for the VBR system is shown in Figure E-6.

The AMS is a mast-deployed system used to retrieve waste and convey it out of the tank. An extendable articulated arm provides a nominal effective cleaning radius of 4.6 meters (15 feet). A fluid-kinetics-driven unit at the end of the arm dislodges waste and provides sufficient kinetic assist to vacuum-induced forces to draw waste out of the tank.

A waste batch vessel on the vessel skid is connected to the AMS. The vessel is nominally 3,500 liters (925 gallons) in size and can accumulate approximately 3,000 liters (800 gallons) of waste. The waste batch vessel is placed under a vacuum created by the vacuum skid. This vacuum draws waste into the vessel, where the waste is separated from the gas stream. The gas stream continues to the vacuum skid. When the waste batch vessel is full, the waste is conveyed to a receiver tank. Water is mixed with the waste as it is being pumped to achieve a specific target gravity.

Two liquid-ring vacuum pumps are located on the vacuum skid, along with a seal tank. Only one pump is needed to obtain the vacuum needed to retrieve waste from the tank; the second pump provides redundancy. The seal tank collects entrained liquid separated from the gas stream at the pump discharge and supplies sealing liquid (water) for vacuum pump operation.

A booster pump draws the conditioned waste slurry from the vessel skid through an ultrasonic deagglomeration unit. The ultrasonic unit is about 1.8 meters (6 feet) long and is fitted with transducer banks on the outside of the unit. Ultrasonic energy (nominally 30- to 40-kilohertz frequency) is transmitted through the pipe wall to the waste slurry to break the binding force of agglomerated waste particles. Two booster pumps are provided on the skid for redundancy. The nominal operating conditions for a single pump are a pressure of 170 pounds per square inch with a flow rate of 320 liters (85 gallons) per minute. Each pump is nominally capable of producing pressure of 1.72 million pascals (250 pounds per square inch) at the pump outlet.

In-tank video systems are installed to allow tank farm operators to monitor and assess tank retrieval operations and performance.

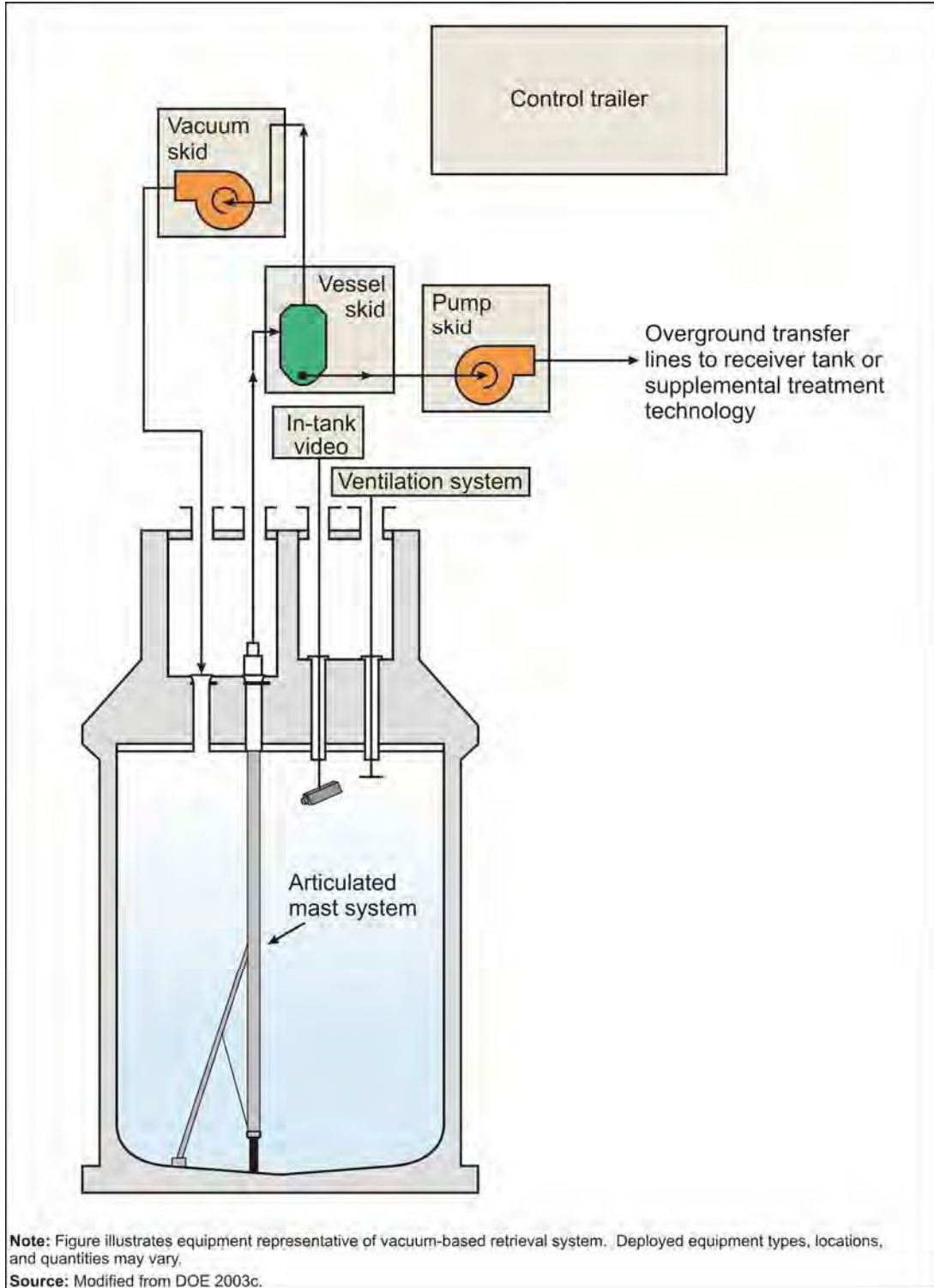

Figure E-6. Vacuum-Based Retrieval System Schematic

The ventilation system maintains the tank at a slightly negative (less than atmospheric) pressure within specified limits during operation. The ventilation system consists of an inlet filter assembly and a portable exhaustor skid that includes HEPA filters, air monitoring/sampling equipment, and associated ductwork. The inlet filter connects to an existing riser on the tank. Collectively, the tank ventilation system performs the following functions:

- Prevents release of airborne radioactive particulates to the environment
- Controls emissions of the air/gas stream before the effluents are discharged to the environment
- Minimizes the amount of condensation in the tank headspace

A control trailer is located near the tank from which waste is retrieved. Operation and monitoring of the system are performed from the control trailer. The closed-circuit television monitors and camera manipulation controls are also located within the control trailer.

Before initiating VBR, proper configuration of all equipment is established. All of the necessary portable equipment and instrumentation are delivered to the tank and set up. Jumpers are set and HIHTL lines are installed (if required) to establish a waste transfer route. The AMS is installed, and the receiving tank is made ready to receive the waste.

E.1.2.2.3.4 Assumptions and Uncertainties

For analysis purposes, it was assumed that the construction, operations, and deactivation impacts assessed for tank 241-C-104 retrieval were representative of the proposed VBR system.

Temporary facilities associated with the VBR system would be moved and reused for four tank retrievals.

VBR has been used on the 241-C-200 series tanks, which are the smaller 208,000-liter-capacity (55,000-gallon-capacity) tanks. VBR has not been used on one of the larger tanks yet. There is uncertainty regarding how VBR would work on a large scale.

The AMS was designed to be inserted into the Hanford tanks through existing penetrations (risers) through the roof of the tank. The only uncertainty associated with implementation of the vacuum system is whether the tanks identified for retrieval using the VBR system would contain available penetrations of an appropriate size to accommodate the system or if new risers would need to be installed. It may be necessary to remove existing equipment from or to install new risers on some tanks to allow installation of the AMS.

The VBR system, as described in this appendix, may have to be adapted to suit various configurations of the MUSTs. The VBR system has been proof-of-principle tested at the Hanford Cold Test Facility (CH2M HILL 2002).

E.1.2.2.4 Chemical Wash System

A chemical wash system has been identified to supplement the MRS and the VBR system to retrieve 99.9 percent of the waste from Hanford tanks. The chemical wash would be conducted after as much waste as technically practical has been removed using those technologies.

E.1.2.2.4.1 Technology Description

The following is a description of a typical chemical wash system. Actual equipment types, locations, and quantities may vary on a tank-by-tank basis.

E.1.2.2.4.2 Process

Chemical washing of internal tank surfaces and equipment is identified for retrieval of residual waste after MRS and VBR system retrieval to meet closure criteria performance objectives. This additional measure may be needed because the other retrieval methods may not directly meet the performance objective, would require significant operational time, or would affect other tank farm operations. For example, the MRS option may not be able to meet performance objectives because in-tank equipment may not allow direct access to some regions within the tank. Specifically, chemical washing is identified for use in conjunction with MRS and VBR system retrieval of 99.9 percent of the waste.

An example of chemical washing is the use of oxalic acid as a solvent for the waste (Sams 2004). Much of the radioactive tank waste was generated from acidic processes; therefore, the use of acids or other chemicals could dissolve the waste into a solution that is more readily removed from the tank. The same methods used to deliver water or waste supernatant into a tank can be used to introduce other chemicals, provided the delivery system's construction materials would not be degraded by the chemical being used. In the same manner, the same equipment used to remove waste by the MRS or VBR can be used to remove the chemical washing solutions if the removal system construction materials are not incompatible with the chemical being used.

The specific chemicals to be used for retrieving residual waste from Hanford tanks would be selected using the following considerations:

- Minimize potential safety impacts (e.g., worker health and nuclear safety)
- Optimize effectiveness in retrieving residual waste
- Optimize compatibility with construction materials for the tank, retrieval system, and waste transfer lines
- Optimize compatibility with the waste materials
- Minimize impacts on downstream waste processing (i.e., vitrification or supplemental treatment processes [STPs])
- Minimize potential for contaminants to be mobilized into the soil column

The chemical wash system can be used to supplement the MRS and the VBR system to retrieve 99.9 percent of the waste from tanks.

E.1.2.2.4.3 Facilities

A chemical addition skid provides structural support, confinement, and leak detection (as required) for the chemical addition manifold (piping, valves, flowmeters, pressure indicators, and various fittings), instrumentation/power enclosures, and pumps. The chemicals would be trucked to Hanford, and the tank on the truck would be used as the primary holding mechanism for the chemical. The chemical (acid or base) would be piped to the chemical addition skid, where it would be pumped to the equipment used to disperse it within the tank.

A chemical manifold would be connected to the chemical truck and piping that runs to the chemical addition skid. Included on the manifold are valves and pressure indicators. The chemical manifold would be equipped with a water flush port to flush the chemical wash system after completion of the chemical addition campaign.

Flexible hoses would be used to provide pathways for the chemical between the chemical truck/tank and chemical addition skid and between the chemical addition skid and retrieval equipment located at the tank.

E.1.2.2.4.4 Assumptions and Uncertainties

For purposes of analysis, it was assumed that chemicals that can effectively clean tanks to the 99.9 percent retrieval goal would also be compatible with safety requirements (e.g., worker health and safety, nuclear safety); construction materials used (e.g., tank liner and retrieval system); tank waste to be treated; and waste feed composition requirements for the WTP or supplemental technologies.

Key uncertainties with chemical washing include chemical compatibility with the DST system, worker safety issues, and waste feed acceptability to the WTP or other solidification technologies.

Chemical (acid) washing in combination with modified sluicing was demonstrated on Hanford SST 241-C-106 from August to December 2003. The objective was to demonstrate 99 percent retrieval of tank waste within acceptable confidence intervals. The results of the demonstration, as reported in **Stage 1 Retrieval Data Report for Single-Shell Tank 241-C-106**, published in May 2004 (Sams 2004), suggest that the combined technologies reached their limit of capability but did not achieve the 99 percent criteria of retrieval, which corresponds to 10.2 cubic meters (360 cubic feet) of remaining tank waste. Based on mass balances, the tank waste remaining was approximately 10.5 cubic meters (370 cubic feet) at the termination of the demonstration. The chemical (oxalic acid) wash was delivered in six stages. After the sixth stage, it was determined that subsequent acid additions would not yield beneficial retrieval of additional tank waste. Chemical (acid) washing has not been demonstrated with MRS or VBR systems at Hanford.

E.1.2.2.5 Leak Detection and Monitoring

Safe retrieval of tank waste would involve use of procedures, technologies, and systems for detecting environmental releases.

The DSTs are designed with multiple systems for detecting leaks from the primary tank. These systems are installed in the annulus of the DST, the space between the primary and secondary tank liners. In addition, the DSTs have leak detection runners and a leak collection sump located in the base of the outer tank to provide additional protection from potential leakage of waste to the soil.

The SSTs were designed with limited capabilities for detecting and monitoring leaks. Because of the physical limitations of the existing tank systems, detection, monitoring, and mitigation of liquid releases from the SSTs during waste retrieval operations would be more difficult. However, equipment and procedures developed for the SST interim stabilization program would be applicable for leak detection and monitoring during SST retrieval operations.

E.1.2.2.5.1 Technology Description

Leak detection and monitoring technologies currently available to support waste retrieval from SSTs include high-resolution resistivity (HRR), dry-well monitoring, chemical process mass balance, and static-liquid-level observation. Performance limitations are associated with each of these technologies, and current plans for near-term waste retrieval include the combined use of all three technologies.

- **High-resolution resistivity.** The HRR leak detection and monitoring system measures changes in the soil resistivity that may occur when conductive tank liquid enters the surrounding soil. Such conductive liquid can alter the current or voltage measured by the HRR leak detection equipment. A resistivity which either decreases or increases with time could result from a

number of factors, one of which is a leaking tank. The system has been used on a number of SSTs starting in 2004 (Schofield 2008).

- **Dry-well monitoring.** All 100-series SSTs are equipped with dry wells, which are vertical pipes placed in the soil around the perimeter of the tank extending downward from grade level to depths of about 23 to 46 meters (75 to 150 feet). These pipes are used for deploying gamma radioactivity monitors and neutron moisture probes to detect any liquid waste that has moved from the tank into the soil surrounding the tank. Some of the earliest leaks from SSTs were detected through routine monitoring of tank farm dry wells.
- **Chemical process mass balance.** During the retrieval operation, the amount of waste removed from a tank and any liquid added to aid retrieval would be compared to the amount of material transferred into the receiver tank. If the amount of waste appearing in the receiver tank were less than the amount of waste retrieved, plus any liquid added, a leak would be suspected. These parameters would be tracked continually during the retrieval operation to warn operations personnel of potential leaks.
- **Static-liquid-level observation.** This can also be used to detect a suspected leak. If all transfers out of and all additions to a tank are halted, the liquid level of that tank is expected to level off and remain unchanged after the liquid level stabilizes. A measurable drop in the liquid level would indicate the possibility of a leak. For example, a liquid-level change of 1.3 centimeters (0.5 inches) in a 100-series tank (22.9-meter [75-foot] diameter) is equivalent to a change in volume of 5,200 liters (1,400 gallons).

E.1.2.2.5.2 Physical Condition of the Single-Shell Tanks

The SSTs were initially constructed at Hanford as early as 1943 to store radioactive waste. The most significant degradation of the physical integrity of the SSTs occurred while the SSTs were in service and receiving waste from processing facilities (1944 to 1980). Some of the failures were attributed to buildup of high-heat sludge, resulting in elevated temperatures at the bottom of the tank. Tank waste temperatures have cooled over the years, and high-heat sludges have been removed from SSTs, making this failure mechanism unlikely.

Stress-corrosion cracking and pitting/crevice corrosion are the failure mechanisms most applicable to the SSTs that have leaked in the past. The rate at which these modes of corrosion may have progressed in nonleaking SSTs is unknown. However, the general condition and age of the SSTs suggest that new SST leaks could occur during retrieval actions that involve additions of liquid to the tanks (DOE 2003c).

The first SSTs known to leak were tanks 241-TY-109 and 241-U-101 in 1959. As analyzed, 67 of Hanford's 149 SSTs are listed as known or suspected leakers. The SSTs were formally removed from service in 1980, but still contain approximately 120 million liters (32 million gallons) of waste. Estimates of total leak volumes from individual SSTs range from approximately 1,140 liters to 1.05 million liters (300 to 277,000 gallons) per tank (Hanlon 2003). Although the RPP plans to minimize introduction of liquids into suspected leakers (utilizing VBR), for the analysis, all tanks were assumed to leak during retrieval. The TWRS EIS (DOE and Ecology 1996) assumed each tank would leak an average of 15,100 liters (4,000 gallons) during SST retrieval. Due to limitations on currently employed leak detection equipment, this assumption was carried forward in this EIS. The leak detection monitoring and mitigation strategy developed for the tank 241-S-112 retrieval demonstration (Hanson 2003) estimated that the best of the three available leak detection methods utilized dry-well gamma logging and neutron soil logging. The 95th percentile upper confidence limit with this method estimated leak detection within a leak volume range from 1,140 to 68,000 liters (300 to 18,000 gallons), depending on where the leak originated in relation to the dry wells. In-tank liquid balance leak detection methods were less sensitive,

ranging from 68,000 to 310,000 liters (18,000 to 82,000 gallons) at the 95th percentile upper confidence limit.

Potential for leakage during retrieval operations would vary based on the height of liquid above potential leak sites (hydrostatic-pressure-driving force) and duration of the retrieval operation.

Technologies to assist in mitigation and improve detection of leakage are currently being evaluated and tested by the RPP. Testing conducted on resistivity-based technologies over a 110-day period in 2003 at the Hanford 105A mock-tank test site provided encouraging data for potential future use of much more sensitive leak detection capabilities (Barnett et al. 2003).

E.1.2.2.5.3 Assumptions and Uncertainties

This TC & WM EIS adopts the assumption that each of the 149 SSTs would leak an average of 15,000 liters (4,000 gallons) to soils surrounding the tank during retrieval operations (see Appendix D, Section D.1.6). It is expected that many of the SSTs would not leak during waste retrieval. However, given the limited sensitivity of some SST leak detection systems, larger leak volumes could occur.

No leakage was assumed to occur from the DSTs during retrieval operations because the DSTs have provisions for leak containment and collection.

Similarly, no leakage was assumed to occur from MUST retrieval operations, which would use the VBR system that employs small volumes of water.

E.1.2.2.6 New Risers

Risers are vertical pipes that extend from aboveground through the dome of the waste tank. Risers of various diameters are used to install pumps, instrumentation, and other equipment in the tanks. New risers may need to be installed on some tanks to provide access for retrieval system equipment. Early SST designs included fewer risers with smaller diameters than newer SSTs and DSTs.

E.1.2.2.6.1 Technology Description

The following is a description of a typical riser installation in a Hanford waste tank. The need for and location of new actual equipment risers on a tank may vary on a tank-by-tank basis.

E.1.2.2.6.2 Process

The process of installing a new riser on a Hanford waste tank involves (1) excavating soil from grade down to the tank dome, (2) core drilling through the dome to install the new riser, and (3) backfilling with clean soil.

E.1.2.2.6.3 Facilities

For each tank from which waste is to be retrieved, existing risers would be checked for size, location, and total number to determine whether they would accommodate required retrieval equipment. As-found equipment in the risers would be evaluated for removal as required. Based on this evaluation, the need for one or more new risers would be determined.

E.1.2.2.6.4 Assumptions and Uncertainties

Uncertainties in the analysis pertaining to new risers include the actual number of new risers that would be required and the specific tanks on which they would be installed.

Uncertainties with the schedule and cost of installing new risers include the degree of soil contamination present at the new riser location and the number and configuration of underground obstructions (e.g., electrical conduits, transfer lines).

E.1.2.2.7 Waste Transfer

This section summarizes approaches for transferring waste between tanks (e.g., from SSTs to DSTs and from DSTs to other DSTs) and from tanks to treatment facilities (e.g., from SSTs, DSTs, and WRFs to treatment facilities).

Existing and future waste transfer approaches are discussed below. Future waste transfer system components include underground piping, HIHTL lines, container transport, and WRFs.

E.1.2.2.7.1 Existing Single-Shell Tank Waste Transfer Systems

None of the existing SST transfer piping would be used because (1) the pipelines are single-wall construction and noncompliant with current regulations; (2) some of the pipelines are plugged; (3) many of the pipelines leak; and (4) the pipelines are up to 60 years old.

E.1.2.2.7.2 Existing Double-Shell Tank Transfer Lines

An existing, extensive system of underground piping connecting the DSTs is operated routinely. This piping would be used for final retrieval of DST waste. In particular, waste removed from DSTs in the 200-West Area would be transferred to selected DSTs in the 200-East Area through the existing underground cross-site transfer system that connects the SY tank farm (in the 200-West Area) with the DSTs in the 200-East Area.

Waste from various DSTs in the 200-East Area would be transferred through existing underground pipelines to DSTs in the AP tank farm, then through a new underground pipeline to the WTP. The DST transfer system would continue to service the DSTs through the end of the mission.

E.1.2.2.7.3 Use of Hose-in-Hose Transfer Lines

The Hanford Site uses an HIHTL configuration placed on or near the surface with appropriate shielding. Interim stabilization project efforts currently use this type of transfer line in addition to double-contained underground transfer lines (DOE 2003c).

E.1.2.2.7.4 Future Waste Transfer System

Existing transfer lines would be used for retrieval of waste from DSTs and WRFs to the extent practicable. Because the DST transfer system would continue to service the DSTs through the end of the mission and the SST transfer system offers limited utility, future transfer system upgrades would be primarily oriented to service the SSTs, through the use of HIHTL.

The two primary methods for transferring tank waste are via pipeline or container transport. The **Tank Waste Technical Options Report** (Boomer et al. 1993) evaluated these two tank waste transfer alternatives. Public health and safety parameters estimated in the report for container transport and pipeline transfer were roughly equivalent. Occupational health and safety impacts and capital operating costs were estimated to be somewhat higher for container transport than for pipeline transport. For purposes of estimating impacts, this **TC & WM EIS** assumed the tank waste would be transferred predominantly by pipeline. Container transport of tank waste may be used selectively.

The VBR system, MRS, and modified sluicing would make extensive use of HIHTL. The MRS and the VBR system previously engineered for tank 241-C-104 include approximately 460 meters (1,500 feet) of

HIHTL; the modified sluicing system for tank 241-S-112 includes approximately 230 meters (750 feet) of HIHTL. These distances of HIHTL were included in all applications of the VBR system, MRS, and modified sluicing. This length of transfer line would be sufficient to transfer waste beyond the tank farm boundary or to nearby supplemental treatment facilities, but would be insufficient to deliver waste to more distant locations (DOE 2003c).

E.1.2.2.7.5 New Underground Transfer Lines

New underground transfer lines would be used to transfer waste beyond the distances that can be reached by HIHTL. The general configuration of the SST farms suggests that the maximum distances for underground transfer lines are from the B tank farm complex to the 200-East Area DSTs and from the T tank farm complex to the 200-West Area DSTs. For the purpose of this analysis, the 200-East Area destination is designated as the “AY/AZ DST farm” because of its location relative to the B tank farm complex. The 200-West Area destination is designated as the “SY DST farm” because it is the only DST farm in the 200-West Area.

E.1.2.2.7.6 Technology Description

New underground transfer lines and associated components (valve pits, diversion boxes, booster pumps, and instrumentation) would be constructed. Transfer lines would be double-walled RCRA-compliant lines.

E.1.2.2.7.7 Process

Processes involved in operating underground waste transfer lines include establishing the desired route (setting valves and jumpers in pits and diversion boxes); pumping waste from the source tank to the receiver tank; recycling supernatant back to the source tank if required; flushing the lines after the waste has been transferred; and verifying the volume transferred by material balance. In addition, monitoring and periodic leak testing of transfer lines would be conducted.

E.1.2.2.7.8 Facilities

Two new transfer line routes are currently planned to connect SST farms to DST farms. One underground transfer line route would originate at the boundary of the T SST farm, be routed past the TX, TY, and U SST farms, and terminate at the SY DST farm (see Figure E-7). The second transfer line route would originate at the boundary of the B SST farm, run beside the C SST farm, and terminate at the 200-East Area DST complex (see Figure E-8). The AY/AZ DST farm is selected for this purpose.

Three transfer lines (one primary transfer, one recycle, and one spare) would be constructed for each route described above. The transfer lines would be double-walled pipe with heat-tracing and leak-detection features. Booster pump stations, access points to leak detection instrumentation, and other equipment would be provided along the transfer route as required. Transfer lines could be constructed on grade and shielded with concrete enclosures or placed in trenches below grade. To provide a conservative estimate of environmental impacts of excavation, it was assumed that transfer lines would be constructed in trenches below grade.



Figure E-7. Future 200-West Area Underground Transfer Line

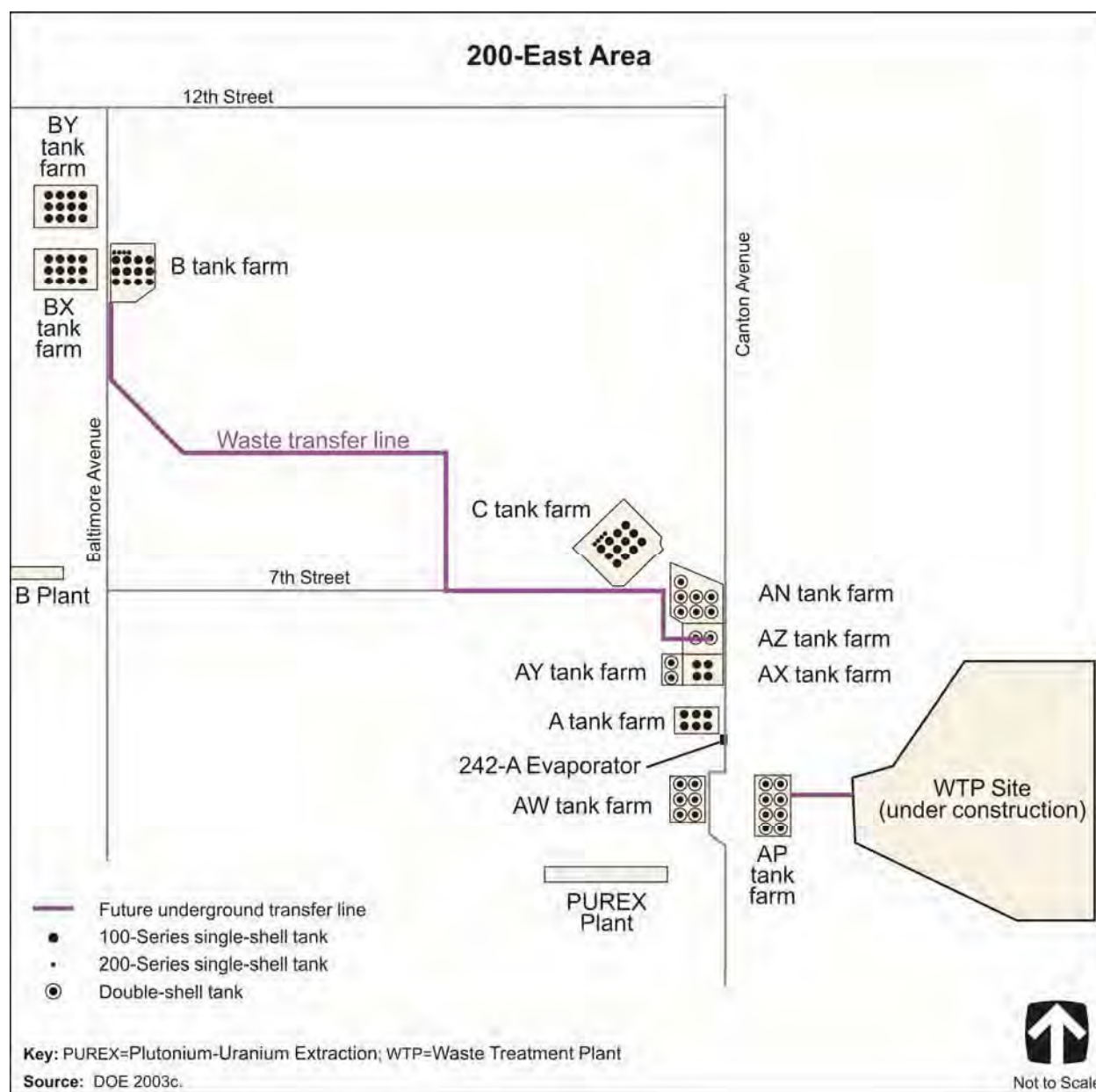

Figure E-8. Future 200-East Area Underground Transfer Line

Following completion of waste retrievals, the underground transfer lines would be left in place. These transfer lines would have been essentially decontaminated during routine waste retrieval and transfer operations through use of routine transfer line flushes. Leaving the lines in place would result in 2,100 meters (7,000 feet) each of primary, recycle, and spare transfer lines from the T tank farm to the SY tank farm and 2,300 meters (7,500 feet) each of primary, recycle, and spare transfer lines between the B tank farm and the AY/AZ tank farms (DOE 2003c).

E.1.2.2.7.9 Assumptions and Uncertainties

For planning purposes, it was assumed that the following constraints apply:

- HIHTL lengths would not exceed those identified for tank 241-C-104 or 241-S-112 retrieval.

- Below-grade waste transfer lines would remain in place at completion of the retrieval activities.
- Existing transfer lines in the northeast (B, BX and BY tank farms) and northwest (T, TX, and TY tank farms) quadrants of the tank farm system can support a maximum of six simultaneous retrievals or transfers in each tank farm and a total of six simultaneous retrievals or transfers in each quadrant.
- For the southwest (S, SX, SY and U tank farms) quadrant, operations would be limited to two simultaneous retrievals or transfers per tank farm and six simultaneous retrievals or transfers per quadrant.
- For the southeast (A, AX, C and DST tank farms) quadrant, the limits would be two simultaneous retrievals or transfers, both of which would be allowable within the same tank farm. A maximum of seven simultaneous transfer operations can be performed, and the waste from up to two SSTs may be transferred into one DST at a time (Hanlon 2003).

The additional underground transfer lines and WRF identified in this TC & WM EIS may not increase the allowable number of simultaneous transfer operations. Process modeling would be used to evaluate applicable constraints on the identified waste transfer system.

E.1.2.2.8 Waste Receiver Facilities

WRFs would facilitate retrieval of waste from SSTs and MUSTs for transfer to the DST system. WRFs may also be used to condition waste from SSTs and DSTs for transfer to waste treatment facilities. WRF construction and operations are analyzed under all Tank Closure alternatives, except 1, 2A, and 6A.

E.1.2.2.8.1 Technology Description

WRFs accumulate waste during retrieval; condition waste by dissolution, dilution, or size reduction of particles; and provide batches of waste for subsequent transfer. The WRFs could also be used to recirculate sluicing liquids back to the SSTs. Not all SST retrievals would necessarily require WRFs.

E.1.2.2.8.2 Process

In the WRFs, waste can be conditioned through dissolution, dilution, and size reduction (of particles suspended in the waste slurry), if necessary. The actual size of the WRFs would vary based on many design considerations. For this EIS, the WRFs analyzed would contain four process cells serviced by an overhead crane. Three of the cells would each contain a 568,000-liter (150,000-gallon) tank and agitator, while the remaining cell would contain transfer pumps and miscellaneous equipment used for waste conditioning and decontamination. Each WRF would also contain an equipment load-out bay and crane maintenance area. Three pipe runs would service each WRF. The two runs that would service the tank farms would include three lines each (one transfer, one recycle, and one spare). The run that would transfer slurry from the WRF to the DSTs or waste treatment facilities would contain two lines (one transfer and one spare) (DOE 2003c).

E.1.2.2.8.3 Facilities

A WRF would have a facility footprint approximately 61 meters long by 15 meters wide (200 feet long by 50 feet wide), with four separate process cells. Operations in each process cell would be conducted remotely (no personnel present during processing). The cell would be serviced by an overhead crane. Each WRF would also have a separate control room for operations personnel, an equipment load-out bay, and a dedicated maintenance area. The tanks, cells, and crane area would be appropriately ventilated. See Figure E-9 for a schematic diagram of a WRF.

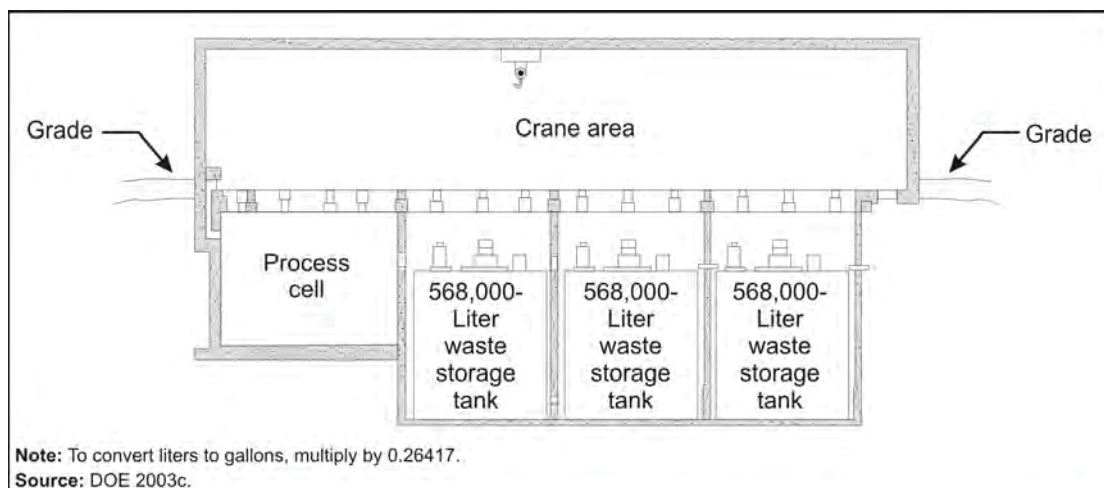

Figure E-9. Waste Receiver Facility Schematic

A waste retrieval and transfer logistical analysis conducted using the Hanford Tank Waste Operation Simulator (HTWOS) model was used as the basis for the number and locations of WRFs required. Four WRFs would be constructed near clusters of SSTs, as follows:

- Adjacent to the B, BX, and BY tank farms in the 200-East Area (WRF-B)
- Between the T and TY tank farms in the 200-West Area (WRF-T)
- Between the U and S tank farms in the 200-West Area (WRF-S)
- Adjacent to the A tank farm in the 200-East Area (WRF-A)

Under alternatives that require WRF construction, this would be integrated with construction of new transfer lines, as discussed in the previous section (DOE 2003c).

E.1.2.2.8.4 Assumptions and Uncertainties

- Uncertainties associated with WRFs are related primarily to the total number of WRFs required, the number of tanks within each WRF, and the size of the tanks within each WRF.
- Four WRFs were assumed to be constructed, with a maximum of three 568,000-liter (150,000-gallon) tanks per WRF.

E.1.2.2.9 Waste Staging for Treatment

Several alternatives considered in this TC & WM EIS require construction of additional storage tanks. Alternative 5 requires the construction of four new DSTs to provide additional storage capacity, while Alternatives 2A and 6A would require replacement of existing DSTs when they reach the end of their useful lives.

E.1.2.2.9.1 Technology Description

All of the alternatives evaluated in this TC & WM EIS require the use of existing storage facilities (with or without modification) to store retrieved tank waste. Alternative 5 requires additional storage capacity, while several other alternatives require replacement of DSTs as they reach the end of their useful lives.

Alternative 5 proposes the use of existing storage facilities that would be modified or supplemented with new waste storage facilities to support near-term retrieval and treatment of tank waste. The storage option selected to support Alternative 5 is the construction of new underground DSTs.

Modification of existing facilities to increase storage space using administrative controls is discussed in Section E.1.2.1.1. Impacts of that option would be less than those of constructing new DSTs.

E.1.2.2.9.2 Process

Retrieval systems for DSTs have been designed and installed in selected DSTs to support waste feed delivery for the WTP. The retrieval systems consist of a combination of mixer and retrieval pumps designed to slurry the contents of the tank and to pump the waste out of the tank into the waste transfer system. Construction, operations, and deactivation impacts of DST retrieval are included for analysis in this EIS.

E.1.2.2.9.3 Facilities

Construction of new DSTs to provide safe storage space for retrieved SST/DST waste was evaluated in the early 1990s as a multifunction waste tank facility project (DOE 2003c). A facility similar to the multifunction facility would be constructed on approximately 10 hectares (24 acres) near the WTP site in the 200-East Area. Electric power, raw water, steam, sanitary water, and process lines would be routed to the site. Discussions in the following sections are based on the multifunction facility design.

New DSTs would be constructed in modules, with four DSTs per module, similar to the multifunction waste tank facility design. Each tank would have a 23-meter (75-foot) internal diameter and a capacity of up to 4.5 million liters (1.2 million gallons). The outer tank would be reinforced concrete that is lined with steel to provide the secondary containment required by DOE directives. The inner tank would be enclosed within the outer tank and separated from the outer tank liner by an annular space where leak detection equipment would be installed (see Figure E-2). The outer tank would serve as secondary containment in the event of a leak from the primary tank liner. In addition, the base of the outer tank would be equipped with leak detection runners leading to a sump for detecting and mitigating possible leakage from the outer tank of a DST.

Each primary tank would be equipped with a transfer pump, and transfer lines would be installed to connect the tank system with the AP tank farm, other tank farms, or the WTP, as required. All transfer lines, process piping, sample lines, and drain lines for tank waste would be encased in secondary piping equipped with leak detection systems (DOE 2003c).

E.1.2.2.9.4 Assumptions and Uncertainties

Construction of new DSTs is technically feasible based on previous design, construction, and operations experience. The approach established here provides a solid technical basis for cost, schedule, and resource estimates.

New DSTs would be constructed in sets of four tanks. Each set of four tanks would require 10 hectares (24 acres) of land.

New DSTs would be constructed of carbon steel. A weather enclosure would not be required.

E.1.2.3 Waste Treatment

This section presents detailed information on the waste treatment technologies identified with the various alternatives considered in this TC & WM EIS. The subsections begin with WTP treatment as currently planned and go on to describe technologies that could be used to expand WTP treatment capacity, particularly for ILAW glass. Following the discussion on WTP activities, several subsections are dedicated to upgrading or replacing facilities that currently support the RPP program. The remaining subsections describe supplemental technologies that could be used either in conjunction with, or separate from, the WTP to accelerate treatment of Hanford tank waste.

The WTP would pretreat and immobilize (by vitrification to borosilicate glass) waste now stored in underground tanks at Hanford. The WTP consists of three individual waste treatment facilities (Pretreatment, HLW Vitrification, and LAW Vitrification), a standalone Analytical Laboratory, and the BOF. Figure E-1 shows the WTP site plot plan with all of the major facilities identified. Figure E-10 shows the interrelationships between the WTP and the supplemental treatment technologies for Hanford tank waste that are evaluated in this TC & WM EIS.

WTP pretreatment is discussed in Section E.1.2.3.1.1; WTP HLW vitrification in Section E.1.2.3.1.2; and WTP LAW vitrification in Section E.1.2.3.1.3.

The following subsections discuss existing treatment facilities that would require upgrading or replacement: 242-A Evaporator (see Section E.1.2.3.2) and LWPFs (see Section E.1.2.3.3).

The following subsections also discuss new supplemental treatment facilities such as the Cesium and Strontium Capsule Processing Facility (see Section E.1.2.3.4); thermal supplemental treatment facilities (see Sections E.1.2.3.6 and E.1.2.3.8); nonthermal supplemental treatment facilities (see Section E.1.2.3.7); the Sulfate Removal Facility (see Section E.1.2.3.9); technetium removal facilities (see Section E.1.2.3.10); and mixed TRU waste processing facilities (see Section E.1.2.3.11). Bulk vitrification and steam reforming are the two representative thermal supplemental treatment technologies, and cast stone is the representative nonthermal supplemental treatment technology analyzed in this EIS.

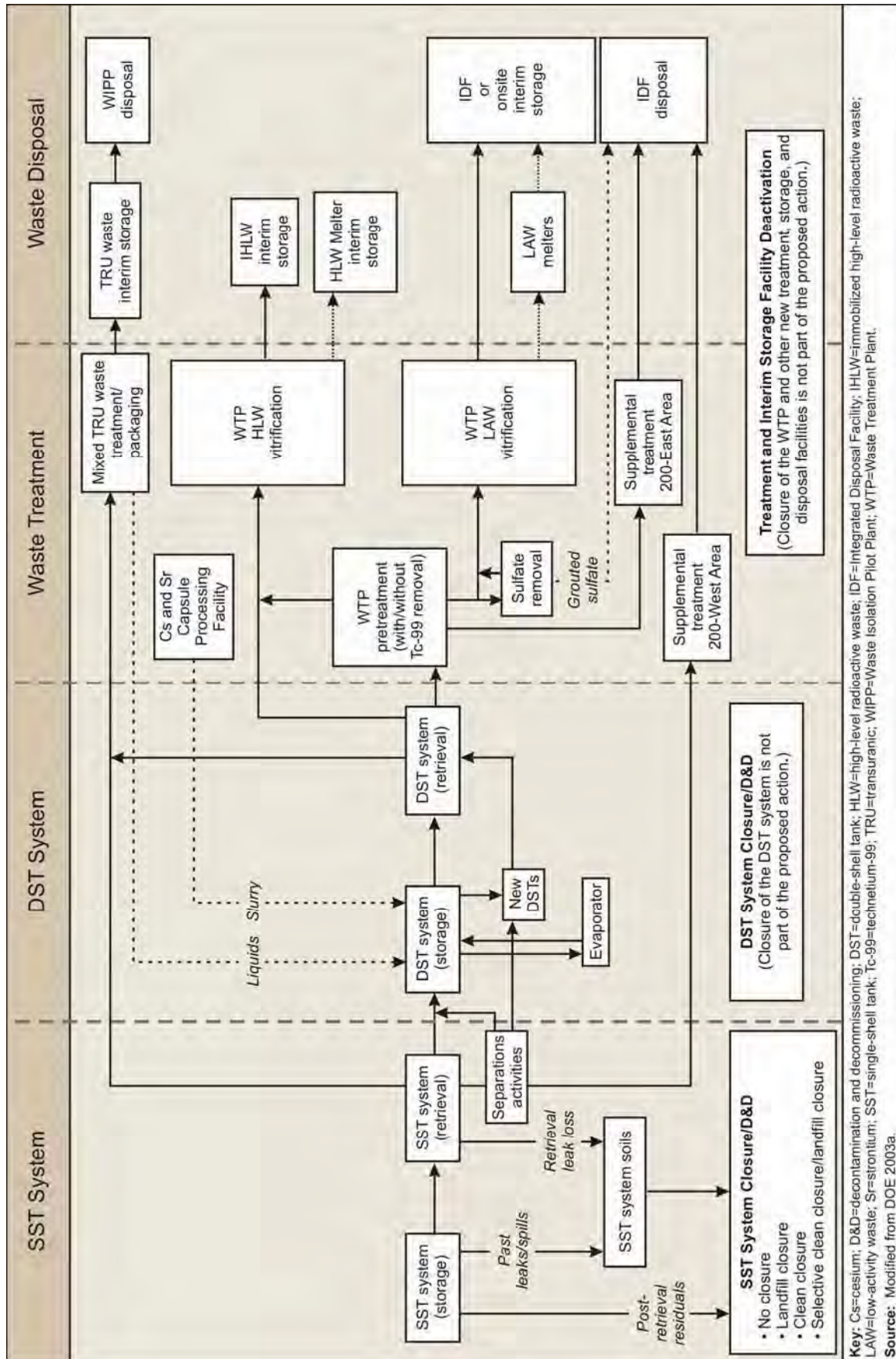

Figure E-10. Relationships Between Waste Treatment Plant Tank Systems and Supplemental Treatment Technologies

The primary waste forms that would be generated by each of the supplemental treatment technologies are also discussed. Further treatment and disposal that may be needed (e.g., liquid effluents) would be accomplished by utilizing existing Hanford treatment and/or disposal facilities (e.g., the LWPFs). Table E-4 provides the technical basis of key features for supplemental technologies.

Table E-4. Basis for Supplemental Treatment Estimates

| Analysis Features | Mixed TRU Waste | Bulk Vitrification | Cast Stone | Steam Reforming | Sulfate Removal |
|---|--|---|---|--|---|
| Facility size and layout | CH-TRU waste procurement specification | Vendor proposal | Existing grout facility modified for containers | Scaled from vendor information on existing commercial facilities | Modified WTP pretreatment process |
| Construction resources | Scaled by ratio of supplemental treatment facility to WTP | Scaled by ratio of supplemental treatment facility to WTP | Scaled by ratio of supplemental treatment facility to WTP | Scaled by ratio of supplemental treatment facility to WTP | Scaled by ratio of supplemental treatment facility to WTP |
| Operations supplies | TRU waste packaging procurement specification (57 liters absorbent per drum) | Target sodium oxide loading in glass, 20 percent by mass | Based on SRS-tested formulation | Based on bench-scale simulant testing at Hazen Research Facility and Idaho National Laboratory | Mass balance calculations |
| Operations staffing | Facility-specific staffing estimate | Facility-specific staffing estimate | Based on grout facility restart estimate | Facility-specific staffing requirement | Facility-specific staffing estimate |
| Waste form characteristics ^a | Dewatered sludge in 0.21-cubic-meter drums | Sodium aluminosilicate glass in 54.3-cubic-meter steel containers | Cast stone in 11.5-cubic-meter steel containers | Mineralized granulated material in 2.25-cubic-meter steel containers | Solidified grout in 3.6-cubic-meter steel containers |

^a Basis for all is material balance calculations.

Note: To convert liters to gallons, multiply by 0.26417; cubic meters to cubic yards, by 1.308.

Key: CH=contact-handled; SRS=Savannah River Site; TRU=transuranic; WTP=Waste Treatment Plant.

Final locations for the supplemental treatment facilities have not been selected. For the purposes of this analysis, representative locations of these facilities in the 200-East and 200-West Areas are shown in Figure E-11. Supplemental treatment facilities would be located south of the WTP in the 200-East Area and in the southeastern portion of the 200-West Area. Figure E-11 also shows locations of the mobile Contact-Handled (CH)-Mixed TRU Waste Facilities. The two mobile packaging units may require up to three locations in the 200-West Area and one location in the 200-East Area. The Remote-Handled (RH)-Mixed TRU Waste Facility would be located in the southeastern portion of the 200-East Area, near the AP tank farm.

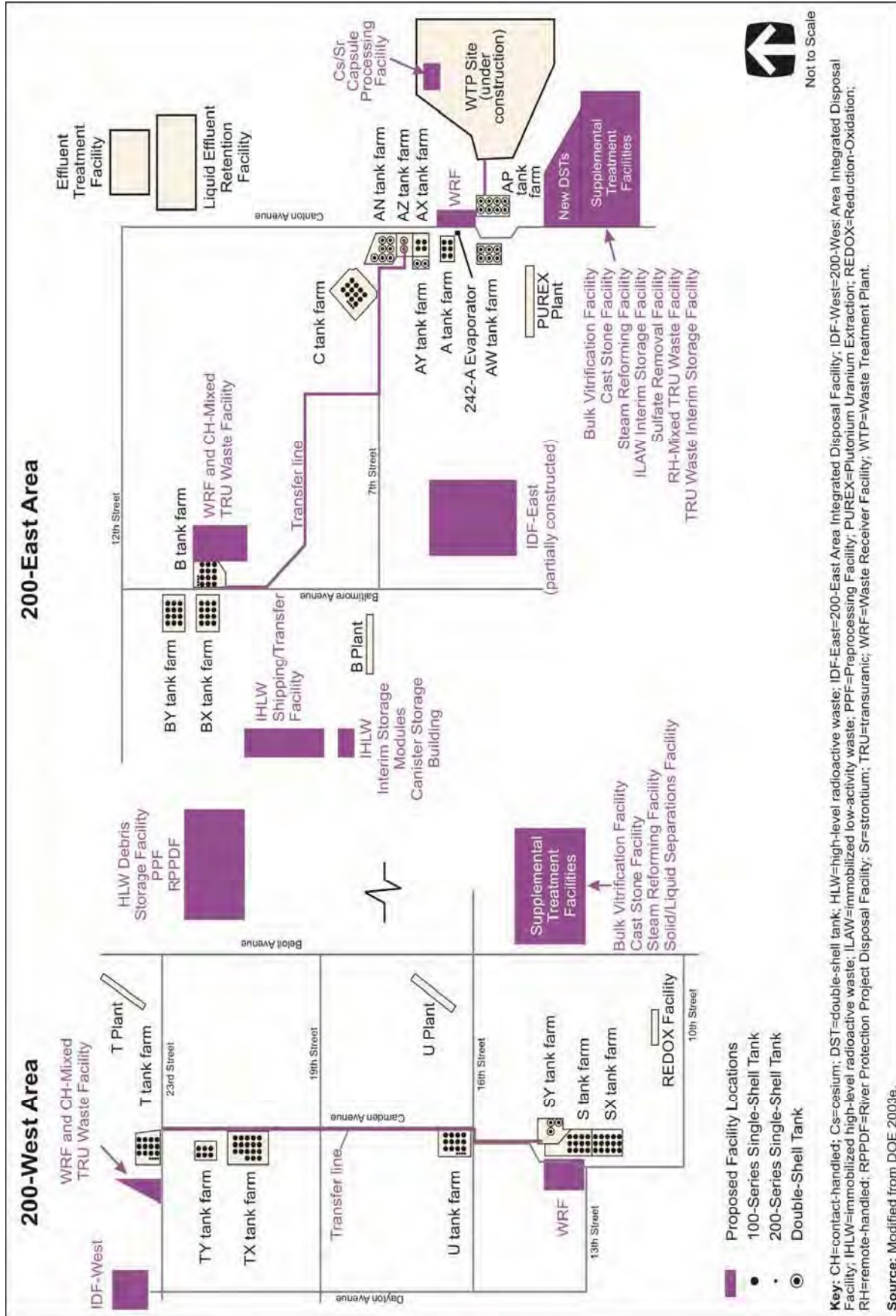

Figure E-11. Proposed Locations of Core Zone Facilities

The current approach to waste immobilization at Hanford uses borosilicate glass produced in joule-heated melters. Possible improvements in glass formulation and enhancements to the melter technology could be used in conjunction with the currently planned approach. These enhancements could increase waste loadings, increase throughput, or otherwise lead to cost reduction and schedule improvement. DOE conducted a technical review of alternatives for vitrification of Hanford tank waste that could achieve cost reductions within reasonable long-term program risks. Enhancements to the waste forms that may allow troublesome chemical constituents to be incorporated include adjustments to the formulations and establishment of acceptable limits of crystalline phases in the waste glass (DOE 2003e).

Melter technology improvements to increase waste loading, melting rate, and predictability of processing are being sought. Enhancements to the existing joule-heated ceramic melter technology include forced convection, higher operating temperatures, and configuration changes to increase tolerance for accumulation of crystals in the melter.

E.1.2.3.1 Waste Treatment Plant

The WTP, currently under construction, would be a new facility on Hanford property owned by DOE. The site lies at the eastern end of the 200-East Area of Hanford. The WTP is designed to accommodate a TMC of 6 metric tons of glass IHLW per day and 30 metric tons of glass ILAW per day by the employment of two HLW melters and two LAW melters.

The WTP would be constructed, permitted, and operated to treat radioactively contaminated dangerous waste stored at Hanford and managed by the Office of River Protection (ORP).

The WTP would include three primary processing facilities: Pretreatment, LAW Vitrification, and HLW Vitrification. These facilities would be supported by the Analytical Laboratory and the BOF. The WTP would have a 40-year design life. Under Tank Closure Alternatives 2A and 6A (Base and Option Cases), replacement of the WTP would be required because the estimated operational life of the facility would be exceeded. For analysis purposes, it was assumed that replacement of the WTP would be required after 60 years of operation. This time period assumes a 20-year period of life extension activities which would extend the 40-year design life. Therefore, Tank Closure Alternative 2A would require one WTP replacement, and Tank Closure Alternative 6A would require two WTP replacements. These replacement facilities would be located adjacent to the WTP currently under construction.

PROCESS OVERVIEW

The following discussion presents an overview of the facilities, laboratory, and BOF systems at the WTP. Figure E-1 is a graphic representation of the WTP site showing the facilities' locations.

The WTP would receive waste from the DSTs in batches. The waste feed solutions and slurries would be transferred by pipeline to the WTP for pretreatment and immobilization by vitrification. The pretreatment process is designed to separate the solid and liquid fractions of the waste, wash and/or leach the solids to remove chemical constituents that drive the total IHLW glass volume, and remove selected radionuclides from the liquid portion of the waste. The pretreated liquid waste would be routed to the LAW Vitrification Facility; the pretreated solids and separated radionuclides would be routed to the HLW Vitrification Facility.

In the vitrification facilities, pretreated tank waste would be combined with glass-forming materials and melted at high temperatures to form a liquid that would be poured into stainless steel containers. After the glass cools and hardens, the containers would be sealed and decontaminated in preparation for storage and permanent disposal. Dangerous waste and radioactive constituents in the waste would be either removed or immobilized in the durable glass matrix as a result of the vitrification process. The offgas from the processes would be treated to a level that protects human health and the environment.

During routine operation of the WTP, miscellaneous wastes such as used equipment, laboratory waste, and other chemically and radiologically contaminated materials would be generated. This newly generated waste is referred to as “secondary waste.” Secondary waste would be transferred to accumulation or storage facilities at the WTP and then either transferred to Hanford facilities or transferred off Hanford, as appropriate. Nonradioactive dangerous waste may also be generated by operations, laboratory, and maintenance activities. This waste would be managed at the WTP until it can be transferred to a permitted disposal facility.

A simplified block flow diagram of the WTP process appears in Figure E-12.

The pretreatment process divides waste feeds into LAW and HLW streams. The LAW stream would consist primarily of salt solutions with much of the radioactivity removed. The HLW stream would consist primarily of solids separated from the tank waste and selected radioactive components that would be removed from the aqueous LAW stream. The LAW vitrification process would immobilize the pretreated LAW component, producing a vitrified product known as ILAW glass. The HLW vitrification process would immobilize the pretreated HLW component, producing a vitrified product known as IHLW glass. Offgas generated by the individual processes would be treated by the offgas treatment systems.

Waste would be transferred from the DSTs in batches through double-walled pipelines to the WTP waste receipt tanks. HLW solids, strontium, TRU waste compounds, and cesium would be separated from the waste feed by ultrafiltration, precipitation, and ion exchange processes. The pretreated HLW solids and separated radionuclides would be blended and transferred to the HLW Vitrification Facility as pretreated HLW feed. The pretreated supernatant and permeate from the separations processes would be transferred to the LAW Vitrification Facility as pretreated LAW feed.

The LAW vitrification process would immobilize the pretreated LAW component by first adding glass-forming materials to the pretreated LAW feed, then vitrifying the mixture in a joule-heated, ceramic-lined melter. Similarly, the HLW vitrification process would immobilize the pretreated HLW component by adding glass-forming materials to the pretreated HLW feed, then vitrifying the mixture in a joule-heated, ceramic-lined melter. The molten glass products (ILAW and IHLW) would be poured from the melters into stainless steel containers and allowed to cool and solidify. The containers would then be sealed, decontaminated, and transferred to either an Integrated Disposal Facility (IDF) (ILAW glass only) or the IHLW Interim Storage Modules.

Detailed process descriptions provided in the following section are based on process descriptions presented in the **No Action Baseline Tank Farm Operations and Waste Treatment Data Package** (DOE 2003a) and the **Flowsheet Bases, Assumptions, and Requirements** document (BNI 2005).

E.1.2.3.1.1 Waste Treatment Plant Pretreatment

The pretreatment process involves operations for pretreating tank waste before immobilization. The major types of tank waste are differentiated into waste envelopes based on chemical characteristics and are designated as “Envelopes A, B, C, and D.” Descriptions of these waste envelopes are provided below.

- **Envelope A.** This waste envelope constitutes the largest volume of the LAW to be treated, has a nominal concentration of 6- to 8-molar sodium, and contains radioactive cesium at concentrations high enough to warrant its removal prior to vitrification.
- **Envelope B.** This waste envelope is a small-volume feed stream similar to Envelope A, except that it contains higher concentrations of compounds that limit waste loading in the glass (such as sulfates) and has a nominal concentration of 2- to 4-molar sodium. This waste envelope also contains higher concentrations of radioactive cesium than Envelope A. Radioactive cesium is present at concentrations sufficient to warrant its removal prior to vitrification.

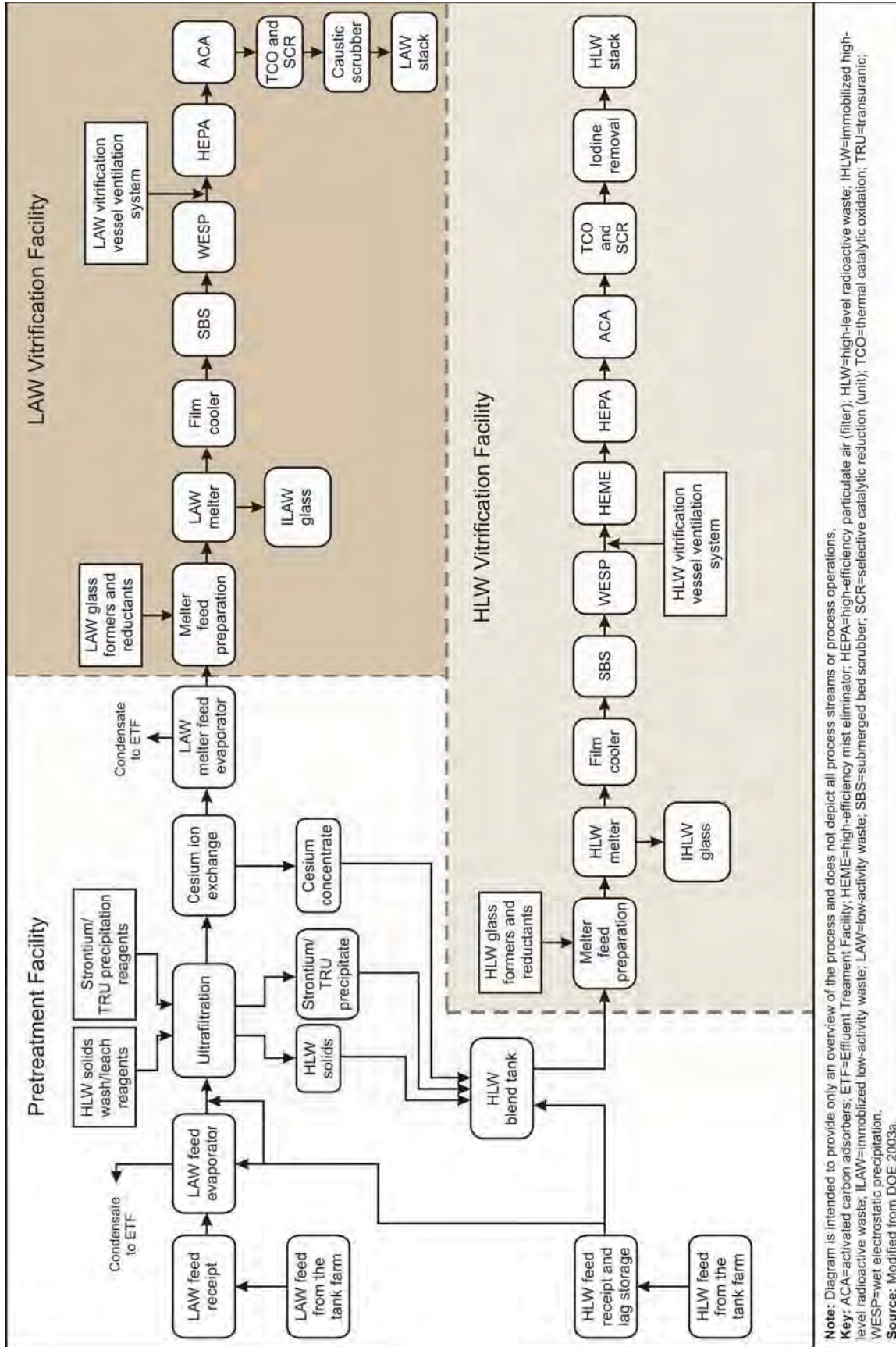

Figure E-12. Simplified Block Flow Diagram of the Current Waste Treatment Process

**Draft Tank Closure and Waste Management Environmental Impact Statement for the
Hanford Site, Richland, Washington**

- **Envelope C.** This waste envelope has a nominal concentration of 6- to 8-molar sodium, but contains organic compounds that can hold strontium and TRU waste components in solution. This waste would require treatment (e.g., precipitation) to remove both the strontium and TRU waste components. As with Envelopes A and B, radioactive cesium is present at concentrations sufficient to warrant its removal prior to vitrification.
- **Envelope D.** This waste envelope represents the undissolved solids from the tank waste and contains approximately 10 to 200 grams (0.35 to 7 ounces) of unwashed solids per liter.

In general, Envelopes A, B, and C consist of the supernatant portion of the tank waste and make up the LAW feed to pretreatment. Envelope D consists of the undissolved solids portion of the tank waste and makes up the HLW feed to pretreatment. LAW feeds (Envelopes A, B, and C) would be transferred to the WTP as concentrated solutions that contain up to 2 weight-percent entrained solids.

The pretreatment process has a TMC of 2,950 metric tons of sodium per year to support LAW vitrification and sufficient solids processing capacity to support 6 metric tons of glass per day for HLW vitrification.

The initial step in the pretreatment of LAW would be evaporation of dilute feeds, or dilution of concentrated feeds, to approximately 5-molar sodium concentration. This would dissolve soluble salts and prepare the feed for subsequent processing. From there, the waste would go through the following processes:

- Envelope A and B feeds would be blended with HLW feeds (Envelope D) in an ultrafilter preparation tank and then filtered through an ultrafiltration system to remove any entrained solids. The LAW permeate (liquid stream) would be processed through the cesium ion exchange process, and the concentrated solids slurry would be caustic-leached (if warranted), washed, oxidative-leached (if warranted), washed, and blended with cesium concentrate from the ion exchange and strontium and TRU waste solids from the strontium/TRU waste precipitation process. The entrained solids would be stored before HLW vitrification and the LAW permeate would be stored before LAW vitrification (BNI 2005).
- Envelope C feeds contain organic complexants that cause the strontium and some TRU waste to remain in solution. This waste would undergo a strontium/TRU waste precipitation process before filtration. The filtration step would separate the strontium/TRU waste solids, manganese oxide and entrained solids from the LAW permeate. The strontium/TRU waste precipitate would be washed and stored for blending with HLW feed before HLW vitrification. The strontium/TRU waste precipitate would not be caustic-leached. Envelope C permeates would be processed through the cesium ion exchange process (BNI 2005).
- After filtration, the LAW permeate undergoes cesium ion-exchange processing and the cesium eluate concentrated by evaporation and then blended with pretreated HLW solids before transfer to the HLW vitrification process. The last step in the Pretreatment Facility process would be to concentrate the treated LAW liquid by evaporation before transferring the waste to the LAW vitrification process (BNI 2005).

Radioactive or dangerous waste liquid effluents would be either recycled in pretreatment or sent to the ETF.

PRETREATMENT FACILITY

The Pretreatment Facility would contain the equipment necessary for preparing the LAW and HLW feeds for vitrification. The Pretreatment Facility would also contain the equipment to receive waste transfers

from the Hanford tank farms, including receipt tanks that can hold a total of 5.8 million liters (1.5 million gallons).

The building ventilation system would be designed to cascade the supply air from areas with low potential for contamination into areas with high potential for contamination. The ventilation discharge from the high-contamination areas would then be filtered before release. A completely separate system would vent the process tanks and vessels.

The structure of the Pretreatment Facility would be supported by a reinforced-concrete foundation. The superstructure would be constructed of structural steelwork with external metal siding and a metal roof. The process cells within the Pretreatment Facility would be constructed of reinforced concrete to protect facility operators from radiation and to ensure facility containment in a post seismic or design-basis event. The cell floors and a portion of the cell walls would be lined with stainless steel to provide a surface capable of life-long decontamination and to provide a tank leaks barrier for the process tanks.

The Pretreatment Facility was originally designed to remove technetium. Based on reviews of technetium-99 in ILAW glass, DOE and Washington State Department of Ecology (Ecology) agreed to delete technetium removal from the WTP permit (Hedges 2008). Construction of the Pretreatment Facility to date has eliminated the capability to remove technetium from the LAW stream. This **TC & WM EIS** assumes that technetium-99 removal could be completed in the existing Pretreatment Facility and analyzes it under Tank Closure Alternatives 2B and 3B. Design and construction modifications would need to be made to add the technetium-99 removal capability for these alternatives. Section E.1.2.3.10 has additional information on technetium removal within the WTP.

E.1.2.3.1.2 Waste Treatment Plant High-Level Radioactive Waste Vitrification

The baseline HLW vitrification process consists of two melter systems operated in parallel. Each melter system would be equipped with feed preparation vessels; a joule-heated, ceramic-lined melter; a canister-filling system; and primary offgas treatment. These systems would be supported by HLW melter feed vessel, canister welding and decontamination systems, a condensate collection and recycle system, and secondary offgas treatment.

HLW feed concentrate would be transferred from the Pretreatment Facility to the HLW melter feed vessel. The feed would be blended with glass-forming chemicals and other additives and mixed to maintain the solids in suspension. The melter-feed slurry would then be transferred to the melter-feed vessels that provide continuous feed to the HLW melters.

The melter feed would be introduced at the top of the melter and would form a “cold cap” above the surface of the melt pool. The melt pool would be maintained at a temperature of approximately 1,050 to 1,150 degrees Celsius (°C) (1,900 to 2,100 degrees Fahrenheit [°F]). Water and volatile components in the feed would evaporate or decompose. The volatile components would be drawn off through the melter offgas system. Nonvolatile components would undergo chemical reactions to form oxides, which would then dissolve in the glass melt. The glass pool would be agitated to improve heat transfer and thereby increase the glass production rate.

HLW glass would be poured into stainless steel canisters (0.6 meters in diameter by 4.6 meters high [2 feet in diameter by 15 feet high]) by means of an airlift system inside the melter. The glass would be poured in a series of “lifts” (layers) over a period of approximately 2 days for each canister. An infrared level detector would monitor the fill height of glass in the canister. Each canister would hold approximately 3.2 metric tons of glass IHLW (assuming the use of the “thin-wall” canister). After filling, the canister would be removed from the melter pour station and allowed to cool sufficiently to allow subsequent handling.

The filled canister would be transferred to a station within the facility, where it would be inspected and prepared for sealing. A lid would be welded to the top of the canister using a remotely operated, automated welding process. The IHLW glass canister would be decontaminated using a nitric acid/cerium (IV) chemical milling process to remove a thin layer of the canister outer wall material and any contaminants adhering to it. The decontaminated canister would be swabbed remotely to confirm that any remaining removable contamination would be below specification limits. Canisters that meet waste acceptance technical requirements for DOE's Civilian Radioactive Waste Management System (DOE 2007) would be transferred to the onsite IHLW Interim Storage Modules.

Each HLW melter would have a dedicated primary offgas treatment system, including a film cooler, submerged bed scrubber, wet electrostatic precipitator, high-efficiency mist eliminator, and HEPA filters to remove particulates and condensables, including entrained or volatilized radionuclides, from the melter offgas. Condensate from the scrubbers would be collected in the liquid effluent system and recycled to the Pretreatment Facility along with the neutralized canister decontamination solution.

After the primary offgas treatment system, the offgas would be routed to a secondary offgas system. The secondary offgas system would destroy organics, reduce nitrogen oxides, and remove halides and mercury. The major system components would include a thermal catalytic oxidizer (oxidizes volatile organic compounds [VOCs]); selective catalytic reducer (converts nitrogen oxides to nitrogen and water); silver mordenite column (removes iodine-129 and volatile compounds); and sulfur-impregnated activated carbon bed (mercury removal) (BNI 2005).

Each HLW melter would have a TMC of 3 metric tons of glass per day IHLW, or a total of 6 metric tons of glass per day IHLW for the two melters combined. The actual glass production rates would be somewhat lower based on the operating efficiency of each facility. The operating efficiency of the Pretreatment Facility is included in this analysis because the availability of pretreated waste feed is an important factor in determining overall plant operating efficiency.

The analyses assumed there would be sufficient overall availability to support a throughput per HLW melter of 2.5 metric tons of glass per day IHLW, or a combined total of 5 metric tons of glass per day IHLW for two melters, for a total operating efficiency (TOE) of 83 percent (DOE 2003e). The total amount of IHLW glass produced and the duration of the processing campaigns to treat all retrieved waste would vary based on the alternatives.

HIGH-LEVEL RADIOACTIVE WASTE VITRIFICATION FACILITY

The HLW Vitrification Facility would house all of the processing systems and equipment for producing IHLW glass from pretreated HLW feed. The HLW Vitrification Facility would be designed for remote maintenance of contaminated equipment.

The building ventilation system would be designed to cascade the supply air from areas with low potential for contamination into areas with a higher potential for contamination. The ventilation discharge for the contaminated areas would be filtered before release.

The HLW Vitrification Facility is constructed of reinforced concrete and structural steel. The below-grade portions, structural walls, process areas and radiation areas are constructed from reinforced concrete. The superstructure is made of structural steel with external metal siding and a metal roof. Facility structural appendages are supported by reinforced concrete foundations.

The process cells within the HLW Vitrification Facility are being constructed of reinforced concrete to protect facility workers from radiation. The cell floors and a portion of the walls are being lined with stainless steel capable of life-long decontamination. The cell liners also act as secondary containment, providing a barrier for potential leakage from process tanks and equipment. The HLW Vitrification

Facility is designed to allow replacement of the melters, which have an expected service life of 5 years each.

E.1.2.3.1.3 Waste Treatment Plant Low-Activity Waste Vitrification

The baseline WTP LAW vitrification process would consist of two large-scale melter systems operated in parallel. Each melter system would have a set of feed-preparation vessels; a large-capacity, joule-heated, locally shielded, ceramic melter; an ILAW-product container-filling system; and a primary offgas treatment system. The following description applies to each of the LAW melter systems.

Pretreated LAW feeds would be received into one of two common LAW concentrate-receipt vessels inside the LAW vitrification building. Batches of concentrated LAW feed would be transferred from these vessels to melter feed preparation vessels, where glass formers would be added and blended to maintain the solids in suspension. The melter feed would be a slurry and would be continuously agitated. The slurry feed would then be transferred to the melter feed vessels, where it would be fed continuously to the LAW melters.

The melter feed would enter the melter from the top and form a cold cap above the melt pool. The melt pool would be maintained at a temperature of approximately 1,050 to 1,150 °C (1,900 to 2,100 °F). Water and volatile components present in the feed would evaporate or decompose. The volatile components would be drawn off through the melter offgas treatment system. The nonvolatile components would undergo chemical reactions to form oxides or other compounds that dissolve in the glass melt. Bubblers would be used to agitate the glass pool to improve heat transfer and thereby increase the glass production rate. The glass would be poured from the melter by an airlift system into stainless steel containers 1.22 meters in diameter by 2.3 meters high (4 feet in diameter by 7.5 feet high). Each container would hold approximately 6 metric tons of glass ILAW.

After being filled, each ILAW glass container would be allowed to cool before being sealed and decontaminated. Samples of the ILAW glass would be taken as required and analyzed to confirm that the ILAW glass meets specifications. Inert fill would be added, if necessary. A lid would be attached to the top of the container using equipment remotely operated from outside the cell. External contamination would be removed using a carbon dioxide pellet decontamination process. A remote-controlled container swabbing system would be used to confirm that residual surface contamination levels are below limits for transport to the disposal site. Sealed and decontaminated containers of ILAW glass would then be loaded on transporters for transfer to an IDF.

Each LAW melter system would be equipped with its own primary offgas equipment, including a film cooler, submerged bed scrubber, and wet electrostatic precipitator. Particulates and condensables, including radionuclides volatilized or entrained in the melter offgas stream, would be captured in the submerged bed scrubber and wet electrostatic precipitator. Condensate from the scrubber and the precipitator would be collected in the liquid effluent system and recycled to the Pretreatment Facility.

The offgas from the primary offgas treatment systems would be combined with offgas from the vessel ventilation system and passed through a secondary offgas treatment system. The secondary offgas treatment system would provide final filtration, destroy organics, reduce nitrogen oxides, and remove halides and mercury. This would be accomplished by using HEPA filters; activated carbon adsorbers (mercury, halides and acid gases, including iodine-129); a catalyst skid (to remove nitrogen oxides, carbon monoxide, and VOCs); thermal catalytic oxidizers (to oxidize VOCs and carbon monoxide to carbon dioxide and water); a selective catalytic reducer (to reduce nitrogen oxides in offgas to nitrogen and water); and a caustic scrubber (to remove acid gases such as sulfur dioxides) (BNI 2005).

Each LAW melter would have a TMC of 15 metric tons of glass per day ILAW, or a total of 30 metric tons of glass per day ILAW for the two melters. The actual glass production rates would be somewhat

lower based on the operating efficiency of each facility. The operating efficiency of the Pretreatment Facility is included in this analysis because the availability of pretreated waste feed is an important factor in determining overall plant operating efficiency.

The analyses assumed there would be sufficient overall availability to support a throughput per LAW melter of 10.7 metric tons of glass per day ILAW, or a total of 21.4 metric tons of glass per day ILAW for two melters, 32.1 metric tons of glass per day ILAW for three melters, and 64.2 metric tons of glass per day ILAW for six melters, for a TOE of 71 percent (DOE 2003e). The total amount of ILAW glass produced and the duration of the processing campaigns to treat all retrieved waste would vary based on the alternatives for which these options are used. Total ILAW glass production in the WTP is addressed in Section E.1.2.4.

LOW-ACTIVITY WASTE VITRIFICATION FACILITY

The WTP LAW Vitrification Facility would house all of the processing systems and equipment for production of ILAW glass from pretreated LAW feed. The LAW feed receipt and melter feed preparation vessels would be located within a shielded concrete cell lined with stainless steel for containment and ease of decontamination. The vitrification portion of the facility would be designed to facilitate local melter maintenance and reduce reliance on remote maintenance operations. Each melter would be equipped with a steel shielding box. The locally shielded melters would be located in a large melter gallery area. This arrangement allows operators to perform routine maintenance (such as bubbler-tube replacement) locally, using specially designed maintenance equipment to control contamination spread and worker exposure. Along with this melter confinement design, the glass-pour cell arrangement would be designed to provide a container turntable and a container elevator system to place containers in position for glass filling. This approach would provide the needed residence time for container cooling and improve container contamination control.

The building ventilation system is designed to cascade the supply air from areas with a low potential for contamination into areas with a higher potential for contamination. The ventilation discharge for the contaminated areas would then be filtered before release.

The LAW Vitrification Facility building is constructed of reinforced concrete and structural steel. The below-grade portion of the building structure is reinforced concrete, and the superstructure is made of reinforced concrete and structural steel with exterior metal siding and a metal roof. The facility appendage structure is supported by reinforced concrete foundations.

The process cells within the LAW Vitrification Facility are constructed of reinforced concrete to protect facility operators from radiation. A protective coating is being applied to the concrete floor and walls of the LAW melter gallery to aid in decontamination activities, if necessary. The cell and cave floors and a portion of the walls are being lined with stainless steel capable of life-long decontamination to provide a leakage barrier for the process tanks. The LAW Vitrification Facility is designed to allow periodic replacement of the melters, which is expected every 5 years.

E.1.2.3.1.4 Expanded Low-Activity Waste Vitrification

The LAW Vitrification Facility was originally designed to produce 30 metric tons of glass ILAW using three melters. Improvements in melter technology have demonstrated a 30-metric-ton-of-glass-per-day vitrification capacity can be achieved with two melters. Construction of the LAW Vitrification Facility is proceeding with two melters with a TMC of 30 metric tons of glass per day ILAW.

Additional LAW vitrification capacity needed to accelerate treatment of the tank waste is addressed under two alternatives in this **TC & WM EIS**. The first alternative is the installation of additional melter capacity in the existing LAW Vitrification Facility currently under construction as part of the WTP,

bringing the total design capacity from a TMC of 30 metric tons of glass per day to a TMC of 45 metric tons of glass per day ILAW (Tank Closure Alternative 5). The installation of additional melter capacity in the existing LAW Vitrification Facility, though technically possible, would require design modifications for additional infrastructure tie-ins. The second alternative includes the installation of this additional melter capacity in the existing LAW Vitrification Facility, as well as construction of a second LAW Vitrification Facility, for a TMC of 90 metric tons of glass per day ILAW (Tank Closure Alternatives 2B, 6B, and 6C).

Note that these alternatives are described in terms of their TMC. For the purpose of analysis, this TC & WM EIS assumes a nominal throughput rate of 10.7 metric tons of glass per day ILAW for one LAW melter and 21.4 metric tons of glass per day ILAW for two melters combined.

The LAW vitrification process description for expanded WTP LAW vitrification would essentially be the same as that for the currently planned LAW vitrification process. However, expanded LAW vitrification would require pretreatment to operate at or near its design capacity, which, in turn, means the facility would have a high TOE. This could be accomplished by fully utilizing available processing capacity, reducing sampling and analysis requirements, and minimizing downtime for maintenance and repairs.

The waste treatment processing timeframes are based on a 14 weight-percent sodium oxide loading in the ILAW glass, assuming the same nonwaste sodium additions as indicated in the **Waste Treatment and Supplemental Technology Data Package** (DOE 2003e), i.e., a maximum of 11,500 metric tons of nonwaste sodium additions. It is important to note that the quantity of nonwaste sodium added during pretreatment (e.g., from caustic leaching of HLW solids) would affect the total quantity of containers of ILAW glass produced. In addition, the quantity of sulfate present in the LAW feed relative to sodium could reduce the allowable sodium oxide loading in the glass. Thus, combining expanded LAW vitrification with supplemental treatment technology such as sulfate removal could reduce both the amount of ILAW glass produced and the processing time required to treat all of the retrieved waste. Section E.1.2.3.1.7 discusses WTP assumptions and uncertainties.

EXPANDED LOW-ACTIVITY WASTE VITRIFICATION FACILITIES

A second LAW Vitrification Facility of the same basic design as the currently planned LAW Vitrification Facility would be constructed on unoccupied land within the WTP complex. A location adjacent to the Pretreatment Facility and critical support facilities is preferred. Each LAW Vitrification Facility would receive pretreated LAW from the WTP Pretreatment Facility. Each facility would be supported by the Analytical Laboratory, as well as systems and utilities from the support infrastructure (the BOF). Each facility would have a 40-year design life.

E.1.2.3.1.5 Waste Forms/Disposal Packages

The vitrified IHLW form would consist of borosilicate glass in a sealed and decontaminated stainless steel canister. The glass would be poured from the melter by means of an airlift system into stainless steel canisters 0.6 meters in diameter by 4.6 meters high (2 feet in diameter by 15 feet high). Each canister would hold approximately 3.2 metric tons of IHLW product.

The vitrified ILAW form would consist of borosilicate glass in a sealed and decontaminated stainless steel container. The glass would be poured from the melter by means of an airlift system into stainless steel containers 1.2 meters in diameter by 2.3 meters high (4 feet in diameter by 7.5 feet high). Each container would hold approximately 6 metric tons of ILAW products.

PRIMARY WASTE

The primary waste streams would follow two distinct pathways. The IHLW glass (as vitrified by the WTP) would be stored on site until disposition decisions are made and implemented. Section E.1.2.4 discusses the post-treatment storage and disposal and product performance characteristics for the IHLW product.

ILAW glass (as vitrified by the WTP) would be disposed of on site except under Tank Closure Alternatives 6B and 6C, wherein the ILAW glass would be managed as HLW. Section E.1.2.4 discusses the disposal options and product performance characteristics for the ILAW glass, as well as the quantities of primary waste generated by the WTP under the various alternatives analyzed.

WASTE FORM PERFORMANCE

The DOE Office of Civilian Radioactive Waste Management has established the performance requirement for IHLW. The chemical durability (i.e., leach resistance) of the IHLW glass must be equal to or better than that for the reference glass. The reference glass is borosilicate glass prepared in support of the **Defense Waste Processing Facility Environmental Assessment** and is commonly referred to as “Savannah River EA [environmental assessment] glass” (DOE 2007).

The long-term impacts of ILAW glass disposal were analyzed in the **Hanford Immobilized Low-Activity Waste Performance Assessment: 2001 Version** (Mann et al. 2001). This document was reviewed by the Ecology and approved by DOE Headquarters. A wide variety of cases was analyzed.

The rate of release of hazardous constituents depends strongly on the nature of the waste form used to immobilize the constituents. The nature of the waste forms, analysis for long-term performance assessment, and methods used to estimate release rates and values of parameters characterizing release rates from the ILAW glass are presented in Appendix M.

SECONDARY SOLID WASTE

Secondary solid waste would be generated by the WTP in every area where waste processing takes place. Tank farm waste would be pumped to the Pretreatment Facility, where it would be subjected to a number of processing steps, including ultrafiltration, ion exchange, and mixing. As a result of these activities, fouled or worn ultrafilter membranes and spent ion exchange resins would be produced as process expendables. Additionally, spent HEPA cartridges would be produced by the process vent systems, and a number of pretreatment maintenance wastes would be produced, such as worn pipe jumpers, failed mechanical or instrumentation equipment, and degreasing or decontamination materials. The resultant solid waste would be CH or RH, as applicable, and would be placed into either drums (HEPA cartridges, failed equipment, decontamination materials) or boxes (ultrafilter modules, pipe jumpers) or sluiced into high-integrity containers and dewatered (using ion exchange resins). After the filtration and maintenance wastes were securely packaged, they would be transferred to the Central Waste Complex (CWC) for stabilization, if necessary, and repackaging. The stabilized waste would then be transported to an IDF for disposal (BNI 2005).

HLW melter feed streams would be sent to the HLW Vitrification Facility for processing in the HLW melters. Vitrifying these HLW streams would produce contaminated secondary waste. Solid secondary waste produced by the melters would include expended melter bubblers and thermowells. In addition, each melter line would result in one melter taken out of service every 5 years. Operation of the melters would produce offgases that would pass through a number of offgas treatment system components and result in the production of contaminated waste byproducts. The HLW melter offgas treatment system would produce solid waste such as spent HEPA filters, spent sulfur-carbon adsorbent, spent silver mordenite adsorbent, and fouled thermal catalyst and selective reduction catalyst modules. HLW

vitrification plant maintenance operations would produce decontamination material, worn or fouled pipe jumpers, and failed equipment. Additionally, spent HEPA filters would be discharged from the vessel pulse jet vent system. Solid waste is RH and would be placed into drums or boxes. After the filtration, sorption, and maintenance wastes were securely packaged in accordance with the HSSWAC, they would be transferred to the CWC for stabilization, if necessary, and repackaging. The stabilized waste would then be transported to an IDF for disposal. Packaging and transport of the HLW melter taken out of service is described in Section E.1.2.4.4 (BNI 2005).

As a result of processing waste through the LAW melter system, solid and liquid secondary waste would be produced. Melter operation would produce a number of waste products. Offgases from operation of the melter would pass through a number of the offgas treatment system components identified in Section E.1.2.3.1.3, resulting in the production of contaminated solid and liquid waste byproducts. Maintenance of the LAW Vitrification Facility would result in additional contaminated solid waste. The LAW vitrification process would produce expended melter bubbler/thermowell waste and, periodically, melter taken out of service. This TC & WM EIS assumes the melter would require replacement every 5 years. Operation of the melter offgas and vent system would produce loaded or occasionally failed HEPA filters, expended sulfur-carbon adsorbent modules, fouled or damaged scrubber packing, fouled thermal catalytic modules, and fouled selective catalytic reduction modules. LAW vitrification plant maintenance operations would produce decontamination materials, worn or fouled pipe jumpers, and failed process equipment. Spent HEPA filters would also be produced during operation of the process vessel vent system. The solid waste would be RH and would be placed into drums or boxes. After the filtration, sorption, and maintenance wastes were securely packaged in accordance with the HSSWAC, they would be transferred to the CWC for stabilization, if necessary, and repackaging. The stabilized waste would then be transported to an IDF for disposal. Packaging and transport of the LAW melter taken out of service is described in Section E.1.2.4.4 (BNI 2005).

SECONDARY LIQUID WASTE

The WTP liquid effluent collection system would consist of two subsystems: the radioactive liquid disposal system and the nonradioactive liquid disposal system.

The radioactive liquid disposal system would receive effluent waste from the LAW Vitrification Facility such as the melter primary offgas treatment system, LAW vitrification secondary offgas/vessel vent treatment system, processes, vessel washes, floor drains and sumps, and vessel vent header drains, all of which are expected to have low levels of radioactive contamination. Waste from the HLW Vitrification Facility areas also would be received, including the primary and secondary offgas treatment and HLW canister decontamination handling system, vessel washes, offgas drains, and the floor drains and sumps system. In addition, the radioactive liquid disposal system would receive waste from Pretreatment Facility sources such as the radioactive liquid disposal vessels and tanks that are primarily used to collect solutions that may be discharged to the LERF/ETF, including process condensates from evaporators, caustic waste from the LAW caustic scrubber, and spent reagents from the resin addition process (BNI 2005).

The nonradioactive liquid disposal system for all three WTP facilities would receive effluent from the floor drains and sump systems that is not expected to be radioactively contaminated. The purpose of the system is to receive effluents for interim storage, to sample them for radioactivity, and, after the contents have been determined to be free of radiological contamination, to transfer the effluents to the BOF for ultimate disposal at the TEDF. If radioactive contamination is detected, the contents would be transferred to the Pretreatment Facility for processing (BNI 2005).

For TC & WM EIS analysis purposes, it was assumed that solid waste would be treated as needed (e.g., by grouting or encapsulation) to meet the IDF waste acceptance criteria. Liquid effluents would be routed to

the LERF/ETF or the TEDF, as appropriate. Solid waste generated at the ETF would be treated as needed to meet the IDF waste acceptance criteria. Additional discussion of secondary waste streams and their disposal is included in Section E.1.2.4.5.

E.1.2.3.1.6 Other Waste Treatment Plant Facilities

ANALYTICAL LABORATORY

The Analytical Laboratory would be a standalone facility located east of the Pretreatment Facility and north of the LAW Vitrification Facility. The laboratory would analyze chemical and radiochemical samples to support WTP operations. The laboratory would be capable of processing and analyzing nonradioactive samples to support the WTP glass-forming chemical supply operation. The reserve capacity of the laboratory would be used to conduct limited and infrequent technology testing. Environmental samples (including effluent) would be sent to other laboratories for analysis.

The laboratory would contain hot cells with shield walls and remote manipulators to prepare the highly radioactive samples. The laboratory would also have chemical and radiochemical analysis modules, administrative areas, and equipment rooms. A cascading ventilation system would be used to ensure air movement from low-contamination areas to high-contamination areas. The exhaust from the radioactive areas would be filtered. Samples would be transported to the laboratory via a remote pneumatic system or manual transport inside shielded containers. Radioactive liquid waste from laboratory operations would be transferred to the Pretreatment Facility for processing.

The laboratory would be a steel frame building built on a reinforced-concrete foundation with exterior metal siding and a metal roof.

BALANCE OF FACILITIES

The BOF would include the facilities, support systems, and utilities that make up the WTP site infrastructure. The BOF support systems and utilities would include electrical power, heating and cooling, process steam, process water, chilled water, compressed air, fire protection water, potable water, sanitary sewer, and storm drains.

Some of the larger support BOF would include the glass-former storage silos and glass-former handling and transport facility, the melter assembly building, the expended melter storage areas, wet chemical storage, and a storage facility for secondary waste from WTP processing.

E.1.2.3.1.7 Waste Treatment Plant Assumptions and Uncertainties

The capture of several select radionuclides in the ILAW glass is an important consideration when evaluating the performance of the ILAW process. The high temperatures associated with the ILAW process would cause some of the select radionuclides to emit offgas and be captured in secondary waste streams. The estimated fractions of select radionuclides between final waste form product and secondary waste streams as a percent of the feed stream to the ILAW process are provided in Table E-5.

Table E–5. Partitioning Factors of Radiological Constituents of Potential Concern in Immobilized Low-Activity Waste Glass^a

| Radiological Constituent of Potential Concern | Percent of ILAW Feed in ILAW Glass | Percent of ILAW Feed in Liquid Secondary Waste |
|---|------------------------------------|--|
| Iodine-129 ^b | 20.0 | 80.0 |
| Cesium-137 | 99.8 | 0.4 |
| Carbon-14 | 0.0 | 0.3 |
| Uranium-233 | 99.7 | 0.4 |
| Uranium-234 | 99.7 | 0.4 |
| Uranium-235 | 99.8 | 0.4 |
| Neptunium-237 | 99.8 | 0.2 |
| Uranium-238 | 99.8 | 0.4 |
| Plutonium-239 | 99.8 | 0.2 |
| Plutonium-240 | 99.8 | 0.2 |
| Hydrogen-3 (tritium) | 0.0 | 99.0 |
| Strontium-90 | 99.5 | 1.5 |
| Technetium-99 | 98.5 | 1.8 |

^a Totals may not equal 100 percent due to rounding.

^b The partitioning factor for iodine-129 was directed by the Office of River Protection (CEES 2007a:Attachment 3).

Key: ILAW=immobilized low-activity waste.

Source: Data extracted from CEES 2007a.

The behavior of iodine-129 in thermal processes and the fraction that would be captured in the final waste form is difficult to predict. Therefore, this fraction was assumed, based on ORP guidance (CEES 2007a:Attachment 3), in contrast to the use of the HTWOS simulations partitioning factors for the other radiological constituents of potential concern (COPCs). Further demonstration and testing of this technology should provide the necessary performance data to confirm these assumptions. If necessary, design changes may have to be implemented should the actual fractions in secondary waste streams be demonstrated to be higher than anticipated. Carbon-14 is highly volatile and would produce very high fractions in the offgas. Incorporation of treatment technologies in the final facility design may be required to reduce these emissions. Select radionuclides that exist in particulate form would be recycled into the waste feed. Appendix N, Section N.3.8, provides the results of a sensitivity analysis of additional retention of iodine-129 in ILAW glass.

The following basis and assumptions related to the WTP baseline were also used for analysis purposes in this TC & WM EIS:

- A 99 percent retrieval of the tank waste could be achieved using currently available retrieval technologies. A retrieval rate of 99.9 percent could be achieved using advanced retrieval technologies (e.g., chemical washing) with the currently available retrieval technologies.
- The Pretreatment Facility would be capable of providing sufficient feed to support the full operation of both the HLW Vitrification Facility and two LAW Vitrification Facilities simultaneously.
- This TC & WM EIS assumes the WTP would process approximately 60,000 metric tons of sodium combined from tank waste (approximately 48,000 metric tons) and additions made during pretreatment (12,000 metric tons). The precise quantity of sodium to be processed is uncertain because of the developing process flowsheets for the pretreatment and treatment technologies. The amount of sodium processed influences the time required for waste treatment through the WTP and the amount of IHLW and ILAW produced.

- The DOE ORP has been reviewing the WTP design. One of the areas assessed in detail is related to the amount of sodium hydroxide (caustic) that may need to be added as a process reagent. Sodium is added in the pretreatment process to solubilize aluminum. This process is referred to as caustic leaching. The net result of the evaluation of the flowsheet model indicates that increases in the overall sodium quantity utilized in the caustic leaching process are necessary, which would cause corresponding increases in the sodium disposed of as LLW. Early indications are that the total sodium requiring disposal as LLW may increase from 60,000 to 90,000 metric tons. To address this issue, DOE is evaluating various R&D tasks to minimize this impact. Potential solutions include sodium hydroxide recycle, maintaining the treatment process from ultrafiltration through LLW immobilization at elevated temperature, and treating or separating the aluminum within the tank waste prior to sending it to the WTP.
- Due to uncertainties with how well caustic leaching works for different types of waste, more sodium may be required to limit the number of IHLW glass canisters produced. If the total sodium value becomes as high as 90,000 metric tons, there could be an increase in the number of ILAW glass canisters by 46,000 based on the current flowsheet assumptions used for this EIS. Additionally, the waste treatment processing timeframes for the WTP could be extended by as much as 50 percent, or 13 years. However, the higher sodium volume would reduce the contaminant concentrations in the WTP annual air emissions (Burandt 2007).
- The WTP vitrification facilities would begin vitrifying waste in 2018.
- The effects of potential improvements in IHLW glass loading were incorporated by relaxing three glass-property model constraints. Glass loading to these limits may not be achievable without additional research and testing. However, these limit changes indicate that a reduction in the number of IHLW glass canisters is achievable with a positive effect on the RPP program. The maximum allowable viscosity of the IHLW glass was increased from 5.5 pascal-seconds to 10 pascal-seconds to ensure the glass would flow to the canister walls and to minimize voids. The maximum allowable chromium oxide loading was increased from 0.5 percent to 1.0 percent. The maximum allowable spinel liquidus temperature was increased from 1,050 °C to 1,100 °C (1,922 °F to 2,012 °F) (DOE 2003f).
- The IHLW glass canisters would be “thin-wall” canisters, with a capacity of approximately 3.2 metric tons of glass IHLW per canister. Although this canister has not been approved, it was assumed it would be approved in the future. The currently approved Hanford canister would have a capacity of approximately 3.06 metric tons of glass IHLW per canister, or approximately 5 percent less (DOE 2003f). Under Tank Closure Alternative 2B, a change from the thin-wall canister would result in approximately 600 additional IHLW glass canisters, i.e., from 12,000 to 12,600.
- RPP supporting facilities (e.g., the LWPFs and 242-A Evaporator) would be available as required throughout the duration of the waste treatment mission.

The following considerations contribute uncertainty to the analysis:

- Assumed nominal throughputs have been demonstrated only on pilot-scale facilities.
- Construction of a second LAW Vitrification Facility would require substantial resources. Skilled workers, equipment, and production capability might not be available, resulting in schedule delays and added costs.

- The ability of the RPP interfacing facilities to support expanded LAW vitrification capacity is uncertain.
- Upgrades to the Analytical Laboratory and BOF may be needed to support operation of expanded LAW vitrification facilities.

E.1.2.3.2 242-A Evaporator

The continued operation of the 242-A Evaporator is required to support treatment of tank waste. The current and future mission of the evaporator is to support environmental restoration and remediation of Hanford by optimizing the 200 Area DST waste volumes in support of the tank farm management and WTP operations. To accomplish this mission, the 242-A Evaporator would require multiple replacements under some Tank Closure alternatives analyzed in this EIS. The estimated 242-A Evaporator's useful life is 25 years. The 242-A Evaporator also depends on the continued operation of the LWPFs to accept and treat both contact (process condensate) and noncontact (steam condensate and cooling water) effluent waste streams. The LWPFs are discussed in detail in Section E.1.2.3.3.

Under Tank Closure Alternative 1, the 242-A Evaporator would be utilized to support the tank farm management program until failure of the facility, with no planned replacement. Under Tank Closure Alternative 6A, the operational lifespan of the evaporator was assumed to extend from the present until approximately 2163. This would require the construction of six replacement evaporators (one each in 2018, 2043, 2068, 2093, 2118, and 2143). Under Tank Closure Alternative 2A, two replacement evaporators are required, one in 2040 and one in 2065. Under all other Tank Closure alternatives, only one replacement evaporator was assumed to be required.

The 242-A Evaporator is not operated continuously. Based on historical operating data, it was assumed the 242-A Evaporator would process approximately 3.78 million liters (1 million gallons) of liquid tank waste per campaign and would complete two campaigns per year, each lasting only about 21 days. The following background, process, and facility descriptions are based on the **Documented Safety Analysis for the 242-A Evaporator** (HNF-14755) (Campbell 2004).

E.1.2.3.2.1 Background

The existing 242-A Evaporator was constructed from 1974 to 1977 and is located in the 200-East Area of Hanford. The 242-A Evaporator began operations in 1977. Between 1977 and the late 1980s, the 242-A Evaporator's mission was to support ongoing defense-related production of nuclear weapons material, to concentrate and transfer SST waste into the DST system, and to manage DST waste by liquid volume reduction.

The 242-A Evaporator was shut down in April 1989, pending a determination regarding whether the process condensate required management as a mixed waste. Ecology subsequently concluded that the process condensate stream is a mixed waste stream, and thus is a discharge regulated by Ecology. As a result, direct discharge to the 216-A-37-1 Crib (trench) was eliminated. The determination led to a 5-year shutdown of the 242-A Evaporator until the LERF basins were constructed for storing process condensate.

The LERF basins store process condensate prior to treatment in support of 242-A Evaporator operation. The ETF was constructed to reduce the concentrations of ammonia, residual organics, and dissolved radionuclides in the process condensate to levels that permit direct disposal of the treated liquid effluent to the State-Approved Land Disposal Site (SALDS). The LERF, ETF, and SALDS are all part of the LWPFs described in Section E.1.2.3.3.

During the shutdown, the 242-A Evaporator was extensively upgraded. The upgrades were completed in fiscal year 1993, and operations restarted in April 1994. The current and future mission of the 242-A Evaporator is to support environmental restoration and remediation of Hanford by optimizing the 200-East and 200-West Areas' DST waste volumes. To support this mission, a life extension study was prepared to identify the work scope needed to extend the facility life through 2016. This study was revisited in January 2001 due to a need for the facility through 2019. The upgrades completed in 1993 and the implementation of the work scope outlined in the life extension study are expected to extend the 242-A Evaporator's useful life through 2018, when it has been assumed the first replacement would be required.

E.1.2.3.2.2 Process

The 242-A Evaporator is designed to reduce waste volume and the number of DSTs required to store liquid waste generated at Hanford. The process uses a conventional, forced-circulation, vacuum evaporation system operating at low pressure (approximately 8,000 pascal [1.2 pounds per square inch]) and low temperature (approximately 50 °C [122 °F]) to concentrate radioactive waste solutions.

The liquid tank waste feed is pumped from a DST feed tank (241-AW-102) through an underground-encased feed line to the 242-A Evaporator. Using a thermal-assisted evaporative process (steam), the waste feed is concentrated in vessel C-A-1 to achieve a specified volume reduction. The concentrated tank waste slurry is returned to the DST farm. The slurry can be directed to a specific DST via the tank farm transfer piping system. The tank farm transfer system is physically connected to the 242-A Evaporator in-facility process piping at the exterior walls of the 242-A Evaporator and consists of single and encased piping, pumps, valve pits, diversion boxes, clean-out boxes, and support systems such as leak detectors and cathodic protection. Process offgases and water vapor are passed through one primary and two secondary condensers, creating a process condensate and air emissions. Air emissions are filtered and released to the environment from the vessel ventilation exhaust system. Process condensate is collected in a collection tank prior to transfer to external treatment facilities.

The 242-A Evaporator process condensate, steam condensate, and cooling water effluent streams are transferred to other waste handling facilities. Process condensate (contact effluent) is transferred to LERF via an underground transfer line approximately 1 mile away. Effluent waste streams received in the LERF are eventually treated in the ETF and discharged in the SALDS. Monitoring for leak detection is provided at regular intervals along the transfer line. Steam condensate and cooling water (noncontact effluents) are transferred via separate underground transfer lines to the TEDF.

The average evaporator campaign processes 3.68 million liters (973,000 gallons) of waste to remove 2.17 million liters (573,000 gallons) of water and return 1.51 million liters (400,000 gallons) of slurry to the DSTs (CEES 2006a).

SECONDARY WASTE STREAMS

There are four secondary waste streams from the evaporator. The process condensate is discharged to the LERF for blending and future treatment at the ETF at a maximum flowrate of 189 liters (50 gallons) per minute. The noncontact discharge effluents—steam condensate, cooling water, and facility wastewater—are discharged to the TEDF at a maximum flowrate of 680 liters (180 gallons) per minute, 14,000 liters (3,700 gallons) per minute, and 1,900 liters (500 gallons) per minute, respectively.

E.1.2.3.2.3 Facilities

The 242-A Evaporator is located in the 200-East Area. Replacement evaporators were assumed to be similar in size and capacity to the existing 242-A Evaporator. Construction resources required for the replacement evaporators were scaled from WTP construction data. Deactivation of the evaporators was

assumed to require six months and that 1 percent of the waste processed through the evaporator would remain after operations. The following four principal structures make up the 242-A Evaporator.

- 242-A Building: main process building
- 242-AB Building: control room
- 242-A-81 Building: water services building
- 207-A Retention Basins

The principal process components of the 242-A Evaporator system are located in the 242-A Building, which is composed of two adjoining but independent structures. The first structure contains processing and service areas and is a reinforced-concrete shear wall and slab structure. The second structure is separated from the first by a seismic joint and contains operating and personnel support areas.

The 242-A Building is 23 meters wide by 33 meters long (75 feet wide by 108 feet long). The 242-AB Building is an addition to the main structure of the 242-A Building, is of similar design and construction, and is 14 meters long by 12 meters wide (45 feet long by 40 feet wide). The 242-A Evaporator Facility footprint includes 23 meters wide by 33 meters long by 22 meters high (75 feet wide by 108 feet long by 72 feet high) (main building) and 12 meters wide by 14 meters long by 4 meters high (40 feet wide by 45 feet long by 12 feet high) (support building) for a total of 14,400 cubic meters (605,000 cubic feet). The facility boundary is assumed to encompass approximately 0.4 hectares (1 acre).

The principal process components of the 242-A Evaporator system include the reboiler, evaporator vessel C-A-1, recirculation pump, recirculation pipe loop, slurry product pump, condensers, jet vacuum system, and condensate collection tank.

A computer-based monitoring and control system is located in the 242-AB Building control room and is used to operate and monitor the 242-A Evaporator. The emergency diesel generator and the package boiler units are the only equipment that normally uses diesel fuel within the facility boundaries. The emergency diesel generator is run for 15 minutes a month as a safety check to ensure its operational capability. The package boilers provide normal building heating and steam to the reboiler units during a campaign. The package boilers use approximately 182,000 liters (48,000 gallons) of diesel fuel to heat the building during a normal calendar year. Additionally they use approximately 295,300 liters (78,000 gallons) of diesel fuel during a campaign. Diesel fuel requirements are estimated by multiplying the projected number of campaigns per year (two) by 295,260 liters (78,000 gallons) and then adding 182,000 liters (48,000 gallons) for normal building heating.

Water is provided from the 200-East Area Power House to the 242-A-81 Water Services Building. Steam used in the 242-A Evaporator process and for building heat is provided by package boilers located in the 242A-AB Building.

The 207-A Retention Basins have been disconnected from the 242-A Evaporator and are no longer used. Prior to the temporary shut down in 1989 and the subsequent construction of the ETF to treat process condensate, the 207-A Retention Basins were used for temporary storage of 242-A Evaporator process condensate and steam condensate prior to disposal. The basins contain low levels of residual radioactive contamination. This EIS does not analyze the decontamination and decommissioning (D&D) of the 207-A Retention Basins (CEES 2006a).

E.1.2.3.2.4 Assumptions and Uncertainties

The following is a list of the assumptions for construction, operation, and deactivation of evaporators as needed for replacement of the existing 242-A Evaporator. The 242-A Evaporator has been an operational facility since 1977; therefore, very little uncertainty is associated with the size of the facility, required process equipment, and production capacity.

- Evaporator facility life is estimated to be 25 years. Construction of a replacement evaporator and supporting facilities would take 3 years to complete.
- The capacity of the replacement evaporators would be similar to the production rates achieved in the 242-A Evaporator, averaging about 3.78 million liters (1 million gallons) per campaign and two campaigns per year, with each campaign lasting approximately 21 days. In practice, the 242-A Evaporator and its replacements could process more than two campaigns per year to support Hanford's needs; however, the air emissions assumed for that year would increase and the facility's useful life would likely decrease.
- The operating resources and emissions for the replacement evaporator are the same as the operating resources and emissions of the existing 242-A Evaporator.
- The TEDF and LERF are operating and available to receive the evaporator secondary waste streams.
- Evaporator deactivation, including the removal of radioactive/hazardous materials to ensure adequate protection of workers, public health and safety, and the environment, would place the facility in a stable and known condition. Decommissioning and dismantling of the facility is not included in the scope of this TC & WM EIS. Deactivation would take place between campaigns and would take 6 months to complete.
- Evaporator deactivation assumes that 1 percent of 1 year's throughput would remain in the facility and it would take 6 months to clean up the facility with no campaigns during that period. Drain waste and flush waste would be returned to tank 241-AW-102 during deactivation activities (CEES 2006a).

E.1.2.3.3 Liquid Waste Processing Facilities

The 200 Area LWPFs include the LERF, ETF, SALDS, and TEDF. These facilities receive, store, treat, and dispose of liquid effluents from Hanford cleanup activities.

The LERF and ETF were constructed and commissioned circa 1995 to support 242-A Evaporator operations. The initial mission of the LERF was to pre-store all 242-A Evaporator process condensate until it could be treated in the ETF. The LERF and ETF were constructed to support the determination that 242-A Evaporator process condensate was a mixed waste and could no longer be discharged directly into the ground without treatment.

The LERF, a series of three liquid storage basins, was initially constructed to provide permitted interim storage of the 242-A Evaporator process condensate. The LERF is capable of storing up to 4.9 million liters (13 million gallons) of liquid effluent waste awaiting treatment at the ETF. The effective storage capacity may be slightly lower due to recirculation and contingency space needs. All process condensate is received into the LERF prior to treatment in the ETF.

The ETF process reduces the concentration of contaminants, including ammonia, residual organics, and dissolved radionuclides, to levels that allow direct disposal of the treated liquid effluent to the SALDS. A byproduct of the ETF process, a concentrated, powdery solid waste material, is placed in approved containers for transfer to storage and/or final disposal.

The LERF, ETF, and SALDS are designed to accept and treat regulated effluents discharges prior to disposal. These effluents are process condensates that have been in contact with radioactive tank waste.

Separate from the LERF and ETF is the TEDF, a collection and disposal facility for unregulated liquid effluents. These effluents are primarily steam condensates, cooling water, boiler blowdown, and rainwater that have not contacted tank waste and do not require treatment prior to disposal. The TEDF consists of approximately 11 miles of network piping, three pump stations, one sample station, and two 2-hectare (5-acre) disposal ponds (Fluor Hanford 2004a).

The alternatives in this TC & WM EIS depend on the continued operation of the 200 Area LWPFs, both for contact and noncontact effluent discharges. In fact, the ETF's role is expected to expand beyond treating liquid effluent generated from the operation of the 242-A Evaporator. Under this EIS, the LWPFs would be also required to support WTP, bulk vitrification, steam reforming, and other processes, should they be selected for implementation.

For purposes of analysis in this EIS, it was assumed the ETF's main building 2025 and support building 2025-EA would require replacement to provide continued support for proposed treatment technologies selected under this EIS. However, the LERF (retention basin), TEDF (disposal pond), and SALDS (crib) are well suited to life extension projects; therefore, it was assumed replacement of these systems would not be required.

The design life of the ETF is 30 years, with the current ETF's useful life ending in 2025. The replacement of the ETF would occur every 30 years thereafter. Under Tank Closure Alternative 1, the ETF would be utilized to support the 242-A Evaporator until failure of the facility, with no planned replacements. Under Tank Closure Alternative 2A, the operational lifespan of the ETF was assumed to be from the present until approximately 2093. This would require the complete construction of two replacement facilities. Under Tank Closure Alternative 6A, the operational lifespan of the ETF was assumed to be from the present until approximately 2163. This would require the construction of five replacement facilities. All other Tank Closure alternatives would require only one replacement of the ETF.

E.1.2.3.3.1 Process

The ETF operation collects, treats, and stores MLLW. This includes the load-in station and transfer piping as well as the tanks and process equipment within the ETF. The following is a brief discussion of the treatment processes available at the ETF. The ETF is an RCRA-permitted facility; as such, it can only receive liquid effluent meeting certain waste acceptance criteria and must successfully treat the liquid effluents prior to discharge. All effluent treated in the ETF is first interim-stored in the LERF basins. Maximum processing rates for the ETF are estimated to be 210 million liters (55.5 million gallons) per year based on a TOE of 70 percent (CEES 2006a). The following process steps are associated with the ETF treatment train as illustrated in Figure E-13 (Koerner, Wagner, and McDonald 1995).

Feed Receipt: ETF feed is received into the 378,540-liter (100,000-gallon) surge tank. Recirculation mixes the surge tank contents continuously before they are introduced into the treatment process.

Suspended Solids Removal: Removal of suspended solids is accomplished via a two-step process. Gross removal of suspended solids (greater than 2 micrometers) is performed before the ultraviolet oxidation system step. The second step, fine filtration (greater than 0.5 micrometers) is accomplished prior to introduction of the slurry into the degasification system. The removal of suspended solids greater than 0.5 micrometers is necessary for the protection of downstream equipment.

Organic Destruction: Ultraviolet light oxidation destroys organics. The destruction process is enhanced with the use of hydrogen peroxide.

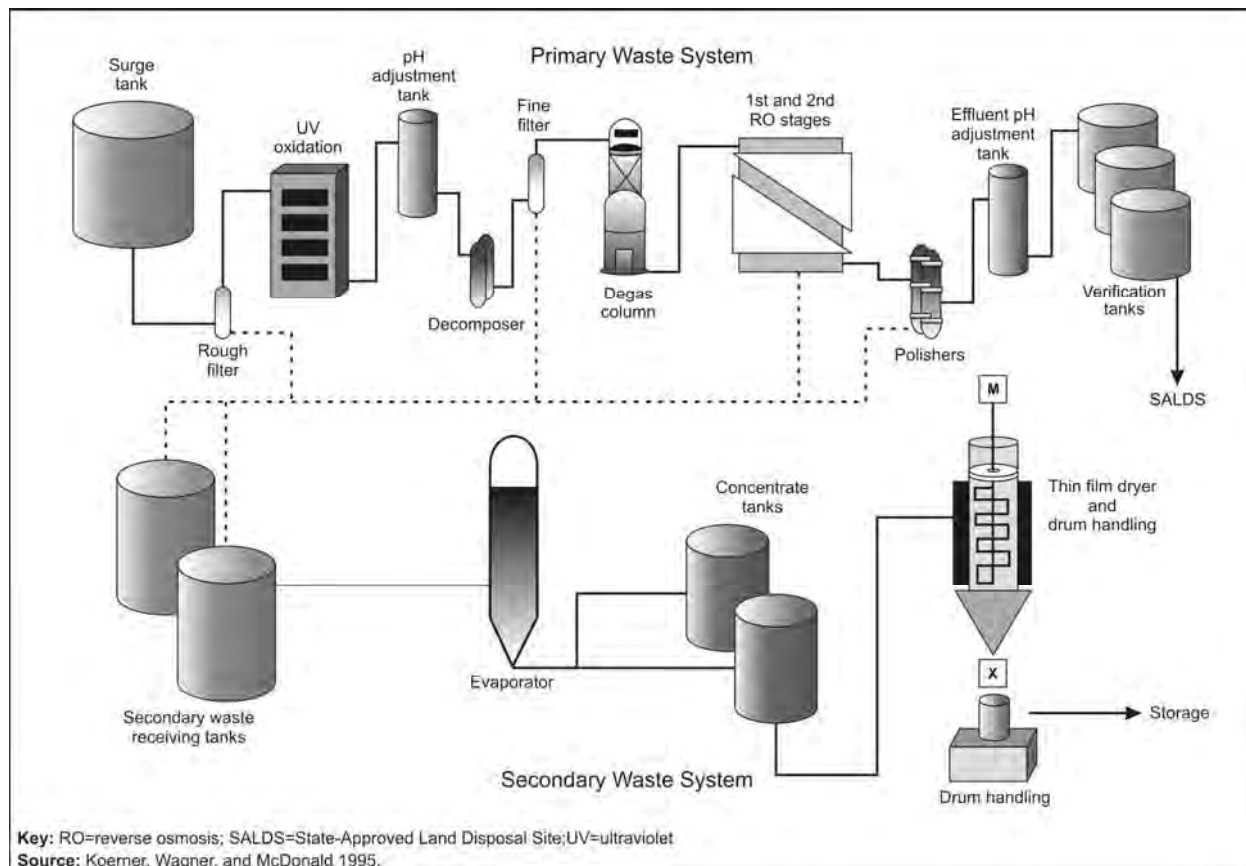

Figure E-13. Effluent Treatment Facility Process Flowsheet

pH Adjustment: The process effluent's pH (relative acidity or alkalinity) is controlled through the metered addition of sodium hydroxide or sulfuric acid. The pH is maintained at a value of approximately 4.0. Adjustment of pH is performed after ultraviolet oxidation and again after the reverse osmosis treatment process.

Hydrogen Peroxide Decomposition: Hydrogen peroxide added during the destruction of organics in the ultraviolet oxidation system must be removed prior to the reverse osmosis process step. Hydrogen peroxide is decomposed using a granulated activated carbon column that breaks down the hydrogen peroxide.

Degasification: Removal of dissolved carbon dioxide is accomplished via degasification in a packed column. The reduction in carbonate loading is necessary for downstream process steps such as reverse osmosis and polishing.

Dissolved Solids Removal: Removal of dissolved solids is provided by reverse osmosis. The effluent continues through to the polishing step. The concentrated liquid waste is redirected to additional secondary evaporation steps.

Effluent Quality Verification: All treated effluent exits the polishers and is temporarily stored in one of three verification tanks. Each verification tank has a storage capacity of 2,536,200 liters (670,000 gallons) and is designed to hold 72 hours of effluent discharge. Prior to discharge to the SALDS, effluent may be retained for verification of quality. During storage, laboratory analyses may be performed to confirm compliance with the appropriate requirements before discharge. Effluent that does not meet discharge requirements is recirculated back to the surge tank for additional treatment.

Effluent Disposal: Effluents suitable for disposal may be transferred through the liquid effluent disposal system for release to the SALDS.

Secondary Waste Treatment: Liquid waste from the primary treatment train may be concentrated in an evaporator and/or dewatered in the thin film dryer. The resultant powdery solid waste is packaged in drums for disposal (Koerner, Wagner, and McDonald 1995).

PRIMARY AND SECONDARY WASTE STREAMS

There are two significant waste streams associated with the ETF. The primary liquid waste stream is verified in the verification tanks and sent to the SALDS for final disposition. Three of the 2004 quarterly monitoring reports cited a discharge volume of 80.5 million liters (21.3 million gallons) for a 9-month period (Fluor Hanford 2004a, 2004b, 2005b). Based on these 2004 data and operations supported by the ETF, the annualized discharge rate in 2004 was approximately 107.1 million liters (28.3 million gallons). As analyzed in this EIS, the operation of the WTP, IDF(s), groundwater leachate collection systems, and supplemental treatment facilities could increase the waste loading on the ETF. The secondary waste stream is a solid waste generated from the thin-film dryer. The powder and/or sludge solid waste stream is packaged in 208-liter (55-gallon) drums and is directed to final disposition, depending on the source of the effluent that was processed. Waste from effluent that is a result of a Comprehensive Environmental Response, Compensation, and Liability Act (CERCLA) cleanup activity is sent to the Environmental Restoration Disposal Facility for disposal; LLW and MLLW from ongoing site activities would be sent to the currently operational lined trenches 31 and 34 in low-level radioactive waste burial ground (LLBG) 218-W-5, or an IDF for disposal (CEES 2006b).

E.1.2.3.3.2 Facilities

The ETF is a permanent facility with an estimated operating design life of 30 years and has been classified as a radiological facility. The ETF is a single building containing a control room that provides the capability to control the treatment process and the collection, recycling, and disposal systems. External storage is provided for the treated waste during analysis and/or verification. The building also contains a chemical makeup and storage area, secondary waste treatment and storage systems, and offgas and ventilation systems. In addition, there are various support systems, including fire protection, communications, sanitary and raw water, and electrical. The ETF also includes a load-in station that provides the capability to unload, store, and transfer liquid waste to the ETF or LERF from tank trucks (Koerner, Wagner, and McDonald 1995). The ETF layout is presented in Figure E-14.

The ETF is located in the northeast corner of the 200-East Area of Hanford, adjacent to the LERF and approximately 1 mile north of the 242-A Evaporator facility. The ETF's main building dimensions are 4,100 square meters (44,000 square feet) and 12 meters (40 feet) tall, and the support building is 950 square meters (10,300 square feet) and 3.7 meters (12 feet) tall, for a total footprint of 5,000 square meters (54,300 square feet). Therefore, each ETF replacement is based on constructing a 5,000-square-meter (54,300-square-foot) building. The facility boundary was assumed to occupy 29 hectares (72 acres) (Koerner, Wagner, and McDonald 1995).

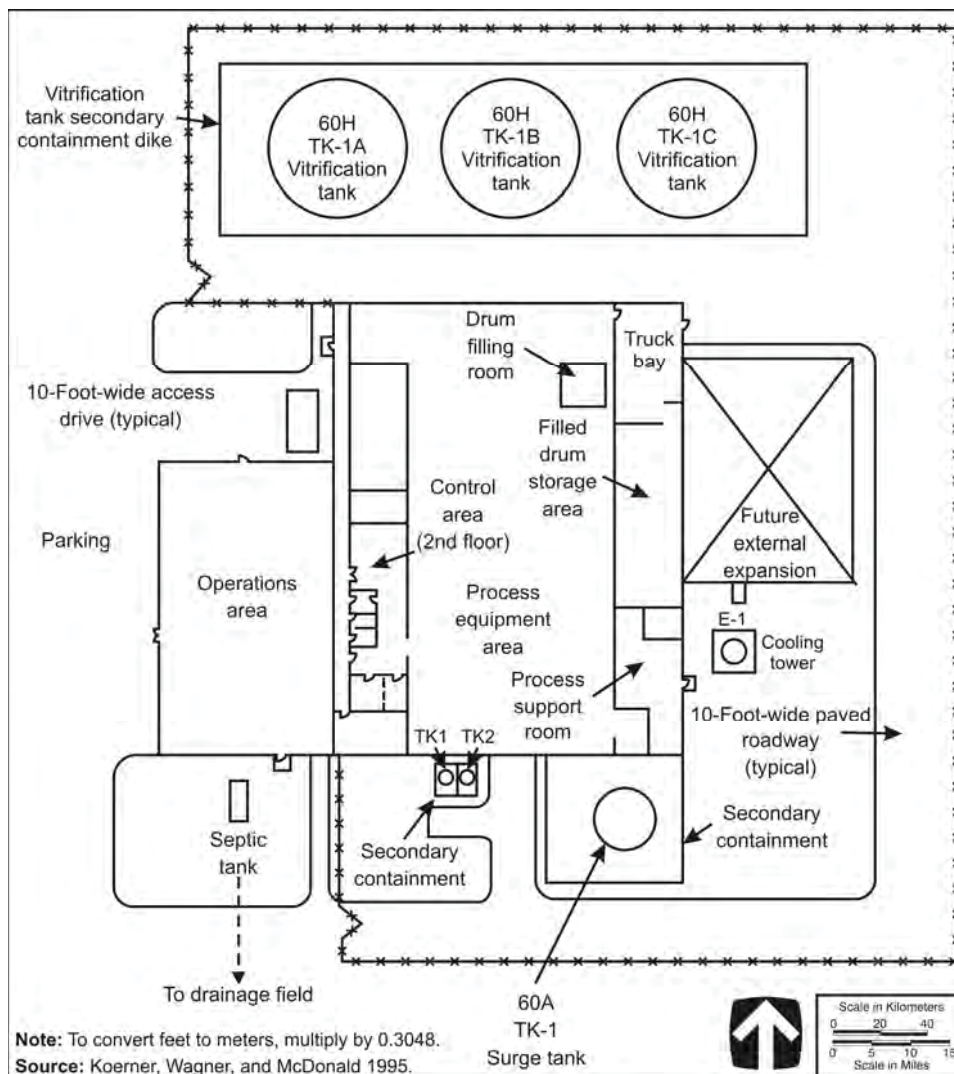

Figure E-14. Effluent Treatment Facility Layout

E.1.2.3.3.3 Assumptions and Uncertainties

- The ETF main building 2025 and the ETF support building 2025-EA would require replacement. The LERF (retention basin), TEDF (disposal pond), and SALDS (crib) are well suited to life extension projects. The LERF, TEDF, and SALDS would continue their useful life within the ETF system with the replacement ETF.
- The ETF's useful life is estimated to be 30 years. Construction of replacement ETF and supporting facilities would take 3 years to complete.
- The current design capacity of the ETF would be sufficient to support all current Hanford activities as well as the tank closure activities implemented under this EIS.
- The operating resources and emissions for the replacement ETF would be the same as the operating resources and emissions of the existing ETF.
- The LERF and SALDS would remain in operation and available to support the ETF operations.

- All solid waste would be disposed of in either the Environmental Restoration Disposal Facility (for CERCLA waste), the currently operational mixed waste lined trenches, or an IDF. This solid waste would be grouted, containerized waste.
- ETF deactivation, including the removal of radioactive/hazardous materials to ensure adequate protection of workers, public health and safety, and the environment, would place the facility in a stable and known condition. Decommissioning and dismantling of the facility is not included in the scope of this TC & WM EIS. Deactivation would take place between campaigns and would take 6 months to complete.
- ETF deactivation assumes that 1 percent of 1 year's throughput would remain in the facility and that it would take six months to clean up the facility with no campaigns during that period. Drain waste and flush waste would be returned to the LERF during deactivation activities (CEES 2006b).

E.1.2.3.4 Cesium and Strontium Capsule Processing Facility

The construction of a capsule processing facility would be necessary for extracting cesium and strontium waste from the storage capsules prior to treatment through the WTP HLW melters. The capsule processing facility would also prepare the cesium and strontium waste into a slurry waste stream acceptable for treatment in the WTP. The final waste form would be canistered waste that was assumed to be stored on site as IHLW until disposition decisions are made and implemented.

Under Tank Closure Alternative 1, the cesium and strontium capsules would be stored indefinitely in the Waste Encapsulation Storage Facility (WESF), in a manner similar to the present; therefore, construction of a capsule processing facility would not be required. Under all other Tank Closure alternatives analyzed in this EIS, the cesium and strontium waste would be vitrified in WTP. The immobilization of cesium and strontium capsule waste would take place during a separate campaign, after treatment of all tank HLW is completed in the WTP. The cesium and strontium WTP campaign is expected to add 1 year of processing time to the WTP HLW melters. The capsule processing facility would be built so that processing of cesium canisters could begin approximately 14 months prior to the completion of WTP processing of tank HLW.

Based on estimated production rates, the capsule processing facility would require 26 months to de-encapsulate all the cesium and strontium capsules and prepare the cesium and strontium slurry feed. The WTP requires an estimated 12 months to vitrify the slurry feed. Thus, to maintain a continuous WTP feed, the capsule processing facility must begin operations 14 months in advance of the cesium and strontium campaign and prestore this WTP feed in the DSTs. It is estimated that an additional 340 canisters would be produced during the cesium and strontium treatment campaign (CEES 2006c).

E.1.2.3.4.1 Background

The cesium and strontium capsules were generated at Hanford during the 1970s and 1980s, when cesium and strontium isotopes were separated from other tank waste, converted to cesium chloride and strontium fluoride, and then encapsulated for long-term storage.

Currently, there are 1,335 cesium capsules and 601 strontium capsules stored in the WESF pool cells. Most of the capsules are composed of an inner and outer capsule. However, 23 of the cesium capsules are Type W capsules containing material from the 324 Building B cell. The Type W containers are triple-containment capsules versus the normal double-containment configuration (SAIC 2007a).

Originally, there were 640 strontium capsules produced at WESF; 601 are presently stored in the WESF pool cells. Of the 39 strontium capsules remaining and not stored at Hanford, only four capsules stored at

the Nevada Test Site (NTS) have a commitment for disposal by other DOE programs. Though there are no formal plans, the other 35 strontium capsules could potentially be returned to the WESF; therefore, they are conservatively included in this EIS analysis for potential processing through the WTP (Claghorn 1996).

The cesium capsules are 6.67 centimeters (2.6 inches) in diameter and 51.1 centimeters (20.1 inches) long, and the strontium capsules are 6.67 centimeters (2.6 inches) in diameter and 52.8 centimeters (20.8 inches) long (Jeppson 1973). The capsules contain approximately 68 million curies of radioactivity, decayed to January 2000 (CEES 2006c).

E.1.2.3.4.2 Process

The Cesium and Strontium Capsule Processing Facility would receive the capsules on a “just-in-time” basis for de-encapsulation and preparation of the waste into a suitable WTP slurry feed. The waste slurry would then be stored in a DST prior to treatment through the WTP. This EIS analyzes the immobilization of the cesium and strontium slurry feed as a separate, 1-year-long WTP campaign; however, the cesium and strontium slurry feed could be mixed with the late-stage tank waste feed for consistency. A simplified cesium and strontium capsule processing flow sheet is provided in Figure E-15.

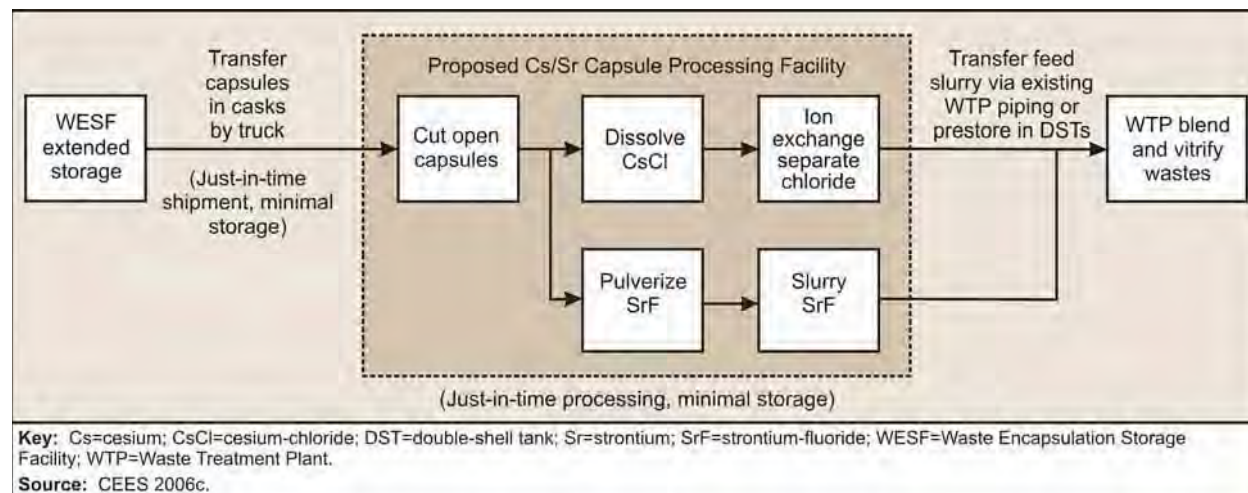

Figure E-15. Simplified Cesium and Strontium Capsule Processing Flow Sheet

TRANSPORTATION OF CAPSULES FROM WESF TO CAPSULE PROCESSING FACILITY

Transportation from the WESF load-out area to the capsule processing facility would require the use of two cask designs. The transportation of cesium and strontium capsules has been successfully accomplished using both government-owned and commercially available shipping casks. Many casks are potentially available to transport cesium and strontium capsules. However, the size limitations of the WESF loading area (G cell), the need to transport a large amount of capsules in each shipment, and the lead time required to certify other casks for capsule transport limit the choices to two shipping casks. One cask, the Beneficial Uses Shipping System (BUSS) cask, is a high-payload 4,000-watt (13,650 British thermal units [Btus] per hour) cask certified by both DOE and the U.S. Nuclear Regulatory Commission (NRC) to transport cesium and strontium capsules. The cask was fabricated specifically for WESF capsules. The BUSS cask is limited to transporting those cesium and strontium capsules certified as “special form” radioactive material.

The other cask, the General Electric Model 2000 (GE-2000), is currently certified by NRC for only 600 watts (2,047 Btus per hour) and its allowable payload did not specifically include cesium or strontium. However, an amended safety analysis has been submitted to NRC, and approval for the

transport of both cesium and strontium capsules with a payload of 2,000 watts (6,824 Btu per hour) is expected.

To meet the just-in-time processing strategy and accomplish the 26-month delivery schedule assumed for the capsule processing facility, both the BUSS and GE-2000 casks would be needed (Claghorn 1996).

DE-ENCAPSULATION OF CAPSULES

Once the casks are received at the capsule processing facility, they would be disassembled, and the double-lined (with the exception of the triple-lined Type W) capsules would be removed from the inner basket. The ends of the metal capsules would then be cut off and the contents slid out of the outer liner. For the cesium capsules, the ends of the inner liners also would be cut off.

Although the same method used to dismantle cesium capsules can be used to cut the strontium outer capsules, the same method cannot be used to cut the strontium inner capsules. Based on experience at Oak Ridge National Laboratory (ORNL) (ORNL 1988), strontium fluoride is usually stuck to the inner Hastelloy capsule wall. The chop saw used to open the strontium inner capsules is modified to make two longitudinal cuts 180 degrees apart on the Hastelloy capsule using a saw with a 0.13-meter (0.43-foot) disc-type blade. Using this procedure, ORNL was able to process about six capsules in three 8-hour shifts.

The solid waste (inner and outer capsule metal lining) generated must be properly packaged and disposed of. It is estimated that the 8,500 kilograms (18,700 pounds) of shredded metal would result in 100 drums of RH solid MLLW for disposal on site.

CESIUM SLURRY FEED PREPARATION

Once exposed by cutting off the ends of the inner capsule liner, the cesium chloride would be dissolved in water, and the chloride removed using an ion exchange. The volume of water needed to process the cesium capsules is conservatively estimated to be approximately 4,540 liters (1,200 gallons), resulting in approximately 5,680 liters (1,500 gallons) of processed solution.

Removal of the chloride from the cesium chloride solution would be required as an additional step prior to introducing the slurry feed into the WTP HLW melters. The process would use an anion exchanger to exchange the chloride ion with hydroxide. Hydroxide is the anion of choice because of the high selectivity of hydroxide to chloride. The chlorine-loaded ion exchange resin would be disposed of as MLLW. The WTP Pretreatment Facility would have similar resin waste, and a similar disposal path could be utilized. There are a number of ion exchange resins that could be used to remove chlorides.

STRONTIUM SLURRY FEED PREPARATION

Strontium fluoride is not water soluble, so it must be pulverized to prepare it for blending with an HLW feed. A hammer and chisel would be used to break the strontium fluoride salt loose from the inner capsule walls. Once the strontium salt is separated from the capsule into several pieces, the pieces would be transferred into a jaw crusher to crush the salt into particles less than 300 micrometers (0.01 inches) (number 50 sieve). The strontium powder then would be transferred to a holding tank as a slurry with suspended solids.

E.1.2.3.4.3 Facilities

The WESF is located in the 200-East Area and consists of the 225-B Building and several other support structures. The WESF was originally designed to process, encapsulate, and store the extracted radionuclides, cesium, and strontium that are generated from other chemical processing operations.

Construction of the WESF started in 1971 and was completed in 1974. Processing of cesium continued until 1983, and strontium processing lasted until 1985. The cesium and strontium capsules at Hanford are currently stored and monitored in pool cells at the WESF. The operations, maintenance, deactivation, and decommissioning of the WESF is not analyzed in this EIS. Data presented in this EIS regarding the WESF are provided for information purposes only.

The capsule processing facility would be located adjacent to the WTP in the 200-East Area, the building would have a footprint of 3,800 square meters (40,500 square feet), and the facility boundaries would encompass 1.6 hectares (3.9 acres). The Cesium and Strontium Capsule Processing Facility would be constructed as a heavily shielded facility. The construction requirements for the capsule processing facility are scaled from the WTP facility data. That scaling factor was increased by 20 percent to account for the increased shielding required in the Cesium and Strontium Capsule Processing Facility.

Based on an operating efficiency of 80 percent, the capsule processing facility's processing rate must be 1,140 capsules per year to de-encapsulate the inventory of cesium and strontium capsules within the 26-month operating time. Transportation of casks from the WESF would be scheduled to provide just-in-time delivery for processing. The capsule processing facility is not currently planned to prestore casks awaiting de-encapsulation.

Once the capsule contents are prepared into an acceptable slurry feed, the slurry would be pumped to the DST system to await feed into the WTP HLW melter. Storage in the DST system would be required because the capsule processing facility would require 26 months of operation to de-encapsulate and prepare the cesium and strontium slurry feed; however, the WTP HLW melter would require only 12 months to vitrify the waste. It would be possible to bypass the DST system and feed the cesium and strontium slurry directly into the WTP; however, this would require additional design modifications to the feed system for the WTP. This EIS assumes prestorage in the DST system. The capsule slurry feed can either be blended with tank waste or fed to the melter as a unique campaign. The vitrification of a distinctly different feed would potentially require a new glass formulation or chemical additives. For determining peak cesium and strontium processing impacts, this EIS assumes the immobilization of the cesium and strontium capsule slurry feed would occur as a separate campaign after all tank waste treatment has been completed (CEES 2006c).

E.1.2.3.4.4 Assumptions and Uncertainties

The following lists the assumptions for the construction, operation, and deactivation of a capsule processing facility that are the basis for this EIS analysis. Discussion of the level of uncertainty associated with each assumption is included.

- The treatment of capsule waste is assumed to be a separate vitrification campaign from the processing of tank HLW. For purposes of analysis, the cesium and strontium slurry feed would be treated as a separate waste stream through the WTP after completing the treatment of all tank waste. It was estimated that the vitrification of cesium and strontium capsule waste into canistered waste that would result in the production of an additional 340 canisters of glass (1.2 cubic meters [42.4 cubic feet] each) that would be stored on site as IHLW. The estimated number of canisters produced (340) is uncertain and may not be consistent with the current glass properties model. Without blending, additional glass-forming or other chemical additives would be required to maintain an acceptable final waste form. Blending the cesium and strontium slurry feed with the tank waste would require the authorization, funding, and construction of the Cesium and Strontium Capsule Processing Facility to be completed, with sufficient WTP operations remaining to support this option. Other analyses suggest that sufficient blending may not lead to an increase in the number of canisters from the inclusion of cesium and strontium capsules in the HLW melter feed stream (i.e., the volume of glass would be constrained by something other than the cesium and strontium).

- Chloride would be removed before treatment at the WTP. The ion exchange resin was conservatively assumed to be a nitrate-based resin as discussed in trade study WHC-SD-WM-ES-382 (Claghorn 1996). The more efficient hydroxide resin, if utilized, could reduce secondary waste considerably.
- Processing rates in the capsule processing facility would be coordinated with WESF packing, load-out, and transportation rates. Facility modifications or additional storage facilities would not be required at the WESF to support capsule load-out.
- The Cesium and Strontium Capsule Processing Facility would be 98.4 meters (30 feet) tall, on average. The facility would have a volume of 34.4 million cubic meters (1,215 million cubic feet), based on the 3,760-square-meter (40,500-square-foot) footprint (Claghorn 1996).
- The transportation of the cesium and strontium capsules would require the use of both the BUSS and the GE-2000 casks to accomplish the transfer of capsules within the 26 months analyzed for operation of the capsule processing facility. Transportation of capsules from the WESF to the capsule processing facility, using both BUSS and GE-2000 cask designs, would rely on an aggressive schedule that assumes the availability of both casks. The transportation casks and the cesium and strontium capsules may have to be recertified. The transportation of capsules was assumed to be direct from the WESF to the capsule processing facility, with no interim storage.
- The resources required to maintain the WESF through the disposition of the capsules were assumed to be the same as these used for normal routine operations and maintenance of the facility. Routine operations and maintenance of the WESF were not analyzed in this EIS (CEES 2006c).

E.1.2.3.5 Supplemental Waste Treatment Options

This TC & WM EIS analyzes three representative technologies out of the several viable options for accomplishing the supplemental treatment and immobilization of the LAW. These three waste treatment options, bulk vitrification, cast stone, and steam reforming, were among the technologies selected for further testing and evaluation when DOE sought to identify candidate technologies for accelerating the tank waste cleanup schedule.

E.1.2.3.5.1 Supplemental Technology Selection

Technologies for treating Hanford tank waste have been researched and evaluated for a number of years. A systematic review of possible technologies was conducted in the early 1990s and resulted in the issuance of the TWRS EIS (DOE and Ecology 1996) and a subsequent Record of Decision (ROD) (62 FR 8693). These documents were reviewed again in early 2002. Vendors, national laboratories, and universities were consulted regarding additional technologies for the purpose of establishing a list of possible LAW treatment technologies. Only technologies that could meet the criterion of closing the LAW treatment gap by accelerating cleanup and reducing risk while maintaining cleanup quality were retained for further consideration.

In March 2002, the Cleanup Challenge and Constraints Team (C3T) was established through a Memorandum of Understanding between DOE and Ecology. As part of the C3T, a Mission Acceleration Initiative (MAI) working group was formed to select candidate supplemental technologies to augment the WTP.

**Draft Tank Closure and Waste Management Environmental Impact Statement for the
Hanford Site, Richland, Washington**

The technologies were grouped into families that employed the same basic principles, but differed in their implementation (i.e., all calcination technologies were grouped together and all polymer-based microencapsulation technologies were grouped together). Tank 241-S-112 was selected as a good representative for the targeted LAW source SSTs.

Technology experts prepared a short briefing on each technology and its application to treatment of tank 241-S-112 waste. Additionally, separations technologies were combined with immobilization technologies to constitute complete treatment options.

In April 2002, DOE evaluated over 50 options for potential supplemental technologies. Their results were documented in the **Mission Acceleration Initiative Demonstration Information Package** (CH2M HILL 2003a). The results were reviewed by ORP representatives, who selected the following seven representative technology options, two with two suboptions, for more-detailed evaluation.

- Bulk vitrification
- Active-metal reduction
- Steam reforming
- Clean salt
 - Without cesium ion exchange
 - With cesium ion exchange
- Clean salt and sulfate removal
 - Without cesium ion exchange
 - With cesium ion exchange
- Cast stone
- Sulfate removal

Technical data for the seven options were developed, and the Hanford C3T MAI subgroup performed the final evaluation to select appropriate technologies for further development. Details of the selection process can be found in the **Evaluation of Low-Activity Waste Feed Supplemental Treatment Options by the C3T Mission Acceleration Initiative Team for the Office of River Protection** (Choho and Gasper 2002).

The evaluation criteria used for the final selection of candidate technologies were based on compliance and safety, project utility, operability, technical risk, and programmatic risk. A workshop was held to define the supplemental treatment goals, criteria, and measures by which performance could be judged versus the criteria. The team established six goals, 10 selection criteria, and 14 measures to guide the technology evaluation selection process. The six goals were to (1) ensure worker and public safety; (2) provide environmental protection comparable to the current vitrified waste disposal plan; (3) maximize schedule acceleration; (4) maximize cost-effectiveness; (5) maximize operability; and (6) minimize overall system interface impacts.

Using both qualitative and quantitative measures to score the technologies with respect to the goals and criteria, the MAI subgroup selected the following three LAW immobilization approaches for further development.

- Bulk vitrification
- Cast stone
- Steam reforming

Additionally, the subgroup selected one pretreatment option, sulfate removal, for further development.

The alternatives analyzed in this TC & WM EIS use the cast stone process to represent supplemental LAW treatment technologies that do not require heat for solidification of the waste (i.e., a nonthermal treatment process). Bulk vitrification and steam reforming are technologies that require heat input for waste solidification. In the TC & WM EIS alternatives, bulk vitrification and steam reforming are the STPs used to represent the thermal treatment technologies. Sulfate removal is also included in one of the alternatives as a pretreatment process outside the WTP. The following sections describe the supplemental LAW treatment technologies included in the alternatives analyzed in this TC & WM EIS.

Complete descriptions for supplemental treatment options are presented in the following sections: thermal treatment – bulk vitrification (see Section E.1.2.3.6); nonthermal treatment – cast stone (see Section E.1.2.3.7); thermal treatment – steam reforming (see Section E.1.2.3.8); sulfate removal (see Section E.1.2.3.9); technetium-99 removal (see Section E.1.2.3.10); and mixed TRU waste processing (see Section E.1.2.3.11). The level of maturity for each technology is also discussed in these sections.

Technologies that were not analyzed in detail in this EIS (see Section E.1.3) are not precluded from selection as supplemental treatment technologies to treat tank waste. As information matures so the candidate technologies can be evaluated at relative parity by the decision makers, technologies other than those analyzed in detail by this EIS may be chosen for use. The known impacts of any candidate treatment technology can be evaluated against the impacts of the technologies analyzed in detail by this EIS. Impacts of the technology would be evaluated relative to the impacts in this EIS, and additional National Environmental Policy Act (NEPA) analysis would be required before selection of that treatment technology.

E.1.2.3.5.2 Separations Activities

Each of the TC & WM EIS alternatives that include use of supplemental treatment technologies in the 200-East Area of Hanford would include use of the pretreatment capability provided by the WTP. In contrast, waste feeds for supplemental treatment technologies used in the 200-West Area would not undergo WTP pretreatment, but would instead be subject to solid-liquid separations activities. These activities would primarily entail the application of a solid-liquid separations process that would be conducted in a new 200-West Area Solid-Liquid Separations Facility using waste feed from 35 SSTs that have tentatively been identified to contain cesium-137 concentrations of less than 0.05 curies per liter (0.19 curies per gallon) (see Table E-6). Waste contained in many of the 35 tanks was received from processing facilities that removed radionuclides such as cesium, strontium, and TRU waste. The extent of separations activities would depend on the waste feed being processed and the immobilization operation being used.

The designation of the contents of the 35 tanks listed in Table E-6 as LAW is based on the analysis found in the Technical Basis for Classification of Low-Activity Waste Fraction from Hanford Site Tanks, which stated that recovery of waste containing less than 0.05 curies per liter of cesium-137 was not economically practical (Petersen 1996). At this concentration of cesium, no more than 5 million curies of cesium-137 would be disposed of in the ILAW glass. In accepting the DOE information, NRC concurred with this analysis.

Draft Tank Closure and Waste Management Environmental Impact Statement for the
Hanford Site, Richland, Washington

Table E-6. Designation of Low-Activity Waste Tanks

| Tank | Cesium-137 (curies per liter for 7 molar sodium solution) | Sodium (kilograms) | Sodium/Cesium (molar ratio) | Cesium-137 (curies) |
|--------------|---|-----------------------|--------------------------------|----------------------------|
| 241-TX-106 | 0.050 | 4.39×10 ⁵ | 3.00×10 ⁵ | 189,000 |
| 241-BY-110 | 0.049 | 4.67×10 ⁵ | 3.03×10 ⁵ | 199,000 |
| 241-TX-103 | 0.049 | 1.83×10 ⁵ | 3.04×10 ⁵ | 77,700 |
| 241-TX-108 | 0.046 | 1.62×10 ⁵ | 3.20×10 ⁵ | 65,300 |
| 241-TX-105 | 0.046 | 7.40×10 ⁵ | 3.25×10 ⁵ | 294,000 |
| 241-TX-115 | 0.045 | 7.12×10 ⁵ | 3.29×10 ⁵ | 279,000 |
| 241-TX-112 | 0.043 | 8.19×10 ⁵ | 3.42×10 ⁵ | 309,000 |
| 241-TX-110 | 0.043 | 5.80×10 ⁵ | 3.45×10 ⁵ | 217,000 |
| 241-S-110 | 0.042 | 4.82×10 ⁵ | 3.49×10 ⁵ | 178,000 |
| 241-TX-111 | 0.042 | 4.44×10 ⁵ | 3.51×10 ⁵ | 163,000 |
| 241-B-104 | 0.042 | 2.24×10 ⁵ | 3.55×10 ⁵ | 81,300 |
| 241-BY-103 | 0.041 | 5.68×10 ⁵ | 3.59×10 ⁵ | 204,000 |
| 241-TX-114 | 0.040 | 6.81×10 ⁵ | 3.75×10 ⁵ | 234,000 |
| 241-BY-109 | 0.036 | 3.25×10 ⁵ | 4.07×10 ⁵ | 103,000 |
| 241-BX-111 | 0.036 | 2.47×10 ⁵ | 4.15×10 ⁵ | 76,800 |
| 241-BY-111 | 0.033 | 4.58×10 ⁵ | 4.51×10 ⁵ | 131,000 |
| 241-BY-102 | 0.033 | 4.29×10 ⁵ | 4.53×10 ⁵ | 122,000 |
| 241-BX-110 | 0.031 | 2.74×10 ⁵ | 4.83×10 ⁵ | 73,200 |
| 241-BY-105 | 0.030 | 6.90×10 ⁵ | 4.92×10 ⁵ | 181,000 |
| 241-TX-117 | 0.027 | 5.80×10 ⁵ | 5.42×10 ⁵ | 138,000 |
| 241-BY-112 | 0.027 | 5.94×10 ⁵ | 5.51×10 ⁵ | 139,000 |
| 241-TX-118 | 0.027 | 3.01×10 ⁵ | 5.58×10 ⁵ | 69,600 |
| 241-S-112 | 0.026 | 9.83×10 ⁵ | 5.61×10 ⁵ | 226,000 |
| 241-BY-108 | 0.025 | 2.33×10 ⁵ | 5.82×10 ⁵ | 51,600 |
| 241-B-107 | 0.018 | 1.49×10 ⁵ | 8.39×10 ⁵ | 22,900 |
| 241-B-106 | 0.017 | 7.07×10 ⁴ | 8.77×10 ⁵ | 10,400 |
| 241-TX-116 | 0.017 | 7.08×10 ⁵ | 8.78×10 ⁵ | 104,000 |
| 241-TY-102 | 0.015 | 8.74×10 ⁴ | 9.97×10 ⁵ | 11,300 |
| 241-B-109 | 0.011 | 1.57×10 ⁵ | 1.32×10 ⁶ | 15,300 |
| 241-B-105 | 0.011 | 3.26×10 ⁵ | 1.36×10 ⁶ | 30,900 |
| 241-B-103 | 0.011 | 5.79×10 ⁴ | 1.37×10 ⁶ | 5,440 |
| 241-B-101 | 0.011 | 1.11×10 ⁵ | 1.39×10 ⁶ | 10,300 |
| 241-S-109 | 0.007 | 7.71×10 ⁵ | 2.09×10 ⁶ | 47,600 |
| 241-TX-113 | 0.004 | 9.18×10 ⁵ | 3.51×10 ⁶ | 33,700 |
| 241-T-109 | 0.003 | 5.74×10 ⁴ | 5.65×10 ⁶ | 1,310 |
| Total | | | | 4.09×10⁶ |

Note: To convert kilograms to pounds, multiply by 2.2046.

Source: DOE 2003g.

The TC & WM EIS mass balances (CEES 2007b) model all 35 LAW tanks identified in Table E-6 through the 200-West Area Solid-Liquid Separations Facility before treatment using the 200-West Area STPs (bulk vitrification, cast stone, or steam reforming). While it is recognized that some of the waste tanks are located in the 200-East Area, for analysis purposes, the waste in all 35 tanks was assumed to require 200-West Area Solid-Liquid Separations Facility pretreatment. Similarly, for analysis purposes, the option for cesium ion exchange in the 200-West Area Solid-Liquid Separations Facility was not exercised; therefore, the mass balances provide conservative estimates of the cesium-137 contribution to the 200-West Area STPs and their waste products (bulk vitrification glass, cast stone product, steam reforming product). The remaining 114 SSTs and DST waste would be pretreated in the WTP.

This solid-liquid separations (settling and decanting) was assumed to return 50 percent of the solids to the WTP for processing. Strontium and TRU waste would be precipitated with a chemical addition during this settling process resulting in a portion of the strontium-90 and TRU waste radionuclides being forwarded to the WTP and the balance forwarded to the STP in the 200-West Area.

Some precipitation, settling, and decanting could be conducted in the existing underground storage tanks. However, this TC & WM EIS assumes that all separations activities would occur in the 200-West Area Solid-Liquid Separations Facility (DOE 2003e).

E.1.2.3.6 Thermal Supplemental Treatment Technology – Bulk Vitrification

The bulk vitrification process is one of two representative thermal supplemental treatment technologies (the other is steam reforming) analyzed in this EIS. Bulk vitrification is a technology that is currently being used domestically and internationally for radioactive, hazardous, and mixed waste treatment. Bulk vitrification can be accomplished in-situ or in large containers. The application of bulk vitrification to tank waste can only be performed by use of the In-Container Vitrification™ (ICV™) process. Waste vitrified in large containers offers several advantages. The content of the incoming waste stream is carefully controlled and homogenized, resulting in a more reliable final waste form. The final waste form is also characterized by small surface-to-volume ratios, which minimizes the potential for waste form leaching. In-container bulk vitrification would be used to supplement the treatment of LAW.

Bulk Vitrification Facilities may be placed in one or both of the 200-East and the 200-West Areas as necessary to supplement the current WTP configuration and capacity. The construction and operation of a Bulk Vitrification Facility in the 200-East Area is analyzed under Tank Closure Alternative 3A. The construction and operation of a Bulk Vitrification Facility in the 200-West Area is analyzed under Tank Closure Alternatives 3A, 4, and 5.

The 200-East Area Bulk Vitrification Facility would be located near the WTP and would accept a fraction of the LAW generated from the WTP Pretreatment Facility. The 200-East Area Bulk Vitrification Facility would provide supplemental treatment to the WTP by immobilizing up to 37 percent of the tank waste sodium (approximately 18,000 metric tons of sodium) currently existing in the Hanford tank system. However, the 200-East Area Bulk Vitrification Facility would actually be required to process more than the 18,000 metric tons of sodium tank waste due to the addition of nonwaste sodium during the WTP pretreatment step. Approximately 5,500 metric tons of sodium would be added to the supplemental treatment waste stream during the WTP pretreatment step. The WTP Pretreatment Facility is designed to accept high-curie waste feed from the DST system and to separate the tank waste into HLW and LAW fractions.

The 200-West Area Bulk Vitrification Facility would immobilize up to 32 percent of the tank waste sodium (approximately 15,000 metric tons of sodium) consisting of pretreated waste from the 35 SSTs with low cesium-137 concentrations (listed in Table E-6 and discussed in Section E.1.2.3.5.2). These 35 SSTs are located in both the 200-East and 200-West Areas and contain approximately

15,000 metric tons of sodium. Waste feeds for supplemental treatment technologies used in the 200-West Area would be subject to solid-liquid separations activities consisting of a settling and decanting process to reduce the solids content of the waste received from the LAW tanks. The settling and decanting step were assumed to return 50 percent of the solids to the WTP for processing (CH2M HILL 2004).

E.1.2.3.6.1 Technology Description

Bulk vitrification would use an ICVTM process. Pretreated tank waste, or retrieved waste with low radioactivity, would be used as feed for the ICVTM process. The waste would be mixed with soil or with other glass formers, such as those planned for use in the WTP LAW melters. The mixture would be dried to optimize the process, and the excess water would be treated in the ETF. After mixture with additional soil additives, the dried mixture would then be vitrified in a steel box. Once the vitrification process is complete, soil would be used to fill the void spaces and the steel box would be sealed. The steel box would also serve as the final disposal container. During the melt process, air emissions would be collected by a sealed container hood and would be directed to an offgas treatment system. The secondary waste generated by the offgas treatment system (e.g., filters, liquid effluents) would be stabilized, packaged for disposal, or otherwise directed to another treatment facility. A flow diagram of the production-scale bulk vitrification process appears in Figure E-16.

E.1.2.3.6.2 Process

The ICVTM process would be the final treatment for the tank waste, prior to final disposition on site. The description that follows is based upon use of soil and/or sand as glass-forming materials. However, if necessary to meet performance requirements, other glass formulations, including those used in the WTP LAW melters, could be used in the bulk vitrification system. The bulk vitrification process would only receive LAW either from the WTP pretreatment system or the 200-West Area solid-liquid separations pretreatment process.

In the bulk vitrification process, the LAW feed would be mixed with soil and/or sand prior to vitrification. In the initial processing step, the incoming waste stream would be mixed with approximately 20 percent of the total amount of soil and/or sand required to complete the process. A vacuum drying process would be used to remove free water from the mixture. The dryer would utilize an internal waste blending and agitation process to convert the mixture into a granular form. Prior to loading the waste feed into the vitrification container, the remaining 80 percent of soil and/or sand would be added in a mixer.

The amount of soil and/or sand addition would be predetermined to achieve approximately 20 weight-percent sodium oxide loading in the final glass waste form. Graphite would be added to the mixture for electrical conductivity to start the vitrification process. The dried waste and soil/sand mixture would then be conveyed to the vitrification container.

Graphite electrodes would be used to melt the waste and sand/soil mixture in the container. An electrical current would be applied to heat and melt the mixture to produce glass. The operating temperature of the melt would be approximately 1,600 °C (2,900 °F).

The Bulk Vitrification Facility is currently configured with parallel processing lines that could process more than one vitrification container at a time. The standard vitrification container would be a steel roll-off box modified for this specific purpose. After completion of the melt, the container would be topped off with clean soil to fill the void spaces, allowed to cool, and then sealed.

The container would be a rectangular, steel box approximately 2.4 meters wide by 3.0 meters high by 7.3 meters long (8 feet wide by 10 feet high by 24 feet long). Each container would hold an estimated 42.6 metric tons of glass. The final dimensions of the containers may change during detailed design of the facilities.

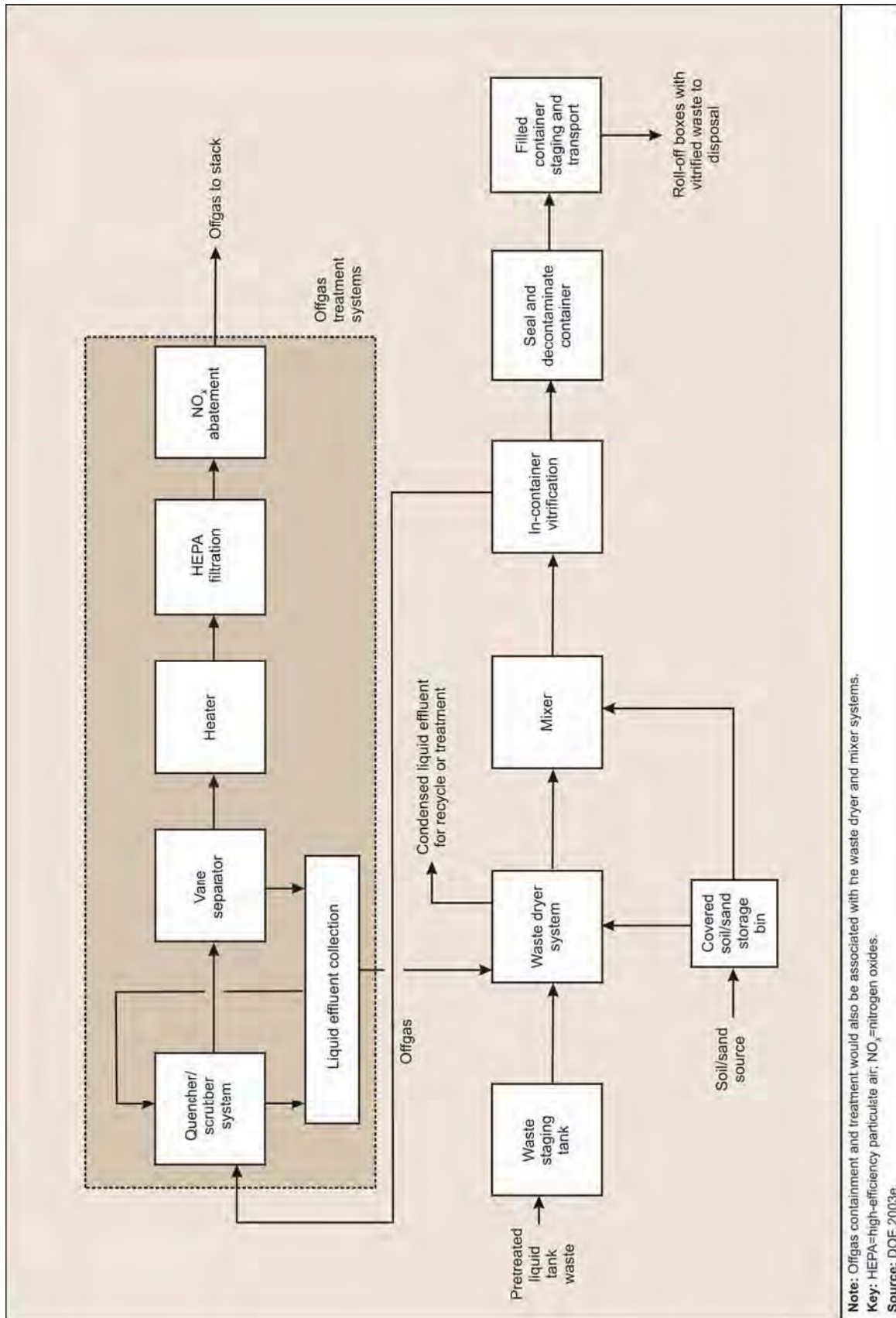

Figure E-16. Bulk Vitrification Supplemental Treatment Process Flow Diagram

The process of vitrifying the waste would result in volume reduction as a result of the loss of volatile components and reduction of void space during the melting process. The waste volume could be reduced by one-third to one-half by the melting process. As a result, additional waste feed may be added to the container during the melt step. At completion of the melt, the amount of vitrified waste in each container would be roughly 50 to 60 percent of the container volume. The remaining space in the container would be taken up by a perimeter insulating barrier consisting of sand and/or refractory material and soil and/or sand added on top of the vitrified waste to fill void space, prior to sealing the container. The perimeter insulating barrier is expected to be 31 centimeters (12 inches) thick to separate the vitrified waste from the container walls. The purpose of the insulating barrier is to retain heat, ensuring a thorough melt, and to maintain the integrity of the container, ensuring worker safety. The contents of the filled and sealed container would be cooled for approximately 3 days and then transferred to an IDF for near-surface burial (DOE 2003e).

The high-temperatures associated with the vitrification process would generate an offgas stream that would require treatment. Nonradioactive offgas emissions would include nitrogen oxides, sulfur oxides, chlorides, fluorides, organics, water, and mercury. Radioactive emissions would potentially include carbon-14, iodine-129, hydrogen-3 (tritium), and smaller fractions of volatile radionuclides such as technetium-99.

The offgas treatment system would consist of a series of unit operations to control emissions of selected offgas constituents. Filters, scrubbers, condensers, and selective catalytic reduction would be used to treat the offgas before discharge into the atmosphere through a stack. The offgas would be directed to a quenching and scrubber system to cool the offgas, remove particulates, and neutralize the sulfur oxides, chlorides, and fluorides. The scrubber solution would be recycled if feasible and/or may be treated and disposed of separately. Sintered metal filtration may be employed to remove particulate emissions prior to introduction into the quenching and scrubber system. Particulates removed by sintered metal filtration would be recycled back into the dryer for mixing with waste feed. Tritium and water would be condensed from the offgas. The scrubbed offgas would then enter a series of two HEPA filters for final particulate removal. After passing through the HEPA filters, a high-efficiency gas adsorber could be used to remove radioactive iodine and organic carbon prior to entering the final offgas treatment unit. The final step in offgas treatment would be removal of nitrous oxides through selective catalytic reduction. Removal of mercury in the offgas stream, if necessary, could be accomplished by adding an activated carbon system. For analysis purposes, this EIS assumes a mercury abatement technology would be applied, resulting in a solid waste stream with the mercury that would be disposed of in an IDF. In addition, in estimating air emissions impacts, this EIS assumes no mercury abatement.

E.1.2.3.6.3 Facilities

The exact locations of the Bulk Vitrification Facilities, if constructed, have not been determined. For purposes of evaluation, it was assumed that the Bulk Vitrification Facilities would be located northeast of the 202-S Reduction-Oxidation (REDOX) Facility in the 200-West Area and/or in the 200-East Area near the WTP. In practice, the Bulk Vitrification Facilities could be built in other locations in the 200-West or 200-East Areas. See Figure E-11 for proposed locations of the supplemental treatment facilities in the 200-East and 200-West Areas.

The Bulk Vitrification Facilities would contain separate areas for processing and supporting equipment and personnel. The processing equipment areas that handle tank waste would be inside shielded cells or shielded rooms. Supporting process systems such as the process offgas system would also be in shielded areas. The building ventilation systems would be within the reinforced area of the main structure and within the secondary containment system.

Support systems such as the generator and compressor systems and water chiller would be outside of the reinforced structure. Other systems outside of the reinforced structure would include the power supply skid for the vitrification system and a covered soil storage bin. Figure E-17 illustrates a typical Bulk Vitrification Facility process layout.

PROCESS AREAS

The Bulk Vitrification Facilities would consist of multiple structures containing processing and supporting equipment and personnel. The Bulk Vitrification Facilities would include the following process systems:

- Feed receipt and mixing with soil and/or sand
- Waste drying
- Vitrification
- Container sealing and decontamination
- Filled-container staging and transport
- Offgas treatment

Each Bulk Vitrification Facility would contain parallel and independent vitrification process trains. The containers used for vitrification would be loaded one at a time into the shielded area through an airlock. A rail system would be used to move the containers into and through the process area. The process offgas system would be connected to the bulk vitrification container lid. The main process area would have enough space for three containers in each of the parallel processing lines, one container in the filling position, one in the vitrification position, and one in the initial cooldown position. The vitrification step is estimated to take approximately two days to complete. After initial cooldown, each container would be moved into an airlock for final cooling. After final cooling, the container would be moved to a final inspection area outside of the shielded process area. Truck bays on each end of the vitrification process line would be provided for delivery and removal of the vitrification containers.

The remaining shielded process area would be used for receipt and mixing of the tank waste. Waste retrieved from a tank or pretreated waste from the WTP or the solid-liquid separations process would be transferred to a tank where soil and sand would be mixed with the waste, dried, and then added to the vitrification container. The drying and mixing equipment would be located above the vitrification process lines and would be connected to the offgas containment and treatment system.

PROCESS SUPPORT AREAS

The process support areas would contain the building offgas system, including parallel systems for air movement and filtration. These systems would be within the main process facility, but outside of the shielded process areas. Other process support equipment would be located outside of the main process facility structure.

A maintenance shop, offices, control room, and change rooms would be used for the facility operations and maintenance personnel. These facilities would be located outside the main process structure. The construction contractor may erect temporary facilities during construction of the Bulk Vitrification Facilities. Typically, these facilities would be limited to trailers used as construction site offices and change and restroom facilities for the construction workers (DOE 2003e).

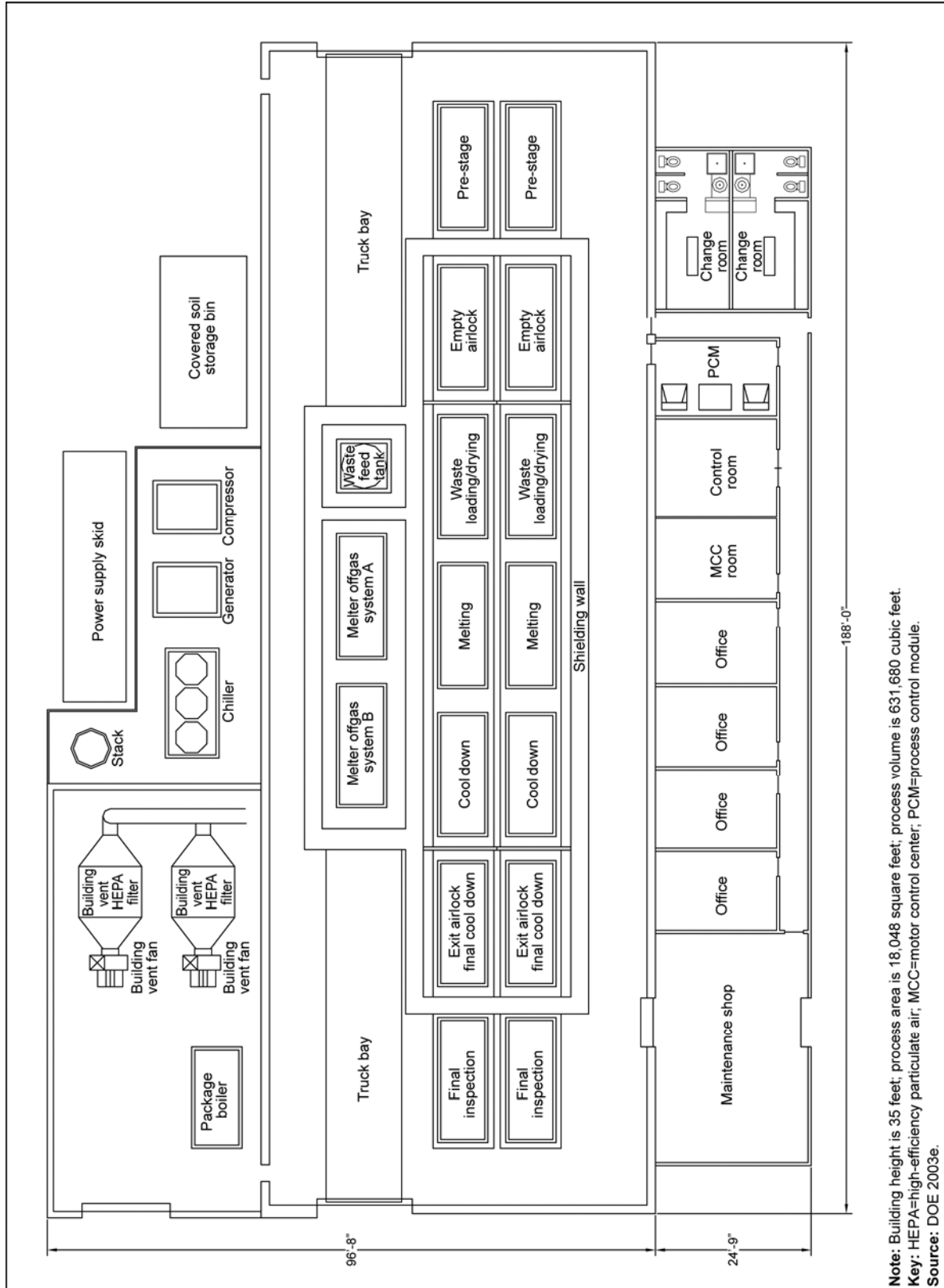

Note: Building height is 35 feet; process area is 18,048 square feet; process volume is 631,680 cubic feet.
Key: HEPA=high-efficiency particulate air; MCC=motor control center; PCM=process control module.
Source: DOE 2003e.

Figure E-17. Supplemental Treatment Bulk Vitrification Facility Layout

E.1.2.3.6.4 Waste Form/Disposal Package

PRIMARY WASTE

The disposal container for vitrified tank waste would be a roll-off box, a large rectangular steel container designed to be moved after filling. For analysis purposes, the container's dimensions were assumed to be 2.4 meters wide by 3.0 meters high by 7.3 meters long (8 feet wide by 10 feet high by 24 feet long), resulting in a volume of 54.3 cubic meters (71.1 cubic yards). The container would be lined on the bottom and sides with approximately 31 centimeters (12 inches) of insulating material before the waste mixture is added, reducing the effective volume for storing immobilized waste glass. The insulating material would be specifically selected soil and/or sand or other refractory material characterized by a high melting temperature and low conductance of heat. The surface temperature of the insulating material next to the waste would be monitored during the vitrification process. After vitrification of the waste, the containers would be staged to allow cooling before transfer to the disposal site. Each container, upon completion of the melt, would contain approximately 42.6 metric tons of glass, and the total container payload, including container and insulating layers, was estimated to weigh approximately 110 metric tons (Ecology 2005; May et al. 2004). The density of glass formed by the bulk vitrification process was assumed to be 2,500 kilograms per cubic meters (156 pounds per cubic feet). Approximately 3 days of cooling would be required to reach the desired external surface temperature prior to transporting the containers for final disposition.

The primary components of the bulk vitrification glass are soluble sodium and aluminum compounds. The soil mixed with the waste would be primarily aluminum silicate, and the sand would provide a source of additional silica. The final form after treatment would be a vitrified mass of sodium aluminum silicate (borosilicate glass), with minor components and contaminants chemically bonded and encapsulated within the glass matrix.

In general, bulk vitrification glass can be formulated at a higher waste loading than ILAW glass, due in part to the higher melting temperatures that can be achieved. The higher temperature can overcome viscosity constraints that normally affect WTP melters. Moreover, because bulk vitrification melters are essentially one-time-use equipment, they are not subject to other glass formulation constraints such as melter refractory corrosion and buildup of crystalline phases over time. It is estimated that an approximate 20 weight-percent sodium oxide loading in the final glass waste form can be achieved (CEES 2007b).

Quantities of primary waste generated by the bulk vitrification process for each alternative are provided in Section E.1.2.4.

Waste Form Performance

Bulk vitrification containers are planned to be disposed of at Hanford in an IDF. The final waste acceptance criteria have not been established; however, it was assumed that the criteria would be consistent with the HSSWAC (Bagaasen, Westsik, and Brouns 2005; Fluor Hanford 2005a).

The bulk vitrification glass container in its final packaged waste form would be required to meet certain physical limitations prior to acceptance for disposal in an IDF. Some of these physical requirements include a mass of less than 85 metric tons, less than 10 percent void space, and an external surface temperature of the package below 50 °C (122 °F) (Bagaasen, Westsik, and Brouns 2005). Currently, the Demonstration Bulk Vitrification System (DBVS) design criteria estimates the mass of the waste container at nearly 110 metric tons. Either the IDF criteria would need to be relaxed to permit the heavier bulk vitrification containers, or the size and mass of the final design container would need to be reduced accordingly.

Bulk vitrification glass can be formulated to achieve performance that meets requirements established for ILAW glass. The performance of bulk vitrification glass would continue to be evaluated during the scheduled operation of a full-scale testing facility using actual Hanford tank waste from tank 241-S-109 (see Section E.1.2.3.6.6). The rate of release of hazardous constituents depends strongly on the nature of the waste form used to immobilize the constituents. The nature of the waste forms, analysis for long-term performance assessment, and the methods used to estimate release rates and the values of parameters that characterize release rates from the bulk vitrification glass are presented in Appendix M.

SECONDARY WASTE

Secondary waste expected from bulk vitrification operations would include solid waste from routine operations and liquid effluents. An example of solid waste would be filtering media from the offgas treatment systems and debris waste. Liquid effluents generated from the offgas treatment system would be collected and sent to the ETF for treatment with the resultant grouted waste form disposed of in an IDF. Condensed liquid effluent from the waste dryer system would consist primarily of water generated at a rate of 870 kilograms (1,900 pounds) per hour. This condensed liquid effluent would be sent either to the DSTs or to the ETF.

E.1.2.3.6.5 Assumptions and Uncertainties

The waste acceptance criteria for bulk vitrification glass has not been established; however, it was assumed that the criteria would be consistent with the HSSWAC (Bagaasen, Westsik, and Brouns 2005; Fluor Hanford 2005a). The preliminary design of the vitrification container, as detailed in the DBVS (see Section E.1.2.3.6.6), has an estimated mass of 110 metric tons; however, the IDF acceptance criteria limits disposal of packaged units to 85 metric tons.

The capture of several select radionuclides in the final waste form product is an important consideration when evaluating the performance of the bulk vitrification process as a potential supplemental thermal LAW treatment option. The high temperatures associated with the thermal bulk vitrification process would cause some of the select radionuclides to offgas and be captured in secondary waste streams. The assumed fractions of select radionuclides between final waste form product and secondary waste streams as a percentage of the feed stream to the bulk vitrification process are provided in Table E-7.

The behavior of technetium-99 and iodine-129 in thermal processes and the fractions that would be captured in the final waste form are difficult to predict. Therefore, these fractions were assumed based on ORP guidance (CEES 2007a:Attachments 2 and 3). This is in contrast to the use of the HTWOS simulations partitioning factors for the other radiological COPCs. Further demonstration and testing of this technology should provide the necessary performance data to confirm these assumptions. If necessary, design changes may have to be implemented should the actual fractions in secondary waste streams be demonstrated to be higher than anticipated. Carbon-14 is highly volatile and would produce very high fractions in the offgas. Incorporation of treatment technologies may be required in the final facility design to reduce these emissions. The select radionuclides that exist in particulate form would be recycled back into the waste feed.

Engineering-scale testing of the bulk vitrification process suggests that some modifications may be required to the final production facility design to eliminate some unfavorable final waste form characteristics. During engineering-scale and large-scale testing, results suggested that technetium-99 might present itself in a more soluble form deposited as a vesicular glass layer on top the bulk vitrification melt (Pierce et al. 2005). This would affect the release rates from the final waste form in an IDF. The very high temperatures associated with bulk vitrification volatilize and drive off technetium-99 from the waste feed prior to its incorporation into the vitrified glass matrix. The volatilized technetium-99 then condenses on the surface of the melt prior to being carried away in the offgas (Pierce et al. 2005).

Table E-7. Partitioning Factors of Radiological Constituents of Potential Concern in Bulk Vitrification Glass^a

| Radiological Constituent of Potential Concern | Percentage of BV Feed in BV Glass | Percentage of BV Feed in Liquid Secondary Waste |
|---|-----------------------------------|---|
| Iodine-129 ^b | 20.0 | 80.0 |
| Cesium-137 | 99.5 | 0.0 |
| Carbon-14 | 0.0 | 0.1 |
| Uranium-233 | 99.9 | 0.1 |
| Uranium-234 | 99.9 | 0.1 |
| Uranium-235 | 99.9 | 0.1 |
| Neptunium-237 | 99.9 | 0.1 |
| Uranium-238 | 99.0 | 0.1 |
| Plutonium-239 | 100.0 | 0.0 |
| Plutonium-240 | 100.0 | 0.0 |
| Hydrogen-3 (tritium) | 0.0 | 99.8 |
| Strontium-90 | 100.0 | 0.0 |
| Technetium-99 ^c | 93.4 | 0.1 |

^a Totals may not equal 100 percent due to rounding.

^b The partitioning factors for iodine-129 were directed by ORP (CEES 2007a:Attachment 3).

^c The partitioning factors for technetium-99 were directed by ORP (CEES 2007a:Attachment 2). This direction included the assumption that 6.5 percent of technetium-99 resides in the waste container insulating material or waste container in a leachable form. This 6.5 percent is not included in the 93.4 percent BV glass percentage.

Key: BV=bulk vitrification; ORP=Office of River Protection.

Source: Data extracted from CEES 2007a.

Another engineering-scale study of the bulk vitrification process suggested that metal inclusions in the final waste form may corrode and increase release rates of technetium-99 from the final waste form (Bacon et al. 2006). It is expected that these final waste form challenges can be overcome through careful process control and modifications to the final process design.

E.1.2.3.6.6 Demonstration Bulk Vitrification System Project

The DBVS is a full-scale test facility that would receive waste from the tank 241-S-109, mix the waste with soil, dry the soil/waste mixture, and blend in glass former additives to produce a dried waste/additive mixture. The DBVS would then use the ICVTM process to convert the dried mixture into boxes of vitrified waste. The ICVTM waste would be cooled and interim-stored until the containers are transferred to an IDF for disposal. The DBVS would treat the process offgas to a level that protects human health and the environment and meets applicable requirements. Secondary liquid waste would be filtered and sent to the ETF for treatment and disposal. The process systems would include the following (CH2M HILL 2006a):

- Clean Soil System
- Waste Receipt System
- Waste Mixer/Dryer and Condensate Recovery Systems
- Dried Waste Handling System
- ICVTM System
- Offgas Treatment System
- Secondary Waste Storage System

The DBVS final design was completed in 2006, and initiation of construction is currently not scheduled. The work is being conducted under a research, development, and demonstration permit issued by Ecology. Fifty bulk vitrification containers are scheduled for production during the DBVS project (Bagaasen, Westsik, and Brouns 2005).

The current design for the DBVS process is consistent with the preliminary conceptual design for the production-scale Bulk Vitrification Facilities, with one notable exception. The DBVS design utilizes a one-step soil addition process, whereas the production-scale process would add soil amendments in two steps. The two-step soil addition process should result in a more uniform waste feed and more favorable final waste form. Final design of the Bulk Vitrification Facilities as a supplemental technology to the WTP would be largely determined by the results of the DBVS project.

The overall mission drivers for the DBVS Project are included in the Justification of Mission Need for the DBVS Project, which was approved by DOE in July 2006. The mission-need document requires that the DBVS Project complete the following actions:

- Process approximately 720,000 liters (190,000 gallons) of tank 241-S-109 waste into fifty 100-metric-ton boxes of vitrified product.
- Store and dispose of these boxes at the Hanford 200-East Area IDF (IDF-East).
- Evaluate the waste form characteristics.
- Gather pilot plant operability data.
- Develop the overall life-cycle system performance of bulk vitrification and produce a comparison of the bulk vitrification process to building a second LAW immobilization facility or other supplemental treatment alternatives as provided in TPA Milestone M-62-08 (CH2M HILL 2006a; Ecology, EPA, and DOE 1989).

E.1.2.3.6.7 Demonstration Bulk Vitrification System Technical Review

In May 2006, CH2M HILL Hanford Group, Inc., chartered an Expert Review Panel to review the current status of the DBVS. It was the consensus of the Expert Review Panel that bulk vitrification is a technology that requires further development and evaluation to determine its potential for meeting the Hanford waste stabilization mission (CH2M HILL 2006a). No fatal flaws (issues that would jeopardize the overall DBVS mission that cannot be mitigated) were found. However, a number of technical issues were found that could significantly affect the ability of the process to meet its overall mission, as stated in the project's Justification of Mission Need document, if not satisfactorily resolved.

The following is a summary of the key issues identified by the Expert Review Panel (CH2M HILL 2006a) that need technical and management actions.

- Additional cold testing is needed to underpin process design and operations (e.g., flow of dried waste feed, prevention of secondary phases, and balancing of the offgas systems) before radioactive feed is introduced.
- The mixer-dryer and offgas systems need special attention in the next project phase, as most of the development work to date has been focused on the ICVTM process.
- System complexity should be reduced to enhance system operability and availability.

- Process sampling and monitoring plans should be improved to ensure that essential operational and needed R&D data from DBVS test runs are captured.
- A better understanding of the DBVS process flowsheet from a chemical point of view is critical to success, both in building a high reliability production plant and in troubleshooting and recovering from any problems that may occur during operation.
- The feed compositions to be tested in the DBVS Project should reflect the spectrum of wastes expected to be processed by bulk vitrification so that a comparison to other supplemental treatment alternatives can be made.
- Potential nuclear safety issues, including confinement strategy, implementation of Integrated Safety Management, and responses to off-normal events, need to be resolved before startup of radioactive waste processing.
- The project needs to ensure that its design and specifications meet the required codes and standards.
- The risk identification and management process has been developed, needs to be improved, and must be effectively utilized in future stages of the project.

The Expert Review Panel identified the following:

- Nineteen technical issues that could result in a failure of the DBVS demonstration system to meet established DBVS system performance requirements unless addressed prior to startup of hot operations
- Twenty-six areas of concern that may result in changes to design or require additional testing to determine if the design is adequate (now or later)
- Thirteen suggested improvements that the project should consider to enhance safety, cost, schedule, or efficiency during test operations and potential transition to a production system downstream

The Expert Review Panel charter focused this review on the technical basis for the existing DBVS design. This review team did not review overall project cost and schedule estimates, nor did it specifically evaluate the efficacy of bulk vitrification technology implementation versus other alternative treatment pathways that DOE may choose in the future (Hamilton 2006a).

E.1.2.3.7 Nonthermal Supplemental Treatment Technology – Cast Stone

Cast stone is the representative nonthermal supplemental treatment technology analyzed in this TC & WM EIS. Cast stone is a waste form in which liquid waste slurries may be immobilized in a process similar to grouting; however, in this application, the grouted waste would be placed in large containers to enhance the durability of the final waste form and facilitate retrieval, if needed. Substantial performance data are available to support the utilization of cast stone as a supplemental treatment technology. Treatment of hazardous waste with Portland cement formulations is common, and the grouting of radioactive waste has been extensively demonstrated worldwide. This nonthermal treatment process does not require specialized equipment and uses readily available materials. Cast stone is an advanced formulation designed to bind waste constituents more tightly in a cementitious matrix. Cast stone would be used to supplement the treatment of LAW.

Cast Stone Facilities may be placed in one or both of the 200-East and 200-West Areas as necessary to supplement the current WTP configuration and capacity. The construction and operation of a Cast Stone Facility in the 200-East Area is analyzed under Tank Closure Alternatives 3B, 4, and 5. The construction and operation of a Cast Stone Facility in the 200-West Area is analyzed under Tank Closure Alternative 3B.

The 200-East Area Cast Stone Facility would be located near the WTP and would accept a fraction of the LAW generated from the WTP Pretreatment Facility. The 200-East Area Cast Stone Facility would provide supplemental treatment to the WTP by immobilizing up to 37 percent of the total LAW (approximately 18,000 metric tons of sodium) currently existing in the Hanford tank system. However, the 200-East Area Cast Stone Facility would actually be required to process more than the 18,000 metric tons of sodium tank waste due to the addition of nonwaste sodium during the WTP pretreatment step. Approximately 5,500 metric tons of sodium would be added to the supplemental treatment waste stream during the WTP pretreatment step.

The 200-West Area Cast Stone Facility would immobilize up to 32 percent of the tank waste sodium (approximately 15,000 metric tons) consisting of pretreated waste from the 35 SSTs with low cesium-137 concentrations (listed in Table E-6 and discussed in Section E.1.2.3.5.2). These 35 SSTs are located in both the 200-East and 200-West Areas and contain approximately 15,000 metric tons of sodium. Waste feeds for supplemental treatment technologies used in the 200-West Area would be subject to solid-liquid separations activities. This 200-West Area solid-liquid separations process would consist of a settling and decanting process to reduce the solids content of the waste received from the LAW tanks. The settling and decanting step were assumed to return 50 percent of the solids to the WTP for processing (CH2M HILL 2004).

E.1.2.3.7.1 Technology Description

The cast stone process can be performed at ambient temperatures and pressures and involves mixing the waste with readily available dry materials (e.g., Portland cement, fly ash, and slag) and casting the wet mix in large containers to produce a waste form exhibiting satisfactory physical and chemical characteristics. The LAW liquid waste stream, either directly from the solid-liquid separations process (200-West Area), or from the WTP Pretreatment Facility (200-East Area), would be stored in dissolved salt cake storage tanks. The LAW feed would be sampled to verify sodium molarity (nominal 5 molar with a range of 4 molar to 10 molar) and to optimize the grout formulations (CH2M HILL 2003b). The LAW feed then would be mixed with dry cementitious binding materials and other additives to produce a wet slurry. The slurry would be cast into large containers for solidification to bind the hazardous and radioactive constituents in the cement matrix. When the cast stone waste has cured sufficiently for transport and storage, the containers would be transported to onsite disposal in an IDF. A flow diagram of the cast stone process is illustrated in Figure E-18.

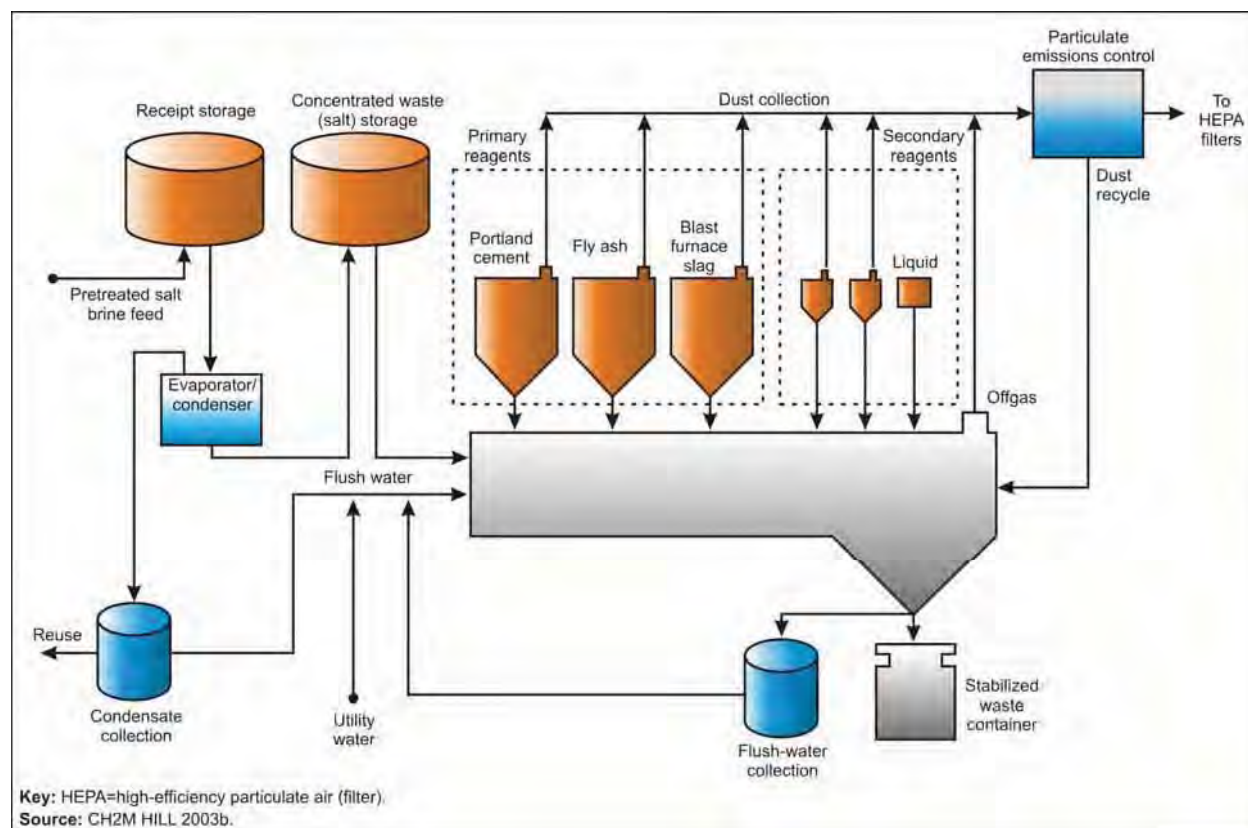

Figure E–18. Diagram of Proposed Cast Stone Process

E.1.2.3.7.2 Process

The cast stone process would be the final treatment for the tank LAW prior to final disposition on site in an IDF. LAW liquid waste feed would be received from either direct DST retrieval operations, the solid-liquid separations process (200-West Area), or the WTP Pretreatment Facility (200-East Area). The LAW liquid waste feed would be received and temporarily stored in dissolved salt storage tanks for mixing, blending, homogenization, and sampling. The LAW is sampled to verify sodium molarity and optimize grout formulations (CH2M HILL 2003b). Based on past experience, the lead-time necessary to stage, sample, and assay the waste in preliminary dissolved salt storage tanks and to verify an acceptable cast stone formulation would be 5 months. Temporary storage of a 5-molar sodium cast stone feed at maximum throughput rates for 5 months would require the use of two DSTs.

After acceptance and assaying of the LAW feed, the liquid waste would then be pumped to an evaporator to concentrate the waste feed into a 10-molar-sodium solution. The evaporator condensate would be recycled in the Cast Stone Facility or directed to the ETF for treatment. The 10-molar-sodium liquid waste feed would be stored in holding tanks to cool the liquid waste stream prior to the stabilization process. The contents of each waste tank would be treated as an individual feed batch.

Dry materials (e.g., Portland cement, fly ash, and slag) would be procured directly from vendors, delivered to the Cast Stone Facilities by truck, and stored in individual silos. The materials would be blended before being mixed with the liquid waste using “off-the-shelf” technology for conveying, mixing, and dust suppression. The nominal grout formulation is expected to be approximately 8.2 percent Portland cement, 44.9 percent fly ash, and 46.9 percent slag. The target waste loading is 18.8 weight-percent waste solids in the cast stone. In addition to the dry reagents, a secondary reagent, ferrous sulfate monohydrate, would be added to the slurry mixture to reduce the leachability of hexavalent chromium from the final waste form. The addition of surfactants, plasticizers, and/or antifoaming agents

also may be necessary to improve slurry mixture flow properties and reduce porosity of the final waste form (CH2M HILL 2003b).

The mixer would receive waste slurry at a rate of up to 380 liters (100 gallons) per minute into the stabilization process. The waste slurry and the cement-forming materials would be metered into twin-screw paddle mixers to mix for 10 to 15 minutes. The mixer would discharge into a surge tank that feeds a positive displacement pump. The pump would discharge directly into the cast stone waste containers. The dimensions of the cast-stone waste containers would be 2.7 meters long by 2.7 meters wide by 1.5 meters high (9 feet long by 9 feet wide by 5 feet high), with a net volume of approximately 11.5 cubic meters (15 cubic yards). Each container would be filled to 10 cubic meters (13.1 cubic yards) and would contain 20 metric tons of grout. Each 10-cubic-meter container of cast stone waste would represent approximately 5,010 liters (1,324 gallons) of concentrated 10-molar sodium LAW (CH2M HILL 2003b).

After being filled, the containers would be closed and sealed. The exterior surface of the containers would be checked for contamination and decontaminated as necessary. The cast stone waste containers would then be stored in the Staging Area for further curing. The initial curing stage, prior to final disposition on site, is estimated to require 5 days.

Offgas generated by the process would be passed through a HEPA filtration system and then discharged through a stack to the atmosphere. General plant housekeeping, among other activities, would generate liquid effluents (e.g., the cast stone mixer must be routinely washed to prevent buildup of solidified cast stone on internal surfaces). All liquid effluents produced would be returned to the cast stone feed tank and disposed of in subsequent cast stone batches.

E.1.2.3.7.3 Facilities

The exact location of the Cast Stone Facilities, if constructed, has not been determined. For purposes of evaluation, it was assumed that the Cast Stone Facilities would be located northeast of the 202-S REDOX Facility in the 200-West Area and/or in the 200-East Area near the WTP. Each Cast Stone Facility would cover approximately 3,810 square meters (41,000 square feet) in area. In practice, the Cast Stone Facilities could be built in other locations in the 200-West or 200-East Areas. The larger container sizes discussed in **Containerized Cast Stone Facility Pre-Conceptual Engineering Report** (CH2M HILL 2003b) may lead to some consideration that only one Cast Stone Facility would be needed to supplement the WTP and still meet LAW immobilization milestones. However, for the purposes of this EIS, a conservative approach would be to consider the construction and operation of two Cast Stone Facilities, one in the 200-East Area and one in the 200-West Area. See Figure E-11 for proposed locations of the supplemental treatment facilities in the 200-East and 200-West Areas.

Cast Stone Facilities would consist of multiple connected structures. The core structure would consist of shielded and reinforced process containment cells. The following process systems would be housed in each of the Cast Stone Facilities.

- LAW receipt, conditioning, and storage
- Dry-material storage and blending
- LAW stabilization
- Cast stone container filling
- Cast stone curing and container staging
- Container decontamination and venting
- Cast stone container storage and transport
- Process support systems

E.1.2.3.7.4 Process Areas

General descriptions of the cast stone process systems and facilities are provided in the following subsections.

LOW-ACTIVITY WASTE RECEIPT, CONDITIONING, AND STORAGE SYSTEMS

The LAW liquid waste feed would be received into two 113,600-liter (30,000-gallon) dissolved salt cake storage tanks. The LAW feed would be received intermittently, but at an average of 38 liters (10 gallons) per minute. Each storage tank would temporarily store LAW for up to 5 months while assay and grout formulations were optimized. The LAW liquid feed would be conditioned to a concentrated 10-molar sodium solution through an evaporator and transferred to two smaller 68,100-liter (18,000-gallon) holding tanks. The concentrated LAW would then be introduced into the stabilization process. The holding tanks would be sized to store up to 2 days of LAW feed (CH2M HILL 2003b).

DRY-MATERIAL STORAGE AND BLENDING SYSTEM

The dry-material storage system would receive bulk materials by either rail or truck, store the materials in dedicated silos, and deliver the dry materials to the dry-material blending system via a pneumatic conveyer system and mechanical conveyance. Dry materials used in the cast stone process would consist of Portland cement, blast furnace slag, and fly ash. The dry-material storage system would be a nonradiological operation. If preblended dry materials were procured from a vendor, they would be transferred directly to the staging vessel of the dry-material blending system. A centralized receiving, storage, and blending system may be used to provide dry-material feed to both the 200-East and 200-West Area Cast Stone Facilities.

The dry-material blending system would proportionately blend the cement, slag, and fly ash into a homogeneous mixture, stage the blended material, and deliver the dry-material mixture to the cast stone mixer. Dry materials would be blended with a horizontal-shaft ribbon-blade mixer or similar equipment.

A second dry reagent, ferrous sulfate monohydrate, would be introduced into the grout formulation. Due to the relatively smaller quantities required, this material would be received and stored in large sacks or containers and would not require silo storage.

LOW-ACTIVITY WASTE STABILIZATION SYSTEM

The LAW liquid waste and dry-material mixing system would be designed to consolidate radioactive service functions within a single process cell. This cell would contain the liquid-handling tanks, pumps, valves, and instrumentation. The LAW concentrated liquid waste feed would be transferred into the mixers at a rate of up to 380 liters (100 gallons) per minute. The mixing process for each 10-cubic-meter (13.1-cubic-yard) batch would take approximately 15 minutes to complete. Within the mixing cell, the waste slurry and the cement-forming materials would be metered into a typical twin-screw paddle mixer. The mixing operations would be shielded for radiation protection and remotely operated.

CAST STONE CONTAINER-FILLING SYSTEM

The mixed slurry would be transferred into cast stone waste containers with a net volume of 11.5 cubic meters (15 cubic yards). The inner containment flooring and sides would be made of continuously welded steel plate to provide leak-tight construction. Cast stone slurry would be transferred to steel containers through either a gravity-feed steel chute or a positive-displacement pump and steel piping. The cast stone waste containers would be filled to capacity through a port in the top of the container. The containers would be filled to minimize void space. The cast stone container-filling operation would be shielded for radiation protection and remotely operated.

DECONTAMINATION AND VENTING SYSTEM

The decontamination system would be a utility module that supports the container decontamination station, as well as flushing and decontamination of the cast stone process system. The decontamination system would store, feed, and meter decontamination solutions to the container decontamination station and the cast stone process system. This system would house process support equipment, but would not contain radioactive service components. It was assumed that decontamination tanks and associated pumps would be required and that a caustic agent would be used as the primary decontamination solution at a rate of about 3,800 liters (1,000 gallons) per year.

The air filtration system would maintain a negative air pressure within process vessels and process areas. Air would flow from those areas with the least potential for contamination to areas with the highest potential for contamination. Air collected by the air filtration system would be passed through HEPA filters before being discharged to a stack. The air filtration system would include heaters to prevent condensation in the HEPA filters, redundant banks of HEPA filters, exhaust fans, and a stack with a continuous air radiation monitor and a gas sampler train.

CAST STONE CONTAINER STORAGE AND TRANSPORT SYSTEM

The empty-container staging area would provide sufficient storage capacity for a 2-week supply of empty cast stone containers. The containers would be stacked on a concrete pad. A forklift would be used to transfer empty containers to the container transport system for delivery to the cast stone container-filling system. This area of the facility would be contact-operated and -maintained.

The cast stone container transport system would move the containers from the empty-container staging area, through an air lock and into the container-filling area. After filling the cast stone container, the cast stone container transport system would move the container to a capping and decontamination station and then to the filled-container staging area.

The filled-container staging and transport system would provide indoor interim storage for curing of the cast stone, an inspection area, and a load-out area. The filled-container storage area would accommodate 5 days of production. It is estimated that the filled containers would require up to 5 days to reach surface temperatures low enough for final disposition in onsite burial facilities. Containers would be inspected and sampled periodically to ensure proper compressive strength and the absence of free water.

The load-out area would be sized to accommodate the trucks that would be used to haul the containers to the disposal site. A bridge crane would be used to remove the containers from the cast stone container transport system, stack them in the filled-container staging area, and load them onto trucks for shipment to the disposal site (an IDF). The cast stone would continue to cure to higher compressive strength after transfer. The staging facility would be a concrete-walled building with a lined concrete floor. The load-out area would be sized to store up to 2 days of facility production to provide flexibility in scheduling transportation.

PROCESS SUPPORT SYSTEMS

Process support systems that provide auxiliary support to the Cast Stone Facility's primary systems include, but are not limited to, flush water systems, instrumentation and control systems, offgas monitoring and control, chilled water systems, backup emergency electrical generation, and fire protection systems. Flush water systems would be used to rinse the grout mixers between shifts. Chilled water systems would assist in regulating and dissipating heat generation during the curing process.

The construction contractor may erect temporary facilities during construction of the Cast Stone Facilities. Typically, these facilities are limited to trailers used as construction site offices and change and restroom facilities for the construction workers.

For purposes of analysis in this EIS, the Cast Stone Facilities would be deactivated at the end of their process mission. Closure of the Cast Stone Facilities is not analyzed in this EIS.

E.1.2.3.7.5 Waste Form/Disposal Package

PRIMARY WASTE

A grout formulation similar to formulations demonstrated at Hanford, the Savannah River Site (SRS), and other large commercial grout-based projects was used as a basis for the evaluation in this TC & WM EIS. An SRS formulation tested with a similar radioactive tank waste composition was used to calculate the required grout formation and process chemicals. The SRS grout formulation used to make chemical calculations consisted of 4 weight-percent Portland cement, 25 weight-percent fly ash, 25 weight-percent slag, and 46 weight-percent waste salt solution.

Cast stone formulation trials have been completed with a limited number of actual tank waste samples and simulants. These formulations have used the baseline cast stone feed stream composition of 5-molar sodium and 3-molar total nitrate. Addition of the grout-forming materials (e.g., Portland cement, fly ash, and slag) increases the slurry volume to 1.4 times the feed volume. Based on the assumptions used in this TC & WM EIS analysis, the estimated waste loading of the cast stone waste product would be 7.8 weight-percent of sodium oxide (CH2M HILL 2003b). It is possible that actual cast stone formulations may be tailored to adjust for batch-to-batch variations as waste is retrieved from different tanks.

A disposal package consisting of a 11.5-cubic-meter (15-cubic-yard) steel container nominally 2.7 meters long by 2.7 meters wide by 1.5 meters high (9 feet long by 9 feet wide by 5 feet high) would be utilized. Each container, for mass balance estimates, was assumed to be filled with 10 cubic meters (13.1 cubic yards) of grout (approximately 20 metric tons of grout). The density of grout formed by the cast stone process was assumed to be 2,000 kilograms per cubic meter (125 pounds per cubic foot). The gross weight of a full cast stone waste container would be less than 25 metric tons, and the container was assumed to be equipped with a bolted lid and to be made of carbon steel, though the actual package to be used has not been determined.

Quantities of primary waste generated by the cast stone process are provided in Section E.1.2.4, “Waste Disposal.”

WASTE FORM PERFORMANCE

Cast stone waste containers were assumed to be disposed of at Hanford in an IDF. The final waste acceptance criteria have not been established; however, it was assumed that the criteria would be consistent with the HSSWAC (CH2M HILL 2003b; Fluor Hanford 2005a).

The cast stone waste container in its final packaged waste form would be required to meet certain physical limitations prior to acceptance for disposal in an IDF. Some of these physical requirements include mass, void space, and external surface temperature. The mass cannot exceed 25 metric tons. The waste container must be at least 90 percent full. The external surface temperature of the package must be below 50 °C (122 °F) (CH2M HILL 2003b).

Data are available on the performance of grouted waste forms produced previously for Hanford tank waste as well as similar waste at the SRS. Retention of waste constituents within the cast stone waste is

enhanced through addition of fly ash and slag to the grout formulation. The rate of release of hazardous constituents depends strongly on the nature of the waste form used to immobilize the constituents. The nature of the waste forms, analysis for long-term performance assessment, and methods used to estimate release rates and values of parameters characterizing release rates from the cast stone are presented in Appendix M.

In addition to the primary dry reagents, a secondary dry reagent, ferrous sulfate monohydrate, may be used to reduce the leachability of hexavalent chromium in the final waste form.

Waste form performance may be enhanced by introducing reagents such as surfactants, plasticizers, and antifoaming agents into the grout slurry mixture during the mixing stage.

SECONDARY WASTE

Secondary waste generation for cast stone waste would be minimal because cast stone is a nonthermal process. Excess process liquids generated from cast stone operations include liquids from washing the mixer and general housekeeping activities. All liquid effluents produced would be returned to the cast stone waste feed tank and disposed of in subsequent cast stone waste batches. The cast stone process may also include evaporation of waste feeds. It was assumed that any condensate produced would be treated in an existing facility such as the ETF.

The offgas and venting systems would generate a limited amount of HEPA filtering media that would require handling and disposal.

E.1.2.3.7.6 Assumptions and Uncertainties

An extensive worldwide body of experience exists for the grouting of LLW. Grout disposal is the technology used for the majority of LLW in the industry. The Cast Stone Facilities would not require the development of any unique process equipment because the cast stone process utilizes readily available materials.

The capture and immobilization of several select radionuclides in the final waste form product is an important consideration when evaluating the performance of the cast stone process as a potential supplemental nonthermal LAW treatment option. The final waste form for the nonthermal cast stone process was assumed to retain 100 percent of select radionuclides due to the low temperatures associated with this process (CEES 2007a). The performance measures of most concern are the ability for long-term confinement of technetium-99, iodine-129, and nitrate. Particularly, the leachability of technetium-99 from the final waste form is suspect. A consideration would be to pretreat the LAW by removing technetium prior to immobilizing the LAW in the Cast Stone Facilities. This EIS evaluates the incorporation of technetium removal technologies as a WTP pretreatment step prior to introduction of the grout waste form into the selected supplemental pretreatment process to mitigate questionable waste performance factors associated with technetium-99. This technetium-99 removal option is evaluated under Tank Closure Alternative 3B.

As reported in RPP-RPT-26742, Rev. 0, published in 2005, **Hanford Containerized Cast Stone Facility Task 1 – Process Testing and Development Final Test Report** (Lockrem 2005), a series of laboratory-scale demonstrations were conducted on actual samples of LAW from Hanford tanks. The purpose of these demonstrations was to optimize dry reagent formulation assumptions and to validate the final waste form. The results of these demonstrations suggest that specific dry reagent formulations, coupled with the use of a secondary dry reagent (ferrous sulfate monohydrate) to control hexavalent chromium, could yield favorable final waste form performance. Additional tests on final waste form performance assessments are planned (Lockrem 2005).

E.1.2.3.8 Thermal Supplemental Treatment Technology – Steam Reforming

The steam reforming process is one of the two representative thermal supplemental treatment technologies (the other is bulk vitrification) analyzed in this EIS. Steam reforming is used extensively in nonradioactive processing in the petroleum industry and has recently been applied to treating radioactive waste. The application and testing of steam reforming on radioactive waste feeds is limited. A commercial facility in Erwin, Tennessee, uses the fluidized-bed steam reforming (FBSR) process to treat LLW (chiefly ion exchange resins from commercial nuclear power reactors). This facility has been in operation since 1999 and uses a 1.14-meter-diameter (45-inch-diameter) FBSR system (Gasper et al. 2002). The size of the facility represents a pilot-scale demonstration of the operational features of a full-scale Hanford plant, which is based on 1.83-meter-diameter (72-inch-diameter) FBSR systems. This treatment technology uses a high-temperature fluidized bed to destroy nitrates and to incorporate in a granular, mineralized waste form radionuclides and sodium, sulfate, chlorine, and fluorine from the waste. DOE has selected steam reforming to treat approximately 3.8 million liters (1 million gallons) of sodium-bearing waste at Idaho National Laboratory (INL) and is currently performing pilot-scale demonstrations using nonradioactive surrogate waste at the Hazen Research Facility (70 FR 75165). The Hazen Research Facility concluded a pilot-scale demonstration in February 2006 that processed 29,900 liters (7,900 gallons) of INL simulant waste during two continuous operational runs totaling 498 hours (THOR and WGI 2006).

Steam Reforming Facilities may be placed in both the 200-East and 200-West Areas as necessary to supplement the current WTP configuration and capacity.

The 200-East Area Steam Reforming Facility would be located near the WTP and would accept a fraction of the LAW generated from the WTP Pretreatment Facility. The 200-East Area Steam Reforming Facility would provide supplemental treatment to the WTP by treating up to 37 percent of the tank waste sodium (approximately 18,000 metric tons of sodium) currently existing in the Hanford tank system. However, the 200-East Area Steam Reforming Facility would actually be required to process more than the 18,000 metric tons of sodium tank waste due to the addition of nonwaste sodium during the WTP pretreatment step. Approximately 5,500 metric tons of sodium would be added to the supplemental treatment waste stream during the WTP pretreatment step.

The 200-West Area Steam Reforming Facility would immobilize up to 32 percent of the tank waste sodium (approximately 15,000 metric tons of sodium) consisting of pretreated waste from the 35 SSTs with low cesium-137 concentrations (listed in Table E-6 and discussed in Section E.1.2.3.5.2). These 35 SSTs are located in both the 200-East and 200-West Areas and contain approximately 15,000 metric tons of sodium. Waste feeds for supplemental treatment technologies used in the 200-West Area would be subject to solid-liquid separations activities. This 200-West Area solid-liquid separations process would consist of a settling and decanting process to reduce the solids content of the waste received from the LAW tanks. The settling and decanting step were assumed to return 50 percent of the solids to the WTP for processing (CH2M HILL 2004).

E.1.2.3.8.1 Technology Description

Steam reforming is not a batch process; thus it depends on a continuous waste feed. The Steam Reforming Facility receives pretreated tank waste (retrieved waste with low radioactivity) and dilutes the waste stream with water to an optimal sodium molarity of 2.9 molar, or approximately 50 percent water content. The dilution of tank LAW is required to transform the steam reforming waste feed into a pumpable liquid for introduction into the fluidized-bed vessel. The 200-East Area Steam Reforming Facility is expected to receive pretreated feed at a nominal molarity of 7.0 molar, whereas the 200-West Area Steam Reforming Facility feed is expected to receive pretreated feed at 5.0 molar. Within the fluidized-bed vessel, the steam reforming process converts LAW solutions (tank waste) to granular

minerals, volatilizes water, and decomposes organic compounds, nitrate, and nitrite present in the tank waste to carbon dioxide, water, and nitrogen. The steam reforming process uses several chemical consumables, including sucrose, clay, iron oxide, oxygen, and nitrogen. These chemical additives are added at various stages of the process to facilitate reduction and/or conversion. The offgas from the steam reformer process would be treated to remove radionuclides, acid gases, and other pollutants before discharge. The mineralized product (steam reforming waste) was assumed to be suitable for packaging for disposal as a free-form granulated material. However, this waste form may require additional immobilization, either through the use of additives during the steam reforming process or the formulation of monolithic waste forms using cement binders (e.g., grout) (DOE 2003e). For purposes of analysis, this EIS assumes the mineralized product (steam reforming waste) would be suitable for packaging and disposal. A flow diagram of a production-scale steam reforming process appears in Figure E-19.

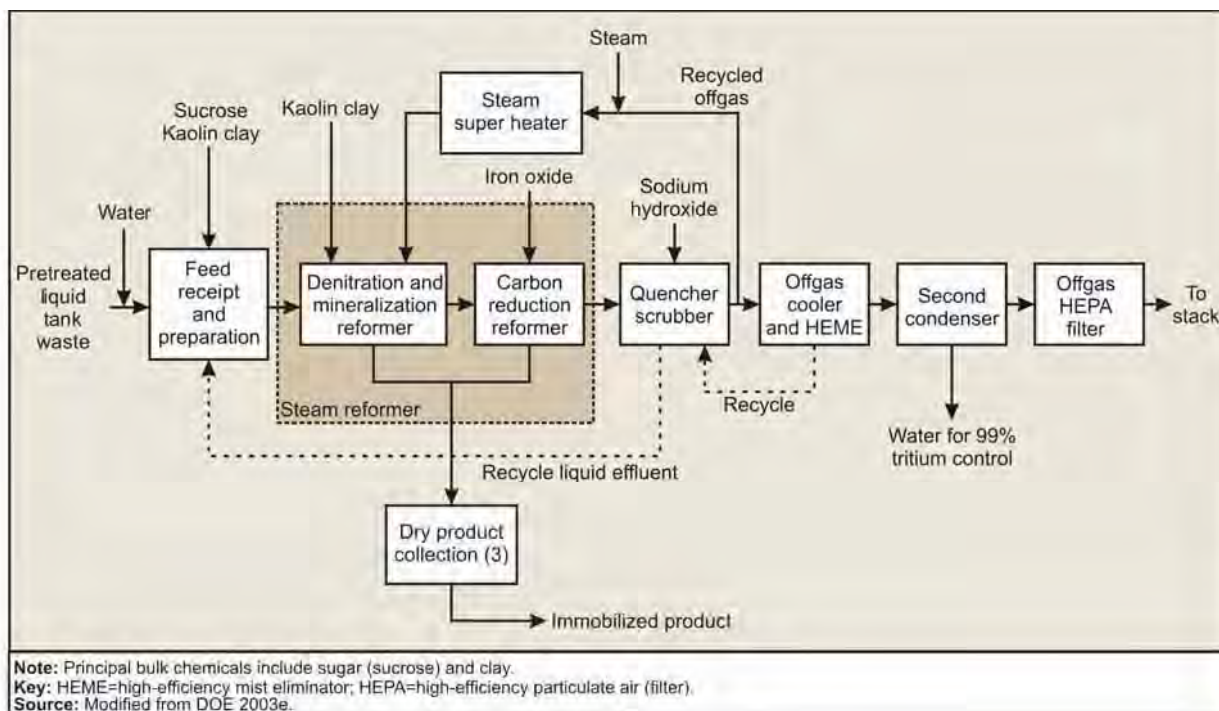

Figure E-19. Steam Reforming Supplemental Treatment Process Flow Diagram

E.1.2.3.8.2 Process

The tank waste would first be diluted with water to an acceptable sodium molarity (~2.9 molar) and water content (~50 percent). Then the diluted liquid waste feed would be mixed in a batch/feed tank with select coreactants, including a soluble carbon reductant (sucrose) and a mineralization additive (clay). The waste feed mixture would be injected by the waste feed pumps into the bottom of the de-nitrator reformer fluid bed just above the fluidizing gas distributors. Other coreactants (e.g., iron oxide) would be introduced directly into the fluidized-bed vessels during both startup and operation.

In the first fluidized-bed vessel (the de-nitrator reformer), the waste would be converted to processed mineralized waste, organics would be destroyed, and partial destruction of nitrogen compounds would occur. Steam reforming would be operated at 700 to 800 °C (1,290 to 1,470 °F) and under a slight vacuum (-20 to -40 inch water column). The second fluidized-bed vessel (the carbon reduction reformer) would be used to complete the destruction of nitrogen compounds. The upper zone of the carbon reduction fluid bed would be operated under oxidizing conditions by injection of oxygen. This oxidizing zone would convert residual carbon reductants and organics into carbon dioxide and water vapor. In the

steam reformer vessels, the granular/particle bed material would be fluidized with low-pressure super-heated steam and recycled offgas.

The following chemical reactions and physical changes would take place in the steam reformer.

- All liquids would be evaporated.
- A majority of the radioactive cesium, technetium, and other radionuclides would be incorporated into the crystalline structure of the mineralized processed waste in the lower reactor zone. Tritium and carbon-14 would be volatilized to the offgas treatment system. Approximately 20 percent of the iodine-129 would be incorporated into the final waste product, with the balance incorporated into the secondary waste streams. Section E.1.2.3.8.5 provides additional information on assumptions and uncertainties regarding radiological constituents partitioning.
- Sodium, potassium, and aluminum in the waste feed would be converted into sodium-alumina-silicate, a stable, mineralized, processed waste product that contains essentially all the radionuclides and inorganic elements in the waste feed stream.
- Nitrates and nitrites in the waste feed would be reduced to nitrogen gas in the presence of carbon, carbon monoxide, hydrogen, iron, and iron oxide reductants in the bed.
- Organics would be initially converted into light volatile hydrocarbons such as methane, carbon monoxide, hydrogen, carbon dioxide, and water in the de-nitrator reformer bed. In the upper zone of the carbon reduction reformer bed, oxygen would be injected to oxidize the gaseous constituents more fully.
- The steam reforming process would destroy organics in the waste. The process is a nonincineration thermal treatment system. Studies have confirmed that the formation of dioxin and furan do not take place in the steam reforming process.

Certain hazardous metals would be reduced to a nonhazardous valence state (e.g., chromium [VI] would be reduced to chromium [III]) and become chemically bound in the mineralized waste product. Other hazardous metals, such as lead, would also be chemically bound in the mineralized waste sodium-alumina-silicate product. Mercury would volatilize into the offgas and would be captured with activated carbon.

The steam reforming process would produce a mineralized and granular waste form (steam reforming waste) consisting primarily of nepheline (NaAlSiO_4), nosean ($\text{Na}_8[\text{AlSiO}_4]_6\text{SO}_4$) and other aluminosilicate derivatives (DOE 2003e).

E.1.2.3.8.3 Facilities

The 200-West Area Steam Reforming Facility would be required to treat on average 26.9 liters (7.1 gallons) per minute of diluted LAW solution that has a sodium concentration of 2.9 molar. Based on information provided by THOR Treatment Technologies, LLC, a single 1.83-meter-diameter (72-inch-diameter) steam reformer unit would have a processing rate of 20.8 liters (5.2 gallons) per minute for 2.9 molar sodium feed solution, assuming 70 percent TOE. Therefore, two 1.83-meter-diameter (72-inch-diameter) steam reformer units, along with ancillary process and service equipment, would be required to achieve the desired processing rate. The typical configuration for a dual steam reformer unit facility is illustrated in Figure E-20; such a facility would occupy an area 49 meters wide by 52 meters long (160 feet wide by 170 feet long).

Draft Tank Closure and Waste Management Environmental Impact Statement for the Hanford Site, Richland, Washington

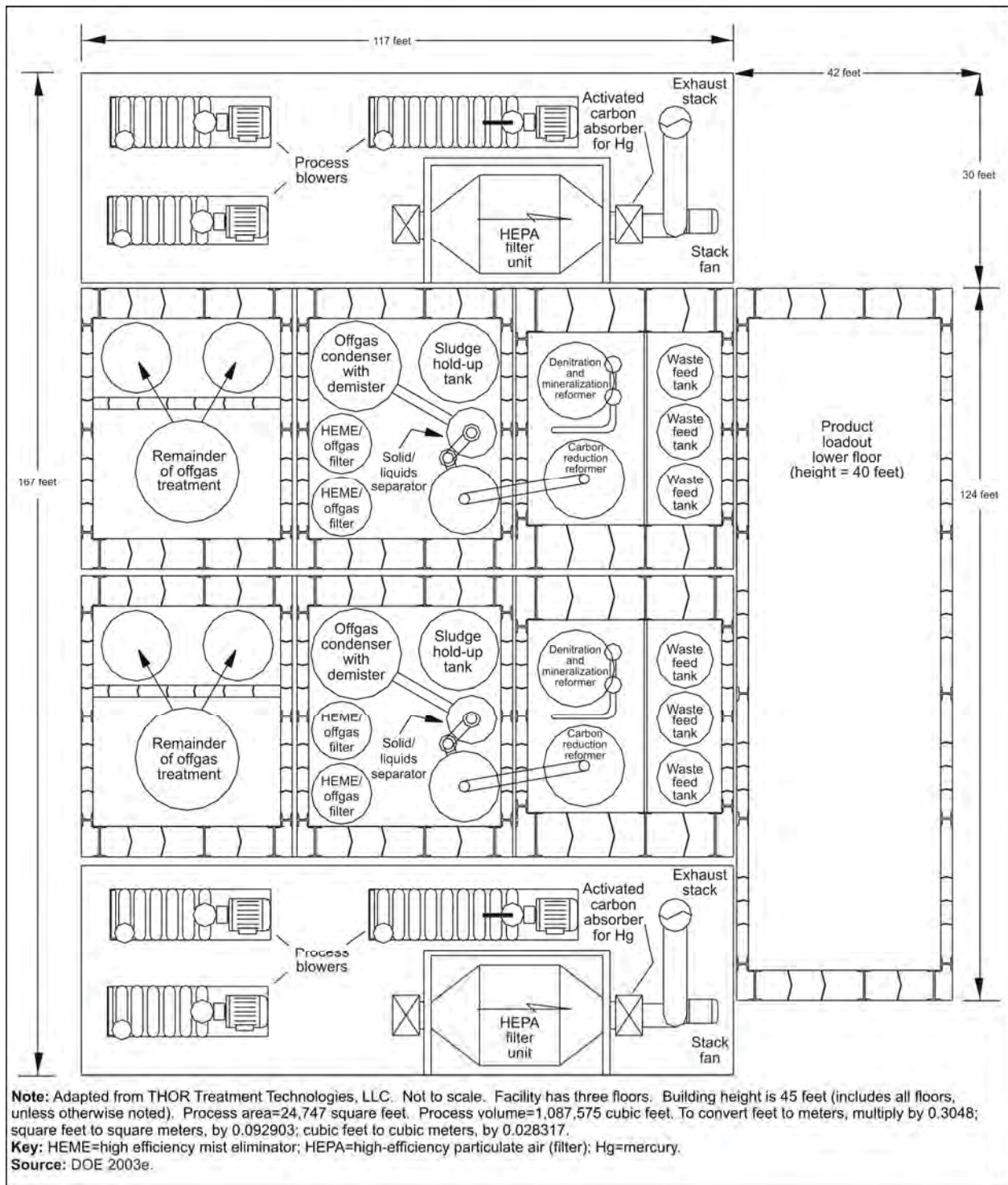

Figure E-20. Dual Steam Reforming Facility Layout

To meet the supplemental treatment needs for the 200-West Area, a dual Steam Reforming Facility would need to be constructed, occupying an area 49 meters wide by 52 meters long (160 feet wide by 170 feet long), or a footprint of approximately 2,530 square meters (27,200 square feet). An additional area would provide space for the control room, change room, standby generator, electrical equipment building, cooling water system, nitrogen supply, instrument air, cooling water, boiler/steam supply, and other

equipment. The total area for the dual Steam Reforming Facility and the ancillary support buildings and equipment would be 4,900 square meters (53,000 square feet).

The 200-East Area Steam Reforming Facility would be located near the WTP and be required to treat on average 56.8 liters (15 gallons) per minute of diluted LAW solution with a sodium concentration of 2.9 molar, assuming 70 percent TOE. Therefore, three 1.83-meter-diameter (72-inch-diameter) steam reformer units, along with ancillary process and service equipment, would be required to meet the treatment needs for the 200-East Area. For conservative evaluation, two dual Steam Reforming Facilities (total of four 1.83-meter [72-inch] reformer units) are proposed to be constructed in the 200-East Area.

For the construction of two dual Steam Reforming Facilities side by side in the 200-East Area, the facility would occupy an area of 98 meters wide by 52 meters long (320 feet wide by 170 feet long) or a footprint approximately 5,050 square meters (54,400 square feet). An additional area would be needed to provide the same ancillary equipment and support systems as for the 200-West Area Facility. The total area for both the dual Steam Reforming Facilities and the ancillary process and service equipment would be 8,800 square meters (95,000 square feet).

Each Steam Reforming Facility would be composed of a dual Steam Reforming Facility consisting of two 1.83-meter (72-inch) reformer units with the following major process systems (DOE 2003e):

- Waste batch and feed
- Steam reformers (de-nitration and mineralization reformer vessel and carbon reduction vessel)
- Product packaging
- Offgas treatment systems (quencher/scrubber, HEPA filtrations, and other air pollution control equipment)

PROCESS AREAS

Waste Batch and Feed System

The waste batch and feed system include the following main hardware components.

- Waste batch tanks
- Waste feed pumps
- Associated instrumentation and controls, piping, valves, etc.

The three waste batch tanks would accept waste from the tank farms directly or as pretreated tank waste from WTP. The waste would be sampled and assayed for alkali metals, calcium, aluminum, nitrate, and nitrite content. In addition to diluting the tank waste to approximately 50 percent water content, corresponding to a 2.9 molar sodium solution, the requisite coreactants and reductants would be added to the waste in the tank. The tank contents would then be thoroughly mixed until the liquid waste mixture is ready for feed injection into the first fluidized-bed vessel (the de-nitrator reformer). The steam reforming process relies on continuous waste feed, so it is not a batch process. Therefore, feed tank volumes would need to be sized large enough to allow enough time for incoming tank waste to be characterized and prepared by dilution and chemical additives.

Steam Reformer

In the first fluidized-bed vessel (the de-nitrator reformer), the waste would be converted to processed mineralized waste, organics would be destroyed, and partial destruction of nitrogen compounds would

occur. Steam reforming would be operated at 700 to 800 °C (1,290 to 1,470 °F) and under a slight vacuum (-20 to -40 inch water column). Additional coreactants would be added to optimize the incorporation of radionuclides, alkali metals, sulfates, chlorides, fluorides, phosphates, and heavy metals into a solid granular product.

The second fluidized-bed vessel (the carbon reduction reformer) would be used to complete the destruction of nitrogen compounds. The upper zone of the carbon reduction fluid bed would be operated under oxidizing conditions by injection of oxygen. This oxidizing zone would convert residual carbon reductants and organics into carbon dioxide and water vapor. In the steam reformer vessels, the granular/particle bed material would be fluidized with low-pressure, super-heated steam and recycled offgas.

A continuous emission monitor system would monitor the offgas at the outlet of the steam reformer for the purpose of process control and would include online indication of total nitrogen oxides, oxygen, and carbon monoxide. The nitrogen oxides monitor would be used to control the level of reductants in the fluid bed.

Product Packaging System and Interim Storage

The product packaging system would receive the cooled processed mineralized waste (product) solids from the conveyor valve and cooler/separator. The granular waste product would be collected from the bottom of each steam reforming vessel, the cyclone, or other particulate collectors. The product packaging system would convey the granular/powdery final product as a free-flowing solid into bulk containers for disposal or storage. Product solids would be intermittently withdrawn from the bottom of the de-nitrator reformer as needed to maintain the solids level in the fluid bed at the desired bed depth. The outlet conveyor valve would be used to control the discharge rate of the product solids. The product solids from the cooler/separator would be transferred to a holdup tank. Product solids from the holdup tank would be metered to the container fill-port where solids would drop by gravity into the bulk container and the container would be sealed.

The granular processed mineralized, steam reforming waste, would be placed in 2.25-cubic-meter (3.0-cubic-yard) steel packages for disposal. At the assumed density of 1,000 kilograms per cubic meter, each steel waste box would contain approximately 2.25 metric tons of granular waste. Other container sizes may be evaluated during design.

The steam reforming process facility would require sufficient storage capacity for approximately 200 waste packages, corresponding to the number of waste packages that would be produced on average in a 30-day operating period.

Offgas Scrubber and Filtration System

The offgas scrubber and filtration system would provide components to cool, scrub, filter, and monitor the offgas from the reformer before discharge up the plant stack. The offgas scrubber and filtration system would consist of the following major components:

- Quencher/scrubber
- Condensers and demister
- HEPA filter
- Continuous emissions and radionuclide monitors

Offgas from the reformer cyclones would flow directly to a submerged bed quencher/scrubber/evaporator vessel to remove acid gas and particulates and to cool the hot offgases. Sodium hydroxide would be metered to the scrubber solution to neutralize acid gases removed from the offgases.

The cooled and scrubbed offgases would exit the quencher/scrubber and flow to a condenser. The condenser would serve as the process heat sink and control water balance in the process. A high-efficiency mist eliminator would be located downstream of the condenser to remove any fine mist that did not coalesce in the condenser. A second stage condenser would remove 99 percent of the water/tritium.

The quencher/scrubber and a downstream condenser and demister also would function to remove product fines (grains less than 1 to 2 millimeters in diameter) carried over from the reformer. The product fines and neutralized acid gas salts removed by the scrubber and condenser/demister system would be periodically returned to the reformer waste feed tank as a recycle stream for incorporation into the solid processed reformer waste product.

The offgas stream would then be passed through a HEPA filter bank and discharged to the stack. Redundant HEPA filters would be provided so that filter elements could be removed and new elements could be installed while the process system remains online.

Mercury is expected to volatilize in the steam reforming process and be present in the offgas. An activated carbon or gold-impregnated media system could be added to capture mercury from the main process vent downstream of the HEPA filter to remove essentially all volatile mercury from the offgas stream. For analysis purposes, this EIS analyses assumed a mercury abatement technology would be applied, resulting in a solid waste stream that would be disposed of in an IDF. In addition, for the purpose of estimating air emissions impacts, it was assumed that no mercury abatement would occur.

Two continuous emission monitor systems and a radionuclide monitor system would monitor the offgas from the process. The second continuous emission monitor system would monitor the outlet of the HEPA filters to document that discharges met applicable environmental standards and that process equipment operated as intended.

PROCESS SUPPORT AREAS

The steam reforming process would require auxiliary and utility systems and services to support continuous operations. An additional area would provide space for the control room, change room, standby generator, electrical equipment building, cooling water system, nitrogen supply, instrument air, cooling water, boiler/steam supply, and other equipment. Temporary facilities may be erected by the construction contractor during construction of the Steam Reforming Facility. These facilities would be typically limited to trailers used as construction site offices and change and restroom facilities for the construction workers. The Steam Reforming facility would be deactivated at the end of the process mission.

E.1.2.3.8.4 Waste Form/Disposal Package

PRIMARY WASTE

The LAW solution or WTP pretreatment intermediate product would be processed in the steam reforming process and converted into granular processed mineralized, steam reforming waste, with a density of 1,000 kilograms per cubic meter (62.4 pounds per cubic foot). During the steam reforming process, clay ($\text{Al}_2\text{O}_3\text{SiO}_2$), sugar, iron, and oxygen would be added to the system under high-temperature, low-pressure, and fluidizing conditions to chemically bind radionuclides into the processed mineralized waste and to decompose nitrate, nitrite, and organic compounds in the feed. The principal minerals formed would be nepheline (NaAlSiO_4), nosean ($\text{Na}_8[\text{AlSiO}_4]_6\text{SO}_4$), mullite ($\text{Al}_6\text{Si}_2\text{O}_{13}$), hematite (Fe_2O_3), magnetite (Fe_3O_4), and corundum (Al_2O_3). Hematite and magnetite would form from the added iron. Smaller quantities of other minerals also would be formed, depending upon the composition of the LAW solutions fed to the steam reformer. For example, technetium would substitute for sulfate in the nosean mineral.

The average concentration of sodium oxide in the processed mineralized waste is estimated to be approximately 20 weight-percent sodium oxide loading (CEES 2007b).

The granular processed mineralized, steam reforming waste, would be placed in 2.25-cubic-meter (3.0-cubic-yard) steel packages for disposal. The density of the final waste form was assumed to be 1,000 kilograms per cubic meter (62.4 pounds per cubic foot), resulting in each container weighing approximately 2.25 metric tons. The packages would have a void space of approximately 10 percent. Other container sizes may be evaluated during design.

Quantities of primary waste generated by the steam reforming process are provided in Section E.1.2.4.

WASTE FORM PERFORMANCE

Packaged, granular waste product from the steam reforming process would be disposed of in an IDF. Final waste acceptance criteria have not been established; however, it was assumed that the criteria would be consistent with the HSSWAC (Fluor Hanford 2005a).

Waste form testing was conducted at the Hazen Research Facility in Golden, Colorado, in December 2001 using a small-scale (15-centimeter-diameter [5.9-inch-diameter]) FBSR unit that produced the mineral waste form from approximately 568 liters (150 gallons) of Hanford 241-AN-107 LAW simulant (**Engineering Study of the Hanford Low Activity Waste (LAW) Steam Reforming Process (U)** [Jantzen 2002] and **Initial Suitability Evaluation of Steam-Reformed Low Activity Waste for Direct Land Disposal** [McGrail et al. 2003]). The principal minerals formed were determined to be nepheline (NaAlSiO_4), nosean ($\text{Na}_8[\text{AlSiO}_4]_6\text{SO}_4$), and other aluminosilicate derivatives. All of the sodium present in the simulated LAW feed solution was determined to be present in the steam reformer mineral waste form derived from small-scale tests with simulated LAW solution. The sodium oxide loading in the steam reformer mineral waste form was determined to be 19.82 weight-percent in this small-scale test with simulated LAW solution. The reducing environment in the steam reformer was demonstrated to convert certain hazardous heavy metals to nonhazardous valence states. For example, hexavalent chromium would be reduced to trivalent chromium and would be incorporated into the mineralized processed waste (sodium-alumina-silicate product). Tritium, carbon-14, and iodine-129 would be volatilized to the offgas treatment system. Nonradioactive simulant has been used in small-scale steam reforming testing. Based on test data, it was assumed that 100 percent of the radionuclides of cesium, cobalt, europium, strontium, and TRU waste elements would be retained in the steam-reformer-processed mineralized waste. On the first pass, technetium capture rates are expected to be lower. Approximately, 66 percent of technetium-99 surrogates are initially captured in the waste form and 34 percent are retained in the scrubber solution. The scrubber solution would be recycled to the reformer vessel, thereby achieving capture rates approaching 100 percent for technetium into the waste form. Testing on Hanford LAW surrogates has shown that greater than 91 percent of the sulfates, greater than 92 percent of fluorides, and greater than 93 percent of chlorides in the simulated LAW feed react in the steam reformer with the clay coreactant and become an integral part of the final mineralized waste product crystalline structure. Small amounts of the sulfates, chlorides, and fluorides in the simulated LAW feed are volatilized as acid gases. The offgas treatment system could be designed to compensate for a small difference in retention rates (Jantzen 2002). For analytical purposes, this EIS assumes that 95 percent of the sulfates, chlorides, and fluorides present in the LAW feed would be retained in the mineralized waste processed by the steam reformer, with the remainder volatilized to the offgas treatment system.

Subsequent studies of the performance of the mineralized waste form conducted in 2003 suggest favorable retention rates for surrogate sodium-bearing waste. Furthermore, analyses indicate steam reforming mineral waste product forms comply with the U.S. Environmental Protection Agency's

Universal Treatment Standards, making delisting of the final waste form an option for this technology (Jantzen 2003).

The steam reforming process recently demonstrated an approximate 5.5:1 reduction in waste feed to final product mass. A recent pilot-scale demonstration (two separate runs) conducted at the Hazen Research Facility in Golden, Colorado, in 2006 treated 40,400 kilograms (89,000 pounds) of waste feed, including chemical additives, and produced approximately 7,350 kilograms (16,200 pounds) of mineralized waste. The waste feed consisted of a simulant for INL sodium-bearing waste (THOR and WGI 2006).

The nature of the steam reforming waste, analysis for long-term performance assessment, methods used to estimate release rates from the steam reforming waste, and other related parameters are presented in Appendix M.

SECONDARY WASTE

Liquid waste effluent streams, such as tritium condensed from the offgas, would be treated at the existing TEDF or ETF. Secondary waste associated with the operations of the Steam Reforming Facilities that is not recycled within the process (e.g., spent HEPA filters, liquid effluents, and miscellaneous solid wastes) would also be generated and sent to the ETF for treatment, with the resultant grouted waste form disposed of in an IDF.

E.1.2.3.8.5 Assumptions and Uncertainties

Final IDF waste acceptance criteria have not been established; however, it was assumed that the criteria would be consistent with the HSSWAC (Fluor Hanford 2005a).

The capture and immobilization of several select radionuclides in the final waste form product is an important consideration when evaluating the performance of the steam reforming process as a potential supplemental thermal LAW treatment option. The high temperatures associated with this thermal treatment process, while not as high as bulk vitrification, would cause some of the select radionuclides to offgas and be captured in secondary waste streams. The estimated fractions of select radionuclides captured between the final waste form product and secondary waste streams as a percentage of the feed stream to the steam reforming process are provided in Table E-8.

The behavior of technetium-99 and iodine-129 in thermal processes and the fractions that would be captured in the final waste form also are hard to predict. Therefore, these fractions were assumed based on ORP guidance (Attachment 2, “Communications,” and Attachment 3, “Record of Conversation” [CEES 2007a:Attachments 2 and 3]). This is in contrast to the use of the HTWOS simulations partitioning factors for the other radiological COPCs. Further demonstration and testing of this technology should provide the necessary performance data to confirm these assumptions. If necessary, design changes may have to be implemented should the actual fractions in secondary waste streams be demonstrated to be higher than anticipated. Carbon-14 is highly volatile and would be produced in very high fractions in the offgas. Incorporation of treatment technologies may be required in the final facility design to reduce these emissions. The select radionuclides that exist in particulate form would be recycled back into the waste feed.

Demonstration of steam reforming technology for treating sodium-bearing tank waste beyond bench-scale is very limited. However, bench-scale testing using Hanford tank waste surrogates and recent pilot-scale testing leading to full-scale implementation of steam reforming to treat sodium-bearing tank waste at INL have continued to produce favorable results.

**Table E-8. Partitioning Factors of Radiological Constituents of
Potential Concern in Steam Reforming Waste^a**

| Radiological Constituent of Potential Concern | Percentage of SR Feed in SR Waste | Percentage of SR Feed in Liquid Secondary Waste |
|--|--------------------------------------|---|
| Iodine-129 ^b | 20.0 | 80.0 |
| Cesium-137 | 100.0 | 0.0 |
| Carbon-14 | 0.0 | 0.1 |
| Uranium-233 | 99.9 | 0.1 |
| Uranium-234 | 99.9 | 0.1 |
| Uranium-235 | 99.9 | 0.1 |
| Neptunium-237 | 99.9 | 0.1 |
| Uranium-238 | 99.9 | 0.1 |
| Plutonium-239 | 100.0 | 0.0 |
| Plutonium-240 | 100.0 | 0.0 |
| Hydrogen-3 (tritium) | 0.0 | 100.0 |
| Strontium-90 | 100.0 | 0.0 |
| Technetium-99 ^c | 99.9 | 0.1 |

^a Totals may not equal 100 percent due to rounding.

^b The partitioning factors for iodine-129 were directed by ORP (CEES 2007a:Attachment 3).

^c The partitioning factors for technetium-99 were directed by ORP (CEES 2007a:Attachment 2).

Key: ORP=Office of River Protection; SR=steam reforming.

Source: Data extracted from CEES 2007a.

Early engineering-scale tests using Hanford LAW surrogates were performed in December 2001 at the Hazen Research Facility. The small-scale tests were performed using 568 liters (150 gallons) of Hanford LAW 241-AN-107 simulant. The data supported the conclusion that steam reforming warranted additional evaluation as a technology for treating sodium-bearing tank waste (Jantzen 2002). Subsequent to the engineering-scale tests at Hazen, a series of pilot-scale demonstrations were performed at the Science and Technology Applications Research (STAR) facility in Idaho Falls, Idaho, on both INL sodium-bearing waste and Hanford LAW 241-AN-107 simulants. One of the tests, conducted using Hanford LAW simulants in August 2004, produced 148 kilograms (326 pounds) of mineralized product. The initial mass of simulated waste feed and additives was 364 kilograms (802 pounds), resulting in a 60 percent reduction in mass. The test was conducted in a 15-centimeter-diameter (0.50-foot-diameter) reactor vessel and lasted 68.4 hours (Olson et al. 2004).

Following the tests conducted at the Hazen Research Facility in Colorado and the STAR facility in Idaho, the Savannah River National Laboratory developed the Bench-top Steam Reformer to correlate and confirm waste form performance at the pilot-scale level. Generally, the Bench-top Steam Reformer product was found to be consistent with results achieved during pilot-scale tests at Hazen and STAR using INL and Hanford LAW simulants. In addition, the final waste form performance characteristics continued to show promise (Burket et al. 2005).

Recently, the Hazen Research Facility concluded a series of pilot-scale production runs using INL LAW simulants. This demonstration used a 38-centimeter-diameter (1.25-foot-diameter) reactor vessel to represent a 1:10-scale version of the full-scale production reactors (1.83-meter-diameter [6.0-foot-diameter]) assumed to be needed for the supplemental treatment of Hanford LAW. The first test, completed in February 2006, treated 20,630 liters (5,450 gallons) of continuous waste feed over 334 hours. The second test, completed in June 2006, treated 9,275 liters (2,450 gallons) of continuous waste feed over 164 hours. The vessel size (38-centimeter-diameter [1.25-foot-diameter]) and length of test runs (up to 334 hours continuous) performed at Hazen Research Facility, represent the largest and longest pilot-scale tests completed to date. The primary focus of the pilot-scale test was to demonstrate

the integration of the entire steam reforming treatment process and to obtain operational data for scale-up, final design, and air emissions. Waste form performance analysis and assessment is pending additional study (THOR and WGI 2006).

The technology development needs for steam reforming include engineering-scale tests that use actual Hanford tank waste and continued to assessment of waste product performance. Additional pilot- and full-scale testing is needed to demonstrate long-term bed sustainability and mitigate operational challenges, such as feed nozzle plugging, bridging, and agglomeration, which are inherent with fluidized-bed technologies.

The selection of steam reforming to treat sodium-bearing waste from tanks at INL would lead to progressive testing and full-scale production data on sodium-bearing tank waste that would become available in the near term.

E.1.2.3.9 Sulfate Removal

High concentrations of sulfate in the WTP LAW feed solutions present processing problems for the LAW vitrification process that uses joule-heated melter. Preliminary testing of the LAW vitrification system indicated that a separate molten sulfur layer could form in the melter at the maximum sulfate-to-sodium ratios found in Hanford tank waste. This molten sulfur layer would be highly corrosive to the melter components. The presence of higher concentrations of sulfate in LAW vitrification process feed can also make the final ILAW glass form more brittle. The formation of the sulfur layer can be avoided by reducing the amount of sulfate in the melter feed. The sulfate removal process would therefore be beneficial in increasing LAW vitrification throughput (in terms of quantity of waste sodium vitrified), increasing LAW melter service life, and decreasing maintenance requirements and downtime for installing LAW melter replacements. Application of the sulfate removal process would increase incorporation of waste into the ILAW glass form from approximately 14 weight-percent to approximately 20 weight-percent sodium oxide (CEES 2007a).

The sulfate removal process is an additional pretreatment process step that is not part of the current WTP Pretreatment Facility, but is proposed and evaluated under Tank Closure Alternative 5. However, the addition of sulfate removal as pretreatment technology would require the construction of two additional processing facilities that would be located adjacent to the existing WTP facility in the 200-East Area: a waste processing facility (including waste receipt and precipitation process areas) and a grouting facility. The sulfate removal process would be conducted following existing WTP pretreatment processing steps (solid-liquid separations and ion exchange). The liquid product from sulfate removal would contain primarily sodium salts (except sulfate) and would be routed back to the existing WTP LAW melter feed evaporator for vitrification as ILAW. The secondary waste-stream solid output (the grout waste form containing the sulfate precipitate) would be routed to an IDF for disposal.

The sulfate removal process is not proposed for use on waste provided as feed to supplemental technologies such as the cast stone, bulk vitrification, or steam reforming processes because there would be no benefit for these technologies. For this reason, Sulfate Removal Facilities are not proposed for the 200-West Area. In addition, low-sulfate waste streams that undergo WTP pretreatment may not need the sulfate removal process (DOE 2003a).

E.1.2.3.9.1 Technology Description

The sulfate removal supplemental pretreatment process would separate sulfate from LAW that has already been pretreated within the existing WTP Pretreatment Facility to separate entrained solids and select radionuclides (i.e., pretreated LAW). The sulfate would be separated from the pretreated LAW solution by a precipitation process that would use strontium nitrate as the precipitation reagent. The resulting strontium sulfate precipitate would be immobilized in a grout waste form or other suitable

containerized waste form. The sulfate-depleted LAW solution would be returned to the WTP for evaporation and subsequent LAW vitrification.

A conceptual diagram of the sulfate removal process is shown in Figure E-21. Entrained solids, strontium-90, TRU waste elements, and cesium-137 would be initially separated from the LAW in the existing WTP Pretreatment Facility. Following processing in the WTP Pretreatment Facility, the LAW solution would be adjusted to pH 1.0 by adding nitric acid. A strontium nitrate solution would be added to the waste to precipitate strontium sulfate, which would be separated from the LAW using conventional solid-liquid separations equipment and immobilized as a grouted waste form (sulfate grout waste). The immobilized strontium sulfate precipitate would be disposed of in an IDF.

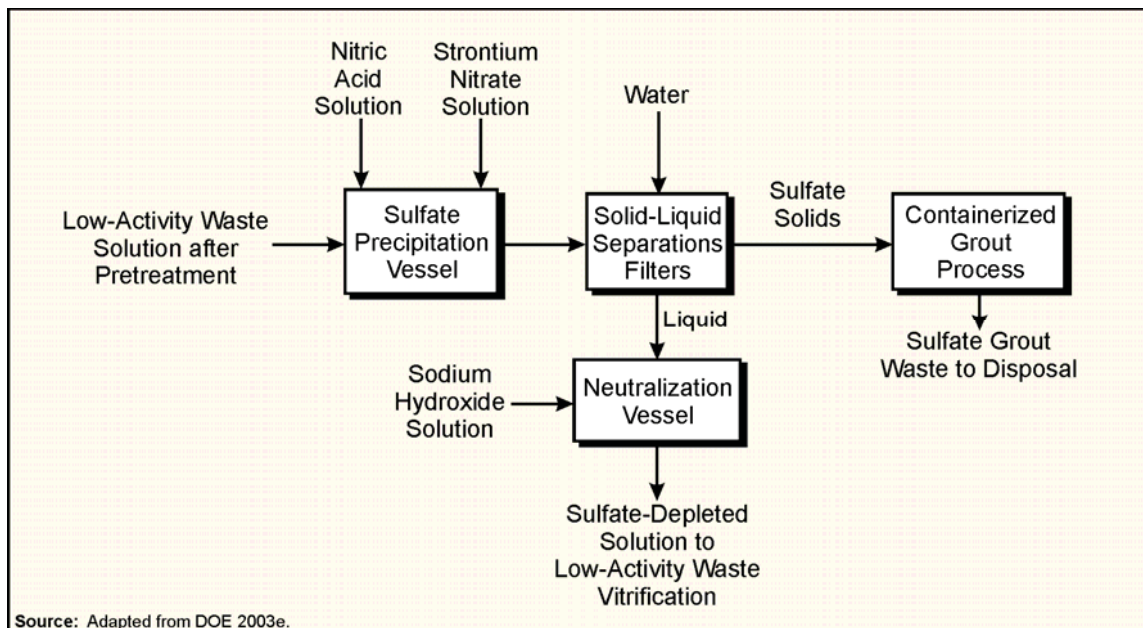

Figure E-21. Sulfate Removal Conceptual Process Diagram

The acidic filtrate (i.e., LAW) from the solid-liquid separations step would be neutralized by adding sodium hydroxide solution prior to transferring the sulfate-depleted LAW back to the WTP for vitrification.

Sulfate precipitation would be a batch-type process that would involve selectively precipitating sulfate using a strontium nitrate reagent. The LAW solution contains carbonate that, if present in sufficient concentration, would preferentially precipitate the added strontium nitrate as strontium carbonate, requiring excess reagent to precipitate the sulfate. To minimize the use of strontium nitrate, the feed must be acidified to decompose carbonate to carbon dioxide according to the following reaction:



This would be followed by further acidification and the addition of the strontium nitrate reagent. Near-minimum solubility of strontium sulfate is attained at approximately pH 1.3 and 1.0-molar sulfate. Precipitation would then occur (approximately 1-hour digestion) by the following reactions:

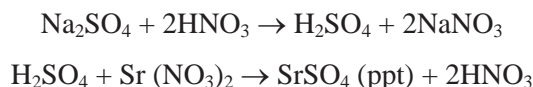

This process is expected to remove 90 to 95 percent of the sulfate present in the incoming pretreated LAW. Previous testing of a sulfate removal process with simulated LAW indicated that strontium fluoride and some strontium chromate would likely precipitate. Prior experience at Hanford's B Plant indicates that barium, lead, and other components would also precipitate if they were present in the pretreated LAW feed (DOE 2003e).

To evaluate radionuclide partitioning into the strontium sulfate precipitate, WSRC conducted screening tests in which barium nitrate solution was added to a pretreated LAW solution derived from Hanford tank 241-AN-102 supernatant that had been acidified by the addition of nitric acid. The following percentages of radionuclides were removed from the acidified LAW (tank 241-AN-102 supernatant).

- Strontium-90 89 percent
- Technetium-99 0 percent
- Cesium-137 11 percent
- Neptunium-237 4 percent
- Uranium-238 0 percent
- Plutonium-239 14 percent
- Americium-241 33 percent
- Curium-244 89 percent

Although barium nitrate was used in these tests, the radionuclide partitioning is expected to be similar using strontium nitrate, with the exception of strontium-90. Because any strontium in solution would be isotopically diluted by the addition of nonradioactive strontium nitrate, it was assumed that essentially all of the strontium-90 would precipitate and end up in the grouted waste form. Note that little, if any, of the technetium-99 is expected to be present in the sulfate grout waste. It was further assumed that iodine-129 would not precipitate or volatilize, but that all of the incoming carbon-14 would be volatilized as carbon dioxide (DOE 2003e).

Following precipitation, the sulfate precipitate would be separated from the liquid stream using an ultrafiltration system similar to that used in the WTP.

A preliminary process flow diagram of the sulfate removal process is provided in Figure E-22. The main inputs to the process include the following:

- LAW from the WTP Pretreatment Facility that has been pretreated to remove solids and cesium
- A 57 weight-percent nitric acid solution that would be added to acidify the pretreated LAW
- A 41.5 weight-percent strontium nitrate solution to precipitate sulfate as well as other cations and anions
- A 30 weight-percent sodium hydroxide solution to neutralize the sulfate-depleted LAW liquid stream
- Portland cement and other grout mix components to produce the sulfate grout waste form

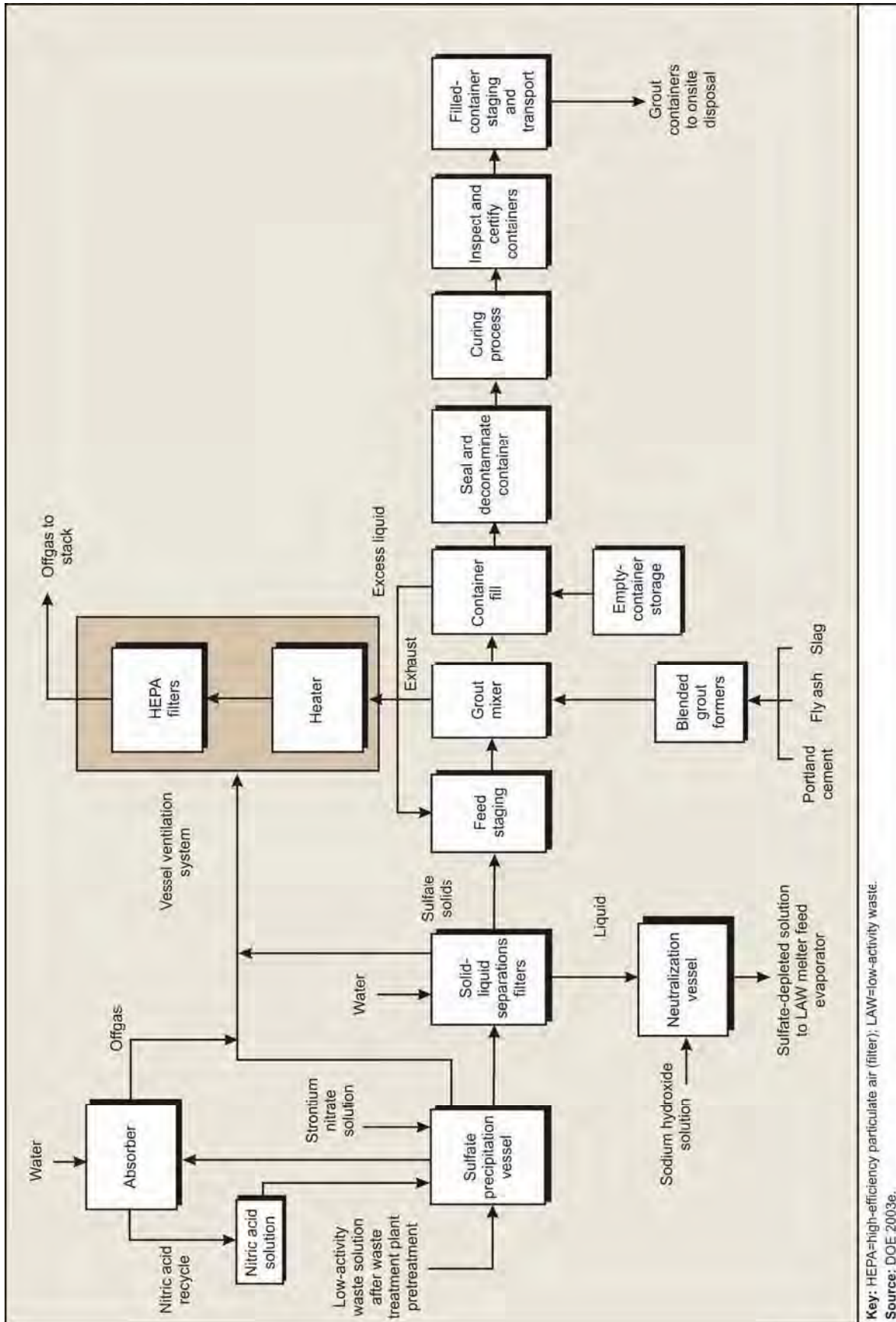

Figure E-22. Sulfate Removal Process Flow Diagram

The primary output streams from the sulfate removal process would be the following:

- Sulfate-depleted pretreated LAW solution, which would be returned to the WTP for vitrification as ILAW.
- The grouted waste form (sulfate grout waste) containing the strontium sulfate precipitate. For the purpose of analysis, it was assumed that the grout waste form would be placed in steel containers, approximately 3.6 cubic meters (4.7 cubic yards) in volume.

The addition of nitric acid to the pretreated LAW is expected to result in the generation of heat (heat of solution and reaction) and acid vapors. As shown in Figure E-22, acid vapors would be absorbed from the offgas system and recycled to the feed stream. The heat evolved would have beneficial effects on the precipitation reaction (the reaction rate and degree of completion). However, heat exchange capability may need to be incorporated into the process as required to ensure safe operation. Neutralization, if necessary, would involve similar considerations.

E.1.2.3.9.2 Facilities

As previously discussed, use of the sulfate removal process would involve construction of two new facilities in the 200-East Area near the existing WTP, a Sulfate Removal Facility and an associated Sulfate Waste Grout Facility.

The Sulfate Removal Facility would house the acidification, precipitation, and solid-liquid separations processes previously described. The size of the Sulfate Removal Facility would be approximately 130 meters long by 48 meters wide by 11 meters high (426 feet long by 157 feet wide by 35 feet high). These dimensions correspond to a facility footprint and volume of 6,200 square meters (66,900 square feet) and 66,000 cubic meters (2.34 million cubic feet), respectively.

The Sulfate Waste Grout Facility would house grout mixing and curing operations. The size of the grout facility would be approximately 40 meters long by 38 meters wide by 11 meters high (130 feet long by 126 feet wide by 35 feet high). These dimensions correspond to a facility footprint and volume of 1,520 square meters (16,400 square feet) and 16,000 cubic meters (573,000 cubic feet), respectively.

E.1.2.3.9.3 Waste Form/Disposal Package

PRIMARY WASTE

The strontium sulfate precipitate would be immobilized in a sulfate grout waste. The formulation of the grout was assumed to be 28 weight-percent sulfate precipitate, 33.8 weight-percent water, and 38.2 weight-percent Portland cement (DOE 2003e). Additional grout formulation would occur in the course of process development to maximize the contaminant retention capability and optimize operational parameters (e.g., heat evolved as a result of hydration and curing).

The sulfate removal process would generate two waste streams: (1) a sulfate-depleted effluent that would be directed to the WTP LAW melters and (2) a strontium sulfate precipitate that would be directed to the grout facility. The precipitate would be grouted in 3.6-cubic-meter (4.7-cubic-yard) steel containers, allowed to cure, and disposed of in an IDF. For analysis purposes, this EIS assumes that, under Tank Closure Alternative 5, the sulfate removal process would generate approximately 6,100 containers of grouted precipitate filled to 90 percent capacity. The density of the sulfate grout waste was assumed to be 1,800 kilograms per cubic meter (112.4 pounds per cubic foot). The resultant volume of sulfate grout waste would be 19,840 cubic meters (25,950 cubic yards) and the weight would be 35,700 metric tons, which would be disposed of in an IDF.

The quantities of primary waste generated by the sulfate removal process and a more-detailed description of the disposal package are provided in Section E.1.2.4, “Waste Disposal.”

WASTE FORM PERFORMANCE

The sulfate grout waste form would need to comply with applicable regulations (e.g., WAC 173-303, “Dangerous Waste Regulations”). Significant amounts of select radionuclides (e.g., TRU waste, cesium, etc.) would be removed within the WTP Pretreatment Facility prior to being introduced into the Sulfate Removal Facility. The performance of this waste form would be further enhanced over cast stone waste because only very low fractions of the select radionuclides that exhibit appreciable mobility (technetium-99 and iodine-129) would be partitioned to the sulfate precipitate (DOE 2003e).

E.1.2.3.9.4 Assumptions and Uncertainties

Although work has been conducted to date regarding the performance of the sulfate precipitation and grouting processes, additional R&D would be necessary to optimize the performance of these processes.

Sulfate removal process development would need to be optimized within the constraints of the existing WTP process design.

The sulfate removal process would add nitrate and some additional sodium to the LAW feed to WTP vitrification. This would be offset by a substantial reduction in the quantity of ILAW glass produced.

Melter replacement frequency was assumed to be independent of the application of sulfate removal to the pretreated LAW solution. However, sulfate removal could increase WTP LAW melter service life, particularly for feeds with high sulfate-to-sodium ratios.

ILAW glass formulations with sulfate removal were assumed to meet the minimum performance requirements of the **Hanford Immobilized Low-Activity Waste Performance Assessment: 2001 Version** (Mann et al. 2001).

Partial precipitation of other cations (e.g., chromium, barium, and lead) and radionuclides (e.g., strontium-90, technetium-99, cesium-137, uranium-238, and TRU waste elements) is expected to occur during sulfate removal, which would decrease the concentration of these species in the ILAW glass produced from sulfate-depleted LAW. For purposes of analysis, these components were conservatively assumed to remain in the liquid stream returned to the WTP for incorporation into the ILAW glass. These partially precipitated components were also assumed to be present in the sulfate grout waste.

E.1.2.3.10 Technetium-99 Removal

The PT facility was originally designed to remove technetium and blend the technetium from the LAW vitrification feed with HLW solids for feed to HLW vitrification. However, based on reviews of technetium-99 in ILAW glass, DOE and Ecology agreed to delete technetium removal from the WTP permit (Hedges 2008). With this modification, the technetium content of IHLW glass would decrease, while the technetium concentration in the ILAW glass would increase (DOE 2003a).

Tank Closure Alternatives 2B and 3B are the only alternatives analyzed in this **TC & WM EIS** that would remove technetium-99 in the WTP (see Table E-3). If the technetium-99 were not removed in pretreatment, it would be included in the resulting ILAW glass; if technetium-99 removal occurred during pretreatment, it would be included in the IHLW glass.

Tank Closure Alternatives 2A and 2B represent the conclusions of the **TWRS EIS ROD** (62 FR 8693) with modifications. Tank Closure Alternative 2A does not include technetium-99 removal in pretreatment; as

noted above, Tank Closure Alternative 2B does. The only waste forms produced under both Tank Closure Alternatives 2A and 2B would be the vitrified products of the WTP. Therefore, comparison of the two alternatives reflects long-term waste performance on site and shows the impact of the decision to eliminate the technetium-99 removal capability from pretreatment.

Under Tank Closure Alternative 3A, technetium-99 would not be removed from the waste prior to bulk vitrification. The long-term waste performance of the bulk vitrification waste form could then be compared to that of the ILAW glass because technetium-99 would be present in both glass waste forms. Under Tank Closure Alternative 3B, technetium-99 would be removed prior to incorporating the LAW into cast stone waste in the 200-East Area because previous grout data showed that technetium-99 removal would be required for acceptable long-term waste performance. For analysis purposes, no technetium-99 removal was assumed to be performed in the 200-West Area.

E.1.2.3.10.1 Technology Description

Technetium-99 removal by ion exchange was originally included in the WTP pretreatment process. In that process, waste feed to the WTP would first undergo ultrafiltration to separate liquids from the HLW solids or precipitated strontium and TRU waste. The liquid portion would then be processed through cesium ion exchange to remove cesium-137, which, if not removed, would result in high dose rates from the ILAW glass and require special handling and shielding. After cesium ion exchange, the waste would be processed through technetium ion exchange to remove technetium-99. Technetium-99 has a very long half-life (213,000 years) and requires durable waste forms for disposal. The technetium removed from the feed to LAW vitrification would be blended with HLW solids for feed to HLW vitrification. For analysis purposes, this EIS assumes a technetium-99 removal efficiency of approximately 99 percent (CEES 2007a, 2007b).

E.1.2.3.10.2 Facility

The Pretreatment Facility was originally designed to remove technetium. Based on reviews of technetium-99 in ILAW glass, DOE and Ecology decided to delete technetium removal from the WTP permit (Hedges 2008). Construction of the Pretreatment Facility to date has eliminated the capability to remove technetium-99 from the LAW stream. This TC & WM EIS, however, assumes that technetium-99 removal could be completed in the existing Pretreatment Facility. Design and construction modifications would need to be made later to add the technetium-99 removal capacity, if required.

E.1.2.3.10.3 Assumptions and Uncertainties

The ability of the ion exchange materials to remove technetium-99 to the desired level is currently uncertain. The WTP project has selected an alternative ion exchange resin in the event that the previously identified material did not perform adequately. Some of the technetium-99 present in the tank waste is not in the anionic pertechnetate form; thus, it would not be removed by the ion exchange process.

E.1.2.3.11 Tank-Derived Mixed Transuranic Waste Processing

This section describes the processing and packaging of tank-derived mixed TRU waste for disposal. There are currently 20 tanks (17 SSTs and 3 DSTs) that are candidates for classification as mixed TRU waste. Tank inventory data indicate that approximately 11.8 million liters (3.1 million gallons) total of waste could be treated and managed as mixed TRU waste. Waste from 11 of the SSTs may be processed by CH methods, while the waste in the remaining 6 SSTs and 3 DSTs would likely need to be processed by RH methods (Certa et al 2008).

Table E-9 presents these tanks and their associated waste volumes.

Table E-9. Mixed Transuranic Waste Tanks and Associated Volumes

| Tank | Waste Type | Waste Volume ^a (kiloliters) |
|-------------------------------------|--------------|---|
| Single-shell tanks | | |
| 241-B-201 | CH-TRU waste | 115 |
| 241-B-202 | CH-TRU waste | 111 |
| 241-B-203 | CH-TRU waste | 193 |
| 241-B-204 | CH-TRU waste | 189 |
| 241-T-201 | CH-TRU waste | 110 |
| 241-T-202 | CH-TRU waste | 81 |
| 241-T-203 | CH-TRU waste | 140 |
| 241-T-204 | CH-TRU waste | 140 |
| 241-T-104 | CH-TRU waste | 1,199 |
| 241-T-110 | CH-TRU waste | 1,397 |
| 241-T-111 | CH-TRU waste | 1,692 |
| 241-T-105 | RH-TRU waste | 371 |
| 241-T-107 | RH-TRU waste | 655 |
| 241-T-112 | RH-TRU waste | 226 |
| 241-B-107 | RH-TRU waste | 611 |
| 241-B-110 | RH-TRU waste | 925 |
| 241-B-111 | RH-TRU waste | 910 |
| Double-shell tanks | | |
| 241-AW-103 | RH-TRU waste | 1,184 |
| 241-AW-105 | RH-TRU waste | 999 |
| 241-SY-102 | RH-TRU waste | 550 |
| Total mixed TRU waste volume | | 11,798 |

^a Includes salt cake and sludge phases.

Note: To convert kiloliters to gallons, multiply by 264.17.

Key: CH=contact-handled; RH=remote-handled; TRU=transuranic.

Source: Certa et al. 2008; DOE 2003g.

E.1.2.3.11.1 Technology Description

The mixed TRU waste would be processed and packaged in accordance with applicable regulations and waste acceptance criteria. The tank waste is considered to be mixed waste and is therefore subject to regulation under the Atomic Energy Act of 1954 and RCRA. Appropriate permits for these facilities would be obtained. All TRU waste packages would be designed as required to meet WIPP waste acceptance criteria.

The CH-TRU waste may be appropriately processed using simple processes such as dewatering and packaging. For RH-TRU waste, an additional step, sludge washing, may be applied to remove the soluble cesium-137 and thereby reduce the radiation dose rate of the packaged waste; however, for purposes of analysis, it was assumed that this step would not occur.

E.1.2.3.11.2 Contact-Handled Mixed Transuranic Waste

For CH-mixed TRU waste, the process is based on packaging the waste using transportable treatment systems located at each tank farm (in both the 200-East and 200-West Areas). These systems are also referred to as "CH-Mixed TRU Waste Facilities." Packaged waste would then be sent to interim storage or disposal.

Feed to the CH-Mixed TRU Waste Facilities would be supplied from the MRS skid. Feed would be pumped in batch transfers as a slurry or sludge to the packaging skid. Each facility would receive waste at a maximum rate of 300 liters (80 gallons) per minute into a receiver tank.

The waste would be pumped into a dewatering unit (e.g., centrifuge) that would produce a liquid waste stream and a solid TRU waste stream for packaging. The solid waste stream would be mixed with an absorbent material to ensure that final waste packaging meets the disposal criteria. The mixed product (TRU waste and absorbent) would then be metered into 208-liter (55-gallon) drums or other approved containers. An appropriate quantity of absorbent material would be added to each waste container to ensure no free liquids are present.

After being filled, the containers would be closed with a bolted lid. The exterior surface of the container would be checked for contamination and decontaminated as necessary. Completed packages would be sent to interim storage for eventual disposal at WIPP.

Offgas generated by the process would be passed through a HEPA filtration system and then discharged through a stack to the atmosphere. Liquid effluent from the facility would be recycled for use in retrieval processes, forwarded to the DST system pending further treatment, or directed to onsite liquid effluent treatment or disposal facilities, as appropriate.

E.1.2.3.11.3 Remote-Handled Mixed Transuranic Waste

For RH-mixed TRU waste, the process is assumed to be located in the 200-East Area at a single, fixed facility for treatment and packaging of waste before storage and disposal. See Figure E-11 for the proposed location. The RH-Mixed TRU Waste Facility would be functionally similar to the CH-Mixed TRU Waste Facilities. Differences include the following:

- Waste feed to the RH system would come from the DST system.
- All operations would be remote.
- The RH-mixed TRU waste system would be housed in a fixed facility located in the 200-East Area.

Additionally, the higher radiation levels in the DST waste would require remote-impact wrenches and cranes to access equipment and piping, which could involve using specialized fasteners, seals, connectors, and skid arrangements. Some of the shielding would need to be removable to allow access to equipment. Moreover, during operational testing, it would be necessary to evaluate access spacing, laydown logistics, ability to repair equipment, and validation of remote operability. The facility design would need to incorporate a controlled laydown area that allows for shielding and contamination control. The facility would also need to have extra flushing and decontamination capability.

Figures E-23 and E-24 present simplified process-block-flow diagrams of the packaging process for CH-mixed TRU and RH-mixed TRU waste, respectively.

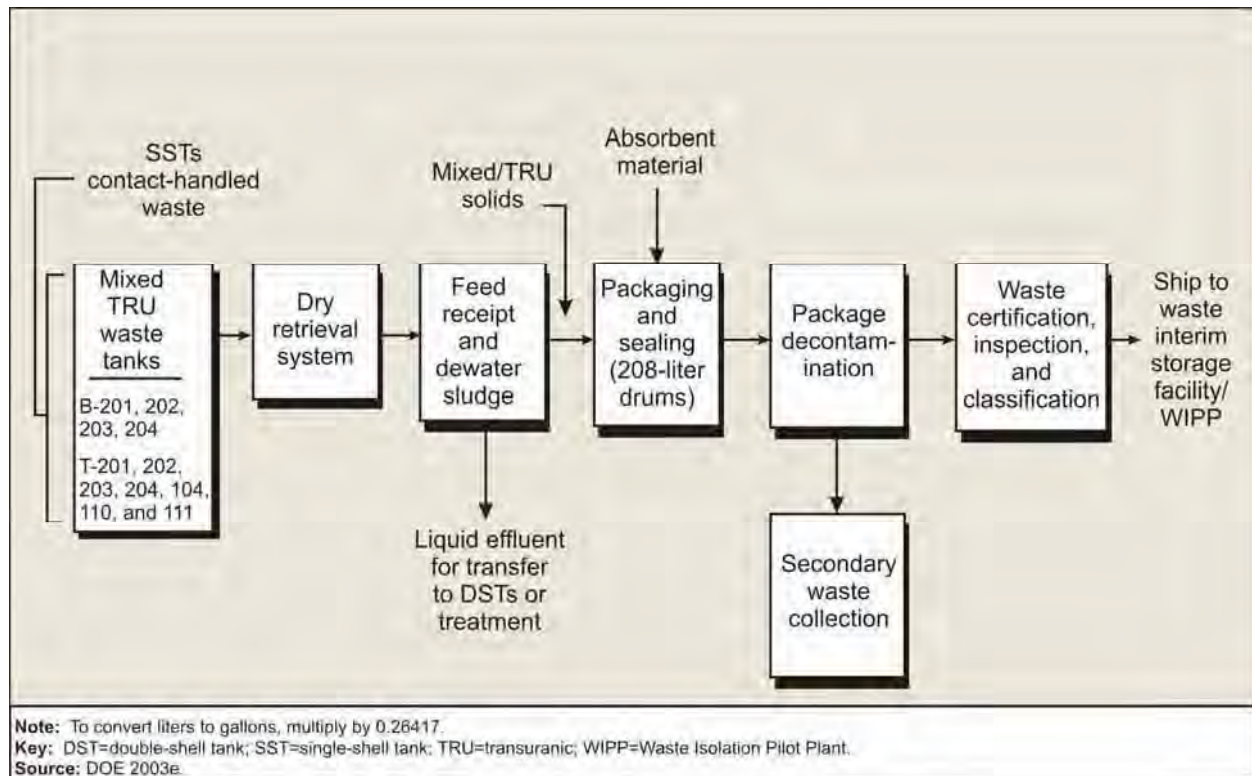

Figure E-23. Contact-Handled Mixed Transuranic Waste Packaging Process Flow Diagram

E.1.2.3.11.4 Transuranic Waste Interim Storage Facility

Given that the demand for transport and disposal could exceed the delivery capacity of WIPP and the availability of transportation casks for the timeframe that the Hanford tank-derived mixed TRU waste may be treated, onsite interim storage and staging facilities were analyzed. Moreover, logistics and prioritization constraints related to TRU waste transport from Hanford to WIPP could necessitate an extended period of onsite interim storage for tank-derived mixed TRU waste. In addition to storage, characterization and certification of the waste may also be needed. Storage time can exceed 90 days; therefore, the TRU Waste Interim Storage Facility would need to be permitted under RCRA (WAC 173-303).

The proposed TRU Waste Interim Storage Facility is expected to provide only a passive storage function and could store both mixed and nonmixed TRU waste. The supplemental treatment facility that would generate tank-derived TRU waste was assumed to provide a TRU waste package that is compliant with the waste acceptance criteria for WIPP. This could necessitate that the supplemental treatment facility provide capabilities for the following:

- Decontamination
- Nondestructive assay (NDA)
- NDE
- Headspace testing
- Certification
- Preparation for transport

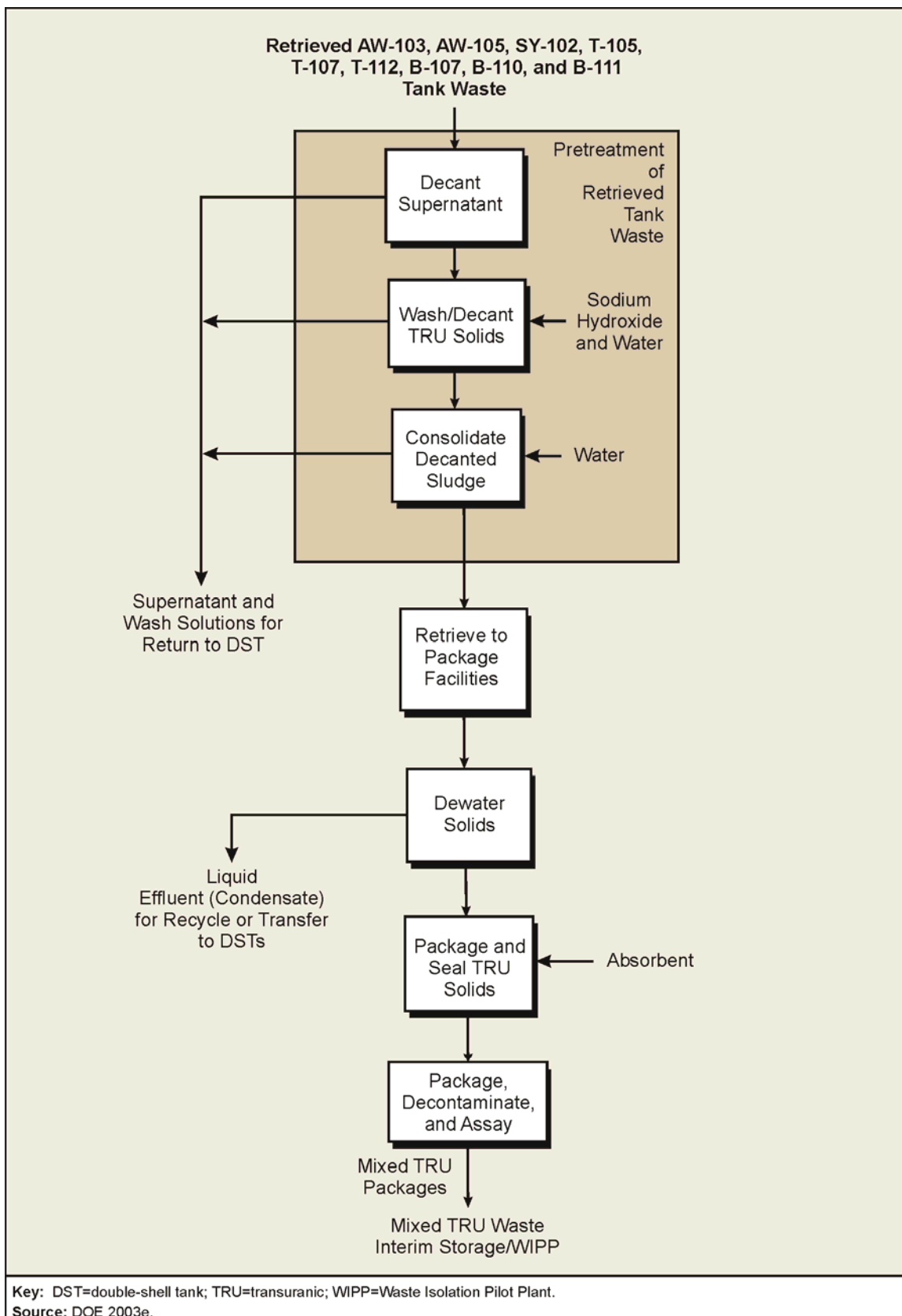

Figure E-24. Remote-Handled Mixed Transuranic Waste Packaging Process Flow Diagram

Tank-derived mixed CH-TRU and RH-TRU waste would be generated and packaged as discussed in Sections E.1.2.3.11.2 and E.1.2.3.11.3, then transferred to the proposed TRU Waste Interim Storage Facility for staging. This proposed facility would be a steel-walled building on a concrete slab (DOE 2003d). The interior floor of the building would be sloped, with a raised perimeter curb to contain and direct spilled liquids to a collection sump into which a portable sump pump could be installed as required. The floor would be sealed with an impervious epoxy sealant to prevent contaminants from entering the concrete.

The building would be accessible through two rollup truck doors and two personnel doors. The building interior would contain a central aisle that facilitates loading and unloading operations. Access and maneuverability areas around the building would be stabilized with asphalt or gravel. Given that the mixed TRU waste drums would be sealed and their external surfaces would be decontaminated, the building ventilation would not have to perform a confinement function. Therefore, the building would be maintained at atmospheric pressure and heating and cooling would not be required for operations. The building would not be insulated except for two rooms, connected through doorways, that would contain the fire riser and electrical/telecommunication systems. The storage area would be provided with overhead lighting.

The TRU Waste Interim Storage Facility footprint was assumed to be 75 meters wide by 174 meters long (247 feet wide by 571 feet long) and to occupy a space envelope of 13,050 square meters (140,500 square feet). To facilitate cost-effectiveness and facility operations, the interim storage building was assumed to be located adjacent to the mixed TRU waste facilities.

To provide the necessary shielding, RH-TRU waste is overpacked within a high-integrity container, a large, reinforced-concrete cylinder that can be sealed with a lid, at the supplemental treatment facility generating RH-TRU waste. The high-integrity container is packed with 208-liter (55-gallon) drums in two layers of seven drums each. Once filled, it is emplaced in the TRU Waste Interim Storage Facility. Eventually the RH-TRU waste would be retrieved from interim storage and emplaced in a TRU waste package transporter II (TRUPACT-II) at the Waste Receiving and Processing Facility (WRAP) or a similar facility in preparation for offsite shipping and disposal at WIPP.

As the TRU Waste Interim Storage Facility was assumed to be located adjacent to the stationary tank-derived RH-Mixed TRU Waste Facility, the same staff would operate both. Given the minimal work scope of interim storage operations (emplacement/retrieval of drums, periodic inspections, etc.), additional supplemental treatment plant operations and maintenance staff would not be required to support the TRU Waste Interim Storage Facility.

The CH-mixed TRU waste drums and RH-mixed TRU waste packages delivered for interim storage are ready for disposal (i.e., the drums are already sealed and external surfaces do not exceed contamination limits). Therefore, the TRU Waste Interim Storage Facility would not be a credible source of significant hazardous or radiological emissions during operation.

The TRU Waste Interim Storage Facility would only serve as a passive storage function. Operations and maintenance activities within this facility would not be a credible source of significant secondary waste.

E.1.2.3.11.5 Facilities

The mixed TRU waste packaging process would include two CH-mixed TRU waste systems and one RH-mixed TRU waste system. Each CH-mixed TRU waste system would consist of approximately three mobile trailers, and the RH-mixed TRU waste system would be housed in a shielded facility with support structures. The two CH-Mixed TRU Waste Facilities would be used simultaneously in the 200-East and 200-West Areas, and the RH-Mixed TRU Waste Facility would be constructed in the 200-East Area. In the 200-West Area, the mobile CH-Mixed TRU Waste Facilities could be located at the T tank farm. In

the 200-East Area, a mobile CH-Mixed TRU Waste Facility could be located at the B tank farm, and an RH-Mixed TRU Waste Facility could be located to the south of the AP tank farm. Potential locations of the facilities appear in Figure E-11. Final locations for these facilities have not been determined.

The waste packaging systems for CH-mixed TRU and RH-mixed TRU wastes would be similar and would include the following elements:

- Waste receipt tanks
- Dewatering
- Drum filling
- Decontamination
- Empty-container staging area
- Filled-container staging area
- Absorbent storage area
- Secondary confinement and air filtration
- Shielding
- Instrumentation and control

General descriptions of the CH-TRU and RH-TRU waste packaging systems and facilities are provided in the following paragraphs.

- **Waste Receipt Tanks.** The waste receipt tanks would receive batch transfers of waste slurry from the MRS process skid. Waste stored in the receipt tanks would be pumped with progressive cavity pumps to the dewatering system. Waste receipt tanks would have a nominal capacity of 5,700 liters (1,500 gallons).
- **Dewatering System.** The dewatering system would remove all drainable liquid from the waste by using, for example, a centrifuge. The system would be nominally rated at 11,300 liters (3,000 gallons) of dewatered waste per day. The dewatering system, drum-filling system, and decontamination systems would be housed in a glovebox-like containment structure. Recovered supernatants would be recycled within the retrieval and dewatering systems. Excess water would be disposed of through the DST system or the ETF. Excess water would be transferred using tanker trucks or through pipelines.
- **Drum-Filling System.** The dewatered waste would be transferred to drums. Concurrent with the waste addition to the drum, absorbent material would be metered in to ensure that the final waste package would contain no free liquids.
- **Decontamination System.** The decontamination system would provide carbon dioxide pellets or other suitable media to facilitate container decontamination.
- **Empty Container Staging Area.** The empty container staging area would provide sufficient storage capacity for 20 empty containers. The drums would be stacked four to a pallet, three pallets high, on a concrete pad. A forklift would be used to transfer empty drums to the packaging system. This area of the facility would not be a radiologically controlled area (RCA). The staging area is expected to be a graded and graveled area with access control, but no weather covering would be provided.
- **Filled Container Staging Area.** The filled container staging area would provide interim storage for filled waste drums. The storage area would accommodate 4 days of production. The staging area would be a concrete pad that is curbed and sloped with access controls and weather

protection. Drums from the staging area would be loaded on trucks for shipment to the TRU Waste Interim Storage Facility.

- **Absorbent Staging Area.** The absorbent staging area would provide temporary storage for absorbent materials received by truck at the RH-Mixed TRU Waste Facility. The absorbent storage area would be a nonradiological operation located adjacent to the waste packaging system.
- **Air Filtration System.** The air filtration system process would maintain negative air pressure within process vessels and areas. Air would flow from those areas with the least potential for contamination to areas with the highest potential for contamination. Air collected by the air filtration system would be passed through HEPA filters before being discharged to a stack. The air filtration system would include heaters to prevent condensation in the HEPA filters, redundant banks of HEPA filters, exhaust fans, and a stack with a continuous air radiation monitor and a gas sampler train.
- **Instrumentation and Control System.** The instrumentation and control system would provide process control and monitoring of waste packaging process equipment and support systems.

Designation and certification of packaged mixed TRU waste would include characterization of results, identification of procedures, preparation of reports, and conduct of interviews to properly collect the required data and systems information to support the TRU waste designation. This data would include WIPP-approved documentation, hazardous waste codes, acceptable knowledge, waste history, and isotopic and chemical constituent information. When necessary, sampling and analysis would be done to support the data packages. Certification and inspection would include the use of audited programs and trained personnel to perform the required certification and quality assurance work.

All CH-Mixed TRU Waste Facilities, except for waste storage pads, would be mobile and temporary. The RH-Mixed TRU Waste Facility was assumed to be a temporary, but not mobile, facility.

Other temporary facilities may be erected during construction of the RH-Mixed TRU Waste Facility. Typically, these facilities are limited to trailers used as construction site offices and change and restroom facilities for the construction workers.

Upon completion of processing, the mobile and temporary facilities would be deactivated, and the waste inventories would be removed to the extent practical, stabilized, and prepared for disposal.

E.1.2.3.11.6 Waste Form/Disposal Package

The waste would be pumped into a dewatering unit (e.g., a centrifuge) that would produce both a liquid waste stream and a solid mixed TRU waste stream for packaging. The solid waste stream would be mixed with an absorbent material to ensure that the final packaged waste would meet the WIPP waste acceptance criteria. The blended product (waste and absorbent) would then be metered into drums or other approved containers.

The TRU waste would be processed and packaged in accordance with applicable regulations and waste acceptance criteria. The tank waste is considered mixed waste and would therefore be subject to regulation under RCRA. Appropriate RCRA permits for the packaging facilities would be obtained. All TRU waste packages would be designed as required to meet the WIPP waste acceptance criteria.

E.1.2.3.11.7 Assumptions and Uncertainties

The mixed TRU waste packaging system would not require the development of any unique process equipment or systems. The technical approach to processing and packaging the subject waste is based on information from other sites within the DOE complex, where a substantial amount of TRU waste processing has already occurred. Disposal of the packaged waste would be in accordance with existing, well-understood requirements.

There is waste in certain HLW storage tanks that ORP believes are candidates for classification as TRU waste based on the origin of the waste. This TC & WM EIS evaluates the environmental impact of handling this tank waste as TRU waste under some Tank Closure alternatives, thus assuming the historical processing data to support this classification. However, DOE has not defined a process for making such determinations and not made a decision whether WIPP can accept such waste. The TRU waste must meet the disposal criteria described in Section E.1.2.4.3.1.

The excess water from dewatering operations should be acceptable for treatment at the ETF. If it were unacceptable, this waste stream would be sent to the DSTs for processing in the WTP.

E.1.2.4 Waste Post-Treatment Storage and Disposal

Many waste disposal aspects of the proposed actions have been addressed in previous EISs. DOE has evaluated the programmatic aspects of waste management across the DOE complex (**Final Waste Management Programmatic Environmental Impact Statement for Managing Treatment, Storage, and Disposal of Radioactive and Hazardous Waste** [DOE 1997a]). WIPP has an EIS that addressed transportation and disposal of a given waste quantity at WIPP (**Waste Isolation Pilot Plant Disposal Phase Final Supplemental Environmental Impact Statement** [DOE 1997b]). These EISs adopted assumptions and methodologies for assessing waste transportation to and disposal at the respective facilities and reported resultant environmental impacts. This TC & WM EIS was developed to be as consistent as possible with these adopted assumptions and methodologies to avoid contradictions in the impacts reported for overlapping activities.

E.1.2.4.1 Immobilized High-Level Radioactive Glass Waste

This section provides information used to assess the impacts of interim storage of IHLW glass in specially designed facilities on Hanford.

E.1.2.4.1.1 Technology Description

Based on the Preferred Alternative selected in the TWRS EIS (DOE and Ecology 1996) for the treatment of Hanford tank waste and a supplement analysis (DOE 1998), treatment at Hanford's WTP is expected to involve separation of the waste into high- and low-activity fractions by removal of selected radionuclides (e.g., cesium-137, strontium-90, and TRU waste). The high-activity portion of the waste would be vitrified in borosilicate glass and placed in welded stainless steel canisters measuring 0.6 meters in diameter by 4.6 meters high (2 feet in diameter by 15 feet high). Each IHLW glass canister would contain an average of 3.2 metric tons of glass IHLW. The low-activity fraction is discussed in Section E.1.2.4.2.

The IHLW glass canisters would be placed in interim storage on Hanford. A number of factors influence the volume of IHLW glass produced and, hence, the number of canisters required under each alternative analyzed in this TC & WM EIS. The number of canisters produced was assumed to be directly proportional to the percentage of waste retrieved from the tanks for processing. For the retrieved waste, the amount of waste that could be immobilized in a given volume of glass depends on the composition of the waste, the combination of glass-forming materials used, and the desired properties of the IHLW glass

to be produced. For example, the presence of chromium in the waste at relatively minor concentrations (e.g., less than 1 weight-percent chromium oxide by weight) could promote the formation of solid spinel phases that could create difficulties in processing the glass in typical joule-heated melters. Elevated quantities of aluminum, iron, and zirconium in the waste could also limit the processibility and durability of the final waste form. Other minor constituents such as sulfate have limited solubilities in glass at 1,050 to 1,150 °C (1,922 to 2,100 °F) and are therefore important factors in determining the amount of waste loading that could be achieved for the IHLW glass.

For the purposes of analysis in this TC & WM EIS, glass-property constraints that are less conservative than those previously employed were utilized. See Section E.1.2.3.1.7 for additional information. The resulting estimates of total IHLW glass volume are still considered to be conservative because of the glass-property predictions and assumptions regarding the extent of removal of constituents that influence the overall IHLW glass volume in pretreatment. The resulting estimates of IHLW glass volumes under each of the alternatives analyzed appear in Table E-10.

E.1.2.4.1.2 Facilities

The facilities required for interim storage of IHLW glass are described in Section E.1.2.1.3. The current planned capacity of the CSB is 880 canisters of IHLW glass. Eventually, structures similar to the CSB would be constructed as storage modules, each able to hold 2,640 canisters. Each module would be the same as the first storage module to be constructed as part of the IHLW Shipping/Transfer Facility (DOE 2003d). The number of IHLW Interim Storage Modules to be constructed varies under each Tank Closure alternative evaluated in this TC & WM EIS, depending on the number of canisters produced.

E.1.2.4.1.3 Transportation

Project W-464, *Immobilized High-Level Waste Interim Storage Facility, Preliminary Design Report* (Colosi 2002) provides data regarding onsite transportation of IHLW glass canisters from the WTP to the IHLW Shipping/Transfer Facility. Based on possible site locations recommended for the IHLW Shipping/Transfer Facility, the longest onsite travel distance would be 7.9 kilometers (4.8 miles). Transported waste would be sufficiently shielded to comply with radiation-level restrictions imposed by 49 CFR 173.

E.1.2.4.1.4 Disposal

Although IHLW would be disposed of off site, IHLW may remain on site in interim storage for a period of time. As indicated in the Administration's fiscal year 2010 budget request, the Administration intends to terminate the Yucca Mountain program while developing nuclear waste disposal alternatives. Notwithstanding the decision to terminate the Yucca Mountain program, DOE remains committed to meeting its obligations to manage and ultimately dispose of HLW and SNF. The Administration intends to convene a blue ribbon commission to evaluate alternative approaches for meeting these objectives. The commission will provide the opportunity for a meaningful dialogue on how best to address this challenging issue and will provide recommendations that will form the basis for working with Congress to revise the statutory framework for managing and disposing of HLW and SNF.

Table E-10. Summary Waste Masses/Volumes/Waste Containers for Tank Closure Alternatives

| Tank Closure Alternative | Immobilized High-Level Radioactive Waste (Notes 1 and 2) | | | Immobilized Low-Activity Waste (Note 1) | | | Bulk Vitrification (Note 1) | | | Cast Stone (Note 1) | | | Steam Reforming (Note 1) | | |
|---|--|--------------------------------|-----------------------|---|--------------------------------|-----------------------|-----------------------------|--------------------------------|-----------------------|-----------------------|--------------------------------|-----------------------|--------------------------|----------------------------------|-----------------------|
| | Mass (MTG) | Glass Volume (m ³) | No. of Cont. (Note 3) | Mass (MTG) | Glass Volume (m ³) | No. of Cont. (Note 4) | Mass (MT Glass) | Glass Volume (m ³) | No. of Cont. (Note 5) | Mass (MT Grout) | Gross Volume (m ³) | No. of Cont. (Note 6) | Mass (MT Product) | Product Volume (m ³) | No. of Cont. (Note 7) |
| 2A | 38,400 | 14,220 | 12,000 | 553,510 | 212,890 | 92,250 | - | - | - | - | - | - | - | - | - |
| 2B | 38,400 | 14,220 | 12,000 | 553,510 | 212,890 | 92,250 | - | - | - | - | - | - | - | - | - |
| 3A (Note 13) | 27,840 | 10,310 | 8,700 | 171,040 | 65,780 | 28,510 | 200 W: 100,350 | 200 W: 40,140 | 200 W: 2,360 | - | - | - | - | - | - |
| 3B (Note 13) | 27,840 | 10,310 | 8,700 | 171,040 | 65,780 | 28,510 | - | - | - | 200 W: 181,870 | 200 W: 90,940 | 200 W: 9,090 | - | - | - |
| 3C (Note 13) | 27,840 | 10,310 | 8,700 | 171,040 | 65,780 | 28,510 | - | - | - | 200 E: 283,690 | 200 E: 141,840 | 200 E: 14,180 | 200 W: 101,950 | 200 W: 101,950 | 200 W: 45,310 |
| 4 | 27,840 | 10,310 | 8,700 | 171,040 | 65,780 | 28,510 | 200 W: 101,340 | 200 W: 40,540 | 200 W: 2,380 | 200 E: 287,540 | 200 E: 143,770 | 200 E: 14,380 | - | - | - |
| WTP: | 6,730 | 2,490 | 2,100 | 1,280 | 490 | 220 | - | - | - | - | - | - | - | - | - |
| PPF Feed: | 34,570 | 12,800 | 10,800 | 172,320 | 66,270 | 28,730 | - | - | - | - | - | - | - | - | - |
| Total: (Notes 8 and 13) | 24,960 | 9,240 | 7,800 | 186,590 | 71,760 | 31,100 | 200 W: 91,490 | 200 W: 36,590 | 200 W: 2,150 | 200 E: 100,080 | 200 E: 50,040 | 200 E: 5,000 | 200 E: 158,970 | 200 E: 158,970 | 200 E: 70,650 |
| 5 (Notes 9, 12, and 13) | 548,260 | 203,060 | 171,330 | PPF Glass: 4,010 | PPF Glass: 1,540 | PPF Glass: 670 | - | - | - | - | - | - | - | - | - |
| 6A , Base Case (Notes 10 and 11) | 548,260 | 203,060 | 171,330 | PPF Glass: 4,010 | PPF Glass: 1,540 | PPF Glass: 670 | - | - | - | - | - | - | - | - | - |
| 6A , Option Case (Notes 10 and 11) | 548,260 | 203,060 | 171,330 | PPF Glass: 1,097,750 | PPF Glass: 42,210 | PPF Glass: 18,290 | - | - | - | - | - | - | - | - | - |
| 6B , Base Case (Note 11 and 12) | 38,400 | 14,220 | 12,000 | 557,990 | 214,610 | 93,000 | - | - | - | - | - | - | - | - | - |
| 6B , Option Case (Note 11 and 12) | 38,400 | 14,220 | 12,000 | 557,990 | 214,610 | 93,000 | PPF Glass: 4,010 | PPF Glass: 1,540 | PPF Glass: 670 | PPF Glass: 109,750 | PPF Glass: 42,210 | PPF Glass: 18,290 | - | - | - |
| 6C (Note 12) | 38,400 | 14,220 | 12,000 | 553,510 | 212,890 | 92,250 | - | - | - | - | - | - | - | - | - |

Key: 200-E=200-East Area; 200-W=200-West Area; BV=bulk vitrification; CH=contact-handled; Cont.=containers; DST=double-shell tank; HLW=high-level radioactive waste; IHLW=immobilized high-level radioactive waste; ILAW=immobilized low-activity waste; LAW=low-activity waste; LW=low-activity waste; TRU=transuranic; yd3=cubic yards; WTP=Waste Treatment Plant; RH=remote-handled; SST=single-shell tank; TRU=transuranic; yd3=cubic yards; WTP=Waste Treatment Plant.

Table E-10. Summary Waste Masses/Volumes/Waste Containers for Tank Closure Alternatives (continued)

General Notes:

Due to rounding, the values listed in this table may not calculate precisely.

Table reflects the mass balances included with Calculation Package WT-ST-056, Rev. 2, dated March 19, 2007, Revision of PCAL 17284-2 Mass Balance, WT-ST-056 and "Mass Balance Calculation for Supplemental Treatment Technologies," Revision 10, for the following Tank Closure Alternatives: 2A, 2B, 3A, 3B, 3C, 4, 5 and 6B (CEES 2007b).

Mass balances were not provided for Tank Closure Alternatives 1, 6A, and 6C.

To convert cubic meters to cubic yards, multiply by 1.308; kilograms to pounds, by 2.2046.

Table Notes:

1. Per R. Wilson to B. Gannon email, dated June 5, 2003, "Preliminary Alt. 2B Glass Production Quantities (RPP System Plan, Rev. 1 Draft Conditions)" (Wilson 2003), the following values were used:

- Mass of IHLW glass: 3.2 metric tons of glass per canister (this assumes use of the thin-wall IHLW canister)
- Mass of ILAW glass: 6 metric tons of glass per container
- Density of IHLW glass: 2,700 kilograms per cubic meter
- Density of ILAW glass: 2,600 kilograms per cubic meter

Per Mass Balance Calculation referenced above, the following values were used:

- Mass of Bulk Vitrification glass: 42.6 metric tons of glass per container
- Mass of Cast Stone (grount): 20.0 metric tons grount per container
- Mass of Steam Reforming (product): 2.25 metric tons product per container
- Density of BV glass: 2,500 kilograms per cubic meter
- Density of Cast Stone (grount): 2,000 kilograms per cubic meter
- Density of Steam Reforming (product): 1,000 kilograms per cubic meter

2. The IHLW estimates exclude the estimated mass, volume and number of canisters generated by the treatment of the cesium and strontium capsules in the WTP. Estimates for this waste stream are (ref: Data Request No. 199, Calculation Package WT-ST-053, Rev. 1, May 3, 2006) (CEES 2006c):

- Mass (metric tons of glass): 1,090
- Volume (cubic meters): 400
- Number of IHLW canisters: 340

3. Per DOE/ORP-2003-08, Revision 0, the IHLW canisters are to be 0.6 meters (2 feet) in diameter by 4.5 meters (15 feet) long (DOE 2003a). Per Alternative 3 – Mass Balance Updated to River Protection Project System Plan, Revision 1 – Case 3, Effective Date: May 21, 2003, Section 4.3, the waste loading for each canister was assumed to be 3.2 metric tons of glass, which reflects use of the thin-wall IHLW canister. Canister volume approximately 1.27 cubic meters. Glass volume per canister = 1.18 cubic meters (DOE 2003f). Per email, R. Wilson to M. Burandt, "Estimated IHLW Canister Reduction from 20 TRU Tanks," dated April 2, 2004, the number of IHLW canisters is to be reduced by 500 canisters to account for tank TRU waste (Wilson 2004). Tank Closure Alternative 4 includes an additional 2,102 (rounded to 2,100) IHLW canisters resulting from the treatment of BX and SX tank farms' "tanks, ancillary equipment removal, and deep soils removal" recovered in the PPF (ref: Calculation Package WT-ST-040, Revision 4, January 8, 2007) (CEES 2007c).

4. Per DOE/ORP-2003-08, Revision 0, the ILAW containers are to be 1.22 meters (4 feet) in diameter by 2.3 meters (7.6 feet) long and contain 6 metric tons of glass (DOE 2003a). Canister volume approximately 2.69 cubic meters. Glass volume/canister = 2.31 cubic meters. **Tank Closure Alternative 4** includes an additional 215 (rounded to 220) ILAW canisters resulting from the treatment of BX and SX tank farms' deep soil removal that is recovered in the PPF (ref: Calculation Package WT-ST-040, Revision 4, January 8, 2007) (CEES 2007c). **Tank Closure Alternatives 6A, Base Case, and 6B, Base Case**, include 669 (rounded to 670) ILAW containers resulting from the treatment of "deep soils removal" from the 12 SST farms. **Tank Closure Alternatives 6A, Option Case, and 6B, Option Case**, include 18,292 (rounded to 18,290) LAW containers resulting from the treatment of deep soils removal at the 12 SST farms and the 6 sets of cribs and trenches (ditches) in the B and T Areas. The waste is recovered and thermally treated in the PPF (ref: Calculation Packages WT-ST-040, Revision 4, January 8, 2007 and WT-ST-052, Rev. 4, January 17, 2007) (CEES 2007c, 2007d).
5. Per response to Data Request 202 – Supplemental Treatment Data Review for the Tank Closure EIS, dated April 17, 2006, the BV containers are to be boxes with nominal dimensions of 10 feet x 24 feet x 8 feet, 71.1 cubic yards or approximately 54.3 cubic meters. Per the mass balances referenced above, glass mass per box = 42.6 metric tons of glass (CH2M HILL 2006b).
6. Per response to Data Request 202 – Supplemental Treatment Data Review for the Tank Closure EIS, dated April 17, 2006, the cast stone containers are to be boxes with nominal dimensions of 9 feet x 9 feet x 5 feet, 15 cubic yards or approximately 11.5 cubic meters. Per mass balances referenced above, grount volume per box = 10 cubic meters with a mass = 20 metric tons (CH2M HILL 2006b).
7. Per the mass balances referenced above, the steam reforming product (assumed to be granular solids, not a grouted monolithic solid) containers would contain a product volume of 2.25 cubic meters per container at 19.8 percent sodium oxide. At the density of 1,000 kilograms per cubic meters each container's mass = 2.25 metric tons.
8. The Tank Closure Alternative 4 totals for IHLW and ILAW include the tank waste and PPF feed contributions resulting from clean closure of the BX and SX tank farms (ref: Calculation Package WT-ST-040, Revision 4, January 8, 2007) (CEES 2007c).

Table E–10. Summary Waste Masses/Volumes/Waste Containers for Tank Closure Alternatives (continued)

9. Per the mass balances referenced above, Tank Closure Alternative 5 produces a sulfate grout waste to be disposed of on site with a density of 1,800 kilograms per cubic meter; at a 90 percent waste retrieval, the mass, volume, and number of containers are respectively:
- Mass (metric tons) = 55,700
 - Volume (cubic meters) = 19,840
 - Number of containers = 6,120 (3.6 cubic meter capacity boxes, 90 percent filled)

This waste form is excluded from the Cast Stone estimates.

10. Mass of IHLW for Tank Closure Alternative 6A is derived from Calculation Package WT-ST-025, Rev. 6, dated October 18, 2006. Mass = 6.45×108 kilograms $\times 0.85$ (ratio of IHLW mass, relaxed Glass Properties Model (GPM), River Protection Project System Plan, Draft Rev. 1 (Guidance) to GPM) = 5.48×108 kilograms (CEES 2006d; DOE 2003f).

11. **Tank Closure Alternatives 6A and 6B, Base and Option Cases**, produce 8.82×10^5 cubic yards or approximately 147,000 shielded boxes of tanks/ancillary equipment that are to be managed as HLW and are to be disposed of off site. The number of shielded boxes assumes 2X (swell factor) of the excavated volume without compaction.

12. ILAW produced under **Tank Closure Alternatives 6B, Base Case and Option Case**, is to be managed as IHLW and would be disposed of off site.

13. **Tank Closure Alternatives 3A, 3B, 3C, 4, and 5** include the treatment of tank TRU waste. This TRU waste would be treated in new treatment facilities and disposed of at WIPP. Waste in the following tanks is assumed to be managed as TRU waste (ref: Certa et al. 2008): **Tank Closure Alternatives 1, 2A, 2B, 6A, 6B and 6C** do not include the treatment of tank TRU waste and therefore do not assume disposal at WIPP. Under these Tank Closure alternatives, the waste in the 20 tanks would be treated as HLW.

- CH SST: B-201, B-202, B-203, B-204, T-201, T-202, T-203, T-204, T-104, T-110, T-11
- RH SST: T-112, T-105, T-107, B-107, B-110, B-111
- RH DST: AW-103, AW-105, SY-102

Per the mass balances referenced above, the Tank TRU waste mass, the waste volumes and numbers of containers (for Tank Closure Alternatives 3A, 3B, 3C, 4 and 5) are as follows (assumes 100 percent of the original SST TRU inventory is CH-TRU waste):

| Tank Closure Alternatives | Mass (metric tons) | Waste Volumes (cubic meters) | Numbers of Containers |
|---------------------------|---|---|---|
| 3A, 3B, and 3C | CH: 1,740 RH (SST): 2,210 RH (DST): 710 | CH: 1,500 RH (SST): 1,620 RH (DST): 520 | CH: 7,120 RH (SST): 7,710 RH (DST): 2,480 |
| 4 | CH: 1,760 RH (SST): 2,230 RH (DST): 720 | CH: 1,510 RH (SST): 1,630 RH (DST): 530 | CH: 7,190 RH (SST): 7,780 RH (DST): 2,500 |
| 5 | CH: 1,590 RH (SST): 2,010 RH (DST): 650 | CH: 1,360 RH (SST): 1,470 RH (DST): 470 | CH: 6,480 RH (SST): 7,010 RH (DST): 2,260 |

Per WT-ST-046, Rev. 0, dated April 27, 2004, **Optimized Drum Estimates for RH-TRU Single-Shell Tanks**, the CH-TRU and RH-TRU waste are to be packaged in 55-gallon (~0.21-cubic-meter) drums (CEES 2004). Each drum would be filled with 40 gallons of sludge and 15 gallons of sorbent material. Assuming the sorbent is mixed with the waste prior to loading of drums. Density of CH-TRU waste sludges = 1,230 kilograms per cubic meter. Density of dried RH-TRU waste sludges = 1,500 kilograms per cubic meter. Densities of sorbent/waste:

- CH-TRU waste: $40/55 \times 1,230$ kilograms per cubic meter + $15/55 \times 1,000$ kilograms per cubic meter = 1,167 kilograms per cubic meter.
- RH-TRU waste: $40/55 \times 1,500$ kilograms per cubic meter + $15/55 \times 1,000$ kilograms per cubic meter = 1,364 kilograms per cubic meter.

E.1.2.4.2 Immobilized Low-Activity Glass Waste

This section provides information used to assess the impacts of the transportation and disposal of ILAW glass generated under the various alternatives evaluated in this TC & WM EIS, including wastes from supplemental treatment of Hanford tank waste. This TC & WM EIS also addresses disposal of the ILAW glass produced by the WTP and the glass melters from the WTP that would be taken out of service and would be replaced.

E.1.2.4.2.1 Technology Description

Vitrification at the WTP, as well as one or more supplemental treatment technologies, could be used to process LAW currently stored in the Hanford tank farms. Supplemental treatment technologies being considered include bulk vitrification, cast stone, steam reforming, sulfate removal, technetium removal, solid-liquid separations, and mixed TRU waste processing and packaging.

Disposal capabilities would be required for the following waste forms that could be produced by the WTP and supplemental treatment technologies (DOE 2003e).

- **ILAW Glass.** This waste form is glass produced by the WTP. The ILAW glass packages are stainless steel cylinders (2.7-cubic-meter [3.5-cubic-yard] capacity) that have been filled with vitrified LAW, cooled, and sealed. The packages are approximately 2.3 meters in height and 1.22 meters in diameter (7.5 feet in height and 4.0 feet in diameter). The density of ILAW glass is assumed to be 2.6 metric tons per cubic meter with each package containing approximately 6 metric tons of glass.
- **Bulk Vitrification Glass.** This waste form is assumed to be a monolithic glass with a density of 2.5 metric tons per cubic meter. The waste would be placed into a roll-off box for disposal. The 54.3-cubic-meter (71.1-cubic-yard) roll-off box would contain 17 cubic meters (22.3 cubic yards) of glass waste form and the remaining box space would be filled with soil or sand.
- **Cast Stone Waste.** This waste form is grout with a cured density of approximately 2.0 metric tons per cubic meter. The grout would be cast in 11.5-cubic-meter (15-cubic-yard) containers.
- **Steam Reforming Waste.** This waste form was assumed to be a mineralized granular product suitable for packaging. The final product was assumed to have a density of 1.0 metric ton per cubic meter. The waste would be placed into steel containers for disposal. The 2.25-cubic-meter (2.9-cubic-yard) containers would weigh approximately 2.25 metric tons.

A pretreatment process for the WTP, sulfate removal, would generate about 20,000 cubic meters (26,200 cubic yards) of precipitated strontium sulfate blended with grout (sulfate grout waste). This waste form would be cast into 3.6-cubic-meter (4.7-cubic-yard) containers. This option would have the net effect of reducing the volume of ILAW glass produced in the WTP for high-sulfate waste feeds and is considered in the evaluation of Tank Closure Alternative 5.

In addition to the primary products (ILAW glass), the actions proposed in this TC & WM EIS would generate numerous LLW and MLLW streams as secondary waste. Further discussion of secondary waste can be found in Section E.1.2.4.5.

For analysis purposes, disposal of all ILAW glass and STP wastes was assumed to be on site in an IDF. See Section E.3.6 for a description and status of the IDF(s) evaluated in this TC & WM EIS.

E.1.2.4.2.2 Transportation

ILAW glass, STP wastes, and secondary waste (LLW or MLLW) would be transported from the WTP, supplemental treatment technology sites, or individual tank farms to onsite disposal facilities. Transport of these containers would be performed by the use of a lowboy trailer attached to a semitractor, loaded with a single waste container per shipment (Colosi 2002). Transported waste would be sufficiently shielded to comply with radiation-level restrictions imposed by 49 CFR 173. See Appendix H for a detailed description of the transportation analysis.

E.1.2.4.2.3 Disposal

Based on the waste form performance information provided in the **Waste Treatment and Supplemental Technology Data Package** (DOE 2003e), the expected release rates of contaminants from the ILAW glass should be less than indicated by information provided in the **Hanford Immobilized Low-Activity Waste Performance Assessment: 2001 Version** (Mann et al. 2001). (See Appendix M for details on waste form performance.)

Release rates from cast stone waste were based on diffusion of immobilized contaminants from the waste form under conditions of near-surface disposal at Hanford. Thus, parameters affecting the source term include items such as the time the release begins, the corrosion rate, and the waste form surface area.

Although the ILAW glass package that would be placed in an IDF would consist of a steel container holding the ILAW glass, the steel container was not assumed to provide a barrier to water intrusion after it is placed into the disposal facility (Mann et al. 2001:Section 3.5.3.1.2).

Alternatives for onsite disposal are evaluated in this EIS and discussed in detail in Section E.1.3.4. As a result of the evaluation of alternatives in this **TC & WM EIS**, different combinations of waste forms and volumes were considered.

E.1.2.4.2.4 Assumptions and Uncertainties

STPs would produce waste forms that meet regulatory requirements for disposal and disposal facility acceptance criteria.

E.1.2.4.3 Tank-Derived Mixed Transuranic Waste

This section describes information used to assess the impacts of mixed TRU waste that would be generated from actions taken under Tank Closure Alternatives 3 through 5.

E.1.2.4.3.1 Technical Description

Tank-derived mixed TRU waste is divided into two types: CH-mixed TRU and RH-mixed TRU waste. CH-mixed TRU waste has dose rates equal to or less than 200 millirem per hour on the surface of the package and can be stored in facilities similar to those used for TRU waste and LLW at Hanford. RH-mixed TRU waste has dose rates above 200 millirem per hour on the surface of the package and requires storage in facilities with shielding capabilities.

The technology analyzed in this EIS for mixed TRU waste retrieval is a vacuum-type method capable of retrieving waste from Hanford's SSTs and DSTs. After retrieval, the waste would be processed (dewatered and absorbent added) to yield CH- or RH-mixed TRU waste that is compliant with the WIPP waste acceptance criteria described in the **Contact-Handled Transuranic Waste Acceptance Criteria for the Waste Isolation Pilot Plant** (DOE 2002a).

The quantities of CH- and RH-mixed TRU waste that supplemental treatment is estimated to produce are listed in Table E-10. Processing rates are expected to be two drums per hour for CH-mixed TRU waste, and one drum per hour for RH-mixed TRU waste.

E.1.2.4.3.2 Facilities

The TRU Waste Interim Storage Facility for CH- and RH-mixed TRU waste would provide the same capabilities as Hanford's CWC. The capabilities of the CWC are described in Section E.3.2. The TRU Waste Interim Storage Facility is described in Section E.1.2.3.11.4.

The shipment of mixed TRU waste generated at Hanford is limited by the receipt rates of WIPP. The CH-Mixed TRU Waste Facilities analyzed in this TC & WM EIS would operate from 2009 through 2010. The RH-Mixed TRU Waste Facility analyzed in this TC & WM EIS would operate from 2015 through 2019. The TRU Waste Interim Storage Facility would be operational for the storage of CH- and RH-mixed TRU waste from 2009 through 2034, pending transportation to the WIPP disposal facility. It was assumed all mixed TRU waste would be shipped off site by 2035, when WIPP is expected to close and discontinue receipt of TRU waste.

The facilities for treatment and storage of mixed TRU waste would obtain applicable permits. Furthermore, any onsite interim storage of mixed TRU waste would have to be permitted under WAC 173-303.

E.1.2.4.3.3 Transportation

Filled drums could be transported from the packaging site to the TRU Waste Interim Storage Facility located adjacent to the RH-Mixed TRU Waste Facility. The longest distance used for evaluating impacts would be transportation from near the T tank farm, near the northern corner of the 200-West Area, to the storage facility located in the 200-East Area south of AP tank farm. The distance traveled between these sites is about 16 kilometers (10 miles). Drum transport could be by flatbed truck or a flatbed trailer attached to a semitractor. Depending on the concentration and quantity of radionuclides, TRU waste packages may require overpacks during transportation to provide additional safety or lower dose rates (DOE 2003d).

Type B containers certified by the NRC would be used for transport to WIPP. Four packaging systems meet this criterion: TRUPACT-II containers; RH-72B (for RH-TRU waste); HalfPACT (for heavy packages of CH-TRU waste); and CNS10-160B (for RH-TRU waste—limits plutonium to 20 grams [0.71 ounces] per shipment). Additional packages are under consideration. At this time, the WIPP transportation system is constraining the rate at which DOE sites can dispose of CH-TRU waste. Transported waste must be sufficiently shielded to comply with radiation-level restrictions imposed by 49 CFR 173.

E.1.2.4.3.4 Disposal

Eventual disposal of the mixed TRU waste would be performed at WIPP. The volumes of CH- and RH-mixed TRU waste estimated to be produced under each Tank Closure alternative are listed in Table E-10.

E.1.2.4.3.5 Assumptions and Uncertainties

- For the purposes of this analysis, it was assumed that WIPP (or some other fully authorized facility) would be available and would have sufficient disposal capacity to eventually meet demand for all CH- and RH-TRU waste generated at Hanford. Any differences in reported

capacity and demand for disposal volume of TRU waste would be resolved without impact on Hanford's treatment, storage, and disposal operations.

- The WIPP original RH-TRU waste design capacity of 7,080 cubic meters (9,260 cubic yards) may not be realized because of original design assumptions and the delay of receipt of RH-TRU waste (**National TRU Waste Management Plan, Corporate Board Annual Report**) (DOE 2002b). Whether this shortcoming would affect the shipment of Hanford's RH-TRU waste is unknown.
- WIPP has a planned 35-year operational life; thus, it may not be available after 2034. Additionally, estimates of anticipated disposal capacity may not be accurate because of the unknowns inherent in waste characterization and remediation actions.

E.1.2.4.4 Waste Treatment Plant Melters

This section describes information used to assess the impacts of onsite transportation and interim storage of WTP melters that would be taken out of service. The LAW melters from WTP operations would be managed and disposed of as MLLW.

For the purposes of analysis in this **TC & WM EIS**, it was assumed that WTP HLW melters would be packaged within an overpack at the WTP to provide shielding and confinement. The overpack's overall dimensions would be 5.29 meters wide by 5.29 meters long by 4.38 meters high (17.4 feet wide by 17.4 feet long by 14.4 feet high). The overpack containing a melter would weigh approximately 263 metric tons (Lowe and Haigh 2003). The dose rate at 30 centimeters (11.8 inches) from the overpack surface would be less than 16 millirem per hour. The radiological inventory within a WTP melter would be equal to or less than that provided in **HLW Melter Radioactive Inventory at End of Life** (BNI 2004).

The HLW melters have not been installed or operated, and a high degree of uncertainty exists about their operation and lifespan. Due to the uncertainty surrounding information about the melters at the WTP, this EIS assumed that the HLW melters would be stored on site.

The LAW melters from WTP operations are expected to be classified as MLLW and would be disposed of in an IDF. As such, WTP LAW melters would require treatment to meet land disposal restrictions under RCRA. The overpack's overall dimensions would be 9.38 meters wide by 6.79 meters long by 4.86 meters high (30.6 feet wide by 21.8 feet long by 15.8 feet high). The overpack containing a melter weight is unknown, but is expected to be significantly greater than the overpacked HLW melter (Lowe and Haigh 2003).

Tank Closure Alternatives 2 through 5 would require disposition of LAW melters that have been taken out of service in an IDF as MLLW. At an estimate of 31 LAW melters, Tank Closure Alternative 2B represents the maximum quantity of LAW melters that would be disposed of on site. Tank Closure Alternative 2B's quantity of melters would be driven by the expanded ILAW glass operations and vitrification treatment processes (SAIC 2007a).

E.1.2.4.4.1 Onsite Transportation

Conveyance of melters from the WTP to either interim storage for HLW melters or the MLLW disposal facility for LAW melters would require specialized equipment for handling these very heavy loads. This could be accomplished using either the WTP onsite transporter or the transporter equipment described in **Failed Melter Disposal – Alternative Generation and Analysis, and Decision Report** (Calmus and Baker 2001).

E.1.2.4.4.2 Interim Storage

The HLW Melter Interim Storage Facility is a storage pad that would provide staging and temporary storage for WTP melters until they could be removed for disposition and final disposal. The pad would consist of a reinforced-concrete slab at grade level. The pad would be sealed to prevent contaminants from entering the concrete and would be sloped to allow precipitation to collect in a trench located in the center of the pad. The collection trench would drain to a sump into which a portable sump pump could be installed as required. The area around the pad would be sloped to prevent rainwater draining onto the pad. To facilitate cost-effectiveness and facility operations, the pad would be located as close as possible to the WTP. The largest HLW Melter Interim Storage Facility footprint (Tank Closure Alternative 6A) would include seven pads, each measuring 38.3 meters wide by 38.3 meters long (126 feet wide by 126 feet long) and occupying a space envelope of 1,467 meters (1,920 square yards). Under Tank Closure Alternative 6A, each HLW Melter Interim Storage Facility pad would be constructed on an as-needed basis for the storage of HLW melters taken out of service. It was assumed that a new pad, up to the required seven, would be constructed every 20 years to support the operational life of the WTP for this alternative.

E.1.2.4.4.3 Assumptions and Uncertainties

- HLW melters would be placed in interim onsite storage until disposition decisions are made and implemented.
- LAW melters would contain residual ILAW and would be disposed of as MLLW. Adequate disposal capacity would be provided in an IDF, which is discussed in Section E.3.6.
- The number of HLW melters requiring disposition varies by alternative, depending on the duration of HLW vitrification operations. All HLW melters taken out of service would be interim-stored on site until disposition decisions are made and implemented. The HLW melter design life is 5 years per melter.
- The number of LAW melters requiring disposition varies by alternative, depending on the duration of LAW vitrification operations. LAW melters taken out of service would be disposed of in an IDF. The assumed LAW melter design life is 5 years.
- Melters would be overpacked in containers that provide confinement and shielding (DOE 2003d).

E.1.2.4.5 Secondary Waste

This section provides information used to assess the impacts of the transportation and disposal of secondary waste generated from construction, operations, deactivation, and closure activities under the various alternatives. Secondary waste is waste generated as a result of another activity. Secondary waste includes TRU waste, LLW, MLLW, hazardous waste, and nonhazardous waste.

E.1.2.4.5.1 Secondary Transuranic Waste

Secondary TRU waste (e.g., equipment, tools, filters, and empty containers) would be generated during waste retrieval and operation of tanks and treatment facilities. The secondary TRU waste would be treated if necessary, packaged, certified (in WRAP or a mobile facility), stored in existing facilities at the CWC pending transportation, and disposed of at WIPP. Projections for secondary TRU waste generation under each Tank Closure, Fast Flux Test Facility (FFTF) Decommissioning, and Waste Management alternative are presented in Chapter 4.

Secondary TRU waste does not include the tank-derived TRU waste that would be generated by treating waste currently stored in the SSTs and DSTs. A discussion of tank-derived TRU waste is presented in Section E.1.2.3.11.

E.1.2.4.5.2 Secondary Low-Level Radioactive Waste

Secondary LLW includes personal protective equipment, tools, filters, empty containers, and contamination control materials (e.g., plastic, paper, wood) that become radiologically contaminated during construction, operations, deactivation, and closure activities, and would be disposed of on site in an IDF. See Chapter 4 for projected volumes under each Tank Closure, FFTF Decommissioning, and Waste Management alternative. The characteristics of this secondary LLW were derived from the Solid Waste Information and Tracking System (**Tri-Party Agreement Databases, Access Mechanism and Procedures** [Friday and Sterling 2002]) or the **Solid Waste Integrated Forecast Technical (SWIFT) Report, FY2006–FY2035 (SWIFT Report)** (Barcot 2005). Most of the LLW would be packaged in standard waste drums or waste boxes. Waste container transport would be by flatbed truck or a semitractor–flatbed trailer combination.

E.1.2.4.5.3 Secondary Mixed Low-Level Radioactive Waste

Secondary MLLW includes personal protective equipment, tools, filters, empty containers, and contamination control materials (e.g., plastic, paper, wood) from construction, operations, deactivation, and closure activities that have become contaminated with radioactive materials and a hazardous component subject to RCRA. In addition to the examples of MLLW cited above, it is anticipated that a secondary MLLW stream containing iodine-129 would be generated by the WTP offgas treatment system. MLLW would be disposed of on site in an IDF. See Chapter 4 for projected volumes under each Tank Closure, FFTF Decommissioning, and Waste Management alternative. The characteristics of this secondary MLLW were derived from the Solid Waste Information and Tracking System (**Tri-Party Agreement Databases, Access Mechanism and Procedures** [Friday and Sterling 2002]) or the **SWIFT Report** (Barcot 2005). MLLW would be treated using a combination of on- and offsite capabilities. Most of the MLLW would be packaged in standard waste drums or waste boxes. Waste container transport would be via flatbed truck or a semitractor-flatbed trailer combination.

Other MLLW would also be generated from closure activities. This waste would include soil excavated from around the tanks, ancillary equipment removed from tank farms, rubble, and tank material and soil that have been processed in a facility to remove some of the radiological and chemical contaminants under the Tank Closure alternatives that consider clean closure (Tank Closure Alternatives 6A and 6B) or selective clean closure (Tank Closure Alternative 4). This waste would be disposed of on site in the new River Protection Project Disposal Facility (RPPDF), which would be similar to an IDF and would be located between the 200-East and 200-West Areas. See Figure E–11 for the proposed location of the RPPDF. See Section E.3.5 for a description of the RPPDF.

E.1.2.4.5.4 Hazardous Waste

Hazardous waste generated during construction, operations, and closure would be packaged in U.S. Department of Transportation-approved containers, stored on site for a short time, and shipped off site to permitted commercial recycling, treatment, and disposal facilities. See Chapter 4 for projected volumes under each Tank Closure, FFTF Decommissioning, and Waste Management alternative.

E.1.2.4.5.5 Nonhazardous Waste

Any nonhazardous solid waste generated during construction, operations, and deactivation would be packaged and transported in conformance with standard industrial practice. Solid waste such as office paper, metal cans, and plastic and glass bottles that can be recycled would be sent off site for that purpose.

Under the Tank Closure alternatives that generate large volumes of nonhazardous solid waste in the form of soils, the material may be stockpiled for use in closure activities. The remaining solid nonhazardous waste would be sent for offsite disposal in a local landfill.

E.1.2.5 Tank System Closure

This section describes the technologies, facilities, uncertainties, and assumptions associated with closure of Hanford waste tanks. The alternatives evaluated in this **TC & WM EIS** include various options for closure of the tanks and related equipment. Tank Closure Alternatives 1 and 2A do not include closure of the tanks. Tank Closure Alternatives 2B through 6C include different options for closure. Options for closure vary depending on factors such as the extent of waste retrieval from the tanks and regulatory decisions regarding the method of closure (e.g., clean closure, landfill closure, combination of clean and landfill closure) (DOE 2003b).

E.1.2.5.1 Tanks

The largest components of the Hanford tank farm system are the tanks themselves. As noted previously, the tanks vary in terms of capacity and age, but have some similarities. All were constructed as underground storage tanks for radiation shielding purposes; all have access risers (pipes) that extend vertically from the tank dome to the tank farm surface; and all 100-series tanks have a 22.9-meter (75-foot) internal diameter.

Options for closure of the tanks themselves involve stabilization of the tanks and any residual waste for closure as a landfill or removal of the tanks and residual waste to regulatory standards for clean closure.

E.1.2.5.1.1 Grout Fill

Stabilizing residual waste and filling the tanks with grout is an option for closure of the tanks as a landfill.

TECHNOLOGY DESCRIPTION

This section describes the process and activities associated with filling the 149 SSTs with grout. Grout is a material formed from cement, fly ash, fine aggregate, sodium bentonite clay, and water to create a free-flowing material that can be used to fill the tanks after waste retrieval is completed. The grout hardens in the tanks to stabilize the residual waste and provide structural stability for landfill closure of the tank farms.

The tanks would be filled with grout in a series of lifts in two separate phases. Each lift would deposit a layer of grout within the tank. The time allotted between each would allow the added grout to set up (cure).

Phase 1 would involve initial grout placement to stabilize the residual waste heel that is expected to remain following retrieval. Materials called sequestering agents could be added to immobilize specific contaminants (technetium and uranium) in residual waste. Phase 2 would involve filling the remaining tank void space up to the tank dome. This would prevent long-term degradation of the tank farm surface barrier due to structural subsidence, minimize water infiltration, and discourage intruder access.

The fill material for the tanks was assumed to be similar to the cold-cap grout formulation developed by the U.S. Army Corps of Engineers for the Hanford Grout Vault Program. This formulation exhibits a relatively low-hydration heat and is free-flowing, self-leveling, and designed to generate little or no free water during curing. This cold-cap grout formulation would include the following materials:

- American Petroleum Institute Class H cement. 180 kilograms per cubic meter (300 pounds per cubic yard).
- American Society for Testing and Materials Class F fly ash. 660 kilograms per cubic meter (1,100 pounds per cubic yard).
- Natural fine aggregate (100 percent passing No. 8 sieve). 780 kilograms per cubic meter (1,300 pounds per cubic yard).
- Sodium bentonite clay. 23 kilograms per cubic meter (38 pounds per cubic yard).
- Water. 330 kilograms per cubic meter (560 pounds per cubic yard).
- High-range, water-reducing admixture. 0.17 kilograms per cubic meter (0.38 pounds per cubic yard).

A portable, continuous-mixing grout plant would be mobilized outside the RCA at a staging area adjacent to each tank farm. Portable generators would provide electrical power; site services would provide water to the mixing plant; and dry-grout mix components would be trucked in from offsite suppliers. The portable grout plant would have two production lines, each with a nominal production rate of 57 cubic meters (75 cubic yards) per hour. The twin grout production lines could be run independently or simultaneously for a combined nominal grout production rate of 115 cubic meters (150 cubic yards) per hour. Both grout production lines would feed into a single pump. The grout would be pumped through a slickline (pipeline that would be used to deliver grout to the tanks) constructed between the grout pump and the tank riser. Scaffolding support may be required adjacent to the riser pit and other locations where the ground would not provide continuous support of the slickline. The grout slickline would cross the radiological control barrier. The slickline within the RCA would be constructed, maintained, and operated by Hanford forces; the slickline outside the RCA could be constructed, maintained, and operated by the grout vendor.

Following residual waste heel stabilization (Phase 1 grouting), the remaining tank void space would be filled with grout (Phase 2). Phase 2 grouting would be accomplished in the same manner as Phase 1 grouting, though lift heights would now be constrained by dissipation of heat generated from the setting grout, tank wall loading associated with hydrostatic pressures, and grout production capability.

The free-flowing grout would be placed into the tank through (and all the way up to) a riser (or risers, depending on the tank configuration) using a tremie (a long tube used to deliver grout into the tank) to limit the drop height. The grout would flow over and cover the residual waste.

Grout lift height limitations and required cure time between lifts would be determined during design. Lift heights would be monitored during the grouting process using the in-tank video system or the existing level gauges. Tank operating pressures would be controlled within specified limits using a portable exhauster. Air emissions would be controlled by HEPA filters on the portable exhauster and by installation of portable confinement structures, if required.

The temperature of the grout during curing would be managed within specified limits by controlling the grout formulation, lift height, and period between lifts. Monitoring instruments for in-tank temperatures

would not be required for process control. The existing data collection system may be used to verify that in-tank temperatures are within specifications.

Once the specified volume of grout has been produced at the grout plant, the plant would be shut down and the volume of grout in the slickline would be delivered to the tank using the slickline cleaning procedure. Cleaning of the grout plant mixing chamber, pump, and slickline would be required at the completion of a grouting campaign or during extended delays. The crushed rock and grout mixture would be disposed of as solid waste at a nonradioactive, nonhazardous disposal facility at Hanford, and the wastewater would be treated and disposed of in compliance with Hanford facility regulations. Weather-sealed protective foam coating would then cover the exposed grout surfaces, which is the current practice for water intrusion prevention (DOE 2003b).

RESIDUAL WASTE STABILIZATION

A volume of residual waste would remain in the tanks for closure. Physical stabilization of the residual waste would be the preferred approach for treatment. Grout has physical as well as chemical waste stabilization properties that would make it an effective technology for stabilization of residual waste. However, chemical stabilization using sequestering agents may also be considered if needed to further immobilize specific contaminants.

Sequestering agents may be used to chemically alter or bind potentially mobile contaminants within the grout matrix. Selection of sequestering agents would depend on the chemical form of the contaminant and its concentration in the residual waste.

For example, Sandia National Laboratories conducted bench-scale testing of inorganic sequestering agents (apatite and bone char) for immobilization of technetium and uranium in Hanford soils, groundwater, and simulated tank waste during fiscal year 2001. Technetium and uranium were expected to represent a major fraction of the radiological risk to groundwater. Apatite performed better in terms of irreversibly adsorbing both technetium and uranium. Very little desorption was detected. The apatite process requires a reducing agent (stannous chloride) (DOE 2003b). The success of this and other work has led to the consideration of apatite as a sequestering agent for tank waste residuals in enhanced grout formulations. Development work has focused on grout formulations that incorporate apatite for use in residual waste immobilization in support of the Accelerated Tank Closure Demonstration Project.

Residual waste can be physically stabilized in one of the following three ways:

- **Microencapsulation.** Residual waste would be mixed with the grout-fill material to achieve dispersion of waste within the grout matrix (as much as technically possible).
- **Macroencapsulation.** Residual waste would be displaced by the grout-fill material and sandwiched between a lower level containing sequestering agents and an upper layer.
- **Isolation.** Residual solid waste not displaced by the grout-fill material would remain adhered to the steel liner. The grout-fill material would minimize water infiltration through the waste and thereby reduce contaminant mobility.

The purpose of waste stabilization is to assist in reducing residual waste constituent mobility by physically isolating the residual waste from the environment and/or treating the waste chemically to reduce its mobility.

The Accelerated Tank Closure Demonstration Alternatives Generation and Analysis Report (Riess 2002) selected the use of a layer of low-strength grout for waste stabilization in the tanks. The **Engineering Report for Interim Closure for Tank No. 241-C-106 and the 241-C Farm 200-Series Tanks**

(Fredenburg 2003) selected the addition of dry solids (granular material) to immobilize the waste heel and eliminate any freestanding liquid in the bottom of the tank. This selection was also based on lessons learned from tank closures at the SRS (DOE 2003b).

A small volume of free liquid may remain after waste retrieval from the tanks. The liquid waste fraction would be immobilized within the granular material; this layer would be covered with grout. Immobilization of the liquid waste is significant because it is expected to contain the highest concentration of mobile constituents. Further, the residual solid waste adhering to the steel liner of the tank bottom would be blanketed with the first grout layer. Although the solid waste would not be fully encapsulated, the overlying grout is expected to minimize contact with infiltration water and maintain a high pH environment that may be conducive to minimizing contaminant solubility. Chemical sequestering agents may be added as part of Phase 1 (to the granular material and grout). The Accelerated Tank Closure Demonstration Project funded the Savannah River Technology Center and Sandia National Laboratories during fiscal year 2003 to develop enhanced grout formulations that incorporate sequestering agents (e.g., apatite) to immobilize residual waste (DOE 2003b).

Physical encapsulation or stabilization is intended to reduce contact between the waste and the environment by isolating the contaminants and contaminated media. This can be accomplished on a macroscale where the residual tank waste would be encased, surrounded by, or sandwiched between solid media such as grout. The placement of grout over residual waste with the tank bottom beneath is also a form of waste stabilization, though less effective than entirely surrounding a waste volume with grout. In addition, the stabilization of residual waste can be accomplished by placing two grout lifts at the bottom of a tank. The initial lift would generally have a higher density than the residual waste, thereby displacing or floating it. Following partial curing of the initial lift, the second lift of grout would be placed over the portion of the residual waste displaced by the first lift.

A granular layer may be placed in the tank bottom following waste retrieval. The granular material may consist of sand, gravel, dry bentonite, absorbent zeolite material, apatite, or apatite blended with another granular material. The purpose of the aggregate material would be to wick and contain the liquid fraction of the residual waste. Zeolites have the added benefit of providing selective ion exchange (i.e., immobilization) for certain constituents (e.g., uranium and technetium-99). The use of dry bentonite (or similar swelling clay material) would create a low-permeability capping layer that physically incorporates the liquid waste fraction and effectively seals the solid waste fraction from future water infiltration. Coarser aggregate material may be added to increase the structural performance of the bentonite layer. Additional study is required to identify design parameters for using granular materials.

The system evaluated in this TC & WM EIS includes the following:

- **Waste Immobilization.** This process involves pneumatic delivery of dry powder to the wet tank heel.
- **Dry Granular Material.** The purpose for introducing the dry granular material would be to absorb and immobilize both the anticipated liquids and the nonadherent solids remaining in the tank bottom after completion of the waste retrieval effort.
- **Waste Stabilization.** This process involves delivery of the grout to the tanks by pumping the grout through a slickline to the tank.
- **Wet Grout.** A layer of free-flowing grout approximately 30 centimeters (12 inches) thick (Phase 1) would be placed into the tank (approximately 126 cubic meters [165 cubic yards] for 100-series tanks and 9.2 cubic meters [12 cubic yards] for 200-series tanks) through a single tank riser using a pipe extension to limit the drop height. The grout would mix with or encapsulate the

residual waste not fixed to the bottom of the tank. Multiple grout lifts may be used to form the waste stabilization layer. Each successive grout lift would capture a portion of the unbound residual waste at the interface between the grout and residual waste.

- **Tank Fill.** The remainder of the void space in the tank would also be filled using a series of grout lifts until the entire tank (including the riser) is full of grout.

For the purpose of this TC & WM EIS, 30 centimeters (12 inches) of grout would be provided as a minimum to establish a cost basis for scaling to other volumes. The results of regulatory analysis and risk assessments would determine the ultimate volume of grout required to ensure protection of human health and the environment (DOE 2003b).

The performance of the stabilized residual waste form used for analysis in this TC & WM EIS was based on typical grouted waste performance without sequestering agents for any specific constituents added. Thus, releases from the immobilized waste form used in the analysis would be greater than those for actual waste forms where sequestering agents would be employed.

FACILITIES

Temporary facilities would include mobile grout facilities such as a dry mix plant and a grout batch plant. Offices and bathroom, shower, and changing facilities may be set up to accommodate the employees required for operation of the grouting activity. Additionally, several material stockpiles for the various components of the grout mixture may be needed. The stockpiles may be covered with tarps to reduce airborne emissions caused by wind and other elements.

Existing grout plant infrastructure such as permanent storage silos may be used to supplement the temporary facilities described above.

ASSUMPTIONS AND UNCERTAINTIES

- The grout-filling option could be readily implemented. This option would use standard construction equipment, commercially available materials, and portable dry mix and batch plant facilities for grout production.
- The long-term effectiveness of the sequestering agent technology to immobilize contaminants is unclear. It is also uncertain whether stabilization would yield a waste form with performance equivalent to LLW.
- The physical form of the residual waste that would remain after retrieval is uncertain. To minimize the amount of liquid or loose sludge pushed to the outer edge of the tank, it was assumed that dry granular material (possibly containing sequestering agents) would be added to the tank before adding grout. It is not known whether dry powder would be required for all tank waste or only for those tanks containing free liquids.
- Possible sequestering agents and their methods of application are currently uncertain. It was assumed that sequestering agents would be applied to the tank as an additive to the dry powder and to the wet grout materials. The sequestering agents may or may not be the same materials for the powder and the grout (DOE 2003b).

E.1.2.5.1.2 Tank Removal

Details regarding the tank removal technology required to support clean closure of a tank farm or multiple tanks are described in Section E.1.2.5.3.2.

E.1.2.5.2 Ancillary Equipment

This section addresses disposition of ancillary equipment associated with tank farm operations for alternatives involving landfill closure or clean closure of the tank farms. For purposes of analysis, WRFs would be closed as part of the SST system in the same manner as ancillary equipment.

Tank Closure Alternatives 2B, 3A, 3B, 3C, 5, and 6C in this **TC & WM EIS** would employ grout-fill stabilization of ancillary equipment. Tank Closure Alternative 4 would involve grout-fill stabilization of ancillary equipment associated with landfill closure of all tank farms except BX and SX. The BX and SX tank farms would be “clean-closed” with ancillary equipment removal. Tank Closure Alternatives 6A and 6B would involve clean closure of all SST farms, including removal of ancillary equipment, Tank Closure Alternatives 6A, Option Case, and 6B, Option Case, add the removal of the contaminated soils caused by the liquid releases from the six sets of contiguous cribs and trenches (ditches). See Appendix D, Section D.1.5, for a discussion about the six sets of contiguous cribs and trenches (ditches). All Tank Closure alternatives, except Tank Closure Alternatives 1, 2A, and 5, assume ancillary equipment outside the projected closure barriers would be remediated or removed. Under Tank Closure Alternatives 1, 2A, and 5, this ancillary equipment would be left as is, with no remediation actions.

TECHNOLOGY DESCRIPTION

Tank farm ancillary equipment includes MUSTs; tank-related equipment (pump pits, risers, in-tank equipment); the waste transfer system (pipelines, diversion boxes, valve pits); and miscellaneous facilities used to store, retrieve, or treat tank waste. For long-term impacts, the greatest consequences would result from abandoning the ancillary equipment in place with no remediation. The radiological and chemical inventories for this option are described in Appendix D, Section D.1.2, and are included in the analysis of long-term impacts. The following paragraphs describe the options for ancillary equipment closure considering short-term impacts. Treatment options for each category of ancillary equipment are also described below.

- **MUSTs.** Generally, landfill closure of the MUSTs would be similar to landfill closure of the SSTs, particularly in terms of residual waste treatment and stabilization of the tank structure. Stabilization of the residual waste heel would be accomplished by adding grout. Grout would also be used for structural stabilization of the tank and as a barrier to water intrusion.
- **Diversion Boxes.** Diversion boxes provide secondary containment for leaking transfer piping jumpers and collection of fluids from transfer piping encasements. By design, the diversion boxes are not normally exposed to tank waste. However, a percentage of the diversion boxes have been contaminated by waste that has adhered to the internal concrete box surfaces.

For clean closure alternatives that require component removal, scabbling (a scabber is a metallic rotating device fitted onto a track hoe used to grind material from the surface of concrete) to a depth of 0.63 centimeters (0.25 inches) over the internal concrete surfaces would be performed.

For landfill closure, the diversion boxes would be filled with sand, gravel, or grout to prevent excessive soil subsidence. Not all of the diversion boxes would be within the projected landfill closure barrier and, as such, not all may be landfill-closed. Removal or in situ remediation of diversion boxes outside of the closure barrier was assumed.

- **Waste Transfer Piping and Encasements.** Underground waste transfer pipeline configurations include (1) direct-buried, single-wall pipelines; (2) steel pipelines in concrete encasements; and (3) double-walled pipelines providing double containment. There are many miles of pipe connecting tanks and ancillary equipment within a tank farm to processing facilities, laboratories, disposal sites (e.g., cribs, trenches, ponds), treatment facilities, and other tank farms. Not all of

the waste transfer pipes would be within the projected landfill closure barrier and, as such, some may be removed or remediated in place, and are addressed in the cumulative impacts analysis.

- **Valve Pits and Tank Pits.** Similar in function to the diversion boxes, these pits may be contaminated because of transfer piping and jumper connection leaks. Although not primary waste containments, a percentage of these pits have been contaminated with tank waste that has adhered to internal concrete surfaces.

For clean closure alternatives that require component removal, scabbling to a depth of approximately 0.63 centimeters (0.25 inches) over the internal concrete surfaces would be performed.

All but one of the valve pits and all of the tank pits would be landfill-closed (filled with grout to prevent excessive soil subsidence) within the projected landfill closure barrier. Removal or in situ remediation of the valve pit outside of the closure barrier may be required.

- **Flush Pits, Cleanout Boxes, and Leak Detection Pits.** Generally, these pits would be within the projected landfill closure barrier and are not expected to have significant levels of contamination.

For clean closure, both equipment and concrete would be removed. All contaminated debris would be disposed of in an IDF.

For the landfill closure options, the flush pits, cleanout boxes, and leak detection pits would be filled with grout to prevent excessive soil subsidence.

- **Tank Risers.** Access to the interior of the waste tanks is provided through vertical pipes that penetrate the tank roof and terminate either above grade or within an at-tank pit. Risers also provide a means for installation of in-tank equipment.

Landfill closure options would require filling the tank risers with grout to prevent excessive soil subsidence.

- **In-Tank Equipment.** In-tank equipment is installed in the tank risers and includes pumps, instrumentation trees, air-lift circulators, and retrieval equipment. Except when required for retrieval operations, in-tank equipment would not be removed and would be landfill-closed. In-tank equipment that presents a preferential pathway for infiltrating water to reach stabilized residual waste would be filled with grout for stabilization. Grout fill is considered to have the greatest impacts for landfill closure of in-tank equipment.

- **Miscellaneous Facilities.** By design, the structure of the miscellaneous facilities would not normally be exposed to the tank waste. These structures would be within the footprint of the projected closure barrier and would be landfill-closed. Under the alternatives that include landfill closure, miscellaneous facilities would have contaminated equipment removed and would be demolished to grade level. The below-grade structures would be filled with grout to prevent excessive soil subsidence.

All contaminated debris would be disposed of in permitted mixed waste disposal facilities (an IDF) at Hanford. Ancillary equipment would be characterized and disposed of as appropriate.

ASSUMPTIONS AND UNCERTAINTIES

- Sequestering agents, if required to meet performance objectives, would be incorporated into the formulation of the stabilization grout. The performance of the stabilized waste form used for

analysis in this TC & WM EIS was based on typical grouted waste performance without sequestering agents for any specific constituents added.

- The residual waste inventory in the miscellaneous tanks and other ancillary equipment following waste retrieval operations would not preclude landfill closure or disposal of removed components as mixed waste in permitted onsite disposal facilities after satisfying DOE Order 435.1 and RCRA requirements.
- In-tank equipment not required for retrieval operations would be landfill-closed in place within the tank and not removed.
- Some ancillary equipment would not be capped by the closure barrier and, as such, may not be closed under landfill closure.
- Grout-filling of pipes (if required) could be accomplished through access to existing pits; no tapping sleeves would be required. There is some uncertainty associated with the adequacy of existing access points for grouting long lengths of pipe and lines that may be plugged.
- Closure activities on ancillary equipment close to an SST would not proceed until stabilization activities for the SST were completed.
- Grout for filling of tanks and ancillary equipment would be produced at either of the two portable grout plants located in the 200-East and 200-West Areas of Hanford and trucked to the local site for placement into the ancillary equipment.
- The outer walls of the double-walled pipes and encasements, which do not provide primary containment, would not require grout-filling to prevent subsidence (DOE 2003b).

E.1.2.5.2.1 Grout Fill

Filling ancillary equipment with grout is considered to have the greatest impacts for landfill closure of ancillary equipment due to the additional expenditure of resources for this option.

TECHNOLOGY DESCRIPTION

Filling the ancillary equipment with grout may be required for stabilization of residual waste, prevention of water infiltration, and structural stabilization to preclude subsidence of the closure barrier cap.

The following ancillary equipment may need to be filled with grout depending on the alternative.

- MUSTs, double-contained receiver tanks, vaults, and tank pits
- Diversion boxes and valve, flush, and leak detection pits
- Waste transfer piping and cleanout boxes
- Tank risers and in-tank equipment
- Below-grade portions of miscellaneous facilities

For placement of large volumes of grout, an overground grout delivery line (slickline) would be temporarily installed from a grout pump located outside the tank farm RCA to ancillary equipment within an RCA. Grout would be trucked from the nearest portable grout plant and discharged into the hopper of the grout pump. The grout would then be pumped and gravity-discharged into the ancillary equipment or into a second grout pump located within the RCA for pressure-injection grouting of the system.

For placement of smaller grout volumes, a self-contained unit with a continuously circulating holding tank may be used. Grout would be trucked from the nearest plant and discharged into the holding tank of the self-contained grouting unit.

FACILITIES

Necessary temporary facilities would include (1) two portable grout plants located in the 200-East and 200-West Areas to service the closure needs for both ancillary equipment and SSTs; (2) grout delivery slicklines within the tank farm RCA for transferring grout from the pump to ancillary equipment; and (3) portable generators for operating the grout pumps.

ASSUMPTIONS AND UNCERTAINTIES

- Dose rates from the contaminated ancillary equipment are based on **Single-Shell Tank System Description** (CH2M HILL 2003c) estimates, as referenced in the **Inventory and Source Term Data Package** (DOE 2003g). Although the **AX Tank Farm Ancillary Equipment Study** (Skelly 1998) cites much higher dose rates, available field data provided in the **Single-Shell Tank System Description** suggest that the values in the **AX Tank Farm Ancillary Equipment Study** are conservatively high.
- This analysis assumes that the pipelines can be grout-filled by accessing the nozzles in the various pits. Data regarding the flow distance of grout in pipes are not available; however, grout was pumped over 305 meters (1,000 feet) through a 13-centimeter (5-inch) slickline for closure of an underground waste tank at DOE's SRS.
- Grout-filling of pipelines that were not used for transfer of waste was not included.
- Ancillary equipment lists were based on currently available data (DOE 2003b). These lists are likely to change as integration with other remediation efforts at Hanford matures.
- There is uncertainty associated with the quantities of secondary waste (e.g., lead used for shielding and abandoned equipment in pits and ancillary equipment).

E.1.2.5.2.2 Removal

Removal of ancillary equipment is considered to have the greatest impacts for clean closure and partial clean closure due to the additional expenditure of resources for removal and disposal of equipment under this option.

TECHNOLOGY DESCRIPTION

This section describes technology required for the complete removal of ancillary equipment. Ancillary equipment removal would be a necessary component under any alternative that includes near-surface soil or tank removal. Removal of the following ancillary equipment may be required for closure:

- MUSTs, double-contained receiver tanks, vaults, and tank pits
- Diversion boxes and valve, flush, and leak detection pits
- Waste transfer piping and cleanout boxes
- Tank risers and in-tank equipment
- Below-grade portions of miscellaneous facilities

The approach for ancillary equipment removal would involve segregating equipment and materials that have residual waste from materials with low levels of contamination and packaging them for proper disposal.

The ancillary equipment would be removed using shielded cab excavators with various end attachments for excavating, shearing, pulverizing, grappling, and scabbling. The components would be reduced in size and placed in appropriate packages for onsite permitted landfill disposal. All operations would be performed within actively ventilated enclosures.

Contaminated concrete would be decontaminated by removal of surface material using scabbling. Scabbling is expected to remove 95 percent of residual contamination. Size reduction of concrete structures would be performed using concrete pulverizer attachments on excavation equipment. Size reduction of metal items would be performed using shear attachments on excavation equipment.

Waste with radiation levels low enough to allow contact handling would be loaded into roll-off boxes in preparation for disposal. Waste requiring remote handling would be packaged in shielded disposal boxes. Soil would be packaged with the CH concrete debris to minimize void space within the disposal box. Packaged pipe, metal debris, and other contaminated debris would be grouted within the disposal box to minimize void space.

FACILITIES

Portable enclosures with active ventilation similar to those currently used on Hanford would be erected locally over the site of remediation.

A portable grout plant may be erected near the disposal facility for void-space filling of disposal boxes.

ASSUMPTIONS AND UNCERTAINTIES

- Dose rates from the contaminated ancillary equipment are based on **Single-Shell Tank System Description** (CH2M HILL 2003c) estimates, as referenced in the **Inventory and Source Term Data Package** (DOE 2003g). Although the **AX Tank Farm Ancillary Equipment Study** (Skelly 1998) cites much higher dose rates, available field data provided in the **Single-Shell Tank System Description** suggest that the values in the **AX Tank Farm Ancillary Equipment Study** are conservatively high.
- Ancillary equipment lists were based on currently available data (DOE 2003b; SAIC 2007a). These lists are likely to change as integration with other remediation efforts at Hanford matures.
- Five process pipelines are plugged with residual waste. There is a potential for this ancillary equipment to be classified as RH-TRU waste (DOE 2003b).
- It is uncertain whether removal of 0.63 centimeters (0.25 inches) from the internal surface of unlined pits would adequately decontaminate the pits for removal and disposal as MLLW.
- **Primary Waste:** For Tank Closure Alternatives 2B, 3A, 3B, 3C, and 6C, where 15 feet of assumed contaminated soil and ancillary equipment would be removed from SST farms BX and SX, the waste consists of contaminated ancillary equipment that would be removed and packaged for onsite disposal.
- **Secondary Waste:** Items that may become contaminated during removal of the contaminated ancillary equipment include hydraulic excavators with shielded cabs and attachments, concrete

scabbler systems, front-end loaders, filter media, decontamination fluids, personal protective equipment, rags, and wipes.

E.1.2.5.3 Tank and Soil Removal

Options for closure evaluated in this TC & WM EIS include removal of soil within the tank farms that is contaminated or suspected of being contaminated as a result of spills during routine tank farm operations or leaks from SSTs. Tank Closure Alternatives 2B, 3A, 3B, 3C, and 6C involve partial removal of soils from the BX and SX tank farms along with removal of ancillary equipment. BX and SX tank farms were chosen for this option because: (1) their tank waste inventories are well characterized and the nature and extent of past leaks and spills are documented; (2) their current in-tank inventories include substantial amounts of long-lived highly mobile constituents and short-term health risks; and (3) they are geographically located in both the 200-East and 200-West Areas.

Tank Closure Alternatives 4, 6A (Base and Option Cases), and 6B (Base and Option Cases) involve removal of the soils and ancillary equipment and removal of tanks and contaminated soils beneath the tanks for selected tank farms.

E.1.2.5.3.1 Near-Surface Soil Removal

Removal of near-surface soils was analyzed for the environmental impacts associated with the removal of localized areas of soil contamination. Based upon eventual soil characterization data, some tank farms may require less than 4.6 meters (15 feet) of soil excavation, while others may need deeper excavation; therefore, a 4.6-meter (15-foot) average was used for purposes of analysis in this TC & WM EIS. The basis for extensive removal of near-surface soil considered in this TC & WM EIS involves closing the SSTs in place with partial removal of the ancillary equipment and removal of the top 4.6 meters (15 feet) of soil.

TECHNOLOGY DESCRIPTION

The confinement concept for extensive near-surface soil removal is provided in Figure E-25.

The SSTs and DSTs are found within 18 separate tank farms on Hanford. In addition to the tanks themselves, the tank farms include ancillary equipment such as MUSTs; waste transfer system components (pipelines, diversion boxes, valve pits); at-tank equipment (pits, risers, pumps, instrumentation); and miscellaneous components used in the treatment, transfer, or storage of tank waste. The ancillary equipment, along with the soil, would all be removed to a depth of 4.6 meters (15 feet) from the surface of the tank farm.

As an option, 4.6 meters (15 feet) of clean soil could be added over the top of the tank farms without first removing the contaminated soil. However, the impacts would be less than those of the removal/replacement option evaluated.

It is assumed that the tanks and in-tank equipment would be stabilized before removal of near-surface soils. Closure of the ancillary equipment is described in detail in Section E.1.2.5.2. For analysis purposes, it was assumed all ancillary equipment is accessible and would be removed with the 4.6 meters (15 feet) of soil excavation.

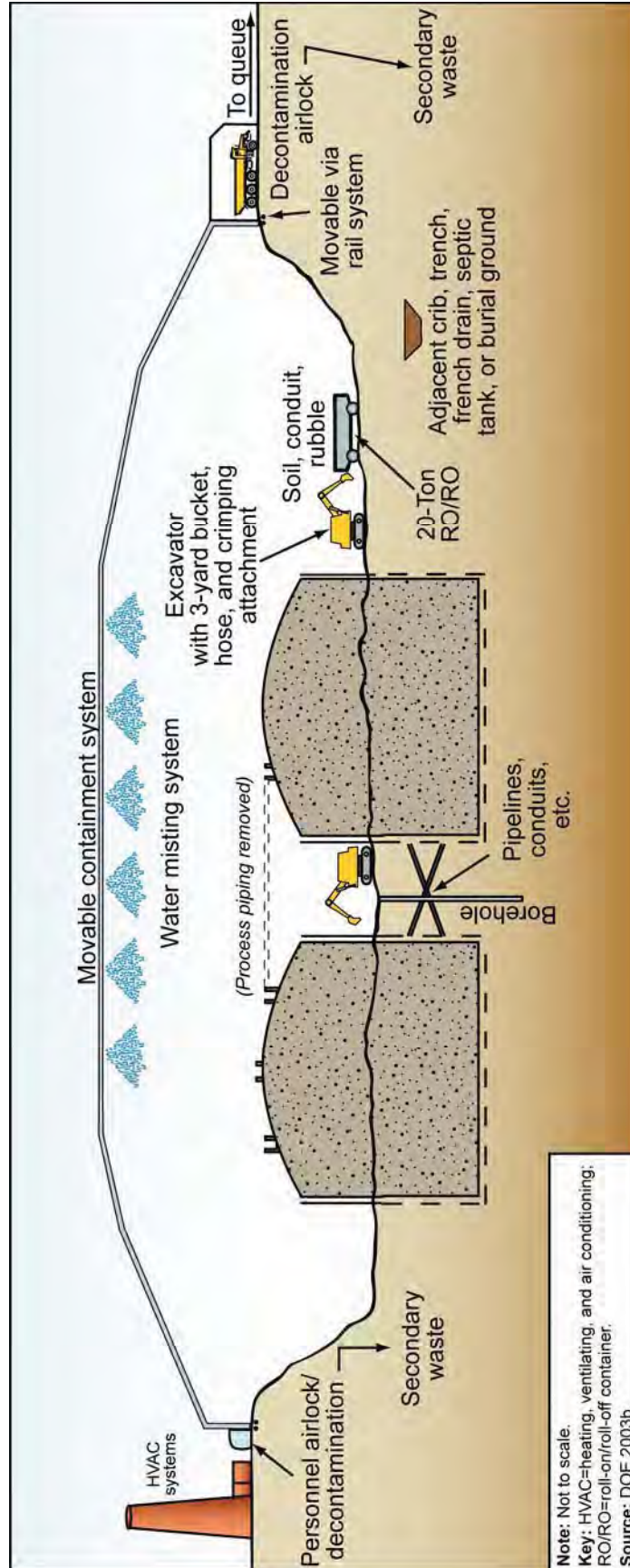

Figure E-25. Sulfate Removal Process Flow Diagram

**Draft Tank Closure and Waste Management Environmental Impact Statement for the
Hanford Site, Richland, Washington**

Hot spots are defined as near-surface sites of spills from piping or ancillary equipment with elevated levels of contamination. Tank farm closure actions could involve taking extra measures to minimize the source term remaining in the tank farm at the time of closure. The practical application of near-surface soil removal would focus on removal of hot spots. However, the characterization data are insufficient to accurately quantify the extent of contamination. Thus, the concept assumed was one that involves removal of all soil within the upper 4.6 meters (15 feet) of each tank farm.

Because of confinement requirements, the soil removal activity would be conducted within a confinement structure. Soil removal would require two large confinement structures. These structures are further described in Section E.1.2.5.3.2.

Excavated soil would be placed in large roll-off boxes for transport to the RPPDF.

Clean soil assumed to be provided from Borrow Area C would be used as backfill. The soil would be placed by heavy equipment, and soil compaction would result only from the equipment placing the soil.

FACILITIES

An overarching confinement structure, or “bubble,” would be placed over all or part of a tank farm. The structure’s ventilation system would be equipped with filters and would have at least two zones of negative pressure, each with personnel and equipment airlocks. The bubble would be used to keep fugitive dusts containing hazardous or radioactive particles from escaping to the environment. Shielded excavation and size-reduction equipment would be used under the bubble.

The site enclosure concept includes two connected structures. One is the large enclosure structure that would span the entire length and width of the excavation. The other would house support facilities for the operations. Site personnel and waste containers would enter and exit through airlock access points within the connected support facility structure.

Temporary facilities would include the set of mobile grout plants to stabilize debris and/or soil in disposal boxes. These facilities would include a dry mix plant and a grout batch plant. Additionally, development of several material stockpiles for the various components of the grout mixture would be needed. The stockpiles would be covered with tarps to reduce airborne emissions caused by wind and other elements.

Equipment staging facilities, waste container and laydown areas, material storage areas, and waste storage areas would be required. Temporary greenhouse confinement structures would be set up as well.

A container storage building would be constructed to house containers filled with either soil or material/debris. This facility would store the containers until ready for transport to the disposal facility, a staging area, and a final decontamination and package preparation area.

In addition to the structures, utilities and other site services would be provided. These include power, water, exhaust blowers, HEPA filter housings, ducting, stacks, fuel storage, etc.

Temporary office and bathroom/shower/changing facilities would be set up to accommodate employees performing closure activities.

ASSUMPTIONS AND UNCERTAINTIES

- The tanks would remain in place after waste retrieval. The waste residue heel remaining in the tanks would be stabilized, and the void space would be filled with a structural fill to prevent dome collapse.

- A large domelike structure spanning a tank farm would be erected to provide a means of confinement for the soil excavation activities around the tank farms.
- Soil and ancillary equipment would be removed to a depth of 4.6 meters (15 feet) from the surface. Decontamination, size reduction, and packaging of the soil and ancillary equipment for disposal would be performed within the confinement structure.
- Contaminated soil would be disposed of on site in the RPPDF. Excavated areas would be backfilled with clean or native soil.
- Groundwater, within the confines of the tank farm envelope, would be treated as part of the postclosure care of the tank farms.
- Soil removal would be performed under containment housing, either the large containment structure or smaller greenhouse-type structures. Safety would be a concern, as an effort of this scale has never been undertaken in the United States.
- All decontaminated concrete and waste debris that can be CH would meet onsite disposal (RPPDF) requirements without additional treatment.
- Borrow materials were assumed to be taken from Borrow Area C, near the intersection of Beloit Avenue and State Route 240.
- The quantity of material retrieved from the ancillary equipment is uncertain. Access to the piping and equipment components may be difficult because of insufficient waste retrieval. Liquid holdup may create hot spots.
- Additional disposal capability would be required to handle the anticipated waste volumes generated by closure activities. Resources required for this are accounted for in evaluating alternatives that involve soil removal.
- The enclosure structure identified for the 241-AX Tank Farm Closure Demonstration was a free-span structure that would cover an area 150 meters (500 feet) wide by 170 meters (550 feet) long. Most SST farms include three or four rows of tanks, and this enclosure concept may not be adaptable to these larger areas.
- Applying the 241-AX tank farm study data sets to all other tank farms is technically uncertain.
- Technologies used to excavate and treat soils would not be used until after the tank dome fill is completed to prevent dome collapse and to comply with existing safety load restrictions within tank farms (DOE 2003b).

E.1.2.5.3.2 Tank, Ancillary Equipment Removal, and Deep Soil Removal

Selective or full clean closure of the SST farms is analyzed under the following three Tank Closure alternatives.

- **Tank Closure Alternative 4:** The 27 SSTs in the BX and SX tank farms and the 3 meters (10 feet) of soil directly beneath these tanks would be removed. The highly contaminated rubble, soil, and equipment (RSE) from this removal action, which are expected to include tank steel, concrete, ancillary equipment, and contaminated soils, would be transported to the Preprocessing Facility (PPF) in shielded boxes and subjected to a strong acid wash. The resultant liquid waste stream would be neutralized and piped to the DSTs for treatment as HLW in the WTP, and the

decontaminated (washed) RSE would be packaged and disposed of on site in the RPPDF. Similarly, the contaminated soils from deep soil excavation (tank leak plumes) would be removed, transported to the PPF in shielded boxes, and subjected to a weak acid wash. The resultant liquid waste stream would be neutralized and piped to the DSTs for treatment in the WTP as LAW, and the decontaminated (washed) rubble and soil would be packaged and disposed of on site in the RPPDF.

- **Tank Closure Alternatives 6A and 6B:** All 144 SSTs in the 12 SST farms and the 3 meters (10 feet) of soil directly beneath these tanks would be removed. The highly contaminated and moderately contaminated RSE from this removal action, which are expected to include tank steel, concrete, ancillary equipment, and contaminated soils, would be compacted to the extent practical and boxed in shielded storage boxes for disposal as HLW. To accommodate the long-term storage of these estimated 147,000 boxes, 35 covered concrete storage pads would be constructed near the PPF. Similar to Tank Closure Alternative 4, the contaminated soils from deep soil excavation (plumes) would be removed, transported to the PPF in shielded boxes, and subjected to a weak acid wash. However, unlike Tank Closure Alternative 4, this resultant liquid waste stream would be further treated in the PPF and immobilized by treatment in a glass melter system to produce an immobilized waste form that would be equivalent to ILAW glass in its long-term performance. This PPF glass would be disposed of in an IDF. The decontaminated (washed) rubble and soil from these PPF decontaminated operations would be packaged and disposed of on site in the RPPDF.

The above description applies to both the Base Cases and the Option Cases for Tank Closure Alternatives 6A and 6B. For the Option Cases, the deep soil wash activities in the PPF would include contaminated soils and rubble from the six sets of cribs and trenches (ditches) near the B/BX/BY and T/TX/TY waste management areas. See Appendix D, Section D.1.5, for a more complete description of these cribs and trenches (ditches); see Section D.1.7 for additional discussion and simplified mass balance flowsheets for Tank Closure Alternatives 6A and 6B.

- Routine work away from the dig face could be performed under the enclosure without respiratory protection. Numbers of workers involved and total exposure to radiation and industrial hazards would increase if supplied air were required.
- All contaminated material and soil would be disposed of either in an IDF or the RPPDF or would be placed in onsite interim storage and managed as HLW, as described above.

TECHNOLOGY DESCRIPTION

The scope of the tank, ancillary equipment, and deep soil removal alternative and associated technology would involve the complete removal of the tanks and ancillary equipment, the excavation of all soil in the tank farms down to the soil/groundwater interface, and disposal of the debris and soil. The excavation of all soil in the tank farms down to the soil/groundwater interface represents the most extreme implementation of this alternative. DST farms and some SST farms may have considerable uncontaminated soils. Some would be directly disposed of as is, while others may require additional treatment to meet RCRA/dangerous waste disposal requirements (WAC 173-303). The resulting excavation would then be backfilled with clean soil from Borrow Area C.

The overall concept is depicted in Figures E-26 and E-27. A containment structure would be built over a group of tanks. Then the ancillary equipment, tanks, and contaminated soil down to the groundwater (70 to 76 meters [200 to 250 feet] below the ground surface in most tank farms) would be completely removed. The technology would require an overarching containment structure (or “bubble”) to be placed

over all or part of a tank farm prior to tank or soil removal. The structure would be filtered and have at least two zones of negative pressure, each with personnel and equipment airlocks.

The bubble would be used to keep fugitive dusts containing hazardous or radioactive particles from escaping to the environment. Shielded cab excavation and size-reduction equipment would be used under the bubble.

Use of a containment structure represents a reasonable and responsible case and the greatest impacts with respect to resource use. The Hanford environmental restoration contractor has been routinely cleaning up Columbia River corridor sites without the use of containment structures. A containment structure, such as that described herein, may be required for soils containing large inventories of contaminants (e.g., in tank farms where SSTs have leaked).

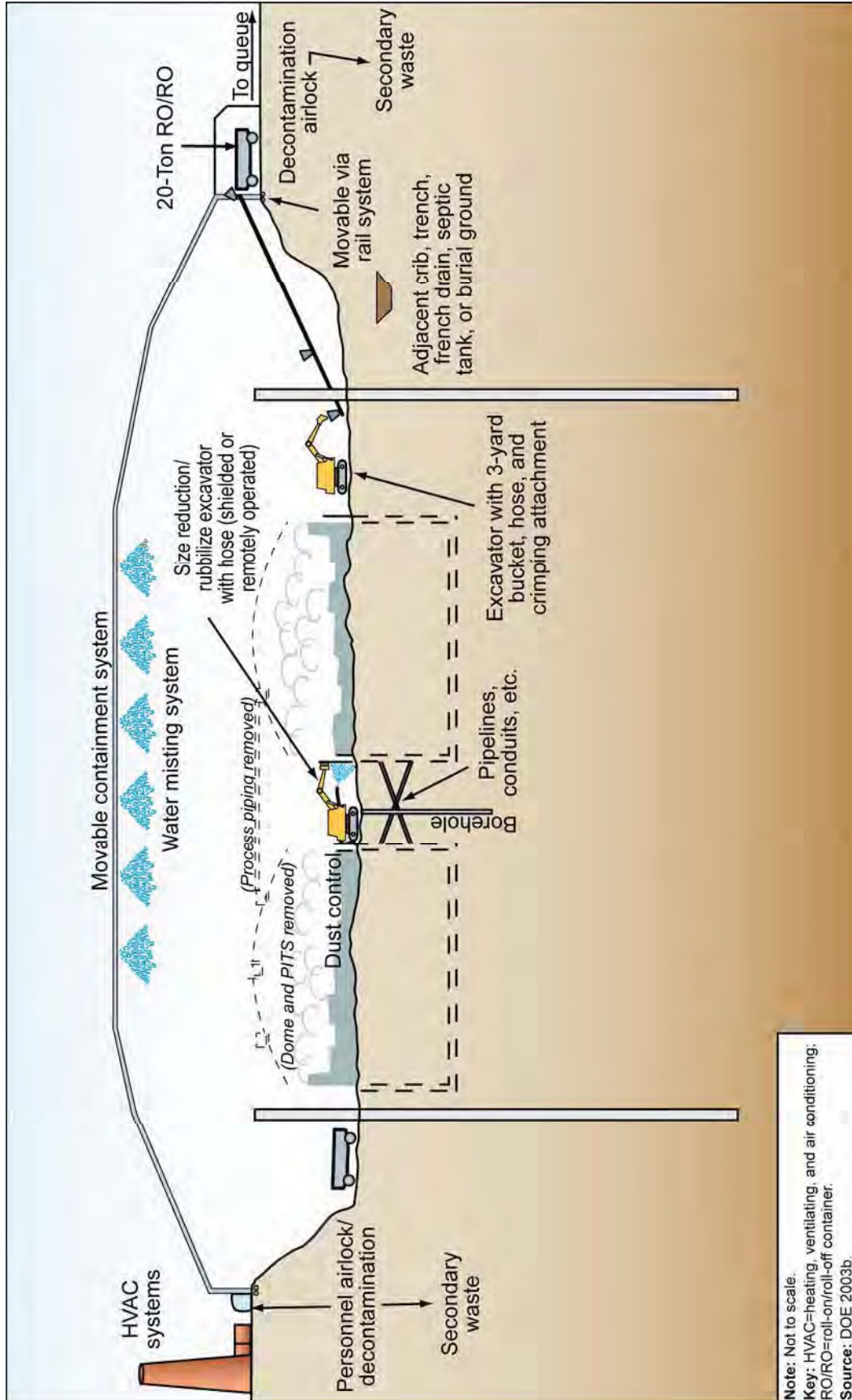

Figure E-26. Conceptual Drawing of Clean Closure Showing Domes and Pits Partially Removed

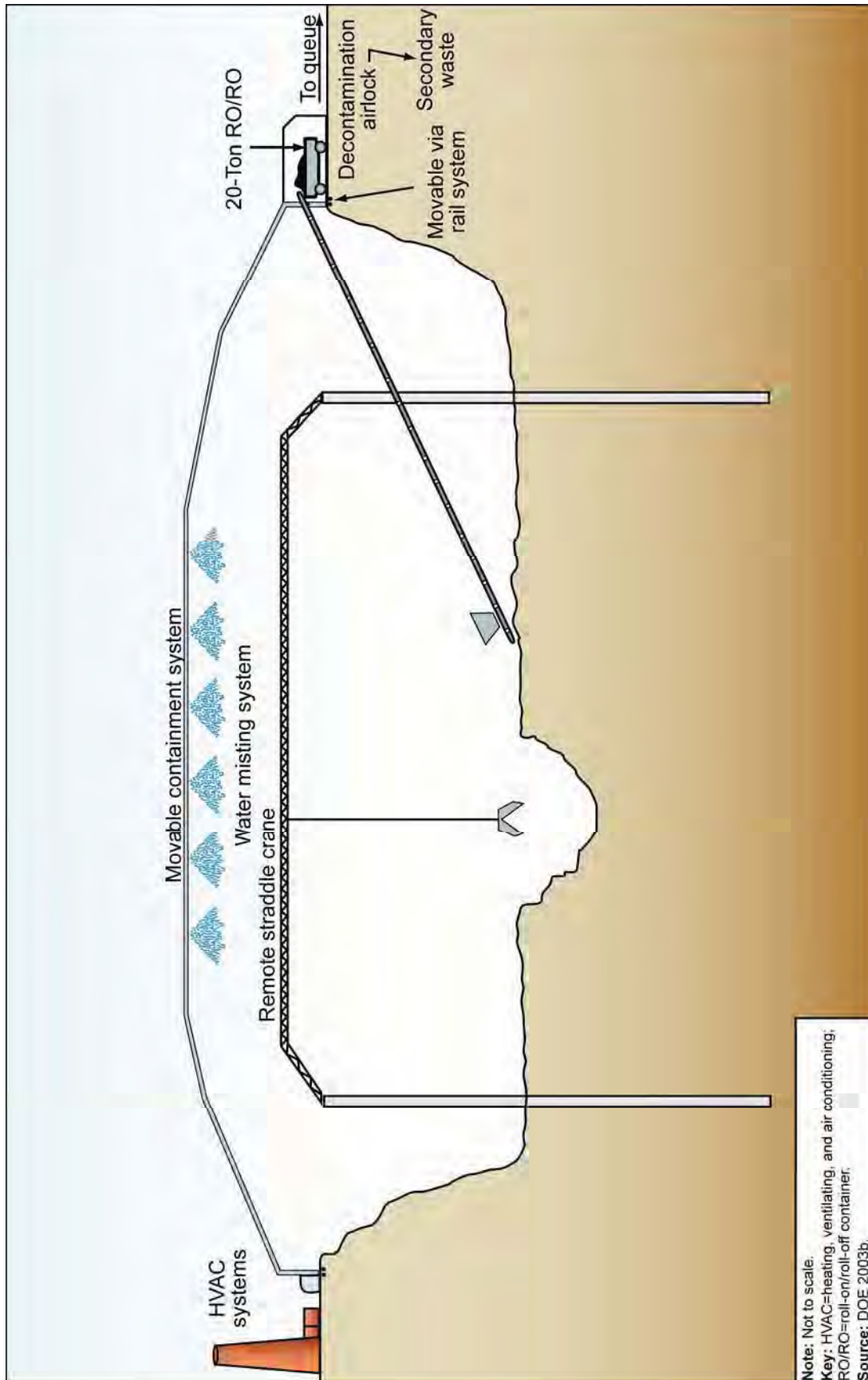

Figure E-27. Conceptual Drawing of Clean Closure After Removal of Tanks

Ancillary Equipment Removal. All ancillary equipment components would be removed, reduced in size, packaged, and prepared for disposal. Whenever necessary, this work would be performed remotely. Concepts developed for demolishing and removing the ancillary equipment include using shielded heavy equipment and hydraulic excavators with specialized implements designed for demolition and material handling. To reduce the volume of heavily contaminated debris, a vacuum scabbler would be used to remove highly contaminated thin layers of concrete. A truck-mounted vacuum system, similar to the system already in use in the tank farms, would be used for shallow excavations in areas that are otherwise limited to hand excavation.

Ancillary equipment removal concepts and information are taken from the **AX Tank Farm Ancillary Equipment Study** (Skelly 1998). The number of different types and the large number of pieces of ancillary equipment combine to make removal a substantial effort.

Tank Removal. Removal of the tanks under Tank Closure Alternative 4 (BX and SX tank farms only), Tank Closure Alternative 6A (Base and Option Cases), and Tank Closure Alternative 6B (Base and Option Cases) would involve the following activities.

- All contaminated tanks, ancillary equipment, and contaminated soils would be removed.
- Several large, movable enclosures spanning the width of each tank farm would be required for containment of radioactive and hazardous materials.
- The vadose zone and groundwater would be characterized to assess the nature and extent of contamination from losses during tank waste retrieval and to gather geotechnical data.
- Retaining walls would be installed. The outer wall would be located around the perimeter of the tank farm and would support excavation down to the tank base elevation. The outer wall would be installed before construction of the tank farm enclosure. The remaining walls would be installed following tank removal and would extend down from the tank base elevation to support excavation of tank leak plumes. A 30-centimeter-thick (1-foot-thick) layer of high-flow, low-strength grout would be placed into each of the tanks to reduce worker exposures from residual waste in the tanks.
- Soil cover would be removed from grade level down to the top of the tank domes. The lightly contaminated excavated soil would be placed into containers for transport to and disposal in the onsite RPPDF.
- The tank domes would be demolished, placing the rubble inside the tank for additional radiation shielding.
- The lateral soil surrounding tanks would be excavated, debris would be placed in containers, and lightly contaminated soil would be transported to the onsite RPPDF.
- Tank sidewalls would be demolished and rubble would be placed in containers. Under Tank Closure Alternative 4, this waste would be transported for decontamination to the PPF. Under Tank Closure Alternatives 6A (Base and Option Cases) and 6B (Base and Option Cases), this waste would be packaged in shielded containers for disposition as HLW.
- The tank slab and footing would be demolished; the debris and the 3 meters (10 feet) of soil under the tank slab would be placed in shielded boxes. Under Tank Closure Alternative 4, the highly contaminated portion of this waste would be decontaminated in the PPF. Under Tank Closure

Alternatives 6A (Base and Option Cases) and 6B (Base and Option Cases), this waste would be packaged in shielded containers for disposition as HLW.

- Demolishing the base slabs would involve the most adverse working and material handling conditions encountered during tank removal. The base slab demolition would use 5-centimeter-thick (2-inch-thick) sheets of steel laid down on the soil as the base slab is removed to provide shielding and reduce worker radiation exposure rates to manageable levels (DOE 2003b).

Deep Soil Removal. After removing the tanks, contaminated soil from past tank leaks would be excavated. To accommodate larger excavation volumes, a conveyor system would be constructed to move the soil from the excavation area to the container loading area. A straddle crane and rail system would be installed within the confinement facility to support soil excavation. The crane with a clamshell attached would be fully operable from a remote location and would use cameras to view the excavation area. The straddle crane would be mounted on three parallel sets of east-west rails supported by steel girders. To increase the production by the crane, a belt conveyor system would be constructed to move the contaminated soil from the floor of the excavation to the container loading zone.

Lightly contaminated soil meeting waste acceptance criteria would be placed into roll-on/roll-off containers and transported to the onsite RPPDF for disposal. Soil with higher concentrations of radionuclides is expected immediately beyond the 3-meter (10-foot) layer of soil below the tank bases. These soils and other highly contaminated soils would be placed in shielded boxes and transported to the PPF for decontamination under Tank Closure Alternatives 4; 6A, Base and Option Cases; and 6B Base and Option Cases (DOE 2003b).

Under the Tank Closure Alternatives 6A and 6B Option Cases, an additional volume of contaminated soil would be either decontaminated at the PPF (highly contaminated) or disposed of at the RPPDF (lightly contaminated). The sources of this volume and radionuclide/chemical inventory are the six sets of contiguous cribs and trenches (ditches) in the B and T Areas. The balance of cribs and trenches (ditches) at Hanford are evaluated within the Chapter 6, Cumulative Impacts. Specifically analyzed are the following 33 cribs and trenches (ditches): two cribs in the B tank farm, eight trenches in the BX tank farm, seven cribs in the BY tank farm, two cribs in the T tank farm, six trenches (ditches) in the T tank farm, five trenches (ditches) in the TX tank farm, and three cribs in the TY tank farm. (Note: T and TX trenches are considered one set.) The total estimated volume of soil added by these six sets of cribs and trenches (ditches) is approximately 6.50×10^6 cubic meters (8.50×10^6 cubic yards). See Appendix D, Section D.1.5, for additional discussion on the cribs and trenches (ditches).

Preprocessing/Packaging Contaminated Soil and Debris. Under Tank Closure Alternative 4, more than 310,000 cubic meters (405,000 cubic yards) of soil and debris recovered from the ancillary equipment, tank, and deep soil removal efforts are expected to be heavily contaminated with tank waste. Because this material would likely exceed waste acceptance criteria for onsite disposal, the material would be treated at a standalone, 4-hectare (10-acre) PPF (DOE 2003h). In the PPF, the highly contaminated tank debris, equipment, soil, and rubble from tank removal would be treated using a strong acid wash. The washed soils and debris would be packaged and disposed of on site in the RPPDF. The contaminated liquid waste stream from the acid wash would be neutralized and sent to the DSTs for treatment in the WTP. The contaminated soils from deep soil excavation would be treated in the PPF using a weak acid soil wash. The washed soils would be disposed of on site in the RPPDF, and the contaminated liquid waste stream from the soil acid wash would be sent to the DSTs for treatment in the WTP.

Under Tank Closure Alternatives 6A (Base and Option Cases) and 6B (Base and Option Cases), more than 670,000 cubic meters (880,000 cubic yards) of tank debris, equipment, soil, and rubble from tank

removal are expected to be heavily contaminated with tank waste. However, these materials would be considered HLW and would be packaged in approximately 147,000 shielded storage boxes for disposal as HLW. To accommodate the shielded storage boxes, 35 covered concrete pads would be constructed near the PPF (SAIC 2007a). It was assumed that the boxed HLW would require long-term onsite storage until disposition decisions are made and implemented. It was also assumed that the radiological and nonradiological inventories in this waste would be contained during onsite storage. Therefore, this waste would not represent a contaminant source to the groundwater. Highly contaminated soil removed from deep soil excavation would be treated in the PPF using a weak acid wash. The washed soils would be disposed of on site in the RPPDF, and the contaminated liquid waste stream from the soil acid wash would be further treated in the PPF using a glass melter. The PPF melter would produce an immobilized waste form that would be equivalent to ILAW glass in waste form performance. Under Tank Closure Alternatives 6A, Base Case, and 6B, Base Case, the volume of PPF glass produced would fill approximately 670 canisters, and under Tank Closure Alternatives 6A, Option Case, and 6B, Option Case, the volume of PPF glass would fill approximately 18,300 canisters. This PPF glass would be disposed of on site in an IDF.

FACILITIES

The facilities involved in the removal of tanks, ancillary equipment, and deep soil would include construction of the containment structures, retaining walls for excavation, and the PPF. Adequate space must also be available for disposal or interim storage of excavated soil and debris.

Construction activities would involve setting up field offices and utilities, obtaining characterization data, preparing the site, and erecting the containment structure and support facility, and construction of the PPF.

Under Tank Closure Alternatives 6A Base Case, and 6B Base Case, six containment enclosures would be required. The enclosures would be around the following sets of tanks:

- T, TY, and TX tank farms
- U tank farm
- S and SX tank farms
- B, BY, and BX tank farms
- C tank farm
- A and AX tank farms

Under Tank Closure Alternatives 6A, Option Case, and 6B, Option Case, four additional containment enclosures would be required because many of the cribs and trenches (ditches) are located in the B and T Areas (DOE 2003b).

Under all three Tank Closure alternatives involving “clean closure” (Tank Closure Alternatives 4, 6A, and 6B), the PPF would be a soil-washing facility. However, the original PPF was designed to clean equipment, not soils, and thus required a strong acid (57 percent nitric acid) solution to etch the material being treated. Because no etching would be required of the PPF for soil-washing purposes, a weaker acid (3 percent) would be adequate to treat contaminated soils. This weaker acid concentration would be comparable to those used in hydrometallurgy industries to remove the majority of removable contaminants. For Tank Closure Alternative 4, an additional equipment treatment system would be included because this Tank Closure alternative would treat the highly contaminated RSE generated from the removal of the SST and ancillary equipment. This additional treatment system would use a strong acid wash to remove 85 percent of the residual contamination to permit packaging and disposal of the decontaminated debris and soils in the RPPDF. Under Tank Closure Alternatives 6A and 6B, this highly contaminated waste stream would be packaged in HLW shielded containers for interim onsite storage.

The size of the PPF varies among the Tank Closure alternatives to optimize the facility's throughput. Under Tank Closure Alternative 4, which excludes a PPF melter but would include both a strong and weak acid wash system, the estimated footprint of the facility would be approximately 13,000 square meters (140,000 square feet). This facility size would support a continuous feed to the HLW and LAW melter operations at the WTP. Under Tank Closure Alternatives 6A, Base Case and 6B, Base Case, the same facility footprint of 13,000 square meters (140,000 square feet) would be adequate to support the weak acid wash operations with one PPF melter. Estimated annual throughput would be 2.5 metric tons of glass per day. Under Tank Closure Alternatives 6A, Option Case, and 6B, Option Case, the facility footprint would be approximately double, or 26,000 square meters (280,000 square feet), which would support six melters operating simultaneously for an estimated throughput of 15 metric tons of glass per day (CEES 2007c, 2007d).

ASSUMPTIONS AND UNCERTAINTIES

- Because an effort of this scale in a radioactive environment has not been undertaken in the United States, it is unclear whether the operation could be conducted with adequate considerations for worker safety. Although the technology related to the installation of movable containment structures is clearly understood, some uncertainty exists regarding the feasibility of installing these structures over the tank farms.
- For the purposes of this analysis, it was assumed that 99.9 percent of the waste would be removed from the tanks, before tank removal operations begin, but leakage of 15,000 liters (4,000 gallons) per SST would occur during retrieval of waste from the SSTs.
- Tank removal would include removal of all contaminated soils in a tank farm, including excavation of plumes to groundwater, if necessary.
- The equipment used for soil excavation and tank removal would require additional radiation shielding to protect the equipment operators.
- Tank base materials are expected to have high radionuclide concentrations, so a new design for RH equipment would be required.
- An uncertainty associated with the PPF would be related to remote operation of the debris and soil-cleaning process.
- The PPF process is an immature design with very little data available and would probably change as more-detailed design efforts are undertaken (DOE 2003b).

E.1.2.5.4 Tank Farm Closure System

The tank farm closure system combines surface barrier technology with postclosure care. Installation of surface barriers and monitoring systems was included in the analysis of impacts under Tank Closure Alternatives 2B, 3A, 3B, 3C, 4, 5, and 6C in this TC & WM EIS, all of which involve closure of the tank farms as landfills.

E.1.2.5.4.1 Surface Barriers

The reference surface barrier discussed here is the modified RCRA Subtitle C barrier. Resource requirements for the modified RCRA Subtitle C barrier are essentially 40 percent less than those required for the Hanford barrier. This is due primarily to the difference in barrier installation depth. The modified RCRA Subtitle C barrier is an eight-layer barrier with a combined thickness of 2.7 meters (9.0 feet) versus 4.6 meters (15 feet) for the Hanford barrier and the absence of a basalt riprap layer.

Substantial research and testing has been conducted on the Hanford barrier as part of a CERCLA treatability study. For analysis purposes, it was assumed that the Hanford barrier is designed for 1,000 years of performance without maintenance to control water infiltration; plant, animal, and human intrusion; and wind and water erosion. Performance results of both barrier prototypes would be evaluated further to confirm their suitability for closure of the tank farms as landfills. Cross sections of both types of barriers are shown in Figures E-28 and E-29. Both barrier designs are described in greater detail in the **Focused Feasibility Study of Engineered Barriers for Waste Management Units in the 200 Areas** (DOE 1996).

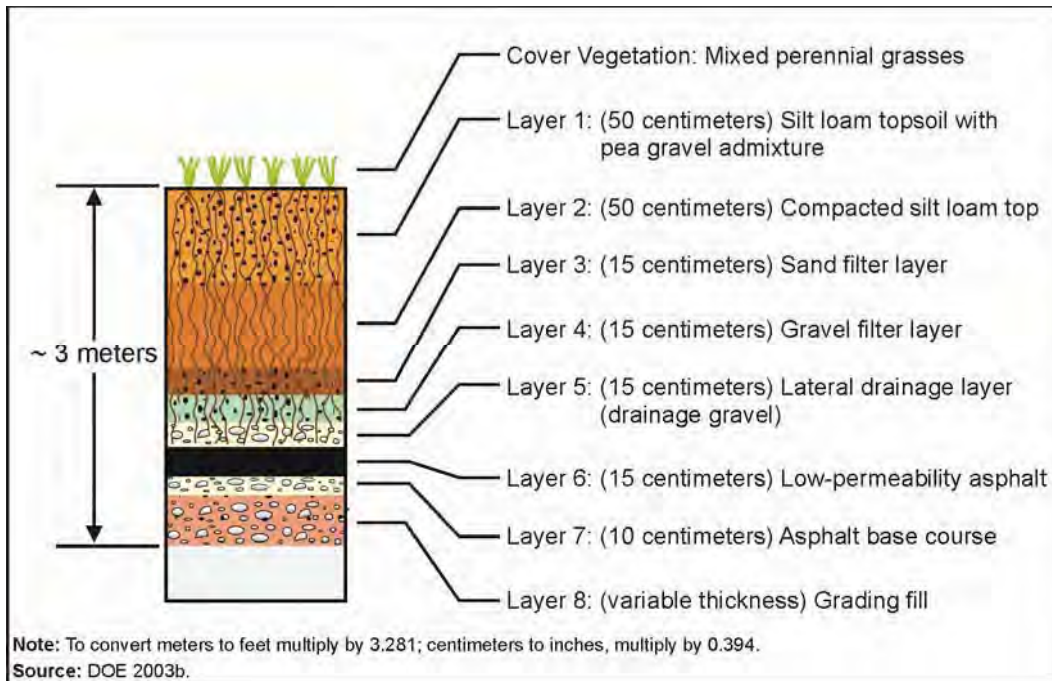

Figure E-28. Modified Resource Conservation and Recovery Act Subtitle C Barrier

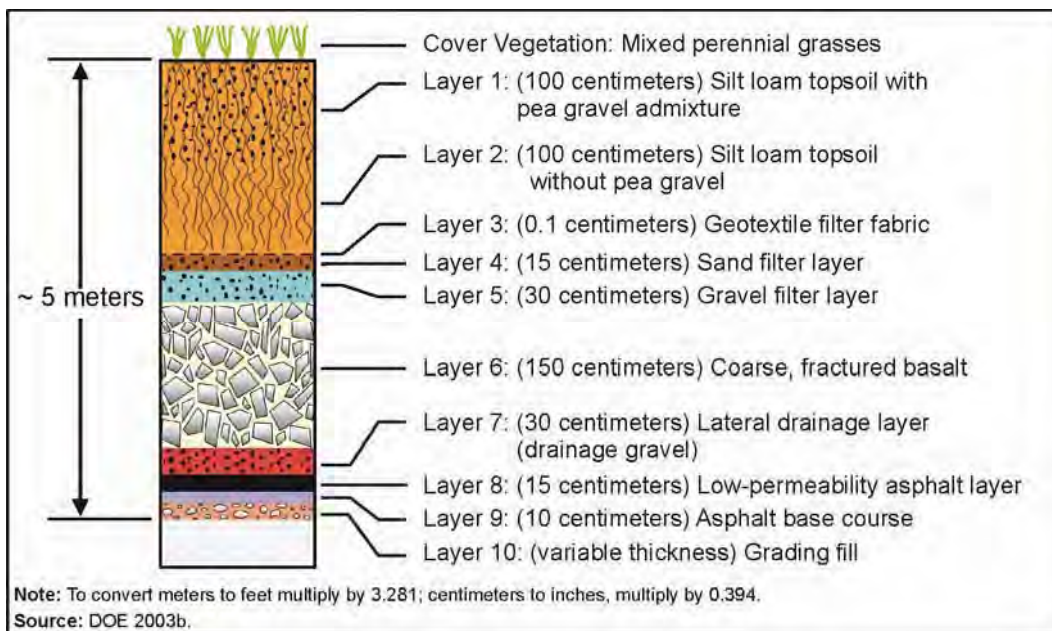

Figure E-29. Hanford Barrier Profile Technology Description

All alternatives that use landfill closure as part of their proposed activities, with the exception of Tank Closure Alternative 5, analyze the construction of a modified RCRA Subtitle C barrier. Tank Closure Alternative 5 analyzes the construction and operation of the Hanford barrier design.

TECHNOLOGY DESCRIPTION

The modified RCRA Subtitle C barrier would cover each tank farm and the ancillary equipment within each tank farm. The modified RCRA Subtitle C barrier is designed to provide long-term containment and hydrologic protection for a performance period of 500 years. The design incorporates an asphalt layer to inhibit bio-intrusion (plants and burrowing animals) and human intrusion control.

The Hanford barrier is a 10-layer design with a combined thickness of 4.6 meters (15 feet). This barrier is designed to remain functional for a performance period of 1,000 years and to provide the maximum available degree of containment and hydrologic protection. This barrier includes a layer of coarse, fractured basalt intended to provide the primary biointrusion control function and to limit inadvertent human intrusion. Criteria common to both barrier designs include the following:

- Minimize moisture infiltration through the cover.
- Design a multilayer cover of materials resistant to natural degradation processes.
- Design a durable cover requiring minimal maintenance during its functional design life.
- Prevent plants from accessing and mobilizing contaminants (i.e., prevent root penetration into the waste zone).
- Prevent burrowing animals from accessing and mobilizing contamination.
- Facilitate drainage and minimize surface erosion by wind and water.
- Design the low-permeability layer of the cover to have a permeability less than or equal to any natural subsoils present.
- Design the cover to prevent the migration and accumulation of topsoil material within the lateral drainage layer.

A conceptual representation of the five surface barrier “lobes” required for closure of Hanford tanks is presented in Figures E-30 and E-31. Three barrier lobes are anticipated in the 200-West Area and two lobes are anticipated in the 200-East Area, including a large lobe over the C farm and the A farm complex. All contaminated areas under these five lobes are considered in this analysis. The perimeter of each lobe is also considered to be the maximum distance within which soils would be removed under alternatives that call for either near-surface or deep soil removal.

All SSTs, ancillary equipment, facilities, and those existing DSTs within the barrier lobe area would be removed or isolated and stabilized prior to barrier construction. WTP closure is not part of the proposed actions because it is an active component needed to complete waste treatment. The existing 28 DSTs, also active components, are included in the closure scenario for each alternative presented in this TC & WM EIS that includes landfill closure. When the closure barrier is placed over the SSTs, it would also need to cover proximal DSTs due to the engineering design and the close proximity to the SSTs. Therefore, the decision was made to include existing DSTs in the closure configuration. In contrast, new or replacement DSTs proposed to be constructed as part of the infrastructure needed to support certain alternatives would not be closed, as these new DSTs would be physically separate from the original 177 tanks (149 SSTs and 28 DSTs) built at Hanford and outside the real extent of the SST closure barriers. Although a closure configuration for the DSTs is evaluated in this EIS, this EIS is not intended to support a decision on the closure of the new or replacement DSTs. Closure decisions related to both the new or replacement DSTs and the WTP would have to be addressed at a later date after appropriate NEPA analysis. See Figure E-11 for the locations of proposed facilities.

Draft Tank Closure and Waste Management Environmental Impact Statement for the Hanford Site, Richland, Washington

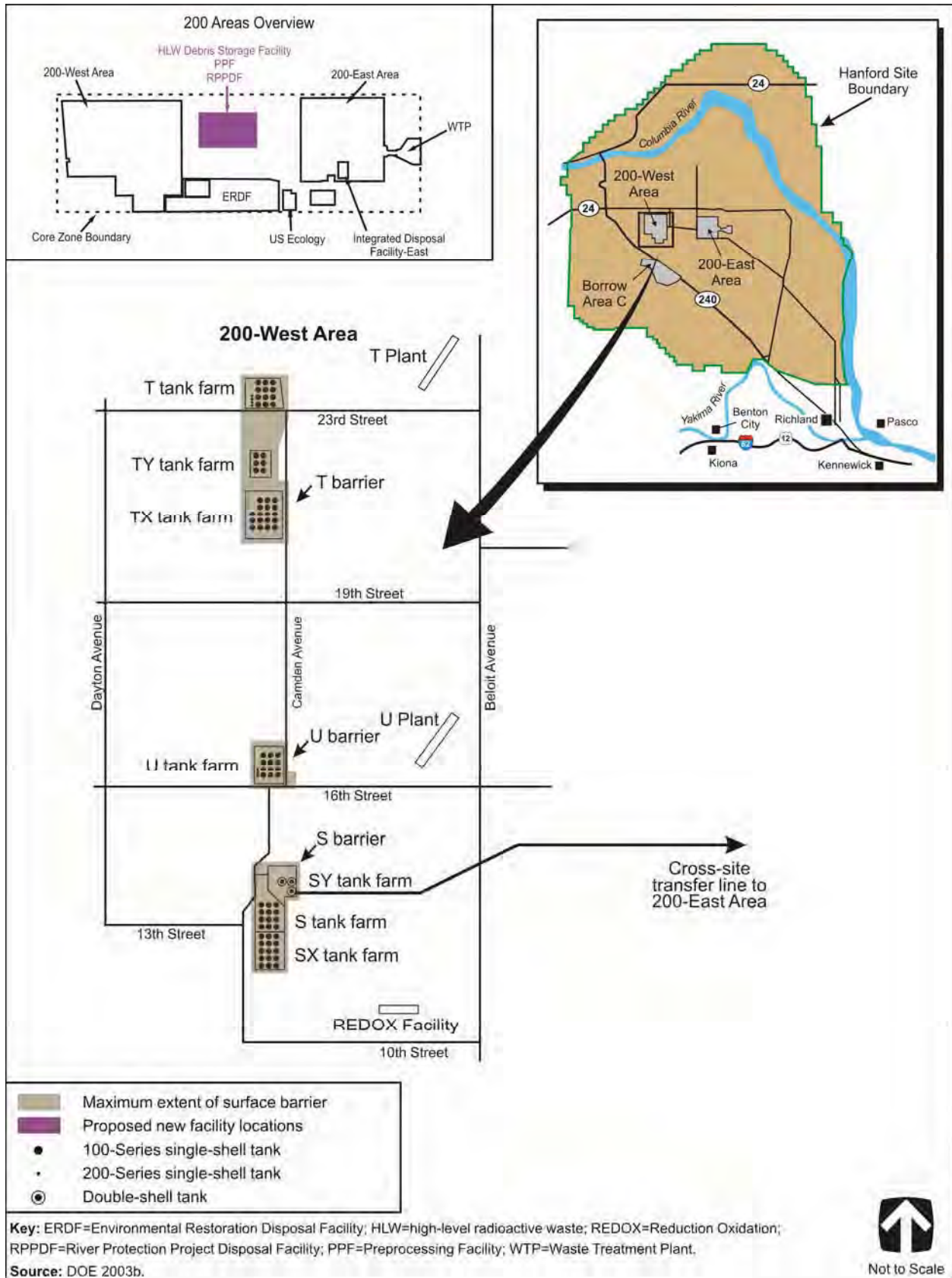

Figure E-30. Conceptualized Closure Surface Barriers in the 200-West Area

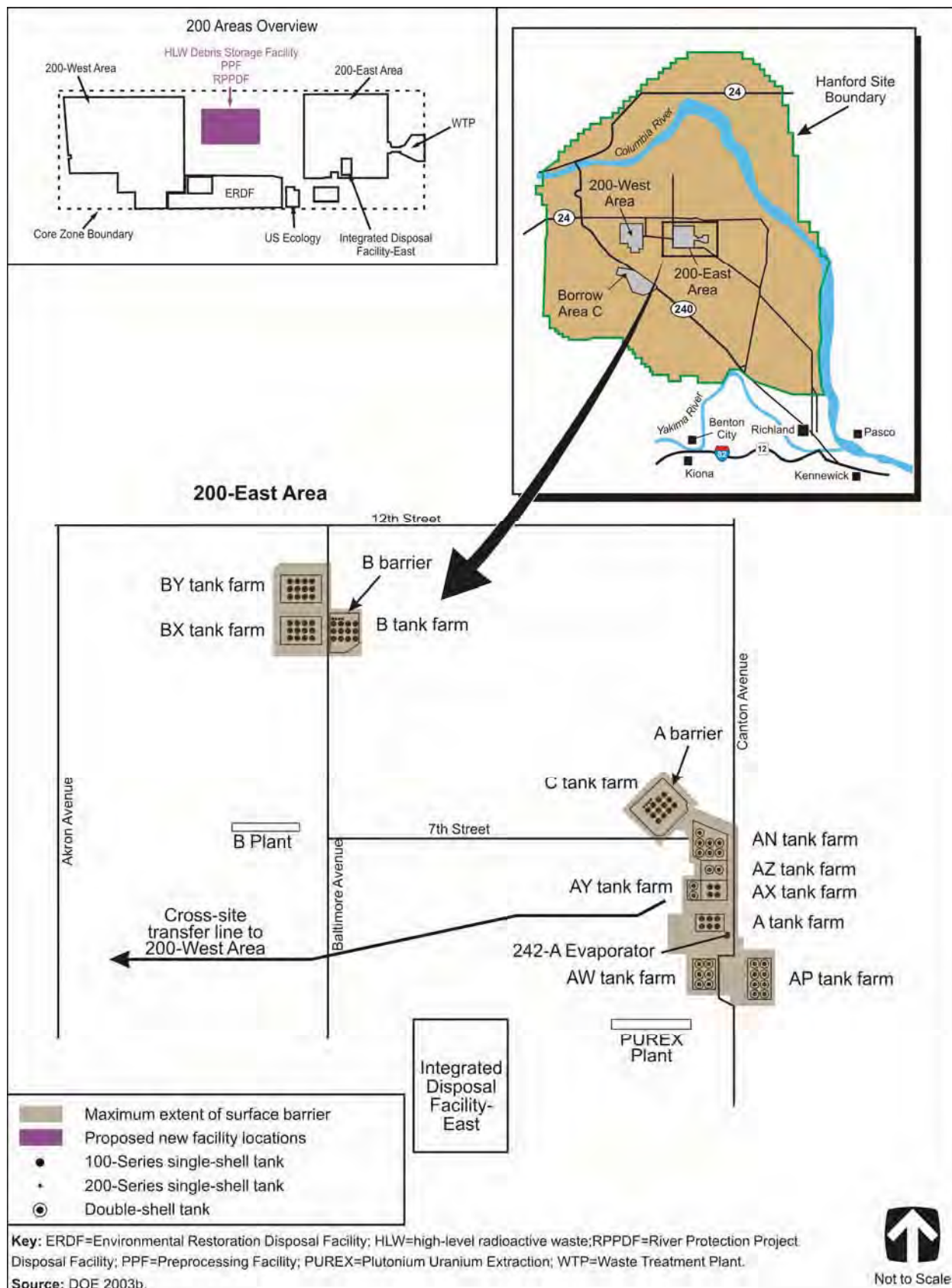

Figure E-31. Conceptualized Closure Surface Barriers in the 200-East Area

**Draft Tank Closure and Waste Management Environmental Impact Statement for the
Hanford Site, Richland, Washington**

Under the Tank Closure alternatives where the tanks are left in place, the tanks would be filled with grout to stabilize the tank domes for subsequent barrier emplacement. Standard earthmoving equipment (e.g., graders, scrapers, bulldozers, compactors) would be used to install the barriers; the barriers themselves involve massive amounts of soil and gravel. Any tanks and equipment left in place would need to be stabilized to prevent collapse during or after barrier emplacement.

Surface barriers would be installed using a three-step process: (1) excavation of material from Borrow Area C, (2) transportation of materials to the tank farms, and (3) emplacement of the barrier over the tank farms. All resource material except the asphalt would be hauled from Borrow Area C, a 930-hectare (2,300-acre) area near the intersection of Beloit Avenue and State Route 240, just south of the 200-West Area. Conventional excavation and transportation equipment would be used to remove and haul the material to the tank farms.

Topography of the tank farms would be considered in the design of the individual barrier lobes. The initial barrier layer would be clean soil fill material of varying thickness to establish grade. This would be followed by two courses of asphalt, which would serve as the primary permeability barrier to prevent water intrusion. Above the asphalt layers would be three layers of sand and gravel to serve as a capillary break and as a drainage layer for water that percolates from the upper soil and vegetation layers. Little if any drainage is expected, as the upper soil and vegetation layers, each a minimum of 0.5 meters (20 inches) thick, are designed to promote evapo-transpiration of moisture from precipitation.

The soil and gravel layers would be placed using standard construction equipment such as scrapers, bulldozers, graders, and compactors. Minimal quantities of water may be needed to minimize windblown particulates. Asphalt layers would be constructed using typical road-paving techniques. Vegetation would be planted in the top layer by drilling and crimping or possibly hydroseeding. Typical farm or landscaping equipment would be used. There are several different options for seeding and/or reseeding surface barriers. These options vary based on the type of vegetation planted and the contractor that does the planting. Previous drill planting and crimping using tractor implements have been successful (DOE 2003b).

FACILITIES

Borrow Area C, discussed in Section E.1.2.5.5, provides the facilities and borrows material for closure of solid waste burial grounds. Surface barriers for the tank farms covering approximately 60 hectares (150 acres) would be similar to those installed over more than 120 hectares (300 acres) of burial grounds. Resource material for burial ground and tank farm surface barriers would come from the same Borrow Area C.

In the process of placing a barrier over tank farms and periphery, several liquid waste disposal sites currently not assigned to the RPP would be covered.

ASSUMPTIONS AND UNCERTAINTIES

The placement of a surface barrier would be relatively straightforward. The construction of the Hanford barrier over the 216-B-57 crib in the 200-East Area successfully demonstrated that surface barriers could be built using existing construction equipment and practices.

For purposes of analysis, the surface barriers were assumed to be effective for minimizing the infiltration of precipitation through the tank farms covered by those barriers.

It was further assumed that, because the existing DST farms are located adjacent to SST farms, any practical installation of surface barriers over the SST farms would also cover the adjacent DST farms. The new or replacement DSTs required by some alternatives would not be covered under barriers.

E.1.2.5.4.2 Postclosure Care

Under alternatives where there would not be total removal of all tanks, ancillary equipment, and contaminants in the vadose zone, postclosure care of residual waste would be required for 100 years after the tank farms are closed and the surface barriers installed. Confirmation that the barriers are performing as designed is especially important (i.e., vegetation planted in the cover is evapotranspiring rainwater and snowmelt such that very little moisture can move through the vadose and mobilize contaminants). Therefore, a major portion of this section addresses vadose zone monitoring. Risk-based clean closure where contaminants would be removed or cleaned up to a risk level may not require postclosure care.

TECHNOLOGY DESCRIPTION

Previous documents published by Hanford and supporting organizations have examined tank closure and associated alternatives, but have not included postclosure care in detail. Until now, long-term monitoring plans for the time beyond tank farm closure had been delayed until RCRA closure plans were written. Although these monitoring activities would not be performed for many years, it is important that general information on the various technologies and alternatives for monitoring be identified here. The three primary areas identified for long-term postclosure care would be air, groundwater, and the vadose zone. Figures E-32 and E-33 illustrate both a cross section and a plan view of a barrier with appropriate air, groundwater, and vadose zone monitoring equipment.

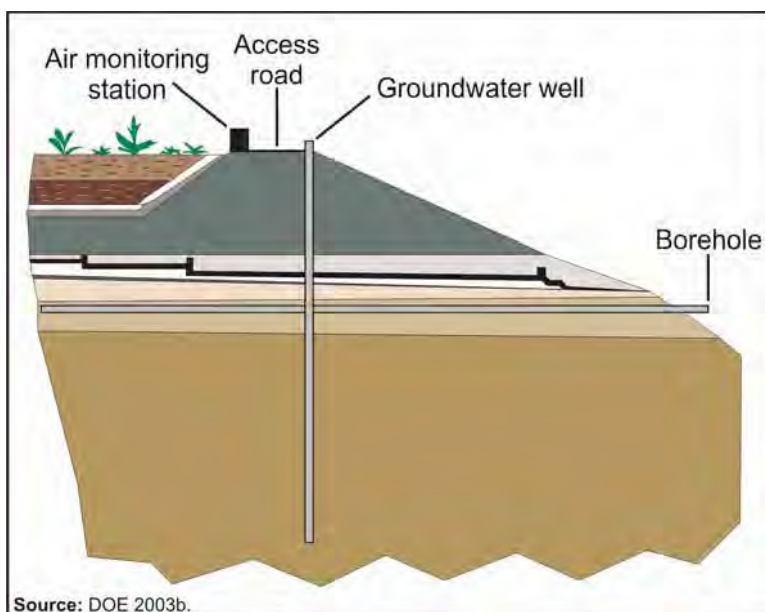

Figure E-32. Cross Section of Proposed Postclosure Monitoring Systems

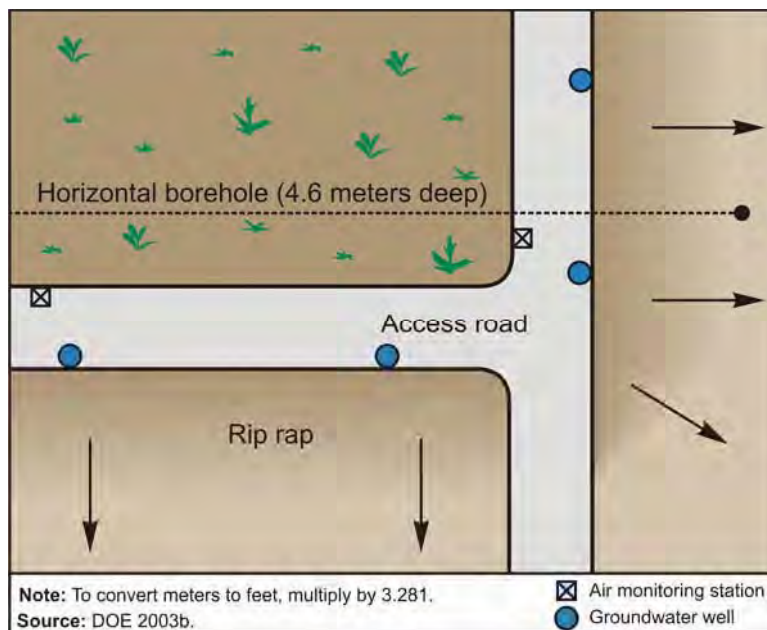

Figure E-33. Plan View of a Barrier Lobe Corner with Monitoring Systems Installed

Air Monitoring. Atmospheric releases of radioactive material from Hanford to the surrounding region are a potential source of human exposure. Radioactive and chemical constituents in air are monitored at a network of air sampling locations on and around Hanford, as well as in nearby and distant communities.

There are currently 45 continuously operating samplers. Of these, 24 samplers are on Hanford, 11 are near the site perimeter, 8 are in nearby communities, and 2 are in distant communities. Air samples collected are analyzed for gross beta and gross alpha radioactivity, specific gamma-emitting radionuclides, strontium-90, plutonium and uranium isotopes, and tritium.

Postclosure care plans would evaluate and/or incorporate the existing air monitoring program. It was assumed that atmospheric radioactive and chemical constituents would decline following barrier placement, which would result in a less vigorous ambient air monitoring program. It is expected that the number of near-field monitoring stations would be reduced almost to zero for long-term monitoring, giving way to at-surface barrier monitoring stations. It was also assumed that technologies would advance considerably in the next few years, and that the site would take advantage of those improvements.

Air monitoring technologies would concentrate on sampling, detecting, and/or analyzing volatiles that may be moving up through the surface barrier. As the asphalt layer prevents upward movement of volatile vapors, this monitoring would primarily monitor barrier performance. A number of technologies are currently available to fulfill this mission, including high-volume samplers that pass the air stream through activated charcoal and perforated shallow-soil gas probes. When coupled with photo ionization chambers and telemetry, it was anticipated that data could be continuously logged in a remote computer powered by small solar panels (DOE 2003b).

Groundwater Monitoring. DOE has monitored groundwater on Hanford since the 1940s to help determine which chemical and radiological contaminants have made their way into the vadose zone and groundwater. In 1996, DOE established the Groundwater Monitoring Project, under which current groundwater monitoring continues at 24 waste management sites. Each year, monitoring wells are evaluated for performance and new wells are installed as needed. Old wells that are in poor condition or

wells that are not being used for monitoring activities are decommissioned according to WAC 173-160, “Minimum Standards for Construction and Maintenance of Wells.”

There are several regulations and statutes that govern groundwater monitoring on Hanford, including the Atomic Energy Act, RCRA, CERCLA, and the **Washington Administrative Code**. The TPA (Ecology, EPA, and DOE 1989) is used to coordinate groundwater protection and remedial action efforts. Groundwater monitoring technologies currently in use include chemical and radiochemical analysis of groundwater samples, piezometers, laminated steel electronic sounding tapes, graduated steel tapes, pressure gauges, data loggers, and pressure transducers.

The sitewide groundwater monitoring strategy is to continue incorporating more cost-efficient methods as they are developed. An evaluation of the regulations governing groundwater monitoring activities would need to be performed in conjunction with development of a groundwater postclosure care plan. This evaluation would need to determine whether all wells would be monitored or whether a reduction to selected wells surrounding barriers would be more appropriate. It is anticipated that, by the time barriers are constructed, any groundwater wells currently in place would need to be replaced or upgraded. It was therefore assumed that all new wells would be needed for 100 years of postclosure care and that these wells would be drilled at the interface between the slope and the perimeter road built on top of each barrier or just outside the barrier perimeter.

Surface Barrier Monitoring. Surface barrier monitoring would include surveillance of the surface barrier for structural integrity, animal burrowing, soil erosion and deposition, and vegetation status. Currently, barrier monitoring can be done in several ways, and the resources needed are difficult to estimate until a specific method of monitoring is selected. Resources would vary from field investigation on foot to aerial photography and computer diagnostics.

Vadose Zone Monitoring. Vadose zone monitoring is currently conducted in tank farms using gamma logging and neutron probes in dry wells. Alternative vadose zone monitoring technology demonstrations are also being conducted on a research level.

Monitoring of the vadose zone after tank farm closure is the most important mechanism for ensuring that the closure activities are successful. Particularly important is confirmation that the surface barrier is performing as designed. Under complete clean closure (i.e., tank and deep soil removal), the tank farm areas would be considered clean after closure, and it was assumed that no postclosure care would be required. Monitoring would, however, be needed under any of the landfill alternatives (Tank Closure Alternatives 2B through 5 and 6C), where tanks, residual waste, ancillary equipment, or contaminated soils remain.

Recommendations cannot be made at this time regarding the best technologies for long-term monitoring of the vadose zone and surface barriers because the technologies are evolving at a rapid pace. Several research projects are under way to evaluate new electrical, geophysical, and photogrammetric/remote sensing methods and technologies for monitoring the vadose zone. These new technologies would offer more easily implemented and economical monitoring options than the historical and current field monitoring technologies. Before monitoring technologies are chosen, the results for those currently in R&D would be evaluated against the performance of the currently existing technologies. Regardless of the technology chosen to monitor the vadose zone, boreholes would be needed (DOE 2003b).

FACILITIES

No facilities would be required for postclosure care.

ASSUMPTIONS AND UNCERTAINTIES

- Technologies are developing at a rapid pace, so it is uncertain which technologies would actually be deployed for monitoring.
- The number and locations of the monitoring wells are uncertain at this time and could be affected by changes in the groundwater level and/or flow direction that could occur by the time postclosure care is initiated.
- All interim monitoring would continue until all tank farms were cleaned and/or areas were ready for barrier placement.
- Evaluation of current air monitoring stations (number and locations) would be conducted, and existing stations would be used whenever possible.
- New vadose zone monitoring boreholes would be needed at the perimeters of the barriers.
- Borehole spacing for this analysis was based on engineering judgment. Actual spacing would be determined during barrier design.
- Horizontal boreholes would be placed by incorporation into the surface barrier design.
- The vegetation cover would be planted with a mixture of native perennial grass species by disking, seeding, and crimping and would be reseeded when necessary (e.g., after range fires, which were assumed to occur every 10 years) (DOE 2003b).

E.1.2.5.5 Borrow Area C Operations

Borrow Area C is a proposed onsite pit to be used to supply sand, soil, and gravel to environmental remediation activities throughout Hanford. Area C has been included in several NEPA reviews, beginning with the **Final Hanford Comprehensive Land-Use Plan Environmental Impact Statement (Hanford Comprehensive Land-Use Plan EIS)** (DOE/EIS-0222F) (DOE 1999). The **Hanford Comprehensive Land-Use Plan EIS** set aside a portion of the Fitzner/Eberhardt Arid Lands Ecology Reserve (including Area C) as a quarry site instead of the McGee Ranch. The latter location was originally included as part of DOE's **Hanford Comprehensive Land-Use Plan EIS Preferred Alternative** due to the extensive basalt rock and silty soil materials located there which would be needed for Hanford Site remediation activities. However, due to input from the cooperating agencies such as the U.S. Fish and Wildlife Service (USFWS), the Washington Department of Fish and Wildlife, and the public, which were concerned about the importance of a wildlife corridor and shrub-steppe habitat located through the McGee Ranch/Umtanum Ridge area, DOE modified its Preferred Alternative. In the final Preferred Alternative the McGee Ranch land-use designation was revised to Preservation and included within a USFWS-managed wildlife refuge. In exchange, and in support the need for appropriate borrow materials, a portion of the Fitzner/Eberhardt Arid Lands Ecology Reserve was set aside and designated as Conservation (Mining). This tradeoff was subsequently acknowledged by the USFWS in its **Hanford Reach National Monument Draft Comprehensive Conservation Plan and Environmental Impact Statement** (USFWS 2006).

Specific alternatives discussed in this **TC & WM EIS** require the utilization of borrow materials from Borrow Area C. Resource material from Borrow Area C would primarily be used for construction of new facilities, backfilling and regrading where facilities and/or contaminated soils were removed from the ground, and creation of modified RCRA Subtitle C or Hanford barriers.

Conventional excavation, loading, and transportation equipment would be used at Borrow Area C. Conveyor systems may be employed to move excavated material to stockpile areas or load trucks. Conveying systems may be outfitted with crushing, sorting, and screening systems to segregate rock and fines according to Hanford’s needs. Basalt, when encountered, would be blasted with controlled, subsurface detonations.

E.1.2.5.5.1 Description

Borrow Area C is located near the intersection of Beloit Avenue and State Route 240. Borrow Area C is a large polygon of approximately 930 hectares (2,300 acres). Borrow Area C is bounded by State Route 240 and the Fitzner/Eberhardt Arid Lands Ecology Reserve. Borrow Area C is not part of the Hanford Reach National Monument. Borrow Area C was selected for use as a borrow area because of its relative close proximity to most of the environmental activities that would require borrow materials (e.g., on-site disposal facilities, tank farms, other 200 Area treatment facilities). Figure E–34 illustrates the relative location of Borrow Area C to the 200 Area and tank farms. Borrow material needed to support TC & WM EIS alternatives was assumed to come from Borrow Area C because it can provide the variety of gravel, sand, and soil types necessary to support environmental activities.

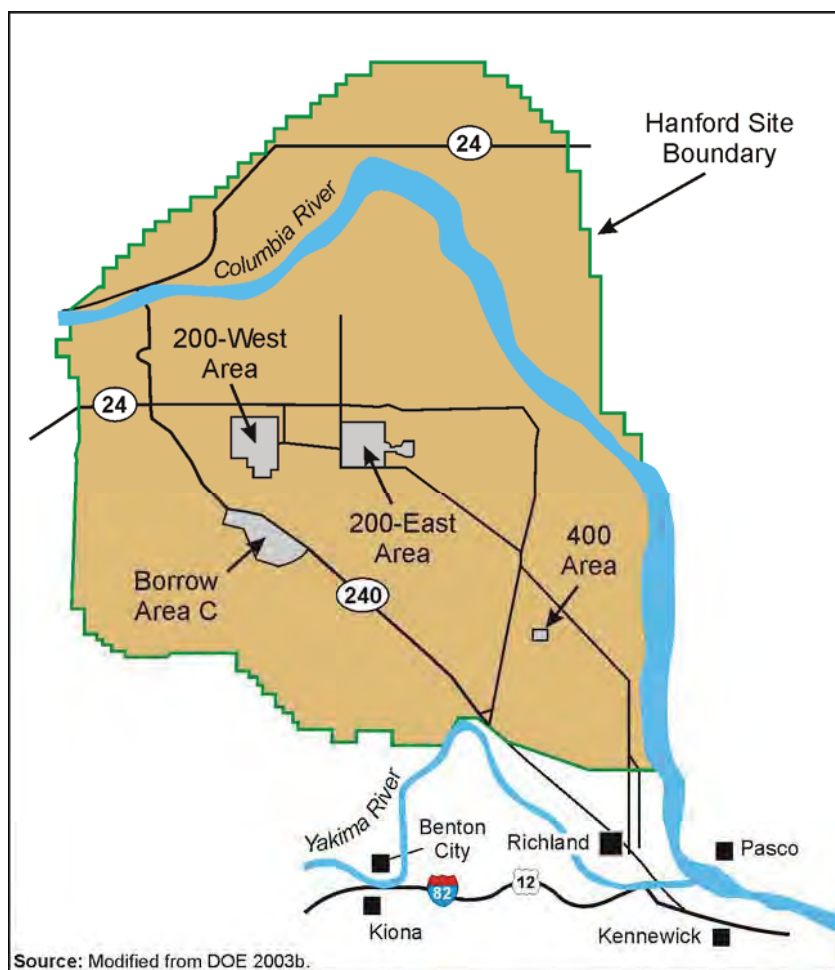

Figure E–34. Borrow Area C Pit Location and Access Routes

Assuming the entire Borrow Area C footprint of 930 hectares (2,300 acres) is excavated to a depth of 4.6 meters (15 feet), Borrow Area C would yield up to 42.6 million cubic meters (55.7 million cubic yards) of resource material to support Hanford activities, including those activities analyzed in this EIS.

For analysis purposes, the baseline operational data for Borrow Area C were based on an assumed excavation rate of 150 cubic meters (200 cubic yards) per hour. Available hours of operation would be a standard 2,080 hours per year. This assumed rate and hours of operation would be capable of producing approximately 318,000 cubic meters (416,000 cubic yards) per year of borrow material for use at Hanford.

A hydraulic excavator with a 1.5-cubic-meter (2-cubic-yard) shovel excavates sand and gravel at a rate of 122 cubic meters (160 cubic yards) per hour. Therefore, conservatively, two hydraulic excavators would be needed to achieve the operational rate of 150 cubic meters (200 cubic yards) per hour. A loader with a 3-cubic-meter (4-cubic-yard) bucket can load the sand and gravel into dump trucks at a rate of 245 cubic meters (320 cubic yards) per hour. Based on a 7.5-cubic-meter (10-cubic-yard) capacity dump truck making a single round trip in 1 hour, 20 dump trucks would be required to sustain a production rate of 150 cubic meters (200 cubic yards) per hour.

Two water trucks would be utilized to maintain dust control. Borrow Area C water usage for dust control would be approximately 190,000 liters (50,000 gallons) per day (SAIC 2007a).

E.1.2.5.5.2 Resources

The total borrow material demand from all tank closure, FFTF decommissioning, and waste management activities analyzed under the TC & WM EIS alternatives is provided in Table E-11. The estimated volumes in this table are for analysis purposes only and assume that the Borrow Area C would be operated at full production rates every day for the duration of the alternative, regardless of the actual need for borrow material. This table lists all the Borrow Area C demand activities and volumes that are expected to be implemented and provides four combinations of Tank Closure, FFTF Decommissioning, and Waste Management alternatives.

1. Alternative Combination 1: No Action Alternatives for Tank Closure Alternative 1, FFTF Decommissioning Alternative 1, and Waste Management Alternative 1 activities.

This combination estimates the demand for Borrow Area C resource material when all the No Action Alternatives are analyzed together.

2. Alternative Combination 2: Tank Closure Alternative 2B, FFTF Decommissioning Alternative 2 with the Hanford Option for disposition of remote-handed special components (RH-SCs), and Waste Management Alternative 2 in combination with Disposal Group 1.

This combination estimates the demand for Borrow Area C resource material resulting from a combination of the alternatives and represents DOE's Preferred Alternative.

3. Alternative Combination 3: Tank Closure Alternative 6B, Base Case; FFTF Decommissioning Alternative 3 with the Hanford Option for disposition of RH-SCs; and Waste Management Alternative 2 in combination with Disposal Group 2.

This combination estimates the demand for Borrow Area C resource material due to a combination of the alternatives and represents an upper limit for analyzing the demands on Borrow Area C resource materials.

Table E-11. Demand on Borrow Area C Resources from Alternative Activities

| Alternative | TOTAL (yd ³) | TOTAL (m ³) | Alternative Combinations | | | | | | | |
|-----------------|-----------------------------|----------------------------|---|--|--|--|--|--|--|----------------------|
| | | | Combination 1 | | Combination 2 | | Combination 3 | | Combination 4 | |
| | | | TC Alt. 1, FFTF Dec. Alt. 1, WM Alt. 1 (yd ³) | TC Alt. 1, FFTF Dec. Alt. 2 (Hanford); WM Alt. 2, DG 1 (yd ³) | TC Alt. 2B; FFTF Dec. Alt. 2 (Hanford); WM Alt. 2, DG 1 (m ³) | TC Alt. 6B, Base; FFTF Dec. Alt. 3 (Hanford); WM Alt. 2, DG 2(yd ³) | TC Alt. 6B, Base; FFTF Dec. Alt. 3 (Hanford); WM Alt. 2, DG 2 (m ³) | TC Alt. 6A, Base; FFTF Dec. Alt. 3 (Hanford); WM Alt. 2, DG 3(yd ³) | TC Alt. 6A, Base; FFTF Dec. Alt. 3 (Hanford); WM Alt. 2, DG 3 (m ³) | |
| Tank Closure | 1 | 1.21×10 ⁵ | 1.21×10 ⁵ | 9.28×10 ⁴ | | | | | | |
| | 2A | 1.64×10 ⁶ | 1.25×10 ⁶ | | | | | | | |
| | 2B | 5.66×10 ⁶ | 4.33×10 ⁶ | | 5.66×10 ⁶ | 4.33×10 ⁶ | | | | |
| | 3A | 6.03×10 ⁶ | 4.61×10 ⁶ | | | | | | | |
| | 3B | 5.38×10 ⁶ | 4.11×10 ⁶ | | | | | | | |
| | 3C | 5.61×10 ⁶ | 4.29×10 ⁶ | | | | | | | |
| | 4 | 6.09×10 ⁶ | 4.66×10 ⁶ | | | | | | | |
| | 5 | 7.03×10 ⁶ | 5.38×10 ⁶ | | | | | | | |
| | 6A, Base Case | 2.93×10 ⁷ | 2.24×10 ⁷ | | | | | | 2.93×10 ⁷ | 2.24×10 ⁷ |
| | 6A, Option Case | 2.90×10 ⁷ | 2.21×10 ⁷ | | | | | | | |
| Decommissioning | Alt. 6B, Base Case | 1.42×10 ⁷ | 1.08×10 ⁷ | | | | 1.42×10 ⁷ | 1.08×10 ⁷ | | |
| | Alt. 6B, Option Case | 1.39×10 ⁷ | 1.06×10 ⁷ | | | | | | | |
| | 6C | 6.21×10 ⁶ | 4.75×10 ⁶ | | | | | | | |
| | 1 | 0 | 0 | 0 | | | | | | |
| FFTF | 2 | 1.59×10 ⁵ | 1.21×10 ⁵ | | 1.59×10 ⁵ | 1.21×10 ⁵ | | | | |
| | 2 | 2.14×10 ³ | 1.63×10 ³ | | 2.14×10 ³ | 1.63×10 ³ | | | | |

Table E-11. Demand on Borrow Area C Resources from Alternative Activities (continued)

| Alternative | Alternative Combinations | | | | | | | | | | | | |
|-----------------------------------|---|---|----------------------------|---|--|----------------------------|--|--|----------------------------|--|--|----------------------------|----------------------------|
| | Combination 1 | | | Combination 2 | | | Combination 3 | | | Combination 4 | | | |
| | TC Alt. 1, FFTF Dec. Alt. 1, WM Alt. 1 (yd ³) | TC Alt. 1, FFTF Dec. Alt. 1, WM Alt. 1 (m ³) | TOTAL (m ³) | TC Alt. 2B; FFTF Dec. Alt. 2 (Hanford); WM Alt. 2, DG 1 (yd ³) | TC Alt. 2B; FFTF Dec. Alt. 2 (Hanford); WM Alt. 2, DG 1 (m ³) | TOTAL (m ³) | TC Alt. 6B; Base; FFTF Dec. Alt. 3 (Hanford); WM Alt. 2, DG 2(yd ³) | TC Alt. 6B, Base; FFTF Dec. Alt. 3 (Hanford); WM Alt. 2, DG 2 (m ³) | TOTAL (m ³) | TC Alt. 6A, Base; FFTF Dec. Alt. 3 (Hanford); WM Alt. 2, DG 3(yd ³) | TC Alt. 6A, Base; FFTF Dec. Alt. 3 (Hanford); WM Alt. 2, DG 3 (m ³) | TOTAL (m ³) | |
| 3 | 1.88×10 ⁵ | 1.43×10 ⁵ | 1.43×10 ⁵ | | | | 1.88×10 ⁵ | 1.43×10 ⁵ | 1.88×10 ⁵ | 1.43×10 ⁵ | 1.43×10 ⁵ | 1.88×10 ⁵ | 1.43×10 ⁵ |
| 3, Hanford options (SRF & RTP) | 2.14×10 ³ | 1.63×10 ³ | 1.63×10 ³ | | | | 2.14×10 ³ | 1.63×10 ³ | 2.14×10 ³ | 1.63×10 ³ | 1.63×10 ³ | 2.14×10 ³ | 1.63×10 ³ |
| 2, T&S | 1.39×10 ⁴ | 1.06×10 ⁴ | 1.06×10 ⁴ | 1.39×10 ⁴ | 1.06×10 ⁴ | 1.06×10 ⁴ | 1.39×10 ⁴ | 1.06×10 ⁴ | 1.39×10 ⁴ | 1.06×10 ⁴ | 1.06×10 ⁴ | 1.39×10 ⁴ | 1.06×10 ⁴ |
| 2, DG 1 | 2.46×10 ⁶ | 1.88×10 ⁶ | 1.88×10 ⁶ | 2.46×10 ⁶ | 1.88×10 ⁶ | 1.88×10 ⁶ | | | | | | | |
| 2, DG 2 | 9.46×10 ⁶ | 7.23×10 ⁶ | 7.23×10 ⁶ | | | | 9.46×10 ⁶ | 7.23×10 ⁶ | | | | | |
| 2, DG 3 | 9.46×10 ⁶ | 7.23×10 ⁶ | 7.23×10 ⁶ | | | | | | | | | | |
| 3, T&S | 1.39×10 ⁴ | 1.06×10 ⁴ | 1.06×10 ⁴ | | | | | | | | | | |
| 3, DG 1 | 2.17×10 ⁶ | 1.66×10 ⁶ | 1.66×10 ⁶ | | | | | | | | | | |
| 3, DG 2 | 9.37×10 ⁶ | 7.16×10 ⁶ | 7.16×10 ⁶ | | | | | | | | | | |
| 3, DG 3 | 9.37×10 ⁶ | 7.16×10 ⁶ | 7.16×10 ⁶ | | | | | | | | | | |
| Total | 1.30×10⁵ | 9.90×10⁴ | 9.90×10⁴ | 8.30×10⁶ | 6.34×10⁶ | 6.34×10⁶ | 2.38×10⁷ | 1.82×10⁷ | 3.90×10⁷ | 1.82×10⁷ | 1.82×10⁷ | 3.90×10⁷ | 2.98×10⁷ |

Notes:

- 1 The Idaho options under FFTF Decommissioning Alternatives 2 and 3 do not require Borrow Area C materials.
 - 2 All borrow material resources are assumed to be supplied by Borrow Area C.
 - 3 Available Borrow Area C resources are estimated to be 4.26×10⁷ cubic meters (5.57×10⁷ cubic yards). This estimate assumes 930 hectares (2,300 acres) are available and the average excavated depth is 4.6 meters (15 feet).
 - 4 Blank cell denotes not applicable.
- Key:** Alt.=Alternative; Base=Base Case; Dec.=Decommissioning; DG=Disposal Group; FFTF=Fast Flux Test Facility; Hanford=Hanford Site; m³=cubic meters; RTP=Remote Treatment Project; SRF=Sodium Reaction Facility; T&S=treatment and storage; TC=Tank Closure; WM=Waste Management; yd³=cubic yards.
Source: SAIC 2007a, 2008.

4. Alternative Combination 4: Tank Closure Alternative 6A, Base Case; FFTF Decommissioning Alternative 3 with the Hanford Option for disposition of RH-SCs; and Waste Management Alternative 2 in combination with Disposal Group 3.

This combination estimates the highest demands for Borrow Area C borrow materials.

As shown in Table E–11, the demands for all the alternative combinations above do not exceed the 42.6 million cubic meters (55.7 million cubic yards) of available borrow material volume. Alternative Combination 4 requires the highest volume of borrow materials; approximately 70 percent of the available borrow material.

Alternatively, based on an estimated total available volume of borrow material of 42.6 million cubic meters (55.7 million cubic yards), Borrow Area C would be able to support Hanford operations for up to 134 years at the maximum production rate of 318,000 cubic meters (416,000 cubic yards) per year. In practice, the resource demands for each TC & WM EIS alternative on Borrow Area C would be intermittent, nonexistent during lengthy intervals, and significantly less than the volumes estimated in Table E–11. However, for the purpose of analyzing air emissions generated from operations of heavy equipment and wind erosion (e.g., dust), each TC & WM EIS alternative conservatively assumes that Borrow Area C would be operated at full production rates every day for the duration of the alternative, regardless of the actual needs for borrow material.

E.1.2.5.5.3 Assumptions and Uncertainties

- The analysis of available resources (e.g., borrow material) and the consumption of these resources in support of the alternatives analyzed in this TC & WM EIS is based on several assumptions related to the operations of the Borrow Area C pits. The operation of Borrow Area C pit is purely an earthmoving exercise utilizing traditional mechanical means and methods. The production rate of borrow material is based on a modest amount of equipment (e.g., 1.5 to 3.1-cubic-meter [2- to 4-cubic-yard] excavators, 0.7 to 3.1-cubic-meter [1- to 4-cubic-yard] loader, 15.3- to 7.6-cubic-meter [20- to 10-cubic yard] dump trucks, etc.) and a standard 2080-hour work year. If necessary to meet peak resource demands to support environmental activities at Hanford, the large size of Borrow Area C (930 hectares [2,300 acres]) could easily accommodate an increase in heavy equipment or daily work shifts to temporarily increase production rates.
- Borrow Area C operations would generate no LLW, MLLW, TRU waste, or hazardous waste.
- Borrow Area C infrastructure upgrades prior to operation and restoration activities after operations are not included in this analysis.
- Borrow Area C would produce equal amounts of sand and gravel.
- Radiological exposure to workers (radiological workers) would be zero.
- The average Borrow Area C excavation depth is 4.6 meters (15 feet).
- Controlled blasting may be required for excavation of basalt to meet gravel/rock requirements (SAIC 2007a).

E.1.2.6 Facility Decontamination and Decommissioning

This TC & WM EIS specifically evaluates the D&D of only the following 10 existing Hanford facilities that would be required prior to final closure of the SST system.

- **242-S Evaporator.** The 242-S Evaporator, located north of the S tank farm, was used to concentrate tank waste. Operation of the evaporator began in 1973 and continued until 1980. The facility was shut down in 1980 and placed in a standby mode in 1981.
- **242-T Evaporator.** The 242-T Evaporator is located adjacent to the TX tank farm. Operation of the evaporator began in 1952 and continued intermittently until 1980. In April 1981, a shutdown/standby plan was written, and a final waste transfer out of the facility was made in 1982.
- **204 AR Receiver Station.** The 204 AR Receiver Station is located west of the AX tank farm. The facility was designed to receive liquid waste from rail tank cars or tank trailers and to pump this waste to a designated 200-East Area tank farm. The facility was constructed in 1981 and is still operational.
- **241-A-431 Vent Building.** The 241-A-431 Vent Building was constructed in 1953 to provide offgas de-entrainment for the six tanks in the A tank farm and to receive drainage from the 296-A-11 stack. It began operation in 1955 and was shut down in 1969.
- **241-AX-IX Ion Exchange.** The 241-AX-IX Ion Exchange is located east of the A tank farm and was used to treat condensate from the waste facility exhauster between the A and AX tank farms. The column was designed and built in the late 1960s and was operated routinely from 1973 to 1976.
- **241-BY-ITS1 In-Tank Solidification.** The 241-BY-ITS1 In-Tank Solidification is located in the BY tank farm. The system was constructed in the late 1950s and operated until the mid-1970s to concentrate waste in the BY tanks.
- **241-C-801 Cesium Loadout Facility.** The 241-C-801 Cesium Loadout Facility is located in the C tank farm. It commenced operation in 1962 and served as a cesium processing transfer facility until 1976.
- **241-SX-401 and 241-SX-402 Condenser Shielding Buildings.** These condenser shielding buildings were built in 1954 and are located within the SX tank farm. Building 241-SX-401 was used as designed to cool some of the tanks in the SX tank farm. This continued until 1975, when the facility's use was ended.
- **241-AX-WT-SP-137 Seal Pot.** The 241-AX-WT-SP-137 Seal Pot is an underground structure located in the AX tank farm. The seal pot would be grouted and abandoned in place.

D&D of these 10 facilities would include the following operations: decontamination of building surfaces and equipment; removal of major vessels from inside each facility; demolition of each facility to ground level; and transfer of waste, rubble, and debris into containers or shielded burial boxes for shipment to appropriate disposal locations (DOE 2003b).

This TC & WM EIS evaluates the deactivation of the WTP and other proposed waste treatment and interim storage facilities (i.e., the CSB, IHLW Shipping/Transfer Facility, IHLW Interim Storage Modules, and ILAW Interim Storage Facilities) at the end of their operational lives. However, closure and D&D of these facilities are not within the scope this TC & WM EIS.

E.1.3 Tank Closure Technologies Considered, but Not Analyzed in Detail

This section describes the technologies that were initially considered, but were not evaluated, in this TC & WM EIS.

E.1.3.1 Waste Storage

Some of the alternatives may require additional storage capacity beyond the current DST capacity. The proposed storage arrangement is the construction of new below-grade DSTs. The following storage options were considered but not evaluated.

Modification of Existing Canyon Facilities. This concept involves the modification of existing canyon facilities (e.g., the Plutonium-Uranium Extraction [PUREX] Plant, B Plant) to store HLW. Existing equipment would be removed and new tank capacity would be installed. This option was not evaluated because (1) existing canyon facilities are not designed for storage of large volumes of liquid waste; (2) the existing radiation and contamination levels would result in elevated personnel exposure; (3) the low volume of storage space would not be cost-effective; and (4) environmental permitting is highly uncertain (DOE 2003c).

New Above-Grade DSTs. This concept involves construction of new above-grade DSTs similar to the WTP waste receipt tanks. This option would also require construction of a facility surrounding the tanks to provide shielding. This option was not evaluated because (1) there are technical disadvantages associated with shielding large (3.8-million-liter [1-million-gallon]) aboveground tanks and (2) resources associated with new aboveground tanks would be similar to those associated with the below-grade tanks (DOE 2003c).

Staging of Retrieved Waste in Single-Shell Tanks. Use of SSTs was proposed as an option for staging of retrieved waste prior to transfer to the DST system or to waste treatment. This would be used only in cases where sufficient DST space was not readily available to support SST retrieval. The SSTs selected for staging of waste would need to be upgraded with leak detection, monitoring, and mitigation systems. Pumps, transfer lines, and ventilation systems would also need to be upgraded or replaced.

This option was not considered for evaluation in this TC & WM EIS primarily because the SSTs cannot be made compliant with current regulations. In addition, this option would likely require extra DST space to be held in reserve in the event a leak was detected in one of the waste staging SSTs. This would potentially decrease the available space in the DSTs by the volume of the largest SST used.

The possibility of obtaining waivers to use the SSTs for staging waste if upgrades were completed was considered. However, it was determined that new WRFs would be the preferred option for staging retrieved waste under those alternatives that require accelerated retrieval of waste from SSTs (DOE 2003c).

E.1.3.2 Waste Retrieval

The following technologies could be used in the SSTs to retrieve waste. All of the technologies are flexible with regard to the general configuration of the equipment, fluid velocities and flow rates, and methods of operation. As such, tank-specific considerations such as riser availability, waste condition, or in-tank interferences offer advantages to one retrieval technology over other technologies and lead to the selection of that technology to retrieve waste from a particular tank. The following retrieval technologies have been used or are in use and were addressed in the TWRS EIS. However, they are very similar to, and effectively encompassed by, the retrieval technologies evaluated in this TC & WM EIS. Therefore, DOE did not consider them reasonable for further consideration and evaluation in this TC & WM EIS.

Past-Practice Sluicing. Past-practice sluicing is the introduction of liquid (water or liquid waste from another tank) at moderate pressures and high volumes into the waste. Pressure of 1.2 million pascals (180 pounds of force per square inch) and flows of 1,300 liters (350 gallons) per minute are typical. The liquid dissolves and breaks apart solid materials and suspends them in a waste slurry. A transfer pump inside the tank pumps the slurry to a receiver tank at flows of approximately 1,300 liters (350 gallons) per minute. Past-practice sluicing has been used to remove waste from more than 50 tanks at Hanford and was most recently used on tank 241-C-106. Modified sluicing offers improvements over past-practice sluicing (e.g., less water, better distribution systems) and was selected for analysis in this TC & WM EIS.

Fluidic Mixing. Fluidic mixing systems consist of in-tank mixing vessels connected to submerged jets or orifices via a pipe. A vacuum is created in the mixing vessel, filling it with solid and liquid waste. The vacuum is released and the mixing vessel is charged, driving the fluid in the mixing vessel back into the tank through the jet and imparting a mixing action on the tank waste. This process is repeated until the tank waste is sufficiently mixed. The waste is pulled into the mixing vessel and driven out of the tank through a pipeline to a receiver tank. The fluidic mixing system has been used to retrieve radioactive waste at ORNL (DOE 2003c).

Salt Cake Dissolution. The salt cake dissolution method sprays a solvent (typically water) onto the salt cake surface using a sprinkler-type device. The sprinkler device is designed to distribute the solvent in a uniform manner across the waste surface. The solvent dissolves the salt cake and drains to a centrally located pump. This pump is housed in a salt well screen specifically designed to prevent passage of the larger-sized particles that are inherent with sludge and insoluble waste. The salt cake dissolution retrieval system is designed to retrieve primarily soluble wastes and not to retrieve sludge and other insoluble waste components. A proof-of-concept salt cake dissolution system was designed, tested, and used in tank 241-U-107 (DOE 2003c).

E.1.3.3 Treatment Technologies

Section E.1.2.3.5.1 describes the process DOE used to identify and select supplemental LAW treatment and immobilization techniques. From the dozens of treatment options considered, seven were selected for further consideration based on their expected viability for accelerating cleanup and reducing risk while maintaining cleanup quality.

After further data development and evaluation, the C3T MAI subgroup compared and evaluated the seven options based on criteria developed by the team. The selection criteria addressed worker and public safety, environmental protection, schedule acceleration, cost-effectiveness, operability, and system interface effects. Using both quantitative and qualitative measures for scoring, the subgroup selected three immobilization techniques, bulk vitrification, cast stone, and steam reforming, as well as one pretreatment technology, sulfate removal, for further evaluation and prototype testing. These are the supplemental treatment technologies identified in the Notice of Intent for potential analysis in this TC & WM EIS.

The three immobilization techniques, bulk vitrification, cast stone, and steam reforming, as well as the pretreatment technology, sulfate removal, are included under the alternatives analyzed in this EIS and are described in Sections E.1.2.3.6 through E.1.2.3.9.

In addition to the technologies selected by the subgroup for further evaluation, other pretreatment and immobilization technologies may become viable for use in place of or in addition to the technologies analyzed in detail in this TC & WM EIS. Decisions on the implementation of these technologies are outside the scope of this TC & WM EIS. A future decision to implement any of these technologies would require analysis to demonstrate that the technology performs within the bounds of this EIS.

E.1.3.3.1 Technology Readiness Assessment

In 2007, DOE conducted a Technology Readiness Assessment (TRA) to determine the maturity level of the technologies applied to treatment of Hanford tank LAW. The results of this assessment are documented in DOE's **Hanford River Protection Project Low Activity Waste Treatment: A Business Case Evaluation** (DOE/ORP-2007-03) (Wade et al. 2007). The following is an excerpt from Appendix B, "Technology Readiness Assessment Results," to this document.

B.1 Description of Technology Assessment

In 1999, the U.S. General Accounting Office (GAO) produced a report (GAO/NSIAD-99-162) that examined the differences in technology transition between the U.S. Department of Defense (DoD) and private industry. The GAO concluded that the DoD took greater risks and attempted to transition emerging technologies at lesser degrees of readiness compared to private industry and that the use of immature technology increased the overall program risk and led to substantial cost and schedule overruns. The GAO recommended that the DoD adopt the use of National Aeronautics and Space Administration's (NASA) Technology Readiness Levels (TRL) as a means of assessing technology readiness before design transition. In 2001, the DoD Deputy Undersecretary for Science and Technology issued a memorandum that endorsed the use of the TRA process to develop TRLs for new major programs. Guidance for assessing technology readiness was incorporated into the **Defense Acquisition Guidebook** (DoD 2004), which defines a TRA as follows:

"A TRA is a systematic, metric-based process and accompanying report that assesses the readiness of certain technologies [called Critical Technology Elements (CTEs)] used in systems."

The TRA process consists of three parts: (1) identifying critical technology elements (CTE), (2) assessing the TRL of each CTE using an established readiness scale, and (3) preparing the TRA report. The CTE identification process involves breaking the project under evaluation into its component systems and subsystems and determining which of these are essential to project success, and either represent new technologies, are combinations of existing technologies in new or novel ways, or will be used in a new environment. If some of the CTEs are judged to be below the desired level of readiness, the TRA is followed by development of a technology maturation plan that identifies the additional development required to attain the desired level of readiness.

DOE is conducting a pilot program that includes this study to evaluate the use of TRAs in its projects. The TRA process is being adapted for use by DOE from applications by other agencies (e.g., DOE, NASA). Notably, the TRA process is being adapted from use in product development applications to nuclear-chemical engineering process development applications for U.S. Department of Energy, Office of Environmental Management (EM). Use of the TRA process for evaluating LAW alternative technologies represents the first TRA application by EM and therefore is a pilot study that will serve as a basis for subsequent revisions to the use of the TRA process by DOE. The purpose of the TRAs conducted in support of this report was to determine the readiness level of the technologies as applied to the treatment of Hanford Site tank LAW.

The TRL scale used for the Hanford Site TRAs is shown in Table B.1. The DoD policy requires that testing of a prototypical design in a relevant environment be completed before incorporation of the technology into the final design of the facility. Thus, for DoD, a TRL 6

Draft Tank Closure and Waste Management Environmental Impact Statement for the Hanford Site, Richland, Washington

must be achieved prior to proceeding to Milestone B, which is the entrance point for the initiation of a system acquisition program.

The testing requirements used for the Hanford Site TRAs are compared to the TRLs in Table B.2. These definitions provide a convenient means to display the relationship between the scale of testing, fidelity of testing system, testing environment, and the TRL. The goal is to achieve a TRL 6 prior to incorporation of the technology into the final design. In order to attain a TRL 6, testing must be completed at an engineering or pilot scale, with testing of the system fidelity that is similar to the actual application and with a range of simulated waste and/or limited range of actual waste, if applicable.

DOE's assessment of the TRLs was aided by a TRL Calculator that was originally developed by the U.S. Air Force (Nolte et al. 2003) and modified by the DOE Assessment Team. This tool is a standard set of questions addressing hardware, software program, and manufacturability questions and is implemented in Microsoft Excel™. The set of questions provide the criteria used to assess and determine the TRL numerical value. The TRL Calculator produces a graphical display of the TRLs achieved and was used by the Assessment Team in establishing TRLs.

Table B.1. Technology Readiness Levels Used in this Assessment

| Relative Level of Technology Development | Technology Readiness Level | TRL Definition | Description |
|--|----------------------------|---|--|
| System Operations | 9 | Actual system operated over the full range of expected conditions. | The technology is in its final form and operated under the full range of operating conditions. Examples include using the actual system with the full range of wastes. |
| System Commissioning | 8 | Actual system completed and qualified through test and demonstration. | The technology has been proven to work in its final form and under expected conditions. In almost all cases, this TRL represents the end of true system development. Examples include developmental testing and evaluation of the system with real waste in hot commissioning. |
| | 7 | Full-scale, similar (prototypical) system demonstrated in relevant environment | This represents a major step up from TRL 6, requiring demonstration of an actual system prototype in a relevant environment. Examples include testing the prototype in the field with a range of simulants and/or real waste and cold commissioning. |
| Technology Demonstration | 6 | Engineering/pilot-scale, similar (prototypical) system validation in relevant environment | Engineering-scale models or prototypes are tested in a relevant environment. This represents a major step up in a technology's demonstrated readiness. Examples include testing a prototype with real waste and a range of simulants. |

Table B.1. Technology Readiness Levels Used in this Assessment (continued)

| Relative Level of Technology Development | Technology Readiness Level | TRL Definition | Description |
|--|----------------------------|--|---|
| Technology Development | 5 | Laboratory scale, similar system validation in relevant environment | The basic technological components are integrated so that the system configuration is similar to (matches) the final application in almost all respects. Examples include testing a high-fidelity system in a simulated environment and/or with a range of real waste and simulants. |
| | 4 | Component and/or system validation in laboratory environment | The basic technological components are integrated to establish that the pieces will work together. This is relatively "low fidelity" compared with the eventual system. Examples include integration of ad hoc hardware in a laboratory and testing with a range of simulants. |
| Research to Prove Feasibility | 3 | Analytical and experimental critical function and/or characteristic proof of concept | Active research and development (R&D) is initiated. This includes analytical studies and laboratory-scale studies to physically validate the analytical predictions of separate elements of the technology. Examples include components that are not yet integrated or representative. Components may be tested with simulants. |
| | 2 | Technology concept and/or application formulated | Once basic principles are observed, practical applications can be invented. Applications are speculative, and there may be no proof or detailed analysis to support the assumptions. Examples are still limited to analytic studies. |
| Basic Technology Research | 1 | Basic principles observed and reported | This is the lowest level of technology readiness. Scientific research begins to be translated into applied R&D. Examples might include paper studies of a technology's basic properties. |

Table B.2. Relationship of Testing Requirements to the Technology Readiness Level

| TRL | Scale of Testing ¹ | Fidelity ² | Environment ³ |
|-----|-------------------------------|-----------------------|-----------------------------|
| 9 | Full | Identical | Operational (Full Range) |
| 8 | Full | Identical | Operational (Limited Range) |
| 7 | Full | Similar | Relevant |
| 6 | Engineering/Pilot | Similar | Relevant |
| 5 | Laboratory | Similar | Relevant |
| 4 | Laboratory | Pieces | Simulated |
| 3 | Laboratory | Pieces | Simulated |
| 2 | Paper | Paper | Paper |
| 1 | Paper | Paper | Paper |

- ¹ Full Scale = Full plant scale that matches final application
 1/10 Full Scale < Engineering/Pilot Scale < Full Scale (Typical)
 Lab Scale < 1/10 Full Scale (Typical)
- ² Identical System – configuration matches the final application in all respects
 Similar System – configuration matches the final application in almost all respects
 Pieces System – matches a piece or pieces of the final application
 Paper System – exists on paper (no hardware)
- ³ Operational (Full Range) – full range of actual waste
 Operational (Limited Range) – limited range of actual waste
 Relevant – range of simulants + limited range of actual waste
 Simulated – range of simulants

B.2 Summary of LAW Treatment TRA Results

The TRA conducted to support this report were performed by DOE following the process described above. Results from the two TRAs identified below were utilized to support the business case study presented in this report. Table B.3 provides a summary of the TRLs related to each business case.

Table B.3. Business Case Technology Readiness Level Summary

| Business Case and SI Approach | Critical Technology Elements (Systems) | TRLs |
|---|---|-----------------------|
| 1 – WTP LAW Only | Container Sealing | 5 |
| | Decontamination | 4 |
| | LAW Melter Feed | 6 |
| | LAW Melter | 6 |
| | Melter Offgas and Vessel Vent Process | 6 |
| 2 – 2nd WTP LAW | Same as Case 1 | Same as Case 1 |
| 3 – BV | Feed Receipt, Feed Preparation, and Feeding | 5 |
| | In-Container Vitrification | 5 |
| | Offgas Treatment | 4 |
| 4 – CS | Feed Receipt, Feed Preparation, and Feeding | 3 |
| | Mixing and Casting | 3 |
| 5 – SR | Feed Receipt, Feed Preparation, and Feeding | 4 |
| | Thermal Reformer | 5 |
| | Offgas Treatment | 4 |
| 6 – BV East and West w/TF Pretreatment Facility | Container Handling and Waste Qualification | 3 |
| | BV Same as Case | 3 |
| | Rotary Filtration | 3 |
| 7 – LAW First and BV w/TF Pretreatment Facility | Cesium ion exchange | 3 |
| | Same as Cases 1 and 6 | Same as Cases 1 and 6 |

Note: SI=Supplemental Immobilization. In Business cases 6 and 7, tank farm-based pretreatment TRLs are also provided.

Table B.4 provides a summary of the Waste Treatment and Immobilization Plant (WTP) Low-Activity Waste (LAW) results from 07-DESIGN-042, **Technology Readiness Assessment for the Waste Treatment Plant (WTP) Analytical Laboratory, Balance of Facilities and LAW Waste Vitrification.**”

Table B.4. Technology Readiness Level Summary WTP LAW Critical Technology Elements

| Critical Technology Element/Description | Technology Readiness Level | Rationale |
|---|----------------------------|---|
| <p>ILAW Container Finishing Handling System (LFH) Container Sealing Subsystem The ILAW container sealing subsystem press fits and locks a flat circular lid into a circular groove in the container neck.</p> | 5 | The container sealing system design is based on existing technologies but has not been demonstrated as an integrated prototypical system in an operating environment. |
| <p>LFH Decontamination Subsystem The LFH decontamination subsystem sprays carbon dioxide pellets at ILAW container surfaces to remove radioactive contamination. The sublimed carbon dioxide and dislodged contamination are contained by a vacuum system and shroud.</p> | 4 | The ILAW container decontamination design is based on existing technology concepts, but has not been demonstrated as an integrated, prototypical system in a relevant environment. Testing on a laboratory scale of the carbon dioxide spray to decontaminate flat-metal specimens has been completed; testing did not demonstrate the WTP Project’s requirement on surface decontamination levels. Integrated testing of the robot, carbon dioxide spray, and shrouding system has not been carried out on the complex surfaces of the ILAW container. |
| <p>LAW Melter Feed Process System (LFP) The LFP mixes LAW Facility waste and glass formers to provide feed for the LAW melters.</p> | 6 | There has been extensive WTP and vendor testing to demonstrate the adequacy of the mixing systems |
| <p>LAW Melter System (LMP) The LMP is the LAW melter system that melts mixtures of LAW and glass formers.</p> | 6 | The LAW melter has a significant development basis in previous DOE projects and developmental tests for the WTP. However, risk remains with the availability of MA758, a high chromium alloy used for the LAW bubbler assembly. An alternate bubbler material of construction should be identified. |
| <p>LOP/LVP The LOP/LVP is the LAW Melter Offgas and Vessel Vent Process Systems that remove aerosols, gases, and particulates generated by the LAW melters and vessel vent streams.</p> | 6 | The LOP/LVP have a significant technology basis. Two of 12 MACT DRE tests for naphthalene conducted on a prototypical system did not attain the required destruction efficiency. Engineering analysis shows that the WTP system should attain MACT standards based on higher capacities of the plant unit operations as compared to the pilot plant unit operations. |

The DOE TRA cited above assesses Business Case No. 7 (LAW First and Bulk Vitrification with Tank Farm Pretreatment) at Technology Readiness Levels of 3 to 6. However, at the time of the preparation of this TC & WM EIS, DOE had not made a decision on whether to support implementation of this Business Case. Such a decision requires, minimally, completion and DOE approval of its project management system Critical Decision 0 (CD-0) requirements. These requirements include, for example,

approval of a Mission Need for the project and the completion of preconceptual design planning and analysis. On December 21, 2007, DOE approved the Justification of Mission Need Statement for an Interim Pretreatment System Project (Rispoli 2007). However, no design information was included in this project documentation to support analyzing tank farm pretreatment in this TC & WM EIS.

Differences between the LAW First and Bulk Vitrification with Tank Farm Pretreatment Business Case and this EIS identified at this time include the following:

- Solids and cesium separation using rotary microfiltration and ion exchange, respectively
- Secondary waste, which would include additional inventories of technetium-99 and iodine-129 that would be disposed of in an IDF
- Upgrades to the ETF

However, it is recognized that the above differences could change as design information matures.

E.1.3.3.2 Low-Activity Waste Treatment and Immobilization Technologies

The following subsections describe potential LAW treatment and immobilization technologies that were not included under the alternatives analyzed in this TC & WM EIS. Each discussion addresses the reasons the technology was not analyzed.

E.1.3.3.2.1 Active-Metal Reduction

The active-metal reduction process was one of the potential LAW treatment and immobilization technologies evaluated by the MAI subgroup. This technology was not selected for further analysis. The technology scored low compared to the other technologies considered, primarily on the basis of its technical immaturity, complexity, and the operational safety issues involved because of its flammable gas generation.

The active-metal reduction process uses a stirred tank or a fluidized-bed reactor to decompose nitrates and nitrites present in the salt cake waste. The sodium aluminate-aluminum hydroxide product from the active-metal reduction reactor is mixed with phosphoric acid or silica to produce a sodium aluminosilicate or aluminophosphate ceramic waste form. The active-metal reduction process has been demonstrated on a laboratory scale, but the process chemistry has not been entirely confirmed. This process is a potentially complete LAW treatment option with no streams returning to DSTs. Further research is required to confirm chemical reactions on actual waste, the liquid effluent stream and offgas compositions, and the performance of the phosphate-bonded ceramic waste form produced (DOE 2003e).

E.1.3.3.2.2 Fractional Crystallization

The WTP Pretreatment Facility currently being constructed in the 200-East Area would separate tank waste into HLW and LAW fractions. Fractional crystallization is a technology being considered as a potential supplemental pretreatment process in the 200-West Area that would primarily target medium-curie tank waste from SSTs. As a supplemental separations technology, the clean salt technology would be employed after selective dissolution, settling/decanting, and ion exchange processes—steps that are already assumed as a baseline 200-West Area separations process for pretreating tank waste streams. The ion exchange pretreatment process would require the construction of a new facility. The selective dissolution and settling/decanting steps would not require new facilities and would be incorporated into the retrieval process and the proposed 200-West Area Solid-Liquid Separations Facility, which is described in Section E.1.2.3.5.2.

The medium-curie tank waste, characterized by high sodium and sulfate content, presents operational challenges for the WTP LAW melter (Hamilton 2005). Supplemental treatment technologies are being considered which could increase WTP LAW processing capacities. In contrast, when considering final waste performance and worker exposures, it is more desirable to divert medium-curie waste with certain radionuclides (e.g., cesium-137 and technetium-99) to the WTP LAW melter (Hamilton 2006b). The proposed 200-West Area Solid-Liquid Separations Facility already includes methods for fractionating radionuclides and reducing sulfate content. Fractional crystallization would go beyond this separations technology by also reducing the sodium content of the waste stream being directed back to the WTP process. This would increase the waste loading in the WTP LAW melter. In essence, the objectives of the fractional crystallization would be to (1) reduce the radioactive activity (e.g., cesium-137) in the LAW feed into the supplemental treatment facility; and (2) reduce the sodium content of the WTP LAW feed (Hamilton 2006b). Sulfate removal by precipitation, if necessary, could also be incorporated into the fractional crystallization process facility to accomplish a third objective.

The fractional crystallization process was not evaluated in detail due to the lack of available data demonstrating this process on actual tank wastes. If new R&D suggests favorable results, the implementation of fractional crystallization for separations may be evaluated in detail at a later date. The core process for the options uses the same precipitation process to achieve separation. The options are as follows:

- Fractional crystallization for radionuclide separations and sodium reduction
- Fractional crystallization for radionuclide separations with sodium and sulfate reduction

For the fractional crystallization option (without sulfate removal), the sodium nitrate crystals are formed by evaporating the liquid waste below the sodium nitrate solubility in a reduced atmosphere. These crystals are separated from the highly radioactive liquid and washed. The liquid fraction, containing the most of the radionuclides (e.g., cesium-137, iodine-129, and technetium-99) would be returned to the DST system for eventual processing by the WTP and the washed salts would be re-dissolved with the process condensate and immobilized as ILAW glass.

For the option with sulfate removal, an additional precipitation step utilizing strontium nitrate would be used to remove sulfate from the waste stream. Following the sulfate reduction, the separated supernatant would be treated by fractional crystallization as described above. The re-dissolved solids from fractional crystallization would then be mixed with the precipitated solids from the sulfate removal step. This slurry would be immobilized with a LAW supplemental treatment technology.

Fractional crystallization is a commercially proven process that is typically used for pharmaceuticals (purifying drugs) and industrial chemicals (cleansers, fertilizers, etc.) and works by evaporating feed stocks and selectively forming pure crystalline products (Hamilton 2006b).

Recently, laboratory-scale testing of fractional crystallization was completed in 2005 on simulated tank waste. Phase I laboratory testing of fractional crystallization using simulated waste is part of a two-phase Pretreatment Testing and Demonstration Program designed to determine whether fractional crystallization is a viable supplemental pretreatment process for Hanford medium-curie waste. The laboratory study was conducted by a technical team commissioned by CH2M HILL Hanford Group, Inc., and is composed of COGEMA, Inc., Georgia Institute of Technology, AREVA Framatome ANP, and Swenson Technologies, Inc. The results of the study are presented in **Hanford Medium/Low Curie Waste Pretreatment Project – Phase I Laboratory Report**, dated January 30, 2006 (Hamilton 2006b).

Simulants tested during Phase I of the program represented the following anticipated tank liquid waste streams: (1) Early SST Feed, (2) Late SST Feed, and (3) DST Feed. The purpose of demonstrating feasibility on early feed versus late SST feed is to determine the ability of fractional crystallization to

cope with variability in liquid waste feeds. In general, the fractional crystallization process desires homogenous waste feed. The purpose of using DST tank waste feed simulants is to determine the effects of high aluminum ion content on the process, which typically characterizes DST feed. The higher concentration of aluminum in DST feed may lead to the formation of aluminum-based gels prior to satisfactory sodium recovery. The formation of gels can lead to difficulties in slurry handling (Hamilton 2006b).

The results of the Phase I laboratory scale tests were very favorable for continued development of the technology for potential use on Hanford tank waste. Laboratory-scale tests demonstrated successful exclusion of cesium from crystalline product and successful reduction of sulfate-to-sodium ratios for all three waste simulants, as well as sufficient sodium recovery for both SST feeds, but not quite for the DST feed. Further testing and manipulation of the waste feed pH through reactions involving hydroxyl ions and carbon dioxide reduced the formation of aluminum-based gels and increased sodium recovery. Therefore, unless sodium recovery objectives can be achieved through process design refinements, the pretreatment of waste using fractional crystallization may be limited to SST feed (Hamilton 2006b).

Phase I testing, although found to meet the objectives for cesium exclusion from crystalline product, suggested that some cesium-bearing liquor may become entrapped within inclusions and interstitial spaces of the crystallized salt. It is expected that washing the crystals would remove the cesium residing in the interstitial spaces. However, cesium retained in inclusions would likely remain within the crystal phase (Hamilton 2005). The significance of the effect of inclusions on radioactive separations would need to be evaluated during subsequent laboratory-scale testing.

Continuation of the Pretreatment Testing and Demonstration Program under Phase II occurred in 2006 and 2007. Phase II of the program includes laboratory-scale testing of fractional crystallization on actual radioactive Hanford tank waste and pilot-scale operational testing and integration of process equipment.

A different option, called "clean salt," was considered by the MAI subgroup under two different flowsheet options; however, neither of the clean salt options were selected by the MAI subgroup for further evaluation (CH2M HILL 2003a).

The MAI subgroup evaluated clean salt, assuming that the sodium nitrate product from the clean salt options (without sulfate removal) would be immobilized into a phosphate-bonded ceramic. The strontium sulfate precipitate from the clean salt with sulfate removal options would be incorporated into a grout matrix. The sodium nitrate crystals from the clean salt with sulfate removal options would be immobilized by microencapsulation using a polyethylene polymer (DOE 2003e).

After the tank waste underwent selective dissolution and solid-liquid separations, the liquid waste stream would be sent to an acid reactor where it would be acidified with nitric acid. Acidification neutralizes sodium hydroxide and sodium carbonate, dissolves aluminum hydroxide, and converts all the nitrite to nitrate and nitrogen oxide. The primary form of sodium leaving the acid reactor would be sodium nitrate. Crystallization of sodium nitrate would be performed in two steps. First, the acidified liquid stream would be evaporated at approximately 110 °C (230 °F) at atmospheric pressure until about 50 percent by weight of the sodium nitrate was crystallized out. Second, the liquid stream would be cooled, resulting in the crystallization of another 20 percent by weight of sodium nitrate (Gasper et al. 2002). Fractional crystallization was assumed to be adequate to produce sufficient radionuclide decontamination to meet applicable requirements. Select radioactive components (particularly cesium-137) would be excluded from the crystal matrices, thus yielding a radioactively enriched effluent that can be directed to the WTP process. Because of the inherent ability of this technology to separate radionuclides from the clean salt, a separate ion exchange facility for the removal of cesium and technetium may not be necessary.

The washed crystals would be separated from the filtrate in a solid-liquid separations step and then sent to the immobilization step. Waste sodium nitrate needs to be immobilized because, as a waste form, it does not comply with land disposal restrictions due to its toxicity and ignitability. The key problem identified would be achieving an immobilized waste form for the crystallized sodium nitrate that could meet disposal requirements and did not result in a significant increase in the volume of immobilized waste to be disposed of at Hanford (DOE 2003e).

E.1.3.3.2.3 High-Level Radioactive Waste and Low-Activity Waste Vitrification and Phosphate Glass

It has been proposed that the use of a phosphate glass formula for Hanford waste vitrification would have some advantages over the current baseline borosilicate glass. Hanford tank waste has some chemical constituents that are troublesome to incorporate into the base program ILAW and IHLW borosilicate glasses. The low solubility of sulfate in silicate glasses limits the concentration of sodium oxide in the ILAW glass. Without the sulfate problem, an increase in waste loading would be possible for ILAW glass. Sulfate incorporation and chemical durability have been demonstrated in the laboratory for phosphate glasses formulated for Hanford ILAW. Similarly, for IHLW glass, the chromium solubility limits the waste loading in the baseline borosilicate glass. High chromium content may be incorporated by adding phosphate to the waste feed and operating at 1,200 to 1,250 °C (2,190 to 2,280 °F). Increased waste loading can be accommodated, and the lower viscosity of the resulting melt allows a shorter residence time in the melter. These factors offer the potential for improved IHLW glass throughput at the WTP. This option was not considered for evaluation in this TC & WM EIS because the phosphate glass formula has not been proven to be compatible with production-scale melters, and the resulting product glass has not been shown to meet the waste acceptance technical requirements for DOE's Civilian Radioactive Waste Management System (DOE 2007).

E.1.3.3.2.4 Preprocessing Tank Waste with a Plasma Mass Separator (Archimedes Technology)

DOE, as part of the accelerated cleanup program, issued a Request for Information in October 2003 seeking data on potential HLW processing options. The Request for Information targeted technical application areas for enhanced separation process, low-temperature immobilization, thermal immobilization, waste retrieval, and tank closure. The Archimedes Technology Group provided a response to the Request for Information.

The plasma mass separation process physically separates elements based on their atomic mass. The process relies on the physics of rotating plasmas to establish a so-called "mass cutoff," which is indifferent to the complexity of waste input. Elements with an atomic mass unit above the mass cutoff are simply sent in one direction, while elements below the cutoff are sent in another.

Waste is injected into a vacuum chamber. Radio frequency power converts the injected material into a plasma (an atom transforms into a plasma state when an outer electron leaves its atomic orbit). The resulting positively charged ions in the plasma respond to electric and magnetic forces. Electric and magnetic fields combine to rotate or spin the plasma much like these two force fields spin an electric motor. When the plasma rotates at high speeds, the magnetic and electric fields can be adjusted to create a mass cutoff that keeps light ions confined to the plasma while heavy ions rotate instantaneously to the side wall collector.

This TC & WM EIS does not evaluate preprocessing tank waste with a plasma mass separator due to the present immaturity of the technology. The project team recommended that DOE conduct further testing and demonstration of the process and a thorough evaluation of the business model prior to considering implementation. The Archimedes Technology Group is currently implementing a demonstration program for processing Hanford tank waste (DOE 2003e).

E.1.3.3.2.5 Additional Technologies

Section B.9.0 of the TWRS EIS includes additional potentially viable pretreatment and immobilization technologies that are available for use should they prove to be technically viable and perform within the bounds of the environmental impacts to be addressed in this TC & WM EIS.

Some technologies were rejected from further analysis because of the inability to adequately treat Hanford waste. For example, in situ (in place) vitrification was eliminated for consideration as an option for supplemental treatment because vitrification of the tank waste in situ (in the tanks) would not achieve the objective of removing 99 percent of the waste from the tanks (DOE 2003e).

E.1.3.4 Disposal

Options for offsite disposal of ILAW glass (MLLW) and secondary waste (LLW and MLLW) and onsite disposal of the HLW melter taken out of service were considered. The following sections provide information about these disposal options and the reasons they are not included in the alternatives analyzed in this TC & WM EIS.

E.1.3.4.1 ILAW Glass and Secondary Waste Disposal

A primary advantage of the offsite disposal of ILAW glass (MLLW) and secondary waste (LLW and MLLW) from tank waste treatment would be that it would not require construction, operation, and closure of waste disposal facilities at Hanford. The **Final Waste Management Programmatic Environmental Impact Statement for Managing Treatment, Storage, and Disposal of Radioactive and Hazardous Waste (WM PEIS)** (DOE 1997a) provided analysis of potential environmental impacts of broad alternatives for DOE's waste management program to provide a basis for DOE decisions on programmatic configurations of sites for waste management activities. One of DOE's decisions based on the WM PEIS addressed disposal of LLW and MLLW—DOE decided that Hanford would dispose of its own LLW and MLLW on site (65 FR 10061). As a result, the option of disposing of these wastes offsite was eliminated from further consideration in this EIS.

E.1.3.4.2 High-Level Radioactive Waste Melter Disposal

Onsite disposal of the HLW melter taken out of service was considered. WTP HLW melter taken out of service would be packaged within an overpack at the WTP. The overpack would provide shielding and confinement. The overpack's overall dimensions would be 5.29 meters wide by 5.29 meters long by 4.38 meters high (17.4 feet wide by 17.4 feet long by 14.4 feet high). The overpack containing a melter would weigh approximately 263 metric tons, and the dose rate at 30 centimeters (11.8 inches) from the overpack surface would be less than 16 millirem per hour (Lowe and Haigh 2003).

Since the HLW melter have not been installed or operated, a high degree of uncertainty exists about their operation, lifespan, waste characterization, and waste classification. As a result, this TC & WM EIS assumed a conservative (i.e., economical and with consideration of the human health impacts of melter storage, transportation, and disposal) disposition of the melter; the HLW melter would be stored on site until disposition decisions are made and implemented. Thus, onsite disposal was eliminated from further consideration in this EIS.

E.1.3.5 Tank System Closure

Several technologies providing in situ soil remediation and alternatives to support tank farm closure were considered, but not selected for detailed analysis in this TC & WM EIS. The following provides an overview of these technologies and the rationale for not analyzing each.

E.1.3.5.1 Subsurface Barriers

Underground containment barriers could be an important method for limiting and/or eliminating the movement of contaminants through the subsurface and minimizing impacts on human health and the environment. Subsurface barriers could contain the volume of waste and reduce the potential for migration through the vadose zone and into the groundwater.

Many subsurface barrier technologies are commercially available and others are in various stages of development. The purpose and function of the subsurface barrier system must be determined prior to designing and constructing the barrier. Site characterization is an essential part of choosing an appropriate barrier.

Several factors should be considered when designing a subsurface barrier. First, it is important to establish the barrier geometry (e.g., alignment, depth, and thickness). Second, a stress-deformation analysis should be performed on the surrounding area to assess the potential impacts of barrier construction. Third, compatibility testing must be done to select the most effective barrier materials and, when necessary, appropriate mixture combinations. Fourth, it is necessary to determine the most effective and feasible construction methods. Finally, construction quality assurance/quality control, along with monitoring, is a crucial component of subsurface barrier design.

Construction quality assurance and quality control are essential for the successful design, implementation, and performance of subsurface barrier systems. Different types of subsurface barriers have different construction quality control criteria; however, there are two primary concerns. First, the installed barrier must have a hydraulic conductivity equal to or less than that specified in the design. The second concern is barrier continuity.

The use of subsurface barriers in the vadose zone below and around the sides of Hanford SSTs has previously been evaluated. Two types of potential installations were studied: “close-coupled” and “mega” (massive) applications. Barrier installation would be difficult because of the proximity to other tanks; application of close-coupled barriers would therefore be limited. Installation of mega subsurface barriers would cocoon entire tank farms. In addition, upon construction of the subsurface barrier, no method is available to measure the completeness of the subsurface barrier or methods to determine how much leaks through.

Previous studies to evaluate, among other things, the application of existing subsurface barriers and their potential for the reduction of environmental impacts have concluded the following.

- The use of subsurface barrier concepts in general tank farm applications would result in only a small reduction of the risk associated with waste retrieval, tank stabilization, and surface barrier technologies.
- Uncertainty about the performance of subsurface barriers (e.g., verification of placement and performance in immobilizing contaminants) is high.
- Potential risks to workers involved in implementing subsurface barrier alternatives increase by factors of up to 15 compared to those of surface barriers and waste retrieval.

Recent developments regarding the use of reactive barriers in soils to immobilize contaminants appear promising. However, detailed evaluation of reactive barriers for closure of Hanford tanks is not practical because limited information is currently available for this application (DOE 2003b).

E.1.3.5.2 In Situ Soil Remediation

In situ (in place) methods that are generally less expensive and disruptive to the natural landscape, hydrology, and ecosystems than conventional excavation, treatment, and disposal methods are options for soil remediation. The main advantage of in situ remediation is that it allows soil to be treated without being excavated and transported. Consequently, in situ remediation offers a likely reduction of environmental disturbance and personnel exposure to hazardous materials. However, in situ treatment generally requires long periods of time; there is uncertainty about the uniformity of treatment because of the variability in soil and aquifer characteristics; and the efficacy of the process is difficult to verify. In situ soil remediation of metals and radionuclides using inexpensive additives such as minerals (apatite, zeolite, or clay minerals) or waste byproducts (steel shot, beringite, or iron-rich biosolids) is a promising alternative to current remediation methods. In situ remediation techniques rely on a fundamental understanding of the natural geochemical processes governing the speciation, migration, and bioavailability of metals and radionuclides in the environment. In contaminated soils, metals and radionuclides can be dissolved in solution, held on inorganic soil particles, complexed with organic soil components, or precipitated as pure or mixed solids. Soluble contaminants are subject to migration with soil water, uptake by plants, or loss due to volatilization into the atmosphere. Metals and radionuclides in soil may be associated with various phases that are reactive, semireactive, or nonreactive. Soil amendments used with in situ remediation techniques decrease the mobility of metals and radionuclides by increasing retention in the nonmobile solid phase.

Although numerous methods exist or are being developed for the in situ remediation of contaminated soils, their application can be problematic. The primary mechanism for contaminant migration in the vadose zone under arid site conditions typical of Hanford is the infiltration of precipitation. Consequently, properly designed and constructed surface covers offer the greatest control of water infiltration and ultimate protection of human health and the environment. A variety of in situ soil remediation technologies were considered and subsequently rejected because of difficulties and uncertainties associated with the placement of treatment zones and their performance verification.

The majority (greater than 90 percent) of the radioactivity in Hanford tanks can be attributed to strontium-90, cesium-137, and their daughter compounds. These radioactive contaminants are relatively insoluble, tend to be trapped in the soil matrix, are not easily transported by groundwater movement, and tend to remain in localized areas. Although small in terms of total inventory, mobile, long-lived radionuclides present the greatest concerns from a groundwater risk perspective. The primary mobile, long-lived COPCs are technetium-99, iodine-129, neptunium-237, and uranium-238.

Factors that contribute to the difficulty in performing in situ remediation of contaminated soils include location; identification and quantification of the contaminants listed above; site lithology, geology, and hydrology; and the differing properties of the contaminants within the soil structure and matrix. The remediation technology for each selected COPC can be highly specialized, emphasizing the need for selectivity. Generally speaking, no single technology can remediate an entire site because multiple contaminants, both organic and inorganic, as well as soil and groundwater, can be involved. Several treatment technologies must be typically combined at a single site to form an effective treatment train (DOE 2003b).

Three primary strategies are typically used separately or in combination to achieve remediation of most sites. These strategies are as follows:

- Destruction or alteration of contaminants
- Extraction or separation of contaminants from environmental media
- Immobilization of contaminants

Available in situ soil remediation technologies include various chemical, physical, and biological treatment methods including, but not limited to, the following:

- In situ vapor extraction
- In situ solidification/stabilization
- In situ bioremediation
- In situ bioventing and biosparging
- In situ soil washing/flushing
- In situ vitrification
- In situ electrochemical remediation
- In situ reduction-oxidation control
- In situ enhanced soil mixing

While these treatment technologies can be effectively used for in situ remediation of contaminated soils, only solidification/stabilization, soil washing/flushing, and vitrification are commonly applied to the in situ treatment of radioactive materials and heavy metals (the primary contaminants at Hanford). In situ reduction-oxidation control has been demonstrated for some heavy-metal remediation and has potential application to soils contaminated with radioactive materials. Other in situ remediation technologies are better suited to work with halogenated volatiles and semivolatiles, nonhalogenated volatiles and semivolatiles, polychlorinated biphenyls (PCBs), pesticides, and cyanides.

The potential applicability of land disposal restrictions to waste left in the tanks after closure and to the contaminated soil that remains in place is an important area of regulatory uncertainty. The “Land Disposal Restrictions” (40 CFR 268) impose strict requirements on waste management operations and environmental restoration activities at DOE sites. Under the land-disposal-restriction regulatory framework, the disposal of RCRA hazardous waste in or on land is prohibited unless the waste has been treated to meet applicable treatment standards or it has been demonstrated to a reasonable degree of certainty that there would be no migration of hazardous constituents from the disposal unit or injection zone for as long as the waste remains hazardous (i.e., a “no-migration” petition [40 CFR 268.6]) (DOE 2003b).

For mixed waste, the hazardous components are subject to regulation under RCRA, while the radioactive components are regulated by the Atomic Energy Act of 1954. Because RCRA requirements apply to the hazardous portion of the waste, mixed waste may be subject to the land disposal restrictions. Uncertainties in the ability to verify in situ soil remediation technology placement and subsequent performance make it difficult to demonstrate compliance with the no-migration requirements.

If land disposal restrictions are determined to be applicable to tank waste residuals and contaminated soils, and the waste cannot be treated to meet a total concentration level or the treatment technology is not appropriate for the waste, DOE could petition for a variance from the treatment standards. A treatability variance does not remove the requirement to treat waste residuals and contaminated soil. Rather, alternative treatment standards based on data from actual treatment of soils and waste residuals become the treatment standard that must be met (DOE 2003b).

E.1.3.5.3 Gravel Filling of Tanks

After stabilizing the residual waste, filling the void spaces in the tanks with gravel could be used as an alternative to grouting to stabilize the tanks structurally. This process would use a gravel slinger to uniformly distribute sized, crushed rock throughout the tank, including the tank dome. This commercially proven technology is used to fill ship holds and silos with materials such as grain or cement. Tests performed at Hanford have verified the use of this technology with local materials in a tank-like environment.

Gravel would be distributed in the tank with a slinger, a mechanism suspended in the tank from the center riser. The slinger would capture gravel on a fast-moving horizontal belt, then throw it as it is slowly rotated. The belt speeds, belt angle, gravel feed rate, and rotational speed would be the primary controlling parameters. A hopper, mounted directly above the slinger, would be fed from the conveyor system and, in turn, would feed the slinger through a quick-acting isolation valve.

Tank conditions could require more than one slinger in a tank. The availability of existing risers versus the difficulty of installing new risers also could drive the decision to use more than one slinger. These somewhat smaller slingers could operate like the larger, center-mounted unit. For the purposes of this analysis, it is assumed that all tanks would use a larger, center-mounted unit. Sacrificial material vibrators could be strategically placed within the tanks to ensure maximum fill for critical areas.

While it is clear that the gravel filling option would adequately stabilize the tank structurally, the gravel would not prevent water intrusion and possible mobilization of contaminants from stabilized residual waste. In addition, the option of placing grout in the tanks to prevent structural subsidence represents the most conservative estimate for commitment of resources and was used to analyze the alternatives in this TC & WM EIS (DOE 2003b).

E.2 FAST FLUX TEST FACILITY DECOMMISSIONING

E.2.1 Fast Flux Test Facility Background

The FFTF is a DOE-owned, formerly operating, 400-megawatt (thermal) liquid-metal (sodium)-cooled research and test reactor located in the 400 Area of Hanford near the city of Richland, Washington (Figures E-35 and E-36). A detailed description of the FFTF complex is provided in **Technical Information Document for the Fast Flux Test Facility Closure Project Environmental Impact Statement** (Fluor Hanford 2005c).

The purpose of the facility was to develop and test advanced fuels and materials for the Liquid Metal Fast Breeder Reactor Program (FFTF is a liquid-metal reactor) and to serve as a prototype facility for future Liquid Metal Fast Breeder Reactor Program facilities; other missions were subsequently pursued. Construction of the FFTF was completed in 1978. Initial criticality was achieved on February 9, 1980, and full power was initially achieved on December 21, 1980. Following an additional year of extensive acceptance testing, FFTF operated safely and successfully from 1982 to 1992 and provided the nuclear industry with significant advances in fuel performance, medical isotope production, materials performance, and passive and active safety system testing. In December 1993, DOE decided to discontinue FFTF operations because of a lack of economically viable missions at that time and issued a shutdown order for FFTF.



Figure E–35. Fast Flux Test Facility

In May 1995, DOE prepared the 1995 EA (DOE 1995), evaluating the potential impacts associated with actions necessary to place the FFTF in a radiologically safe and industrially safe permanent shutdown and deactivation condition (Phase I), suitable for long-term S&M (Phase II) prior to decommissioning (Phase III). The 1995 EA did not evaluate Phase III. DOE determined that an EIS was not required for the permanent shutdown and deactivation of the FFTF and issued a Finding of No Significant Impact (FONSI) in May 1995.

In January 1997, DOE decided to maintain FFTF in standby pending an evaluation of a future role in DOE’s national tritium production strategy. In December 1998, DOE decided FFTF should not play a role in production of the nation’s tritium stockpile. Facility deactivation work continued under the 1995 EA, limited to activities that would not preclude reactor restart.

In December 2000, DOE published the **Final Programmatic Environmental Impact Statement for Accomplishing Expanded Civilian Nuclear Energy Research and Development and Isotope Production Missions in the United States, Including the Role of the Fast Flux Test Facility** (NI PEIS, DOE/EIS-0310F) (DOE 2000). This NI PEIS evaluated the role of FFTF as an alternative nuclear irradiation services facility to accomplish civilian nuclear energy R&D, medical and industrial radioisotope production, and production of plutonium-238 to support future National Aeronautics and Space Administration space exploration missions. Also evaluated was an alternative to permanently deactivate the FFTF. Based on the NI PEIS, DOE decided in the NI PEIS ROD (66 FR 7877, January 26, 2001) that permanent deactivation of FFTF was to be resumed, with no new missions. Since that time, deactivation has continued, consistent with the 1995 EA and FONSI and the 2000 NI PEIS and 2001 NI PEIS ROD.

Draft Tank Closure and Waste Management Environmental Impact Statement for the Hanford Site, Richland, Washington

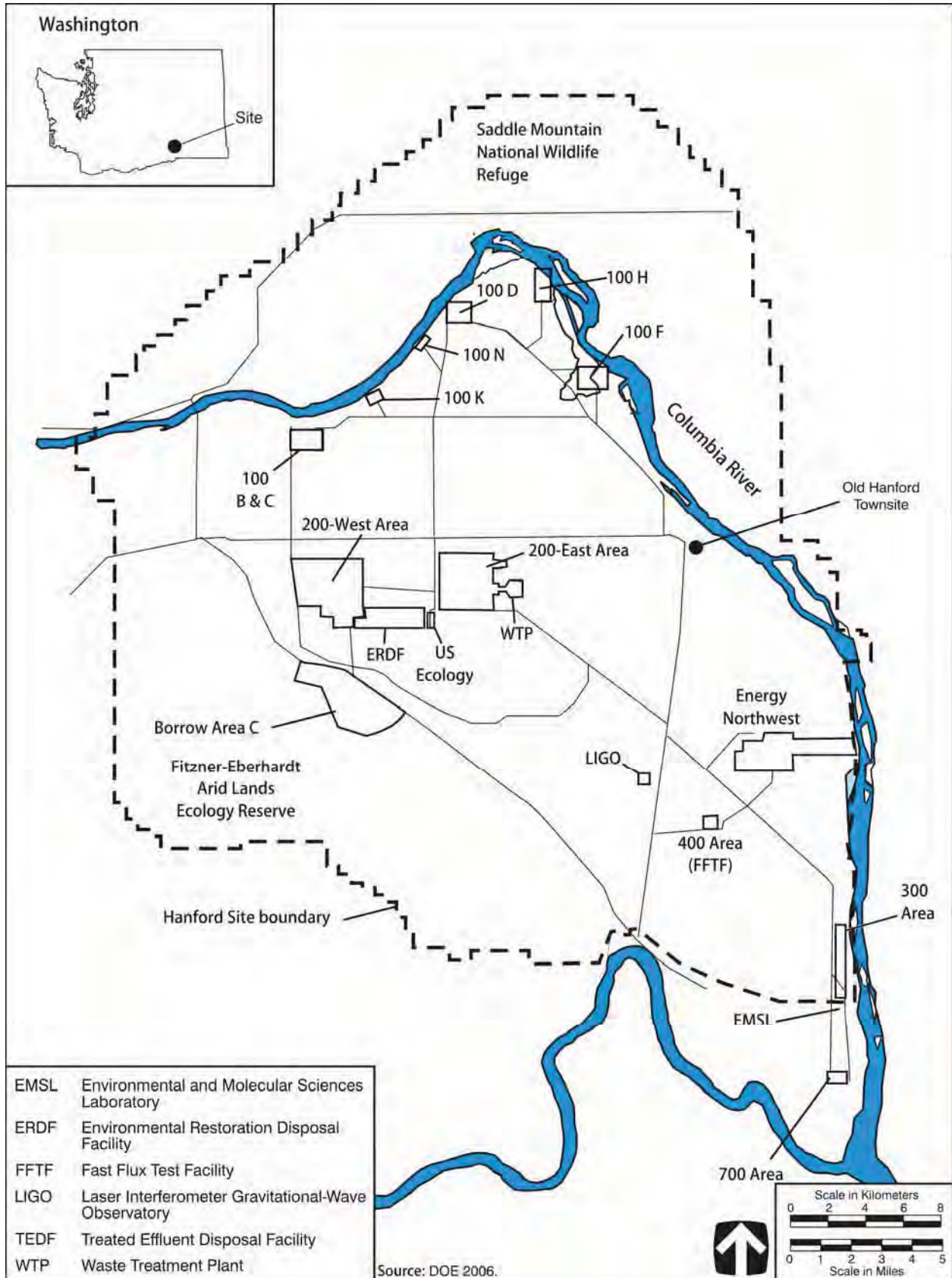

Figure E-36. Hanford Site

In December 2003, DOE issued a final request for proposals to “clean up and take down” the FFTF complex. On December 22, 2005, DOE cancelled the solicitation for the Hanford Site FFTF Closure Project. Cancellation of the solicitation was deemed necessary because of budget constraints and the need to support higher-risk/higher-priority Hanford cleanup projects. In February 2006, DOE announced its intention to prepare a TC & WM EIS for Hanford (71 FR 5655). DOE decided to merge the scope of the proposed but cancelled “FFTF Decommissioning EIS,” described in DOE’s Notice of Intent (69 FR 50176), to further coordinate resources and ensure a comprehensive look at environmental impacts at Hanford. In this TC & WM EIS, the potential decision for final D&D of FFTF would identify the final end-state for the above-ground, below-ground, and ancillary support structures.

In March 2006, DOE published the **Environmental Assessment, Sodium Residuals Reaction/Removal and Other Deactivation Work Activities, Fast Flux Test Facility (FFTF) Project, Hanford Site, Richland, Washington** (DOE 2006). This EA was an interim action that examined the environmental consequences on an expanded deactivation work scope that were previously analyzed in the 1995 EA to evaluate a different approach to sodium residuals management. The 1995 EA provided the foundation for most of the analyses of environmental impacts included in the 2006 EA, which evaluated potential additional environmental impacts. There had been relatively minor changes in environmental conditions at the 400 Area of Hanford since 1995. The affected environment is described in Section 3.0 of the 2006 EA and updates the description provided in the 1995 EA (as documented in current 2005 reviews of Hanford environmental conditions). As such, the 2006 EA supplements or adds to the 1995 EA analysis of deactivation actions. Under the criteria of 40 CFR 1500–1508, these actions are not expected to have adverse environmental impacts or limit the choice of reasonable alternatives under consideration in the pending TC & WM EIS (DOE 2006).

DOE proposed a different approach to accomplish the ongoing deactivation work at FFTF that was not extensively discussed and analyzed in the 1995 EA. DOE proposed to remove radioactively contaminated sodium residuals left over from the drain of Hanford’s radioactively contaminated sodium inventory (FFTF, Hallam Reactor, and Sodium Reactor Experiment [SRE]) by reacting the sodium metal with water (as superheated steam) to produce caustic sodium hydroxide solution; remove associated equipment/components to allow removal of the sodium; and remove, dispose of, and stabilize miscellaneous hazards and waste streams left over from the sodium drain. These activities would further support low-cost, environmentally safe, S&M activities at FFTF.

Some of the specific issues discussed and evaluated in the 2006 EA include the following (DOE 2006):

- The use of the superheated steam process in-place or at designated cleaning locations to remove sodium residuals. [Superheated steam occurs when steam is superheated well above the boiling point of water before being injected into the preheated equipment/components (e.g., piping, valves, tanks, etc.) at controlled rates.]
- The locations where the reaction of sodium or sodium residuals associated with the sodium systems and equipment can be performed (e.g., in-place or at designated cleaning locations).
- The use of alternative technology(s) in select situations for small-scale reaction of sodium residuals.

**Draft Tank Closure and Waste Management Environmental Impact Statement for the
Hanford Site, Richland, Washington**

Other deactivation work activities discussed and evaluated in the 2006 EA include removal of associated equipment/components to facilitate removal of the sodium residuals and removal, disposition, and stabilization of miscellaneous hazards and waste streams resulting from the sodium drain. These activities include the following (DOE 2006):

- Clean in-place vessels, components, and large-bore pipe (greater than or equal to 20.3-centimeter diameter [8-inch diameter]) in primary and secondary sodium cooling systems.
- Remove small-bore pipe (less than 20.3-centimeter diameter [8-inch diameter]), valves, and other components for reaction in a cleaning station.
- Remove large components for cleaning.
- Remove and package FFTF RH-SCs (primary cold trap, cesium trap, and two vapor traps) for storage in the 400 Area pending final disposition.
- Remove/dispose of asbestos.
- Remove/stabilize existing hazards in conjunction with deactivating systems and equipment associated with sodium residuals.
- Remove/recycle/dispose of excess deactivated equipment and components as necessary.
- Remove depleted uranium and/or lead shielding for recycling, reuse, or storage in the 400 Area.

On March 31, 2006, DOE issued a FONSI (DOE 2006:Appendix B) containing the following conclusion:

“Based on the analysis in the EA, and considering preapproval comments received (Appendix A of DOE/EA-1547F [the 2006 EA]), DOE has determined that the proposed action is not a major federal action significantly affecting the quality of the human environment within the meaning of the “**National Environmental Policy Act of 1969 (NEPA), 42 U.S.C. 4321, et seq.**” Therefore, the preparation of an Environmental Impact Statement (EIS) is not required.”

In addition, the FONSI stated:

“The DOE/EA-1547F [the 2006 EA] does not address FFTF decommissioning activities, i.e., final end state of the FFTF. That scope of work will be addressed in the Tank Closure and Waste Management Environmental Impact Statement” (DOE 2006:Appendix B).

Since June 2007, major deactivation activities underway at FFTF have included preparing fuel for shipment offsite and deactivating auxiliary plant systems. Approximately 916,000 liters (242,000 gallons) out of the 958,000 liters (253,000 gallons) of radioactively contaminated bulk sodium have been drained from the FFTF reactor vessel, three primary and three secondary heat transport system loops, the Fuel Storage Facility, and the interim decay storage vessel and associated auxiliary systems and transferred to the Sodium Storage Facility (SSF), which is adjacent to FFTF. Associated trace heat systems have been de-energized (Chapin 2007). See Chapter 3, Section 3.2.13, for status of FFTF SNF.

E.2.2 Fast Flux Test Facility Description

The existing buildings and structures within the FFTF complex are identified in Table E-12 which includes the Reactor Containment Building (RCB), reactor support buildings, and auxiliary buildings. The RCB is a large round building measuring 41.1 meters (135 feet) in diameter with a domed roof. The building rises 56.7 meters (186 feet) above grade and extends 24 meters (78 feet) below grade. The RCB

Appendix E • Descriptions of Facilities, Operations, and Technologies

is constructed from carbon steel, reinforced concrete, and magnetite concrete used for shielding. The numerous reactor and auxiliary buildings are primarily steel frame buildings with metal siding on reinforced-concrete foundations or pads. Other structures are also associated with FFTF, including storage tanks, electrical/power transformer substations, and cooling towers. The SSF and the Fuel Storage Facility are also a part of FFTF. Figure E–37 is a map of the FFTF complex and associated facilities.

This TC & WM EIS includes alternatives for final disposition of all these buildings and associated structures, as well as the bulk sodium material in the SSF. It does not, however, include disposition of the fuel stored in the Fuel Storage Facility. Previous NEPA documentation addresses the alternatives for handling and disposition of the fuel removed from FFTF (Fluor Hanford 2005c).

Table E–12. Fast Flux Test Facilities and Structures

| Building Number | Building Name | Equipment | Construction Materials |
|----------------------------------|--|--|--|
| 405 | Reactor Containment Building | Reactor vessel, maintenance and storage cells, sodium-cooling system, inert cover gas system | Carbon steel, reinforced concrete, magnetite concrete (shield) |
| Reactor Support Buildings | | | |
| 4703 | FFTF Control Building | Reactor control room, telephone and computer equipment, offices, etc. | Reinforced concrete, steel frame, metal-and-concrete roof and siding |
| 4621E | Auxiliary Equipment Building, East | Plant control and auxiliary equipment, radiation monitoring, access control, diesel generator | Steel frame, metal siding above, reinforced concrete below |
| 4621W | Auxiliary Equipment Building, West | Electrical switchgear and equipment, diesel generator | Steel frame, metal siding above, reinforced concrete below |
| 491E | HTS Service Building, East | Secondary sodium piping, pumps, switchgear controls, and equipment | Steel frame, metal siding above, reinforced concrete below |
| 491W | HTS Service Building, West | Secondary sodium piping, pumps, switchgear controls, and equipment | Steel frame, metal siding above, reinforced concrete below |
| 491S | HTS Service Building, South | Primary sodium-sampling equipment, small hot cell, cesium trap, cover gas sampling, decontamination, inert gas cooling | Steel frame, metal siding above, reinforced concrete below |
| 408A | HTS Dump Heat Exchanger, East | Heat exchanger modules, fans, motors, secondary sodium piping | Reinforced concrete, steel frame, metal siding (tornado-hardened) |
| 408B | HTS Dump Heat Exchanger, South | Heat exchanger modules, fans, motors, secondary sodium piping | Reinforced concrete, steel frame, metal siding |
| 408C | HTS Dump Heat Exchanger, West | Heat exchanger modules, fans, motors, secondary sodium piping | Reinforced concrete, steel frame, metal siding |
| 409A | Closed Loop Heat Dump, East 1 | Sodium-to-air forced-convection heat exchangers (never operational) | Steel frame, metal siding |
| 409B | Closed Loop Heat Dump, East 2 | Sodium-to-air forced-convection heat exchangers (never operational) | Steel frame, metal siding |
| 4717 | Reactor Service Building | Cask loading, radioactive gas and waste management | Steel frame, metal siding above, reinforced concrete below |
| 403 | Fuel Storage Facility | Spent nuclear fuel storage vessel and associated sodium potassium heat exchangers | Steel frame, metal siding above, reinforced concrete below |
| 402 | Sodium Storage Facility | Storage vessels for secondary and primary sodium coolant | Reinforced concrete |
| 484 | FFTF In-Containment Chiller Water Equipment Building | Chiller units, pumps, tanks, piping | Steel frame, metal siding, on reinforced-concrete pad |
| 483 | Cooling Towers Chemical Addition Building | Eight modular, forced-draft, evaporative, closed-loop cooling towers and adjacent chemical addition building | Modular cooling towers on reinforced-concrete pad |
| 4716 | FFTF Rigging Loft | Maintenance equipment and tool storage | Steel frame, metal siding |
| 4721 | FFTF Emergency Turbine Generator Building | Oil-fired turbine generator and switchgear, fuel oil storage tank | Reinforced concrete (tornado-hardened) |
| 451A | Substation | Electrical substation and associated equipment | Concrete pads |

**Draft Tank Closure and Waste Management Environmental Impact Statement for the
Hanford Site, Richland, Washington**

Table E-12. Fast Flux Test Facilities and Structures (continued)

| Building Number | Building Name | Equipment | Construction Materials |
|----------------------------|--|---|--|
| Auxiliary Buildings | | | |
| 432A | Interim Covered Equipment Storage | Storage of fuel cask handling equipment | Steel frame, metal siding |
| 4718 | 400 Area Interim Storage Area | Spent nuclear fuel cask storage area | Concrete pad with perimeter fence and lighting |
| 436 | Training Facility | Classrooms, reactor control room simulator | Wood frame, composite siding |
| 437 | Maintenance & Storage Facility | Multipurpose maintenance and storage, equipment testing, training, equipment decontamination, sodium cleaning, radioactive liquid storage | Steel frame, metal siding |
| 440 | 90-day Storage Pad | Hazardous waste storage | Steel frame, metal siding, concrete foundation |
| 453A | Transformer Station, East DHX A1 2.4kV | Transformer support pad | Concrete |
| 453B | Transformer Station, South DHX A2 2.4kV | Transformer support pad | Concrete |
| 453C | Transformer Station, West DHX A3 2.4kV | Transformer support pad | Concrete |
| 480A | Water Supply Well House (P-14) | Well pumps and chlorination equipment | Wood frame, aluminum siding |
| 480B | Water Supply Well House (P-15) | Well pumps and chlorination equipment | Wood frame, aluminum siding |
| 480D | Water Supply Well House (P-16) | Well pumps and chlorination equipment | Concrete masonry |
| 482A | Water Storage Tank (T-58) | Water supply storage | Tank on reinforced-concrete foundation |
| 482B | Water Storage Tank (T-87) | Water supply storage | Tank on reinforced-concrete foundation |
| 482C | Water Storage Tank (T-330) | Water supply storage | Tank on reinforced-concrete foundation |
| 481 | Water Pump House | Distribution pumps for 400 Area water supply | Concrete masonry |
| 481A | Water Pump House | Distribution pumps for 400 Area water supply | Concrete masonry |
| 4842B | Switchgear Building for Pump Houses | Switchgear for well pumps and associated equipment | Wood frame, metal siding |
| 4701 | Kentucky Boulevard Guard Building | Security, access control to 400 Area Property Protected Area | Wood frame, composite siding, concrete masonry |
| 4710 | FFTF Office Building | Offices for operations and support staff | Wood frame, composite siding |
| 4713A | Riggers & Drivers Operations Facility | Offices for maintenance staff | Steel frame, metal siding |
| 4713B | FFTF Maintenance Shop | Maintenance operations | Shop: steel frame, metal siding Annex: wood frame, composite siding |
| 4713C | Contaminated Storage Warehouse | Equipment storage | Steel frame, metal siding |
| 4713D | Interim Maintenance and Storage Facility | Maintenance operations, equipment storage | Steel frame, metal siding |
| 4734A | FFTF Argon/Nitrogen Dewar Pad | Mounting and foundation for gas storage tanks | Concrete |

Note: To convert meters to feet, multiply by 3.281.

Key: DHX=Dump Heat Exchanger; FFTF=Fast Flux Test Facility; HTS=Heat Transport System; kV=kilovolt.

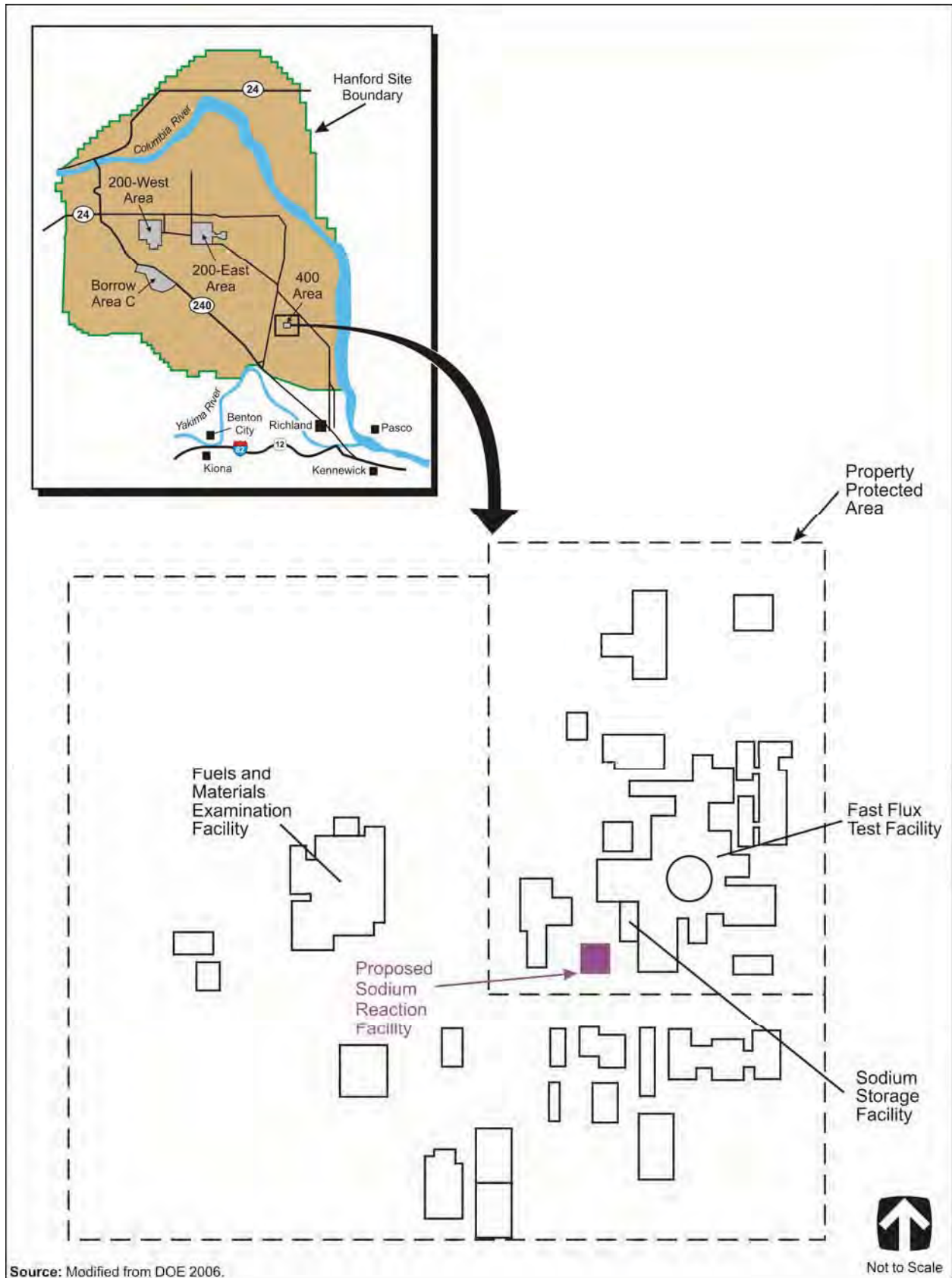

Figure E-37. Fast Flux Test Facility and Associated Facilities Location

E.2.3 Summary Description of FFTF Decommissioning Alternatives

DOE needs to decommission FFTF and its support facilities at Hanford, to manage waste associated with decommissioning the facilities, including certain FFTF wastes designated as RH-SCs, and to disposition the radioactively contaminated bulk sodium inventory at Hanford. Those actions are necessary to protect human health and the environment, facilitate cleanup at Hanford, take actions consistent with decisions reached by DOE as a result of previous NEPA reviews (DOE 1995, 2000; 66 FR 7877), comply with Federal and Washington State laws and regulations, and meet enforceable milestones established in the TPA (Ecology, EPA, and DOE 1989, 2002, 2003).

To address anticipated needs for decommissioning FFTF, DOE proposes to complete the following actions:

- Decommission FFTF and associated support facilities within the Property Protected Area (PPA) at the Hanford 400 Area, including management of radioactive and hazardous wastes using existing capabilities.
- Manage certain FFTF wastes designated as RH-SCs using management capabilities that do not currently exist at Hanford or elsewhere.
- Disposition the inventory of radioactively contaminated bulk sodium resulting from deactivation of FFTF, as well as sodium from the Hallam Reactor and the SRE that is now in storage at the Hanford 200-West Area.

Alternatives for accomplishing these proposed actions are described below. A No Action Alternative is also evaluated as required by NEPA.

- **Demolition of the facilities within the 400 Area of Hanford.** Demolition of all or part of the facilities in the 400 Area would be required under each of the alternatives evaluated in this TC & WM EIS, except for the No Action Alternative. Demolition would result in radioactive and chemically hazardous waste requiring disposal. Disposal of the bulk of this demolition waste would occur on site in disposal facilities approved for Hanford's operational waste (e.g., an onsite IDF). Waste volumes would vary among the alternatives. This TC & WM EIS provides the environmental impact information needed for DOE to make informed decisions regarding preferred alternatives based in part on waste volumes generated, worker safety and other environmental risks/impacts, appropriate D&D technologies, and disposal requirements (e.g., appropriate modified RCRA Subtitle C, D, or other barrier designs).
- **Management and disposition of radioactively contaminated bulk sodium.** FFTF reactor coolant systems and storage vessels contained about 984,200 liters (260,000 gallons) of radioactively contaminated sodium. Management and disposition of this sodium, along with about 128,700 liters (34,000 gallons) and about 26,500 liters (7,000 gallons) of radioactive sodium from the Hallam Reactor and SRE, are addressed in this TC & WM EIS. Additionally, radioactively contaminated piping and other general demolition wastes would result from decommissioning FFTF. Processing the radioactively contaminated bulk sodium coolant from FFTF, as well as sodium from the Hallam Reactor and SRE, is required under the scope of the FFTF decommissioning actions. This TC & WM EIS analyzes the following two options, in addition to the No Action Alternative, for processing this bulk sodium.
 - Hanford Reuse Option: Store the bulk sodium on site at Hanford until a new Sodium Reaction Facility (SRF) is built and the sodium can be processed into a caustic sodium hydroxide solution for product reuse by ORP for the WTP or Hanford tanks corrosion

control. This alternative requires permitting and construction of a new facility to convert the reactive radioactive sodium to a caustic sodium hydroxide solution on site at Hanford.

- Idaho Reuse Option: Prepare and ship the sodium to INL (formerly Idaho National Engineering and Environmental Laboratory [INEEL]) for processing into a caustic sodium hydroxide solution and shipment back to Hanford for product reuse by ORP for the WTP or Hanford tanks corrosion control. This alternative requires that the Sodium Processing Facility (SPF) at INL's Materials and Fuels Complex (MFC) (formerly Argonne National Laboratory-West) be restarted and available for use when required.

In May 2007, the **Hanford Site Sodium Disposition Evaluation Report** (Burke 2007) was issued to document current planning by the TPA agencies for the management and disposition of the radioactively contaminated bulk sodium currently stored at Hanford. Based on planning at the time the document concluded that conversion of the sodium to caustic sodium hydroxide solution would not utilize the SPF located at INL and anticipated construction of a new conversion facility adjacent to the SSF located in the 400 Area. However, the document also noted that it does not preclude or predetermine sodium management decisions to be reached in the DOE NEPA TC & WM EIS ROD thus, DOE has decided to retain for analysis purposes the option of processing the Hanford radioactively contaminated bulk sodium at the INL SPF.

Descriptions of the SRF and SPF can be found in Sections E.2.4.2 and E.2.4.3, respectively. This EIS provides the environmental impact information for DOE's programmatic decisions on whether to transport the sodium to the SPF at INL's MFC or to permit and construct a new facility, the SRF, at Hanford for processing the bulk sodium.

- **Management and disposition of the FFTF RH-SCs.** Currently, no facility exists within the DOE complex for handling or treating the RH-SCs. DOE has proposed construction of a new facility, the Remote Treatment Project (RTP), at INL's MFC. The **Idaho National Engineering and Environmental Laboratory Site Treatment Plan** and Consent Order milestones mandate that the RTP begin waste operations in 2011 (ANL-W 2004; INEEL 2001). The analyses in this TC & WM EIS evaluate two options for processing the RH-SCs in addition to the No Action Alternative, as follows:
 - Idaho Option: Removal and shipment of the RH-SCs to INL for treatment in the proposed RTP, followed by shipment and disposal at either NTS or Hanford.
 - Hanford Option: Removal and storage on site at Hanford until a new facility (RTP) is permitted and built, followed by disposal at Hanford.

A description of both of these facilities can be found in Section E.2.4.4. This EIS provides the environmental impact information on both options for disposition of RH-SCs to allow DOE to make informed, programmatic decisions on RTP construction, location, and operation with respect to the FFTF RH-SCs, as well as other materials requiring remote handling and processing.

E.2.3.1 FFTF Decommissioning Alternative 1: No Action

Council on Environmental Quality regulations requires that NEPA analyses include a No Action Alternative. Under this alternative, deactivation of the FFTF complex and support buildings would be completed as specified by previous FFTF NEPA decisions (**Environmental Assessment, Sodium Residuals Reaction/Removal and Other Deactivation Work Activities, Fast Flux Test Facility (FFTF) Project, Hanford Site, Richland, Washington**) (DOE 2006), so that it can be maintained in a long-term S&M condition for the foreseeable future. The facility would be monitored and periodic S&M performed to

ensure that environmental or safety issues are minimized and addressed. Figure E-38 is a graphic representation of this FFTF Decommissioning No Action Alternative.

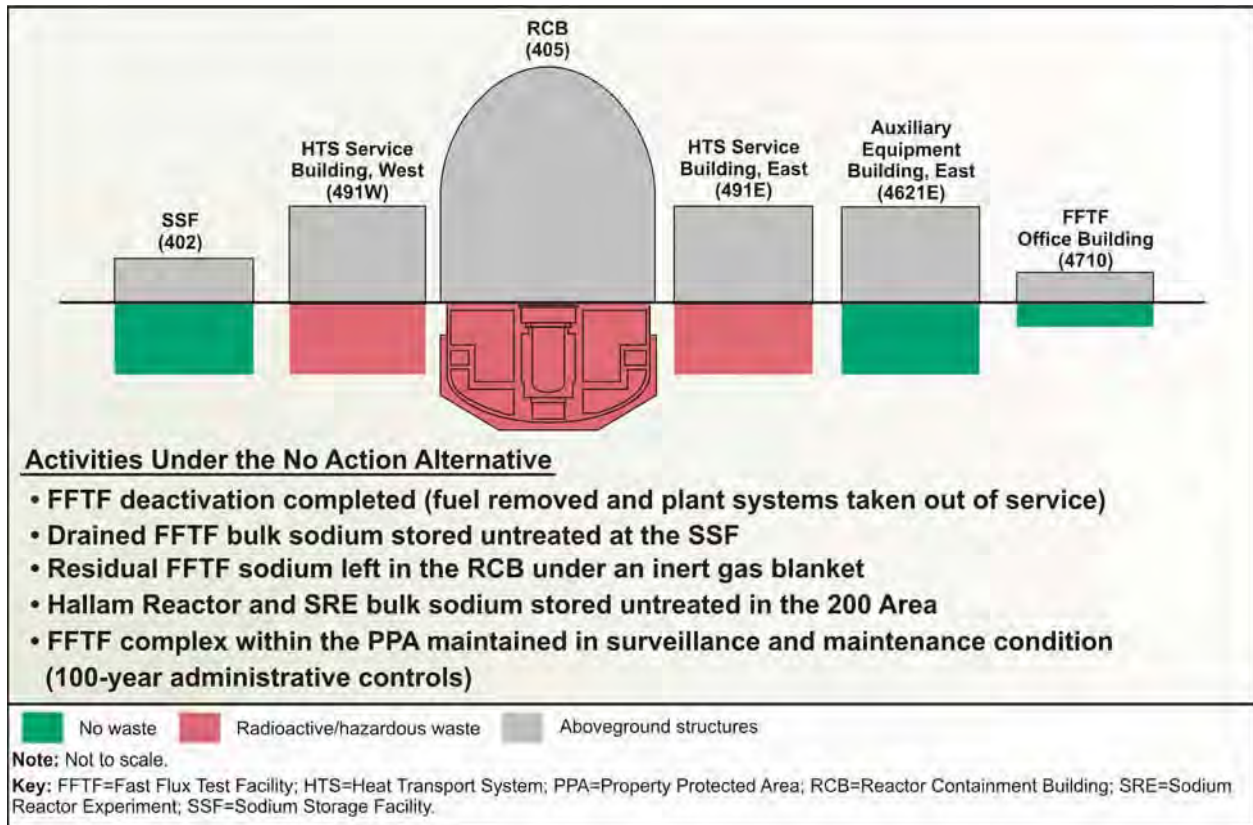

Figure E-38. FFTF Decommissioning Alternative 1: No Action

The impacts of continuing to implement previous decisions would be compared to the potential impacts of the proposed actions under the action alternatives. The following sections provide additional descriptions of activities to be conducted under the No Action Alternative.

Facility Disposition. FFTF (the RCB, Building 405), along with the rest of the buildings within the 400 Area PPA, would be maintained in a long-term S&M condition after completion of all deactivation activities. The buildings would be left standing, with a maintained exterior capable of protecting them from the elements. They would be unoccupied, with essential safety-related systems left operational. Such systems could include, but would not be limited to, fire protection, emergency lighting, ventilation, air monitoring, and inert gas systems used to isolate piping and equipment containing sodium residuals.

Process Components. The reactor vessel, piping systems and tanks (contained above and below grade within the RCB and the immediately adjacent buildings) would be left in place under an inert gas (e.g., argon) blanket. Deactivation activities would already be completed, including removal of spent nuclear fuel, depleted uranium, and lead shielding; draining of the bulk sodium; and removal of small-bore piping, valves, and other components. Some systems would be deactivated/de-energized and isolated (e.g., those not associated with maintaining safety-related functions) per the deactivation plans.

Sodium Residuals. Sodium residuals in the RCB vessels and cooling systems piping would be left in place, untreated, but under an inert gas (e.g., argon) blanket. During deactivation activities, the FFTF bulk sodium would be drained from the reactor systems and stored as a solid in tanks in the SSF within the 400 Area. The small amount of sodium-potassium alloy would be blended with the content of the

bulk sodium storage containers. The sodium from the Hallam Reactor and SRE would remain in its current storage location (Hanford's 200-West Area).

Demolition and Other Waste. There would be no demolition under the No Action Alternative; hence, no demolition waste would be generated. Solid and liquid radioactive and/or hazardous waste generated during deactivation would be managed and disposed of on site. Activities associated with the No Action Alternative would not generate substantial additional quantities of solid waste for disposal. The small amounts of radioactive solid waste generated during S&M activities would be disposed of on site in disposal facilities approved for Hanford's operational waste in the existing LLBG trenches. Other regulated waste, such as PCBs, asbestos, and hazardous waste, would be handled in a similar manner for all of the alternatives. The volume of that waste is expected to be small, and it would be dispositioned in accordance with existing Hanford facility acceptance criteria or offsite treatment contracts.

End State. The facilities and infrastructure within the 400 Area PPA, including the RCB, would be maintained in a long-term S&M condition using appropriate monitoring and controls (to ensure that environmental or safety concerns are minimized) for the foreseeable future.

E.2.3.2 FFTF Decommissioning Alternative 2: Entombment

Under this alternative, the FFTF RCB (and structures within) above grade level (i.e., 168 meters [550 feet] above mean sea level) would be decontaminated as necessary, dismantled, and removed. The RCB structures below grade level, as well as the FFTF reactor vessel and radioactive and contaminated equipment, components, piping, and other materials that have become radioactive or otherwise contaminated, would remain in place. Sodium residuals would be either removed from the RCB and treated in existing 400 Area facilities or treated in place. In addition, the RCB below grade level would be filled with grout or other suitable fill material to immobilize remaining hazardous chemicals and radiological materials to the maximum extent practicable and to prevent subsidence. The RCB fill material may include other demolition debris containing hazardous or radioactive materials, as allowed by regulations. A modified RCRA Subtitle C barrier would be constructed over the filled area. The barrier, together with the lower RCB and adjacent structures and the immobilized internal structures, would be within the entombed area. A preliminary, conceptual view of the Entombment Alternative is presented in Figure E-39.

The FFTF support buildings would be decontaminated as needed and demolished, as noted in Table E-13. The area previously occupied by the facilities would then be backfilled with soil to eliminate void spaces and then compacted, contoured, and revegetated. An appropriate monitoring program for the PPA would also be established. The following sections provide additional descriptions of activities to be conducted under the Entombment Alternative.

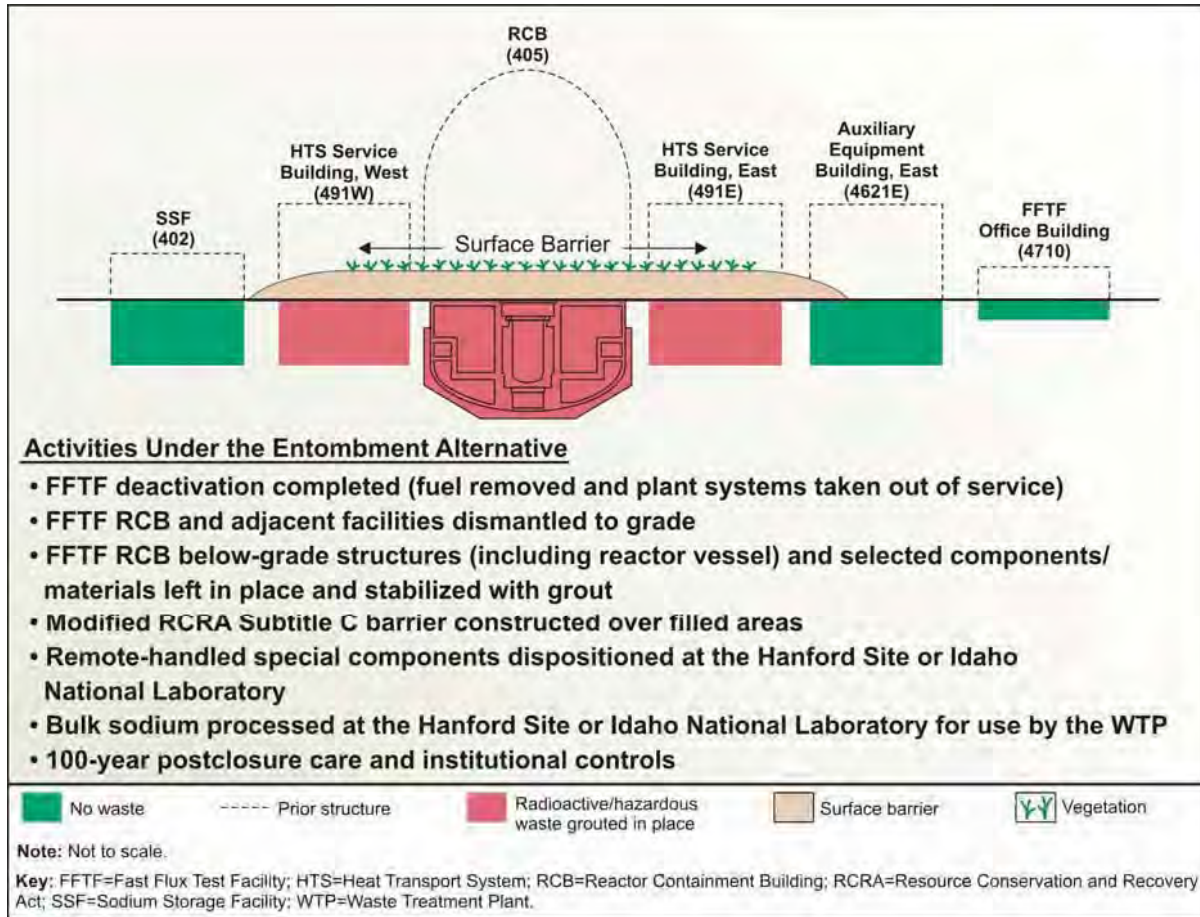

Figure E-39. FFTF Decommissioning Alternative 2: Entombment

Table E-13. Proposed Decommissioning Actions for Hanford Fast Flux Test Facility and Support Facilities

| Building No. | Building Name | Action Alternative | |
|--------------|------------------------------------|--------------------------------------|-----------------------------------|
| | | FFTF Decom. Alternative 2 Entombment | FFTF Decom. Alternative 3 Removal |
| 405 | FFTF Reactor Containment Building | F | E |
| 491E | HTS Service Building, East | F | C |
| 491W | HTS Service Building, West | F | C |
| 4621E | Auxiliary Equipment Building, East | D | C |
| 4621W | Auxiliary Equipment Building, West | D | C |
| 4703 | FFTF Control Building | D | C |
| 4717 | Reactor Service Building | D | C |
| 491S | HTS Service Building, South | D | C |
| 408A | Main Heat Dump, East | B | A |
| 408B | Main Heat Dump, South | B | A |
| 408C | Main Heat Dump, West | B | A |
| 409A | Closed Loop Heat Dump, East 1 | B | A |
| 409B | Closed Loop Heat Dump, East 2 | B | A |
| 403 | Fuel Storage Facility | C | C |
| 402 | Sodium Storage Facility | A | A |
| 432A | ISA Covered Equipment Storage | A | A |
| 436 | Training Facility | A | A |

Table E–13. Proposed Decommissioning Actions for Fast Flux Test Facility and Support Facilities (continued)

| Building No. | Building Name | Action Alternative | |
|------------------|--|--------------------------------------|-----------------------------------|
| | | FFTF Decom. Alternative 2 Entombment | FFTF Decom. Alternative 3 Removal |
| 437 | Maintenance & Storage Facility | A | A |
| 440 | 90-day Covered Storage Pad | A | A |
| 451A | Substation | A | A |
| 453A | Transformer Station, East DHX A1 2.4kV | A | A |
| 453B | Transformer Station, South DHX A2 2.4kV | A | A |
| 453C | Transformer Station, West DHX A3 2.4kV | A | A |
| 4701 | Former FFTF Guard Station | A | A |
| 4710 | FFTF Office Building | A | A |
| 4713A | Riggers and Drivers Operations Facility | A | A |
| 4713B | FFTF Maintenance Shop | A | A |
| 4713C | Contaminated Storage Warehouse | A | A |
| 4713D | Interim Maintenance and Storage Facility | A | A |
| 4716 | FFTF Rigging Loft | A | A |
| 4718 | 400-Area Interim Storage Area Pad | A | A |
| 4721 | FFTF Emergency Generator Building | A | A |
| 4734A | FFTF Argon/Nitrogen Pad | A | A |
| 480A | Water Supply Well House (P-14) | A | A |
| 480B | Water Supply Well House (P-15) | A | A |
| 480D | Water Supply Well House (P-16) | A | A |
| 481 | Water Pump House | A | A |
| 481A | Water Pump House | A | A |
| 482A | Water Storage Tank (T-58) | A | A |
| 482B | Water Storage Tank (T-87) | A | A |
| 482C | Water Storage Tank (T-330) | A | A |
| 483 | Cooling Towers Chemical Addition Building | A | A |
| 484 | FFTF In-Containment Chiller Water Equipment Building | A | A |
| 4842B | Switchgear Building for Pump Houses | A | A |
| SRF ^a | Sodium Reaction Facility (Proposed) | A | A |

^a If the U.S. Department of Energy decides to process the bulk sodium at an existing INL facility, the SRF would not be constructed. Decommissioning of the INL facility is not addressed in this **Tank Closure and Waste Management Environmental Impact Statement for the Hanford Site, Richland, Washington.**

Note: Grey shading indicates buildings with reinforced-concrete basements.

A = Demolish and remove building and soils, down to 0.91 meters (3 feet) below grade (if present, collapse subsurface floors and interior walls into the below-grade space—basement exterior walls below 0.91 meters (3 feet); basement floor and foundations would remain). Backfill to grade with soil, then compact and contour surface and revegetate. Remove all radioactive and/or hazardous material, as well as wood and large steel components. Foundation rubble (e.g., concrete and rebar) would remain.

B = Same as A, except the building footprint would be partially covered by the engineered barrier system.

C = Demolish and remove building down to grade. Remove above- and below-grade components and systems, then collapse floors and walls into the below-grade space at least down to 0.91 meters (3 feet) below grade (basement exterior walls below 0.91 meters (3 feet); basement floor and foundations would remain). Backfill to grade with soil, then compact and contour surface and revegetate. Remove all radioactive and/or hazardous material, as well as wood and large steel components. Foundation rubble (e.g., concrete and rebar) would remain.

D = Same as C, except the building footprint would be partially covered by the engineered barrier system.

E = Same as C, except small amounts of radioactive activation products in structural concrete and steel would remain.

F = Remove above-grade structures and systems. Contaminated equipment and systems below grade would remain. Consolidate waste and demolition debris below grade, then backfill with grout and cover entirely as part of the engineered barrier system. Radioactive and hazardous waste would remain entombed.

Key: DHX=Dump Heat Exchanger; Decom.=Decommissioning; FFTF=Fast Flux Test Facility; HTS=Heat Transport System; INL=Idaho National Laboratory; ISA=Interim Storage Area; kV=kilovolts; SRF=Sodium Reaction Facility.

Facility Disposition. Table E-13 summarizes the proposed decommissioning activities for each building under both the Entombment and the Removal Alternatives. For the Entombment Alternative, the main RCB and the two immediately adjacent support facilities (Buildings 491E and 491W) would have all above-grade structures (e.g., the RCB dome) dismantled, and the demolition waste would be disposed of in an IDF or consolidated in the below-grade spaces. Below-grade structures would be filled with demolition waste as practicable and stabilized with suitable fill material (e.g., grout) to immobilize hazardous chemical and radiological materials and prevent subsidence in the future.

All other ancillary buildings, including their internal equipment and components, would be demolished, as noted in Table E-13, and the contaminated demolition debris would be disposed of in an IDF or consolidated within available below-grade spaces within the RCB or Buildings 491E and 491W. All radioactive and/or hazardous material would be removed. Wood and large steel components would also be removed. Foundation rubble (e.g., concrete and rebar) would remain. The area previously occupied by these facilities would be backfilled, compacted, contoured, and revegetated. As indicated in Table E-13, some of these buildings would be either completely or partially within the footprint (including side slope) of the engineered barrier over the RCB.

Process Components. The reactor vessel, piping systems, and tanks (contained above and below grade within the RCB and the immediately adjacent buildings) would have all above-grade systems dismantled and placed in below-grade spaces as practicable or transported to an IDF for disposal. Systems that are below grade (including regulated waste) would be grouted in place after treatment of sodium residuals. The small-diameter piping (less than 20.3 centimeters [8 inches] in diameter) would be removed, treated (cleaned of sodium) in the 400 Area, and disposed of on site in an IDF or placed in below-grade spaces within the RCB.

Sodium Residuals. All sodium residuals would be removed from the RCB systems or treated in place. The analyses assumed that sodium would be drained from plant systems to the extent practicable, followed by passivation and/or flushing with water to stabilize sodium residuals. Sodium residuals in small-diameter piping would be treated in the 400 Area after removal of the components from the reactor plant.

Demolition and Other Waste. Demolition debris from facility decommissioning (chemically hazardous or radioactive solid waste) would be handled in the same way for both action alternatives, except that the disposition of the volumes of debris would change. The debris not placed in the RCB or other voids or used as backfill would be transported to an IDF for disposal. Analyses of solid waste resulting from any of the processing options (for sodium residuals, bulk sodium, etc.) were included in the analyses of those options, specific to the appropriate processing activities.

Radioactive liquid waste resulting from treatment of the sodium residuals would also be handled in the same way for both FFTF Decommissioning Alternatives 2 and 3. The liquid volume would be reduced at FFTF (either through ion exchange and reuse or evaporation), and the remaining liquids would be transported to the 200 Area ETF for processing and disposal. For analysis purposes, it was assumed that a 90 percent reduction in volume could be achieved prior to shipment of the liquid to the ETF for processing. Any other sources of radioactive waste (such as decontamination solutions) are expected to result in very small volumes compared to those produced as a result of treating sodium residuals.

Other regulated waste, such as PCBs, asbestos, and nonradioactive hazardous waste, would be handled in a similar manner under all of the FFTF Decommissioning alternatives. The volume of that waste is expected to be small, and it would be dispositioned in accordance with existing Hanford facility waste acceptance criteria or offsite treatment contracts.

End State. For the analyses in this TC & WM EIS, a regulatorily compliant engineered barrier (see Figure E–28), such as a modified RCRA Subtitle C barrier, was assumed to be constructed over the remaining below-grade portions of the RCB and Buildings 491E and 491W, which would contain radioactive and/or hazardous waste. The barrier also would extend over part or all of the immediately adjacent facility footprints. The barrier would be circular with a radius of about 39.2 meters (128.5 feet), not including the side slope used for drainage. The side slope would be about 5.2 meters (17.1 feet), using a 3H:1V slope. Minimal site postclosure care and maintenance would be required. The remainder of the PPA would be backfilled with soil, compacted, contoured, and revegetated.

The modified RCRA Subtitle C barrier would be designed to provide long-term containment and hydrologic protection for a performance period of 500 years, assuming no maintenance is performed after a 100-year institutional control period. This performance period is conservatively based on radionuclide concentration and activity limits for Category 3 LLW. The modified RCRA Subtitle C barrier would be composed of eight layers of durable material with a combined minimum thickness of about 1.7 meters (5.7 feet), excluding the grading fill layer, which would range from zero at the edge to around 0.8 meters (2.6 feet) at the center for a 2 percent drainage slope. This design incorporates RCRA “minimum technology guidance” (EPA 1989) with modifications for extended performance. One deviation from the guidance consists of elimination of the clay layer, which may desiccate and crack over time in an arid environment. The geo-membrane component was also eliminated because of its uncertain long-term durability (hundreds to thousands of years). The design incorporates an asphalt layer to inhibit biointrusion or inadvertent human intrusion (SAIC 2007b).

E.2.3.3 FFTF Decommissioning Alternative 3: Removal

Under the Removal Alternative, the RCB (and structures within) above grade level would be decontaminated as necessary, dismantled, and removed. All sodium residuals would be removed from the RCB or treated in place to neutralize its chemical reactivity. Below grade, the reactor vessel and its contaminated internals, as well as other radioactively contaminated equipment, components, piping, and materials any asbestos, depleted uranium shielding, and lead shielding, would also be removed. Such radioactively contaminated equipment, components, piping, and materials would include the intermediate heat exchangers, primary pumps, primary isolation valves, primary overflow tanks, interim examination and maintenance cell equipment, 8.5- to 12.2-meter (28- to 40-foot) long test assembly hardware, and the interim decay storage vessel. Additional radioactively contaminated equipment from the RCB and the FFTF heat transport system would also be removed. Upon removal, this equipment and materials would be disposed of in appropriate Hanford 200 Area disposal units in an IDF. The below-grade RCB and the structures within, as well as the FFTF support buildings outside the RCB area, would be decontaminated as necessary and demolished. The area previously occupied by the facilities would then be backfilled with soil to eliminate void spaces, compacted, contoured, and revegetated. An appropriate monitoring program would be established. Figure E–40 is a graphic representative of the Removal Alternative. The following sections describe the activities to be conducted under the Removal Alternative.

Facility Disposition. Table E–13 summarizes the proposed decommissioning activities for each building for both the Entombment and the Removal Alternatives. Under the Removal Alternative, the main RCB and the immediately adjacent support facilities with substructures (basements) would have all their above-grade structures dismantled and the contaminated demolition debris would be disposed of in an IDF. The RCB would be demolished to grade and the support facilities would be demolished to 0.91 meters (3 feet) below grade. Below grade, radioactively contaminated components and equipment (including the reactor vessel) would be removed. However, the reinforced-concrete cavity in the RCB would remain to be backfilled with either soil or grout to minimize void space, and the surface would be contoured and revegetated. Small amounts of radioactive activation products in structural concrete and steel would remain. As discussed in the following sections, all small-diameter pipes would be removed, and sodium residuals would be either treated in place or removed from the RCB for treatment at an onsite facility to neutralize the chemical reactivity of the metallic sodium.

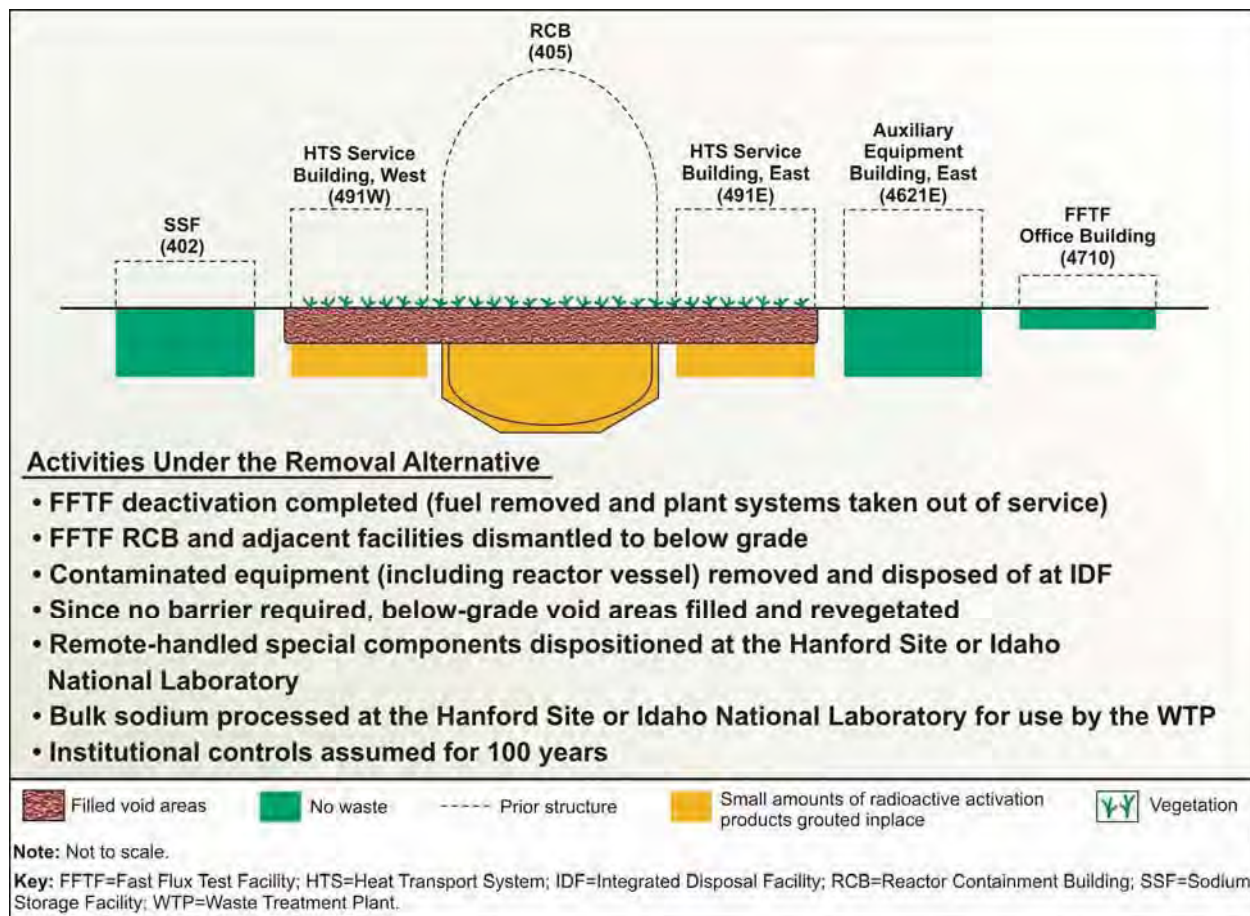

Figure E-40. FFTF Decommissioning Alternative 3: Removal

All other ancillary buildings, including their internal equipment and components, would be demolished and removed (down to a depth of 0.91 meters [3 feet] below grade). The contaminated demolition debris would be removed to an IDF for disposal, and the vacated spaces would be backfilled, compacted, contoured, and revegetated. All radioactive and/or hazardous material would be removed. Wood and large steel components would also be removed. Foundation rubble (e.g., concrete and rebar) would remain.

Process Components. The above- and below-grade reactor vessel, piping systems, and tanks within the RCB and the immediately adjacent buildings would be dismantled and transported to an IDF for disposal. Radioactively contaminated equipment, components, piping, tanks, and hazardous materials (including asbestos and lead shielding) would also be removed for disposal in an IDF. The reactor vessel (along with any internal piping and equipment and attached depleted uranium shielding) would be filled with grout, removed, packaged, and transported to an IDF for disposal. Uncontaminated (clean of radioactive or hazardous substances) material would not be removed, and, as previously stated, the reinforced-concrete cavity would remain. All small-diameter piping would be removed and treated in the 400 Area to remove sodium residuals, and the decontaminated equipment piping would be disposed of on site in an IDF.

Sodium Residuals. In the same manner as for the Entombment Alternative, all sodium residuals would be removed from the RCB systems or treated in place under the Removal Alternative. It was assumed that sodium would be drained from the plant systems to the extent practicable, followed by passivation and/or flushing with water to stabilize sodium residuals. Sodium residuals in small-diameter piping would be treated in the 400 Area after the components are removed from the reactor plant.

Demolition and Other Waste. Demolition debris, radioactive solid waste, radioactive liquid waste, and other regulated hazardous waste would be handled in the same manner for both action alternatives. Under the Removal Alternative, the demolition waste would be disposed of in an IDF.

End State. Below-grade portions of structures would be backfilled with soil, compacted to eliminate void spaces, contoured such that natural settling would not result in depressions (to avoid the potential for ponding of water), and revegetated. An appropriate site postclosure care program would be established.

E.2.4 FFTF Decommissioning Alternative Process Descriptions

E.2.4.1 Hanford Bulk Sodium Processing

There are approximately 1.1 million liters (300,000 gallons) of Hanford Site radioactively contaminated sodium that need to be dispositioned. This inventory consists of three separate categories of sodium, as follows:

- **FFTF sodium.** The FFTF reactor, located in the 400 Area of Hanford, ceased operation in April 1992 and was maintained in a standby condition from January 1997 until December 2001, when DOE issued a decision to permanently deactivate the facility. Since that time, activities have focused on preparing the facility for deactivation. Historically, FFTF has reported a sodium inventory of approximately 984,200 liters (260,000 gallons) (Burke 2007). This estimate was revised and the current sodium inventory estimate is approximately 958,000 liters (253,000 gallons). As of June 2007, approximately 916,000 liters (242,000 gallons) of radioactively contaminated bulk sodium have been drained and transferred to the SSF (Chapin 2007). The SSF tanks have a total capacity of approximately 1.1 million liters (300,000 gallons).
- **Hallam sodium.** The Hallam Reactor, located in Hallam, Nebraska, shut down in 1964; its approximate 128,700 liters (34,000 gallons) of sodium were received at Hanford in 1967. This sodium is stored in solid form under an inert cover gas in five storage tanks at the 2727-W Hallam Sodium Storage Building in the 200-West Area at Hanford (Burke 2007).
- **SRE sodium.** The SRE sodium, approximately 26,500 liters (7,000 gallons), was received at Hanford in 1975 from the SRE, located at the Santa Susanna Field Laboratory, California. This sodium is stored in solid form in 158 208-liter (55-gallon) drums sealed within 322-liter (85-gallon) overpacks. The SRE sodium is stored in eight South Alkali Metal Storage Modules in the 200-West Area CWC at Hanford (Burke 2007).

Based on the historical estimate (i.e., 1.1 million liters [300,000 gallons]), the approximate quantities of Hanford sodium inventory remaining to be processed and the resulting quantity of 50 weight-percent caustic sodium hydroxide solution that would be produced are shown in Table E-14. The 2.5 million liters (667,000 gallons) of sodium represent less than 40 percent of the caustic sodium hydroxide solution additions required by the WTP pretreatment processes (waste processing and caustic leaching) (ANL-W and Fluor Hanford 2002).

Table E-14. Hanford Site Radioactive Sodium Inventory

| Sodium Category | Sodium | | 50 weight-percent Caustic Sodium Hydroxide Solution | |
|-----------------|-----------|-------------|---|-------------|
| | Liters | Metric Tons | Liters | Metric Tons |
| FFTF | 984,200 | 950 | 2,176,600 | 3,360 |
| Hallam | 128,700 | 130 | 287,700 | 450 |
| SRE | 26,500 | 30 | 60,600 | 90 |
| Total | 1,139,400 | 1,110 | 2,524,900 | 3,900 |

Note: To convert liters to gallons, multiply by 0.26417.

Key: FFTF=Fast Flux Test Facility; SRE=Sodium Reactor Experiment.

Source: ANL-W and Fluor Hanford 2002.

Two options for disposal of Hanford's sodium inventory are being considered: the Hanford Reuse Option and the Idaho Reuse Option. To understand whether the radiation levels in Hanford's sodium inventory could affect the feasibility of the caustic conversion process for either option, sodium activity levels were obtained and decayed to October 2008, the assumed date used for the start of processing in the **Hanford Site Sodium Disposition Trade-Off Study** (ANL-W and Fluor Hanford 2002). Table E-15 summarizes the sodium activity levels for the major contaminants, decayed appropriately, and compares them with Experimental Breeder Reactor II (EBR-II) and Enrico Fermi Nuclear Generating Station (Fermi) sodium activity levels (at time of processing). Though the activity levels are low, this material does not qualify as nonradioactive material according to the U.S. Department of Transportation.

Table E-15. Significant Radioisotopes in Sodium

| | Isotope (nCi/gram) | | | Date of Activity |
|------------------------|----------------------|----------------------|--------------------|------------------|
| | Na-22 | Cs-137 | H-3 (Tritium) | |
| FFTF primary sodium | 5.6 | 4.8×10^{-2} | 5.2×10^1 | October 2008 |
| Hallam sodium | 4.6×10^{-4} | 4.9×10^{-4} | 1.2×10^1 | October 2008 |
| SRE sodium | 1.8×10^{-4} | 8.5×10^{-1} | N/A | October 2008 |
| Fermi sodium | 2.2×10^{-2} | 5.6×10^{-1} | 1.2 | December 1998 |
| EBR-II primary sodium | 2.05×10^1 | 1.09×10^1 | 2.52×10^2 | September 2000 |
| DOT limit ^a | 2 | 2 | 2 | - |

^a Maximum activity for nonradioactive shipments per 49 CFR 173.403.

Key: Cs=cesium; DOT=U.S. Department of Transportation; EBR-II=Experimental Breeder Reactor II; FFTF=Fast Flux Test Facility; H=hydrogen; N/A=not applicable; Na=sodium; nCi=nanocuries; SRE=Sodium Reactor Experiment.

Source: ANL-W and Fluor Hanford 2002.

Elemental sodium is a silver, soft and ductile alkali metal at room temperature and has a density slightly less than that of water. Sodium reacts vigorously with water and steam and is extremely reactive, oxidizing rapidly when exposed to air. It melts at about 190 °C (208 °F) to form a silvery liquid. The normal boiling point of sodium is 1,600 °C (1,618 °F). The basic chemical reaction is an exothermic reaction with water that, for excess water, produces a caustic sodium hydroxide solution and the evolution of hydrogen gas:



Liquid sodium would be transferred from a storage tank into the facility where the reaction would take place and would be controlled by adjusting the injection rate of the liquid reactants. The process would occur in the reactor vessel, which is a nickel pressure vessel (4.6 meters tall by 0.8 meters in diameter [15 feet tall by 30 inches in diameter]). The entire system would use nitrogen as an inert cover and pressurizing gas. For a 50 weight-percent caustic sodium hydroxide solution, the reaction would occur at approximately 138 °C (280 °F). Offgases emitted during the process would contain hydrogen, nitrogen, water vapor, and caustic vapor. They would be exhausted from the vessel, dried, scrubbed, HEPA-filtered, and monitored before venting as a nonflammable nitrogen/hydrogen mixture. The final

caustic sodium hydroxide solution would be pumped from the reaction vessel to a fill station where transportation tanks or drums would be used to contain it for storage before shipment off site (ANL-W and Fluor Hanford 2002).

E.2.4.2 Sodium Reaction Facility—Hanford Reuse Option

This section provides background information for processing the Hanford bulk sodium at Hanford. The inventory of the Hanford bulk sodium to be processed is described in detail in Section E.2.4.1. The sodium reaction process utilized by the SPF at INL forms the basis for the FFTF SRF and is described in detail in Section E.2.4.3.

E.2.4.2.1 Description of the Sodium Reaction Facility

The SRF at Hanford would be used to house the process for converting sodium into a caustic sodium hydroxide solution. The SRF would be located directly adjacent to the existing SSF, as shown in Figure E-41. Locating the system adjacent to the SSF would reduce construction and operation costs through sharing of utilities and operational integration. The SSF, an existing building, is located west of the FFTF south dump heat exchanger and consists of three 300,000-liter (80,000-gallon) tanks and one 200,000-liter (52,000-gallon) tank. The SSF structure is 28 meters long by 27 meters wide by 9.1 meters high (91 feet long by 90 feet wide by 30 feet high). The SSF would be used to store the bulk sodium until its transfer to the SRF for treatment. An exterior photo of the SSF is shown in Figure E-42.

For analysis purposes, this TC & WM EIS assumes that the process to be used at the SRF to produce the caustic sodium hydroxide solution would be identical to the process used during the processing of the EBR-II bulk sodium at the SPF at INL. The following subsections describe the individual SRF systems/components.

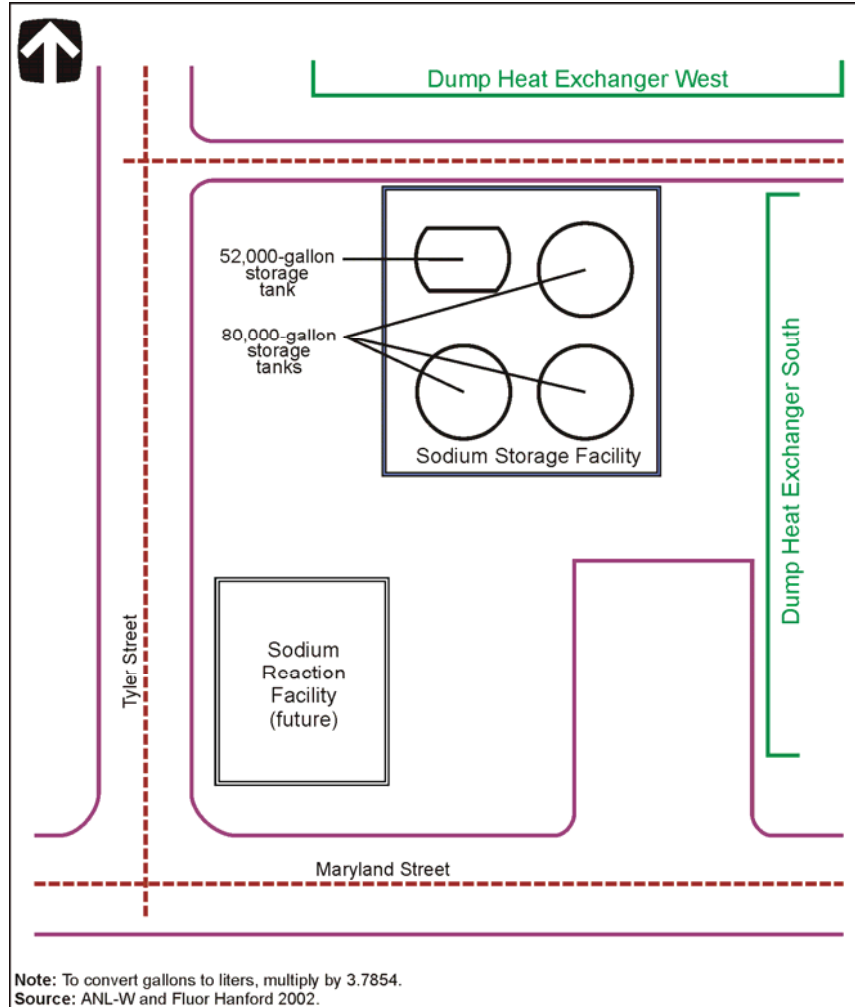

Figure E-41. Location of the Sodium Reaction Facility and the Sodium Storage Facility



Source: ANL-W and Fluor Hanford 2002.

Figure E-42. Sodium Storage Facility at Hanford

E.2.4.2.2 Sodium Barrel Melt-and-Drain System

SRE sodium would arrive at the SRF in its currently packaged 208-liter (55-gallon) drums, each contained in its own overpack, and would be transferred into the SRF day tanks by the barrel melt-and-drain system.

System components would include the following:

- Barrel melt-and-drain stations
- Clamp-on band heaters and thermocouples
- Associated piping (nitrogen supply lines, sodium transfer lines)
- Control panels for each drain station
- HEPA-filtered room exhaust system
- Radiation and contamination detectors

E.2.4.2.3 Sodium Reaction Facility Transfer Line

The SRF transfer line would be an approximate 3.8-centimeter (1.5-inch) heated, stainless steel, insulated pipeline used to transfer sodium from the SSF to the SRF. An isolation valve would be installed at each end of the SRF transfer line. The transfer line would be designed to maximize draining of the pipe when pumping ceases due to its downward slope. As with the SPF transfer line, secondary containment of sodium in double-walled piping would not be required for sodium transfer lines. The transfer line would be trace-heated with resistive heaters and insulated and sealed with a closure system and vapor barrier that would be finished with a weatherproof jacketing material.

E.2.4.2.4 Sodium Transfer System

This system would transfer sodium from the SSF to the SRF's sodium day tanks. During processing of the sodium, the day tanks would receive sodium from one of two sources, as follows:

- SRE sodium from the barrel melt-and-drain system
- FFTF and Hallam sodium from the SSF via the transfer line

There would be two identical carbon-steel sodium day tanks. The SSF nitrogen blanket would be pressurized to push sodium from the SSF to fill one of the day tanks at approximately 110 liters (30 gallons) per minute, while the other day tank would be used for processing.

E.2.4.2.5 Sodium Reaction System

The reaction system would be used to perform the chemical conversion of liquid metallic sodium to a caustic sodium hydroxide solution. This reaction would take place in the reaction vessel when sodium is transferred from the day tanks to the reaction vessel. This transfer would be accomplished by pressurizing the in-service day tank with nitrogen gas.

The reaction vessel would be a 0.8-meter-diameter by 4.6-meter-high (30-inch-diameter by 15-foot-high) vertical cylinder constructed from caustic corrosion-resistant nickel alloy 200. After passing through an injection nozzle, the sodium would react with water to produce a caustic sodium hydroxide solution and hydrogen gas.

By controlling the atmospheric boiling point of the solution with the periodic addition of water, the concentration of the sodium hydroxide product would be fixed. Sodium would be injected into the reaction vessel through specially designed nozzles capable of adding steam or nitrogen gas (or both) simultaneously at the point of injection. Nitrogen would be introduced into an annulus area at the nozzle

tip to aid in atomizing the sodium upon injection into the reaction vessel. The more completely the sodium was atomized, the greater the surface area of sodium exposed and the quieter, less forceful the resulting reaction between the water and sodium would be as experienced by the SPF. This would also ensure that all of the sodium reacted completely beneath the surface of the hydroxide solution where the energy release can be readily absorbed, and the possibility of the carryover of sodium into the offgas would be eliminated. In addition, the capability for initiating a flow of nitrogen or steam to the nozzles after sodium flow was terminated would minimize plugging; if plugging occurred, steam could be used to clear the plug. Each nozzle would have its own electromagnetic flowmeter. The nitrogen would be vented from the reaction vessel via the caustic offgas system along with the reaction-produced hydrogen and some water vapor.

The resulting concentration of caustic sodium hydroxide solution in the reaction vessel would be circulated continuously using a caustic recirculation pump. This recirculation pump would take suction from the bottom of the reaction vessel and discharge it near the top of the reaction vessel. Circulation of the caustic sodium hydroxide solution would ensure uniform mixing of the solution when combined with the vigorous nature of the sodium/water reaction.

E.2.4.2.6 Caustic Transfer System

The caustic transfer system would consist of the following components:

- Caustic recirculation pump
- Caustic recirculation line
- 3,800-liter (1,000-gallon) caustic cooling tank
- Caustic product transfer line (with concentric heat exchanger)
- Caustic metering pump
- Caustic transfer pump
- 15,000-liter (4,000-gallon) caustic storage tank

The caustic recirculation pump would take suction from the bottom of the reaction vessel and discharge to piping that would either (1) return the solution to the vessel, (2) divert some of the solution to the product transfer line, or (3) pump down the contents of the vessel to the caustic cooling tank.

The 3,800-liter (1,000-gallon) caustic cooling tank would measure approximately 1.2 meters in diameter by 3.4 meters long (4 feet in diameter by 11 feet long). It would contain a heat exchanger that would reduce the caustic temperature below the levels necessary for caustic corrosion when the product was being pumped from the reaction vessel to the caustic storage tank. The caustic cooling tank also would be used to store some caustic sodium hydroxide solution when the reaction vessel is drained for maintenance. One of the first evolutions to be performed during process startup would involve using the caustic metering pump to transfer this initial charge of caustic sodium hydroxide solution from the caustic cooling tank directly to the reaction vessel. Sodium would be injected into this volume of caustic sodium hydroxide solution to resume processing operations. All piping would be made of nickel because of its corrosion-resistance to high-temperature sodium hydroxide.

The caustic transfer system would be equipped with two automatic flow-control valves, as follows:

- One automatic flow-control valve would divert approximately 3.8 to 7.6 liters (1 to 2 gallons) per minute of the caustic sodium hydroxide solution from the caustic recirculation line to the product fill line. This diversion would be set to maintain a specified level in the reaction vessel.
- The other flow-control valve would direct caustic to the caustic sodium hydroxide solution cooling tank during process shutdown.

E.2.4.2.7 Product System

When the level of caustic sodium hydroxide solution in the reaction vessel reached the control set point, an automatic valve would open, diverting this product solution from the discharge of the caustic recirculation pump to the product container via a product fill line. The product fill container would be determined later by Hanford personnel. The product fill line would be a concentric pipe, counter-flow heat exchanger, which would have an inner pipe (nickel) utilized for high-temperature sodium hydroxide and an outer pipe (stainless-steel) containing a coolant (chemically treated water). The fill line would be routed from the process area to the product area.

After a product container was placed in the product area and the fill line nozzle was connected, an operator would actuate a switch on the offload station control panel to begin the product container fill process. If the level of caustic sodium hydroxide solution in the reaction vessel was above the level control set point, it would enable the opening of an automatic valve that would divert caustic sodium hydroxide solution to the product area. The caustic sodium hydroxide solution passing through the product fill line concentric heat exchanger would be cooled prior to entering the product container. When sensors indicated that the product container was full, the operator would actuate another switch on the offload station control panel to temporarily reroute the product to the caustic storage tank. This lineup would allow processing to continue until another product container was connected to the fill-line nozzle. At this point, an operator would sample the full product container for product quality and concentration would be adjusted, as necessary. It would then be sealed and surveyed by the health physics technician to verify outer cleanliness and contact radiation levels. It would then be moved aside to one of the storage bays and another product container would be put in place to begin the filling process.

E.2.4.2.8 Service and Suspect Water Systems

Two separate water systems—the service and suspect water systems—would make up the SRF water system. The service water system would be a clean potable water system that functions (1) to cool the offgas condenser and (2) to serve as a heat sink for the product-fill heat exchanger. Service water would be supplied to the SRF from a sitewide source at approximately 690,000 pascals, gauge (100 pounds per square inch, gauge). The primary purpose of the suspect water system would be to provide the water injected into the reaction vessel that controls the main processing temperature. It would also provide baffle sprays in the reaction vessel and makeup water to the offgas scrubber. The primary source of the water in this system would be the condensation and drains from the offgas system. This water would be potentially contaminated with radioactive constituents. The drains would be collected in a small collection vessel and pumped to a 1,900-liter (500-gallon) water holding tank. A pump would then take suction on the water holding tank and discharge it to the reaction vessel. Makeup water to the system would be supplied to the water holding tank from a deionized water system.

E.2.4.2.9 Caustic Offgas System

The system would be designed to perform the following actions:

- Contain and recycle the water vapor and caustic carryover from the reaction vessel.
- Remove the gases produced during the process of converting sodium to sodium hydroxide.
- Remove the nitrogen that collects in the vessel from the various purges in the reaction system.
- Provide for filtration, cleaning, and monitoring of gases and particulate carried over in the offgas stream in accordance with environmental and engineering standards prior to discharging to the environment.

The system would be composed of the following components, as well as interconnecting piping (components are listed in flow path order).

- Reaction vessel baffles
- Reaction vessel demister
- Offgas condenser
- Mist eliminator (mesh-type)
- Scrubber
- Moisture separator (vane-type)
- Parallel prefilters (with polypropylene material)
- Parallel HEPA filters
- Building discharge piping

The principal constituents in the caustic offgas stream, as it exited the reaction vessel would be water vapor, hydrogen, and nitrogen. Hydrogen is a reaction product of sodium and water and would make up approximately 60 to 70 percent of the offgas-stream volume at the anticipated SRF rated sodium injection rate of 2.3 liters (0.6 gallons) per minute to the reaction vessel. Nitrogen would be used to atomize the sodium in the reaction vessel injection nozzles, to do the initial purge of the reaction vessel and offgas system, and to provide an inert cover gas in all process system tanks and vessels to eliminate oxygen. The caustic offgas system would process this gas stream and ultimately release hydrogen and nitrogen outside the SRF building to the atmosphere and return the condensed water vapor to the reaction process. Condensate would be returned to the water holding tank through a series of drain lines.

E.2.4.2.10 Vent Systems

There would be two independent vent systems associated with the sodium process area and 15,000-liter (4,000-gallon) caustic sodium hydroxide solution storage tank. All vent system piping would be carbon-steel. The vent systems would collect gaseous effluents from all tanks in the sodium process area, including the following:

- 2,760-liter (730-gallon) sodium day tanks
- 3,800-liter (1,000-gallon) caustic cooling tank
- 15,000-liter (4,000-gallon) caustic storage tank
- 1,900-liter (500-gallon) water holding tank

E.2.4.2.11 Steam System

Steam would be used to clear the injection nozzles in the reaction vessel in the sodium process area.

E.2.4.2.12 Nitrogen System

Because of the reactive nature of sodium, nitrogen gas would be utilized in the SRF as the primary source of inert gas supplied for all applications requiring a cover gas or motive force.

E.2.4.2.13 Control Air System

The compressed air system would be used to perform the following actions:

- Operate the barrel-tilting mechanism for the melting-draining operation.
- Operate the pneumatically actuated valves in the sodium, caustic sodium hydroxide solution, and vacuum piping.

- Operate the pneumatic tilting device to move drums of hydroxide to the drum palletizing area if drums are used as the product fill containers.

E.2.4.2.14 Process Computer System

The SRF processes would be monitored and controlled using a computer control system consisting of the following components:

- A main control computer
- A graphics computer
- Two bus computers

Process instrumentation and actuators would be connected to the computer control system through input/output channels on the two bus computers. Operators would interact with computer color graphics screens to control and monitor the processes. For certain portions of the process system, operators would interact with the control system through pushbutton/indicator panels located in specific process areas.

E.2.4.2.15 Sodium Throughput

The SRF is modeled directly on the SPF for throughput. The SPF processed sodium at a nominal rate of 2.3 liters (0.6 gallons) per minute, resulting in about 136 liters (36 gallons) per hour, or 3,220 liters (850 gallons) of sodium processed per day. At this rate, approximately 7,600 liters (2,000 gallons) of 50 weight-percent caustic sodium hydroxide solution could be produced each day (ANL-W and Fluor Hanford 2002).

E.2.4.3 Sodium Processing Facility—Idaho Reuse Option

The SPF (see Figures E-43 and E-44) was originally constructed in the mid-1980s to convert sodium from the Fermi reactor plant into 50 weight-percent caustic sodium hydroxide solution for use in the PUREX process at Hanford. This use was abandoned after the SPF was constructed, but before it began operations. Once the EBR-II was ordered to be shut down, defueled, and prepared for deactivation, the SPF was used as a means of preparing the Fermi and EBR-II sodium for disposal at the Radioactive Waste Management Complex, located at INL. Production operations with radioactive sodium began on December 20, 1998. Processing of all EBR-II and Fermi sodium was completed on March 5, 2001, and the facility was placed in a standby condition. To date, approximately 680,000 liters (180,000 gallons) of radioactive sodium have been processed in the SPF.

The purpose of the SPF is to react sodium with water to produce a caustic sodium hydroxide solution. The process has the capability of producing any concentration of this solution simply by changing the processing temperature.

This would allow conversion of the Hanford sodium to a 50 weight-percent caustic sodium hydroxide solution, which is specified for use by the ORP at Hanford.

The SPF can receive sodium in the following ways:

- The 208-liter (55-gallon) barrels can be delivered directly to the SPF, where the contents can be melted and drained to a sodium storage tank. The Fermi sodium was received in this manner, which would also be the method of transferring the SRE sodium into the facility.



Source: ANL-W and Fluor Hanford 2002.

**Figure E-43. Experimental Breeder Reactor II/
Sodium Processing Facility Complex**



Source: ANL-W and Fluor Hanford 2002.

**Figure E-44. Sodium Processing Facility at the
Materials and Fuels Complex**

- Sodium can be transferred via a heated pipeline that runs from the secondary sodium drain tank located in the EBR-II secondary sodium boiler building basement. This method was used to transfer EBR-II primary and secondary sodium, and could also be used to transfer the Hallam and FFTF sodium into the SPF.

Once the sodium is in the SPF and in the sodium storage tank, it can be transferred to one of two day tanks, each with a working volume of 2,570 liters (680 gallons), by pressurizing the sodium storage tank

with nitrogen gas. During normal operations, one of the day tanks can be filled from the sodium storage tank while the other is used to supply sodium to the reaction vessel, which also can be accomplished by pressurizing the tank with nitrogen gas.

In the reactor vessel, the sodium would react with the water in the caustic sodium hydroxide solution used to initially charge the vessel. This reaction would release heat, which would increase the temperature of the caustic sodium hydroxide solution in the vessel until it reached the control set point. As this would be a saturated boiling system, the end caustic product concentration would be determined by this temperature set point. A 50 weight-percent liquid product would require an operating temperature of 138 °C (280 °F), compared to the 186 °C (367 °F) used to process EBR-II sodium into a 70 weight-percent (solid) caustic waste form. Water would be injected into the reactor vessel intermittently to maintain the control set point within +/- 0.5 °C (+/- 0.5 °F).

As the sodium reacts and new caustic sodium hydroxide solution is produced, the level in the reaction vessel would increase. When it reaches the level control set point, operators would begin filling a 15,000-liter (4,000-gallon) tank or direct the 50 weight-percent caustic sodium hydroxide solution to the caustic storage tank until another tank was readied for filling. The majority of instrumentation and system controls at the SPF are coordinated through a control computer in the SPF control room, which permits system operations with minimal operator input (ANL-W and Fluor Hanford 2002).

E.2.4.3.1 Facility Description

The SPF complex consists of several buildings. These include the original SPF building (and a large addition to it), as well as the caustic storage tank room, an operations support trailer, the EBR-II sodium boiler building, and the sodium transfer line located in the yard area between the sodium boiler building and the SPF.

The SPF currently consists of a four-room metal building housing the barrel melt-and-drain room, barrel holding room, equipment room, control room, and a carbon-steel-lined concrete pad on which the process equipment (process area) is located. The approximate overall dimensions of this part of the building are 20.4 meters long by 17.4 meters wide (67 feet long by 57 feet wide). A newer, large addition to the original building contains the product area. The approximate overall dimensions of this addition are 7.6 meters wide by 22.6 meters long (25 feet wide by 74 feet long). It also has two attached storage bays that have combined, outside dimensions of 7.3 meters wide by 9.8 meters long (24 feet wide by 32 feet long).

The SPF is supported on a thickened-edge, reinforced-concrete pad. Most of the exterior is constructed of galvanized-steel siding and roof panels on a structural-steel frame. However, the barrel melt-and-drain room has 30.5-centimeter-thick (12-inch-thick) reinforced-concrete block walls and a 20.3-centimeter-thick (8-inch-thick) reinforced-concrete slab roof. All sections of the building meet the requirements of the Uniform Building Code and Seismic Zone 2 or 2B.

A small metal-sided building, constructed over a lined concrete secondary containment basin, is located just west of the original SPF building. It houses the caustic storage tank. An operations support trailer provides office space, a lunchroom, locker room, and showers for the operating crews. The EBR-II sodium boiler building houses the secondary sodium drain tank, a recirculation system, and pumps used to transfer sodium to the SPF.

E.2.4.3.2 Barrel Melt-and-Drain Room

This room contains the eight melt-and-drain stations that would be used to melt the sodium in the 208-liter (55-gallon) SRE drums.

E.2.4.3.3 Barrel Holding Room

The 208-liter (55-gallon) sodium drums would be brought into this area through a sliding service door in the east exterior wall. This room is a staging area that supports the barrel melt-and-drain room.

E.2.4.3.4 Equipment Room

This room houses several electrical panels, the remote Met-L-X fire control station for the barrel melt-and-drain room, the electrical constant power unit, and several sitewide radio networks utilized by the facility area supervisor. It also is used by the facility area supervisor as office space for conducting facility business, such as work control and lockout/tagout.

E.2.4.3.5 Control Room

This area contains the main control computer that is used to control and monitor all process functions. It also contains controls for a remote video camera monitoring the process area, three backup computers used to monitor process parameters, and the rest of the emergency communications equipment used by the facility area supervisor for emergency response.

E.2.4.3.6 Process Area

This room contains all of the major equipment necessary to convert sodium to caustic sodium hydroxide solution. There is a steel-lined secondary containment basin located below all tanks and most piping containing caustic or sodium in this area, as well as systems to detect hydrogen leaks and fires.

E.2.4.3.7 Product Area

This addition houses equipment that was used for filling waste drums when EBR-II sodium was processed and now would be used for filling 15,000-liter (4,000-gallon) tanks after modifications are made. This area also contains chemical analysis equipment for product quality verification, the ventilation system equipment for the main facility, and two bays that can be used for heated storage of product or waste containers. The building height in the main part of the product area is approximately 9.4 meters long and about 3.6 meters wide (31 feet long and about 12 feet wide) in the storage bays. A floor area just inside a rollup door on the east side of the building has an open workspace of approximately 9.1 meters long by 7.3 meters wide (30 feet long by 24 feet wide) that would be used to house an International Standards Organization (ISO) tank while it is being filled with caustic sodium hydroxide solution (ANL-W and Fluor Hanford 2002).

E.2.4.3.8 Sodium Processing Facility Basic System Descriptions

E.2.4.3.8.1 Sodium Barrel Melt-and-Drain System

The SRE sodium would arrive at the SPF in its currently packaged 208-liter (55-gallon) drums, each contained in its own overpack, and would be transferred into the SPF sodium storage tank by the barrel melt and drain system.

System components would include the following:

- Eight-barrel melt-and-drain stations
- Clamp-on band heaters and thermocouples
- Associated piping (nitrogen supply lines, sodium transfer lines)
- Control panels for each drain station
- HEPA-filtered room exhaust system

- Radiation and contamination detectors
- Fire suppression system (Ansul Met-L-X) for the barrel container assemblies

E.2.4.3.8.2 Sodium Processing Facility Transfer Line

The SPF transfer line is a heat-traced, 2.5-centimeter (1-inch) stainless steel, insulated pipeline that would be used to transfer sodium a distance of approximately 270 meters (900 feet) from the secondary sodium drain tank in the basement of the EBR-II sodium boiler building to the SPF. An isolation valve is installed at each end of the SPF transfer line (i.e., in the sodium boiler building and the SPF). The transfer line is routed out of the sodium boiler building just above grade level and routed west and north toward the SPF. The transfer line enters the SPF through the west wall of the process area and connects to the top of the sodium storage tank at a flange. The transfer line is designed to maximize draining of the pipe when pumping ceases due to its downward slope from the high point just west of the SPF down to the sodium boiler building basement. The transfer line is trace-heated with resistive heaters and insulated and sealed with a closure system and vapor barrier that is finished with a weatherproof jacketing material.

E.2.4.3.8.3 Sodium Transfer System

This system would transfer sodium from the SPF sodium storage tank to the sodium day tanks. During processing of the Hanford sodium, the sodium storage tank would receive sodium from one of two sources, as follows:

- SRE sodium transferred from the barrel melt-and-drain system
- FFTF and Hallam sodium transferred from the secondary sodium drain tank via the transfer line

The secondary sodium drain tank has an effective volume of 56,800 liters (15,000 gallons) and the sodium in this tank could be either recirculated or pumped to the SPF using two annular linear induction pumps at about 90.8 liters (24 gallons) per minute. The sodium storage tank is a carbon-steel storage tank that has a working volume of 16,300 liters (4,300 gallons). A vacuum system is used to create a vacuum in the tank to provide the motive force for sodium transfers into the tank. A nitrogen blanket is also maintained over the tank contents to keep the contents of the tank inert.

There are two identical carbon steel sodium day tanks, each with a working volume of 2,570 liters (680 gallons). The sodium storage tank nitrogen blanket is pressurized to push sodium from the sodium storage tank to fill one of the day tanks at approximately 110 liters (30 gallons) per minute, while the other day tank is used for processing.

E.2.4.3.8.4 Sodium Reaction System

The purpose of the reaction system is to perform the chemical conversion of liquid metal sodium to a caustic sodium hydroxide solution. Sodium transfer would be accomplished by pressurizing the in-service day tank with nitrogen gas, which provides the driving force for the injection of sodium into the reaction vessel, where the reaction takes place.

The reaction vessel is a 0.8-meter-diameter (30-inch-diameter) by 4.6-meter-high (15-foot-high) vertical cylinder constructed from caustic corrosion-resistant alloy 200 nickel. After passing through an injection nozzle, the sodium would react with water to produce a caustic sodium hydroxide solution and hydrogen gas.

By controlling the boiling point of the solution with the periodic addition of water, the concentration of the sodium hydroxide product would be fixed. Sodium would be injected into the reaction vessel through specially designed nozzles capable of adding steam or nitrogen gas (or both) simultaneously at the point of injection. Nitrogen would be introduced into an annulus area at the nozzle tip to aid in atomizing the

sodium upon injection into the reaction vessel. The more completely the sodium is atomized, the greater the surface area of sodium exposed and the quieter, less forceful the resulting reaction between the water and sodium. This also would ensure that all of the sodium would react completely beneath the surface of the hydroxide solution where the energy release can be readily absorbed, and the possibility of the carryover of sodium into the offgas would be eliminated. In addition, the capability to initiate a flow of nitrogen or steam to the nozzles after sodium flow was terminated would minimize plugging; if plugging occurred, the steam could be used to clear the plug. Each nozzle has its own electromagnetic flowmeter. Nitrogen would be vented from the reaction vessel via the caustic offgas system along with the reaction-produced hydrogen, water vapor, and some caustic carryover.

The resulting concentration of caustic sodium hydroxide solution in the reaction vessel would be circulated continuously using a caustic recirculation pump. Circulation of the caustic sodium hydroxide solution would ensure uniform mixing of the solution when combined with the vigorous nature of the sodium/water reaction.

E.2.4.3.8.5 Caustic Transfer System

The caustic transfer system consists of the following components:

- Caustic recirculation pump
- Caustic recirculation line
- 3,800-liter (1,000-gallon) caustic cooling tank
- Caustic product transfer line (with concentric heat exchanger)
- Caustic metering pump
- Caustic transfer pump
- 15,000-liter (4,000-gallon) caustic storage tank

The caustic recirculation pump would take suction from the bottom of the reaction vessel and discharge to piping that can either (1) return the solution to the vessel, (2) divert some of the solution to the product transfer line, or (3) pump down the contents of the vessel to the caustic cooling tank.

The 3,800-liter (1,000-gallon) caustic cooling tank is 1.2 meters in diameter by 3.4 meters long (4 feet in diameter by 11 feet long). It contains a heat exchanger, which would reduce the caustic temperature below the levels necessary for caustic corrosion when the product is being pumped from the reaction vessel to the caustic storage tank. The caustic cooling tank also would be used to store some caustic sodium hydroxide solution when the reaction vessel is drained for maintenance. One of the first evolutions performed during process startup would involve using the caustic metering pump to transfer this initial charge of caustic sodium hydroxide solution from the caustic cooling tank directly to the reaction vessel. Sodium would be injected into this volume of caustic sodium hydroxide solution to resume processing operations.

The caustic metering pump is a sealless, magnetic-drive centrifugal pump with a rated flow of 7.6 liters (2 gallons) per minute. All piping is made of nickel because of its corrosion-resistance to high-temperature caustic. The caustic transfer system is equipped with two automatic flow-control valves, as follows:

- One automatic flow-control valve would divert approximately 3.8 to 7.6 liters (1 to 2 gallons) per minute of the caustic sodium hydroxide solution from the caustic recirculation line to the product fill line. This diversion would be set to maintain a specified level in the reaction vessel.
- The other flow-control valve would direct caustic sodium hydroxide solution to the caustic cooling tank during process shutdown.

E.2.4.3.8.6 Product Offload

When the level of caustic sodium hydroxide solution in the reaction vessel reached the control set point, an automatic valve would open to divert this product solution from the discharge of the caustic recirculation pump to the ISO tank via a product fill line. The product fill line is a concentric pipe, counter-flow heat exchanger that has an inner pipe (nickel) utilized for high-temperature sodium hydroxide and an outer pipe (stainless steel) containing a coolant (chemically treated water). The fill line is routed from the process area to the product area.

After an ISO tank was placed in the product area and the fill line nozzle was connected, an operator would actuate a switch at the offload station control panel to begin the ISO tank fill process. If the level of caustic sodium hydroxide solution in the reaction vessel were above the level control set point, it would enable the opening of an automatic valve that would divert caustic sodium hydroxide solution to the product area. The caustic sodium hydroxide solution passing through the product fill line's concentric heat exchanger would be cooled prior to entering the ISO tank.

When sensors indicated that the ISO tank was full, the operator would actuate another switch at the offload station control panel to temporarily reroute the product to the caustic storage tank. This lineup would allow processing to continue until another ISO tank was connected to the fill-line nozzle. At this point, the full ISO tank could be sampled by an operator to verify product quality. It would then be sealed and surveyed by a health physics technician to verify outer cleanliness and contact radiation levels. It would then be moved aside to one of the storage bays, and another ISO tank would be put in place to begin the filling process.

E.2.4.3.8.7 Service and Suspect Water Systems

Two separate water systems—the service and suspect water systems—make up the SPF water system. The service water system is a clean potable water system. Its functions are to cool the offgas condenser and to serve as a heat sink for the product fill heat exchanger. The service water is supplied to the SPF from a sitewide source at approximately 690,000 pascals, gauge (100 pounds per square inch, gauge) through galvanized-steel piping. The primary purpose of the suspect water system would be to provide the water injected into the reaction vessel that controls the main processing temperature. It also would provide baffle sprays in the reaction vessel and makeup water to the offgas scrubber. The primary sources of the suspect water in this system would be the condensation and drains from the offgas system. This water would be potentially contaminated with radioactive constituents. The drains would be collected in a small collection vessel and pumped to the 1,900-liter (500-gallon) water holding tank. A pump would then take suction on the water holding tank and discharge it to the reaction vessel. Makeup water to the system would be supplied to the water holding tank from the MFC's deionized water system.

E.2.4.3.8.8 Caustic Offgas System

The system is designed to perform the following actions:

- Contain and recycle water vapor and caustic carryover from the reaction vessel.
- Discharge the gases produced during the process of converting sodium to sodium hydroxide.
- Discharge the nitrogen that collects in the vessel from the various purges in the reaction system.
- Provide filtration, cleaning, and monitoring of gases and particulate carried over in the offgas stream in accordance with environmental and engineering standards prior to discharging to the environment.

The caustic offgas system is composed of the following components, as well as interconnecting piping (components are listed in flow path order).

- Reaction vessel baffles
- Reaction vessel demister
- Offgas condenser
- Mist eliminator (mesh-type)
- Scrubber
- Moisture separator (vane-type)
- Parallel prefilters (with polypropylene material)
- Parallel HEPA filters
- Building discharge piping

The principle constituents in the caustic offgas stream as it exited the reaction vessel would be water vapor, hydrogen, and nitrogen. Hydrogen is a reaction product of sodium and water and would make up approximately 60 to 70 percent of the offgas stream volume at the rated sodium injection rate of 23 liters (0.6 gallons) per minute to the reaction vessel. Nitrogen would be used to atomize the sodium in the reaction vessel injection nozzles, to do the initial purge of the reaction vessel and offgas system, and to provide an inert cover gas in all process system tanks and vessels to eliminate oxygen. The caustic offgas system would process this gas stream and ultimately release hydrogen and nitrogen outside the SPF building to the atmosphere and return the condensed water vapor to the reaction process. Condensate would be returned to the water holding tank through a series of drain lines.

E.2.4.3.8.9 Vent Systems

Two independent vent systems are associated with the sodium process area and 15,000-liter (4,000-gallon) caustic storage tank. All vent system piping is carbon-steel. The vent systems would collect gaseous effluents from all tanks in the sodium process area, including the following:

- 19,000-liter (5,000-gallon) sodium storage tank
- 2,760-liter (730-gallon) sodium day tanks
- 3,800-liter (1,000-gallon) caustic cooling tank
- 15,000-liter (4,000-gallon) caustic storage tank
- 1,900-liter (500-gallon) water holding tank

E.2.4.3.8.10 Steam System

Steam would be used to clear the injection nozzles in the reaction vessel in the sodium process area. The 1.2 million pascals, gauge (175-pounds-per-square-inch, gauge) steam from the site steam supply would be reduced in pressure to 200,000 to 350,000 pascals, gauge (30 to 50 pounds per square inch, gauge [measured in respect to atmospheric pressure]).

E.2.4.3.8.11 Nitrogen System

Because of the reactive nature of sodium, nitrogen gas would be utilized in the SPF as the primary source of inert gas supplied for all applications requiring a cover gas or motive force.

E.2.4.3.8.12 Control Air System

The compressed air system is supplied by a 25-horsepower air compressor that would provide cool, filtered air at >690,000 pascals, gauge (>100 pounds per square inch, gauge) for the following uses:

- Operate the barrel-tilting mechanism for the melting-draining operation.
- Operate the pneumatically actuated valves in the sodium, caustic sodium hydroxide solution, and vacuum piping.
- Operate the pneumatic tilting device to move drums of caustic sodium hydroxide solution to the drum palletizing area.

E.2.4.3.8.13 Process Computer System

The SPF processes would be monitored and controlled using a computer control system consisting of the following components:

- A main control computer
- A graphics computer
- Two bus computers

Process instrumentation and actuators are connected to the computer control system through input/output channels on the two bus computers. Operators would interact with computer color graphics screens to control and monitor the processes. For certain portions of the process system, operators would interact with the control system through pushbutton/indicator panels located in specific process areas (ANL-W and Fluor Hanford 2002).

E.2.4.3.8.14 Sodium Throughput

The SPF processed sodium at a nominal rate of 2.3 liters (0.6 gallons) per minute, resulting in about 136 liters (36 gallons) per hour, or 3,220 liters (850 gallons) of sodium processed per day. At this rate, approximately 7,600 liters (2,000 gallons) of 50 weight-percent caustic sodium hydroxide solution could be produced each day; thus, 2 days would be required to fill a 15,000-liter (4,000-gallon) ISO tank.

The SPF processed approximately 680,000 liters (approximately 180,000 gallons) of EBR-II and Fermi sodium in just over 2 years. The plant utilization factor steadily increased over this period. During the initial startup of the SPF, the plant factor was low while engineering personnel refined the process's performance and operations personnel gained experience in how to run the process most efficiently. This is represented by a plant utilization factor of only 11 percent achieved in the first 3 months of process operation. As experience was gained and lessons learned were implemented, the plant utilization factor increased until an average of approximately 62 percent was achieved for the last 6 months of operation. A projected plant utilization factor of 65 percent for resumed operation of the SPF, or the operation of a completely new facility, is well within expectations due to further implementation of lessons learned. In addition, production of 50 weight-percent caustic sodium hydroxide solution rather than a 70 weight-percent caustic would be much easier on systems and components, resulting in less downtime for repairs and maintenance (ANL-W and Fluor Hanford 2002).

E.2.4.4 Remote-Handled Special Components Processing

E.2.4.4.1 Fast Flux Test Facility Remote-Handled Special Components Description

Removal of FFTF RH-SCs would be completed under the deactivation work and is evaluated within the 2006 EA (DOE 2006). The removed components would be stored within the FFTF complex until the selected treatment facility has been built and is ready to receive the components.

As background, FFTF RH-SCs include: the primary cold trap (N-5), the cesium trap (N-3), and two sodium condenser vapor traps (U-527 and U-532), and the associated filter vapor traps (VT-61, VT-62, VT-63, and VT-64). Each of these components has a high radiation dose level due to the presence of high-energy gamma-emitting fission products (primarily cesium-137). The primary cold trap and the cesium trap both contain sodium residuals (Fluor Hanford 2005c). Each of these components would require remote operations to disconnect and isolate the traps from process system piping, to cap or blind off inlets and outlets, and to remove them from the facility. Isolation and removal of these components is a major activity that must be completed before other D&D activities can occur.

The current plan is to leave the sodium residuals frozen in the traps until after removal and to transport the traps to an interim storage facility (Fluor Hanford 2005c). For analysis purposes, it was assumed due to the uncertainty in inventory that the two vapor traps (U-527 and U-532) also include their respective filter vapor traps. Two alternatives were analyzed for treatment of these RH-SCs. The first alternative is treatment in a new INL facility located at MFC and under consideration to handle similar waste streams at INL. The **Draft Environmental Assessment for the Remote-Handled Waste Disposition Project** (DOE 2008) analyzed four alternatives for the treatment of the INL and FFTF RH-SC waste streams ranging from use of existing facilities at the Idaho Nuclear Technology and Engineering Center (Preferred Alternative) to use of new facilities at MFC (EA Alternative 4). The second alternative is to treat these components at a new facility constructed at Hanford. This new facility would be designed and constructed the same as the INL facility. However, there is currently no NRC-licensed transportation cask with the capacity to handle these traps for shipment to INL. Therefore, this EIS assumes that a transportation cask or other shielded container would exist at the time of removal to transport the components to an interim storage facility either at Hanford or at INL. Vehicle emissions for transport of the components on site at Hanford or off site to INL were calculated and included in this EIS (SAIC 2007b).

Disposal of the decontaminated RH-SCs would be handled in a number of ways. Under the Hanford Option, the RH-SCs would be disposed of in an IDF at Hanford. However, under the Idaho Option, the decontaminated RH-SCs would be either packaged and sent to Hanford for disposal in an IDF or packaged and sent to NTS for disposal. For analysis purposes, it was assumed that, under both options (i.e., Hanford or Idaho Options), disposal of the decontaminated RH-SCs would take place at Hanford in an IDF or at NTS.

The radionuclide inventory of the FFTF RH-SCs is summarized in Table E-16.

Table E–16. Fast Flux Test Facility Remote-Handled Special Component Inventory Summary

| Component | Sodium Residuals Volume (gallons) | Contact Dose Rate ^a (rem per hour) | Inventory ^a (curies) | Isotope |
|--------------------------------|-----------------------------------|---|---------------------------------|------------|
| Cesium Trap | 80 | 60 | 210 | cesium-137 |
| Cold Trap | 710 | 10 | 470 | cesium-137 |
| | | | 70 | cobalt-60 |
| 5-scfm Vapor Trap ^b | <1 | 5 | 90 | cesium-137 |
| 1-scfm Vapor Trap ^b | <1 | 0.6 | 5 | cesium-137 |

^a The contact dose rates and inventories are assumed or estimated. The isotope inventory is based on the assumed/estimated contact dose rate (i.e., an inventory of either 94 curies of cesium-137 or 14 curies of cobalt-60 would result in the estimated 2-rem-per-hour contact dose rate for the cold trap). Date of estimate was 2005.

^b Includes two filter vapor traps.

Note: To convert gallons to liters, multiply by 3.7854.

Key: scfm=standard cubic feet per minute.

Source: CEES 2006e.

Currently, no facility exists within the DOE complex for handling or treating the RH-SCs. DOE has proposed construction of a new facility, the RTP, at INL’s MFC. This facility is identified on the INL Site Treatment Plan and DOE has initiated a NEPA review process (an EA) for the RTP. However, completion of this EA is not expected to support issuance of this TC & WM EIS. Therefore, this EIS analyzes two options within FFTF Decommissioning Alternatives 2 and 3 for processing the RH-SCs, as follows:

- Removal and storage of the RH-SCs on site at Hanford until a new facility is permitted and built, followed by disposal in an IDF at Hanford
- Removal and shipment of the RH-SCs to INL for treatment in the proposed RTP, followed by shipment and disposal in an IDF at Hanford

The Idaho National Laboratory, *Conceptual Design Report for the Remote Treatment Project, Annex to the Hot Fuel Examination Facility* (ANL-W 2004) describes a workable concept, an annex to the Hot Fuel Examination Facility (HFEF), for processing RH waste from INL and for handling and shipping the output waste streams. This concept has been applied to both INL and Hanford for the analyses described in this TC & WM EIS.

At INL, the RTP would be located adjacent to the HFEF, which is located within the MFC. Locating the RTP contiguous to the HFEF would result in significant cost savings from the sharing of important, high cost equipment and systems. Annexing the facility to the HFEF also allows sharing of the HFEF’s synergistic workforce. The RTP would be located directly west of the HFEF. The proposed site is currently occupied by two large fuel oil storage tanks located within a spill confinement berm. This site would be cleared and excavated for construction of the RTP. The fuel oil storage tanks would be relocated.

At Hanford, the RTP would be located within the T Plant complex in the 200-West Area and would have the same design as the INL RTP, except that a new cask-unloading high-bay area would be required at Hanford. The INL RTP would utilize the HFEF for this function. Thus, equipment and resource utilization at the Hanford RTP (e.g., structural steel) would be slightly higher than that at the INL RTP because of the new construction required for the cask-unloading high-bay (SAIC 2007b, 2008).

E.2.4.4.2 Remote Treatment Project Process and Facility Descriptions

Turnkey support for the waste processing operations would be key to the success of the RTP at either Hanford or INL.

Annexing the RTP at INL to the existing HFEF, however, would take advantage of two primary design features that would facilitate this objective: (1) a waste-processing cell that could be used to prevent the release of radioactive and hazardous contaminants to the environment and (2) waste processing equipment that is designed to handle and process a variety of the RH and CH wastes that may be received in Radioactive Scrap and Waste Facility (RSWF) storage liners, 208-liter (55-gallon) drums, and large waste boxes. Design, fabrication, and installation of the waste-processing equipment would be segregated into campaigns based on need and space. The equipment in the waste-processing cell could be modified, removed, or replaced based on waste-stream characteristics.

As the proposed remote treatment process and RTPs at INL and Hanford would be nearly identical, the following descriptions apply to both.

E.2.4.4.2.1 Process Flow Description

Waste would always enter the processing cell in some type of packaging. The first task would be to open the package and extract the waste. At INL, for example, waste liners from the RSWF would be opened at the liner-disassembly station. CH debris created during disassembly would be placed into 208-liter (55-gallon) drums, which would then be placed into standard waste boxes for transport and disposal at an appropriate CH disposal facility, depending on the character of the waste. Any RH debris that is generated would be transferred to the RH-waste processing area, sorted at the waste sorter station, and size-reduced so that it could be packaged for removal and disposal. Technicians working with remote manipulators at the hot cell windows would perform visual segregation and characterization. Samples would be extracted and sent to the Analytical Laboratory for quantitative analysis. Figure E-45 shows a simplified waste processing flow diagram.

Other processes would involve use of specialized handling equipment to open specific types of waste containers. There also would be a need to remove sodium from waste components in much of the waste. A melt-and-drain station would be provided at a window for this purpose. The separated sodium would be treated either within the RTP or at another facility. Use of an induction melter station based on an existing design is foreseen for volumetric consolidation of wastes that require deep geologic disposition. Other waste-handling and treatment equipment would be installed in the cell as needed for more specific or future waste processing campaigns.

Waste package handling would occur when waste shipments are received by over-the-road trucks with trailers carrying shielded casks or waste containers. The over-the-road truck and trailer would be backed into the truck lock (at the HFEF in the case of INL). The payload would be accessible to a high-bay overhead bridge crane (also located at the HFEF at INL). After proper dismantling of any impact limiters and other protection devices on the payload, it would be lifted off the trailer and placed upright onto a cask cart in the cask tunnel.

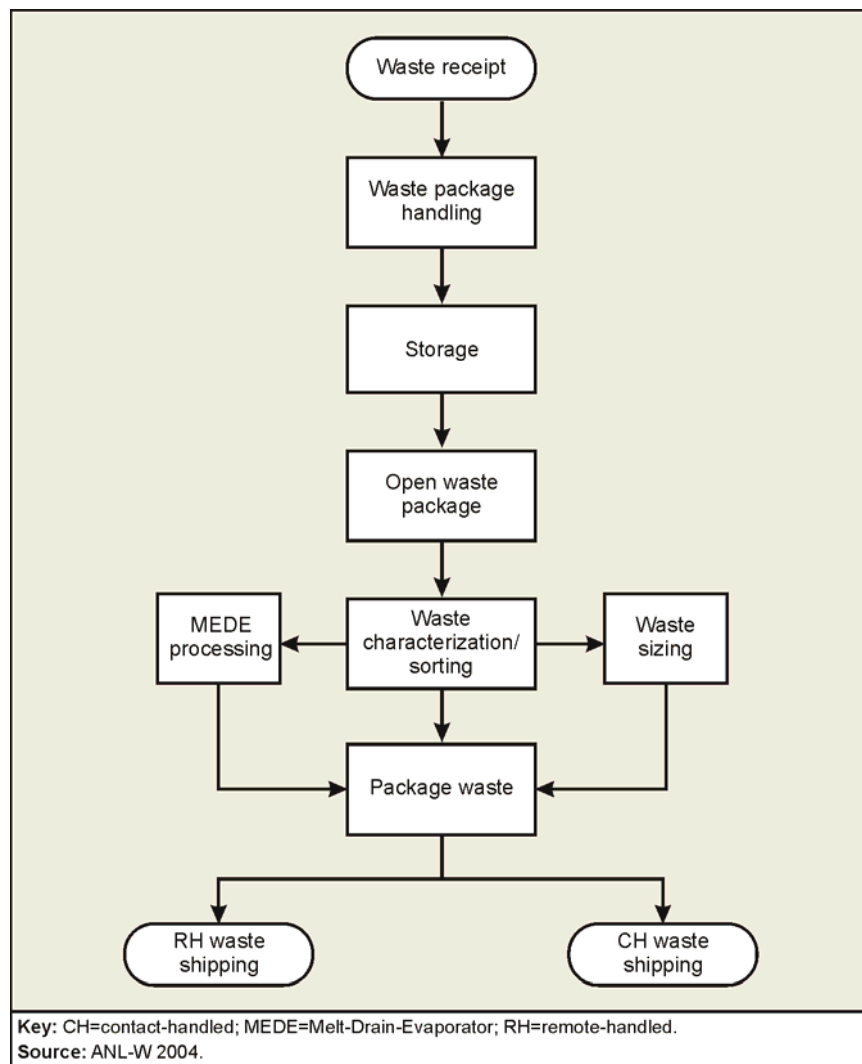

Figure E-45. Simplified Waste Processing Flow Diagram for Remote Treatment Plant

A detailed process flow diagram is provided in Appendix C of the **Idaho National Laboratory, Conceptual Design Report for the Remote Treatment Project, Annex to the Hot Fuel Examination Facility** (ANL-W 2004). After loading the cask onto the cask cart, a shield ring or bagging ring would be placed on top of the cask. The cart would be moved along its rails into the cask tunnel. Once in the tunnel, the cask cart would be positioned under a cask penetration leading up into the waste-processing cell. The bottom side of the cask penetration in the cask room would have an integral bagging ring. A polyvinyl chloride (PVC) plastic sleeve would be connected between the bagging ring on the cask top and the bagging ring on the cask penetration to provide a contamination barrier against the release of contamination when the top of the cask and the cask penetration are opened. Actuation of the cart's cask-elevating mechanism would lift the top-loaded casks and mate them to the cask penetration in the waste-processing cell floor to enable the in-cell crane to extract the waste container from the cask.

After unloading, the cask would be lowered and the bagging sleeve would be heat-sealed between the two sleeve ends. The interior surfaces of the exposed cask top would be cleaned. The emptied cask would then be returned on the cart to the truck lock (at the HFEF in the case of INL) where the cask's lid would be reinstalled. The overhead crane would lift the cask off the cask cart and place it on the transport

trailer. The cask would be prepped for shipment, and the over-the-road truck and trailer with the empty cask would be moved out of the truck lock to the exterior for parking or transport to an offsite location.

After the waste has been transferred into the waste-processing cell, a variety of processing equipment would be used to store, sort, size, process, and repackage the waste. These processes are described in detail in the sections that follow.

The process for transferring processed waste out of the cell would utilize a bagging penetration located in the floor of the waste-processing cell. The penetration would be similar to the cask penetration in that it would have a shield plug with a bagging ring on the underside of the penetration to allow the sealed bagging-in or -out of waste and materials.

Below the penetration would be a bag-out room, which would have an elevating mechanism, such as a scissor-lift, to support the shipping container in which the waste is loaded. This room would accommodate packaging of an LLW 170-liter (45-gallon) inner waste canister, a 110-liter (30-gallon) sodium waste container, or a 208-liter (55-gallon) plastic drum liner into a 208-liter (55-gallon) overpack drum or a designated waste box. The penetration port in the ceiling of this room would have a bagging ring for use with PVC bags sized to fit into the overpack container. The overpack container would rest on a movable electric forklift, and a scissor-lift platform would be located underneath the transfer port. The forklift and scissor-lift would have a 900-kilogram (2,000-pound) safe working load. The bottom of the PVC bag would be placed inside of the overpack container.

Waste canisters would be lowered down into the overpack container using the cell bridge crane. After the bag has been sealed and cut, a lid would be placed on the overpack container, and it would be moved to the storage area to await transfer out of the facility. A motor-operated lid on the bag-out room side would cover the transfer port in the roof of the drum-bagging room when the port is not being used. The bag-out room would include a jib-mounted plastic heat-sealer that would swing out from the wall to seal the PVC bags. The drum or container would be moved out of the bag-out room and then loaded onto an over-the-road truck and trailer in a similar fashion to cask transfers.

E.2.4.4.2.2 In-Cell Equipment and Operations

Equipment necessary to process initial waste from the INL MFC RSWF liners and their contents, waste cans, and other material) would be similar to other equipment designed and long used at various INL facilities. Maintaining commonality in this fashion would enhance the effectiveness and safety of operations.

The proposed equipment includes the following:

- Liner-disassembly station
- NDA
- Waste can size-reducing device
- Sodium removal system (melt-drain-evaporator [MEDE])
- Waste-sorting station
- Induction melter
- Melter equipment handling station
- General-purpose work tables

Equipment necessary to process the remaining RH waste that does not come from the RSWF would be generally limited to sorting and size-reduction; therefore, a sorting table with size-reduction capability would be provided. Additional equipment would be provided based on waste treatment needs.

E.2.4.4.2.3 Liner-Disassembly Station

The liner-disassembly station would be capable of handling, unloading, and disassembling both the 41-centimeter (16-inch) and 61-centimeter-diameter (24-inch-diameter) RSWF liners and the waste cans. The station would consist of an elevator and a rotational drive assembly, a table with limited vertical and horizontal motions, and a multi-axis remotely controlled robot arm that operates a cutting tool. The liner-disassembly station would be located at a window.

When a liner is brought into the hot cell, it would be transferred to the liner-disassembly station, where it would be placed on the elevator stand/rotational drive and clamped into place. The liner would be lowered into the pit using the disassembly station elevator assembly to align the cutting tool with the top of the liner. The liner would then be rotated and the lid of the liner would be cut free.

A pair of PaR Systems 6350 telerobotic manipulators would be located near the Liner Disassembly Station to aid in disassembly of the liners. These manipulators may be table- or wall-mounted. The manipulators would provide a 113-kilogram (250-pound) lifting capacity to aid in the automated cutting and handling of the liners. These manipulators have a 1.8-meter (6-foot) reach, are radiation-resistant to a 1.0×10^9 rads cumulative dose, have 6 degrees of freedom, and are remotely maintainable. A variety of end-effectors would be used to help cutting tools and grippers lift and move heavy components.

The liner lid would be removed and placed into a CH-waste container using the PaR telerobotic manipulators. Once the lid has been removed, and depending on the configuration, either the shield plug would be removed and set aside or a portion of the gravel would be vacuumed out of the 41-centimeter (16-inch) liner. The cutting tool would then be used to cut the top portion of the liner, which would be placed into a CH-waste container. This process would continue until the inner waste storage can was exposed and could be removed. Figure E-46 shows a sketch of the liner-disassembly station.

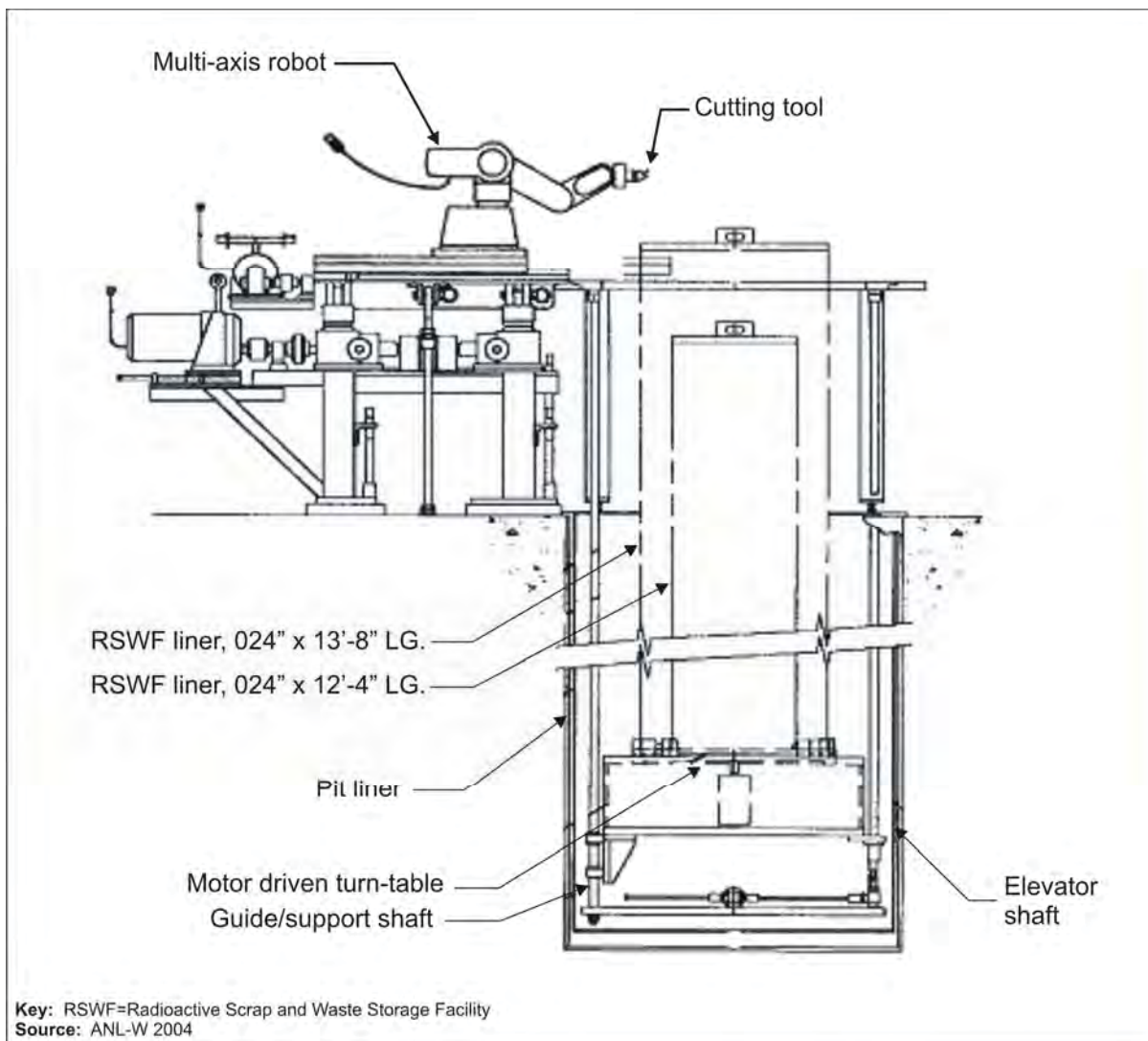

Figure E-46. Liner Disassembly Station

E.2.4.4.2.4 Nondestructive Assay

Two major NDA process categories would be needed in the RTP: item assays and package assays. Item assays would be used to quantify identifiable, separate items encountered in the repackaging process. Package assays would be used after items have been packaged for shipment. These would be primarily confirmatory measurements. Both categories would use the same basic NDA techniques, but item assays would be more accurate because uncertainties arising from the unknown geometries of packaged items would be either reduced or eliminated.

Both categories would use qualitative gamma-ray spectroscopy (for isotope identification) and quantitative gamma-ray spectroscopy, such as segmented gamma scanning, tomographic gamma scanning, and whole-item corrected assays (to quantify isotopes whose gamma rays are detectable). Fissile isotopes are not expected to be directly detected in this manner, however.

Both categories would use passive and active neutron-measurement methods to quantify fissile materials. Passive methods would count coincident neutrons primarily from plutonium-240 decay, while active methods would induce and count fission neutrons (usually with a coincidence counter) from plutonium-239 and uranium-235. Specific instruments would include the passive-active neutron and the

shuffler (which is usually active, but can be passive also). A shielded measurement system with a passive coincidence counter may also be used.

The NDA system would consist of a shielded pipe in the NDA subcell. This pipe would contain an elevator and a turntable to position and rotate the item or waste can within the counters, as well as a shield cover at the top opening at floor level in the RH room. The item or can would be placed on the elevator with the electromechanical manipulator or overhead crane; the elevator would be lowered until the shield cover could be closed, and the object would be lowered and/or rotated in the detectors. After counting, the shield cover would be opened and the object would be retrieved. The instrumentation room could not be manned during operation.

E.2.4.4.2.5 Waste Can Size-Reducing Device

The waste can size-reducing device would be located in the air cell at a window. The waste can size-reducing device would either compact the waste can tubes or cut the tubes into smaller pieces suitable for denser packing in waste containers such as 208-liter (55-gallon) drums. This machine would be used for CH waste only.

E.2.4.4.2.6 Sodium Removal System

Much of the RH waste from the RSWF is contaminated with sodium that must be removed or treated prior to shipment. The MEDE system is currently being evaluated for this purpose. The main components of the MEDE system are the vessel, heater, vacuum pump, and sodium-storage tank. The MEDE would be located at a window. Figure E-47 is a sketch of the MEDE process equipment.

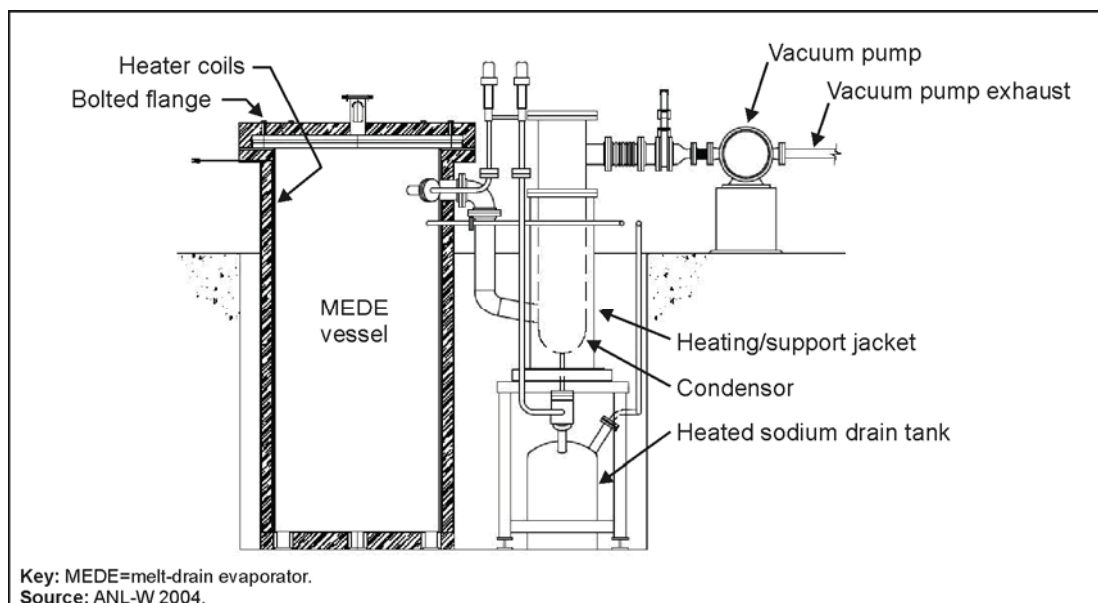

Figure E-47. Melt-Drain-Evaporate Process Equipment

Using the MEDE process, material to be processed would be placed in an evaporation vessel where it would be heated to melt and drain the sodium. The vessel would be heated further under vacuum to remove the sodium from crevices. Tests completed at INL's MFC showed the MEDE system to be capable of removing sodium from metal samples that had 20-centimeter-deep (8-inch-deep) crevices and from a slot that was 5 centimeters (2 inches) long and only 0.01 centimeters (0.005 inches) wide. Tests completed as part of a Fermi reactor fuel-processing cost estimate at INL's MFC demonstrated greater than 99 percent removal from a fuel cladding annulus over 30 centimeters (12 inches) long with approximately 0.02-centimeter (0.010-inch) clearance. This was noteworthy in that higher temperatures,

approximately 650 °C (1,200 °F) were used to decrease the vacuum required, allowing relatively simple and inexpensive commercial dry vacuum pumps to be used instead of oil-sealed or cryogenic pumps (ANL-W 2004).

The majority of the sodium and sodium-potassium present in the waste streams would be contained in bulk in a few of the stored components and could be largely removed using the melt-and-drain step. Sodium metal can be removed by the distillation cycle, but oxide or hydroxide films cannot. Therefore, the system would be provided with a moist carbon-dioxide gas stream to react either sodium residuals films or reaction product films to produce sodium carbonate, the desired final stable form, and the reaction product could be removed by water-washing if required. CH sodium and sodium-potassium metal removed from the waste streams would be commingled and removed from the cell and deactivated at another facility, while RH sodium and sodium-potassium would be accumulated and later remotely deactivated using equipment.

E.2.4.4.2.7 Waste-Sorting Station

The waste-sorting station would be used to disassemble waste cans and to remove, resize, and sort the waste into various waste containers. The waste-sorting station would be composed of a support-table assembly, a stand with a vertically driven waste can clamp, a rotating waste can cutting head, a sorting table, a chop saw, and storage locations for various waste containers.

When a waste can (approximately 30 centimeters in diameter and 183 centimeters long [12 inches in diameter and 72 inches long]) is transferred to the waste-sorting station, it would be placed in the clamp assembly. The cutting head would be moved into position and attached to the waste can, then rotated to cut off the lid. The cut lid would be removed using the electromechanical manipulator and placed into a waste container. The electromechanical manipulator would lift the inner waste can out of the outer waste can and place it in a temporary storage compartment in the table. The outer can would be inverted using the rotating clamp, and the bottom of the can would be removed using the cutter. The can bottom would be placed into a waste container. The electromechanical manipulator would be used to pick up the waste can tube and transfer it to the waste can size-reducing device located in the CH room. The size-reducing device would compact the tube or cut it into pieces suitable for denser packing in a waste container.

The inner waste can that was temporarily stored in an insert in the table would be lifted using the electromechanical manipulator and set into the clamp. The top lid would be either unbolted or removed using the cutter, and the lid would be placed into a waste container. The inner waste can would be lifted and rotated so that the contents would fall into the sorting tray. The inner waste can would be completely inverted, and the cutter would be used to remove the bottom of the container. The bottom of the inner waste can would be placed into a waste container. The electromechanical manipulator would be used to pick up the inner waste can tube and transfer it to the waste can size-reducing device in the CH room. The size-reducing device would either compact the tube or cut it into pieces suitable for denser packing in a waste container.

The waste in the sorting tray would be segregated into the various types of waste and placed into appropriate waste containers for each waste type. If the waste were subassembly hardware, it might be resized using the chop saw and the pieces placed into the melter crucible. Some of the waste might require additional NDA for accurate characterization. These items could be placed into a new inner waste can and transferred to the NDA cell, after which they would be returned and sorted.

E.2.4.4.2.8 Induction Melter

Graphite crucibles would be placed into and removed from the insulation assembly from the top. An insulated lid would cover the top of the crucibles. This new insulation assembly would be capable of melting waste at 1,700 degrees °C (3,092 °F). A typical crucible run would follow these steps:

(1) prepare the crucible assembly; (2) load charge materials into the crucible assembly; (3) lower the crucible assembly into the melter; (4) place the lid on the crucible assembly; (5) install the vacuum vessel lid; and (6) evacuate the vessel and backfill with argon, if needed. One melter heatup-cooldown cycle would take approximately 24 hours.

If constructed at Hanford, the induction melter design would follow that of the HFEF Metal Waste Melter at INL, with the addition of an insulation extension and a modified crucible assembly to accommodate longer feed materials. Use of the induction melter would improve volumetric packaging in waste containers while avoiding the particulate contamination created by other mechanical size-reduction techniques. Figure E-48 is a sketch of the induction melter.

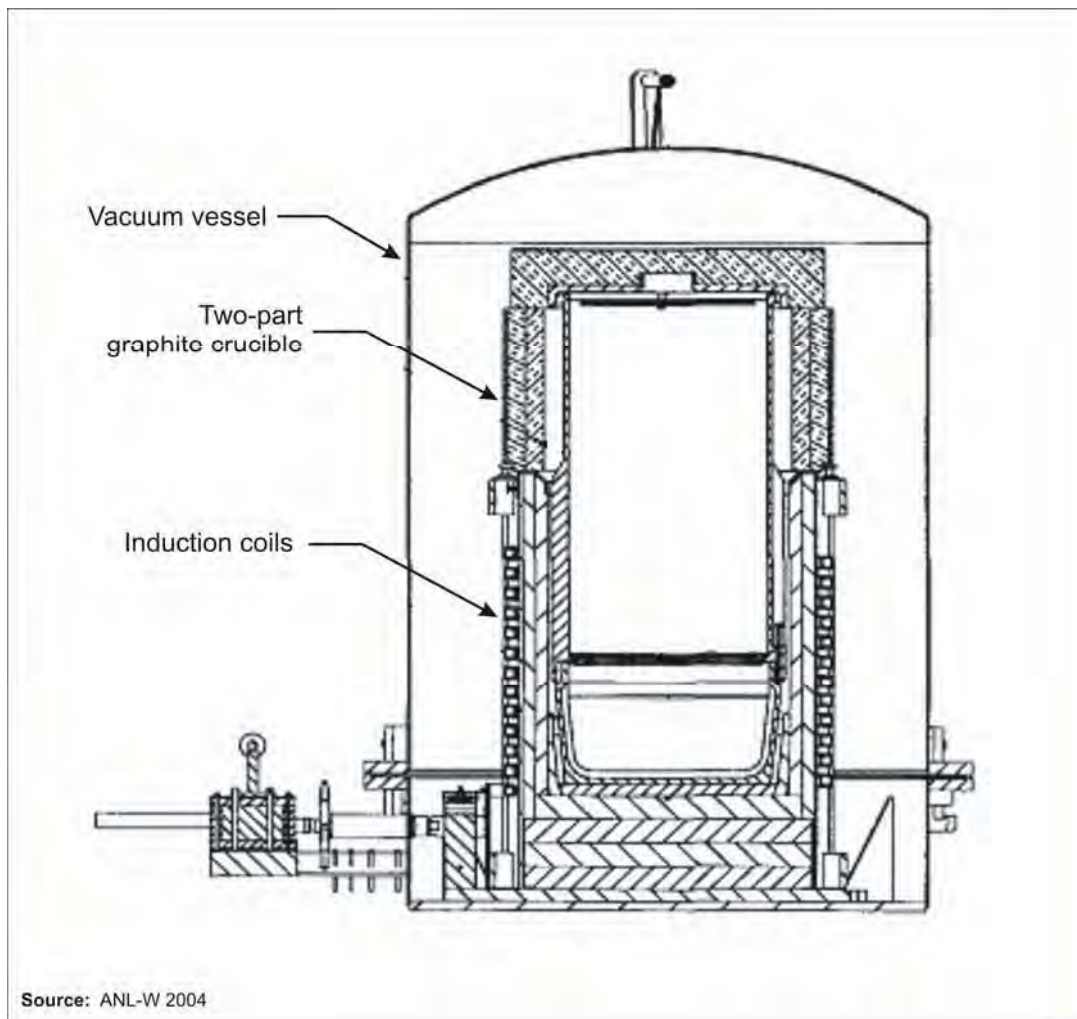

Figure E-48. Induction Melter

E.2.4.4.2.9 Melter-Equipment-Handling Station

The melter-equipment-handling station would be used to prepare and load crucibles, to dump and sample the ingots, and to package the ingots into waste cans. The station would consist of a modular worktable, including a crucible-dumping/cleaning fixture; sampling equipment; a crucible-loading station; and a balance; as well as ingot, crucible, and tool-storage locations. The processed ingots would typically weigh approximately 100 kilograms (220 pounds) based on a high-void-fraction charge.

After completion of the melt-processing, the crucible containing the ingot would be removed from the melter and transferred to the melter-equipment-handling station. The crucible would be placed in a crucible inverter, and the top portion of the crucible would be removed and set down on the table. The bottom portion of the crucible would be clamped into the inverter. An ingot catch-plate would be attached to the inverter, and the crucible and ingot would be inverted. Pins would be removed, and the inverter with the bottom crucible would be lifted off the inverted ingot and catch-plate. The ingot would be weighed and then placed in a waste can using a tong-type lifting device and the electromechanical manipulator.

E.2.4.4.2.10 General-Purpose Worktables

The worktable would be used to perform equipment repairs using the remote manipulators and for general tasks. The worktable would have a scale for weighing containers and equipment for resizing hardware. The tables would be made of steel structural tubing and would have removable lids covering insert locations used to store tools and small equipment items.

E.2.4.4.2.11 High-Efficiency Particulate Air Filter Processing

A HEPA-filter-preparation station would be used to separate the filter media from the filter frames. The radioactively contaminated HEPA filters are approximately 610 millimeters long by 610 millimeters wide by either 15 centimeters or 30 centimeters thick (24 inches long by 24 inches wide by either 6 inches or 12 inches thick). The frames are either steel or wood, and the media consists of aluminum separators and fiberglass paper. The HEPA-filter-processing equipment would consist of a staging area table, a punch press and die assembly, a size-reducing device, and a receiver-can-positioning assembly. The removed filter media would be size-reduced and transferred to additional equipment that would transform the filter media into a powder and mix it with concrete in 208-liter (55-gallon) rigid-plastic drum liners. This additional equipment would consist of a melter, a grinding machine, a hammer mill, and a mixing station to mix the filter media powder with concrete.

The HEPA filter frames would be resized at the waste can size-reducing device if the contamination levels were sufficiently low, and the debris would be placed in the appropriate waste containers. If the contamination levels were high, additional size-reducing equipment would be required for the RH-waste processing area (ANL-W 2004).

E.2.4.4.2.12 Remote Treatment Project Description

The RTP would provide a shielded, air-atmosphere, processing cell designed to ensure complete and reliable containment of particulate radioactive material. In addition, the facility would provide support areas, including an administrative area, restrooms and locker rooms, a hot equipment repair area, a loading dock, a cask-handling area, and adequate space for equipment (e.g., mechanical, electrical, material handling, waste handling/processing, and backup diesel-fuel-powered generator). The facility design also would incorporate flexibility to accommodate potential mission changes during the life of the facility.

The facility would be a concrete and steel structure with planned dimensions of approximately 22 meters wide by 29 meters long (72 feet wide by 94 feet long) and an approximate height of 20 meters (66 feet) above grade. The facility would consist of four separate floors: the service floor (basement), the operating floor (grade level), the utility floor, and the high-bay floor. The total floor area (all four floors) would be approximately 2,600 square meters (28,000 square feet). Each of the floors is described in the following paragraphs.

The main features and equipment of the service floor would include a cask tunnel; an NDA cell; heating, ventilation, and air-conditioning supply and exhaust systems; an air compressor; and miscellaneous

electrical and water systems. If constructed at Hanford, the cask tunnel would be an approximately 16.8-meter-long (55-foot-long) extension of the HFEF cask tunnel at INL and would provide access to the facility for cask-compatible RH waste.

The NDA cell port would be located at the south end of the waste-processing cell. This penetration would allow RH waste to be lowered into a shielded cavity where active systems such as a pulsed-neutron source could be set up. In addition, a passive system such as gamma spectroscopy or coincidence-neutron measurements could also be used to interrogate RH-waste streams. This penetration would be sealed to maintain the cell environment and to prevent the release of contamination to the NDA cell. A data-acquisition room would be located outside the NDA cell in the service-floor area.

The operating floor would house the heavily shielded waste-processing cell, the loading dock, and the administrative areas. Office space for engineers and technicians would be provided in other existing, nearby facilities. An enclosed personnel passage at ground level would provide sheltered access between the truck lock and the RTP.

The utility floor would house the majority of the electrical panels and cabinets, thereby freeing up space on the operating floor around the processing cell. Restrooms and locker rooms also would be located on this floor. In addition, this floor would have a shielded personnel-access door leading to an upper gallery of the processing cell to allow hands-on repair of in-cell crane drive modules.

The high-bay floor would house the hot repair area, which would consist of a decontamination chamber, a glove wall, a remote-manipulator repair glovebox, an equipment-storage area, and a horizontal car-transfer station. A hatch on the roof of the waste-processing cell would enable equipment and waste to be lowered directly into the cell. The glove wall would be used to repair small components, prepare samples, and conduct bench-top experiments. In addition, there would be space for staging areas, dressing rooms, and a Health Physics counting room.

A diesel generator for standby electrical power would be housed apart from the main structure in a lightweight pre-engineered enclosure. The foundation and floor for the diesel generator building would be totally separate from that of the main structure.

A security vulnerability would be eliminated from the storage tank relocation by locating the fuel oil unloading station outside of the security interest area. The pumping station would be located in a new, small building outside of the fenced complex. This would eliminate the necessity of fuel trucks entering the main laboratory area. Fuel oil would be piped from the unloading station to the new location of the fuel oil storage tanks. The access area around the pumping station would be paved and sized to accommodate the maneuvering of a semitrailer-truck with another tanker-trailer (ANL-W 2004).

E.3 WASTE MANAGEMENT

E.3.1 Current Hanford Site Solid Waste Operations Complex

Each current Solid Waste Operations Complex (SWOC) facility performs duties to achieve Hanford's waste management goals. These duties are generally complementary, and each facility contributes to the overall process. However, some processes and activities are performed at more than one facility, either because it is necessary or because it maximizes flexibility and project efficiency. The primary processes for each facility include receipt, staging, storage, repackaging, treatment, and shipment of waste, all of which must comply with the waste acceptance criteria. By facility, those activities are as follows:

- **LLBGs:** Retrieve suspect TRU waste, LLW and MLLW; dispose of LLW and MLLW; store certain RH wastes.

- **CWC:** Provide interim storage of LLW, MLLW, TRU waste, mixed TRU waste, and certain RH wastes (limited treatment and drum processing is planned for the CWC).
- **T Plant:** Clean out stored waste and contaminated equipment; store waste; decontaminate equipment; verify, sample, treat, and repack LLW, MLLW, TRU waste, and RH wastes.
- **WRAP:** Confirm, repackage, certify, sample, assay, perform NDE, and treat LLW, MLLW, and TRU waste for disposal.

The overall SWOC process flow is based on waste type, i.e., LLW or TRU waste. The process flow follows each waste type through generation, storage, treatment, and disposal. LLW or MLLW can be generated either on or off site. Once generated, the waste can be staged or stored at the CWC, LLBG, or T Plant until it is treated, analyzed, or directly disposed of on site at the LLBGs or off site at a compliant facility. If the waste requires treatment, it usually is performed within a SWOC facility or at an offsite facility. Once the waste is treated, it is staged or stored at a SWOC facility until disposal can be arranged.

TRU waste, mixed CH-TRU waste, and RH-TRU waste can be generated either on or off site. TRU waste can be either staged or stored within a SWOC facility until it is treated, or it can be sent directly from generation to treatment. Once the waste is treated, it can be disposed of at WIPP if it meets the WIPP waste acceptance criteria (DOE 2002a), or it can be stored at a SWOC facility until disposal can be arranged (Weidert 2003).

E.3.1.1 Low-Level Radioactive Waste Burial Grounds

The operations at the LLBGs involve primarily LLW and MLLW disposal, TRU waste retrieval, and special waste considerations. Special waste considerations include containers with RH-waste and Category 3 waste encasement in high-integrity containers. RH-waste operations include emplacement in specially designed buried concrete or steel vaults or caissons.

LLW is received from on- or offsite generators for disposal. TRU waste retrieval operations occur within the LLBG sites, and waste containers are transferred to the CWC, T Plant, WRAP, or other LLBG sites.

Currently, LLW and MLLW are sent to RCRA-compliant trenches in LLBG 218-W-5 (trenches 31 and 34) or Environmental Restoration Disposal Facility, and reactor compartments are disposed of in LLBG 218-E-12B (trench 94). The activities at these trenches, whether for LLW or MLLW, involve several common steps, as follows:

- Waste transfer to a disposal trench area
- Waste receipt
- Container handling
- Inspection and survey
- Staging and disposal
- Trench construction, backfilling, and capping
- Stabilization and grouting
- Waste treatment

TRU waste retrieval activities are currently ongoing. These activities involve uncovering and moving the waste containers that were retrievably stored in the following locations:

- LLBG 218-W-4C: trenches 4C-T01, 4C-T04, 4C-T07, 4C-T20, 4C-T24 (EBR-II casks), and 4C-T29

- LLBG 218-W-4B: trenches 4B-TV7, 4B-T07, and 4B-T11
- LLBG 218-E-12B: trenches 12B-T17 and 12B-T27
- LLBG 218-W-3A: trenches 3A-T01, 3A-T04, 3A-T05, 3A-T06, 3A-T08, 3A-T10, 3A-T15, 3A-T17, 3A-T23, 3A-T30, 3A-T32, 3A-T34, 3A-T6S, and 3A-T9S

For suspect TRU waste retrieval, the activities at these trenches include the following:

- Trench backfill removal (where applicable)
- Container-handling, including drum-venting
- Inspection and survey
- Decontamination of spills (when applicable)
- NDE and NDA
- Waste transfers within the LLBGs or to other SWOC facilities
- Container-venting
- Container placement in specially designed concrete or steel vaults or caissons
- Soil sampling and placement

Additional activities include continued management of the material currently exposed in LLBG 218-W-4C, trenches 4C-T01, 4C-T04, 4C-T07, 4C-T20, 4C-T24, and 4C-T29. Trench 4C-T24 has vaults for EBR-II cask storage and is used for staging waste containers. It is not backfilled except around the vault sides.

Preliminary site investigations are conducted in the LLBG as needed to obtain in situ information regarding the current physical condition of TRU buried waste containers and to determine the status of the environmental conditions immediately surrounding the stored waste. Once the stored waste locations have been confirmed and conditions assessed, a few selected waste containers may be retrieved and characterized to provide additional information for the preliminary site investigation in preparation for the full-scale retrieval operations that would follow.

In general, most types of waste packages are received, stored, or disposed of in the same manner. Active trenches are backfilled as needed to minimize operator dose rates and exposure to waste. Backfilling a trench also minimizes the amount of waste exposed to conditions that could cause package degradation, waste-handling accidents, and severe environmental conditions (fires, water intrusion, and earthquakes) (Weidert 2003).

E.3.1.2 Central Waste Complex

Receiving and storing wastes are the primary activities at the CWC. This section describes the facility's process flow and activities by operational area.

The CWC provides storage and staging for waste containers that are awaiting waste processing operations at other waste management facilities. The CWC receives waste from both onsite and offsite generators. Four types of waste are processed or stored at the CWC: LLW, MLLW, TRU waste, and mixed TRU waste. The CWC would receive, as necessary, unvented containers from retrieval operations for staging prior to venting. Venting also may occur at the CWC.

Personnel receive and inspect waste packages at the Waste Receiving and Staging Area. In accordance with all applicable procedures, transport offloading operations are performed using handtrucks, forklifts, or cranes operated by qualified personnel. Packages are transferred from the offloading area to the appropriate CWC storage building or other storage area. Alternatively, waste packages may be received,

inspected, and unloaded at the specific CWC building or storage area where the waste would be stored. The typical stored waste package is a 208-liter (55-gallon) drum, a 322-liter (85-gallon) overpack, and a fiberglass reinforced plywood, plywood, or metal box. Atypical packages include, but are not limited to, radioisotopic thermoelectric generators, vault tank filter assemblies, steel waste disposal boxes, overpacks, and pipe overpacks in 208-liter (55-gallon) drums.

Planned activities at the CWC include performing headspace gas sampling (HSGS) on containers; NDE and NDA using portable units to characterize container contents; intrusive sampling operations to characterize or verify contents, minimal waste treatment (encapsulating, absorbing, stabilizing, neutralizing, venting); and packaging and repackaging (adding shielding inside containers, filling voids, removing noncompliant items, and decontaminating shipping container interiors).

The above discussion provides a general description of the CWC waste management process flow. The following paragraphs provide a brief discussion of activities by operational area.

E.3.1.2.1 Waste Receiving and Staging Area

Primary activities in the Waste Receiving and Staging Area include shipping, receiving, staging, storing, and handling closed waste containers containing LLW, MLLW, TRU waste, and mixed TRU waste. Activities for any of these wastes may include the following:

- Receiving and shipping waste containers
- Receiving waste from onsite and offsite generators
- Transferring waste from the CWC to onsite waste management facilities (LLBG, WRAP, T Plant)
- Handling containers (drums, solid-waste boxes [SWBs], boxes, and other acceptable containers)
- Staging waste pending other CWC activities
- Inspecting and surveying waste containers and equipment
- Intrusive sampling
- Decontaminating waste containers and work areas

E.3.1.2.2 Mixed Waste Storage Pad

The Mixed Waste Storage Pad is used for staging and storing wastes. Activities for any wastes can include the following:

- Handling containers (drums, SWBs, boxes, and other acceptable containers)
- Staging waste pending other CWC activities
- Inspecting and surveying waste containers and equipment
- Performing NDE and NDA in mobile units located near loading docks
- HSGS inside or near the area
- Treating waste
- Placing waste into overpacks, SWBs, or other acceptable containers
- Assembling payloads

E.3.1.2.3 Low-Flashpoint Mixed Waste Storage Modules

The Low-Flashpoint Mixed Waste Storage Modules are used for staging, storing, and analyzing waste. Activities for any waste can include the following:

- Handling containers (drums, boxes, and other acceptable containers)
- Staging waste pending other CWC activities
- Inspecting and surveying waste containers and equipment
- Treating waste
- Placing waste into overpacks, SWBs, or other acceptable containers

E.3.1.2.4 Alkali Metal Waste Storage Modules

The Alkali Metal Waste Storage Modules are used for staging, storing, and analyzing MLLW. Activities for any waste can include the following:

- Handling containers (drums and other acceptable containers)
- Staging waste pending other CWC activities
- Inspecting and surveying waste containers and equipment
- Treating waste
- Placing waste into overpacks, SWBs, or other acceptable containers

E.3.1.2.5 Mixed Waste Storage Buildings (2402-W, 2403-W, and 2404-W Series)

The 2402-W, 2403-W, and 2404-W-series buildings are used for staging, storing, and analyzing waste. Activities for any waste can include the following:

- Handling containers (drums, SWBs, boxes, and other acceptable containers)
- Staging waste pending other CWC activities
- Inspecting and surveying waste containers and equipment
- Performing NDE and NDA in mobile units located in the building or nearby
- HSGS inside or near the area
- Treating waste
- Placing waste containers into overpacks
- Removing long-stem filters
- Placing waste into overpacks, SWBs, or other acceptable containers
- Venting containers

E.3.1.2.6 2420-W Cask Storage Pad

The 2420-W Cask Storage Pad is used for storage of casks containing TRU waste. Most of the waste is not readily dispersible. Activities for any waste can include the following:

- Receiving and shipping waste containers
- Receiving waste from onsite and offsite generators
- Transferring waste from the CWC to other SWOC facilities
- Handling containers
- Inspecting and surveying waste containers and equipment
- Decontaminating waste containers and work areas

E.3.1.2.7 South Alkali Metal Storage Modules

The South Alkali Metal Storage Modules are used for staging, storing, and analyzing radioactively contaminated alkali metal. They also store sodium product.

E.3.1.2.8 Miscellaneous Outside Storage Areas

The miscellaneous outside storage areas are used for staging and storing waste. Activities involving any waste can include the following:

- Handling containers (drums, SWBs, boxes, and other acceptable containers)
- Staging waste pending other CWC activities
- Inspecting and surveying waste containers and equipment
- Performing NDE and NDA in mobile units
- HSGS inside or near the area
- Treating waste
- Placing waste into overpacks, SWBs, or other acceptable containers
- Application of polyurea coatings (Weidert 2003)

Additional descriptions of the CWC and proposed expansion of the CWC can be found in Section E.3.2.2.

E.3.1.3 T Plant

Decontamination and waste storage, treatment, repackaging, and verification are the central activities at the T Plant. The facility has unique capabilities that provide flexibility in managing waste. This section describes the facility's process flow and activities by operational area.

Before equipment or waste containers are sent to the T Plant, they are evaluated for acceptance at 221-T Canyon or the 2706-T/TA/TB Facility. If equipment or waste is sent to the T Plant that is not in accordance with facility acceptance criteria, it is returned to the customer or action is initiated to rectify the discrepant condition. Once accepted, the process flow might take several routes, based on the type of waste or contaminated equipment.

LLW (including MLLW), TRU waste (including mixed TRU waste), and contaminated equipment are typically received at the 2706-T/TA/TB Facility or at the 221-T building's railway tunnel. It may be staged in a yard or building storage area prior to processing at the 2706-T/TA/TB Facility, the 221-T railway tunnel, or the 221-T Canyon, including the head-end. MLLW that does not meet Hanford disposal requirements may be sent off site for treatment and disposal or to other SWOC facilities for storage and treatment.

TRU (including mixed TRU) waste received for HSGS is sent to the 2706-T/TA/TB Facility. After HSGS is completed, the waste is sent to the CWC or WRAP. Other TRU waste or TRU waste-contaminated equipment could be sent to the 221-T railway tunnel, the 221-T Canyon, or the 2706-T Facility. It could be staged in a yard or building storage area prior to processing at the 2706-T/TA/TB Facility, the 221-T railway tunnel, or the 221-T Canyon. The primary access for transferring waste containers into the 221-T Canyon is through the 221-T head-end. The head-end is used as an interim waste container staging area for moving containers into and out of the canyon. The T Plant currently contains RH-TRU waste received from offsite sources. In the future, it is possible that other RH waste would also come to the T Plant.

The T Plant treated sludge using a solidification process located near sections 7, 8, and 9 of the canyon deck area. The sludge/water mixture was evacuated from a large-diameter container overpack and

conveyed to the sludge grouting system where the mixture was fed into 208-liter (55-gallon) drums, and blended with water, Portland cement, and bentonite clay to create grouted sludge.

The sludge transfer system fluidizes the sludge material and then transfers it to the buffer tank. The amount of sludge added to each drum is based on a correlation between the gamma monitor reading and the volume of sludge with that reading, which, when grouted, results in a product with a contact dose rate of less than 200 millirem per hour. Efforts are made to minimize the number of packages produced while controlling the process at a set point below the acceptance criteria for CH packages.

To reduce worker dose during processing, the system uses shielding for each drum that allows access to the drum for dose measurements, smears, and easy drum removal.

The system design incorporates a grout-mixing paddle that is lowered into the drum and a cover plate that seals the top to prevent sludge from splashing outside of the drum during sludge-loading, grout addition, and blending. It also incorporates a process for transferring a specified volume of slurry into the drum. Water is added to the sludge, and then grout is added as the mixture is blended. After the cement/clay mixture is added and the mixture is blended, the mixing paddle is dropped into the mixture in the drum. The drum is moved along the conveyor to install the vented lid. The final conveyor location provides a scale for weighing the drum. Measurement of the drum dose rate is required during this process to ensure that contact dose rates are not exceeded. The final grouted drum of sludge-type material is then ready for disposal as either LLW or TRU waste.

It is anticipated that additional sludge-type material, i.e., K Basin sand filter media and sludge, could be received at the T Plant for treatment using the described solidification process. Any waste received for treatment must meet the T Plant waste acceptance criteria and must not exceed the source strength control limit of 82.5 dose-equivalent curies for a single container.

E.3.1.3.1 221-T Railway Tunnel

The 221-T railway tunnel provides access for waste received at the 221-T Canyon. Current and planned future tunnel activities include the following:

- Receiving and shipping LLW and TRU waste containers and equipment
- Receiving large-diameter container overpacks in shipping casks
- Handling LLW and TRU waste drums, boxes, and sludge casks
- Inspecting and surveying LLW and TRU waste drums, boxes, equipment, and sludge casks
- Staging, storing, and venting LLW and TRU waste drums, boxes, and sludge casks
- Intrusive sampling of LLW and TRU waste drums and boxes
- Packaging and repackaging LLW and TRU waste drums, boxes, and equipment
- Performing routine decontamination from residual waste
- Performing facility repair and process equipment maintenance
- Treating LLW and TRU waste and equipment

E.3.1.3.2 221-T Canyon

The 221-T Canyon is a reinforced-concrete building used for processing and storage. Current and potential activities include the following:

- Handling LLW and TRU waste drums, boxes, sludge casks, and RH-TRU waste
- Inspecting and surveying LLW and TRU waste drums, boxes, equipment, sludge casks, and RH-TRU waste

- Staging, storing, and venting LLW and TRU waste containers, including MLLW, equipment, sludge casks, and RH-TRU waste
- Void-filling and stabilizing, neutralizing, grouting, and removing noncompliant items
- HSGS
- Performing mobile NDA and NDE
- Intrusive sampling of LLW and TRU waste containers and equipment, including MLLW
- Reducing size of LLW and TRU waste, including MLLW and equipment
- Treating LLW and TRU waste and equipment
- Packaging and repackaging LLW and TRU waste drums, boxes, and equipment
- Decontaminating large equipment
- Performing routine decontamination from residual waste
- Performing facility repair and process equipment maintenance
- Compacting waste drums

E.3.1.3.3 2706-T/TA/TB Facility

The 2706-T/TA/TB Facility is used primarily for sampling, treating, and packaging and repackaging waste, as well as decontaminating equipment. Current and potential future activities include the following:

- Transferring LLW and TRU waste containers and equipment
- Receiving and shipping LLW and TRU waste containers and equipment
- Handling LLW and TRU waste containers and equipment
- Inspecting and surveying LLW and TRU waste containers and equipment
- Staging, storing, and venting LLW and TRU waste containers and equipment
- HSGS
- Performing mobile NDA and NDE
- Intrusive sampling of LLW and TRU waste containers
- Treating LLW and TRU waste containers
- Packaging and repackaging LLW and TRU waste containers and equipment
- Decontaminating equipment
- Performing routine decontamination from residual waste
- Transferring decontaminated liquids to storage tanks
- Performing facility repair and process equipment maintenance
- Compacting waste drums

E.3.1.3.4 Yard Storage

Yard storage areas are used primarily for storage and for limited packaging and repackaging activities. Current and planned future activities include the following:

- Transferring LLW and TRU waste containers and equipment
- Receiving and shipping LLW and TRU waste containers and equipment
- Handling LLW and TRU waste containers and equipment, including overpacks
- Inspecting and surveying LLW and TRU waste containers and equipment
- Staging and storing LLW and TRU waste containers and equipment
- Packaging by welding LLW and TRU waste containers

E.3.1.3.5 Building Storage

Building storage areas are used primarily for storage and limited packaging and repackaging activities. Current and planned future activities include the following:

- Transferring LLW and TRU waste drums, boxes, and equipment
- Receiving and shipping LLW and TRU waste drums, boxes, and equipment
- Handling LLW and TRU waste drums, boxes, and equipment, including overpacking LLW and TRU waste drums and boxes in the 214-T building
- Inspecting and surveying LLW and TRU waste drums, boxes, and equipment
- Staging and storing LLW and TRU waste drums, boxes, and equipment (Weidert 2003)

Additional descriptions of the T Plant complex and proposed expansion can be found in Section E.3.2.3.

E.3.1.4 Waste Receiving and Processing Facility

The primary WRAP activities are to confirm, sample, repackage, certify, store, and treat waste for shipment to a treatment, storage, and disposal unit. WRAP contains three operational areas: the Shipping and Receiving Area, the NDE and NDA Area, and the Process Area. WRAP process flow begins with receipt of CH-waste (CH-LLW, CH-MLLW, CH-TRU waste, and CH-TRU mixed waste) containers at the loading docks. Containers (drums or boxes) of CH waste may be received from Hanford generators, the CWC, waste retrieval operations, and offsite generators. Containers are inspected and documentation is verified. Waste that meets WRAP acceptance criteria is officially received into the facility and input to the computerized management system. Waste that does not meet the criteria is returned to the sender or isolated pending management instructions.

Items are tracked, routed, and processed independently and might undergo an activity more than once. Drums or waste boxes undergo NDE and NDA for characterization against the waste acceptance criteria. Suspect containers or containers received for routine verification are sent to the Process Area and inspected. Waste items that do not comply with the waste acceptance criteria are removed and/or treated to achieve compliance. Waste is repacked and returned as necessary for NDE and NDA, HSGS, storage, or shipment. Containers are either staged in the Shipping and Receiving Area just prior to preparation for TRUPACT-II loading for shipment to WIPP or transferred to other SWOC facilities.

E.3.1.4.1 Shipping and Receiving Area

Primary activities in the Shipping and Receiving Area include shipping, receiving, staging, storing, and handling of closed waste containers. Activities for any waste can include the following:

- Receiving and shipping CH-waste (CH-LLW, CH-MLLW, CH-TRU waste, and CH-TRU mixed waste) containers
- Transferring waste to WRAP from onsite generators
- Transporting TRUPACT-IIs from WRAP
- Handling containers (drums, SWBs, boxes, and other acceptable containers)
- Inspecting and surveying waste containers and equipment
- Decontaminating waste containers and work areas
- Staging waste pending other WRAP activities
- HSGS
- Venting containers
- Packaging and repackaging containers
- Decontaminating equipment
- Performing facility repair and maintenance

Drums are typically received in the Shipping and Receiving Area, transferred to a containment pallet, and placed in storage. Before entering the NDE and NDA Area, each drum is removed from the pallet and the bar code is read. Drums requiring assay are typically weighed, and the appropriate weight is recorded prior to NDA. Waste received is either newly generated waste requiring verification, waste retrieved from the LLBG, or waste that has previously been accepted and shipped to WRAP for processing or certification.

E.3.1.4.2 Nondestructive Examination and Nondestructive Assay Area

The purpose of NDE and NDA operations is to characterize waste contents using noninvasive techniques such as real-time radiography, gamma energy analysis, and imaging passive/active neutron analysis. The operations use the following analytical equipment:

- Box real-time radiography NDE
- Box integrated gamma energy analysis-imaging passive/active neutron (inactive)
- Drum real-time radiography NDE
- Drum gamma energy analysis to quantify gamma-emitting radionuclides
- Drum imaging passive/active neutron to quantify fissile contents

Activities conducted in the NDE and NDA Area includes the following:

- Performing NDE and NDA of drum and boxed waste
- Handling containers

- Staging in-process waste drums and boxes
- Decontaminating waste containers and NDE and NDA equipment
- Performing facility repair and maintenance
- HSGS

Waste drums and boxes received at WRAP are subjected to NDE or NDA to verify compliance with waste certification requirements and (in the case of drums) to determine the appropriate method for processing any restricted waste present. For example, LLW received for verification purposes might require only NDE.

Waste containers determined by NDE or NDA to meet appropriate disposal criteria are either certified and shipped to a disposal facility or volume-reduced by supercompaction, certified, and shipped for disposal. Under normal operating conditions, waste containers determined by NDE and NDA to contain restricted waste (or those requiring additional verification) are opened, sorted, sampled, and treated. The restricted waste is either processed in WRAP or repackaged for storage pending treatment at an appropriate facility. The remaining compliant waste is repackaged, certified, and shipped to storage or disposal. Waste boxes determined by NDE or NDA to meet the disposal criteria are certified and shipped to storage or disposal. Boxed waste that does not meet the disposal requirements is shipped to storage, pending treatment at other facilities.

E.3.1.4.3 Process Area

Process enclosures in the Process Area are used to open waste containers for verification, characterization, sorting, and treatment to evaluate whether TRU waste and LLW comply with appropriate waste acceptance criteria.

Process operations occur in the following separate process enclosures (gloveboxes) in the waste processing area.

- TRU waste and LLW process enclosure
- TRU waste process enclosure
- LLW restricted waste management (RWM) process enclosure
- TRU waste RWM process enclosure

Activities conducted to achieve compliant waste in the process areas include the following:

- Handling drums being moved to and from staging and the enclosures
- Inspecting and surveying waste in the enclosures and containers in the area
- Staging waste on carousels or lifts in association with processing
- HSGS
- Intrusive sampling of opened drums inside the enclosures, including separation and sorting, visual examination, and sample collection
- Adding shielding to RH waste to achieve CH requirements
- Packaging and repackaging through loadout from the enclosures
- Decontamination

- Treating noncompliant waste
- Performing facility repair and maintenance

Waste drums that do not meet the appropriate disposal criteria are opened and sorted in a process enclosure where the restricted waste or waste types prohibited by the applicable waste acceptance criteria are removed or processed. Restricted and prohibited wastes that are not certifiable or are noncompliant are either processed in WRAP or returned to the generator for resolution. Two process lines perform these waste processing operations: one is dedicated to TRU waste; the other can process either TRU waste or LLW. Waste drums may be taken to a process glovebox for verification purposes.

In the sorting process, specific hazardous materials and other regulated waste (e.g., lead bricks, PCBs) may be removed from the drum for processing in the RWM enclosures. Restricted waste items are segregated and placed in containers in the waste process enclosures before being transferred to the RWM enclosures. One enclosure is dedicated to LLW and the other to TRU waste material to avoid the possibility of cross-contamination. Samples of restricted waste items are collected in the RWM enclosures for analysis elsewhere. The enclosures also provide limited restricted waste processing capabilities, such as absorbing small quantities of liquids, immobilizing particulates, and depressurizing aerosol cans. After processing, outgoing waste containers might undergo NDA and/or NDE for final certification before shipment.

In addition, waste containers are generated as products of the processing enclosures. There are a number of other categories of waste drums in WRAP. There are mixed or hazardous waste accumulations resulting from mixed or hazardous waste management, as well as waste drums for waste generated outside the process enclosures during operations in the WRAP Process Area. Additionally, there are some waste drums, such as pipe overpack containers, overpacked drums with long-stem Nucfil filters, drums requiring the addition of filler material, that require minimal processing and sampling within a confinement ventilation zone. These drums may be opened within the WRAP Process Area, but outside of the glovebox, to perform this limited processing and sampling. Radiological protection controls are established, as appropriate (Weidert 2003).

E.3.1.4.4 Accelerated Process Lines

The accelerated process lines (APLs) use mobile units such as trailers or relocatable structures to house the equipment used to characterize and process candidate CH-TRU waste containers for disposal at WIPP. These units can be located near or within any SWOC building and are positioned to increase TRU waste characterization and processing throughput.

APL capabilities include any or all of the following (Weidert 2003):

- NDE using real-time radiography
- NDA using the segmented gamma system, imaging passive active neutron, or other similar neutron- or gamma-counting systems
- HSGS, either by taking samples through the existing filter or filter port or by using a drum-venting system and sample analysis system combination
- Drum-venting

- Gas-generation-testing
- Glovebox processing (not approved at this time)

Additional descriptions of WRAP and the proposed expansion can be found in Section E.3.2.4.

E.3.2 Waste Management Alternatives and Treatment Facilities Analyzed in This Environmental Impact Statement

E.3.2.1 Waste Management Alternatives

This TC & WM EIS analyzes three Waste Management alternatives. A summary of each follows and a more-detailed discussion of each treatment facility are included in Sections E.3.2.2 through E.3.2.4. Further discussion of IDF(s) and the RPPDF is included in Sections E.3.4 and E.3.5, respectively.

- **Waste Management Alternative 1: No Action.** Under this alternative, storage and treatment of LLW, MLLW, and TRU waste would continue at the CWC, and disposal would continue at the LLBG 218-W-5, trenches 31 and 34, until an estimated operational closure date of 2035. Likewise, storage and treatment of onsite-generated LLW, MLLW, and TRU waste would continue at WRAP and the T Plant complex. No offsite shipments of LLW, MLLW, or TRU waste would be accepted, except as allowed as part of the Settlement Agreement signed on January 6, 2006, by DOE, Ecology, and the Washington State Attorney General's Office (**State of Washington v. Bodman**, Civil No. 2:03-cv-05018-AAM). Further construction of IDF-East would be discontinued in 2008. Administrative controls would be carried on for 100 years following operational closure of the disposal trenches. Figure E-49 is a graphic representation of the Waste Management No Action Alternative.

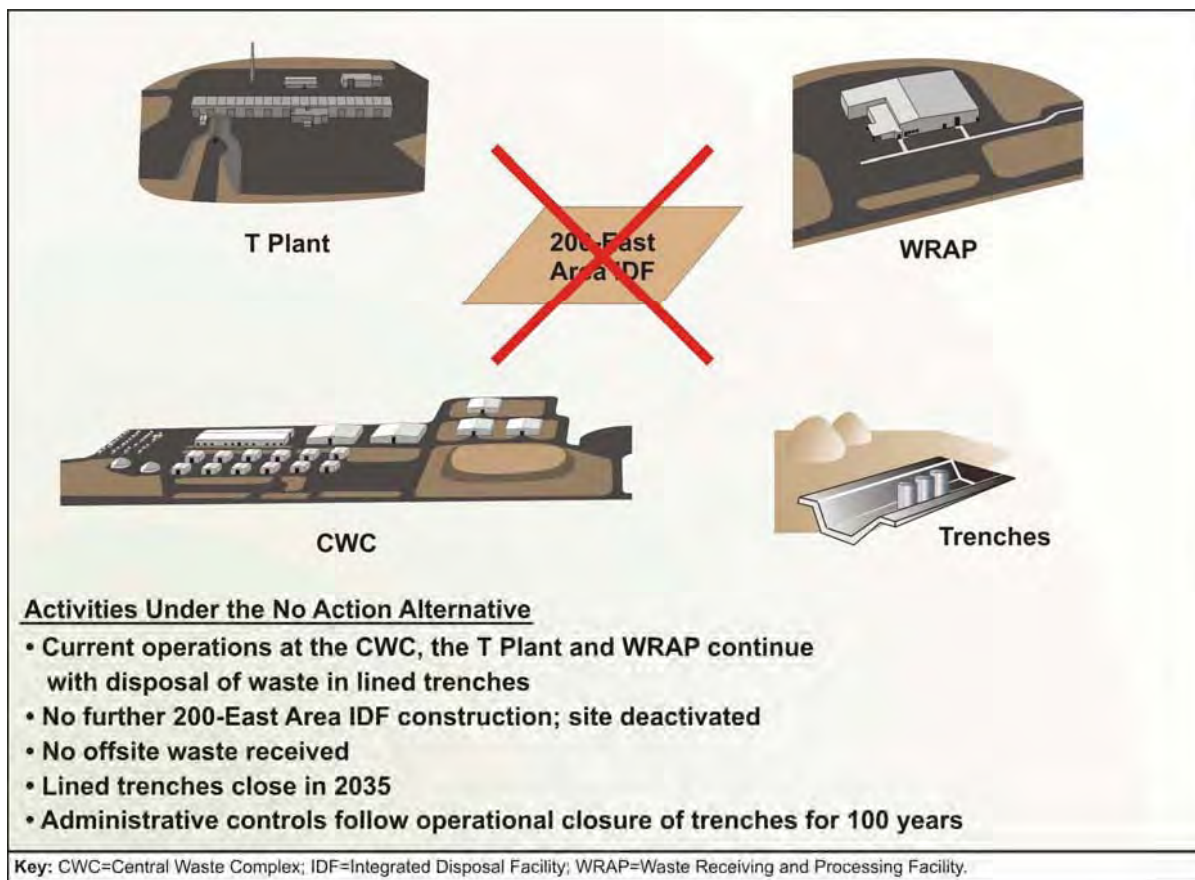

Figure E-49. Waste Management Alternative 1: No Action

- **Waste Management Alternative 2: Disposal in IDF, 200-East Area Only.** Under this alternative, storage and treatment of LLW, MLLW, and TRU waste would continue, using both the existing and the proposed expanded capabilities at the CWC, T Plant complex, and WRAP facilities. Offsite waste received would be limited to 62,000 cubic meters (81,000 cubic yards) of LLW and 20,000 cubic meters (26,000 cubic yards) of MLLW, with shipments estimated to be received from 2010 through 2046. Onsite-generated, nontank waste from non-CERCLA sources would be generated through 2035. For analysis purposes, operation of the LLBG 218-W-5, trenches 31 and 34, would continue through 2050. However, all waste streams requiring onsite disposal were assumed to be disposed of in IDF-East. Under this alternative, IDF-East, which is partially constructed in the 200-East Area would accept the following: tank treatment and FFTF decommissioning waste, waste management facility-generated (secondary) waste, site-generated waste, non-CERCLA waste, non-tank-activity waste, and projected waste shipments from other DOE sites. IDF-East was assumed to be fully constructed and ready to begin operations in 2009. A new disposal facility, the RPPDF, would be constructed for disposal of lightly contaminated RSE resulting from closure of the tank farm facilities. To reduce the combinations of IDF and RPPDF configurations, three disposal groups are analyzed:
 - **Disposal Group 1:** IDF-East would have a capacity of 1.2 million cubic meters (1.57 million cubic yards), and the RPPDF would have a capacity of 1.08 million cubic meters (1.41 million cubic yards). Both facilities would operate through 2050. This grouping supports Tank Closure Alternatives 2B, 3A, 3B, 3C, 4, 5, and 6C; FFTF Decommissioning Alternatives 2 and 3; and disposal of onsite-generated, non-CERCLA, non-tank-activity waste and projected waste shipments from other DOE sites.

- **Disposal Group 2:** IDF-East would have a capacity of 425,000 cubic meters (556,000 cubic yards), and the RPPDF would have a capacity of 8.37 million cubic meters (10.9 million cubic yards). Both facilities would operate through 2100. This grouping supports Tank Closure Alternatives 2A and 6B; FFTF Decommissioning Alternatives 2 and 3; and disposal of onsite-generated, non-CERCLA, non-tank-activity waste and projected waste shipments from other DOE sites.
- **Disposal Group 3:** IDF-East would have a capacity of 425,000 cubic meters (556,000 cubic yards), and the RPPDF would have a capacity of 8.37 million cubic meters (10.9 million cubic yards). Both facilities would operate through 2165. This grouping supports Tank Closure Alternative 6A; FFTF Decommissioning Alternatives 2 and 3; and disposal of onsite-generated, non-CERCLA, non-tank-activity waste and projected waste shipments from other DOE sites.

Figure E-50 is a graphic representation of Waste Management Alternative 2, Disposal in IDF, 200-East Area Only.

- **Waste Management Alternative 3: Disposal in IDF, 200-East and 200-West Areas.** Under this alternative, the activities would be the same as those under Waste Management Alternative 2, except that onsite waste disposal would be split between the current IDF-East site and a new IDF site in the 200-West Area (IDF-West). Tank waste would still be disposed of in IDF-East, but all the other waste streams disposed of in IDF-East under Waste Management Alternative 2 would be disposed of in IDF-West. The three disposal groups under Waste Management Alternative 3 are as follows:
 - **Disposal Group 1:** IDF-East would have a capacity of 1.1 million cubic meters (1.43 million cubic yards); IDF-West would have a capacity of 90,000 cubic meters (118,000 cubic yards); and the RPPDF would have a capacity of 1.08 million cubic meters (1.41 million cubic yards). All three facilities would operate through 2050. This grouping supports Tank Closure Alternatives 2B, 3A, 3B, 3C, 4, 5, and 6C; FFTF Decommissioning Alternatives 2 and 3; and disposal of onsite-generated, non-CERCLA, non-tank-activity waste and projected waste shipments from other DOE sites.

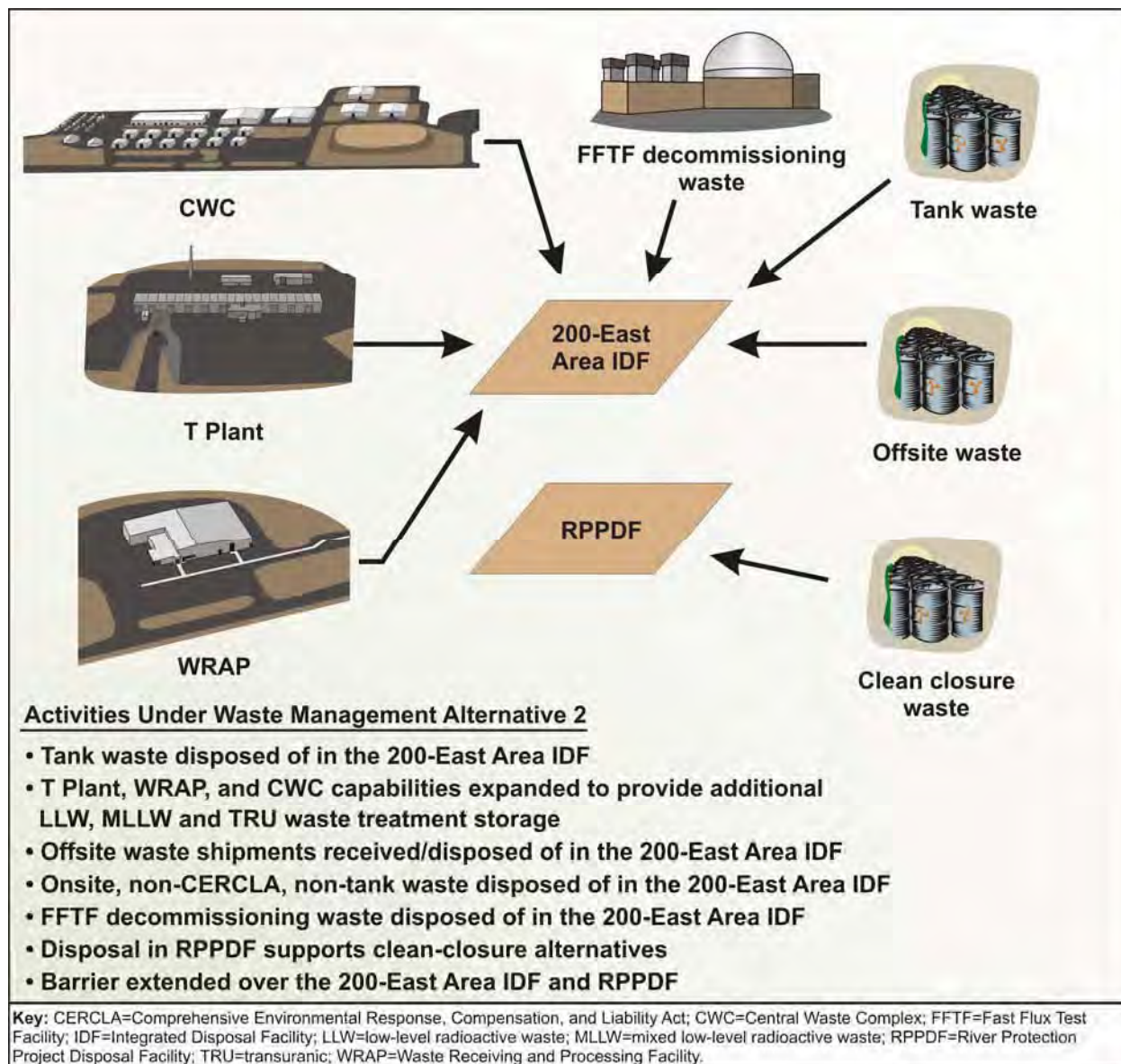

Figure E-50. Waste Management Alternative 2: Disposal in IDF, 200-East Area Only

Figure E-51 is a graphic representation of Waste Management Alternative 3, Disposal in IDF, 200-East and 200-West Areas.

- **Disposal Group 2:** IDF-East would have a capacity of 340,000 cubic meters (445,000 cubic yards); IDF-West would have a capacity of 90,000 cubic meters (118,000 cubic yards); and the RPPDF would have a capacity of 8.37 million cubic meters (10.9 million cubic yards). IDF-East and the RPPDF would operate through 2100. IDF-West would operate through 2050. This grouping supports Tank Closure Alternatives 2A and 6B; FFTF Decommissioning Alternatives 2 and 3; and disposal of onsite-generated, non-CERCLA, non-tank-activity waste and projected waste shipments from other DOE sites.

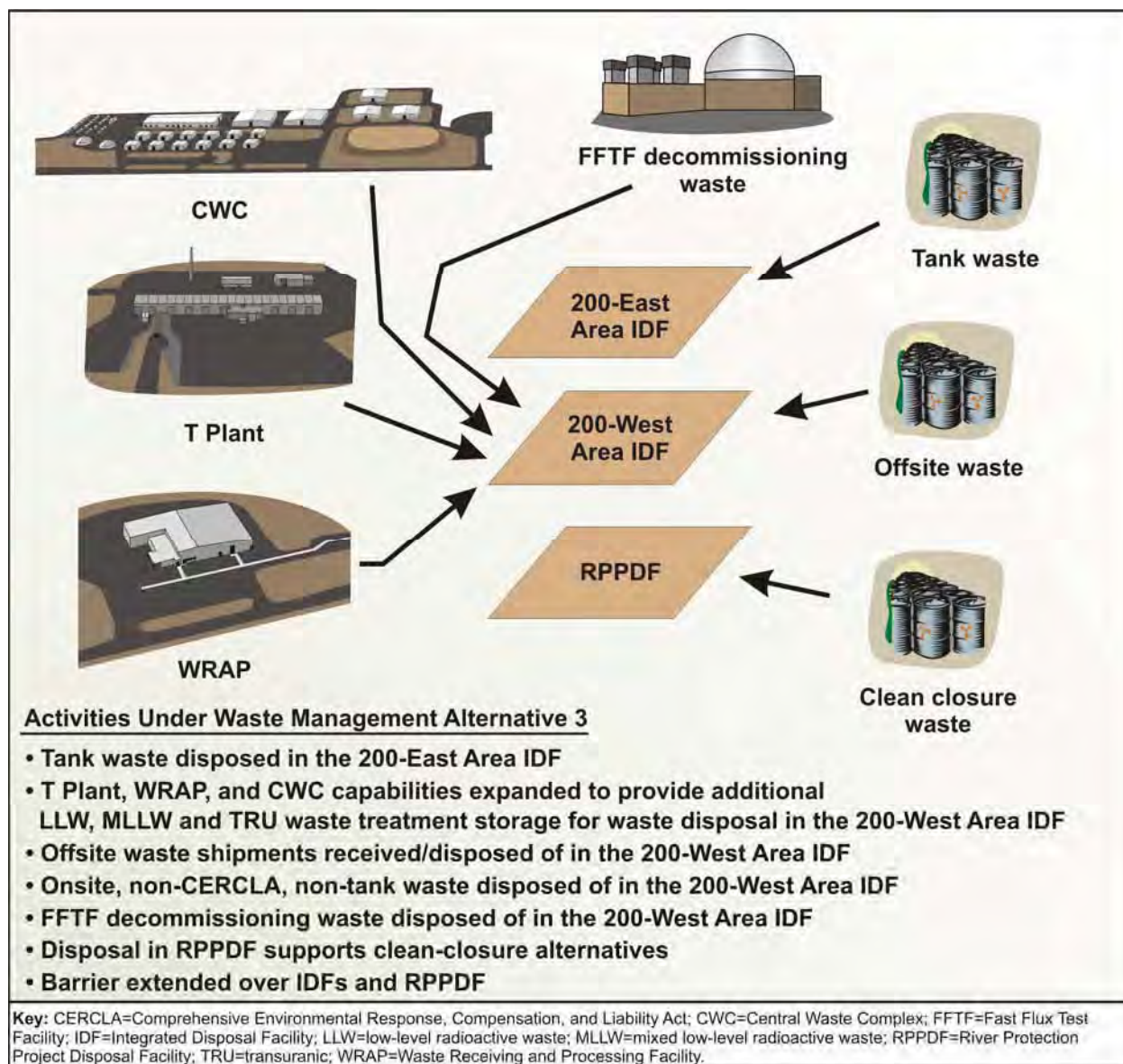

Figure E-51. Waste Management Alternative 3: Disposal in IDF, 200-East and 200-West Areas

- **Disposal Group 3:** IDF-East would have a capacity of 340,000 cubic meters (445,000 cubic yards); IDF-West would have a capacity of 90,000 cubic meters (118,000 cubic yards); and the RPPDF would have a capacity of 8.37 million cubic meters (10.9 million cubic yards). IDF-East and the RPPDF would operate through 2165. IDF-West would operate through 2050. This grouping supports Tank Closure Alternative 6A; FFTF Decommissioning Alternatives 2 and 3; and disposal of onsite-generated, non-CERCLA, non-tank-activity waste; and projected waste shipments from other DOE sites.

E.3.2.2 Central Waste Complex

E.3.2.2.1 Description

The CWC is designed and authorized to receive and store CH-LLW, -MLLW, -TRU waste, and -mixed TRU waste. Current and future activities at the CWC for these wastes' packages include shipping and receiving waste containers staging/storing waste, nonintrusive surveying and inspecting, treating waste, intrusive sampling, verifying, packaging, repackaging, loading, HSGS, drum venting, and decontaminating. The CWC main buildings are the 2401 series, 2402 series, 2403 series, and 2404 series buildings. Other CWC buildings include the Low-Flashpoint Mixed Waste Storage Modules (FS-1-FS-27), Alkali Mixed Waste Modules (AWM-1 to AWM-4), the South Alkali Metal Storage Modules, and the Mixed Waste Storage Modules (MWS-1 to MWS-11). Other facilities include the Waste Receiving and Staging Area, the Mixed Waste Storage Pad, and the 2420-W Cask Storage Pad.

All newly generated Hanford waste is required to meet the HSSWAC (Fluor Hanford 2005a) established by the Hanford Solid Waste Acceptance Program. Waste is generally packaged in 208-liter (55-gallon) drums or other approved alternate packages dictated by size, shape, or other form. Each container is handled individually using a handtruck or dolly, a forklift, or a crane. Drums are placed on pallets, with a maximum of four drums. Pallets are stacked up to three tiers high. The storage buildings or pads have physical features that provide for segregated storage areas to maintain appropriate separation between groups of incompatible wastes.

- The 2403-WD building footprint is 52 meters wide by 99 meters long by 6 meters high (170 feet wide by 325 feet long by 20 feet high) for a total area of 5,150 square meters (55,400 square feet), or 31,000 cubic meters (1.1 million cubic feet) of volume.
- The 2403-WD building drum capacity is 17,500 drums.
- The total CWC drum capacity is 82,480 drums (CEES 2006f).

Figure E-52 is a site plan of the current CWC, including WRAP.

E.3.2.2.2 Central Waste Complex Expansion

Due to the uncertainty of the waste forecasts for Hanford, it was assumed for analysis purposes that additional solid waste storage capacity would be required at the CWC as soon as possible following issuance of the ROD regarding the proposed actions. This capacity would be gained by construction of another 2403-WD facility at the CWC. Thus, under Waste Management Alternatives 2 and 3, the current capabilities of the CWC would be expanded to support additional storage capacity for radioactive waste. Specifically, the current storage building 2403-WD, with a drum storage capacity of 17,500 drums, is duplicated under both Alternatives 2 and 3. Some of the more pertinent assumptions made to support the expansion are as follows:

- The CWC expansion is based on building 2403-WD and its capacity of 17,500 drums.
- Steel waste capacity for roll-on/off containers is estimated to be 13.6 metric tons (DOE 2003c).
- The medium-duty work trucks are used for training and operator rounds; trucks are used 0.5 hours per day each day of the year (182.5 hours per year).
- Ninety percent of the total operational labor hours are radiation worker labor hours; the remaining 10 percent are nonradiation worker labor hours.

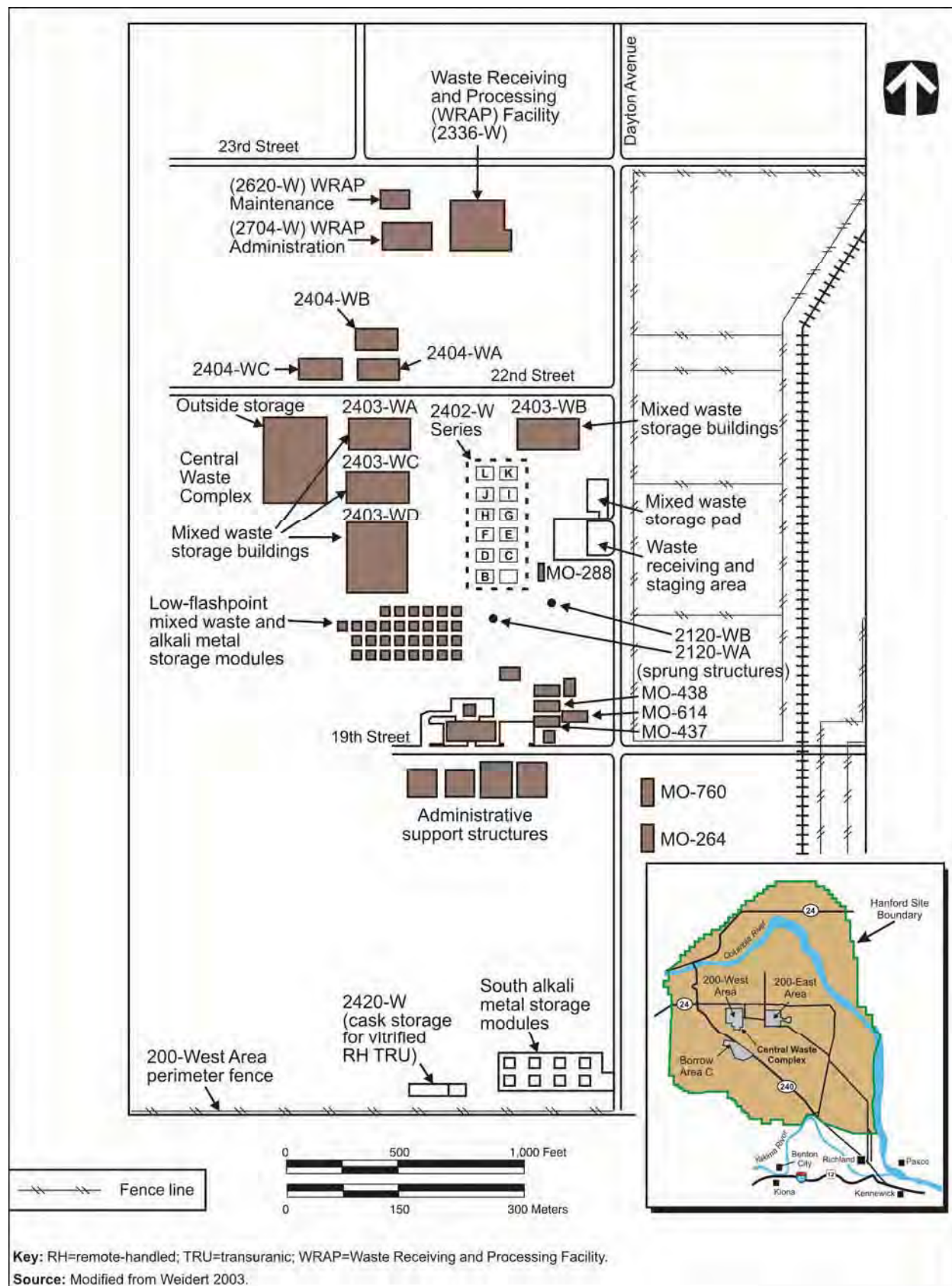

Figure E-52. Current Central Waste Complex Site Plan

- The operational resource personnel vehicle, forklifts, mechanics trucks, crane, and light plants operate an average of 8 hours per day during normal operations. The backhoe operates an average of 1 hour per day, and the portable generators operate an average of 12 hours per day.
- Waste generated from consumables during solid waste processing such as gloves and tape are incorporated into the repackaging operation without an increase to the source term, volume, or number of containers.
- The deactivation of the CWC assumes 100 percent of normal operating staffing during the deactivation period (CEES 2006f).
- Closure and postclosure care of this CWC expansion is not within the scope of Waste Management Alternatives 2 and 3 but is analyzed in Chapter 6, “Cumulative Impacts.”

Waste Management Alternative 1 does not analyze the expansion of the CWC; under this alternative, the existing, permitted CWC would operate to support onsite-generated waste.

E.3.2.3 T Plant Complex

E.3.2.3.1 Description

Current estimates indicate that there are approximately 8,000 cubic meters (10,500 cubic yards) of high-dose (i.e., RH) or oversized waste packages that may not meet the HSSWAC criteria for disposal (Johnson and Parker 2004). A new facility or facility modifications may be required to process these waste volumes. Waste processing could be accomplished through the use of new modules either within or adjacent to an existing facility, e.g., the 2706-T/TA/TB Facility, 221-T Canyon, WRAP, or mobile TRU waste processing units. The T Plant could be modified to remotely open, sort, size-reduce, and repack MLLW and TRU/mixed TRU waste that is either CH or RH and in variously sized packages (Bailey et al. 2006). The T Plant would need to accommodate waste containers sized anywhere from 3.8-liter (1-gallon) cans to 6.1- by 4- by 3.4-meter (20- by 13- by 11-foot) boxes. The waste containers could be as heavy as 37,600 kilograms (83,000 pounds), and the radiation levels could be as high as 20,000 rem per hour at the container surface. These waste types currently cannot be processed using existing site capabilities. This additional waste processing capability could be included in an expansion of either WRAP or the T Plant.

The T Plant is operating under interim status as an RCRA treatment, storage, and disposal unit with no current RCRA permit capacity limit. The T Plant includes the 221-T Canyon and 2706-T/TA/TB Facility, which conduct segregation, treatment, repackaging, verification, classification, and general venting and sampling activities on CH-waste containers (drums and boxes). The T Plant also has limited RH processing capabilities in the 221-T Canyon. T Plant solid waste processing consists of the addition of absorbent or grout material to the waste matrix, neutralization, and amalgamation of mercury or other metals. Additional services include sampling of drum headspace to support the TRU waste program and management of analytical samples returned from commercial laboratories (CEES 2006g).

Figure E-53 is the current T Plant complex site plan.

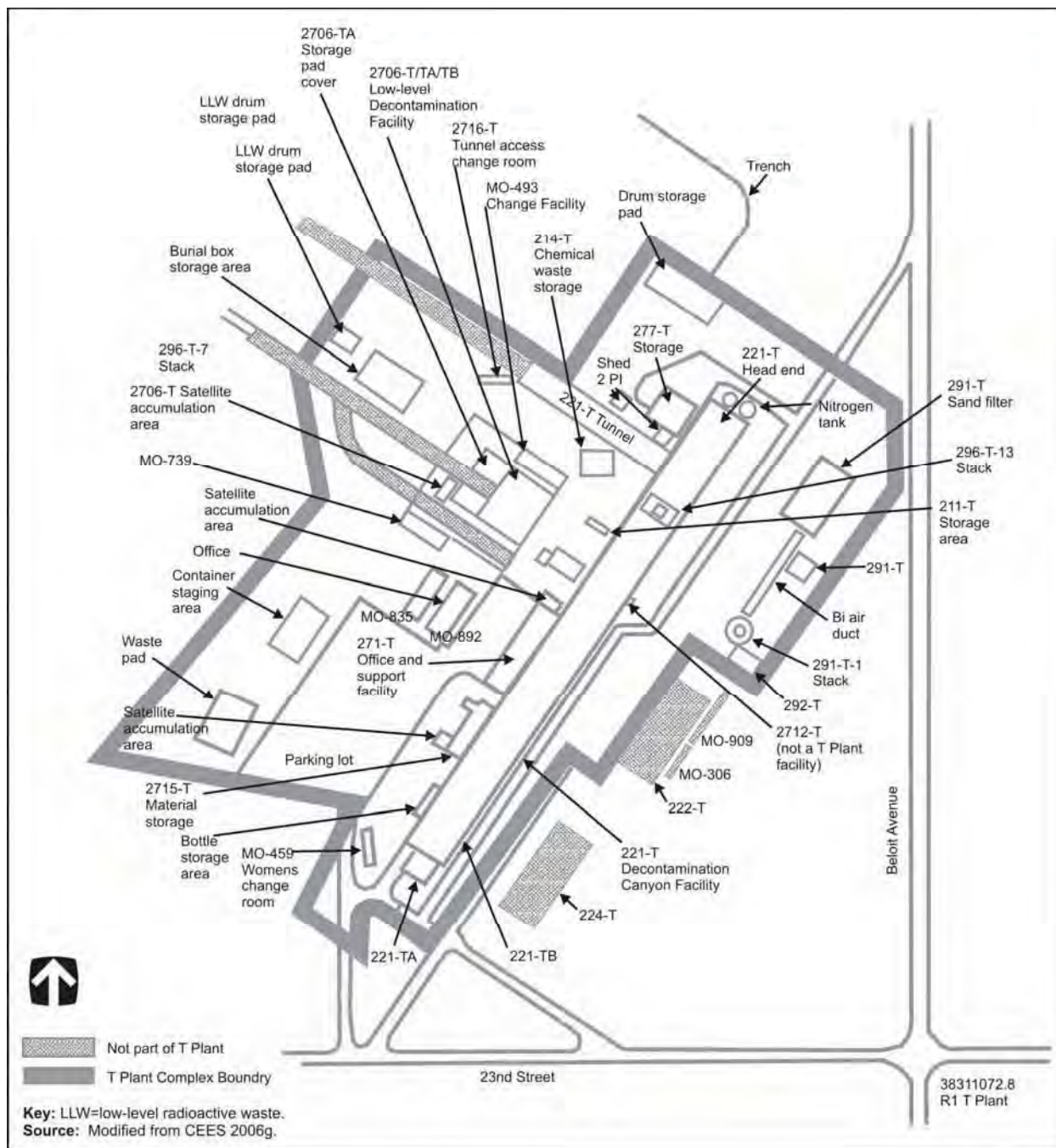

Figure E-53. T Plant Complex Site Plan

E.3.2.3.1.1 221-T Canyon

The 221-T Canyon currently has the capability for some TRU waste processing, including some RH-TRU waste. The capacity of the 221-T Canyon may change over time depending on plans for storing and treating K Basin sludge. The 221-T Canyon continues to be decontaminated and mobile contamination is being fixed; however, the 221-T Canyon still currently requires an air-purifying respirator for manned entries.

The 221-T Canyon is part of the T Plant, which was constructed in 1944. The 221-T Canyon is a heavily shielded, reinforced-concrete structure. The overall area of the 221-T Canyon is 5,400 square meters (57,800 square feet), with a height of 22.6 meters (74 feet) (CEES 2006g).

E.3.2.3.1.2 2706-T/TA/TB Facility

The 2706-T/TA/TB Facility includes the 2706-T building, 2706-TA building addition, 2706-TB building addition, MO-433 Change Facility, and two hazardous waste storage modules. The 2706-T building, the 2706-TA building addition, and 2706-TB building additions make up a single building and are referred to in this document as the “2706-T/TA/TB building.” The surrounding grounds and supporting building are referred to as the “2706-T/TA/TB Facility.” The 2706-T/TA/TB Facility is surrounded by the 2706-T yard area, measuring approximately 61 meters wide by 67 meters long (200 feet wide by 220 feet long) (CEES 2006g).

The 2706-T/TA/TB Facility currently has limited capability to process MLLW and TRU waste. Modifications may be made to the 2706-T/TA/TB Facility to allow additional stabilization, macro-encapsulation, sorting, sampling, repackaging, NDE, and NDA capabilities. All wastes managed by the T Plant are required to meet the T Plant waste acceptance criteria (Fluor Hanford 2005a).

The 2706-T/TA/TB building is a pre-engineered metal building. The foundation is concrete slab on grade throughout. The overall area of the 2706-T/TA/TB building is 900 square meters (9,700 square feet). The 2706-T/TA/TB building has a slanted roof with eaves 7.6 meters (25 feet) above grade and a peak at 9.8 meters (32 feet) above grade. The average height of the 2706-T/TA/TB building is 9 meters (30 feet), giving the 2706-T/TA/TB building an overall facility volume of 8,210 cubic meters (290,000 cubic feet).

Current operations in the 2706-T/TA/TB building include waste sampling, packaging/repackaging, HSGS, and managing “problem” waste containers. To support some of these operations, greenhouse(s) (relocatable confinement structures) are used as necessary in the 2706-T/TA/TB building. An example of a greenhouse erected in the 2706-T/TA/TB building includes two work areas separated by a common entry vestibule. Each work area has an isolatable air space (CEES 2006g).

E.3.2.3.2 T Plant Expansion

Due to the uncertainty of the Hanford waste forecasts, it was assumed for analysis purposes that additional solid waste processing capabilities would be required as soon as possible following issuance of the ROD and would be gained by construction of another 2706-T/TA/TB-type building near the T Plant. This would allow processing of high dose-equivalent curie or high-dose waste in the 221-T Canyon, while all other CH-waste processing could be shifted to the 2706-T/TA/TB building. The average 2706-T/TA/TB building throughput was assumed to be 900 cubic meters (1,200 cubic yards) of LLW and MLLW per year (based on previous performance [Barcot 2002], but limited to a potential source term of 3.0 dose-equivalent curies per year). The decision to expand the T Plant was based on the following assumptions:

- The average T Plant (221-T Canyon and 2706-T/TA/TB Facility) solid waste processing throughput is 1,800 cubic meters (2,400 cubic yards) of LLW and MLLW, based on previous performance. The 2706-T/TA/TB building processed 500 cubic meters (650 cubic yards) of LLW and MLLW in 2005; 1,800 cubic meters (2,400 cubic yards) in 2004; and 1,910 cubic meters (2,500 cubic yards) in 2003 (Barcot 2002).
- Solid waste processing at the T Plant is split between the 221-T Canyon and 2706-T/TA/TB Facility (Fluor Hanford 2005a). The 2706-T/TA/TB Facility solid waste processing operations typically do not require supplied air or shielding, and there are no high-dose areas within the 2706-T/TA/TB Facility. Therefore, the 2706-T/TA/TB Facility is the

preferred location to process CH solid waste at the T Plant, based on operational requirements. However, some solid waste exceeds the limitation on the 2706-T/TA/TB Facility of 3.0 dose-equivalent curies per year (some exceptions have been made for vented HEPA containers) and must be processed in the 221-T Canyon along with RH solid waste. The processing split between the two processing areas changes with time, depending on the needs of the greater SWOC at any given time. The average processing capacity is assumed to be evenly split between the 221-T Canyon and 2706-T/TA/TB Facility (based on engineering judgment). Therefore, the average processing capacity of the 2706-T/TA/TB Facility is assumed to be 900 cubic meters (1,200 cubic yards) of LLW and MLLW.

- The waste-container-processing capacity of the 2706-T/TA/TB building is in linear relation to the number of units available for processing (CEES 2006g).

Under Waste Management Alternatives 2 and 3, three T Plant expansion activities are analyzed: construction, operations, and deactivation of another 2706-T/TA/TB-type building near the T Plant. Closure and postclosure care of this T Plant expansion is not within the scope of the Waste Management alternatives, but is analyzed in Chapters 6, “Cumulative Impacts.” Construction activities include the resources and materials necessary to construct a replacement of the 2706-T/TA/TB building. Operations includes the resources, materials, and labor necessary to conduct solid waste processing of up to 900 cubic meters (1,200 cubic yards) per year of CH-LLW and CH-MLLW. Deactivation activities, including the removal of all containers containing radioactive and hazardous materials to ensure adequate protection of workers, public health and safety, and the environment, would place the facility in a stable and known condition. The T Plant deactivation assumes that 1 percent of 1 year’s throughput remains in the facility, and that it takes 6 months to clean up the facility with no waste processing during that period.

Additional solid waste NDE and NDA capacity is gained by the use of APLs containing NDE and/or NDA equipment supporting solid waste processing activities in the 2706-T/TA/TB building for CH-TRU waste drums and standard waste boxes. The APLs may be operated from within one of the 2706-T/TA/TB building bays and may use greenhouse isolation for contamination control, similar to the greenhouse currently employed at the T Plant. Currently, the T Plant has some capability to perform macroencapsulation activities to support management of problem waste containers. Additional solid waste macroencapsulation capacity may be gained by the use of APLs containing macroencapsulation trains to support solid waste processing activities in the 2706-T/TA/TB building. The APLs may be operated from within one of the 2706-T/TA/TB building bays and may use greenhouse isolation for contamination control, similar to the greenhouse currently employed at the T Plant (CEES 2006g).

Waste Management Alternative 1 does not analyze the expansion of the T Plant; under this alternative, the existing, permitted, T Plant would operate to support onsite-generated waste.

E.3.2.4 Waste Receiving and Processing Facility

E.3.2.4.1 Description

WRAP, located in the 200-West Area of Hanford, was completed in the late 1990s. WRAP comprises three buildings: 2336W, the main processing facility; 2740W, the administrative support building; and 2620W, the maintenance support building. WRAP is designed to process certain sizes of CH-LLW, -MLLW, -TRU waste, and -mixed TRU waste. A second building was planned for processing of RH waste, but was never constructed. The original design life of WRAP was 30 years. WRAP is a Hazard Category 2 nuclear facility (CEES 2006h; Weidert 2003).

The main objectives of WRAP are receiving, verifying, repackaging/treating (if necessary), certifying, and shipping TRU waste to WIPP. WRAP receives containers of CH waste from Hanford generators, including the CWC, Waste Retrieval Operations, LLBG, T Plant, and other onsite generators, as well as

**Draft Tank Closure and Waste Management Environmental Impact Statement for the
Hanford Site, Richland, Washington**

from offsite generators. Radioactive waste is processed in three operational areas within WRAP main processing facility. These are the shipping and receiving area, NDE/NDA area, and process area. Current and future activities at WRAP for all types of waste packages include shipping, receiving, waste-container-handling, waste-container-staging/storage, nonintrusive surveying, and inspection. Inspections include NDE, NDA, and visual examination of open waste containers in gloveboxes. Additional activities at WRAP include treating waste, intrusive sampling, packaging, repackaging, loading, HSGS, drum-venting, and decontamination.

Present throughput at WRAP, when operating two full shifts per day, is 300 waste containers (LLW or CH-TRU waste) per month, or 3,600 containers per year. WRAP provides storage and staging of up to 348 drums, 16 SWBs inside the facility, and 50 LLW containers in an outside storage area.

The maximum radioactive material inventory for a single container (drum or waste box) within the SWOC is 500 grams (18 ounces), at 0.165 dose-equivalent curies (based on the inhalation equivalent of 1 curie of plutonium-239) per gram (0.04 curies per ounce), or an 82.5 dose-equivalent curie maximum content per single container. The radioactive material source strength administrative control limit for WRAP is 5,700 dose-equivalent curies (CEES 2006h). Figures E-54 and E-55 are layouts of the WRAP 2336W Building and the shipping and receiving area within the 2336W Building (CEES 2006h).

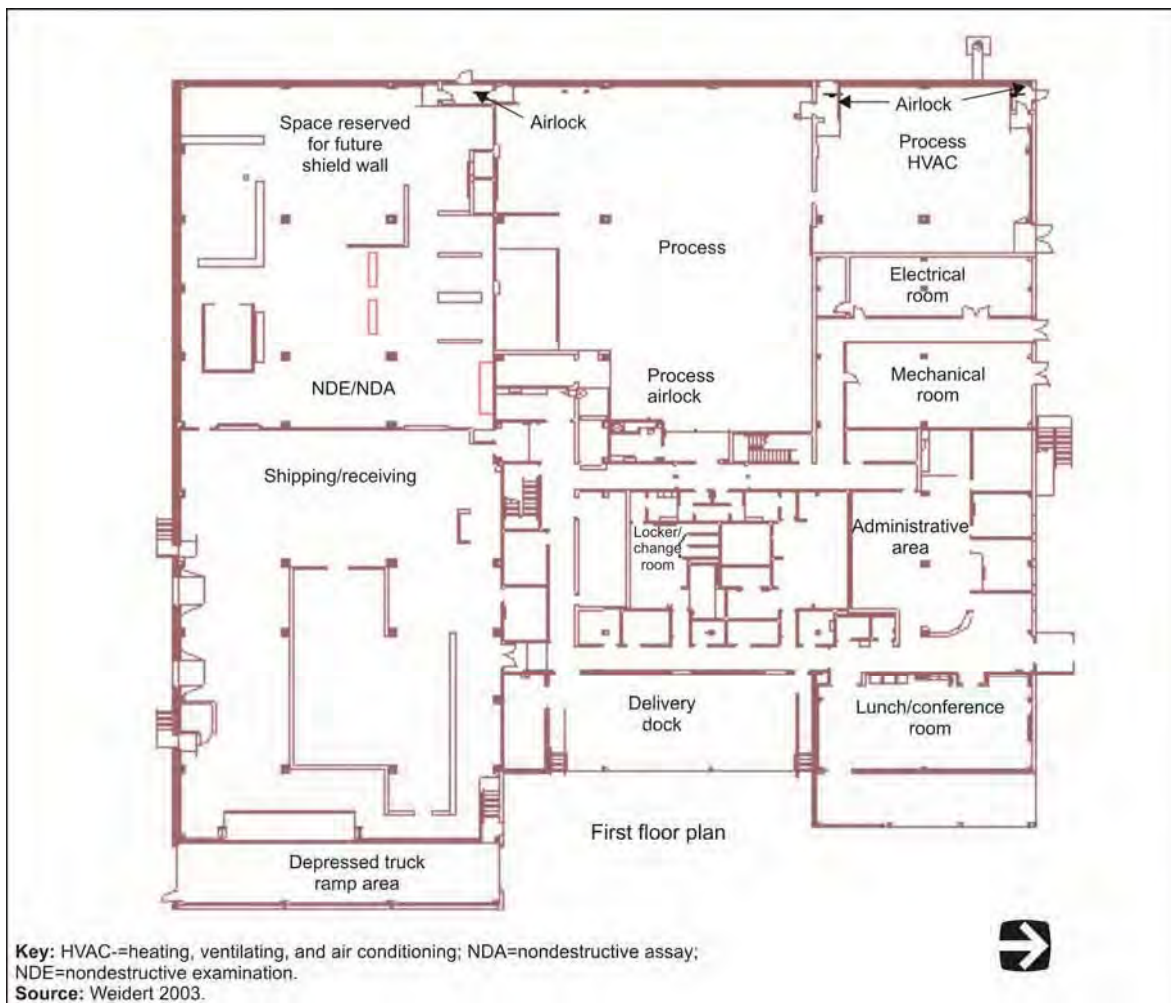

Figure E-54. Waste Receiving and Processing Facility Structure Floor Plan

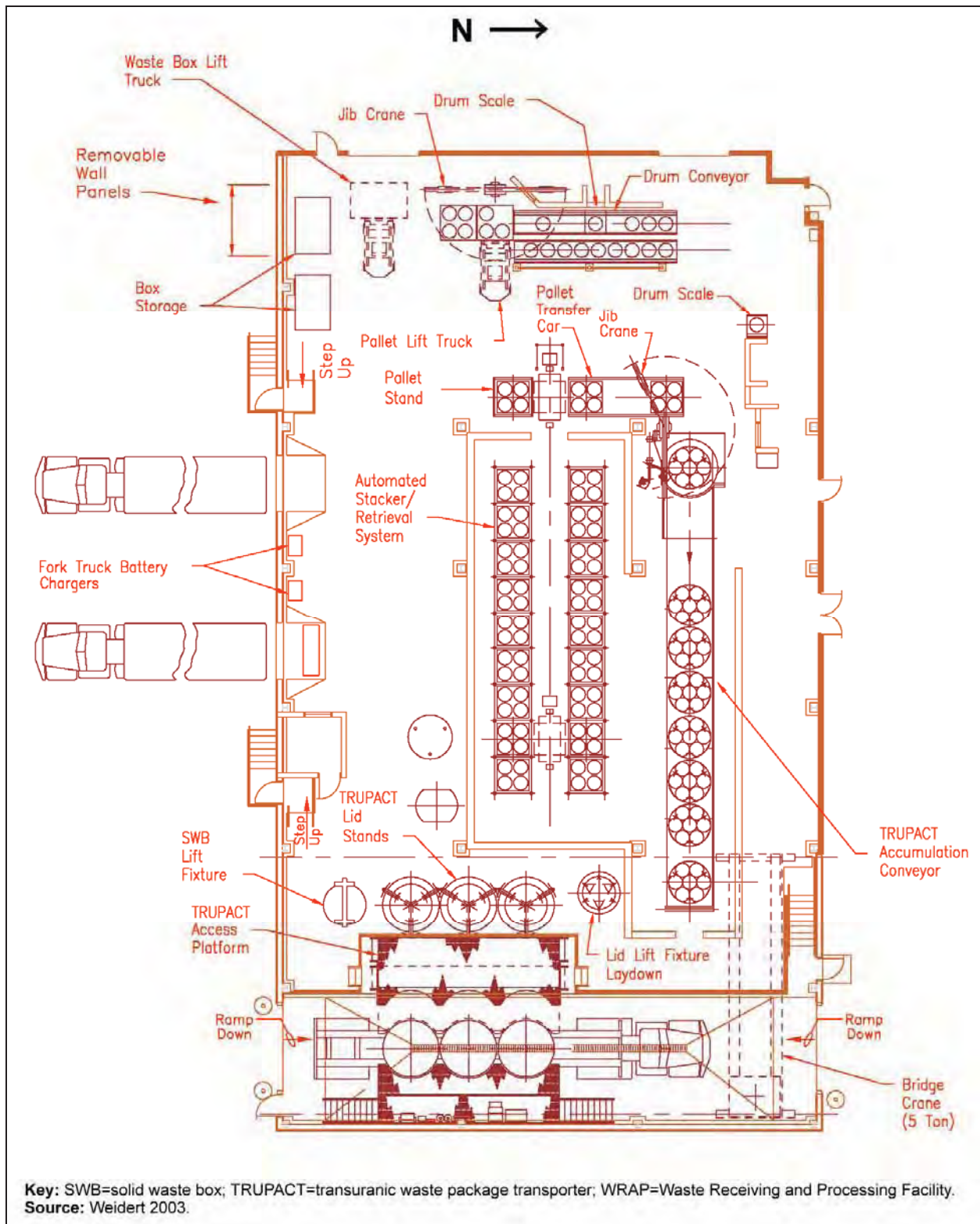

Figure E-55. Waste Receiving and Processing Facility Shipping and Receiving Area Floor Plan and Equipment Layout

E.3.2.4.2 Waste Receiving and Processing Facility Expansions

Due to the uncertainty of the waste forecasts for Hanford, it was assumed for analysis purposes that additional solid waste processing capability would be required in WRAP as soon as possible following issuance of the ROD, and that this capability would be gained by the addition of two capabilities, as follows:

- **Expanded CH-LLW, CH-MLLW, and CH-TRU Waste Processing Capability.** The existing WRAP 2336W main processing facility has no vacant area for expansion of LLW, MLLW, or CH-TRU waste processing activities. To increase the throughput of waste operations at WRAP, additional structure(s) would be needed. Addition of structures was previously considered as part of proposed SWOC accelerated closure initiatives. Accelerated closure analysis determined that the best method of increasing throughput at WRAP was to construct new, or modify existing, storage buildings at the CWC for expanded waste processing activities. The CWC buildings can be modified to accept the APL trailers within the building to perform NDE, NDA, and HSGS activities that would allow processing of up to a 1.5- by 1.5- by 2.7-meter (5- by 5- by 9-foot) box of waste. Although no APL trailers are presently installed within the buildings, the infrastructure needed for their installation already exists.

To increase CH-LLW, CH-MLLW, or CH-TRU waste processing capabilities beyond the level achieved through installation of APL trailers in the CWC buildings, new CWC buildings would need to be constructed. For each new CWC building constructed, the associated waste throughput would increase by approximately 40 percent because the new CWC would have the capability for HSGS and for one NDE and one NDA unit, but no glovebox for visual examinations. Resource impacts associated with construction, operation, and deactivation of CWC expansion buildings were estimated within the CWC expansion analysis. The results of the CWC expansion analysis were identical to the resources required to determine the construction and deactivation resource impacts of increasing the WRAP CH-LLW, CH-MLLW, or CH-TRU waste processing throughput. Operational resource information for increased waste processing throughput was based on a scaled (40 percent container throughput increase per CWC building) basis of the operational resource impacts for the present WRAP. Thus, to increase the current WRAP throughput capacity by 100 percent, i.e., to double it to 7,200 containers per year, the current WRAP operations data resources were scaled by a factor of 2.5. For analysis purposes, it was assumed that three additional CWC waste storage buildings identical to 2403-WD would be constructed within the CWC site. These three structures, totaling a building footprint of 15,450 square meters (166,300 square feet), would house the proposed CH-LLW, CH-MLLW, and CH-TRU waste processing equipment (CEES 2006h).

- **RH-TRU Waste Processing Capability.** The existing WRAP has no capability to process RH-TRU waste. Originally, a second phase of WRAP (WRAP II) was to be constructed for processing RH-TRU waste. That facility was never constructed. The WRAP II Facility was to be approximately the same size as the existing WRAP in dimensions, staffing, and resource usage. Because of the similar size and function of WRAP and the proposed WRAP II Facilities, data from the current WRAP data sets were used to determine operation and deactivation resource impacts associated with establishing a new WRAP RH-TRU waste processing facility capable of processing several different sizes of RH-TRU waste packages. This new facility would be constructed adjacent to the existing WRAP (CEES 2006h).

Under Waste Management Alternatives 2 and 3, the WRAP expansion analyses for WRAP CH-TRU waste and WRAP RH-TRU waste facilities include construction, operations, and deactivation. Closure and postclosure care of WRAP expansions are not within the scope of the Waste Management alternatives, but are analyzed in Chapter 6, "Cumulative Impacts." Construction includes the resources,

materials, and labor necessary to construct these facilities. Operations include the resources, materials, and labor necessary to conduct the additional waste processing services. Deactivation resources include those required to place the facilities in a stable and known condition, including the removal of all radioactive and hazardous materials to ensure adequate protection of workers, public health and safety, and the environment. WRAP deactivation assumes that 1 percent of 1 year's throughput remains in each facility and that it takes 6 months to clean up each facility without incurring new waste (CEES 2006h).

Waste Management Alternative 1 does not analyze the expansion of WRAP; under this alternative, the existing, permitted WRAP would operate to support onsite-generated waste.

E.3.3 Low-Level Radioactive Waste Burial Grounds

E.3.3.1 Description

The LLBGs consist of eight separate waste disposal areas consolidated administratively into a single radioactive waste unit (see Table E-17). Six LLBGs are located in the 200-West Area (see Figure E-56) and two are located in the 200-East Area (see Figure E-57). The combined area of the LLBGs totals about 220 hectares (544 acres) (DOE 1997c). LLBG 218-W-6 is reserved for future use; no trenches have been excavated and no waste has been received. All other LLBGs have received waste, although several contain sizable portions where no trenches have been excavated and no waste has been received (CEES 2006i).

Table E-17. Low-Level Radioactive Waste Burial Ground Locations, Service Dates, Areas, and Waste Types

| LLBG | Location | Service Date | Area | | Waste Types |
|-----------|----------|----------------|----------|-------|--|
| | | | Hectares | Acres | |
| 218-E-10 | 200-East | 1960 | 36 | 89 | RH- and CH-LLW, MLLW, most in concrete boxes |
| 218-E-12B | 200-East | 1967 | 68 | 168 | LLW, TRU waste, defueled RCs |
| 218-W-3A | 200-West | 1970 | 20 | 49 | LLW, MLLW, TRU waste |
| 218-W-3AE | 200-West | 1981 | 20 | 49 | RH-LLW, MLLW, large equipment |
| 218-W-4B | 200-West | 1968 | 4 | 10 | TRU waste (in trenches and caissons) |
| 218-W-4C | 200-West | 1978 | 20 | 49 | TRU waste, MLLW, test reactor fuel waste |
| 218-W-5 | 200-West | 1986 | 37 | 91 | LLW, MLLW (two mixed waste trenches) |
| 218-W-6 | 200-West | Not in service | 16 | 40 | Reserved for MLLW trenches |

Key: CH=contact-handled; LLBG=low-level radioactive waste burial ground; LLW=low-level radioactive waste; MLLW=mixed low-level radioactive waste; RC=reactor compartment; RH=remote-handled; TRU=transuranic.

Source: DOE 1997c.

The LLBGs contain lined and unlined trenches of varying size and depth that are used for disposal of LLW and for retrievable storage of TRU waste. Both CH and RH wastes are disposed of and retrievably stored at the LLBG. All waste accepted for disposal must meet the requirements specified in the HSSWAC (Fluor Hanford 2005a).

Portions of the LLBGs contain mixed waste that is subject to WAC 173-303. Other portions contain only LLW and are designated as solid waste management units. The LLBGs have been permitted under an RCRA Part A permit since 1985 and operate as an interim-status facility pending final administrative disposition of the LLBG Part B permit application (DOE 1997c).

Draft Tank Closure and Waste Management Environmental Impact Statement for the Hanford Site, Richland, Washington

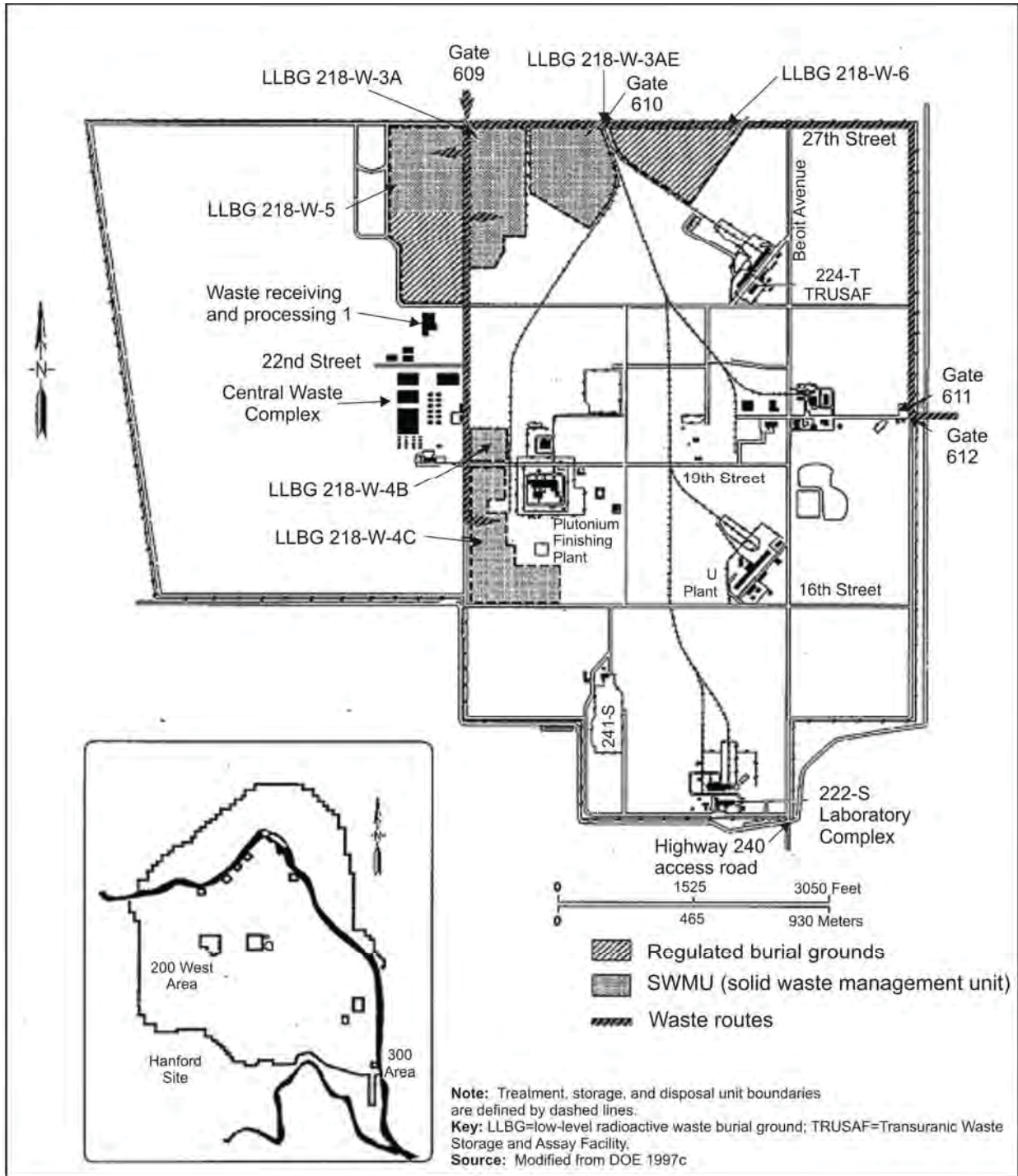

Figure E-56. 200-West Area Low-Level Radioactive Waste Burial Grounds

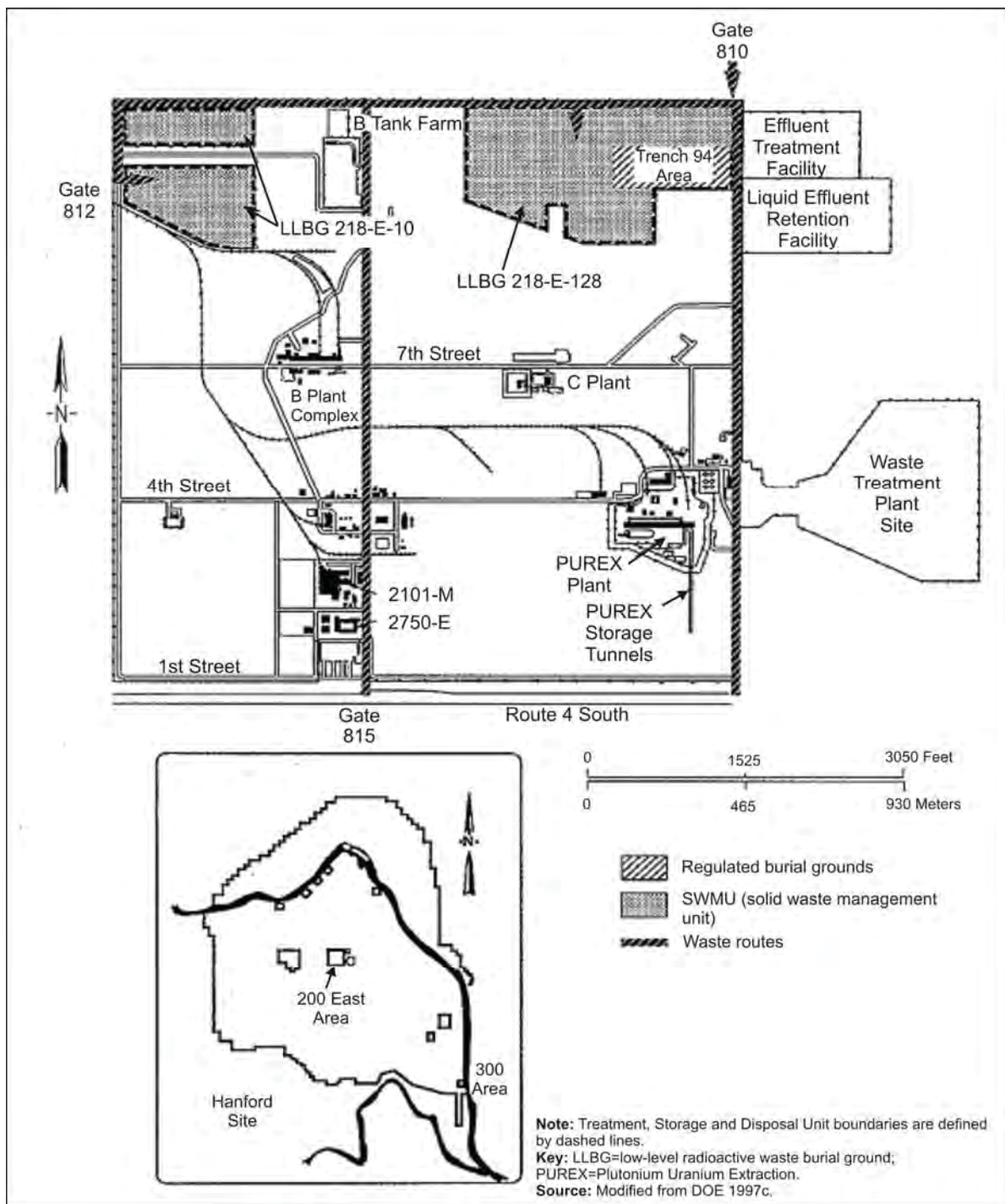

Figure E-57. 200-East Area Low-Level Radioactive Waste Burial Grounds

The earliest active burial ground operations began in 1960. From 1960 to 1970, waste was buried in shallow unlined trenches without regard to radionuclide content or hazardous components. Beginning in 1970, suspect TRU waste was segregated from other radioactive waste and placed in retrievable storage configurations in various unlined LLBG trenches. Both soil-covered and uncovered storage configurations were used. Some RH-TRU waste in small containers was placed in underground alpha (TRU waste) caissons in LLBG 218-W-4B. TRU waste has not been placed in the LLBGs since 1987 (CEES 2006i).

Burial of MLLW in the LLBGs was halted in 1987; from 1987 until the opening in 1999 of a lined RCRA-compliant trench in LLBG 218-W-5 (trench 34), MLLW was sent to storage in the CWC. Since 1999, MLLW meeting the RCRA land-disposal-restriction treatment standards has been disposed of in trench 34. A second lined RCRA-compliant trench (trench 31), located adjacent to trench 34, became operational for disposal in 2004. Trenches 31 and 34 are the only lined trenches in the LLBGs (CEES 2006i).

In 2004, DOE announced its decision to cease disposing of radioactive waste in unlined trenches (“Record of Decision for the **Solid Waste Program, Hanford Site, Richland, WA: Storage and Treatment of Low-Level Waste and Mixed Low-Level Waste; Disposal of Low-Level Waste and Mixed Low-Level Waste, and Storage, Processing, and Certification of Transuranic Waste for Shipment to the Waste Isolation Pilot Plant,**” 69 FR 39449). Since 2004, all waste received for disposal at the LLBG, whether LLW or MLLW, has been disposed of in trenches 31 and 34. Disposal operations at all other existing LLBG trenches have ceased. The only exception is trench 94 in LLBG 218-E-12B, which is an unlined trench currently used for disposal of defueled Navy reactor components. Trench 94 is not affected by the DOE 2004 decision and continues to receive reactor components (CEES 2006i).

TRU waste retrieval activities are currently ongoing at trenches in LLBG 218-W-3A, 218-W-4B, and 218-W-4C. The TPA (Ecology, EPA, and DOE 1989) requires DOE to retrieve all CH-TRU waste from LLBGs 218-E-12B, 218-W-3A, 218-W-4B, and 218-W-4C by 2010 (Milestone M-91-40); retrieve noncaisson RH-TRU waste by 2014 (M-91-41); and retrieve caisson RH-TRU waste by 2018 (M-91-41) (CEES 2006i). The impacts of retrieving the caisson RH-TRU waste from the four “alpha caissons” and noncaissoned TRU waste are analyzed in Chapter 6 “Cumulative Impacts.”

Retrieval of radioactive waste buried before 1970 is not part of the proposed actions and is not analyzed in the alternatives section of this TC & WM EIS. Chapter 6 includes analysis of this waste.

E.3.3.2 Low-Level Radioactive Waste Burial Ground Activities

Continued use of the two lined LLBGs, trenches 31 and 34 at 218-W-5, was analyzed under all three Waste Management alternatives. Activities analyzed include disposal operations at the two mixed waste trenches (ditches), which consist of:

- Placement of disposal layers within the trenches
- Placement of intermediate soil cover between disposal layers
- Placement of final soil cover to grade level
- Collection and removal of leachate (CEES 2006i)

Rain or snowmelt captured by the trench liner systems is drained to a sump, pumped to a holding tank, and removed by tanker truck for treatment at the ETF.

To meet HSSWAC requirements (Fluor Hanford 2005a), Category 3 LLW/MLLW must be disposed of either in a high-integrity container or an in-trench grouted encasement (monolith). Interviews with the current facility contractor indicated that high-integrity container use for disposal of Category 3 waste in trenches 31 and 34 has been discontinued in favor of in-trench grouting. Typical disposal practice for in-trench grouting, or concrete encasement, involves placing concrete forms and rebar around a stack of waste containers and pouring concrete to encase the waste. This results in a solid freestanding monolith. For analysis purposes, construction resource information for monolith construction was included in the resource requirements for LLBG operations. Dimensions of the waste stacked for concrete encasement are typically 39.6 meters long by 3.4 meters wide by 2.1 meters high (130 feet long by 11 feet wide by 7 feet high). The effective disposal volume of a typical monolith is approximately 116 cubic meters (152 cubic yards) of waste. The number of grout campaigns completed annually will depend on

Category 3 waste receipts. Because the waste volume projections are not yet finalized, it was assumed that one concrete monolith would be constructed during each year of operation (CEES 2006i).

Construction activities are not included because the trenches are in current operation. Deactivation is not applicable because operations include filling the landfill with soil to grade level following completion of waste disposal activities, which is normally a deactivation activity. Closure and postclosure care are not analyzed for the trenches as well as the other LLBGs because these activities are not included in the scope of the TC & WM EIS alternatives analysis. However, LLBG closure and postclosure care impacts are analyzed in Chapter 6, “Cumulative Impacts.” Likewise, retrieval of retrievably stored TRU waste from the LLBGs is analyzed in Chapter 6.

Both trenches 31 and 34 are rectangular units with depths of 9.1 to 12.2 meters (30 to 40 feet). Both have surface dimensions of about 137 meters long by 91 meters wide (450 feet long by 300 feet wide) and base dimensions of about 76 meters long by 30 meters wide (250 feet long by 100 feet wide). The total finished airspace volume of each trench from base to ground surface is approximately 53,000 cubic meters (69,000 cubic yards) (WHC 1994). The excavation spoils from construction of trenches 31 and 34 were stockpiled within the 218-W-5 LLBG for use as operational cover. Figure E-58 is a layout of LLBG 218-W-5 depicting the location of trenches 31 and 34 (CEES 2006i).

The following is a description of the three configurations under each Waste Management alternative.

- **Waste Management Alternative 1.** Under the No Action Alternative, the two lined trenches, 31 and 34, would continue to receive LLW and MLLW from onsite, non-CERCLA sources through 2035. It was assumed that, by the year 2035, no additional LLW and MLLW would be generated under the No Action Alternative.
- **Waste Management Alternatives 2 and 3.** Under both alternatives, the two lined trenches in LLBG 218-W-5, 31 and 34, would continue to receive LLW and MLLW from onsite, non-CERCLA sources until they are filled, which is estimated to be in the year 2050. The current remaining space in the two trenches is approximately 17,215 cubic meters (22,520 cubic yards); at the projected emplacement rate, the trenches would be filled to capacity by no later than 2050 (CEES 2006i). For analysis purposes, this EIS assumed the trenches would continue to operate even after IDF-East begins operations in 2009, however, all waste generated after the opening of IDF-East was assumed to be disposed of in IDF-East, not trenches 31 and 34.

E.3.4 Integrated Disposal Facility

E.3.4.1 Description

IDF-East, as it currently exists, is partially constructed and permitted for only limited use. Assuming completion (construction would cease under the No Action Alternative), IDF-East would consist of a single landfill with two separate, expandable cells. The landfill would be divided lengthwise, with one cell for disposal of LLW and the other cell permitted as an RCRA-compliant landfill system for disposal of MLLW and ILAW. The mission of IDF-East includes the following functions:

- Provide an approved disposal facility for the permanent, environmentally safe disposition of MLLW, including vitrified ILAW packages that meet the environmental requirements and are approved by DOE and Ecology.
- Provide an approved disposal facility for LLW that meets the requirements of DOE.
- Conduct solid waste operations to receive and dispose of on- and offsite-generated mixed waste and solid LLW (CEES 2006j).

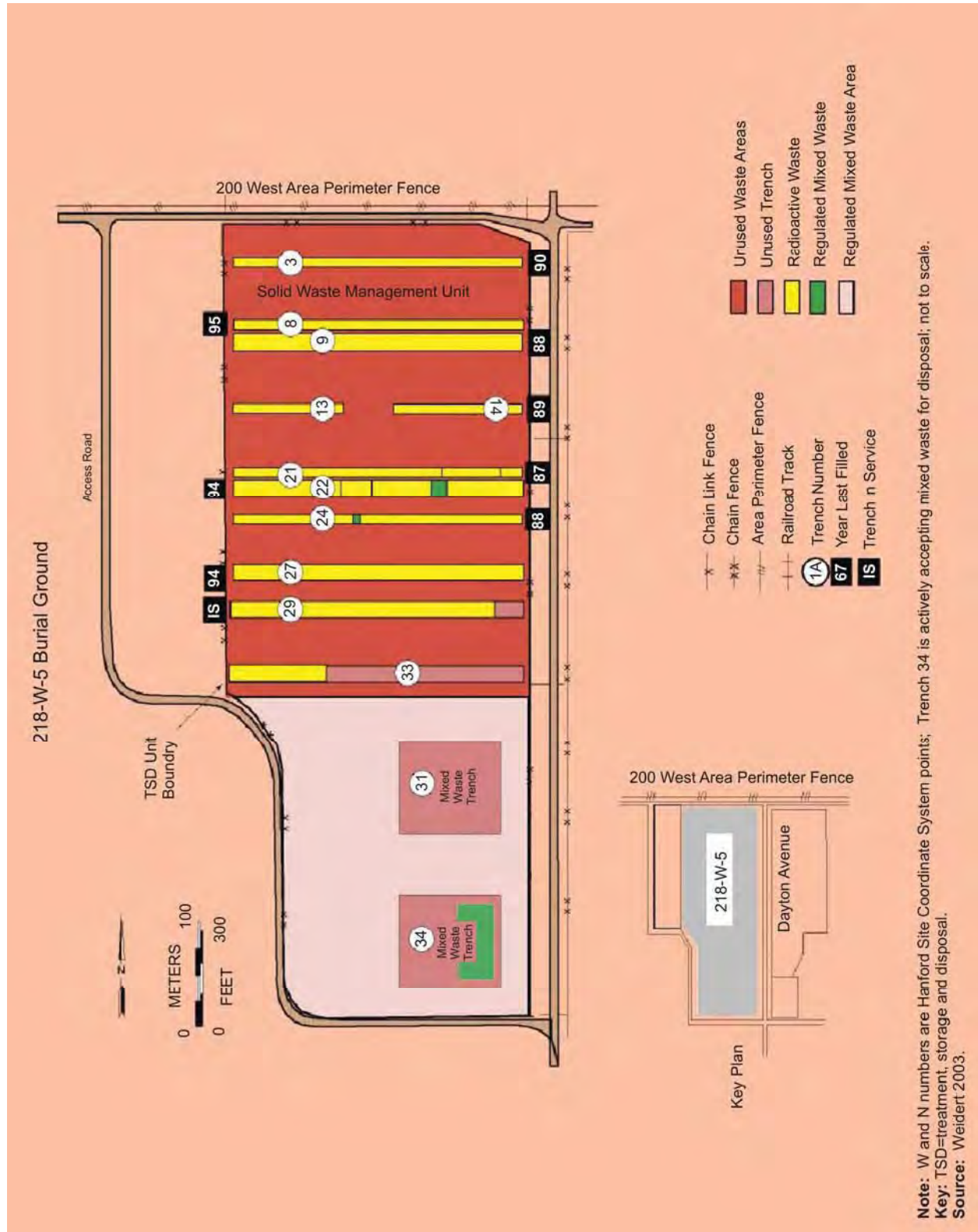

Figure E-58. Low-Level Radioactive Waste Burial Ground 218-W-5

The currently planned IDF-East would dispose of approximately 900,000 cubic meters (1.18 million cubic yards) of LLW and MLLW. However, this EIS analyzes different configurations and capacities as described in Section E.3.4.2. IDF-East would not accept CERCLA waste, but would dispose of ILAW glass from the WTP, STP wastes (e.g., bulk vitrification glass, cast stone waste, steam reforming waste), mixed waste generated through waste operations, other LLW, offsite-generated MLLW and LLW, and the LAW melters taken out of service (CEES 2006j).

The IDF cells would include a double liner, a leachate collection and removal system, and a leak detection system and the liner system would comply with RCRA requirements for hazardous waste landfills. When completed, IDF-East's dimensions would be 442 meters wide by 555 meters long, and 13.1 meters deep (1,450 feet wide by 1,820 feet long and 43 feet deep), with current planned capacity of 900,000 cubic meters (1.18 million cubic yards) of LLW and MLLW (CEES 2006j). As of April 2006, two cells had been constructed. The dimensions of this completed section of IDF-East are approximately 457 meters wide by 233 meters long and 12.8 meters deep (1,500 feet wide by 765 feet long and 42 feet deep) (CEES 2007d).

Four IDF activities are analyzed under the Waste Management alternatives: construction, operations, closure, and postclosure care. Deactivation is not applicable since the proposed operations would include filling the landfill with soil to grade level following completion of waste disposal activities, which is normally a deactivation activity.

- **Construction.** Construction would consist of soil excavation and placement of the RCRA-compliant liner system. IDF-East's location in the 200-East Area and its dimensions were obtained from the **Preliminary Closure Plan for the Integrated Disposal Facility (RPP-21633)** (Baune 2004). IDF-East construction was assumed to occur from 2006 through 2008.
- **Operations.** Operations would consist of placement of disposal units within the landfill, soil cover between the disposal layers, and providing final soil cover to grade level. IDF-East operations resources were obtained from **Integrated Disposal Facility (IDF) Operations and Maintenance Philosophy, Final Report (RPP-18516)** (Dehner and Comstock 2004).
- **Closure.** Closure would consist of placement of a modified RCRA Subtitle C barrier over the landfill (CEES 2006j).
- **Postclosure Care.** Postclosure care would consist of air, groundwater, and vadose zone monitoring. As planned, postclosure care would occur for 100 years following completion of the modified RCRA Subtitle C barrier (CEES 2006j).

E.3.4.2 Integrated Disposal Facility Configurations

A number of different IDF configurations are analyzed within the three Waste Management alternatives. Following is a brief description of the configurations analyzed under each Waste Management alternative.

- **Waste Management Alternative 1.** Following a TC & WM EIS ROD of No Action, current construction operations at IDF-East would cease and the construction site would be deactivated. Deactivation activities would include liner removal and backfilling the site to restore the area back to its natural grade (SAIC 2007c, 2008).
- **Waste Management Alternative 2.** Construction of IDF-East would continue at the current site (see Figure E-11). For analysis purposes, three disposal groups have been identified to support Hanford waste management needs. Each disposal group would support a specific number of Tank Closure, FFTF Decommissioning, and Waste Management alternatives. These groupings were developed to limit the number of iterations of analysis and to support reader understanding.

While it was recognized that some of the Tank Closure, FFTF Decommissioning, or Waste Management alternatives may be penalized due to oversizing of IDF-East to support all Tank Closure alternatives within each disposal group, it was concluded that such oversizing would be minor and the benefits would outweigh the negatives. Each disposal group under Waste Management Alternative 2 is summarized in Table E-18.

Table E-18. Waste Management Alternative 2 Disposal Groups

| Parameters | IDF-East | | |
|---|--------------------------|------------------------|--------------------|
| | Group 1 | Group 2 | Group 3 |
| Tank Closure alternatives supported | 2B, 3A, 3B, 3C, 4, 5, 6C | 2A, 6B Base, 6B Option | 6A Base, 6A Option |
| FFTF Decommissioning alternatives supported | All | All | All |
| Offsite waste | Yes | Yes | Yes |
| Onsite, non-CERCLA waste | Yes | Yes | Yes |
| Capacity (cubic meters) | 1,200,000 | 425,000 | 425,000 |
| Size (hectares) | 33 | 11 | 11 |
| Last year of operations | 2050 | 2100 | 2165 |

Note: To convert cubic meters to cubic yards, multiply by 1.308; hectares to acres, by 2.471.

Key: Base=Base Case; CERCLA=Comprehensive Environmental Response, Compensation, and Liability Act; FFTF=Fast Flux Test Facility; IDF-East=200-East Area Integrated Disposal Facility; Option=Option Case.

Source: SAIC 2007c.

- **Disposal Group 1.** This disposal group would support Tank Closure Alternatives 2B, 3A, 3B, 3C, 4, 5, and 6C, as well as any of the three FFTF Decommissioning alternatives and disposal of other onsite-generated, non-CERCLA LLW and MLLW and projected waste shipments from other DOE sites. A capacity of 1.2 million cubic meters (1.6 million cubic yards) would be required for IDF-East operations continuing through 2050. This capacity would exceed the currently planned capacity of 900,000 cubic meters (1.18 million cubic yards) by approximately 33 percent.
- **Disposal Group 2.** This disposal group would support Tank Closure Alternatives 2A and 6B (Base and Option Cases), as well as any of the three FFTF Decommissioning alternatives, as well as disposal of other onsite-generated, non-CERCLA LLW and MLLW and projected waste shipments from other DOE sites. A capacity of 425,000 cubic meters (555,900 cubic yards) would be required for IDF-East operations continuing through 2100. This capacity would be approximately 53 percent less than the currently planned capacity of 900,000 cubic meters (1.18 million cubic yards).
- **Disposal Group 3.** This disposal group would support Tank Closure Alternative 6A (Base and Option Cases), as well as any of the three FFTF Decommissioning alternatives, as well as disposal of other onsite-generated, non-CERCLA LLW and MLLW and projected waste shipments from other DOE sites. A capacity of 425,000 cubic meters (556,000 cubic yards) would be required for IDF-East operations continuing through 2165. This capacity would be approximately 53 percent less than the currently planned capacity of 900,000 cubic meters (1.18 million cubic yards) (SAIC 2007c).
- **Waste Management Alternative 3.** Two IDFs would be constructed under this alternative. IDF-East in the 200-East Area would receive only waste generated by the Tank Closure alternatives. IDF-West in the 200-West Area (north of WRAP and northwest of LLBG 218-W-5) would receive the balance of the waste that is not disposed of in IDF-East (FFTF Decommissioning alternative waste, onsite-generated, non-CERCLA waste, and projected

waste shipments from other DOE sites). See Figure E–11 for the proposed locations of IDF-East and IDF-West. As with Waste Management Alternative 2, for analysis purposes, three disposal groups were identified to support Hanford waste management needs. These groupings were developed to limit the number of iterations of analysis and to support reader understanding. While it is recognized that some of the Tank Closure, FFTF Decommissioning, or Waste Management alternatives may be penalized due to oversizing of IDF-East to support all Tank Closure alternatives within each disposal group, it was concluded that such oversizing would be minor and the benefits would outweigh the negatives. Each disposal group for Waste Management Alternative 3 is summarized in Table E–19.

Table E–19. Waste Management Alternative 3 Disposal Groups

| Parameters | IDF-East | | | IDF-West |
|---|--------------------------|------------------------|--------------------|---------------------|
| | Group 1 | Group 2 | Group 3 | All Disposal Groups |
| Tank Closure alternatives supported | 2B, 3A, 3B, 3C, 4, 5, 6C | 2A, 6B Base, 6B Option | 6A Base, 6A Option | N/A |
| FFTF Decommissioning alternatives supported | N/A | N/A | N/A | All |
| Offsite waste | N/A | N/A | N/A | Yes |
| Onsite, non-CERCLA waste | N/A | N/A | N/A | Yes |
| Capacity (cubic meters) | 1,100,000 | 340,000 | 340,000 | 90,000 |
| Size (hectares) | 30.0 | 9.3 | 9.3 | 2.4 |
| Last year of operations | 2050 | 2100 | 2165 | 2050 |

Note: To convert from cubic meters to cubic yards, multiply by 1.308; hectares to acres, by 2.471.

Key: Base=Base Case; CERCLA=Comprehensive Environmental Response, Compensation, and Liability Act; FFTF=Fast Flux Test Facility; IDF-East=200-East Area Integrated Disposal Facility; IDF-West=200-West Area Integrated Disposal Facility; N/A=not applicable; Option=Option Case.

Source: SAIC 2007c.

- **Disposal Group 1.** This disposal group would support Tank Closure Alternatives 2B, 3A, 3B, 3C, 4, 5, and 6C. IDF-East would have a capacity of 1.1 million cubic meters (1.43 million cubic yards), exceeding the currently planned capacity of 900,000 cubic meters (1.18 million cubic yards) by approximately 22 percent, and would be required to operate through 2050. IDF-West would have a capacity of 90,000 cubic meters (118,000 cubic yards), approximately 90 percent less than the currently planned IDF-East, and would be required to operate through 2050. IDF-West would support any of the three FFTF Decommissioning alternatives, as well as disposal of other onsite-generated, non-CERCLA LLW and MLLW and projected waste shipments from other DOE sites.
- **Disposal Group 2.** This disposal group would support Tank Closure Alternatives 2A and 6B (Base and Option Cases). IDF-East would have a capacity of 340,000 cubic meters (445,000 cubic yards), approximately 62 percent less than the currently planned capacity of 900,000 cubic meters (1.18 million cubic yards), and would be required to operate through 2100. IDF-West would have a capacity of 90,000 cubic meters (118,000 cubic yards), approximately 90 percent less than the currently planned IDF-East capacity, and would be required to operate through 2050. IDF-West would support any of the three FFTF Decommissioning alternatives, as well as disposal of other onsite-generated, non-CERCLA LLW and MLLW and projected waste shipments from other DOE sites.
- **Disposal Group 3.** This disposal group would support Tank Closure Alternative 6A (Base and Option Cases). IDF-East would have a capacity of 340,000 cubic meters (445,000 cubic yards), approximately 62 percent less than the currently planned capacity of 900,000 cubic meters (1.18 million cubic yards), and would be required to operate through

2165. IDF-West would have a capacity of 90,000 cubic meters (118,000 cubic yards), approximately 90 percent less than the currently planned IDF-East, and would be required to operate through 2050 (SAIC 2007c). IDF-West would support any of the three FFTF Decommissioning alternatives, as well as disposal of other onsite-generated, non-CERCLA LLW and MLLW and projected waste shipments from other DOE sites.

E.3.5 River Protection Project Disposal Facility

E.3.5.1 Description

Another onsite disposal facility analyzed under the Waste Management alternatives is the RPPDF. The RPPDF would support disposal of moderately and lightly contaminated RSE resulting from closure activities at the SST farms under many of the Tank Closure alternatives. For analysis purposes, it was assumed that the design, construction, and operations activities necessary for the RPPDF would be identical to those needed for IDF-East (CEES 2006j). However, the capacity of the RPPDF would differ from the IDF-East capacities described above. Therefore, scaling factors were applied to the IDF-East estimates to support the projected RPPDF estimates.

E.3.5.2 River Protection Project Disposal Facility Activities

As with the IDFs, four RPPDF activities were analyzed under the Tank Closure alternatives: construction, operations, closure, and postclosure care. Construction would include all the necessary actions to build the disposal site and all the required resources and materials. Operations would include all the necessary resources to operate the landfill, including the disposition of leachate at the ETF. Closure would consist of placement of a modified RCRA Subtitle C barrier over the landfill (CEES 2006j). Postclosure care would consist of air, groundwater, and vadose zone monitoring. Postclosure care is planned for 100 years following completion of the modified RCRA Subtitle C barrier (CEES 2006j). Deactivation is not applicable because operations would include filling the landfill with soil to grade level following completion of waste disposal activities, which is normally a deactivation activity.

The Tank Closure alternatives that generate moderately and lightly contaminated RSE are Tank Closure Alternatives 2B, 3A, 3B, 3C, 4, 6A (Base and Option Cases), 6B (Base and Option Cases), and 6C. Tank Closure Alternatives 2B, 3A, 3B, 3C, and 6C would generate RSE from the removal of 4.6 meters (15 feet) of soil and ancillary equipment at the BX and SX tank farms. Tank Closure Alternative 4 would generate RSE from the clean closure of the BX and SX tank farms, which are SST tank farms that have had past, unintentional releases. Finally, Tank Closure Alternatives 6A, Base Case, and 6B, Base Case, would generate RSE from the clean closure of all 12 SST farms, and Tank Closure Alternatives 6A, Option Case, and 6B, Option Case, would generate RSE from clean closure of all 12 SST farms and the six sets of contiguous cribs and trenches (ditches).

- **Waste Management Alternative 1.** Following a TC & WM EIS ROD of No Action, there would be no need for the RPPDF because no clean closure activities would be conducted. Therefore, no construction activities would begin on the RPPDF.
- **Waste Management Alternative 2.** A single RPPDF would be constructed at a site near IDF-East. See Figure E-11 for the proposed location. As with the IDFs, for analysis purposes, three disposal groups were identified to support clean closure activities under the Tank Closure alternatives. Each disposal group would support a number of Tank Closure alternatives. These groupings were developed to limit the number of iterations of analysis and to aid in reader understanding. While it is recognized that some of the Tank Closure alternatives may be penalized due to the resulting oversizing of the RPPDF to support all of the Tank Closure alternatives within a disposal group, it was concluded that such oversizing would be minor and

the benefits would outweigh the negatives of doing so. Each disposal group for Waste Management Alternative 2 is defined, as follows (SAIC 2007c, 2008):

- **Disposal Group 1.** The RPPDF would have a capacity of approximately 1.08 million cubic meters (1.41 million cubic yards) and would be required to operate through 2050. Disposal Group 1 would support Tank Closure Alternatives 2B, 3A, 3B, 3C, 4, and 6C, all of which would generate RSE from the removal of 4.6 meters (15 feet) of soil and ancillary equipment at the BX and SX tank farms.
- **Disposal Group 2.** The RPPDF would have a capacity of approximately 8.37 million cubic meters (10.9 million cubic yards) and would be required to operate through 2100. This group would support Tank Closure Alternative 6B (Base and Option Cases).
- **Disposal Group 3.** The RPPDF would have a capacity of approximately 8.37 million cubic meters (10.9 million cubic yards) and would be required to operate through 2165. Disposal Group 3 would support Tank Closure Alternative 6A (Base and Option Cases).
- **Waste Management Alternative 3.** Sizing and location of the RPPDF would be the same as described under Waste Management Alternative 2, above.

Table E–20 summarizes the disposal groups for the RPPDF under Waste Management Alternatives 2 and 3.

Table E–20. Waste Management Alternatives 2 and 3 RPPDF Disposal Groups

| Waste Management Alternatives 2 and 3 | | | |
|---------------------------------------|------------------------|------------------------|------------------------|
| Parameters | RPPDF Disposal Group 1 | RPPDF Disposal Group 2 | RPPDF Disposal Group 3 |
| Tank Closure alternatives supported | 2B, 3A, 3B, 3C, 4, 6C | 6B Base and Option | 6A Base and Option |
| Capacity (cubic meters) | 1,080,000 | 8,370,000 | 8,370,000 |
| Size (hectares) | 30 | 228 | 228 |
| Last year of operations | 2050 | 2100 | 2165 |

Note: To convert cubic meters to cubic yards, multiply by 1.308; hectares to acres, by 2.471.

Key: Base=Base Case; Option=Option Case; RPPDF=River Protection Project Disposal Facility.

E.4 REFERENCES

ANL-W (Argonne National Laboratory-West), 2004, **Idaho National Laboratory, Conceptual Design Report for the Remote Treatment Project, Annex to the Hot Fuel Examination Facility**, W7000-0134-ES, Rev. 4, Idaho Falls, Idaho, December.

ANL-W and Fluor Hanford (Argonne National Laboratory-West, Idaho Falls, Idaho, and Fluor Hanford, Inc., Richland, Washington), 2002, **Hanford Site Sodium Disposition Trade-Off Study**, April.

Bacon, D.H., E.M. Pierce, D.M. Wellman, D.M. Strachan, and G.B. Josephson, 2006, **Corrosion of Metal Inclusions in Bulk Vitrification Waste Packages**, PNNL-15947, Pacific Northwest National Laboratory, Richland, Washington, July.

Bagaasen, L.M., J.H. Westsik Jr., and T.M. Brouns, 2005, **Waste-Form Qualification Compliance Strategy for Bulk Vitrification**, PNNL-15048, Pacific Northwest National Laboratory, Richland, Washington, January.

**Draft Tank Closure and Waste Management Environmental Impact Statement for the
Hanford Site, Richland, Washington**

Bailey, S.A., C.P. Baker, O.D. Mullen, and P.L.J. Valdez, 2006, **Solid Waste Processing Center Primary Opening Cells Systems, Equipment, and Tools**, PNNL-15779, Pacific Northwest National Laboratory, Richland, Washington, April.

Barcot, R.A., 2002, **Solid Waste Integrated Forecast Technical (SWIFT) Report, FY2002–FY2046**, HNF-EP-0918, Rev. 9, Fluor Hanford, Inc., Richland, Washington, March.

Barcot, R.A., 2005, **Solid Waste Integrated Forecast Technical (SWIFT) Report, FY2006–FY2035, 2006.0, Volume 1**, HNF-EP-0918, Rev. 16, Fluor Hanford, Inc., Richland, Washington, December.

Barnett, D.B., G.W. Gee, M.D. Sweeney, M.D. Johnson, V.F. Medina, D.P. Mendoza, B.G. Fritz et al., 2003, **Results of Performance Evaluation Testing of Electrical Leak-Detection Methods at the Hanford Site Mock Tank – FY 2002–2003**, PNNL-14192, Pacific Northwest National Laboratory, Richland, Washington, February.

Baune, H.L., 2004, **Preliminary Closure Plan for the Integrated Disposal Facility**, RPP-21633, Rev. 0, CH2M HILL Hanford Group, Inc., Richland, Washington, October 25.

BNI (Bechtel National, Inc.), 2004, **HLW Melter Radioactive Inventory at End of Life**, 24590-HLW-M5C-HMP-00002, Rev. B, Bechtel National, Inc., Richland, Washington, April 8.

BNI (Bechtel National, Inc.), 2005, **Flowsheet Bases, Assumptions, and Requirements**, 24590-WTP-RPT-PT-02-005, Rev. 3, Richland, Washington, June 29.

Boomer, K.D., S.K. Baker, A.L. Boldt, J.D. Galbraith, J.S. Garfield, C.E. Golberg, B.A. Higley et al., 1993, **Tank Waste Technical Options Report**, WHC-EP-0616, Rev. 0, Westinghouse Hanford Company, Richland, Washington, March 31.

Burandt, M., 2007, U.S. Department of Energy, personal communication (email) to C.L. Johnson, M.A. Spivey, and L.B. Gannon, Science Applications International Corporation, Germantown, Maryland, “Final Sodium Language Worked out with WTP,” Attachment, Draft Sodium Language comments 061107 (2).doc, June 19.

Burke, T.M., 2007, **Hanford Site Sodium Disposition Evaluation Report**, HNF-33211, Rev. 0, Fluor Hanford, Inc., Richland, Washington, May.

Burket, P.R., J.C. Marra, J.M. Pareizs, and C.M. Jantzen, 2005, **Evaluation of Fluidized Bed Steam Reforming (FBSR) Technology for Sodium Bearing Wastes from Idaho and Hanford Using the Bench-Top Steam Reformer (BSR) (U)**, WSRC-TR-2004-00560, Rev. 0, Savannah River National Laboratory, Aiken, South Carolina, February.

Calmus, R.B., and J.R. Baker, 2001, **Failed Melter Disposal – Alternative Generation and Analysis, and Decision Report**, RPP-9605, Rev. 0, CH2M HILL Hanford Group, Inc., Richland, Washington, December.

Campbell, T.A., 2004, **Documented Safety Analysis for the 242-A Evaporator**, HNF-14755, Rev. 1, CH2M HILL Hanford Group, Inc., Richland, Washington, September 29.

Carpenter, K.E., 2002, **241-C-104 Waste Retrieval System Preliminary Design Report (Project W-523)**, RPP-10829, Rev. 0, CH2M HILL Hanford Group, Inc., Richland, Washington, September 16.

CEES (Columbia Energy & Environmental Services, Inc.), 2004, **Optimized Drum Estimates for RH-TRU Single-Shell Tanks**, WT-ST-046, Rev. 0, Richland, Washington, April 27.

CEES (Columbia Energy & Environmental Services, Inc.), 2006a, **Closure-003, Evaporator Replacement Calculation**, CHG 17546 NEPA, Rev. 1, Richland, Washington, September 29.

CEES (Columbia Energy & Environmental Services, Inc.), 2006b, **Effluent Treatment Facility Replacement Calculation**, 6734-ETF-001, Rev. 0, Richland, Washington, September 29.

CEES (Columbia Energy & Environmental Services, Inc.), 2006c, **De-encapsulation and Treatment of the Cesium and Strontium Capsules at WTP**, WT-ST-053, Rev. 1, Richland, Washington, September 29.

CEES (Columbia Energy & Environmental Services, Inc.), 2006d, **Data Sheet Support Calculations for New Data Set #2, Treat All Waste As HLW**, WT-ST-025, Rev. 6, Richland, Washington, October 18.

CEES (Columbia Energy & Environmental Services, Inc.), 2006e, **FFTF Remote-Handled Special Components Inventory**, 6734-FFTF-Inventory-001, Rev. 0, Richland, Washington, May 24.

CEES (Columbia Energy & Environmental Services, Inc.), 2006f, **Central Waste Complex Expansion Resource Calculation**, 6734-CWC-001, Rev. 0, Richland, Washington, September.

CEES (Columbia Energy & Environmental Services, Inc.), 2006g, **T-Plant Facility Resource Calculation**, 6734-T-Plant-001, Rev. 1, Richland, Washington, September 29.

CEES (Columbia Energy & Environmental Services, Inc.), 2006h, **Waste Receiving and Processing Facility Resource Calculation**, 6734-WRAP-001, Rev. 2, Richland, Washington, October.

CEES (Columbia Energy & Environmental Services, Inc.), 2006i, **Low-Level Burial Grounds Construction, Operation, Closure, Deactivation, and Post-closure Monitoring**, 6734-LLBG-001, Rev. 3, Richland, Washington, September 27.

CEES (Columbia Energy & Environmental Services, Inc.), 2006j, **“Tank Closure and Waste Management EIS” Disposal Facilities**, WD-008, Rev. 1, Richland, Washington, September.

CEES (Columbia Energy & Environmental Services, Inc.), 2007a, **Revision of PCAL 17284-2 Mass Balance**, WT-ST-056, WT-ST-056, Rev. 2, Richland, Washington, March.

CEES (Columbia Energy & Environmental Services, Inc.), 2007b, **Curie Distribution for Alternatives 1, 2A, 2B, 3A, 3B, 3C, 4, 5, 6A, 6B and 6C**, WT-ST-042, WT-ST-042, Rev. 8, Richland, Washington, July 24.

CEES (Columbia Energy & Environmental Services, Inc.), 2007c, **Estimated Glass Quantities from PPF Operations**, WT-ST-040, Rev. 4, Richland, Washington, January 10.

CEES (Columbia Energy & Environmental Services, Inc.), 2007d, **Removal and Treatment of B/BX/BY and T/TX/TY Cribs and Trenches**, WT-ST-052, Rev. 4, Richland, Washington, January 17.

Certa, P.J., T.M. Hohl, R.L. Lytle, G.K. Allen, K.N. Jordan, T.W. Crawford, and R.A. Kirkbride, 2008, **River Protection Project System Plan**, ORP-11242, Rev. 3A, U.S. Department of Energy, Office of River Protection, Richland, Washington, July.

CH2M HILL (CH2M HILL Hanford Group, Inc.), 2002, **S-112 Project Proof-of-Principle Test Plan/Procedure for Cold Test Facility**, RPP-10884, Rev. 0, Richland, Washington, June.

CH2M HILL (CH2M HILL Hanford Group, Inc.), 2003a, **Mission Acceleration Initiative Demonstration Information Package**, RPP-11131, Rev. 0, Richland, Washington.

**Draft Tank Closure and Waste Management Environmental Impact Statement for the
Hanford Site, Richland, Washington**

CH2M HILL (CH2M HILL Hanford Group, Inc.), 2003b. This reference is for Official Use Only.

CH2M HILL (CH2M HILL Hanford Group, Inc.), 2003c, **Single-Shell Tank System Description**, RPP-15043, Rev. 0, Richland, Washington, March.

CH2M HILL (CH2M HILL Hanford Group, Inc.), 2004, **Process Description of the Solid/Liquid Separation Facility Deployed Before the Supplemental Technology in the 200 West Area**, Data Form No. 132, Richland, Washington, May 4.

CH2M HILL (CH2M HILL Hanford Group, Inc.), 2006a, **A Comprehensive Technical Review of the Demonstration Bulk Vitrification System**, RPP-31314, Vol. 1, Richland, Washington, September 28.

CH2M HILL (CH2M HILL Hanford Group, Inc.), 2006b, **Data Request 202 – Supplemental Treatment Data Review for the Tank Closure EIS**, Data Form No. 202, Richland, Washington, April 17.

Chapin, D.H., 2007, U.S. Department of Energy, Richland Operations Office, Richland, Washington, personal communication (email) to C.L. Johnson, Science Applications International Corporation, Germantown, Maryland, “DOE-RL/FFTF Project Response to SAIC (Charlotte Johnson) Re: Status of FFTF Deactivation,” Attachment, “Status of FFTF Project Deactivation (June 2007),” June 6.

Choho, A.F., and K.A. Gasper, 2002, **Evaluation of Low-Activity Waste Feed Supplemental Treatment Options by the C3T Mission Acceleration Initiative Team for the Office of River Protection**, RPP-11306, Rev. 0, CH2M HILL Hanford Group, Inc., Richland, Washington, July.

Claghorn, R.D., 1996, **Trade Study for the Disposition of Cesium and Strontium Capsules**, WHC-SD-WM-ES-382, Rev. 0, Westinghouse Hanford Company, Richland, Washington, March.

Colosi, K.A., 2002, **Project W-464, Immobilized High-Level Waste Interim Storage Facility, Preliminary Design Report**, RPP-12364, Rev. 0, CH2M HILL Hanford Group, Inc., Richland, Washington, November 12.

Dehner, J., and D.C. Comstock, 2004, **Integrated Disposal Facility (IDF) Operations and Maintenance Philosophy, Final Report**, RPP-18516, Rev. 0, CH2M HILL Hanford Group, Inc., Richland, Washington, September.

DOE (U.S. Department of Energy), 1995, **Environmental Assessment, Shutdown of the Fast Flux Test Facility, Hanford Site, Richland, Washington**, DOE/EA-0993, Richland Operations Office, Richland, Washington, May.

DOE (U.S. Department of Energy), 1996, **Focused Feasibility Study of Engineered Barriers for Waste Management Units in the 200 Areas**, DOE/RL-93-33, Rev. 0, Office of Environmental Restoration and Waste Management, May.

DOE (U.S. Department of Energy), 1997a, **Final Waste Management Programmatic Environmental Impact Statement for Managing Treatment, Storage, and Disposal of Radioactive and Hazardous Waste**, DOE/EIS-0200-F, Office of Environmental Management, Washington, D.C., May.

DOE (U.S. Department of Energy), 1997b, **Waste Isolation Pilot Plant Disposal Phase Final Supplemental Environmental Impact Statement**, DOE/EIS-0026-S-2, Carlsbad Area Office, Carlsbad, New Mexico, September.

DOE (U.S. Department of Energy), 1997c, **Hanford Facility Dangerous Waste Permit Application, Low-Level Burial Grounds**, DOE/RL-88-20, Rev. 1, Richland Operations Office, Richland, Washington, July.

DOE (U.S. Department of Energy), 1998, **Supplement Analysis for the Tank Waste Remediation System**, DOE/EIS-0189-SA2, Richland Operations Office, Richland, Washington, May.

DOE (U.S. Department of Energy), 1999, **Final Hanford Comprehensive Land-Use Plan Environmental Impact Statement**, DOE/EIS-0222-F, Richland Operations Office, Richland, Washington, September.

DOE (U.S. Department of Energy), 2000, **Final Programmatic Environmental Impact Statement for Accomplishing Expanded Civilian Nuclear Energy Research and Development and Isotope Production Missions in the United States, Including the Role of the Fast Flux Test Facility**, DOE/EIS-0310, Office of Nuclear Energy, Science and Technology, Washington, D.C., December.

DOE (U.S. Department of Energy), 2002a, **Contact-Handled Transuranic Waste Acceptance Criteria for the Waste Isolation Pilot Plant**, DOE/WIPP-02-3122, Rev. 0.1, Carlsbad Field Office, Carlsbad, New Mexico, July 25.

DOE (U.S. Department of Energy), 2002b, **National TRU Waste Management Plan, Corporate Board Annual Report**, DOE/NTP-96-1204, Rev. 3, Carlsbad Field Office, Carlsbad, New Mexico, July.

DOE (U.S. Department of Energy), 2003a, **Environmental Impact Statement for Retrieval, Treatment, and Disposal of Tank Waste and Closure of Single-Shell Tanks at the Hanford Site, Richland, WA: No Action Baseline Tank Farm Operations and Waste Treatment Data Package**, DOE/ORP-2003-08, Rev. 0, Office of River Protection, Richland, Washington, April 17.

DOE (U.S. Department of Energy), 2003b, **Environmental Impact Statement for Retrieval, Treatment, and Disposal of Tank Waste and Closure of Single-Shell Tanks at the Hanford Site, Richland, WA: Tank System Closure and Facility D&D Data Package**, DOE/ORP-2003-05, Rev. 0, Office of River Protection, Richland, Washington, April 17.

DOE (U.S. Department of Energy), 2003c, **Environmental Impact Statement for Retrieval, Treatment, and Disposal of Tank Waste and Closure of Single-Shell Tanks at the Hanford Site, Richland, WA: Waste Retrieval and Storage Data Package**, DOE/ORP-2003-06, Rev. 0, Office of River Protection, Richland, Washington, April 17.

DOE (U.S. Department of Energy), 2003d, **Environmental Impact Statement for Retrieval, Treatment, and Disposal of Tank Waste and Closure of Single-Shell Tanks at the Hanford Site, Richland, WA: Waste Disposal Data Package**, DOE/ORP-2003-04, Rev. 0, Office of River Protection, Richland, Washington, April 17.

DOE (U.S. Department of Energy), 2003e, **Environmental Impact Statement for Retrieval, Treatment, and Disposal of Tank Waste and Closure of Single-Shell Tanks at the Hanford Site, Richland, WA: Waste Treatment and Supplemental Technology Data Package**, DOE/ORP-2003-07, Rev. 0, Office of River Protection, Richland, Washington, April 17.

DOE (U.S. Department of Energy), 2003f. This reference is for Official Use Only.

DOE (U.S. Department of Energy), 2003g, **Environmental Impact Statement for Retrieval, Treatment, and Disposal of Tank Waste and Closure of Single-Shell Tanks at the Hanford Site, Richland, WA: Inventory and Source Term Data Package**, DOE/ORP-2003-02, Rev. 0, Office of River Protection, Richland, Washington, April 17.

**Draft Tank Closure and Waste Management Environmental Impact Statement for the
Hanford Site, Richland, Washington**

DOE (U.S. Department of Energy), 2003h, **Tank Removal and Deep Soil Excavation**, Rev. 0, Office of River Protection, Richland, Washington, May 15.

DOE (U.S. Department of Energy), 2006, **Environmental Assessment, Sodium Residuals Reaction/Removal and Other Deactivation Work Activities, Fast Flux Test Facility (FFTF) Project, Hanford Site, Richland, Washington**, DOE/EA-1547F, Richland Operations Office, Richland, Washington, March.

DOE (U.S. Department of Energy), 2007, **Civilian Radioactive Waste Management System Waste Acceptance System Requirements Document**, DOE/RW-0351, Rev. 5, Office of Civilian Radioactive Waste Management, May 31.

DOE (U.S. Department of Energy), 2008, **Draft Environmental Assessment for the Remote-Handled Waste Disposition Project**, DOE/EA-01386, Idaho Operations Office, Idaho Falls, Idaho, December.

DOE and Ecology (U.S. Department of Energy, Richland Operations Office, Richland, Washington, and Washington State Department of Ecology, Olympia, Washington), 1996, **Tank Waste Remediation System, Hanford Site, Richland, Washington, Final Environmental Impact Statement**, DOE/EIS-0189, August.

Ecology (Washington State Department of Ecology), 2005, **Permit for Dangerous and or Mixed Waste Research, Development, and Demonstration**, Permit No. WA 7890008967, Nuclear Waste Program, Richland, Washington, January 12.

Ecology, EPA, and DOE (Washington State Department of Ecology, Olympia, Washington; U.S. Environmental Protection Agency, Washington, D.C.; and U.S. Department of Energy, Richland, Washington), 1989, Hanford Federal Facility Agreement and Consent Order, 89-10, as amended, accessed through <http://www.hanford.gov/tpa/tpahome.htm>.

Ecology, EPA, and DOE (Washington State Department of Ecology, Olympia, Washington; U.S. Environmental Protection Agency, Washington, D.C.; and U.S. Department of Energy, Richland, Washington), 2002, Reestablish Milestones and Target Dates for the Shutdown (Transition; Pursuant to Tri-Party Agreement Section 8) of the Fast Flux Test Facility (FFTF) (M-81-00 Series and M-20-29A), Hanford Federal Facility Agreement and Consent Order Change Control Form, M-81-02-01, July 31.

Ecology, EPA, and DOE (Washington State Department of Ecology, Olympia, Washington; U.S. Environmental Protection Agency, Washington, D.C.; and U.S. Department of Energy, Richland, Washington), 2003, Reestablish Agreement M-92-09 and M-92-10 Interim Milestones Associated with the Management and Disposition of U.S. Department of Energy (DOE) Hanford Site Radioactive Sodium As Product, Hanford Federal Facility Agreement and Consent Order Change Control Form, M-92-02-01, June 25.

EPA (U.S. Environmental Protection Agency), 1989, **Technical Guidance Document, Final Covers on Hazardous Waste Landfills and Surface Impoundments**, Office of Solid Waste and Emergency Response, EPA/530/SW-89/047, Washington, D.C., and Office of Research and Development, Risk Reduction Engineering Laboratory, Cincinnati, Ohio, July.

Fluor Hanford (Fluor Hanford, Inc.), 2004a, **Quarterly Discharge Monitoring Reports for the 200 Area Effluent Treatment and Treated Effluent Disposal Facilities Covering the April 2004 Through June 2004 Reporting Period**, FH-0402259, Richland, Washington, August 4.

Fluor Hanford (Fluor Hanford, Inc.), 2004b, **Quarterly Discharge Monitoring Reports for the 200 Area Effluent Treatment and Treated Effluent Disposal Facilities Covering the July 2004 Through September 2004 Reporting Period**, FH-0403487, Richland, Washington, October 29.

Fluor Hanford (Fluor Hanford, Inc.), 2005a, **Hanford Site Solid Waste Acceptance Criteria**, HNF-EP-0063, Rev. 12, Richland, Washington, July 6.

Fluor Hanford (Fluor Hanford, Inc.), 2005b, **Quarterly Discharge Monitoring Reports for the 200 Area Effluent Treatment and Treated Effluent Disposal Facilities Covering the October 2004 Through December 2004 Reporting Period**, FH-0500374, Richland, Washington, February 8.

Fluor Hanford (Fluor Hanford, Inc.), 2005c, **Technical Information Document for the Fast Flux Test Facility Closure Project Environmental Impact Statement**, FFTF-18346, Rev. 1, Richland, Washington, April.

Fredenburg, E., 2003, **Engineering Report for Interim Closure for Tank No. 241-C-106 and the 241-C Farm 200-Series Tanks**, RPP-14590, Rev. 0, CH2M HILL Hanford Group, Inc., Richland, Washington, February 11.

Friday, K.K., and H.J. Sterling, 2002, **Tri-Party Agreement Databases, Access Mechanism and Procedures**, DOE/RL-93-69, Rev. 3, U.S. Department of Energy, Richland, Washington, March.

Gasper, K.A., K.D. Boomer, M.E. Johnson, G.W. Reddick, Jr., A.F. Choho, and J.S. Garfield, 2002, **Recommendation for Supplemental Technologies for Potential Mission Acceleration**, RPP-11261, Rev. 0, CH2M HILL Hanford Group, Inc., Richland, Washington, July.

Hamilton, D.W., 2005, **Technical Assessment of Fractional Crystallization for Tank Waste Pretreatment at the Department of Energy Hanford Site**, RPP-28469, Rev. 0, CH2M HILL Hanford Group, Inc., Richland, Washington, December 22.

Hamilton, D.W., 2006a, **Hanford Medium/Low Curie Waste Pretreatment Project – Pretreatment Process Plan**, RPP-PLAN-27238, Rev. 0, CH2M HILL Hanford Group, Inc., Richland, Washington, January 18.

Hamilton, D.W., 2006b, **Hanford Medium/Low Curie Waste Pretreatment Project – Phase I Laboratory Report**, RPP-RPT-27239, Rev. 0, CH2M HILL Hanford Group, Inc., Richland, Washington, January 30.

Hanlon, B.M., 2003, **Waste Tank Summary Report for Month Ending December 31, 2002**, HNF-EP-0182, Rev. 177, CH2M HILL Hanford Group, Inc., Richland, Washington, February.

Hanson, C.E., 2003, **Tank S-112 Saltcake Waste Retrieval Demonstration Project Leak Detection, Monitoring and Mitigation Strategy**, RPP-10413, Rev. 0, CH2M HILL Hanford Group, Inc., Richland, Washington, February.

Hebdon, J., 2001, U.S. Department of Energy, Richland Operations Office, Richland, Washington, personal communication (letter) to M.A. Wilson, State of Washington, Department of Ecology, Kennewick, Washington, “Response to the Washington State Department of Ecology (Ecology) Inspection of the Inactive Miscellaneous Underground Storage Tanks (IMUST),” July 25.

Hedges, J.A., 2008, Washington State Department of Ecology, Richland, Washington, personal communication (letter) to S.J. Olinger, U.S. Department of Energy, Office of River Protection, Richland, Washington, D.A. Brockman, U.S. Department of Energy, Richland Operations Office, Richland, Washington, and W.S. Elkins, Bechtel National, Inc., Richland, Washington, “Draft Waste Treatment and Immobilization Plant (WTP) Dangerous Waste Permit,” October 15.

**Draft Tank Closure and Waste Management Environmental Impact Statement for the
Hanford Site, Richland, Washington**

INEEL (Idaho National Engineering and Environmental Laboratory), 2001, **Idaho National Engineering and Environmental Laboratory Site Treatment Plan**, accessed through http://www.deq.state.id.us/waste/data_reports/haz_waste/INEEL_site_treatment_plan_2001.pdf, October.

Jantzen, C.M., 2002, **Engineering Study of the Hanford Low Activity Waste (LAW) Steam Reforming Process (U)**, WSRC-TR-2002-00317, Rev. 0, Westinghouse Savannah River Company, LLC, Aiken, South Carolina, July 12.

Jantzen, C.M., 2003, **Characterization and Performance of Fluidized Bed Steam Reforming (FBSR) Product As a Final Waste Form (U)**, WSRC-MS-2003-00595, Rev. 0, Westinghouse Savannah River Company, LLC, Aiken, South Carolina.

Jeppson, D.W., ed., 1973, **Technical Manual, Waste Encapsulation and Storage Facility**, SD-RE-TM-002, Rev. 0, Atlantic Richfield Hanford Company, Richland, Washington, April.

Johnson, W.L., and B.M. Parker, 2004, **Establishment of a Cost-Effective and Robust Planning Basis for the Processing of M-91 Waste at the Hanford Site**, PNNL-14778, Pacific Northwest National Laboratory, Richland, Washington, July.

Koerner, J.A., R.N. Wagner, and F.N. McDonald, 1995, **200 Area Effluent Treatment Facility Auditable Safety Analysis Report**, WHC-SD-ETF-ASA-001, Rev. 1, Westinghouse Hanford Company, Richland, Washington, December.

Lockrem, L.L., 2005, **Hanford Containerized Cast Stone Facility Task 1 – Process Testing and Development Final Test Report**, RPP-RPT-26742, Rev. 0, CH2M HILL Hanford Group, Inc., Richland, Washington, July 15.

Lowe, S., and P. Haigh, 2003, **ICD 03 – Interface Control Document for Radioactive Solid Waste**, 24590-WTP-ICD-MG-01-003, Rev. 3, U.S. Department of Energy, Office of River Protection, Richland, Washington, August 15.

Mann, F.M., K.C. Burgard, W.R. Root, R.J. Puigh, S.H. Finfrock, E.J. Freeman, R. Khaleel et al., 2001, **Hanford Immobilized Low-Activity Waste Performance Assessment: 2001 Version**, DOE/ORP-2000-24, Rev. 0, U.S. Department of Energy, Office of River Protection, Richland, Washington, August.

May, T.H., K.D. Boomer, L.A. Mahoney, and J. Reddick, 2004, **Supplemental Treatment Test and Demonstration Facility Process Flowsheet**, RPP-20528, Rev. 0, CH2M HILL Hanford Group, Inc., Richland, Washington, April.

McGrail, B.P., H.T. Schaefer, P.F. Martin, D.H. Bacon, E.A. Rodriguez, D.E. McCready, A.N. Primak, and R.D. Orr, 2003, **Initial Suitability Evaluation of Steam-Reformed Low Activity Waste for Direct Land Disposal**, WTP-RPT-097, Rev. 0, Bechtel National, Inc., Richland, Washington, January.

Olson, A.L., N.R. Soelberg, D.W. Marshall, and G.L. Anderson, 2004, **Fluidized Bed Steam Reforming of Hanford LAW Using THORSM Mineralizing Technology**, INEEL/EXT-04-02492, Idaho National Engineering and Environmental Laboratory, Idaho Falls, Idaho, November.

ORNL (Oak Ridge National Laboratory), 1988, **Strontium-90 Processing**, Procedure No. IP-514, Chemical Technology Division, Isotope Preparation Department, Oak Ridge, Tennessee, September 19.

Petersen, C.A., 1996, **Technical Basis for Classification of Low-Activity Waste Fraction from Hanford Site Tanks**, WHC-SD-WM-TI-699, Rev. 2, Westinghouse Hanford Company, Richland, Washington, September.

Pierce, E.M., B.P. McGrail, L.M. Bagaasen, E.A. Rodriguez, D.M. Wellman, K.N. Geiszler, S.R. Baum, L.R. Reed, J.V. Crum, and H.T. Schaef, 2005, *Laboratory Testing of Bulk Vitrified Low-Activity Waste Forms to Support the 2005 Integrated Disposal Facility Performance Assessment*, PNNL-15126, Rev. 1, Pacific Northwest National Laboratory, Richland, Washington, June.

Riess, M.J., 2002, *Accelerated Tank Closure Demonstration Alternatives Generation and Analysis Report*, RPP-12194, Rev. 0, CH2M HILL Hanford Group, Inc., Richland, Washington, September.

Rispoli, J.A., 2007, U.S. Department of Energy, Washington, D.C., personal communication (memorandum) to S.J. Olinger, Office of River Protection, Richland, Washington, "Approval of the Mission Need Statement and Critical Decision – 0 for the Office of River Protection Interim Pretreatment System Project," December 21.

SAIC (Science Applications International Corporation), 2007a, *Tank Closure Alternatives, Scaled Data Sets to Support the "Tank Closure and Waste Management Environmental Impact Statement for the Hanford Site, Richland, Washington,"* Germantown, Maryland, July 12.

SAIC (Science Applications International Corporation), 2007b, *Fast Flux Test Facility Alternatives, Scaled Data Sets to Support the "Tank Closure and Waste Management Environmental Impact Statement for the Hanford Site, Richland, Washington,"* Germantown, Maryland, July 12.

SAIC (Science Applications International Corporation), 2007c, *Waste Management Alternatives, Scaled Data Sets to Support the "Tank Closure and Waste Management Environmental Impact Statement for the Hanford Site, Richland, Washington,"* Germantown, Maryland, July 12.

SAIC (Science Applications International Corporation), 2008, *Revised Scaled Data Sets to Support the "Tank Closure and Waste Management Environmental Impact Statement for the Hanford Site, Richland, Washington,"* Germantown, Maryland, October 9.

Sams, T.L., 2004, *Stage 1 Retrieval Data Report for Single-Shell Tank 241-C-106*, RPP-20110, Rev. 1, CH2M HILL Hanford Group, Inc., Richland, Washington, May.

Schofield, J.S., 2008, *High Resolution Resistivity Leak Detection Equipment Description*, RPP-32478, Rev. 1, Washington River Protection Solutions, LLC, Richland, Washington, October.

Skelly, W.A., 1998, *AX Tank Farm Ancillary Equipment Study*, HNF-3441, Rev. 0, COGEMA Engineering Corporation, Richland, Washington, September.

THOR and WGI (THOR Treatment Technologies, LLC, and Washington Group International), 2006, *Pilot Plant Report for Treating Sodium-Bearing Waste Surrogates Carbonate Flowsheet*, RT-ESTD-PMR-001, Rev. 0, Denver, Colorado, October.

USFWS (U.S. Fish and Wildlife Service), 2006, *Hanford Reach National Monument Draft Comprehensive Conservation Plan and Environmental Impact Statement*, Richland, Washington, November.

Wade, K., W. Hewitt, L. Holton, K. Gerdes, K. Juroff, J. Loving, and D. Wodrich, 2007, *Hanford River Protection Project Low Activity Waste Treatment: A Business Case Evaluation*, DOE/ORP-2007-03, Rev. 0A Draft, Office of Environmental Management and Office of River Protection, December.

Weidert, J.R., 2003, *Waste Management Project (WMP) Master Documented Safety Analysis (MDSA) for the Solid Waste Operations Complex (SWOC)*, HNF-14741, Rev. 1, Fluor Hanford, Inc., Richland, Washington, July.

WHC (Westinghouse Hanford Company), 1994, *Definitive Design Report, Project W-025 Radioactive Mixed Waste Land Disposal Facility Non-drag-off*, WHC-SD-W025-FDR-001, Rev. 1, Richland, Washington, November.

Wilson, R., 2003, Columbia Energy & Environmental Services, Inc., Richland, Washington, personal communication (email) to L.B. Gannon, Science Applications International Corporation, Germantown, Maryland, "Preliminary Alt. 2B Glass Production Quantities (RPP System Plan, Rev. 1 Draft Conditions)," June 4.

Wilson, R., 2004, Columbia Energy & Environmental Services, Inc., Richland, Washington, personal communication (email) to M. Burandt, U.S. Department of Energy, Office of River Protection, Richland, Washington, "Estimated IHLW Canister Reduction from 20 TRU Tanks," April 2.

Code of Federal Regulations

40 CFR 268, U.S. Environmental Protection Agency, "Land Disposal Restrictions."

40 CFR 268.6, U.S. Environmental Protection Agency, "Land Disposal Restrictions: Petitions to Allow Land Disposal of a Waste Prohibited Under Subpart C of Part 268."

40 CFR 1500–1508, Council on Environmental Quality, Regulations for Implementing the Procedural Provisions of the National Environmental Policy Act.

49 CFR 173, Pipeline and Hazardous Materials Safety Administration, U.S. Department of Transportation, "Shippers – General Requirements for Shipments and Packagings."

49 CFR 173.403, Pipeline and Hazardous Materials Safety Administration, U.S. Department of Transportation, "Shippers – General Requirements for Shipments and Packagings: Definitions."

Federal Register

62 FR 8693, U.S. Department of Energy, 1997, "Record of Decision for the *Tank Waste Remediation System, Hanford Site, Richland, WA*," February 26.

65 FR 10061, U. S. Department of Energy, 2000, "Record of Decision for the Department of Energy's Waste Management Program: Treatment and Disposal of Low-Level Waste and Mixed Low-Level Waste; Amendment of the Record of Decision for the Nevada Test Site," February 25.

66 FR 7877, U.S. Department of Energy, 2001, "Record of Decision for the *Programmatic Environmental Impact Statement for Accomplishing Expanded Civilian Nuclear Energy Research and Development and Isotope Production Missions in the United States, Including the Role of the Fast Flux Test Facility*," January 26.

69 FR 39449, U.S. Department of Energy, 2004, "Record of Decision for the *Solid Waste Program, Hanford Site, Richland, WA: Storage and Treatment of Low-Level Waste and Mixed Low-Level Waste; Disposal of Low-Level Waste and Mixed Low-Level Waste, and Storage, Processing, and Certification of Transuranic Waste for Shipment to the Waste Isolation Pilot Plant*," June 30.

69 FR 50176, U.S. Department of Energy, 2004, "Notice of Intent to Prepare an Environmental Impact Statement for the Decommissioning of the Fast Flux Test Facility at the Hanford Site, Richland, WA," August 13.

70 FR 75165, U.S. Department of Energy, 2005, "Office of Environmental Management; Record of Decision for the *Idaho High-Level Waste and Facilities Disposition Final Environmental Impact Statement*," December 19.

71 FR 5655, U.S. Department of Energy, 2006, “Notice of Intent to Prepare the *Tank Closure and Waste Management Environmental Impact Statement for the Hanford Site, Richland, WA*,” February 2.

United States Code

42 U.S.C. 2011 et seq., Atomic Energy Act of 1954.

U.S. Department of Energy Orders

DOE Order 435.1, *Radioactive Waste Management*, Change 1, August 28, 2001.

Washington Administrative Code

WAC 173-160, Washington State Department of Ecology, “Minimum Standards for Construction and Maintenance of Wells,” Olympia, Washington, February 2007.

WAC 173-303, Washington State Department of Ecology, “Dangerous Waste Regulations,” Olympia, Washington, March 2003.

APPENDIX F DIRECT AND INDIRECT IMPACTS: ASSESSMENT METHODOLOGY

This appendix briefly describes the methods used to assess the potential direct and indirect effects of the alternatives in this *Tank Closure and Waste Management Environmental Impact Statement for the Hanford Site, Richland, Washington*. Included in this appendix are discussions of general impact assessment methodologies for land resources, infrastructure, noise, air quality, geology and soils, water resources, ecological resources, cultural resources, public and occupational health and safety, transportation, socioeconomics, waste management, and environmental justice. Each section includes a description of the affected resources, region of influence, and impact assessment method. Detailed descriptions of the methods for evaluating impacts on air quality, groundwater, ecological risk, and cumulative impacts are presented in Appendices G, O, P, and R, respectively. Descriptions of the methods for evaluating the human health effects (1) of intra- and intersite transportation, (2) related to environmental justice concerns, and (3) of normal operations and facility accidents are presented in Appendices H, J, and K, respectively.

Methods for assessing environmental impacts vary for each resource area. As presented in Appendix G, “Air Quality Analysis,” for example, pollutant emissions from tank waste retrieval, treatment, and disposal and tank closure activities were evaluated to determine their effect on ambient concentrations and their compliance with ambient air quality standards. Comparison with regulatory standards is a commonly used method for benchmarking environmental impacts, and appropriate comparisons were made in a number of resource analyses to provide perspective on the magnitude of identified impacts. For waste management, waste generation rates were compared with the capacities or expected capacities of waste management facilities. Impacts in all resource areas were estimated using a consistent set of input variables and computations. The impacts of the two options under the Fast Flux Test Facility Decommissioning alternatives at the Idaho facility are addressed in the affected resource areas. Moreover, efforts were made to ensure that calculations in all areas used accepted protocols and up-to-date models.

F.1 LAND RESOURCES

F.1.1 Land Use

F.1.1.1 Description of Affected Resources

Land use is defined as the way land is developed and used in terms of the kinds of anthropogenic activities that occur (such as agriculture, residential areas, industrial areas) (EPA 2006). Analysis of land use includes the land on and adjacent to the Hanford Site (Hanford), the physical features that influence current or proposed uses, pertinent land use plans and regulations, and land ownership and availability. The region of influence (ROI) for land use impact assessment encompasses Hanford, including the 200 Areas, 400 Area, and Borrow Area C, as well as areas immediately surrounding the site.

F.1.1.2 Description of Impact Assessment

The amount of land disturbed and the conformity of disturbance with existing land use designations were considered in evaluating potential impacts (see Table F-1). The analysis focused on the net land area affected, its relationship to conforming and nonconforming land uses, current land use designations, and other factors pertaining to land use. Total land area requirements considered include those areas to be occupied by the required footprint of new facilities in conjunction with any additional parking, construction laydown areas, or supporting roadways. The land use assessment methodology and analysis are discussed further in Chapter 3, Section 3.2.1.1.

Table F-1. Land Use and Visual Resources Impact Assessment Protocol

| Resource | Required Data | | Measure of Impact |
|------------------|--|--|--|
| | Affected Environment | Alternative | |
| Land use | Acreage of affected areas. | Facility acreage requirements. | Area converted to project use. |
| | Existing land use designations | Location of facilities on the site; expected modifications of site activities and uses to accommodate the alternatives | Incompatibility with existing or future land use |
| Visual resources | Current appearance of 200 Areas, 400 Area, and Borrow Area C and current visual resource management classification | Location of facilities on the site; facility dimensions and appearance | Change in appearance of 200 Areas, 400 Area, and Borrow Area C and current visual resource management classification |

F.1.2 Visual Resources

F.1.2.1 Description of Affected Resources

Visual resources are the natural and manmade features that give a particular landscape its character and aesthetic quality. Landscape character is determined by the visual elements of form, line, color, and texture. All four elements are present in every landscape; however, they exert varying degrees of influence. The stronger the influence exerted by these elements in a landscape, the more interesting the landscape. The ROI for visual resources includes the geographic area from which activities associated with the various alternatives may be seen by members of the public. This would generally include nearby higher elevations and public roadways.

F.1.2.2 Description of Impact Assessment

Visual resource assessments are based on a description of the viewshed and the U.S. Bureau of Land Management's visual resource management classification (BLM 1986). A qualitative visual resource analysis was conducted to determine whether disturbances associated with project activities would alter the visual environment. Classifications of visual contrast settings are provided in Table F-2. Classifications were derived from an inventory of scenic qualities, sensitivity levels, and distance zones for particular areas. For example, the classification of the 200-West Area from State Route 240 is Class IV.

Table F-2. U.S. Bureau of Land Management Visual Resources Classifications

| Classification | Visual Settings |
|----------------|--|
| Class I | Very limited management activity; natural ecological change. |
| Class II | Management activities may be seen, but should not attract the attention of the casual observer, such as solitary small buildings or dirt roads. |
| Class III | Management activities may attract attention, but should not dominate the view of the casual observer; the natural landscape still dominates buildings, utility lines, and secondary roads. |
| Class IV | Management activities may dominate the view and major focus of viewer attention, such as clusters of two-story buildings, large industrial/office complexes, primary roads, and limited clearcutting for utility lines or ground disturbances. |

Source: BLM 1986:6, 7.

The visual resource analysis focused on the degree of contrast between the proposed actions and the surrounding landscape, the location and sensitivity levels of public vantage points, and the visibility of the proposed actions from the vantage points. The distance from a vantage point to the affected area was also considered, as distance can diminish the degree of contrast and visibility. A qualitative assessment of the degree of contrast between proposed facility construction and operations and the existing visual landscape is presented, as applicable.

Thus, to determine the range of the potential visual effects of new facilities, the analysis considered the potential impacts of construction and operations in light of the aesthetic quality of surrounding areas, as well as the visibility of proposed activities and facilities from public vantage points. The visual resource assessment methodology and analysis are discussed further in Chapter 3, Section 3.2.1.2.

F.2 INFRASTRUCTURE

F.2.1 Description of Affected Resources

Site infrastructure includes the physical resources that compose the ground transportation and utility systems required to support the construction, operations, and deactivation of facilities associated with the various alternatives and options under consideration in this **Tank Closure and Waste Management Environmental Impact Statement for the Hanford Site, Richland, Washington (TC & WM EIS)**. It also includes the capacities of the (1) onsite road networks; (2) electric power transmission and distribution system; (3) natural gas and liquid fuel (i.e., fuel oil, diesel fuel, and gasoline) storage and conveyance systems; and (4) water supply system.

The ROI is generally limited to the boundaries of the site. However, should infrastructure requirements exceed site capacities, the ROI would be expanded (for analysis) to include the sources of additional supply. For example, if electrical demand (with added facilities) exceeded site availability, then the ROI would be expanded to include the likely source of additional power (i.e., the electric power pool currently supplying the site).

F.2.2 Description of Impact Assessment

In general, utility infrastructure impacts were assessed by evaluating the requirements of each alternative, including associated activities and facility demands against site capacities. Impacts were assessed for each utility infrastructure resource (electricity, fuel, and water) for the various alternatives (see Table F-3). Tables reflecting site availability and infrastructure requirements were developed for each alternative. Data for these tables were obtained from documentation¹ describing the existing infrastructure at the facility site locations and from data reports prepared to support this environmental impact statement (EIS) with regard to proposed tank closure, Fast Flux Test Facility decommissioning, and waste management activities (SAIC 2007a, 2007b, 2007c).

Any projected demand for infrastructure resources exceeding site availability can be regarded as an indicator of impact. Whenever projected demand approaches or exceeds capacity, further analysis of that resource is warranted. Often, design changes can mitigate the impact of additional demand for a given resource. For example, substituting fuel oil for natural gas (or vice versa) for heating or industrial processes can be accomplished at little cost during the design of a facility provided the potential for impact is identified early. Similarly, a dramatic “spike” in peak demand for electricity can sometimes be mitigated by changes to operational procedures or parameters.

¹ For applicable source data, see the documentation referenced in Chapter 3, Sections 3.2.2 and 3.3.2, of this TC & WM EIS.

Table F-3. Infrastructure Impact Assessment Protocol

| Resource | Required Data | | Measure of Impact |
|---|---|------------------------------------|--|
| | Affected Environment | Alternative | |
| Electricity (energy consumption) | Site/facility area capacity and current usage | Activity and facility requirements | Additional requirement (with added facilities) exceeding facility area/site capacity |
| Fuel (natural gas, gasoline, diesel fuel ^a) | | | |
| Water | | | |

^a Includes No. 2 diesel fuel (road diesel) and heating fuel oil.

Although part of the physical infrastructure, incremental demands for ground transportation infrastructure (e.g., new roadways to support project activities) were not separately quantified, but were assessed as part of the land use impacts analysis (see Section F.1.1.2). Note that the methodology for assessing local roadway traffic impacts, which are related to projected changes in facility site employment and local population, is described in Section F.11.2. The infrastructure assessment methodology and analysis are discussed further in Chapter 3, Section 3.2.2.

F.3 NOISE AND VIBRATION

F.3.1 Description of Affected Resources

Noise, or sound, results from the compression and expansion of air or some other medium when an impulse is transmitted through it. Sound requires a source of energy and a medium for transmitting the sound wave. Propagation of sound is affected by various factors, including meteorology, topography, and barriers. Noise is undesirable sound that interferes or interacts negatively with the human or natural environment. Noise may disrupt normal activities (e.g., hearing, sleep), damage hearing, or diminish the quality of the environment.

Noise-level measurements used to evaluate the effects of nonimpulsive sound on humans are compensated by an A-weighting scale that accounts for the hearing response characteristics (i.e., frequency) of the human ear. Noise levels are expressed in decibels (dB), or in the case of A-weighted measurements, decibels A-weighted (dBA). The U.S. Environmental Protection Agency (EPA) has developed noise-level guidelines for different land use classifications (EPA 1974). The EPA guidelines identify a 24-hour average exposure level (energy-equivalent sound level) of no more than 70 dBA of intermittent environmental noise to prevent hearing loss. Likewise, day-night average levels of 55 dBA outdoors and 45 dBA indoors are identified as the limits to prevent activity interference and annoyance. The State of Washington has adopted noise level standards for combinations of source classifications and receiving property classifications. The Washington State standard maximum noise-level limit is 60 dBA for industrial areas impacting a residential area and 50 dBA at night (WAC 173-60). Except for prohibition of nuisance noise, neither the State of Idaho nor local governments have established regulations that specify acceptable community noise levels applicable to Idaho National Laboratory (INL).

Noise from facility construction or operations and associated traffic could affect human and animal populations. The ROI at Hanford includes the 200 Areas; 400 Area; borrow areas; and surrounding areas, including transportation corridors, where proposed activities might increase noise levels. At INL, the ROI includes the Materials and Fuels Complex and surrounding areas, including transportation corridors, where proposed activities might increase noise levels. Transportation corridors most likely to experience increased noise levels are those roads within a few miles of the site boundary that carry most of the site's employee and shipping traffic.

Noise-level data representative of site environs were obtained from existing reports (see Chapter 3, Sections 3.2.3 and 3.3.3). The acoustic environment was further described in terms of existing noise sources for the proposed locations and traffic noise levels along access routes.

F.3.2 Description of Impact Assessment

Noise impacts associated with the alternatives may result from construction, operations, deactivation, decontamination, and closure activities, including increased traffic (see Table F–4). Impacts of proposed activities under each alternative were assessed according to the types of noise sources and the facility site locations relative to the site boundary and noise-sensitive receptors. Potential traffic noise impacts were assessed based on the likely increase in traffic volume. The increase in employee and truck traffic from the discussion of local traffic (Chapter 4, Sections 4.1.9, 4.2.9, and 4.3.9) were compared to the existing average traffic volume (Chapter 3, Sections 3.2.9.4 and 3.3.9.4). For the purpose of comparison among the alternatives, the increase in traffic noise level in dBA can be estimated as 10 times the log of the ratio of the projected traffic volume to the existing traffic volume. Possible impacts on wildlife were evaluated based on the possibility of sudden loud noises occurring during site activities under each alternative.

Table F–4. Noise and Vibration Impact Assessment Protocol

| Resource | Required Data | | Measure of Impact |
|---------------------|--|--|--|
| | Affected Environment | Alternative | |
| Noise and vibration | Identification of sensitive offsite receptors (e.g., nearby residences, nearby threatened and endangered wildlife habitat); description of noise levels and noise and vibration sources in the site vicinity | Description of noise and vibration sources; shipment and workforce traffic estimates | Increase in day/night average sound level at sensitive receptors |

F.4 AIR QUALITY

F.4.1 Description of Affected Resources

Air pollution refers to the direct or indirect introduction of any substance into the air that could:

- Endanger human health
- Harm living resources and ecosystems
- Damage material property
- Impair or interfere with the comfortable enjoyment of life and other legitimate uses of the environment

For the purpose of this TC & WM EIS, only outdoor air pollutants were addressed. These may be in the form of solid particles, liquid droplets, gases, or a combination of these forms. Generally, they can be categorized as primary pollutants (those emitted directly from identifiable sources) and secondary pollutants (those produced in the air by interaction between two or more primary pollutants or by reaction with normal atmospheric constituents that may be influenced by sunlight). Air pollutants are transported, dispersed, or concentrated by meteorological and topographical conditions. Thus, air quality is affected by air pollutant emission characteristics, meteorology, and topography.

**Draft Tank Closure and Waste Management Environmental Impact Statement for the
Hanford Site, Richland, Washington**

Ambient air quality in a given location can be described by comparing the concentrations of various pollutants in the atmosphere with the appropriate standards. The ambient air quality standards established by Federal and state agencies allow an adequate margin of safety for the protection of public health and welfare from the adverse effects of pollutants in the ambient air. Pollutant concentrations higher than the corresponding standards are considered unhealthy; those below such standards are considered acceptable.

Pollutants of concern are primarily those for which Federal and state ambient air quality standards have been established, including criteria air pollutants, hazardous air pollutants, and other toxic air compounds. Criteria air pollutants are listed in “National Primary and Secondary Ambient Air Quality Standards” (40 CFR 50). Hazardous air pollutants and other toxic compounds are those listed in Title I of the Clean Air Act, as amended (40 U.S.C. 7401 et seq.); those regulated by the “National Emission Standards for Hazardous Air Pollutants” (40 CFR 61); and those that have been proposed or adopted for regulation by the applicable state or are listed in state guidelines. States may set ambient standards that are more stringent than the National Ambient Air Quality Standards (NAAQS). The more stringent of the Federal or state standards are used in this EIS.

Areas with air quality better than the NAAQS for criteria air pollutants are designated as “attainment,” while areas with air quality worse than the NAAQS for such pollutants are designated as “nonattainment.” Areas may be designated as “unclassified” when sufficient data for attainment-status designation are lacking. Attainment-status designations are assigned by county, metropolitan statistical area consolidated metropolitan statistical area, or portions thereof, or air quality control regions. Air quality control regions designated by EPA are listed in “Designation of Areas for Air Quality Planning Purposes” (40 CFR 81). The areas within Hanford and the surrounding counties are designated as attainment (40 CFR 81.348); the area within INL and the surrounding counties also are designated as attainment (40 CFR 81.313).

For locations within an attainment area for criteria air pollutants, Prevention of Significant Deterioration regulations limit pollutant emissions from new or modified sources and establish allowable increments of pollutant concentrations. Three Prevention of Significant Deterioration classifications are specified, using the criteria established in the Clean Air Act. Class I areas include national wilderness areas; memorial parks larger than 2,020 hectares (5,000 acres); national parks larger than 2,430 hectares (6,000 acres); and areas that have been redesignated as Class I. Class II areas include all areas not designated as Class I. No Class III areas have been designated (42 U.S.C. 7472 et seq.). The nearest Class I area to Hanford is about 145 kilometers (90 miles) to the west (see Chapter 3, Section 3.2.4.1, of this EIS). The nearest Class I area to INL is about 53 kilometers (33 miles) to the west-southwest (see Chapter 3, Section 3.3.4.1.2, of this EIS).

The ROI for air quality encompasses an area surrounding a site that is potentially affected by air pollutant emissions caused by implementation of the alternatives. The air quality impact area normally evaluated is the area in which concentrations of criteria pollutants would increase more than a significant amount in a Class II area (based on the averaging period and pollutant: 1 microgram per cubic meter for the annual average for sulfur dioxide, nitrogen dioxide, and particulate matter with an aerodynamic diameter less than or equal to 10 micrometers [PM_{10}]; 5 micrograms per cubic meter for the 24-hour average for sulfur dioxide and PM_{10} ; 500 micrograms per cubic meter for the 8-hour average for carbon monoxide; 25 micrograms per cubic meter for the 3-hour average for sulfur dioxide; and 2,000 micrograms for the 1-hour average for carbon monoxide (40 CFR 51.165). Generally, this ROI covers a few kilometers downwind from the source. Further, for sources within 100 kilometers (60 miles) of a Class I area, the air quality impact area evaluated would include the Class I area if the increase in concentration of any air pollutants for which there are Prevention of Significant Deterioration increments is greater than 1 microgram per cubic meter (24-hour average). The area of the ROI depends on emission source characteristics, pollutant types, emission rates, and meteorological and topographical conditions. For the purpose of this analysis, impacts at Hanford were evaluated at the Hanford Reach boundary and along State Route 240 within Hanford to which the public has access for averaging periods of 1 to 24 hours; at

the Hanford boundary for annual averaging periods; and at an additional area beyond these boundaries in which maximum contributions to pollutant concentrations were expected to be identified.

Impacts at INL were evaluated at the INL boundary and at roads within INL to which the public has access.

Baseline air quality is typically described in terms of pollutant concentrations modeled for existing sources at each site and background air pollutant concentrations measured near each site. For this analysis, emission data from existing sources at Hanford were obtained from the **Calendar Year 2005 Nonradioactive Inventory of Airborne Emissions Report** (Johnson 2006); concentrations from these data were modeled using the EPA-recommended AERMOD model (EPA 2004). Emissions data for INL were obtained from an emission inventory database for 2006 (Depperschmidt 2007).

F.4.2 Description of Impact Assessment

Potential air quality impacts of pollutant emissions from construction, normal operations, deactivation, decommissioning, and closure activities were evaluated for each alternative, as appropriate. This assessment included a comparison of pollutant concentrations under each alternative with applicable Federal and state ambient air quality standards (see Table F-5). If both Federal and state standards exist for a given pollutant and averaging period, compliance was evaluated using the more-stringent standard. Operational air pollutant emissions data for each alternative were based on conservative engineering analyses.

Table F-5. Air Quality Impact Assessment Protocol

| Resource | Required Data | | Measure of Impact |
|---|--|---|---|
| | Affected Environment | Alternative | |
| Criteria air pollutants and other regulated pollutants ^a | Measured and modeled ambient concentrations (micrograms per cubic meter) from existing sources at site | Emission rate (kilograms per year) of air pollutants from facility; source characteristics (stack height and diameter, exit temperature and velocity) | Alternative and total site concentrations of each pollutant at or beyond site boundary or within the boundary on a public road compared to applicable standard. |
| Toxic and hazardous air pollutants ^b | | | Alternative concentration of each pollutant at or beyond site boundary or within the boundary on a public road compared to the acceptable source impact level. Concentration for nearby noninvolved member was used to calculate Hazard Quotient or cancer risk. |

^a Carbon monoxide; hydrogen fluoride; lead; nitrogen oxides; ozone; particulate matter with an aerodynamic diameter less than or equal to 10 micrometers; particulate matter with an aerodynamic diameter less than or equal to 2.5 micrometers; sulfur dioxide; total suspended particulates, and volatile organic compounds.

^b Clean Air Act, Section 112, hazardous air pollutants: pollutants regulated under the National Emissions Standards for Hazardous Air Pollutants and other state-regulated pollutants.

For each alternative, as appropriate, contributions to offsite air pollutant concentrations were modeled on the basis of guidance presented in EPA’s “Guideline on Air Quality Models” (40 CFR 51, Appendix W). The EPA-recommended model AERMOD (EPA 2004) was selected as an appropriate model to use for air dispersion modeling for Hanford because it is designed to support the EPA regulatory modeling program

and predicts conservative impacts. For construction activities at INL, the EPA SCREEN 3 dispersion model was used to estimate contributions to offsite air pollutant concentrations.

The modeling analysis incorporated conservative assumptions that tend to overestimate pollutant concentrations. The maximum modeled concentration and averaging time for each pollutant were selected for comparison with the applicable standard. The concentrations evaluated were the maximum occurring at or beyond the site boundary and at a public access road or other publicly accessible area within the site. Concentrations of the criteria and toxic air pollutants were presented for each alternative. Five years of representative hourly meteorological data were used for Hanford.

Details of the air quality impact assessment methodology and analysis are discussed further in Appendix G.

F.5 GEOLOGY AND SOILS

F.5.1 Description of Affected Resources

Geologic resources encompass consolidated and unconsolidated earth materials, including rock and mineral assets such as ore and aggregate materials (e.g., sand, gravel) and fossil fuels such as coal, oil, and natural gas. Geologic conditions include hazards such as earthquakes, faults, volcanoes, landslides, sinkholes, and other conditions leading to land subsidence and unstable soils. Soil resources include the loose surface materials of the earth in which plants grow, usually consisting of mineral particles from disintegrating rock, organic matter, and soluble salts. Certain soils are important farmlands that are designated as such by the U.S. Department of Agriculture Natural Resources Conservation Service. Important farmlands include prime farmland, unique farmland, and other farmland of statewide or local importance, as defined in 7 CFR 657.5, that may be subject to the Farmland Protection Policy Act (7 U.S.C. 4201 et seq.).

Geology and soils were considered with respect to those attributes and geologic and soil resources that could be affected by the alternatives, as well as those geologic conditions that could affect each alternative and associated facilities. The ROI for geology and soils includes the Hanford and INL affected facility areas and nearby offsite areas that are subject to disturbance due to facility construction, decontamination and decommissioning (D&D), and tank closure activities, as well as those areas beneath existing or new facilities that would remain inaccessible for the life of the facilities. Conditions that could affect the integrity and safety of existing or proposed new facilities over the timeframe associated with each alternative include large-scale geologic hazards (e.g., earthquakes, volcanic activity, landslides, and land subsidence) and local hazards associated with the site-specific attributes of the soil and bedrock beneath site facilities. Thus, the area within which these geologic conditions exist is also used to define the ROI for this resource area.

F.5.2 Description of Impact Assessment

Construction, operations, deactivation, closure, and D&D activities under each of the alternatives were considered from the perspective of direct impacts on specific geologic resources and soil attributes, to encompass the consumption of geologic resources. Facility construction, D&D, and tank closure activities were the focus of the impact assessment for geologic and soil resources; hence, the key factors in the analysis were the (1) land area to be disturbed and geologic resources consumed to support the alternatives considered; (2) depth and extent of excavation work to support facility construction, facility D&D, and closure activities; (3) land areas occupied during operations; and (4) identification of unstable geologic strata (such as soils or sediments prone to subsidence, liquefaction, shrink-swell, or erosion) (see Table F-6).

Table F–6. Geology and Soils Impact Assessment Protocol

| Resource | Required Data | | Measure of Impact |
|------------------------------|--|---|---|
| | Affected Environment | Alternative | |
| Geologic hazards | Presence of geologic hazards within the region of influence | Location of facilities | Potential for damage to facilities |
| Mineral and energy resources | Presence of any rare and/or valuable mineral or energy resources on the site and availability of geologic resources within the region of influence | Location of facilities and project activity demands | Potential to consume, destroy, or render resources inaccessible |
| Important farmland soils | Presence of prime or other important farmland soils near the facility site locations | Location of facilities | Conversion of important farmland soils to nonagricultural use |

The geology and soils impact analysis also considered risks to facilities (existing, new, or modified) from large-scale geologic hazards such as faulting and earthquakes, lava extrusions and other volcanic activity, landslides, and sinkholes (i.e., conditions that tend to affect broad expanses of land). In general, the facility hazard assessment was based on the presence of any identified hazard and the distance of the facilities from it. This element of the assessment includes collection of site-specific information regarding the potential for impacts on site facilities from local and large-scale geologic conditions. Historical seismicity within a given radius of Hanford and INL was reviewed, and potential earthquake source areas were identified as a means of assessing the potential for future earthquake activity. Earthquakes are described in this **TC & WM EIS** in terms of classification scheme and parameters, as presented in Table F–7. Probabilistic earthquake ground-motion data that include peak (horizontal) ground acceleration and response spectral acceleration were evaluated for select facility areas to provide a comparative assessment of seismic hazard. Estimates of probabilistic ground motion at a particular location consider earthquake-shaking at all future possible earthquake magnitudes and at all possible distances from the location (USGS 2008a). Peak ground acceleration indicates what an object on the ground would experience during an earthquake and approximates what a short structure would be subjected to in terms of horizontal force. It does not account for the range of energies experienced by a building during an earthquake, particularly taller buildings. Measures of spectral acceleration account for the natural period of vibration of structures (short buildings have short natural vibration periods [up to 0.6 seconds], and taller buildings have longer vibration periods [0.7 seconds or longer]) (USGS 2008b). Both parameters are used by the U.S. Geological Survey (USGS) National Seismic Mapping Project. The USGS’s latest National Earthquake Hazards Reduction Program (NEHRP) maps are based on spectral acceleration and depict maximum considered earthquake ground motions of 0.2- and 1.0-second spectral accelerations based on a 2 percent probability of exceedance in 50 years (i.e., corresponding to an annual probability of occurrence of about 1 in 2,500). The NEHRP maps have been adapted for use in the seismic design portions of the **International Building Code** (USGS 2007).

The NEHRP maps were developed based on the recommendations of the Building Seismic Safety Council’s Seismic Design Procedures Group (BSSC 2004a, 2004b). The Seismic Design Procedures Group-recommended maximum considered earthquake ground-motion maps are derived from the USGS probabilistic hazard maps with additional modifications that incorporate deterministic ground motions in selected areas and the application of engineering judgment (USGS 2007). Note that the maximum considered earthquake maps are based on a reference site condition (firm rock) and are suitable for determining estimates of maximum considered earthquake ground shaking for design purposes at most sites. For sites with nonreference conditions and for design of buildings requiring a higher degree of seismic safety, site-specific design procedures must be used (BSSC 2004b:17, 18).

**Draft Tank Closure and Waste Management Environmental Impact Statement for the
Hanford Site, Richland, Washington**

**Table F-7. The Modified Mercalli Intensity Scale of 1931, with Generalized Correlations to
Magnitude, Earthquake Classification, and Peak Ground Acceleration**

| Modified Mercalli Intensity^a | Observed Effects of Earthquake^a | Approximate Magnitude^b | Class | Peak Ground Acceleration^c (g) |
|--|---|--|--------------|---|
| I | Usually not felt except by a very few persons under very favorable conditions. | Less than 3 | Micro | Less than 0.0017 |
| II | Felt by only a few persons at rest, especially on the upper floors of buildings. | 3 to 3.9 | Minor | 0.0017 to 0.014 |
| III | Felt quite noticeably by persons indoors, especially on upper floors of buildings. Many people do not recognize it as an earthquake. Standing motorcars may rock slightly. Vibrations similar to the passing of a truck. | | | |
| IV | Felt indoors by many; outdoors by few during the day. At night, some awakened. Dishes, windows, doors disturbed; walls make cracking sounds. Sensation like heavy object striking building. Standing motorcars rock noticeably. | 4 to 4.9 | Light | 0.014 to 0.039 |
| V | Felt by nearly everyone; many awakened. Some dishes and windows broken. Unstable objects overturned. Pendulum clocks may stop. | | | 0.039 to 0.092 |
| VI | Felt by all; many frightened. Some heavy furniture moved; a few instances of fallen plaster. Damage slight. | 5 to 5.9 | Moderate | 0.092 to 0.18 |
| VII | Damage negligible in buildings of good design and construction; slight to moderate in well-built ordinary structures; considerable damage in poorly built or badly designed structures; some chimneys broken. | 6 to 6.9 | Strong | 0.18 to 0.34 |
| VIII | Damage slight in specially designed structures; considerable damage in ordinary substantial buildings, with partial collapse. Damage great in poorly built structures. Falling chimneys, factory stacks, columns, monuments, walls. Heavy furniture overturned. | 7 to 7.9 | Major | 0.34 to 0.65 |
| IX | Damage considerable in specially designed structures; well-designed frame structures thrown out of plumb. Damage great in substantial buildings, with partial collapse. Buildings shifted off foundations. | | | 0.65 to 1.24 |
| X | Some well-built wooden structures destroyed; most masonry and frame structures destroyed with foundations. Rails bent. | | | 8 and higher |
| XI | Few, if any (masonry) structures remain standing. Bridges destroyed. Rails bent greatly. | | | |
| XII | Damage total. Lines of sight and level are distorted. Objects thrown into the air. | | | |

^a Intensity is a unitless expression of observed effects of earthquake-produced ground shaking. Effects may vary greatly between locations based on earthquake magnitude, distance from the earthquake, and local subsurface geology. The descriptions given are abbreviated from the Modified Mercalli Intensity Scale of 1931.

^b Magnitude is a logarithmic measure of the strength (size) of an earthquake related to the strain energy released by it. There are several magnitude “scales” (mathematical formulas) in common use, including local “Richter” magnitude, body-wave magnitude, and surface-wave magnitude. Each has applicability for measuring particular aspects of seismic signals and may be considered equivalent within each scale’s respective range of validity. For very large earthquakes, the moment magnitude scale provides the best overall measurement of earthquake size.

^c Acceleration is expressed as a factor that should be multiplied by Earth’s gravitational acceleration (g) (i.e., g is equal to 980 centimeters [386 inches] per second squared). Given values are correlated to Modified Mercalli Intensity based on measurements of California earthquakes (Wald et al. 1999). Site-specific earthquake history, ground motion, and risk assessment data for Hanford and INL are presented in Chapter 3, Sections 3.2.5.1.4 and 3.3.5.1.4, respectively.

Source: Compiled from USGS 2008c, 2008d; Wald et al. 1999.

The U.S. Department of Energy (DOE) specifically requires (DOE Order 420.1B) nuclear and nonnuclear facilities to be designed, constructed, and operated so that the public, workers, and environment are protected from the adverse impacts of natural phenomena hazards, including earthquakes. The order stipulates natural phenomena hazards mitigation requirements for DOE facilities and specifically provides for reevaluation and upgrade of existing DOE facilities when there is a significant degradation in the

safety basis for the facility. DOE Standards 1020-2002 and 1023-95 implement DOE Order 420.1B and provide criteria for design of new structures, systems, and components, as well as for evaluation, modification, or upgrade of existing structures, systems, and components, so that DOE facilities can safely withstand the effects of natural phenomena hazards such as earthquakes. The criteria specifically reflect adoption of the seismic design and construction provisions and associated seismic hazard maps of the International Building Code as the minimum standard for design and evaluation of DOE facilities (i.e., for Performance Category 1 and 2 structures, systems, and components). For structures, systems, and components requiring a higher level of performance from a safety perspective (i.e., Performance Category 3 and 4), a more-rigorous design analysis is required, including performance of a probabilistic seismic hazard assessment to determine the design-basis earthquake.

An evaluation was also performed to determine whether estimated requirements for rock, aggregate, soil, and products derived from rock and mineral resources used to support tank waste retrieval, treatment, and disposal; tank closure; and related D&D activities under each of the alternatives could exceed available resource reserves or stockpiles in the ROI. For example, this analysis included provision of borrow materials from onsite quarries and borrow pits to support construction of surface barriers for landfill closure of tank farms and waste disposal sites and to provide backfill for clean closure of tank farms under select alternatives. This was accomplished by comparing projections of resource demands for construction, operations, deactivation, closure, and D&D with resource availability analyses for the site and the region. In addition, the analysis of impacts on geologic resources included a determination of whether the proposed activities at a specific site could destroy or preclude the use of valuable rock, mineral, or energy resources.

Pursuant to the Farmland Protection Policy Act of 1981 (7 U.S.C. 4201 et seq.) and its implementing regulations, the presence of important farmland soils, including prime farmland, was also evaluated. This act requires agencies to make Farmland Protection Policy Act evaluations part of the National Environmental Policy Act process to reduce the conversion of farmland to nonagricultural uses by Federal projects and programs. However, otherwise qualifying farmlands in or already committed to urban development; land acquired for a project on or prior to August 4, 1984; and lands acquired or used by a Federal agency for national defense purposes are exempt from the act's provisions (7 CFR 658.3 and 658.7).

F.6 WATER RESOURCES

F.6.1 Description of Affected Resources

Water resources are the surface and subsurface waters that are suitable for human consumption, aquatic or wildlife use, agricultural purposes, irrigation, recreation, or industrial/commercial purposes. The ROI used for water resources encompasses those surface-water and groundwater systems at Hanford and INL that could be impacted by water withdrawals, effluent discharges, and spills or stormwater runoff associated with facility construction, operations, deactivation, closure, and related D&D activities under the alternatives. As such, the assessment methodologies described in the following subsections relate to the analysis of the proposed activities under the various alternatives and options that would generally result in short-term impacts (i.e., impacts limited to the timeframe during which the activity would be performed). The impact methodologies employed to assess the potential for long-term impacts on surface-water and groundwater resources from past releases to the vadose zone and groundwater at Hanford, as well as from waste retrieval and disposal and tank closure, in particular, are described in Appendices M, N, and O.

F.6.2 Description of Impact Assessment

Analysis of the potential impacts on water resources consisted of comparing project activity data and best available engineering-basis estimates regarding water use and effluent discharges with applicable regulatory standards, design parameters and standards commonly used in the water and wastewater engineering fields, and recognized measures of environmental impact. Certain assumptions were made to facilitate the impacts assessment: (1) all water supply production and treatment and Effluent Treatment Facilities would be available and upgraded as necessary in accordance with the timeframe considered under each alternative; (2) the Effluent Treatment Facilities would meet the effluent limitations imposed by the respective National Pollutant Discharge Elimination System permits and/or the state-issued discharge permit; and (3) any stormwater runoff from construction and operations activities would be handled in accordance with the regulations of the appropriate permitting authority. It was also assumed that, during construction and other land-disturbing activities, sediment fencing or other erosion-control devices would be used to mitigate short-term adverse impacts of sedimentation and as appropriate, stormwater holding ponds would be constructed to lessen the impacts of runoff on surface-water quality.

F.6.2.1 Water Use and Availability

Impacts on water use and availability were generally assessed by determining changes in the volume of current water usage and effluent discharges as a result of the proposed activities (see Table F-8). Where project activities were assumed to use surface water, no credit was taken for effluent discharges back to surface waters.

Table F-8. Water Use and Availability Impact Assessment Protocol

| Resource | Required Data | | Measure of Impact |
|----------------------------|--|---|---|
| | Affected Environment | Alternative | |
| Surface-water availability | Surface waters near the facilities, including average flow, low flow, and current usage | Volume of withdrawals from, and discharges to, surface waters | Changes in availability to local/downstream users of water for human consumption, irrigation, or animal feeding |
| Groundwater availability | Groundwater near the facilities, including existing water rights for major water users and current usage | Volume of withdrawals from, and discharges to, groundwater | Changes in availability of groundwater for human consumption, irrigation, or animal feeding |

F.6.2.2 Water Quality

The water quality impact assessment for this TC & WM EIS analyzed how routine effluent discharges and nonroutine releases (e.g., spills, containment failure) to surface water, as well as discharges reaching groundwater, from new facilities required under each alternative could potentially affect current water quality over the short term. The impacts of the alternatives were assessed as summarized in Table F-9, including a comparison of the projected effluent quality with relevant regulatory standards and implementing regulations such as the Clean Water Act (33 U.S.C. 1251 et seq.), Safe Drinking Water Act (42 U.S.C. 300(f) et seq.), state laws, and existing site permit conditions. The impact analyses evaluated the potential for contaminants to affect receiving water quality as a result of spills and other releases under the alternatives. Separate analyses were conducted for surface-water (see Chapter 3, Section 3.2.6) and groundwater (see Appendices M, N, and O) impacts.

Table F-9. Water Quality Impact Assessment Protocol

| Resource | Required Data | | Measure of Impact |
|-----------------------|--|---|--|
| | Affected Environment | Alternative | |
| Surface-water quality | Surface waters near the facility locations in terms of stream classifications and changes in water quality | Expected contaminants and contaminant concentrations in discharges to surface waters | Exceedance of relevant surface-water quality criteria or standards under the Clean Water Act or state regulations and existing permits |
| Groundwater quality | Groundwater near the facility locations in terms of classification, presence of designated sole-source aquifers, and changes in quality of groundwater | Expected contaminants and contaminant concentrations in discharges that could reach groundwater | Contaminant concentrations in groundwater exceeding relevant standards or criteria established in accordance with the Safe Drinking Water Act or state regulations and/or existing permits |

F.6.2.2.1 Surface-Water Quality

The evaluation of surface-water-quality impacts focused on the quality and quantity of any effluents (including stormwater) discharged as a result of new facility construction, operations, facility D&D, and tank closure activities, as well as other releases, and the quality of the receiving stream up- and downstream from the discharges. The evaluation of effluent quality featured a review of the expected parameters, such as the expected average and maximum flows and the nature of, and parameter concentrations in, expected effluents. Parameters of concern included total suspended solids, heavy metals, radionuclides, organic and inorganic chemicals, and any other constituents that could affect the local environment. Factors that currently degrade water quality were also identified.

Facility construction activities would have no direct impact on surface-water features because there are no natural, perennial surface-water drainages on the Central Plateau of Hanford or within the Materials and Fuels Complex at INL. Several manmade ponds or impoundments do occur in the 200 Areas, including the two Treated Effluent Disposal Facility’s disposal ponds and the three Liquid Effluent Retention Facility’s impoundments adjacent to the 200-East Area that would indirectly support project activities. During facility construction, D&D, and construction activities that would result in ground disturbance, surface waters could be affected by site runoff and silting. Such impacts relate to the amount of land disturbed, type of soil at the site, topography, and weather conditions. Adherence to best management practices for stormwater and erosion control (e.g., sediment fences, covering disturbed areas) would minimize the impacts.

During operations, surface waters could be affected by increased runoff from impervious surfaces (e.g., buildings) or cleared areas. Stormwater from these areas could be contaminated with materials deposited by airborne pollutants, automobile exhaust and residues, materials-handling releases (such as spills), and process effluents. Impacts of stormwater discharges could be highly variable and site-specific, and mitigation would depend on management practices, the design of holding facilities (if any), the topography, and adjacent land use. Data from existing water-quality data sources were compared with expected discharges from the facilities to determine the potential for, and identify the relative impacts on, surface waters.

F.6.2.2.2 Groundwater Quality

Potential short-term groundwater quality impacts associated with effluent discharges and other contaminant releases associated with new facility construction, operations, D&D, and tank closure were examined. Available engineering estimates of contaminant concentrations were weighed against applicable Federal and state groundwater quality standards, effluent limitations, and drinking-water standards to determine the impacts of each alternative. In addition, the consequences of groundwater use, including dewatering, and effluent discharges on other site groundwater conditions were evaluated. The methods employed to evaluate long-term surface-water and groundwater impacts are presented in Appendices M, N, and O.

F.6.2.3 Waterways and Floodplains

The locations of waterways (e.g., ponds, lakes, streams) and delineated floodplains or zones were identified from maps and other existing documents to assess the potential for impacts resulting from proposed new facility construction and facility modification and operations, including direct effects on hydrologic characteristics. No construction or other activities within the 200 Areas or 400 Area at Hanford would occur within a floodplain. Although the southwest corner of the 200-West Area and Borrow Area C are within the probable maximum flood area of Cold Creek, no new permanent facilities would be constructed in this area under any alternative, ensuring compliance with Executive Order 11988, **Floodplain Management**. No construction or operations activities proposed within the Materials and Fuels Complex at INL would be located in a floodplain. Therefore, preparation of a floodplain assessment is not required, pursuant to 10 CFR 1022.

F.7 ECOLOGICAL RESOURCES

F.7.1 Description of Affected Resources

Ecological resources include terrestrial and aquatic resources (plants and animals), threatened and endangered species, and wetlands that could be affected by the alternatives. The ROI evaluated for ecological impacts encompassed those areas within the 200 Areas, 400 Area, and Borrow Area C potentially disturbed by facility construction, operations, deactivation, and closure. To determine whether important ecological resources were present, surveys of Hanford facility locations were conducted (Sackschewsky 2003a, 2003b; Sackschewsky and Downs 2007).

Terrestrial resources are defined as those plant and animal species and communities that are most closely associated with the land; for aquatic resources, a water environment. Wetlands are defined by the U.S. Army Corps of Engineers and EPA as “those areas that are inundated or saturated by surface or groundwater at a frequency and duration sufficient to support, and that under normal circumstances do support, a prevalence of vegetation typically adapted for life in saturated soil conditions. Wetlands generally include swamps, marshes, bogs, and similar areas” (33 CFR 328.3).

Endangered species are defined under the Endangered Species Act of 1973 (16 U.S.C. 1531 et seq.) as those in danger of extinction throughout all or a large portion of their range. Threatened species are defined as those species likely to become endangered within the foreseeable future. The U.S. Fish and Wildlife Service and the National Oceanic and Atmospheric Administration propose the addition of species to the lists of threatened and endangered species. They also maintain a list of “candidate” species for which they have evidence that listing may be warranted, but for which listing is currently precluded by the need to list species more in need of Endangered Species Act protection. Candidate species do not receive legal protection under the Endangered Species Act, but should be considered in project planning in case they are listed in the future. Critical habitat for threatened and endangered species is designated by the U.S. Fish and Wildlife Service or the National Marine Fisheries Service. Critical habitat is defined

as a specific area that contains physical and biological features essential to the conservation of species and that may require special management consideration or protection. Washington and Idaho designate species as endangered or threatened, as well as a number of other special status designations.

F.7.2 Description of Impact Assessment

Impacts on ecological resources may occur as a result of land disturbance, water use, human activity, and noise from construction, operation, and deactivation of facilities associated with the various alternatives (see Table F–10). Night lighting may also impact site ecology. Each of these factors was considered when evaluating the potential impacts of the proposed activities. Terrestrial resources could be directly affected through destruction or modification of habitat. Likely impacts include increased direct mortality and susceptibility to predation. Activities associated with each alternative (e.g., human intrusion and noise) could also cause wildlife to move to adjacent areas with similar habitat. If the receiving areas were already supporting the maximum sustainable number of individuals, competition for limited resources and habitat degradation could result in the loss of some individuals. Therefore, analysis of impacts on terrestrial wildlife was based largely on the extent of plant community loss or modification. Indirect impacts of factors such as human disturbance, noise, and night lighting were evaluated qualitatively.

Table F–10. Ecological Resources Impact Assessment Protocol

| Resource | Required Data | | Measure of Impact |
|-----------------------------------|--|--|--|
| | Affected Environment | Alternative | |
| Terrestrial resources | Terrestrial vegetation and wildlife within the vicinity of facilities | Area disturbed by facility site activities, air emissions, wastewater discharges, and noise | Loss of, or disturbance to, species and their habitat; emissions and noise values above levels shown to cause impacts on terrestrial resources |
| Aquatic resources | Aquatic resources within the vicinity of facilities | Facility area air emissions, water source and quantity, and wastewater discharge locations and quantities | Discharges above levels shown to cause impacts on aquatic resources |
| Wetlands | Wetlands within the vicinity of facilities | Area disturbed by facility site activities, air emissions, and wastewater discharge locations and quantities | Loss or disturbance to wetlands |
| Threatened and endangered species | Threatened and endangered species, as well as their habitat, within the vicinity of facilities | Area disturbed by facility site activities, air emissions, noise, water sources and quantities, and wastewater discharge, locations and quantities | Similar to measures used in evaluating other terrestrial and aquatic resources and habitats |

Impacts on ecological resources may also occur as a result of exposure to radionuclide and chemical air emissions and groundwater contamination under all alternatives. Appendix P describes impact assessment methods and summarizes the results of the assessment of impacts on ecological resources at both on and offsite locations. Potential impacts are assessed by comparing predicted exposure concentrations and doses to published effects-based threshold concentrations and doses. Exposures above effects-based thresholds could potentially cause reduced fertility or increased mortality in exposed populations.

Project activity impacts on threatened and endangered species, as well as other special status species, and their habitats were determined in a manner similar to that used to evaluate impacts on other terrestrial and

aquatic resources and habitats. A list of sensitive species that could be present at each site was compiled. Informal consultations were initiated with the appropriate U.S. Fish and Wildlife Service offices and state-equivalent agencies as part of the impact assessment for sensitive species (see Appendix C).

F.8 CULTURAL RESOURCES

F.8.1 Description of Affected Resources

Cultural resources are indications of human occupation and use of property as defined and protected by a series of Federal laws, regulations, and guidelines. For this TC & WM EIS, potential impacts were assessed separately for each of the cultural resource categories: prehistoric resources, historic resources, and American Indian interests. Paleontological resources are the physical remains, impressions, or traces of plants or animals from a former geologic age and may be sources of information on ancient environments and the evolutionary development of plants and animals. Although not governed by the same historic preservation laws as cultural resources, they could be affected by the proposed actions in much the same manner.

Prehistoric resources are the physical remains of human activities that predate written records. They generally consist of artifacts that may either alone or collectively yield information about the past. Historic resources consist of physical remains that postdate the emergence of written records. In the United States, they are architectural structures or districts, archaeological objects, and archaeological features dating from 1492 and later. Ordinarily, sites less than 50 years old are not considered historic, but exceptions are made for properties of particular importance such as structures associated with World War II or Cold War themes. American Indian interests include sites, areas, and materials considered important to American Indians for religious or heritage reasons. Such interests may include geographic features, plants, animals, cemeteries, battlefields, trails, and environmental features. The ROI for cultural resource analysis encompasses Hanford, including the 200 Areas, 400 Area and Borrow Area C, as well as areas immediately surrounding the site that would potentially be disturbed by facility construction and other activities and occupied during the operations of facilities for tank waste retrieval, treatment, and disposal and/or tank closure.

F.8.2 Description of Impact Assessment

The analysis of impacts on cultural resources addressed potential direct and indirect impacts at each facility site location (see Table F-11). To determine whether cultural resources were present, a number of surveys were conducted of facility locations within and adjacent to the 200 Areas, 400 Area, and Borrow Area C (Chatters and Cadoret 1990; Duncan 2007; PNNL 2007; Prendergast-Kennedy 2003).

Potential indirect impacts include those associated with reduced access to a resource site, as well as those associated with increased traffic and visitation to sensitive areas. Direct impacts include those resulting from facilities for tank waste management. Consultations to comply with Section 106 of the National Historic Preservation Act (16 U.S.C. 470 et seq.) were conducted with the State Historic Preservation Officer. Correspondence offering consultation was sent to local American Indian tribes (see Appendix C). The cultural resources assessment methodology and analysis are discussed further in Chapter 3, Section 3.2.8.

Table F–11. Cultural Resources Impact Assessment Protocol

| Resource | Required Data | | Measure of Impact |
|------------------------------------|--|--|--|
| | Affected Environment | Alternative | |
| Prehistoric and historic interests | Prehistoric and historic interests within the vicinity of facilities | Location of facilities on the site and facility acreage requirements | Potential for loss, isolation, or alteration of the character of prehistoric and historic resources; introduction of visual, audible, or atmospheric elements that are out of character; neglect of resources listed, or eligible for listing, on the National Register of Historic Places |
| American Indian interests | American Indian interests within the vicinity of facilities | | Potential for loss, isolation, or alteration of the character of American Indian interests; introduction of visual, audible, or atmospheric elements that are out of character |
| Paleontological resources | Paleontological resources within the vicinity of facilities | | Potential for loss, isolation, or alteration of paleontological resources |

F.9 PUBLIC AND OCCUPATIONAL HEALTH AND SAFETY

F.9.1 Description of Affected Resources

Public and occupational health and safety analysis examines the potential adverse human health effects of exposure to ionizing radiation and hazardous chemicals. Health effects are determined by identifying the types and quantities of additional radioactive materials and toxic chemicals to which individuals may be exposed and estimating doses or exposures and the resulting indicators of health effects (latent cancer fatalities [LCFs], emergency exposure air concentration guidelines). The impacts of various releases during both normal activities (facility operations, construction, demolitions) and postulated accidents on the health of workers and the public residing within an ROI of 80 kilometers (50 miles) were assessed using site-specific factors such as meteorology, population distribution, and distance to nearby receptors. More-detailed information on the types and quantities of materials released during normal operations and accident conditions is provided in Appendix K.

F.9.2 Description of Impact Assessment

Health effects, in terms of incremental doses or exposures and related risks (LCFs or relationship to exposure thresholds), were assessed based on the types and quantities of materials released. Impacts on involved workers are estimated based on operational experience, engineering estimates, and administrative control levels. Models were used to estimate impacts on the health of noninvolved workers and the public resulting from releases during normal (incident-free) operations. The models included:

- GENII for all radioactive air emissions during normal operations (Napier et al. 1988). GENII was selected as an appropriate model for radiological dose analysis because it was developed to

model, among other things, radiation doses to individuals and populations from routine releases of radioactive materials into the air and water.

- MACCS2, Version 1.13.1, for all radioactive materials released during accident conditions (Chanin and Young 1997). MACCS2 was selected as an appropriate model because it was developed for DOE and the U.S. Nuclear Regulatory Commission to calculate radiation doses caused by airborne release of a wide range of radioisotopes. It is specifically recommended by DOE for calculating radiological accident consequences and risks in EISs.
- EPIcode [Emergency Prediction Information Code] for all hazardous chemicals released during accident conditions (Homann 2003). As one of the computer models included in the DOE Safety Software Central Registry, EPIcode was selected to perform estimates of atmospheric dispersion and resultant downwind concentrations of hazardous chemicals for comparison to human health limits. The codes included in the registry have been determined to be compliant with the DOE Safety Software Quality Assurance requirements. These codes are recommended for use by DOE to perform calculations and develop data used to establish the safety basis for DOE facilities and their operation, as well as to support the variety of safety analyses and evaluations developed for these facilities.

Detailed discussions of the application of these models are provided in Appendix K.

F.10 TRANSPORTATION

F.10.1 Description of Affected Resources

Transportation of any commodity involves a risk to both transportation crewmembers and members of the public. This risk results directly from transportation-related accidents and indirectly from increased levels of pollution from vehicle emissions, regardless of the cargo. Transportation of certain materials such as hazardous or radioactive waste can pose an additional risk due to the unique nature of the materials themselves. To permit a complete appraisal of the environmental impacts of the proposed actions and alternatives, the human health risks associated with transportation of radioactive materials on public highways and railroads were assessed.

Transportation impacts consist of two parts: the impacts of incident-free (routine) transportation and the impacts of transportation accidents. Incident-free transportation and transportation accident impacts may be either nonradiological or radiological or both. Incident-free transportation impacts include radiological impacts on the public and the workers due to the radiation field surrounding the transportation package. Nonradiological impacts of potential transportation accidents include traffic accident fatalities.

Transportation-related risks were calculated and presented separately for workers (truck or rail drivers) and members of the general public (residing or traveling in vehicles along the routes and present at rest and refueling stops). For the incident-free operation, the ROI for the affected population includes individuals living within 800 meters (0.5 miles) of each side of the road or rail. For accident conditions, the ROI for the affected population includes individuals residing within 80 kilometers (50 miles) of the accident; the maximally exposed individual would be an individual located 100 meters (330 feet) directly downwind from the accident. The risk to the affected population is a measure of the radiological risk posed to society as a whole by the alternative being considered. As such, the impact on the affected population was used as the primary means of comparing various alternatives.

F.10.2 Description of Impact Assessment

The impact of a specific radiological accident is expressed in terms of probabilistic risk, which is defined as the accident probability (i.e., accident frequency) multiplied by the accident consequences. The overall risk is obtained by summing the individual risks from all reasonably conceivable accidents. Only as a result of a severe fire and/or a powerful collision, which have extremely low probabilities, could a transportation package of the type used to transport radioactive material be damaged to the extent that a release of radioactivity to the environment with significant consequences could occur. In addition to calculating the radiological risks that would result from all reasonably conceivable accidents during transportation of radioactive waste, the consequences of maximum reasonably foreseeable accidents, events with a probability greater than 1×10^{-7} (1 chance in 10 million) per year, were assessed. The latter consequences were determined for atmospheric conditions that would likely prevail during accidents. The analysis used the RISKIND code to estimate doses to individuals and populations (Yuan et al. 1995).

The risks of incident-free effects are expressed in additional LCFs. The risks of radiological accidents are expressed as additional LCFs and, for nonradiological accidents, as additional immediate (traffic) fatalities.

In determining the transportation risks, per-shipment risk factors were calculated for both incident-free and accident conditions using the RADTRAN 5 computer program (Neuhauser and Kanipe 2003) in conjunction with the TRAGIS [Transportation Routing Analysis Geographic Information System] computer program (Johnson and Michelhaugh 2003), which was used to choose representative routes in accordance with U.S. Department of Transportation regulations. The TRAGIS program provides population estimates along the representative routes that are used to determine the population radiological risk factors. Details on the analysis approach, modeling, and parameter selections are provided in Appendix H, Sections H.4 and H.5.

F.11 SOCIOECONOMICS

F.11.1 Description of Affected Resources

Socioeconomic impacts are defined in terms of changes to the demographic and economic characteristics and social conditions of a region. For example, the number of jobs created by the proposed actions could affect regional employment, income, and expenditures. Job creation is generally characterized by two types: (1) construction-related jobs, which are transient in nature and limited in duration, and thus less likely to have a longer-term socioeconomic impact; and (2) operations-related jobs in support of facility operations, which are required for a longer period of time and have the greater potential for permanent socioeconomic impacts in the ROI. The ROI for socioeconomics encompasses the counties in which more than 90 percent of the site workers live.

The socioeconomic environment generally includes regional economic indicators, demographic characteristics, and community services available in the area. Economic indicators include employment, the civilian labor force, and unemployment rates. Demographic and community service characteristics include population, housing, education, health, and local transportation information.

F.11.2 Description of Impact Assessment

For each county in the ROI, data were compiled on current socioeconomic conditions, including employment, the civilian labor force, and unemployment. Census data were compiled for population, housing, and community services. U.S. Census Bureau population estimates for the ROIs were combined with overall projected workforce requirements for each alternative to determine the extent of impacts on

**Draft Tank Closure and Waste Management Environmental Impact Statement for the
Hanford Site, Richland, Washington**

regional economic and demographic (population) characteristics, including levels of demand for housing and community services, and local transportation impacts (see Table F–12).

Table F–12. Socioeconomics Impact Assessment Protocol

| Resource | Required Data | | Measure of Impact |
|--|--|---|--|
| | Affected Environment | Alternative | |
| Regional Economic Characteristics | | | |
| Workforce requirements | Site workforce projections from the Hanford Site and Idaho National Laboratory | Estimated construction, operations, deactivation, and closure activity staffing requirements and timeframes | Workforce requirements added to sites' workforce projections |
| Region of influence—civilian labor force | Labor force estimates from the U.S. Census Bureau | Estimated construction, operations, deactivation, and closure activity staffing requirements and timeframes | Workforce requirements as a percentage of the civilian labor force |
| Employment rate | Latest available employment estimates in counties surrounding both sites from the U.S. Census Bureau | Estimated construction, operations, deactivation, and closure activity staffing requirements and timeframes | Potential change in unemployment |
| Demographic Characteristics | | | |
| Population and demographics of race, ethnicity, and income | Latest available estimates by county from the U.S. Census Bureau | Estimated effect on population | Potential effects on population |
| Housing and Community Services | | | |
| Housing—percent of occupied housing units (houses and apartments) | Latest available ratios from the U.S. Census Bureau | Estimated housing unit requirements | Potential change in housing unit availability |
| Public education • Total enrollment • Teacher-to-student ratio | Latest available information for local school districts or state and county estimates | Estimated effect on enrollment and teacher-student ratio | Projected change in teacher-to-student ratio |
| Health care—number of hospital beds and physicians per 1,000 residents | Latest available rates from the U.S. Census Bureau | Estimated effect on health care services | Potential change in the availability of hospital beds/physicians |
| Local Transportation | | | |
| Traffic—number of vehicles | Latest available information on traffic conditions affecting site access roads and intrasite road and local regional transportation networks | Estimated number of commuter and truck vehicle trips to and from the site | Projected change in traffic conditions |

F.12 WASTE MANAGEMENT

F.12.1 Description of Affected Resources

Depending on the alternative, the construction, operations, deactivation, and decommissioning of facilities associated with tank waste retrieval, treatment, and disposal and tank closure would result in the following waste types:

- Immobilized high-level radioactive waste (IHLW)—High-level radioactive waste (HLW) that would be immobilized in a borosilicate glass matrix, resulting in a glass waste form.
- Mixed transuranic (TRU) waste—Radioactive waste not classified as HLW and containing more than 100 nanocuries of alpha-emitting TRU isotopes per gram of waste, with half-lives greater than 20 years, that also contains hazardous components regulated under the Resource

Conservation and Recovery Act (RCRA) (42 U.S.C. 6901 et seq.). All TRU waste would be managed as mixed TRU waste.

- Low-level radioactive waste (LLW)—Radioactive waste that is not classified as HLW, TRU waste, spent nuclear fuel, the tailings or waste produced by the extraction or concentration of uranium or thorium from any ore processed primarily for its source material, or naturally occurring radioactive material.
- Immobilized low-activity waste (ILAW)—Low-activity waste (LAW) immobilized by the Hanford Waste Treatment Plant (WTP) or processed by supplemental treatment (e.g., bulk vitrification, cast stone, or steam reforming). After receiving the necessary approvals, ILAW would be managed as LLW incidental to reprocessing, as defined in DOE Manual 435.1-1. Because it would be a product from treatment of Hanford tank waste, it would also be managed as a mixed waste.
- Mixed LLW (MLLW)—LLW that also contains hazardous components regulated under RCRA (42 U.S.C. 6901 et seq.).
- WTP HLW retired melters—Large-capacity, joule-heated, ceramic-lined melters with a theoretical maximum capacity of 3 metric tons of glass per day per melter. These would be managed as HLW.
- LAW retired melters—Large-capacity, joule-heated, ceramic-lined melters with a theoretical maximum capacity of 15 metric tons of glass per day per melter. These would be managed as MLLW.
- Hazardous and dangerous waste—Under RCRA, a solid waste that, because of its characteristics, may (1) cause or significantly contribute to an increase in mortality or an increase in serious irreversible, or incapacitating reversible, illness; or (2) pose a substantial present or potential hazard to human health or the environment when improperly treated, stored, transported, disposed of, or otherwise managed. Hazardous waste appears on special EPA lists or possesses at least one of the following characteristics: ignitability, corrosivity, reactivity, or toxicity. This category does not include source, special nuclear, or byproduct material as defined by the Atomic Energy Act (42 U.S.C. 2011 et seq.). Hazardous waste may also include solid waste designated by Washington State in WAC 173-303-070 through WAC 173-303-100 as dangerous, extremely hazardous or mixed waste, acute hazardous waste, or special waste.
- Nonhazardous solid waste—Discarded material, including solid, liquid, semisolid, or contained gaseous material resulting from industrial, commercial, mining, and agricultural operations and from community activities. This category does not include source, special nuclear, or byproduct material as defined by the Atomic Energy Act (42 U.S.C. 2011 et seq.).

The alternatives could have an impact on existing Hanford facilities devoted to the treatment, storage, and disposal of these categories of waste.

F.12.2 Description of Impact Assessment

As shown in Table F-13, impacts were assessed by comparing the projected waste stream volumes generated from the proposed activities under each alternative with the site's waste management capacities and generation rates. Projected waste generation rates for the proposed activities and projected waste shipments from offsite sources were compared with the site's capacity to manage the waste.

Table F-13. Waste Management Impact Assessment Protocol

| Resource | Required Data | | Measure of Impact |
|---|---|--|--|
| | Affected Environment | Alternative | |
| Waste management capacity <ul style="list-style-type: none"> • IHLW • TRU waste • Mixed TRU waste • LLW • ILAW • MLLW • Hazardous waste • Nonhazardous waste • Waste Treatment Plant • HLW retired melters • LAW retired melters | Site generation rates (cubic meters per year) for each waste type Offsite shipments (cubic meters per year) for each waste type Site management capacities (cubic meters) or rates (cubic meters per year) for potentially affected treatment, storage, and disposal facilities for each waste type | Generation rates (cubic meters per year) for each waste type | Combination of facility waste generation volumes and other site generation volumes in comparison to the capacities of applicable waste management facilities |

Key: HLW=high-level radioactive waste; IHLW=immobilized high-level radioactive waste; ILAW=immobilized low-activity waste; LAW=low-activity waste; LLW=low-level radioactive waste; MLLW=mixed low-level radioactive waste; TRU=transuranic.

Only the impacts relative to the capacities of the waste management facilities were considered; other environmental impacts of waste management facility operations (human health effects) were evaluated in other sections of this TC & WM EIS or in other facility-specific or sitewide National Environmental Policy Act documents. Projected waste generation rates for the proposed activities were compared with site processing rates and the capacities of the treatment, storage, and disposal facilities likely to be involved in managing the additional waste.

F.13 ENVIRONMENTAL JUSTICE

F.13.1 Description of Affected Resources

Environmental justice assesses of the potential for disproportionately high and adverse human health and environmental effects on minority and low-income populations resulting from implementation of the alternatives in this TC & WM EIS. In assessing the impacts, the following definitions of minority individuals and populations and low-income population were used.

- Minority individuals are identified as members of the following population groups: Hispanic or Latino, American Indian or Alaska Native, Asian, Black or African American, Native Hawaiian or Other Pacific Islander, or two or more races.
- Minority populations are identified where either (1) the minority population of the affected area exceeds 50 percent or (2) the minority population percentage of the affected area is meaningfully greater than the minority population percentage in the general population or other appropriate unit of geographic analysis.
- Low-income populations are identified in an affected area using the annual statistical poverty thresholds from the U.S. Census Bureau's Current Population Reports, Series P60-210 on Consumer Income, **Poverty in the United States: 1999** (Dalaker and Proctor 2000). The 1999 poverty threshold for an individual in the United States of an annual income of \$8,501 was used to determine the number of individuals living in poverty.

Consistent with the impact analysis for the public and occupational health and safety, the affected populations were defined as those minority and low-income populations that reside within an 80-kilometer (50-mile) radius centered on the candidate facilities at Hanford and INL. The decennial census data is used in this analysis because block group level data is unavailable from the annual American Community Survey. Appendix J details the process by which the affected populations were determined.

F.13.2 Description of Impact Assessment

Adverse health effects are measured in risks and exposure rates that could result in LCFs as well as other fatal or nonfatal adverse impacts on human health. Disproportionately high or adverse human health effects occur when the risk of, or rate of exposure to, an environmental hazard for a minority or low-income population is significant and exceeds the risk or exposure rate for the general population or for another appropriate comparison group. The minority and low-income populations are subsets of the general public residing around Hanford and INL; all are exposed to the same hazards generated from various operations at the site. Therefore, estimates of the environmental justice impacts were determined using either the human health risk results or similar methods provided in Appendices H, K, Q, and R. Appendix J provides details of the analysis method and the resulting impacts on the affected populations.

F.14 REFERENCES

BLM (U.S. Bureau of Land Management), 1986, **Visual Resource Inventory**, BLM Manual Handbook H-8410-1, Washington, D.C., January 17.

BSSC (Building Seismic Safety Council), 2004a, **NEHRP Recommended Provisions for Seismic Regulations for New Buildings and Other Structures (FEMA 450), 2003 Edition, Part 1: Provisions**, National Institute of Building Sciences, Washington, D.C.

BSSC (Building Seismic Safety Council), 2004b, **NEHRP Recommended Provisions for Seismic Regulations for New Buildings and Other Structures (FEMA 450), 2003 Edition, Part 2: Commentary**, National Institute of Building Sciences, Washington, D.C.

Chanin, D.I., and M.L. Young, 1997, **Code Manual for MACCS2, Vol. 1, User's Guide**, SAND97-0594, Sandia National Laboratories, Accident Analysis/Consequence Assessment Department, Albuquerque, New Mexico, March.

Chatters, J.C., and N.A. Cadoret, 1990, **Archaeological Survey of the 200 East and 200 West Areas, Hanford Site, Washington**, PNL-7264, Pacific Northwest Laboratory, Richland, Washington, March.

Dalaker, J., and B.D. Proctor, 2000, **Poverty in the United States: 1999**, Current Population Reports: Consumer Income, Series P60-210, U.S. Census Bureau, Washington, D.C., September.

Depperschmidt, J.D., 2007, Idaho National Laboratory, Idaho Falls, Idaho, personal communication (email) to M. Burandt, U.S. Department of Energy, Office of River Protection, Richland, Washington, "Fed Ex Address" (regarding response to data request for Idaho National Laboratory, including 2006 nonradiological criteria pollutant releases), May 22.

Duncan, J.P., ed., 2007, **Hanford Site National Environmental Policy Act (NEPA) Characterization**, PNNL-6415, Rev. 18, Pacific Northwest National Laboratory, Richland, Washington, September.

EPA (U.S. Environmental Protection Agency), 1974, **Information on Levels of Environmental Noise Requisite to Protect Public Health and Welfare with an Adequate Margin of Safety**, EPA-550/9-74-004, Office of Noise Abatement and Control, March.

EPA (U.S. Environmental Protection Agency), 2004, **User's Guide for the AMS/EPA Regulatory Model – AERMOD**, EPA-454/B-03-001, Office of Air Quality Planning and Standards, Emissions Monitoring and Analysis Division, Research Triangle Park, North Carolina, September.

EPA (U.S. Environmental Protection Agency), 2006, **Mid-Atlantic Integrated Assessment: Mid-Atlantic Highlands Streams Assessment**, Appendix C, "Glossary," accessed through <http://www.epa.gov/maia/html/mah-apc.html>, March 3.

Homann, S., 2003, **Introduction to EPIcode**, Version 7.0, Homann Associates, Inc., September.

Johnson, P.E., and R.D. Michelhaugh, 2003, **Transportation Routing Analysis Geographic Information System (TRAGIS) User's Manual**, ORNL/NTRC-006, Rev. 0, Oak Ridge National Laboratory, Oak Ridge, Tennessee, June.

Johnson, R.E., 2006, **Calendar Year 2005 Nonradioactive Inventory of Airborne Emissions Report**, DOE/RL-2006-05, Rev. 0, U.S. Department of Energy, Richland Operations Office and Office of River Protection, Richland, Washington, March.

Napier, B.A., R.A. Peloquin, D.L. Strenge, and J.V. Ramsdell, 1988, **GENII – The Hanford Environmental Radiation Dosimetry Software System**, PNL-6584, Pacific Northwest Laboratory, Richland, Washington, December.

Neuhauser, K.S., and F.L. Kanipe, 2003, **RADTRAN 5 User Guide**, SAND2003-2354, Sandia National Laboratories, Albuquerque, New Mexico, July.

PNNL (Pacific Northwest National Laboratory), 2007. This reference is for Official Use Only.

Prendergast-Kennedy, E., 2003, Pacific Northwest National Laboratory, Richland, Washington, personal communication (letter) to C. Johnson, Science Applications International Corporation, Richland, Washington, “Cultural Resources Review of Retrieval, Treatment and Disposal of Tank Waste and Closure of Single Shell Tanks (Tank Closure) Environmental Impact Statement (EIS), (HCRC #2003-200-044),” August 28.

Sackschewsky, M.R., 2003a, Pacific Northwest National Laboratory, Richland, Washington, personal communication (letter) to C. Johnson, Science Applications International Corporation, Richland, Washington, “Biological Review of the Tank Waste Retrieval, Treatment, and Disposal EIS Project, 200 E and W Areas, ECR #2003-200-044,” September 5.

Sackschewsky, M.R., 2003b, Pacific Northwest National Laboratory, Richland, Washington, personal communication (letter) to C. Johnson, Science Applications International Corporation, Richland, Washington, “Supplemental Biological Review of the Tank Waste Retrieval, Treatment, and Disposal EIS Project, 200 E and W Areas, ECR #2003-200-044a,” September 11.

Sackschewsky, M.R., and J.L. Downs, 2007, **Ecological Data in Support of the “Tank Closure and Waste Management Environmental Impact Statement,”** Part 2, “Results of Spring 2007 Field Surveys,” PNNL-16620, Pacific Northwest National Laboratory, Richland, Washington, May.

SAIC (Science Applications International Corporation), 2007a, **Tank Closure Alternatives, Scaled Data Sets to Support the “Tank Closure and Waste Management Environmental Impact Statement for the Hanford Site, Richland, Washington,”** Germantown, Maryland, July 12.

SAIC (Science Applications International Corporation), 2007b, **Fast Flux Test Facility Alternatives, Scaled Data Sets to Support the “Tank Closure and Waste Management Environmental Impact Statement for the Hanford Site, Richland, Washington,”** Germantown, Maryland, July 12.

SAIC (Science Applications International Corporation), 2007c, **Waste Management Alternatives, Scaled Data Sets to Support the “Tank Closure and Waste Management Environmental Impact Statement for the Hanford Site, Richland, Washington,”** Germantown, Maryland, July 12.

USGS (U.S. Geological Survey), 2007, **Seismic Design Values for Buildings; National Earthquake Hazard Reduction Program (NEHRP) Maps, 1997, 2000**, Earthquake Hazards Program, National Seismic Mapping Project, accessed through <http://eqdesign.cr.usgs.gov/html/nehrrp-D6.html>, <http://eqdesign.cr.usgs.gov/html/nehrrp.html>, January 25.

USGS (U.S. Geological Survey), 2008a, **Earthquake Hazards 201 – Technical Information, What is Probabilistic Ground Motion?, A Simple Description of Seismic Hazard Maps**, Earthquake Hazards Program, accessed through <http://earthquake.usgs.gov/research/hazmaps/haz101/faq/faq.php>, July 16.

USGS (U.S. Geological Survey), 2008b, **Earthquake Hazards 201 – Technical Information, What is Probabilistic Ground Motion?, Uses for the Seismic Hazard Maps**, Earthquake Hazards Program, accessed through <http://earthquake.usgs.gov/research/hazmaps/haz101/faq/faq.php>, July 16.

USGS (U.S. Geological Survey), 2008c, **FAQ – Measuring Earthquakes, What are the Earthquake Magnitude Classes?, What is Intensity?, What is the Modified Mercalli Intensity Scale?, What is the Difference Between Intensity Scales and Magnitude Scales?, What are the Different Magnitude Scales, and Why are There so Many?**, Earthquake Hazards Program, accessed through <http://earthquake.usgs.gov/learning/faq.php?categoryID=2>, July 28.

USGS (U.S. Geological Survey), 2008d, **Earthquake Topics – Intensity, Magnitude/Intensity Comparison**, Earthquake Hazards Program, accessed through <http://earthquake.usgs.gov/learning/topics.php?topicID=77&topic=Intensity>, July 16.

Wald, D.J., V. Quitoriano, T.H. Heaton, and H. Kanamori, 1999, “Relationships Between Peak Ground Acceleration, Peak Ground Velocity, and Modified Mercalli Intensity in California,” **Earthquake Spectra**, Vol. 15, pp. 557–564.

Yuan, Y.C., S.Y. Chen, B.M. Biwer, and D.J. LePoire, 1995, **RISKIND – A Computer Program for Calculating Radiological Consequences and Health Risks from Transportation of Spent Nuclear Fuel**, ANL/EAD-1, Argonne National Laboratory, Argonne, Illinois, November.

Code of Federal Regulations

7 CFR 657.5, Natural Resources Conservation Service, U.S. Department of Agriculture, “Prime and Unique Farmlands: Identification of Important Farmlands.”

7 CFR 658.3, Natural Resources Conservation Service, U.S. Department of Agriculture, “Farmland Protection Policy Act: Applicability and Exemptions.”

7 CFR 658.7, Natural Resources Conservation Service, U.S. Department of Agriculture, “USDA Assistance with Federal Agencies’ Reviews of Policies and Procedures.”

10 CFR 1022, U.S. Department of Energy, “Compliance with Floodplain and Wetland Environmental Review Requirements.”

33 CFR 328.3, Corps of Engineers, Department of the Army, U.S. Department of Defense, “Definition of Waters of the United States.”

40 CFR 50, U.S. Environmental Protection Agency, “National Primary and Secondary Ambient Air Quality Standards.”

40 CFR 51, U.S. Environmental Protection Agency, “Requirements for Preparation, Adoption, and Submittal of Implementation Plans,” Appendix W, “Guideline on Air Quality Models.”

40 CFR 51.165, U.S. Environmental Protection Agency, “Requirements for Preparation, Adoption, and Submittal of Implementation Plans: Permit Requirements.”

40 CFR 61, U.S. Environmental Protection Agency, “National Emission Standards for Hazardous Air Pollutants.”

40 CFR 81, U.S. Environmental Protection Agency, “Designation of Areas for Air Quality Planning Purposes.”

40 CFR 81.313, U.S. Environmental Protection Agency, “Designation of Areas for Air Quality Planning Purposes,” Subpart C, Section 107, “Attainment Status Designations: Idaho.”

40 CFR 81.348, U.S. Environmental Protection Agency, “Designation of Areas for Air Quality Planning Purposes,” Subpart C, Section 107, “Attainment Status Designations: Washington.”

United States Code

7 U.S.C. 4201 et seq., Farmland Protection Policy Act.

16 U.S.C. 470 et seq., National Historic Preservation Act.

16 U.S.C. 1531 et seq., Endangered Species Act of 1973.

33 U.S.C. 1251 et seq., Clean Water Act of 1972.

40 U.S.C. 7401 et seq., Clean Air Act of 1970.

42 U.S.C. 300(f) et seq., Safe Drinking Water Act of 1974.

42 U.S.C. 2011 et seq., Atomic Energy Act of 1954.”

42 U.S.C. 6901 et seq., Resource Conservation and Recovery Act of 1976.

42 U.S.C. 7472 et seq., Prevention of Significant Deterioration of Air Quality: Initial Classifications.

Executive Order

Executive Order 11988, **Floodplain Management**, May 24, 1997.

U.S. Department of Energy Orders and Standards

DOE Order 420.1B, **Facility Safety**, December 22, 2005.

DOE Manual 435.1-1, **Radioactive Waste Management Manual**, Change 1, June 19, 2001.

DOE Standards 1020-2002, **Natural Phenomena Hazards Design and Evaluation Criteria for Department of Energy Facilities**, January 2002.

DOE Standards 1023-95, **Natural Phenomena Hazards Assessment Criteria**, April 2002.

Washington Administrative Code

WAC 173-60, Washington State Department of Ecology, “Maximum Environmental Noise Levels,” Olympia, Washington, December 2000.

WAC 173-303, Washington State Department of Ecology, “Dangerous Waste Regulations,” Olympia, Washington.

APPENDIX G AIR QUALITY ANALYSIS

This appendix presents information on the nonradiological air quality impacts that could result from emissions associated with construction, operations, deactivation, and closure activities under the various alternatives described in this *Tank Closure and Waste Management Environmental Impact Statement for the Hanford Site, Richland, Washington*. The impacts of criteria pollutants and toxic air pollutants were assessed by comparing estimated concentrations with ambient standards and Washington State acceptable source impact levels for toxic pollutants. Assessed impacts of toxic air pollutant emissions on noninvolved workers are summarized in Chapter 4, and the health risks of toxic chemicals and radionuclides, in Appendix K. Air quality resources and the region of influence are discussed and the impact assessment methods summarized in Appendix F, Section F.4.

The Clean Air Act authorizes the U.S. Environmental Protection Agency (EPA) to set permissible levels of exposure for selected air pollutants using health-based criteria. These “criteria pollutants” include carbon monoxide, nitrogen dioxide, particulate matter with an aerodynamic diameter less than or equal to 10 micrometers (PM₁₀) and 2.5 micrometers (PM_{2.5}), sulfur dioxide, lead, and ozone. The maximum permissible exposure levels for these pollutants are set in the National Ambient Air Quality Standards (NAAQS) (40 CFR 50). The standards focus on short-term exposures (1-hour or 3-hour), workday exposures (8-hour), and long-term exposures (24-hour and annual). The exposures considered vary by pollutant. Primary standards are established to protect against adverse health effects. Secondary standards protect against welfare effects, such as damage to crops, vegetation, and buildings, as well as decreased visibility. Washington State has defined standards for sulfur dioxide—these more restrictive than the NAAQS—and for total suspended particulates. Chapter 3, Section 3.2, of this **Tank Closure and Waste Management Environmental Impact Statement for the Hanford Site, Richland, Washington (TC & WM EIS)** reflects the most restrictive of the Washington State ambient standards and the NAAQS; Chapter 3, Section 3.3, the most restrictive of the State of Idaho’s ambient standards and the NAAQS. Enabling legislation for these regulations is discussed in Chapter 8. U.S. Department of Energy (DOE) activities at the Hanford Site (Hanford) are subject to state air quality permitting requirements, discussed in Chapter 8. This **TC & WM EIS** evaluates criteria pollutant impacts by comparing concentrations with the most restrictive standards for carbon monoxide, nitrogen dioxide, PM₁₀, PM_{2.5}, and sulfur dioxide. Table G-1 presents the applicable ambient air pollutant standards and acceptable source impact levels with which estimated air pollutant concentrations were compared.

Carbon monoxide, nitrogen dioxide, particulate matter, and sulfur dioxide are produced from the combustion of fossil fuels. Particulate matter is generated by the mechanical disturbance of soil by earthmoving activities, vehicle traffic over unpaved and paved roadways, and the action of the wind on disturbed soils. Lead is not analyzed in this **TC & WM EIS** because the level of emissions is negligible. Ozone is typically formed as a secondary pollutant in the ambient air (troposphere) in the presence of sunlight from the mixing of primary pollutants, such as nitrogen oxides and volatile organic compounds (VOCs), emanating from various mobile (vehicular) and stationary (including natural) sources. Ozone has not been identified as being emitted directly from the facilities evaluated. Although ozone may be regarded as a regional issue, specific ozone precursors, notably nitrogen dioxide and VOCs, were considered. Concentrations of nitrogen dioxide were analyzed, and emissions of VOCs were estimated.

**Table G–1. Ambient Air Pollutant Standards and
Acceptable Source Impact Levels**

| Pollutant | Averaging Period | Most Stringent Standard ^a (micrograms per cubic meter) | Washington Acceptable Source Impact Level (micrograms per cubic meter) |
|----------------------------|---------------------|--|--|
| Criteria Pollutants | | | |
| Carbon monoxide | 8-hour | 10,000 ^b | N/A |
| | 1-hour | 40,000 ^b | N/A |
| Nitrogen dioxide | Annual | 100 ^c | N/A |
| PM ₁₀ | Annual | 50 ^c | N/A |
| | 24-hour | 150 ^b | N/A |
| PM _{2.5} | Annual | 15 ^d | N/A |
| | 24-hour | 35 ^d | N/A |
| Sulfur dioxide | Annual | 50 ^{c, e} | N/A |
| | 24-hour | 260 ^{c, e} | N/A |
| | 3-hour | 1,300 ^b | N/A |
| | 1-hour | 660 ^{e, f} | N/A |
| Other Pollutants | | | |
| Ammonia | 24-hour | N/A | 100 ^g |
| Benzene | Annual | N/A | 0.12 ^g |
| 1,3-Butadiene | Annual | N/A | 0.0036 ^g |
| Formaldehyde | Annual | N/A | 0.077 ^g |
| Mercury | 24-hour | N/A | 0.17 ^g |
| Toluene | 24-hour | N/A | 400 ^g |
| Xylene | 24-hour | N/A | 1,500 ^g |

^a The more stringent of the Federal and Washington State standards is presented if both exist for the averaging period. The National Ambient Air Quality Standards (NAAQS) (40 CFR 50), other than those for ozone, particulate matter, lead, and those based on annual averages, are not to be exceeded more than once per year. The 24-hour PM₁₀ standard is attained when the standard is not exceeded more than once per year over a 3-year average. The annual arithmetic mean PM₁₀ standard is attained when the expected annual arithmetic mean concentration is less than or equal to the standard. The annual PM_{2.5} standard is attained when the 3-year average of the weighted annual mean concentrations does not exceed the standard. The 24-hour PM_{2.5} standard is attained when the 3-year average of the 98th percentile of the 24-hour concentrations does not exceed the standard.

^b Federal and Washington State standard.

^c Washington State standard.

^d Federal standard.

^e Idaho sulfur dioxide standards are 80 micrograms per cubic meter for the annual average and 365 for the 24-hour average. There is no 1-hour standard.

^f Not to be exceeded more than twice in any 7 consecutive days.

^g Washington State acceptable source impact level.

Note: NAAQS also include standards for lead and ozone. No sources of lead emissions have been identified for the alternatives evaluated. Washington State also has ambient standards for fluorides and total suspended particulates (TSP). Concentrations were not compared to the PM_{2.5} and TSP standards because specific emissions for them were not available. Emissions of hydrogen fluoride were not identified for any of the alternatives.

Key: N/A=not applicable; PM_n=particulate matter with an aerodynamic diameter less than or equal to n micrometers.

Source: 40 CFR 50; WAC 173-460, 173-470, 173-474, 173-475, 173-481, and 173-490.

Carcinogens and noncarcinogenic toxic chemicals that would be released from construction and operations activities were evaluated. The toxic pollutants evaluated include benzene, one of the primary contributors to carcinogenic risk, and ammonia, because of its higher concentration than other tank vapor source toxics, enabling it to serve as an indicator for stationary source air toxics. Toluene and xylene were modeled because they are typical of noncarcinogenic toxics associated with fuel combustion. Formaldehyde and 1,3-butadiene were modeled to represent carcinogenic toxics associated with fuel combustion. Mercury was included because of possible releases from thermal treatment processes. Exposure for members of the public to toxic airborne pollutants was evaluated by comparing maximum concentrations of such pollutants to which the public would be exposed with the Washington State acceptable source impact levels (WAC 173-460). Acceptable source impact levels are used during the permitting process to demonstrate that emissions from a new toxic air pollutant source are sufficiently low to protect human health and safety from potential carcinogenic and other toxic effects.

For noninvolved workers at nearby facilities, the highest annual concentration of each noncarcinogenic chemical was divided by the corresponding inhalation reference concentration to estimate the Hazard Quotient for the released chemical. The Hazard Quotients were summed to give the Hazard Index from noncarcinogenic chemicals associated with the various phases of each alternative. A Hazard Index of less than 1.0 indicates that adverse health effects of non-cancer-causing agents are not expected. For carcinogens, the highest annual concentration was multiplied by the unit cancer risk to estimate the increased cancer risk from that chemical. These results under each alternative are reported in Chapter 4.

To estimate maximum air quality impacts of Hanford tank closure activities, the AERMOD [American Meteorological Society/Environmental Protection Agency Regulatory Model] air dispersion model (EPA 2004) was used. The model was used to calculate dispersion factors at receptor locations to which the public and noninvolved workers could have access. This model uses a steady-state Gaussian plume algorithm to estimate pollutant concentrations from a wide variety of sources associated with industrial complexes. It is applicable to either flat or complex terrain, modeling domains with a radius of 50 kilometers (31 miles) or less from the point of release, and urban or rural environments.

Five years (2000–2004) of hourly meteorological data from the Hanford Meteorological Station (HMS) were used in conducting the AERMOD modeling. Wind and temperature data were obtained from measurements made on the monitoring tower at the HMS, located between the 200-West and 200-East Areas. These data are assumed to be representative because most of the tank closure, Fast Flux Test Facility (FFTF) decommissioning, and waste management activities at Hanford would occur near the 200 Areas and 400 Area. Wind data were obtained from measurements made 9 meters (30 feet) above ground level. Temperature measurements were made at 1.5 meters (5 feet) above ground level. Mixing-depth measurements were made using the HMS Doppler acoustic sodar. Surface meteorological data from the Pasco, Washington, National Weather Service Station were used to supplement the HMS data in the preprocessing of meteorological data using the AERMET [American Meteorological Society/EPA Regulatory Meteorological Preprocessor] program. Upper-air profiles from the Spokane, Washington, National Weather Service Station were also used.

The AERMOD model uses hourly meteorological data records to compute the maximum dispersion coefficients for various averaging periods and receptor locations. Short-term (1-, 3-, 8-, and 24-hour) dispersion factors were calculated at (1) receptors along the Hanford Reach boundary at points approximately 100 meters (0.062 miles) apart; (2) receptors along publicly accessible portions of State Route 240 at points 0.7 to 1 kilometer (0.43 to 0.62 miles) apart; and (3) additional grids of receptors beyond the boundary, one extending 5 kilometers (3.1 miles) away with points 0.5 kilometers (0.31 miles) apart and the other from 5 to 10 kilometers (3.1 to 6.2 miles) distant with points 1 kilometer (0.6 miles) apart. Annual dispersion factors were calculated at receptors along the Hanford boundary at points approximately 100 meters (0.62 miles) apart and at additional grids of receptors beyond the Hanford

boundary, one extending 5 kilometers (3.1 miles) away with points 0.5 kilometers (0.31 miles) apart and the other from 5 to 10 kilometers (3.1 to 6.2 miles) distant with points 1 kilometer (0.6 miles) apart. Modeling receptors for 1- through 24-hour averaging periods are shown in Figure G-1. Receptors for annual modeling are shown in Figure G-2. The receptor locations are accessible to the public and thus are locations at which the public could be exposed to emissions from Hanford tank closure activities.

For the purpose of evaluating air toxic concentrations for the nearest noninvolved workers, three receptors were employed, one in the 200-East Area at the 242-A Evaporator, one at the Environmental Restoration Disposal Facility, and one at the Columbia Generating Station (see Figure G-1). A noninvolved worker is a person working at the site who is incidentally exposed to emissions associated with the Tank Closure, FFTF Decommissioning, or Waste Management alternatives. Both simple and complex terrains were considered in the modeling runs. Elevations at each receptor location were determined from the 10-meter (11-yard) Digital Elevation Models.

In estimating the maximum potential for air quality impacts, emissions from Hanford activities were modeled using a combination of area and point sources. Area sources were defined for the 200-East Area, 200-West Area, the Waste Treatment Plant (WTP) (nonstack emissions), the 200-West Area Supplemental Treatment Technology Site, Borrow Area C, and the 400 Area (FFTF), as shown in Figures G-1 and G-2. Area source parameters are summarized in Table G-2. One point source was defined for the WTP emissions with the following specifications: a stack height of 10.67 meters (35 feet), exit temperature of 450 kelvins (350 degrees Fahrenheit), exit velocity of 19.4 meters (63.7 feet) per second, and stack diameter of 0.3048 meters (1 foot). These parameters were determined using the EPA procedure for determining a representative stack (EPA 1992) and actually represent the steam boiler plant at the WTP. These parameters were used to estimate dispersion coefficients for operation of the WTP and Effluent Treatment Facility. The actual height of the stack from which process emissions, such as mercury emissions, would be emitted would be higher (61 meters [200 feet]) and is expected to result in lower concentrations off site. A 61-meter (200-foot) stack was used for modeling radiological emissions (see Appendix K).

Sources that would operate in both 200-East and 200-West Areas were modeled using a source group referred to as "200EW," while sources that were generic were assumed to operate in all areas and were referred to as source group "200EW+."

For the purpose of modeling, a number of conservative assumptions were made that tend to overestimate concentrations from the activities. Absent an estimate of the facility's operating hours, it was assumed that emissions from operations activities could occur any time during a 24-hour period, not just during day-shift hours. Construction-related activities, including deactivation and closure activities, were assumed to occur during a 12-hour daytime period. It was also assumed for the purpose of the AERMOD modeling for public and worker receptors that pollutants do not decompose or deposit. In actuality, chemical decomposition and atmospheric deposition processes would act to reduce pollutant concentrations.

The sources of pollutants from tank closure, FFTF decommissioning, and waste management activities include diesel- and gasoline-fueled construction equipment, supplemental treatment processes, operation of WTP melters, grouting operations, employee vehicles, shipping, and any activity capable of generating fugitive dust. The analysis of air pollutant concentrations for the public included emission sources at each activity area, such as construction equipment, processes, operation of facilities, fugitive dust from the activity area, and vehicles operating in the activity area. Emissions from other vehicle operations, such as those on local roads at Hanford, those from operations in the region (e.g., shipping materials to Hanford), and employee vehicles, were in most cases quantified separately and were not included when calculating pollutant concentrations (see Sections G.2.1 and G.2.4).

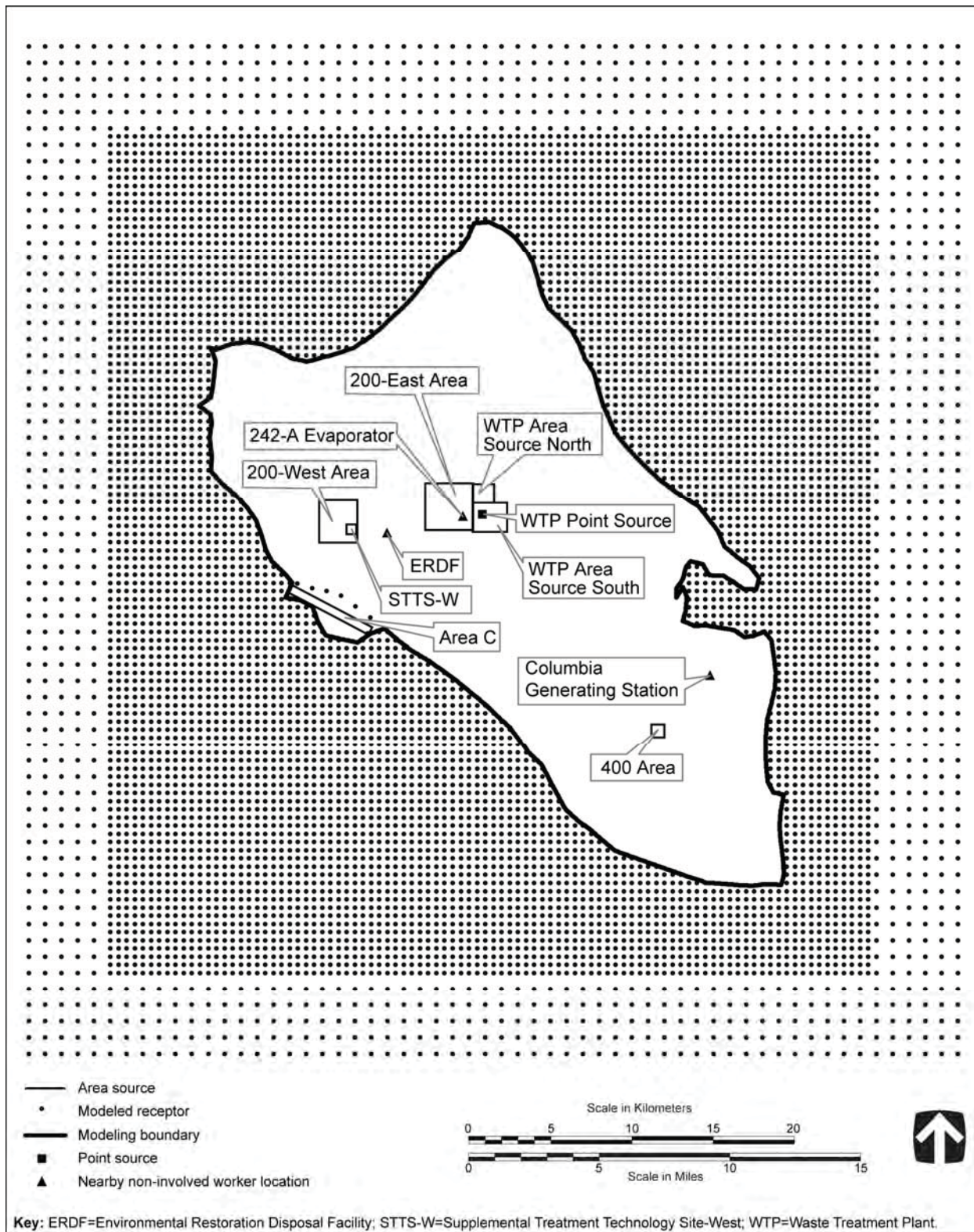

Figure G-1. Nonradiological Air Quality Modeling Receptors and Area Source Locations for 1- to 24-Hour Modeling

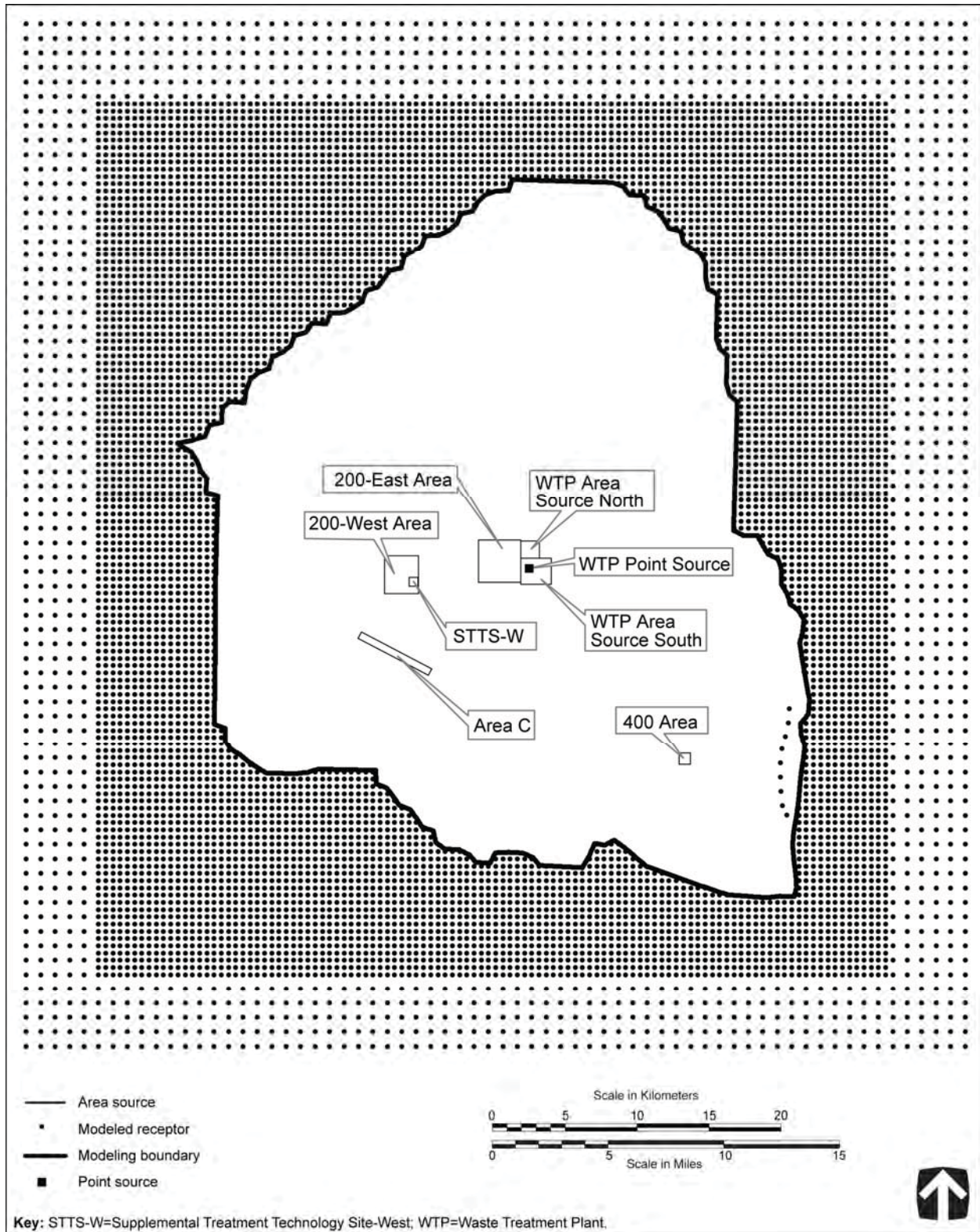

Figure G-2. Nonradiological Air Quality Modeling Receptors and Area Source Locations for Annual Modeling

Table G–2. Area Source Parameters

| Source Identifier | Easting ^a | Northing ^a | Base Elevation | Stack Height | Easterly Length | Northerly Length | Rotation (degrees) | Pit Volume (cubic meters) |
|-------------------|----------------------|-----------------------|----------------|--------------|-----------------|------------------|---------------------|---------------------------|
| | | | (meters) | | | | | |
| WTP_AS_N | 307210 | 5158973 | 179.83 | 3 | 1,291 | 1,199 | 0 | N/A |
| WTP_AS_S | 307210 | 5157163 | 198.12 | 3 | 2,092 | 1,810 | 0 | N/A |
| 200E | 304286 | 5157285 | 213.36 | 3 | 2,930 | 2,930 | 0 | N/A |
| 200W | 297775 | 5156505 | 213.36 | 3 | 2,340 | 2,640 | 0 | N/A |
| SUPW | 299471 | 5157033 | 210.01 | 3 | 600 | 600 | 0 | N/A |
| Area C | 300792 | 5150871 | 173.74 | 3 | 500 | 5,500 | -62.25 ^b | 11,430,000 |
| 400 Area | 318150 | 5144557 | 167.64 | 3 | 804 | 804 | 0 | N/A |

^a Data represent the locations of the southwest corners of the area sources expressed in UTM [Universal Transverse Mercator] coordinates (NAD [North American Datum] 27, Zone 11).

^b Indicates 62.25-degree counterclockwise rotation around the southwest corner of the area.

Note: To convert meters to feet, multiply by 3.281.

Key: 200E=200-East Area; 200W=200-West Area; N/A=not applicable; SUPW=200-West Area supplemental treatment facility; WTP_AS_N=Waste Treatment Plant area source north; WTP_AS_S=Waste Treatment Plant area source south.

For the construction activities at Idaho National Laboratory (INL) under FFTF Decommissioning Alternatives 2 and 3, dispersion factors were calculated using the EPA SCREEN3 model, a unit emission rate, a 32,375-square-meter (38,721-square-yard [8-acre]) area source, and a release height of 3 meters (9.8 feet). The model was employed to estimate the maximum dispersion factor at or beyond the site boundary. The maximum dispersion factor was found to occur at the site boundary 5,240 meters (17,200 feet) from the Materials and Fuels Complex (MFC).

For the ecological risk assessment, atmospheric dispersion analysis was performed at ecological receptor locations to support estimation of peak concentrations of potentially hazardous constituents due to normal releases from tank waste retrieval and processing and tank closure activities, FFTF decommissioning activities, and waste management activities. Environmental media considered in the ecological risk assessment included air, soil, and surface water of the Columbia River. Steps in the analysis included characterization of sources, identification of receptor locations, and estimation of atmospheric concentrations and deposition rates for these locations. Releases were represented as four ground-level sources (one each in the center of the 200-East and 200-West Areas, one at the 400 Area, and one in Borrow Area C) and an elevated source at the WTP in the 200-East Area. Emission rates were estimated using data packages developed for each alternative (see Section G.2). Receptors were placed at onsite and Columbia River nearshore locations. Onsite receptors were selected for all 16 compass bearings; Columbia River nearshore receptors were selected only at points along compass bearings that bisect the river. The number of Columbia River nearshore receptors varied with source area—from 8 for Borrow Area C up to 11 for the 200-East Area and WTP area. The ecological risk assessment is presented in Chapter 5, Sections 5.1.3, 5.2.3, and 5.3.3, and Appendix P.

The atmospheric dispersion analysis was conducted with the XOQDOQ model developed at Pacific Northwest Laboratory (Sagendorf, Goll, and Sandusky 1982). This Gaussian-plume-type model was used to calculate annual average dispersion and deposition conditions using a joint frequency distribution for the categories of velocity, stability class, and direction. For the 200-East Area, 200-West Area, and Borrow Area C ground-level source areas, the meteorological conditions used were the 10-year-average values reported for the 200 Area HMS at the 9-meter (30-foot) level. For the WTP elevated source area, 10-year values from the 200 Area HMS at the 61-meter (200-foot) level were used. For the FFTF ground-level source area, 10-year values from the 400 Area meteorological tower at the 9-meter (30-foot) level were used (Burk 2007). The highest dispersion and deposition conditions were recorded for each of the defined source areas, regardless of compass direction. As a conservative approach, the sum of the

products of the highest recorded dispersion and deposition conditions determined by the XOQDOQ model and the estimated emission rates for each source areas were taken to represent atmospheric concentration and deposition rates. Concentrations in soil were estimated assuming mixing into the upper 1 centimeter (0.4 inches) of soil over the period of operation under each alternative for the calculated deposition rate. Concentrations in surface water were estimated by dividing the annual deposition rate onto the area of affected surface water by the annual flow rate of surface water. Two surface-water environments were considered—a Columbia River nearshore low-flow region and a river average condition (see Appendix P).

G.1 DISPERSION FACTORS

AERMOD modeling runs for the various areas at Hanford were conducted to calculate, for each source or source group and a specified unit emission rate, a dispersion factor for the locations of maximum air quality impact on the public for various averaging periods. Presented as Table G–3 are the unit dispersion factors for the various locations. Multiplying the unit dispersion factor (seconds per cubic meter) by a maximum pollutant emission rate (micrograms per second) generates an estimate of the maximum air pollutant concentration, which is presented in micrograms per cubic meter. The emission rate for an activity can be estimated by dividing the annual emission rate (see Section G.2) by the hours of operation per year (see Sections G.2.1 and G.2.2). For criteria and toxic pollutants, the maximum air quality impacts of emissions from the 200 Areas would occur at points of public access along State Route 240 and at the site boundary to the east, southeast, and southwest.

**Table G–3. Locations and Corresponding Dispersion Factors for
Maximum Air Quality Impacts at the Hanford Site**

| Averaging Time | 24-Hour-per-Day Activity | | 12-Hour-per-Day Activity | |
|---|---------------------------------------|---|------------------------------------|---|
| | Maximum-Impact Location | Unit Dispersion Factor for Maximum-Impact Location ^a (s/m ³) | Maximum-Impact Location | Unit Dispersion Factor for Maximum-Impact Location ^a (s/m ³) |
| 200-East Area Emissions – Area Source (200E) | | | | |
| 1-hour | 1,000 meters southwest of boundary | 6.22×10 ⁻⁵ | 1,000 meters southwest of boundary | 5.91×10 ⁻⁵ |
| 3-hour | Northwest boundary | 2.17×10 ⁻⁵ | 1,000 meters southwest of boundary | 2.11×10 ⁻⁵ |
| 8-hour | West-southwest at State Route 240 | 1.32×10 ⁻⁵ | 1,000 meters southwest of boundary | 9.14×10 ⁻⁶ |
| 24-hour | 3,000 meters south of State Route 240 | 5.41×10 ⁻⁶ | Southwest site boundary | 3.98×10 ⁻⁶ |
| Annual | Southeast site boundary | 1.01×10 ⁻⁷ | 1,000 meters southeast of boundary | 3.75×10 ⁻⁸ |
| 200-West Area Emissions – Area Source (200W) | | | | |
| 1-hour | 1,000 meters southwest of boundary | 9.67×10 ⁻⁵ | 2,000 meters south at boundary | 9.02×10 ⁻⁵ |
| 3-hour | Southwest at State Route 240 | 4.1×10 ⁻⁵ | South at State Route 240 | 3.47×10 ⁻⁵ |
| 8-hour | West at State Route 240 | 2.65×10 ⁻⁵ | Southwest at State Route 240 | 1.65×10 ⁻⁵ |
| 24-hour | South at State Route 240 | 1.28×10 ⁻⁵ | Southwest at State Route 240 | 7.06×10 ⁻⁶ |
| Annual | South site boundary | 9.21×10 ⁻⁸ | 3,900 meters northwest of boundary | 4.51×10 ⁻⁸ |

Table G–3. Locations and Corresponding Dispersion Factors for Maximum Air Quality Impacts at the Hanford Site (continued)

| Averaging Time | 24-Hour-per-Day Activity | | 12-Hour-per-Day Activity | |
|---|--|---|--|---|
| | Maximum-Impact Location | Unit Dispersion Factor for Maximum-Impact Location ^a (s/m ³) | Maximum-Impact Location | Unit Dispersion Factor for Maximum-Impact Location ^a (s/m ³) |
| 200-East Area Emissions – Area Source for Waste Treatment Plant Construction and Deactivation (WTP_AS) | | | | |
| 1-hour | 1,500 meters south of State Route 240 | 1.78×10 ⁻⁴ | South at State Route 240 | 1.69×10 ⁻⁴ |
| 3-hour | North boundary | 6.09×10 ⁻⁵ | South at State Route 240 | 5.62×10 ⁻⁵ |
| 8-hour | Southwest at State Route 240 | 2.91×10 ⁻⁵ | South at State Route 240 | 2.38×10 ⁻⁵ |
| 24-hour | 1,500 meters south of State Route 240 | 1.63×10 ⁻⁵ | 1,500 meters south at State Route 240 | 9.64×10 ⁻⁶ |
| Annual | 1,000 meters south of east site boundary | 2.67×10 ⁻⁷ | 1,000 meters south of east site boundary | 9.43×10 ⁻⁸ |
| 200 Area Emissions – Point Source for Waste Treatment Plant Operations (WTP_PS) | | | | |
| 1-hour | 3,000 meters south of State Route 240 | 2.52×10 ⁻⁵ | 3,000 meters southwest of boundary | 2.35×10 ⁻⁵ |
| 3-hour | 3,000 meters south at State Route 240 | 1.55×10 ⁻⁵ | 3,000 meters south at State Route 240 | 1.06×10 ⁻⁵ |
| 8-hour | 3,000 meters south of south boundary | 7.74×10 ⁻⁶ | 3,400 meters east of boundary | 3.95×10 ⁻⁶ |
| 24-hour | 3,000 meters south of boundary | 2.58×10 ⁻⁶ | 3,000 meters south of boundary | 1.67×10 ⁻⁶ |
| Annual | East site boundary | 1.21×10 ⁻⁷ | 1,500 meters southeast of boundary | 3.37×10 ⁻⁸ |
| 200-West Area Supplemental Treatment Facility – Area Source (SUPW) | | | | |
| 1-hour | West boundary | 3.14×10 ⁻⁴ | South at State Route 240 | 3.14×10 ⁻⁴ |
| 3-hour | South at State Route 240 | 1.12×10 ⁻⁴ | 2,000 meters south at boundary | 1.05×10 ⁻⁴ |
| 8-hour | Southwest at State Route 240 | 5.24×10 ⁻⁵ | South at State Route 240 | 4.49×10 ⁻⁵ |
| 24-hour | South boundary | 2.41×10 ⁻⁵ | Southwest at State Route 240 | 1.87×10 ⁻⁵ |
| Annual | Northwest boundary | 1.7×10 ⁻⁷ | 3,900 meters northwest of boundary | 7.83×10 ⁻⁸ |
| Source Group 200-East and 200-West Area Emissions – Area Source (200EW)^b | | | | |
| 1-hour | 2,000 meters west of west boundary | 1.33×10 ⁻⁴ | 2,000 meters west of boundary | 1.22×10 ⁻⁴ |
| 3-hour | West boundary | 5.08×10 ⁻⁵ | West boundary | 4.13×10 ⁻⁵ |
| 8-hour | Southwest at State Route 240 | 3.48×10 ⁻⁵ | 2,200 meters west at State Route 240 | 1.95×10 ⁻⁵ |
| 24-hour | South at State Route 240 | 1.49×10 ⁻⁵ | South at State Route 240 | 8.43×10 ⁻⁶ |
| Annual | Southeast boundary | 1.68×10 ⁻⁷ | 3,900 meters northwest of boundary | 6.23×10 ⁻⁶ |

Draft Tank Closure and Waste Management Environmental Impact Statement for the
Hanford Site, Richland, Washington

**Table G-3. Locations and Corresponding Dispersion Factors for
Maximum Air Quality Impacts at the Hanford Site (continued)**

| Averaging Time | 24-Hour-per-Day Activity | | 12-Hour-per-Day Activity | |
|---|---|---|---|---|
| | Maximum-Impact Location | Unit Dispersion Factor for Maximum-Impact Location ^a (s/m ³) | Maximum-Impact Location | Unit Dispersion Factor for Maximum-Impact Location ^a (s/m ³) |
| Source Group 200-East, 200-West, and Waste Treatment Plant Area Emissions – Area Source (200EW+)^c | | | | |
| 1-hour | West boundary | 2.03×10 ⁻⁴ | West boundary | 1.86×10 ⁻⁴ |
| 3-hour | South at State Route 240 | 8.1×10 ⁻⁵ | South at State Route 240 | 6.78×10 ⁻⁵ |
| 8-hour | 1,500 meters south at State Route 240 | 5.26×10 ⁻⁵ | West boundary | 3.11×10 ⁻⁵ |
| 24-hour | South at State Route 240 | 2.55×10 ⁻⁵ | South at State Route 240 | 1.21×10 ⁻⁵ |
| Annual | 1,000 meters at southeast site boundary | 3.84×10 ⁻⁷ | 1,000 meters at southeast site boundary | 1.39×10 ⁻⁷ |
| Source Group Area C – Area Source (Area C) | | | | |
| 1-hour | West boundary | 6.07×10 ⁻⁵ | West boundary | 6.07×10 ⁻⁵ |
| 3-hour | South at boundary | 4.61×10 ⁻⁵ | South at boundary | 4.11×10 ⁻⁵ |
| 8-hour | South boundary | 3.28×10 ⁻⁵ | South boundary | 2.49×10 ⁻⁵ |
| 24-hour | South at boundary | 2.31×10 ⁻⁵ | South at boundary | 1.3×10 ⁻⁵ |
| Annual | Southeast at State Route 240 | 8.24×10 ⁻⁸ | Southeast at State Route 240 | 2.97×10 ⁻⁸ |
| Source Group 400 Area – Area Source (400) | | | | |
| 1-hour | 800 meters southwest of south boundary | 2.27×10 ⁻⁴ | 800 meters west of boundary | 2.09×10 ⁻⁴ |
| 3-hour | East at boundary | 8.07×10 ⁻⁵ | 800 meters west of boundary | 6.98×10 ⁻⁵ |
| 8-hour | 700 meters at southwest boundary | 3.78×10 ⁻⁵ | West boundary | 2.91×10 ⁻⁵ |
| 24-hour | South at boundary | 1.72×10 ⁻⁵ | South at boundary | 1.14×10 ⁻⁵ |
| Annual | 1,000 meters at southeast boundary | 4.77×10 ⁻⁷ | Southeast boundary | 1.66×10 ⁻⁷ |

^a Values are computed by the AERMOD model. The emission rate for an activity can be estimated by dividing the annual emission rate (see Section G.2) by the hours of operation per year (see Sections G.2.1 and G.2.2). To convert to a concentration estimate (micrograms per cubic meter), the unit dispersion factor (seconds per cubic meter) is multiplied by the actual pollutant release rate (micrograms per second).

^b Source Group 200EW includes certain activities occurring at both the 200-East and 200-West Areas.

^c Source Group 200EW+ includes certain generic activities assumed to occur at the 200-East and 200-West Areas and the Waste Treatment Plant area.

Note: To convert meters to feet, multiply by 3.281.

Key: s/m³=seconds per cubic meter.

The dispersion factors for construction at the MFC at INL are shown in Table G-4 for a receptor at the site boundary.

Table G-4. Dispersion Factors for Maximum Air Quality Impacts of Construction at the Idaho National Laboratory Materials and Fuels Complex

| Averaging Time | Dispersion Factor (seconds per cubic meter) ^a |
|----------------|--|
| 1-hour | 5.65×10^{-5} |
| 3-hour | 5.08×10^{-5} |
| 8-hour | 3.95×10^{-5} |
| 24-hour | 2.26×10^{-5} |
| Annual | 4.52×10^{-6} |

^a Estimates for 3-hour through annual averaging periods were derived based on the 1-hour dispersion factor, using factors provided by the U.S. Environmental Protection Agency for screening analyses (EPA 1992).

The dispersion factors for the maximally exposed noninvolved onsite worker from sources in each source group are reflected in Table G-5.

Table G-5. Annual Dispersion Factors for Maximally Exposed Noninvolved Workers on the Hanford Site

| Source Location/Source Group | 24-Hour-per-Day Activity | 12-Hour-per-Day Activity |
|------------------------------|---------------------------|--------------------------|
| | (seconds per cubic meter) | |
| 200E | 7.09×10^{-6} | 2.22×10^{-6} |
| 200W | 4.06×10^{-6} | 1.1×10^{-6} |
| WTP_AS | 4.03×10^{-6} | 1.7×10^{-6} |
| WTP_PS | 2.79×10^{-7} | 1.77×10^{-7} |
| SUPW | 9.23×10^{-6} | 2.08×10^{-6} |
| 200EW | 7.37×10^{-6} | 2.27×10^{-6} |
| 200EW+ | 1.11×10^{-5} | 3.87×10^{-6} |
| Area C | 5.27×10^{-8} | 1.89×10^{-8} |
| 400 Area | 3.42×10^{-7} | 1.45×10^{-7} |

Note: Values are computed by the AERMOD model. To convert to a concentration estimate (micrograms per cubic meter), the unit dispersion factor (seconds per cubic meter) is multiplied by the actual pollutant release rate (micrograms per second).

Key: 200E=200-East Area; 200W=200-West Area; 200EW=200-East and 200-West Areas; 200EW+=200-East and 200-West Areas and Waste Treatment Plant area; SUPW=200-West Area supplemental treatment facility; WTP_AS=Waste Treatment Plant area source; WTP_PS=Waste Treatment Plant point source.

G.2 EMISSIONS

Emission estimates are based on data reports prepared for this TC & WM EIS, and their scaling is based on the activities to be performed under each of the alternatives evaluated in this environmental impact statement (EIS) (SAIC 2007a, 2007b, 2007c). The data sets provide information on the source of emission factors used in making the emission estimates. This information is summarized below and in Table G-6. Emissions that would be associated with long-term tank farm administrative control are based on recent tank farm emissions, as summarized in Table G-7. Emissions for employee vehicles are presented in Table G-8. The schedules of various activities evaluated for each alternative are presented in Chapter 2, Section 2.5, of this EIS. Provided in Tables G-9 through G-62 are the estimates of criteria and toxic pollutant emissions under each alternative by general type of activity: decommissioning, construction, operations, deactivation, and closure. These emissions include sources at the construction site, including construction equipment, or operations area and, in most cases, do not include emissions from local or regional vehicular activity that results from shipping of materials or employee vehicles (see Section G.2.4). The same emission factors were used for both mobile and stationary fuel-burning sources, except employee vehicles. Emissions of potential stratospheric ozone-depleting compounds such as chlorofluorocarbons were not evaluated, as no emissions of these pollutants were identified in the data reports.

Table G-6. Representative Nonradiological Air Pollutant Emission Factors

| Pollutant | Factor | Unit ^a | Source |
|---|--|--|----------------------|
| Fuel Burning – Gasoline Fuel-Fired^b | | | |
| Carbon monoxide | 2.7×10^4 (62.7) | Nanograms per joule (pounds per million Btu) | EPA 1996:Table 3.3-1 |
| Nitrogen dioxide | 7.01×10^2 (1.63) | Nanograms per joule (pounds per million Btu) | EPA 1996:Table 3.3-1 |
| Particulate matter (PM ₁₀) | 4.3×10^1 (0.1) | Nanograms per joule (pounds per million Btu) | EPA 1996:Table 3.3-1 |
| Sulfur dioxide | 3.61×10^1 (0.084) | Nanograms per joule (pounds per million Btu) | EPA 1996:Table 3.3-1 |
| Carbon dioxide | 6.62×10^4 (154) | Nanograms per joule (pounds per million Btu) | EPA 1996:Table 3.3-1 |
| Ammonia | 7.55×10^1 (6.3×10^{-1}) | Grams per kiloliter burned (pounds per 1,000 gallons burned) | EPA 2003a |
| Benzene | 1.55×10^{-2} (5.51×10^{-5}) | Grams per kilometer traveled (pounds per vehicle-mile traveled) | EPA 2003a |
| Toluene | 2.38×10^{-1} (8.46×10^{-4}) | Grams per kilometer traveled (pounds per vehicle-mile traveled) | EPA 2003a |
| Xylene | 6.74×10^{-2} (2.39×10^{-4}) | Grams per kilometer traveled (pounds per vehicle-mile traveled) | EPA 2003a |
| 1,3-Butadiene | 8.71×10^{-5} (3.09×10^{-7}) | Grams per kilometer traveled (pounds per vehicle-mile traveled) | EPA 2003a |
| Formaldehyde | 5.24×10^{-3} (1.86×10^{-5}) | Grams per kilometer traveled (pounds per vehicle-mile traveled) | EPA 2003a |
| Total organic compounds | 1.30×10^3 (3.03) | Nanograms per joule (pounds per million Btu) | EPA 1996:Table 3.3-1 |

Table G–6. Representative Nonradiological Air Pollutant Emission Factors (continued)

| Pollutant | Factor | Unit ^a | Source |
|--|---|---|---------------------------|
| Fuel Burning – Diesel Fuel-Fired^b | | | |
| Carbon monoxide | 4.09×10 ² (0.95) | Nanograms per joule (pounds per million Btu) | EPA 1996:Table 3.3-1 |
| Nitrogen dioxide | 1.9×10 ³ (4.41) | Nanograms per joule (pounds per million Btu) | EPA 1996:Table 3.3-1 |
| Particulate matter (PM ₁₀) | 1.33×10 ² (0.31) | Nanograms per joule (pounds per million Btu) | EPA 1996:Table 3.3-1 |
| Sulfur dioxide ^c | 6.54×10 ⁻¹ (1.5×10 ⁻³) | Nanograms per joule (pounds per million Btu) | EPA 1996:Table 3.3-1 |
| Carbon dioxide | 7.05×10 ⁴ (164) | Nanograms per joule (pounds per million Btu) | EPA 1996:Table 3.3-1 |
| Ammonia | 1.14×10 ² (9.5×10 ⁻¹) | Grams per kiloliter burned (pounds per 1,000 gallons burned) | EPA 2003a |
| Benzene | 4.01×10 ⁻¹ (9.33×10 ⁻⁴) | Nanograms per joule (pounds per million Btu) | EPA 1996:Table 3.3-2 |
| 1,3-Butadiene | 1.68×10 ⁻² (3.9×10 ⁻⁵) | Nanograms per joule (pounds per million Btu) | EPA 1996:Table 3.3-2 |
| Formaldehyde | 5.07×10 ⁻¹ (1.18×10 ⁻³) | Nanograms per joule (pounds per million Btu) | EPA 1996:Table 3.3-2 |
| Toluene | 1.76×10 ⁻¹ (4.09×10 ⁻⁴) | Nanograms per joule (pounds per million Btu) | EPA 1996:Table 3.3-2 |
| Xylene | 1.22×10 ⁻¹ (2.85×10 ⁻⁴) | Nanograms per joule (pounds per million Btu) | EPA 1996:Table 3.3-2 |
| Total organic compounds | 1.55×10 ² (0.36) | Nanograms per joule (pounds per million Btu) | EPA 1996:Table 3.3-1 |
| Construction | | | |
| Particulate matter (total suspended particulates) | 2.69 (1.2) | Metric tons per hectare per month (tons per acre per month) | EPA 1996:Section 13.2.3.3 |
| Road Travel | | | |
| Particulate matter (PM ₁₀) – paved | 235 (0.83) | Grams per kilometer (pounds per mile) | Slaathaug 1995:Appendix F |
| Particulate matter (PM ₁₀) – unpaved | 659 (2.34) | Grams per kilometer (pounds per mile) | Slaathaug 1995:Appendix F |
| Glass Manufacture (Surrogate for Waste Treatment Plant Melter and Bulk Vitrification) | | | |
| Carbon monoxide | 9.98×10 ¹ (0.22) | Grams per metric ton of glass (pounds per metric ton of glass [with low-energy scrubber]) | EPA 1996:Table 11.15-1, 5 |
| Nitrogen dioxide | 3.1×10 ³ (6.83) | Grams per metric ton of glass (pounds per metric ton of glass [with low-energy scrubber]) | EPA 1996:Table 11.15-1, 4 |
| Particulate matter (PM ₁₀) | 3.5×10 ² (0.772) | Grams per metric ton of glass (pounds per metric ton of glass [with low-energy scrubber]) | EPA 1996:Table 11.15-1, 2 |
| Sulfur dioxide | 8.48×10 ² (1.87) | Grams per metric ton of glass (pounds per metric ton of glass [with low-energy scrubber]) | EPA 1996:Table 11.15-1, 3 |

Draft Tank Closure and Waste Management Environmental Impact Statement for the
Hanford Site, Richland, Washington

Table G–6. Representative Nonradiological Air Pollutant Emission Factors (continued)

| Pollutant | Factor | Unit ^a | Source |
|---|--------------------|--|-------------------------------|
| Concrete Batching (Surrogate for Cast Stone and Sulfate Removal) | | | |
| Particulate matter (PM ₁₀) | 8.31 (0.014) | Grams per cubic meter produced (pounds per cubic yard [controlled with truck mix loading]) | EPA 1996:Table 11.12-3 |
| Flash Calcination and THOR Data (for Steam Reforming) | | | |
| Carbon monoxide | 0.0893 (0.0893) | Kilograms per kilogram processed (tons per ton processed) | CEES 2006a: Attachment 3:9 |
| Nitrogen dioxide | 0.0253 (0.0253) | Kilograms per kilogram processed (tons per ton processed) | CEES 2006a, Attachment 3:9 |
| Particulate matter (PM ₁₀) | 0.017 (0.034) | Kilograms per megagram processed (pounds per ton [flash calciner with fabric filter]) | EPA 1996: Table 11.16-2 |
| Carbon dioxide | 0.678 (0.678) | Kilograms per kilogram processed (tons per ton processed) | CEES 2006a: Attachment 3:9 |

^a Fuel-use data are summarized in Table E–60.

^b The same emission factors were used for construction equipment, mobile equipment, and stationary fuel-burning sources, except employee vehicles and sources for which factors are provided below.

^c Percent sulfur in diesel fuel was adjusted to 0.0015 percent from 0.3 percent to reflect the current sulfur content of fuel.

Key: Btu=British thermalunit; THOR=THOR Treatment Technologies, LLC; PM₁₀=particulate matter with an aerodynamic diameter less than or equal to 10 micrometers; tons=short tons.

**Table G–7. Nonradiological Air Emissions from the 200 Area Tank Farms
at the Hanford Site**

| Pollutant | Emissions (metric tons per year) | | | |
|---|----------------------------------|---------------|--------------------|---------------|
| | Calendar Year 2001 | | Calendar Year 2002 | |
| | 200-East Area | 200-West Area | 200-East Area | 200-West Area |
| Carbon monoxide | 10 | 3.6 | 10 | 3.6 |
| Nitrogen dioxide | 6.4 | 9.1 | 0.18 | 0.27 |
| Particulate matter ^a | 0 | 0 | 0 | 0 |
| Sulfur dioxide ^b | 0 | 0 | 0 | 0 |
| Volatile organic compounds ^c | 3.2 | 1.8 | 3.6 | 1.8 |
| Ammonia | 6.4 | 5.4 | 6.4 | 5.4 |
| Other toxics ^d | 1.8 | 0.64 | 1.8 | 0.64 |

^a Particulate matter emissions were not reported.

^b Sulfur dioxide emissions were reported as zero.

^c Volatile organic compounds emitted from tank and tank ventilation systems include, but are not limited to, acetaldehyde, acetonitrile, benzene, cyclohexane, methyl-cyclohexane, ethanol, heptane, hexane, octane, and propane (DOE 2003).

^d Other toxics emitted from tank and tank ventilation systems include, but are not limited to, 1,3-butadiene, 1,4-dioxane, acetaldehyde, acetonitrile, benzene, formaldehyde, hexane, methanol, and nitrous oxide (DOE 2003).

Note: Emissions represent 177 tanks in the 200-East and 200-West Areas.

Source: Fluor Hanford 2002, 2003.

Emission rates were calculated for each activity or facility, compiled, and processed for use in the dispersion modeling. Specific assumptions for each alternative are documented in the project calculation data sheets and in the scaled workbooks for each alternative. Emission rates for each facility were determined by summing the emission rates for various sources related to that facility and phase of activity.

Numerous nonradiological toxic air pollutants could be present in emissions from construction equipment, other fuel-burning sources, and process sources. These include constituents such as benzene, toluene, xylene, propylene, formaldehyde, acetaldehyde, acrolein, and trace metals. Fuel-burning sources emit various organic compounds that may be listed as total organic compounds or VOCs, the latter category excluding the semivolatile and condensable organic compounds such as methane (EPA 1996). Typically, however, rather few substances account for most of the risk. DOE selected for detailed analysis seven toxic constituents—benzene, toluene, xylene, ammonia, 1,3-butadiene, formaldehyde, and mercury—that are representative contributors to risk from fuel-burning and process sources and constituents for which there is a Washington State acceptable source impact level. On the basis of a comparison of fuel use for each activity, DOE limited the number of activities for which detailed emissions and pollutant concentrations were calculated. Ammonia was also selected for modeling because its concentration is higher than that of other toxic constituents in tank vapor spaces. This, combined with ammonia's toxicity, made it a good choice as an indicator constituent that would bound the analysis; that is, if ammonia were found not to be in excess of the acceptable source impact level, then the same could be inferred for other toxics. Mercury was evaluated to address potential emissions from the tank waste treatment process. Also evaluated were emissions of carbon monoxide, nitrogen oxides, and ammonia from routine tank farm operations.

G.2.1 Construction Emissions

Included in calculations of overall onsite nonradiological emissions were fuel use and fugitive dust emissions related to construction activities. Mobile vehicle emissions related to the delivery of equipment and supplies to the site were calculated separately in connection with construction of major facilities (see Tables G-63 through G-112). These mobile vehicle emission calculations represent local and regional vehicular emissions; some are included in the onsite activity emission calculations in the facility emission tables (Tables G-9 through G-62). Other mobile emissions that occur at the activity areas, such as those from construction equipment, are also included in the facility emission tables. The same emission factors were used for both mobile and stationary fuel-burning sources, except employee vehicles (see Section G.2.4). Many of the closure activities are also construction-type activities, and thus emissions were also calculated by the methods used for construction-related emissions.

The emissions related to fuel use were calculated by multiplying the quantity of diesel and gasoline fuel by emission factors derived from the EPA compilation of air pollutant emission factors for stationary point and area sources (EPA 1996) and from other EPA sources. These emission factors are summarized in Table G-6.

The sulfur dioxide emission factor for diesel fuel-burning sources was adjusted from the factor provided by EPA (EPA 1996), which is based on 0.3 percent (3,000 parts per million) sulfur in fuel, to a factor based on the current, more-restrictive limit of 0.0015 percent (15 parts per million). No adjustment was made in the emission rates for nitrogen dioxide and particulate matter based on the more-restrictive emission standards for trucks for these air pollutants effective beginning in 2007.

For the purpose of this analysis, emissions of PM₁₀ and PM_{2.5} from activities were assumed to be the same. Therefore, the concentrations estimated would also be the same, and PM_{2.5} concentrations are not shown separately.

Fugitive dust emissions were calculated from an emission factor (EPA 1996) for general construction activity, which gives an estimate of emissions in metric tons per month per hectares disturbed. This factor is very conservative in that it overestimates fugitive dust emissions from general construction activity on a site, but it is useful for estimating emissions when more-detailed information on a construction activity is not available. Moreover, because the factor is for total suspended particulates,

rather than PM₁₀, it results in an overestimate of fugitive emissions of PM₁₀ by a factor of about 2.5. This emission factor was used with the total duration and the total area of land disturbance for each construction activity, and the emission calculations for construction assumed no application of controls to reduce emissions. Many of the construction-type activities that have large emissions of particulate matter occur over large areas. Because it is unlikely that the total area would be actively disturbed by equipment and exposed to wind erosion at any one time, the emissions of particulate matter have likely been overestimated. For example, the modified Resource Conservation and Recovery Act (RCRA) Subtitle C barrier would be constructed over an 84.2-hectare (208-acre) area over a period of 7 years. It is likely that a fraction of this area would be actively under construction at any one time, resulting in much-smaller emissions than estimated.

The onsite travel emission calculations were based in part on an estimate of fuel use developed from the number of loads and mileage. The fuel use emission factors were the same as those used in operations emission calculations. Calculations of road dust emissions were based on assumptions of the portions of travel on unpaved and paved roads. The emission calculations for travel also assumed no application of controls to reduce emissions.

Construction, deactivation, and closure activities would be conducted using appropriate dust suppression techniques compliant with Washington State emission control requirements. Dust control measures could include using soil binders and watering, applying rock to or paving roads, covering loads on trucks used for moving rocks and soil, and halting earthmoving and other activities when windspeed is projected to exceed the threshold for substantial dust generation. These measures were not considered in the emission estimates used in the modeling of these activities. Therefore, the concentrations estimated for these activities are higher than would likely occur.

For the purpose of modeling, construction emissions were averaged over 2,080 hours per year.

G.2.2 Operations Emissions

Two contributors to overall nonradiological operations emissions were calculated: fuel use (for diesel generators and boilers, for example) and process emissions. Vehicular emissions related to the transport of equipment and supplies to the site were calculated separately for the major facilities, as reflected in Tables G-63 through G-112. These emission calculations represent local and regional vehicular emissions; some are included in the onsite activity emission calculations in the facility emission tables (Tables G-9 through G-62). Other mobile emissions that occur at the activity areas, such as those from construction equipment, are also included in the facility emission tables. Calculations of operations emissions related to fuel use and travel were performed in the same manner as those for construction, except for employee vehicles (see Section G.2.4).

For treatment operations such as those of the WTP, Sulfate Removal Facility, Bulk Vitrification Facilities, and Cast Stone Facilities, a surrogate manufacturing process was identified. For the WTP, for example, glass manufacturing was identified as a surrogate process, and, as shown in Table G-6, EPA air pollutant emission factors (EPA 1996) were used. The use of surrogate processes introduces some uncertainty to the calculations. For example, the glass-manufacturing emission factor was for soda lime glass rather than for the borosilicate glass that would be produced at the WTP. This should have minimal effect on the emission estimates, however, as most of the constituents of potential concern are not substantially affected by the chemical composition of the glass.

For the purpose of analysis it was assumed that the entire mercury inventory would be released to the air through the stacks from the WTP, bulk vitrification, and steam reforming processes (CEES 2006b: Attachment 4: A4-2; 2006c: Attachment 4: A4-2, 2007: Attachment 4: A4-2).

Control technologies were applied to the process emissions for each constituent of potential concern. Credit for only one control technology was taken for each constituent. With respect to operations, control technologies were applied to fuel-burning sources for the treatment and supplemental treatment technologies.

Deactivation emissions were calculated assuming 10 percent of the annual emission rates during operations. Although only a small percentage of the facility inventory would remain at the end of operations (e.g., 1 percent for the WTP), cleanout of systems during deactivation would involve operation in off-normal modes, increasing the potential for discharge, so the more-conservative 10 percent was assumed.

For the purpose of modeling, operations emissions were averaged over 2,080 hours per year except for certain sources, for which hours per year were based on operating efficiencies. Operating hours per year assumed for these sources are as follows: 6,250 for the WTP, Immobilized Low-Activity Waste Interim Storage Facilities, Cesium and Strontium Capsule Processing Facility, and Preprocessing Facility; 5,260 for the Bulk Vitrification and Cast Stone Facilities; 6,132 for the Sulfate Removal Facility; 4,380 for the Transuranic Waste Interim Storage Facility; and 7,300 for the High-Level Radioactive Waste Debris Storage Facility. Emissions from routine operations, the Effluent Treatment Facility, and steam reforming were averaged over 8,760 hours per year. Almost all activities associated with the FFTF Decommissioning alternatives were averaged over 2,080 hours per year; the exceptions, associated with the Hanford Sodium Reaction Facility and INL Sodium Processing Facility, were averaged over 8,760 hours per year. Waste management activities were averaged over 2,080 hours per year.

G.2.3 Tank Emissions

Nonradiological air emissions from the 200-East and 200-West Area tank farms, shown in Table G-7 for calendar years 2001 and 2002, were used as the basis for calculating tank farm emissions from the routine operations and administrative control activities (Fluor Hanford 2002, 2003).

G.2.4 Employee Vehicle Emissions

In addition to vehicle emissions from trucks moving materials and equipment to and on the site during various phases of activity, employee vehicles making daily commuter trips to the site would contribute to air pollutant emissions in the Hanford region. Emissions from employee vehicles under each alternative's peak activity period were estimated using an estimate of average vehicle emission rates calculated with EPA's MOBILE6 vehicle emission model (EPA 2003b) and the peak-year vehicle trips presented in the socioeconomics sections of Chapter 4. These emissions were not included when calculating pollutant concentrations, but are discussed here for information purposes. Emission rates were calculated for carbon monoxide, VOCs, particulate matter, and nitrogen oxides on the basis of a vehicle mix for calendar year 2007. Emissions are presented by alternative in Table G-8. Vehicle emission rates over the periods of the alternatives considered are expected to decrease as vehicles become more efficient, emissions are better controlled, and possibly other vehicle technologies are implemented.

Peak-year emissions from employee vehicles under the various Tank Closure alternatives would range from 343 to 2,030 metric tons per year of carbon monoxide, respectively, under Tank Closure Alternatives 1 and 6B, Option Case, and from 46.5 to 246 metric tons per year of nitrogen oxides, respectively, under those same alternatives. These emissions represent between 0.4 and 5 percent of the total calendar year 2002 four-county, on-road vehicle emissions in Benton, Franklin, Adams, and Grant Counties (EPA 2007a).

Peak-year emissions from employee vehicles under FFTF Decommissioning alternatives would range from 0.25 to 16.8 metric tons per year of carbon monoxide, respectively, under FFTF Decommissioning

**Draft Tank Closure and Waste Management Environmental Impact Statement for the
Hanford Site, Richland, Washington**

Alternatives 1 and 3 (facility disposition) and from 0.03 to 2.05 metric tons per year of nitrogen dioxide, respectively, under those same alternatives. These emissions represent less than 0.02 percent of the total calendar year 2002 four-county, on-road vehicle emissions in Benton, Franklin, Adams, and Grant counties. Peak-year emissions under Waste Management alternatives would range from 21.8 to 89 metric tons per year of carbon monoxide and from 2.6 to 10.8 metric tons per year of nitrogen dioxide. The highest emissions would occur under Waste Management Alternative 2, Disposal Groups 2 and 3, and would be less than 2 percent of the total calendar year 2002 four-county, on-road vehicle emissions in Benton, Franklin, Adams, and Grant counties (EPA 2007a).

Table G-8. Peak-Year Employee Vehicle Emissions by Alternative

| Alternative | Period | Total Vehicles | Kilometers Traveled | VOCs (metric tons/year) | Carbon Monoxide (metric tons/year) | Nitrogen Dioxide (metric tons/year) | PM _{2.5} (metric tons/year) | PM ₁₀ (metric tons/year) |
|--|-----------|----------------|---------------------|-------------------------|------------------------------------|-------------------------------------|--------------------------------------|-------------------------------------|
| Tank Closure (TC) | | | | | | | | |
| TC Alternative 1 | 2006–2107 | 1,387 | 36,700,000 | 25.4 | 343.0 | 41.5 | 0.8 | 1.2 |
| TC Alternative 2A | 2006–2193 | 3,996 | 106,000,000 | 73.2 | 988.0 | 120.0 | 2.3 | 3.4 |
| TC Alternative 2B | 2006–2145 | 5,489 | 145,000,000 | 101.0 | 1,360.0 | 164.0 | 3.1 | 4.7 |
| TC Alternative 3A | 2006–2141 | 4,266 | 113,000,000 | 78.2 | 1,050.0 | 128.0 | 2.4 | 3.6 |
| TC Alternative 3B | 2006–2141 | 4,206 | 111,000,000 | 77.1 | 1,040.0 | 126.0 | 2.4 | 3.6 |
| TC Alternative 3C | 2006–2141 | 4,368 | 116,000,000 | 80.0 | 1,080.0 | 131.0 | 2.5 | 3.7 |
| TC Alternative 4 | 2006–2144 | 6,398 | 169,000,000 | 117.0 | 1,580.0 | 192.0 | 3.7 | 5.4 |
| TC Alternative 5 | 2006–2139 | 4,876 | 129,000,000 | 89.3 | 1,210.0 | 146.0 | 2.8 | 4.1 |
| TC Alternative 6A, Base Case | 2006–2262 | 6,804 | 180,000,000 | 125.0 | 1,680.0 | 203.0 | 3.9 | 5.8 |
| TC Alternative 6A, Option Case | 2006–2262 | 7,020 | 186,000,000 | 129.0 | 1,740.0 | 210.0 | 4.0 | 6.0 |
| TC Alternative 6B, Base Case | 2006–2201 | 6,293 | 167,000,000 | 115.0 | 1,560.0 | 188.0 | 3.6 | 5.4 |
| TC Alternative 6B, Option Case | 2006–2101 | 8,204 | 217,000,000 | 150.0 | 2,030.0 | 246.0 | 4.7 | 7.0 |
| TC Alternative 6C | 2006–2145 | 5,498 | 146,000,000 | 101.0 | 1,360.0 | 165.0 | 3.2 | 4.7 |
| FFTF Decommissioning | | | | | | | | |
| FFTF Decommissioning Alternative 1 | 2008–2107 | 1 | 26,500 | 0.02 | 0.25 | 0.03 | 0.00 | 0.00 |
| FFTF Decommissioning Alternative 2, Facility Disposition | 2021 | 40 | 1,060,000 | 0.73 | 9.89 | 1.20 | 0.02 | 0.03 |
| FFTF Decommissioning Alternative 2, Disposition of Bulk Sodium | 2017 | 52 | 1,380,000 | 0.95 | 12.90 | 1.56 | 0.03 | 0.04 |
| FFTF Decommissioning Alternative 2, Disposition of Remote-Handled Special Components | 2015–2016 | 43 | 1,140,000 | 0.79 | 10.60 | 1.29 | 0.02 | 0.04 |
| FFTF Decommissioning Alternative 3, Facility Disposition | 2013–2014 | 68 | 1,800,000 | 1.25 | 16.80 | 2.04 | 0.04 | 0.06 |
| FFTF Decommissioning Alternative 3, Disposition of Bulk Sodium | 2017 | 52 | 1,380,000 | 0.95 | 12.90 | 1.56 | 0.03 | 0.04 |
| FFTF Decommissioning Alternative 3, Disposition of Remote-Handled Special Components | 2015–2016 | 43 | 1,140,000 | 0.79 | 10.60 | 1.29 | 0.02 | 0.04 |

Table G-8. Peak-Year Employee Vehicle Emissions by Alternative (continued)

| Alternative | Period | Total Vehicles | Kilometers Traveled | VOCs (metric tons/year) | Carbon Monoxide (metric tons/year) | Nitrogen Dioxide (metric tons/year) | PM _{2.5} (metric tons/year) | PM ₁₀ (metric tons/year) |
|------------------------------------|-----------|----------------|---------------------|-------------------------|------------------------------------|-------------------------------------|--------------------------------------|-------------------------------------|
| Waste Management (WM) | | | | | | | | |
| WM Alternative 1 | 2009 | 88 | 2,330,000 | 1.6 | 21.8 | 2.6 | 0.1 | 0.1 |
| WM Alternative 2 | 2019–2050 | 360 | 9,530,000 | 6.6 | 89.0 | 10.8 | 0.2 | 0.3 |
| WM Alternative 2, Disposal Group 1 | 2051–2052 | 943 | 25,000,000 | 17.3 | 233.0 | 28.2 | 0.5 | 0.8 |
| WM Alternative 2, Disposal Group 2 | 2101–2102 | 3,636 | 96,300,000 | 66.6 | 899.0 | 109.0 | 2.1 | 3.1 |
| WM Alternative 2, Disposal Group 3 | 2166–2167 | 3,636 | 96,300,000 | 66.6 | 899.0 | 109.0 | 2.1 | 3.1 |
| WM Alternative 3 | 2019–2050 | 360 | 9,530,000 | 6.6 | 89.0 | 10.8 | 0.2 | 0.3 |
| WM Alternative 3, Disposal Group 1 | 2051–2052 | 940 | 24,900,000 | 17.2 | 232.0 | 28.1 | 0.5 | 0.8 |
| WM Alternative 3, Disposal Group 2 | 2101–2102 | 3,603 | 95,400,000 | 66.0 | 891.0 | 108.0 | 2.1 | 3.1 |
| WM Alternative 3, Disposal Group 3 | 2166–2167 | 3,602 | 95,400,000 | 66.0 | 891.0 | 108.0 | 2.1 | 3.1 |

Note:

The calculations assumed 260 days a year per employee, 8-hour days, 5 days per week, 2,080 hours per year.

Assumed 11 percent of vehicles come from the west, an average distance of 45 miles (from Yakima).

Assumed 89 percent of vehicles come from the east, an average distance of 30 miles (midway between Richland and Pasco).

For the purpose of comparison, the most recent available data show total combined vehicular emissions for the four counties (Adams, Benton, Franklin, and Grant) as 10,011 metric tons of VOCs; 119,747 of carbon monoxide; 11,616 of nitrogen dioxide; 194 of PM_{2.5}; and 259 of PM₁₀. Heavy-duty vehicles were included in the averages (EPA 2007a).

Emission factors calculated using the MOBILE6 emission factor model were 0.692 grams of VOCs per kilometer; 9.33 grams of carbon monoxide per kilometer; 1.13 grams of nitrogen dioxide per kilometer; 0.0216 grams of PM_{2.5} per kilometer; and 0.0321 grams of PM₁₀ per kilometer.

Key: FFTF=Fast Flux Test Facility; PM_{2.5}=particulate matter with an aerodynamic diameter less than or equal to 2.5 micrometers; PM₁₀=particulate matter with an aerodynamic diameter less than or equal to 10 micrometers; VOC=volatile organic compound.

Table G-9. Tank Closure Alternative 1 Criteria Pollutant Emissions

| Facility/System | Start Year | End Year | Location | Emission Rate (metric tons per year) | | | | |
|-------------------------------|------------|----------|----------|--------------------------------------|-----------------------|-----------------------|-----------------------|-----------------------|
| | | | | Carbon Monoxide | Nitrogen Dioxide | PM ₁₀ | Sulfur Dioxide | VOCs |
| Construction | | | | | | | | |
| Canister Storage Building | 2006 | 2008 | 200E | 5.54 | 1.28 | 9.05×10 ⁻¹ | 4.02×10 ⁻⁴ | 2.86×10 ⁻¹ |
| Other infrastructure upgrades | 2006 | 2008 | 200EW | 1.11 | 8.05×10 ⁻¹ | 1.13 | 2.54×10 ⁻⁴ | 9.43×10 ⁻² |
| Tank upgrades | 2006 | 2008 | 200EW | 3.49×10 ² | 4.41×10 ¹ | 8.07 | 1.38×10 ⁻² | 1.56×10 ¹ |
| Waste Treatment Plant | 2006 | 2008 | WTP_AS | 7.64×10 ² | 6.20×10 ² | 4.16×10 ² | 1.05 | 7.99×10 ¹ |
| Operations | | | | | | | | |
| Routine operations | 2006 | 2008 | 200EW | 1.36×10 ¹ | 1.55×10 ¹ | a | a | 5.40 |
| Deactivation | | | | | | | | |
| Administrative controls | 2008 | 2107 | 200EW+ | 1.36×10 ¹ | 1.54×10 ¹ | a | a | 5.44 |

^a Emissions for this activity and pollutant were not calculated because annual fuel use for this activity and the resulting emissions would be small compared with those of other activities or would be zero.

Key: 200E=200-East Area; 200EW=200-East and 200-West Areas; 200EW+=200-East and 200-West Areas and Waste Treatment Plant area; WTP_AS=Waste Treatment Plant area source; PM₁₀=particulate matter with an aerodynamic diameter less than or equal to 10 micrometers; VOC=volatile organic compound.

Source: SAIC 2007a, 2008.

Table G-10. Tank Closure Alternative 1 Toxic Pollutant Emissions

| Facility/System | Start Year | End Year | Location | Emission Rate (metric tons per year) | | | | | | |
|-------------------------------|------------|----------|----------|--------------------------------------|-----------------------|-----------------------|-----------------------|---------|---------|-----------------------|
| | | | | Ammonia | Benzene | 1,3-Butadiene | Formaldehyde | Mercury | Toluene | Xylene |
| Construction | | | | | | | | | | |
| Canister Storage Building | 2006 | 2008 | 200E | a | a | a | a | a | a | a |
| Other infrastructure upgrades | 2006 | 2008 | 200EW | a | a | a | a | a | a | a |
| Tank upgrades | 2006 | 2008 | 200EW | 7.82×10 ⁻² | a | a | a | a | a | a |
| Waste Treatment Plant | 2006 | 2008 | WTP_AS | 9.98×10 ⁻¹ | 2.09×10 ⁻¹ | 5.81×10 ⁻³ | 1.89×10 ⁻¹ | a | 1.31 | 3.93×10 ⁻¹ |
| Operations | | | | | | | | | | |
| Routine operations | 2006 | 2008 | 200EW | 1.18×10 ¹ | a | a | a | a | a | a |
| Deactivation | | | | | | | | | | |
| Administrative controls | 2008 | 2107 | 200EW+ | 1.18×10 ¹ | a | a | a | a | a | a |

^a Emissions for this activity and pollutant were not calculated because annual fuel use for this activity and the resulting emissions would be small compared with those of other activities or would be zero.

Key: 200E=200-East Area; 200EW=200-East and 200-West Areas; 200EW+=200-East and 200-West Areas and Waste Treatment Plant area; WTP_AS=Waste Treatment Plant area source.

Source: SAIC 2007a, 2008.

Table G–11. Tank Closure Alternative 2A Criteria Pollutant Emissions

| Facility/System | Start Year | End Year | Location | Emission Rate (metric tons per year) | | | | |
|--|------------|----------|----------|--------------------------------------|-----------------------|-----------------------|-----------------------|-----------------------|
| | | | | Carbon Monoxide | Nitrogen Dioxide | PM ₁₀ | Sulfur Dioxide | VOCs |
| Construction | | | | | | | | |
| Underground transfer lines | 2009 | 2009 | 200EW+ | 7.59×10 ¹ | 2.71×10 ¹ | 2.41×10 ¹ | 8.75×10 ⁻³ | 4.47 |
| Canister Storage Building | 2006 | 2016 | 200E | 5.54 | 1.28 | 9.05×10 ⁻¹ | 4.02×10 ⁻⁴ | 2.86×10 ⁻¹ |
| IHLW Shipping/Transfer Facility | 2011 | 2013 | 200E | 5.68×10 ¹ | 6.72×10 ¹ | 9.81×10 ¹ | 2.18×10 ⁻² | 6.50 |
| IHLW Interim Storage Modules | 2014 | 2019 | 200E | 4.00×10 ¹ | 4.76×10 ¹ | 1.58×10 ² | 1.45×10 ⁻² | 4.34 |
| Other infrastructure upgrades | 2006 | 2034 | WTP_AS | 1.11 | 8.05×10 ⁻¹ | 1.13 | 2.54×10 ⁻⁴ | 9.43×10 ⁻² |
| Tank upgrades | 2006 | 2025 | 200EW | 3.49×10 ² | 4.41×10 ¹ | 8.07 | 1.38×10 ⁻² | 1.56×10 ¹ |
| Waste Treatment Plant | 2006 | 2017 | WTP_AS | 7.64×10 ² | 6.20×10 ² | 4.16×10 ² | 1.05 | 7.99×10 ¹ |
| Cesium and Strontium Capsule Processing Facility | 2088 | 2091 | 200E | 8.41×10 ² | 1.22×10 ² | 1.80×10 ¹ | 1.13 | 4.78×10 ¹ |
| Tank risers | 2013 | 2056 | 200EW | 1.67 | 7.45×10 ⁻¹ | 6.75×10 ⁻² | 1.57×10 ⁻⁴ | 1.88×10 ⁻¹ |
| Modified sluicing retrieval system | 2013 | 2092 | 200EW | 3.31×10 ¹ | 1.28 | 7.07×10 ⁻¹ | 3.06×10 ⁻⁴ | 1.30 |
| Mobile retrieval system | 2013 | 2052 | 200EW | 2.51×10 ¹ | 1.09×10 ¹ | 2.09 | 3.49×10 ⁻³ | 1.66 |
| Vacuum-based retrieval system | 2053 | 2092 | 200EW | 2.17×10 ¹ | 9.81 | 1.97 | 3.13×10 ⁻³ | 1.48 |
| HLW Melter Interim Storage Facility 1 | 2015 | 2016 | WTP_AS | 6.17×10 ⁻¹ | 1.39 | 1.72×10 ¹ | 2.87×10 ⁻⁴ | 6.73×10 ⁻² |
| HLW Melter Interim Storage Facility 2 | 2040 | 2041 | WTP_AS | 6.17×10 ⁻¹ | 1.39 | 1.72×10 ¹ | 2.87×10 ⁻⁴ | 6.73×10 ⁻² |
| HLW Melter Interim Storage Facility 3 | 2065 | 2066 | WTP_AS | 6.17×10 ⁻¹ | 1.39 | 1.72×10 ¹ | 2.87×10 ⁻⁴ | 6.73×10 ⁻² |
| Double-shell tank replacement | 2013 | 2054 | 200EW+ | 3.72×10 ¹ | 3.11×10 ¹ | 1.93×10 ² | 9.19×10 ⁻³ | 3.15 |
| Waste Treatment Plant replacement | 2065 | 2076 | WTP_AS | 1.53×10 ³ | 1.24×10 ³ | 8.32×10 ² | 2.11 | 1.60×10 ² |
| Underground transfer line replacement | 2044 | 2044 | 200EW+ | 7.59×10 ¹ | 2.71×10 ¹ | 2.41×10 ¹ | 8.75×10 ⁻³ | 4.47 |
| Effluent Treatment Facility | 2023 | 2025 | 200E | 1.45×10 ³ | 2.09×10 ² | 9.48×10 ² | 1.96 | 8.25×10 ¹ |
| Effluent Treatment Facility upgrade | 2053 | 2055 | 200E | 1.45×10 ³ | 2.09×10 ² | 9.48×10 ² | 1.96 | 8.25×10 ¹ |
| Evaporator replacement | 2015 | 2017 | 200E | 4.51×10 ² | 6.53×10 ¹ | 1.76×10 ¹ | 6.07×10 ⁻¹ | 2.56×10 ¹ |
| Evaporator upgrade 1 | 2040 | 2042 | 200E | 4.51×10 ² | 6.53×10 ¹ | 1.76×10 ¹ | 6.07×10 ⁻¹ | 2.56×10 ¹ |
| Evaporator upgrade 2 | 2065 | 2067 | 200E | 4.51×10 ² | 6.53×10 ¹ | 1.76×10 ¹ | 6.07×10 ⁻¹ | 2.56×10 ¹ |
| Operations | | | | | | | | |
| IHLW Interim Storage Facility | 2018 | 2092 | WTP_PS | a | a | a | a | a |
| Other infrastructure upgrades | 2006 | 2092 | 200EW | a | a | a | a | a |
| Routine operations | 2006 | 2092 | 200EW | 1.36×10 ¹ | 1.55×10 ¹ | a | a | 5.40 |
| Retrieval operations | 2006 | 2092 | 200EW | 4.72×10 ⁻² | 5.35×10 ⁻² | a | a | 1.89×10 ⁻² |
| Double-shell tank interim stabilization | 2006 | 2092 | 200EW+ | 3.09×10 ⁻¹ | 3.51×10 ⁻¹ | a | a | 1.24×10 ⁻¹ |
| Waste Treatment Plant | 2018 | 2092 | WTP_PS | 1.01×10 ² | 2.18×10 ² | 3.17 | 9.78 | 3.67×10 ² |
| Waste Treatment Plant, cesium and strontium capsules | 2093 | 2093 | WTP_PS | 1.01×10 ² | 2.18×10 ² | 3.17 | 9.78 | 3.67×10 ² |
| Cesium and Strontium Capsule Processing Facility | 2092 | 2093 | WTP_AS | 4.85×10 ¹ | 1.29 | 5.53×10 ¹ | 6.49×10 ⁻² | 2.34 |

Table G-11. Tank Closure Alternative 2A Criteria Pollutant Emissions (continued)

| Facility/System | Start Year | End Year | Location | Emission Rate (metric tons per year) | | | | |
|---|------------|----------|----------|--------------------------------------|-----------------------|-----------------------|-----------------------|-----------------------|
| | | | | Carbon Monoxide | Nitrogen Dioxide | PM ₁₀ | Sulfur Dioxide | VOCs |
| Operations (continued) | | | | | | | | |
| Modified sluicing retrieval system | 2013 | 2092 | 200EW+ | 9.19 | 5.71×10 ⁻¹ | 4.39×10 ⁻² | 1.46×10 ⁻⁴ | 3.95×10 ⁻¹ |
| Mobile retrieval system | 2013 | 2052 | 200EW+ | 1.15×10 ⁻¹ | 1.31×10 ⁻¹ | a | a | 4.61×10 ⁻² |
| Vacuum-based retrieval system | 2053 | 2092 | 200EW | 1.48×10 ⁻¹ | 1.68×10 ⁻¹ | a | a | 5.92×10 ⁻² |
| HLW Melter Interim Storage Facility | 2018 | 2192 | WTP_AS | a | a | a | a | a |
| Effluent Treatment Facility | 2006 | 2095 | WTP_PS | 9.84 | 2.67 | 9.34×10 ² | 1.33×10 ⁻² | 6.48×10 ⁻¹ |
| Evaporator replacement | 2006 | 2093 | 200E | 1.23×10 ¹ | 5.70×10 ¹ | 1.71×10 ¹ | 1.94×10 ⁻² | 4.66 |
| Borrow Area C | 2006 | 2102 | Area C | 8.52×10 ¹ | 1.12×10 ² | 2.30×10 ² | 1.20×10 ⁻¹ | 1.20×10 ¹ |
| Deactivation | | | | | | | | |
| IHLW Interim Storage Facility | 2093 | 2093 | WTP_AS | a | a | a | a | a |
| Waste Treatment Plant | 2078 | 2079 | WTP_AS | 1.01×10 ¹ | 2.18×10 ¹ | 3.17×10 ⁻¹ | 9.78×10 ⁻¹ | 3.67×10 ¹ |
| Modified sluicing retrieval system | 2013 | 2092 | 200EW | 2.36×10 ¹ | 9.95×10 ⁻¹ | 8.78×10 ⁻² | 2.93×10 ⁻⁴ | 9.07×10 ⁻¹ |
| Mobile retrieval system | 2013 | 2052 | 200EW+ | 1.25×10 ¹ | 9.82×10 ⁻¹ | 8.16×10 ⁻² | 3.00×10 ⁻⁴ | 5.17×10 ⁻¹ |
| Vacuum-based retrieval system | 2053 | 2092 | 200EW | 4.73×10 ⁻¹ | 3.71×10 ⁻² | 3.37×10 ⁻³ | 1.13×10 ⁻⁵ | 1.93×10 ⁻² |
| Administrative controls | 2094 | 2193 | 200EW+ | 1.36×10 ¹ | 1.54×10 ¹ | a | a | 5.44 |
| Waste Treatment Plant upgrade | 2094 | 2095 | WTP_AS | 1.01×10 ¹ | 2.18×10 ¹ | 3.17×10 ⁻¹ | 9.78×10 ⁻¹ | 2.11×10 ⁻¹ |
| Cesium and Strontium Capsule Processing Facility | 2094 | 2094 | WTP_AS | 2.24×10 ¹ | 5.96×10 ⁻¹ | 2.55×10 ¹ | 3.00×10 ⁻² | 1.08 |
| Effluent Treatment Facility original | 2026 | 2026 | WTP_AS | 1.09×10 ² | 4.78×10 ¹ | 4.70×10 ² | 1.48×10 ⁻¹ | 8.47 |
| Effluent Treatment Facility replacement 1 | 2056 | 2056 | WTP_AS | 1.66 | 7.70 | 7.07 | 2.62×10 ⁻³ | 6.28×10 ⁻¹ |
| Effluent Treatment Facility replacement 2 | 2096 | 2096 | WTP_AS | 1.66 | 7.70 | 7.07 | 2.62×10 ⁻³ | 6.28×10 ⁻¹ |
| Evaporator original | 2018 | 2018 | 200E | 1.66 | 7.70 | 7.07 | 2.62×10 ⁻³ | 6.28×10 ⁻¹ |
| Evaporator replacement 1 | 2043 | 2043 | 200E | 1.66 | 7.70 | 7.07 | 2.62×10 ⁻³ | 6.28×10 ⁻¹ |
| Evaporator replacement 2 | 2068 | 2068 | 200E | 1.09×10 ² | 4.78×10 ¹ | 4.70×10 ² | 1.48×10 ⁻¹ | 8.47 |
| Evaporator replacement 3 | 2094 | 2094 | 200E | 1.66 | 7.70 | 7.07 | 2.62×10 ⁻³ | 6.28×10 ⁻¹ |
| Closure | | | | | | | | |
| Decontamination and decommissioning of 10 selected facilities | 2018 | 2028 | 200EW | 2.53 | 9.81 | 8.56 | 3.22×10 ⁻³ | 7.93×10 ⁻¹ |

^a Emissions for this activity and pollutant were not calculated because annual fuel use for this activity and the resulting emissions would be small compared with those of other activities or would be zero.

Key: 200E=200-East Area; 200EW=200-East and 200-West Areas; 200EW+=200-East and 200-West Areas and Waste Treatment Plant area; HLW=high-level radioactive waste; IHLW=immobilized high-level radioactive waste; WTP_AS=Waste Treatment Plant area source; WTP_PS=Waste Treatment Plant point source; PM₁₀=particulate matter with an aerodynamic diameter less than or equal to 10 micrometers; VOC=volatile organic compound.

Source: SAIC 2007a, 2008.

Table G-12. Tank Closure Alternative 2A Toxic Pollutant Emissions

| Facility/System | Start Year | End Year | Location | Emission Rate (metric tons per year) | | | | | | |
|--|------------|----------|----------|--------------------------------------|-----------------------|-----------------------|-----------------------|-----------------------|-----------------------|-----------------------|
| | | | | Ammonia | Benzene | 1,3-Butadiene | Formaldehyde | Mercury | Toluene | Xylene |
| Construction | | | | | | | | | | |
| Underground transfer lines | 2009 | 2009 | 200EW+ | a | a | a | a | a | a | a |
| Canister Storage Building | 2006 | 2016 | 200E | a | a | a | a | a | a | a |
| IHLW Shipping/Transfer Facility | 2011 | 2013 | 200E | a | a | a | a | a | a | a |
| IHLW Interim Storage Modules | 2014 | 2019 | 200E | a | a | a | a | a | a | a |
| Other infrastructure upgrades | 2006 | 2034 | WTP_AS | a | a | a | a | a | a | a |
| Tank upgrades | 2006 | 2025 | 200EW | 7.82×10 ⁻² | a | a | a | a | a | a |
| Waste Treatment Plant | 2006 | 2017 | WTP_AS | 9.98×10 ⁻¹ | 2.09×10 ⁻¹ | 5.81×10 ⁻³ | 1.89×10 ⁻¹ | a | 1.31 | 3.93×10 ⁻¹ |
| Cesium and Strontium Capsule Processing Facility | 2088 | 2091 | 200E | 2.22×10 ⁻¹ | 1.27×10 ⁻¹ | 1.49×10 ⁻³ | 6.26×10 ⁻² | a | 1.63 | 4.64×10 ⁻¹ |
| Tank risers | 2013 | 2056 | 200EW | 1.98×10 ⁻¹ | a | a | a | a | a | a |
| Modified sluicing retrieval system | 2013 | 2092 | 200EW | 1.07×10 ⁻¹ | a | a | a | a | a | a |
| Mobile retrieval system | 2013 | 2052 | 200EW | 9.99×10 ⁻² | a | a | a | a | a | a |
| Vacuum-based retrieval system | 2053 | 2092 | 200EW | 1.28×10 ⁻¹ | a | a | a | a | a | a |
| HLW Melter Interim Storage Facility 1 | 2015 | 2016 | WTP_AS | a | a | a | a | a | a | a |
| HLW Melter Interim Storage Facility 2 | 2040 | 2041 | WTP_AS | a | a | a | a | a | a | a |
| HLW Melter Interim Storage Facility 3 | 2065 | 2066 | WTP_AS | a | a | a | a | a | a | a |
| Double-shell tank replacement | 2013 | 2054 | 200EW+ | a | a | a | a | a | a | a |
| Waste Treatment Plant replacement | 2065 | 2076 | WTP_AS | 2.00 | 4.19×10 ⁻¹ | 1.16×10 ⁻² | 3.78×10 ⁻¹ | a | 2.62 | 7.86×10 ⁻¹ |
| Underground transfer line replacement | 2044 | 2044 | 200EW+ | a | a | a | a | a | a | a |
| Effluent Treatment Facility | 2023 | 2025 | 200E | 3.81×10 ⁻¹ | 2.19×10 ⁻¹ | 2.55×10 ⁻³ | 1.08×10 ⁻¹ | a | 2.82 | 8.02×10 ⁻¹ |
| Effluent Treatment Facility upgrade | 2053 | 2055 | 200E | 3.81×10 ⁻¹ | 2.19×10 ⁻¹ | 2.55×10 ⁻³ | 1.08×10 ⁻¹ | a | 2.82 | 8.02×10 ⁻¹ |
| Evaporator replacement | 2015 | 2017 | 200E | 1.19×10 ⁻¹ | 6.80×10 ⁻² | 7.95×10 ⁻⁴ | 3.35×10 ⁻² | a | 8.74×10 ⁻¹ | 2.49×10 ⁻¹ |
| Evaporator upgrade 1 | 2040 | 2042 | 200E | 1.19×10 ⁻¹ | 6.80×10 ⁻² | 7.95×10 ⁻⁴ | 3.35×10 ⁻² | a | 8.74×10 ⁻¹ | 2.49×10 ⁻¹ |
| Evaporator upgrade 2 | 2065 | 2067 | 200E | 1.19×10 ⁻¹ | 6.80×10 ⁻² | 7.95×10 ⁻⁴ | 3.35×10 ⁻² | a | 8.74×10 ⁻¹ | 2.49×10 ⁻¹ |
| Operations | | | | | | | | | | |
| IHLW Interim Storage Facility | 2018 | 2092 | WTP_AS | a | a | a | a | a | a | a |
| Other infrastructure upgrades | 2006 | 2092 | 200EW | a | a | a | a | a | a | a |
| Routine operations | 2006 | 2092 | 200EW | 1.18×10 ¹ | a | a | a | a | a | a |
| Retrieval operations | 2006 | 2092 | 200EW | 4.09×10 ⁻² | a | a | a | a | a | a |
| Double-shell tank interim stabilization | 2006 | 2092 | 200EW+ | 2.68×10 ⁻¹ | a | a | a | a | a | a |
| Waste Treatment Plant | 2018 | 2092 | WTP_PS | 1.52 | 9.56×10 ⁻³ | 3.45×10 ⁻⁶ | 1.07×10 ⁻⁴ | 2.42×10 ⁻² | 2.69×10 ⁻⁴ | 9.06×10 ⁻⁴ |

Table G-12. Tank Closure Alternative 2A Toxic Pollutant Emissions (*continued*)

| Facility/System | Start Year | End Year | Location | Emission Rate (metric tons per year) | | | | | | |
|--|------------|----------|----------|--------------------------------------|-----------------------|-----------------------|-----------------------|-----------------------|-----------------------|-----------------------|
| | | | | Ammonia | Benzene | 1,3-Butadiene | Formaldehyde | Mercury | Toluene | Xylene |
| Operations (<i>continued</i>) | | | | | | | | | | |
| Waste Treatment Plant, cesium and strontium capsules | 2093 | 2093 | WTP_PS | 1.52 | 9.56×10 ⁻³ | 3.45×10 ⁻⁶ | 1.07×10 ⁻⁴ | a | 2.69×10 ⁻⁴ | 9.06×10 ⁻⁴ |
| Cesium and Strontium Capsule Processing Facility | 2092 | 2093 | WTP_AS | 3.80×10 ⁻³ | 6.24×10 ⁻³ | 3.53×10 ⁻⁵ | 2.11×10 ⁻³ | a | 9.58×10 ⁻² | 2.70×10 ⁻² |
| Modified sluicing retrieval system | 2013 | 2092 | 200EW+ | 1.07×10 ⁻¹ | a | a | a | a | a | a |
| Mobile retrieval system | 2013 | 2052 | 200EW+ | 9.99×10 ⁻² | a | a | a | a | a | a |
| Vacuum-based retrieval system | 2053 | 2092 | 200EW | 1.28×10 ⁻¹ | a | a | a | a | a | a |
| HLW Melter Interim Storage Facility | 2018 | 2192 | WTP_AS | a | a | a | a | a | a | a |
| Effluent Treatment Facility | 2006 | 2095 | WTP_PS | 4.54×10 ⁻³ | 1.71×10 ⁻³ | 2.83×10 ⁻⁵ | 1.05×10 ⁻³ | a | 1.86×10 ⁻² | 5.35×10 ⁻³ |
| Evaporator replacement | 2006 | 2093 | 200E | 8.97×10 ⁻² | 1.21×10 ⁻² | 5.06×10 ⁻⁴ | 1.53×10 ⁻² | a | 5.29×10 ⁻³ | 3.69×10 ⁻³ |
| Borrow Area C | 2006 | 2102 | Area C | 1.78×10 ⁻¹ | 3.12×10 ⁻² | 1.02×10 ⁻³ | 3.21×10 ⁻² | a | 1.32×10 ⁻¹ | 4.15×10 ⁻² |
| Deactivation | | | | | | | | | | |
| IHLW Interim Storage Facility | 2093 | 2093 | WTP_AS | a | a | a | a | a | a | a |
| Waste Treatment Plant | 2078 | 2079 | WTP_AS | 1.52×10 ⁻¹ | 9.56×10 ⁻⁴ | 3.45×10 ⁻⁷ | 1.07×10 ⁻⁵ | 2.42×10 ⁻³ | 2.69×10 ⁻⁵ | 9.06×10 ⁻⁵ |
| Modified sluicing retrieval system | 2013 | 2092 | 200EW | a | a | a | a | a | a | a |
| Mobile retrieval system | 2013 | 2052 | 200EW+ | a | a | a | a | a | a | a |
| Vacuum-based retrieval system | 2053 | 2092 | 200EW | a | a | a | a | a | a | a |
| Administrative controls | 2094 | 2193 | 200EW+ | 1.18×10 ¹ | a | a | a | a | a | a |
| Waste Treatment Plant upgrade | 2094 | 2095 | WTP_AS | 1.52×10 ⁻¹ | 9.56×10 ⁻⁴ | 3.45×10 ⁻⁷ | 1.07×10 ⁻⁵ | 2.42×10 ⁻³ | 2.69×10 ⁻⁵ | 9.06×10 ⁻⁵ |
| Cesium and Strontium Capsule Processing Facility | 2094 | 2094 | WTP_AS | 1.75×10 ⁻³ | 2.88×10 ⁻³ | 1.63×10 ⁻⁵ | 9.76×10 ⁻⁴ | a | 4.42×10 ⁻² | 1.25×10 ⁻² |
| Effluent Treatment Facility original | 2026 | 2026 | WTP_AS | 7.88×10 ⁻² | 2.23×10 ⁻² | 4.73×10 ⁻⁴ | 1.64×10 ⁻² | a | 2.00×10 ⁻¹ | 5.81×10 ⁻² |
| Effluent Treatment Facility replacement 1 | 2056 | 2056 | WTP_AS | 7.88×10 ⁻² | 2.23×10 ⁻² | 4.73×10 ⁻⁴ | 1.64×10 ⁻² | a | 2.00×10 ⁻¹ | 5.81×10 ⁻² |
| Effluent Treatment Facility replacement 2 | 2096 | 2096 | WTP_AS | 7.88×10 ⁻² | 2.23×10 ⁻² | 4.73×10 ⁻⁴ | 1.64×10 ⁻² | a | 2.00×10 ⁻¹ | 5.81×10 ⁻² |
| Evaporator original | 2018 | 2018 | 200E | 1.21×10 ⁻² | 1.63×10 ⁻³ | 6.82×10 ⁻⁵ | 2.06×10 ⁻³ | a | 7.14×10 ⁻⁴ | 4.97×10 ⁻⁴ |
| Evaporator replacement 1 | 2043 | 2043 | 200E | 1.21×10 ⁻² | 1.63×10 ⁻³ | 6.82×10 ⁻⁵ | 2.06×10 ⁻³ | a | 7.14×10 ⁻⁴ | 4.97×10 ⁻⁴ |
| Evaporator replacement 2 | 2068 | 2068 | 200E | 1.21×10 ⁻² | 1.63×10 ⁻³ | 6.82×10 ⁻⁵ | 2.06×10 ⁻³ | a | 7.14×10 ⁻⁴ | 4.97×10 ⁻⁴ |
| Evaporator replacement 3 | 2094 | 2094 | 200E | 1.21×10 ⁻² | 1.63×10 ⁻³ | 6.82×10 ⁻⁵ | 2.06×10 ⁻³ | a | 7.14×10 ⁻⁴ | 4.97×10 ⁻⁴ |

Table G-12. Tank Closure Alternative 2A Toxic Pollutant Emissions (*continued*)

| Facility/System | Start Year | End Year | Location | Emission Rate (metric tons per year) | | | | | | |
|---|------------|----------|----------|--------------------------------------|---------|---------------|--------------|---------|---------|--------|
| | | | | Ammonia | Benzene | 1,3-Butadiene | Formaldehyde | Mercury | Toluene | Xylene |
| Closure | | | | | | | | | | |
| Decontamination and decommissioning of 10 selected facilities | 2018 | 2028 | 200EW | a | a | a | a | a | a | a |

^a Emissions for this activity and pollutant were not calculated because annual fuel use for this activity and the resulting emissions would be small compared with those of other activities or would be zero.

Key: 200E=200-East Area; 200EW=200-East and 200-West Areas; 200EW+=200-East and 200-West Areas and Waste Treatment Plant area; HLW=high-level radioactive waste; IHLW=immobilized high-level radioactive waste; WTP_AS=Waste Treatment Plant area source; WTP_PS=Waste Treatment Plant point source.

Source: SAIC 2007a, 2008.

Table G-13. Tank Closure Alternative 2B Criteria Pollutant Emissions

| Facility/System | Start Year | End Year | Location | Emission Rate (metric tons per year) | | | | |
|--|------------|----------|----------|--------------------------------------|-----------------------|-----------------------|-----------------------|-----------------------|
| | | | | Carbon Monoxide | Nitrogen Dioxide | PM ₁₀ | Sulfur Dioxide | VOCs |
| Construction | | | | | | | | |
| Canister Storage Building | 2006 | 2016 | 200E | 5.54 | 1.28 | 9.05×10 ⁻¹ | 4.02×10 ⁻⁴ | 2.86×10 ⁻¹ |
| IHLW Shipping/Transfer Facility | 2011 | 2013 | 200E | 5.68×10 ¹ | 6.72×10 ¹ | 9.81×10 ¹ | 2.18×10 ⁻² | 6.50 |
| IHLW Interim Storage Modules | 2014 | 2022 | 200E | 4.00×10 ¹ | 4.76×10 ¹ | 1.58×10 ² | 1.45×10 ⁻² | 4.34 |
| Other infrastructure upgrades | 2006 | 2034 | 200EW | 1.11 | 8.05×10 ⁻¹ | 1.13 | 2.54×10 ⁻⁴ | 9.43×10 ⁻² |
| Tank upgrades | 2006 | 2025 | 200EW | 3.49×10 ² | 4.41×10 ¹ | 8.07 | 1.38×10 ⁻² | 1.56×10 ¹ |
| Waste Treatment Plant | 2006 | 2017 | WTP_AS | 7.64×10 ² | 6.20×10 ² | 4.16×10 ² | 1.05 | 7.99×10 ¹ |
| Low-Activity Waste Vitrification Facility expansion | 2008 | 2017 | 200E | 1.85×10 ² | 4.09×10 ¹ | 1.65×10 ² | 2.50×10 ⁻¹ | 1.15×10 ¹ |
| Cesium and Strontium Capsule Processing Facility | 2035 | 2038 | WTP_AS | 8.41×10 ² | 1.22×10 ² | 1.80×10 ¹ | 1.13 | 4.78×10 ¹ |
| Waste receiver facilities | 2013 | 2017 | 200EW | 1.15×10 ² | 9.65×10 ¹ | 3.31×10 ² | 2.92×10 ⁻² | 9.94 |
| Tank risers | 2013 | 2016 | 200EW | 1.84×10 ¹ | 8.19 | 7.42×10 ⁻¹ | 1.72×10 ⁻³ | 2.06 |
| Modified sluicing retrieval system | 2013 | 2043 | 200EW+ | 6.69×10 ¹ | 2.58 | 1.43 | 6.19×10 ⁻⁴ | 2.62 |
| Mobile retrieval system | 2013 | 2028 | 200EW | 6.27×10 ¹ | 2.72×10 ¹ | 5.24 | 8.72×10 ⁻³ | 4.15 |
| Vacuum-based retrieval system | 2029 | 2043 | 200EW | 6.69×10 ¹ | 3.03×10 ¹ | 6.08 | 9.64×10 ⁻³ | 4.55 |
| HLW Melter Interim Storage Facility 1 | 2015 | 2016 | WTP_AS | 6.17×10 ⁻¹ | 1.39 | 1.72×10 ¹ | 2.87×10 ⁻⁴ | 6.73×10 ⁻² |
| HLW Melter Interim Storage Facility 2 | 2029 | 2030 | WTP_AS | 6.17×10 ⁻¹ | 1.39 | 1.72×10 ¹ | 2.87×10 ⁻⁴ | 6.73×10 ⁻² |
| Effluent Treatment Facility | 2023 | 2025 | 200E | 1.45×10 ³ | 2.09×10 ² | 9.48×10 ² | 1.96 | 8.25×10 ¹ |
| Evaporator replacement | 2015 | 2017 | 200E | 4.51×10 ² | 6.53×10 ¹ | 1.76×10 ¹ | 6.07×10 ⁻¹ | 2.56×10 ¹ |
| Underground transfer line 1,000-foot sections | 2009 | 2009 | 200EW+ | 7.59×10 ¹ | 2.71×10 ¹ | 2.41×10 ¹ | 8.75×10 ⁻³ | 4.47 |
| Operations | | | | | | | | |
| IHLW Interim Storage Facility | 2018 | 2066 | WTP_AS | a | a | a | a | a |
| Other infrastructure upgrades | 2006 | 2043 | 200EW | a | a | a | a | a |
| Routine operations | 2006 | 2043 | 200EW | 1.36×10 ¹ | 1.55×10 ¹ | a | a | 5.40 |
| Retrieval operations | 2006 | 2043 | 200EW | 4.72×10 ⁻² | 5.35×10 ⁻² | a | a | 1.89×10 ⁻² |
| Double-shell tank interim stabilization | 2006 | 2043 | 200EW | 3.09×10 ⁻¹ | 3.51×10 ⁻¹ | a | a | 1.24×10 ⁻¹ |
| Waste Treatment Plant | 2018 | 2043 | WTP_PS | 2.36×10 ² | 5.24×10 ² | 9.08 | 2.69×10 ¹ | 8.56×10 ² |
| Waste Treatment Plant, cesium and strontium capsules | 2040 | 2040 | WTP_PS | 2.36×10 ² | 5.24×10 ² | 9.08 | 2.69×10 ¹ | 8.56×10 ² |
| Cesium and Strontium Capsule Processing Facility | 2039 | 2040 | WTP_AS | 4.85×10 ¹ | 1.29 | 5.53×10 ¹ | 6.49×10 ⁻² | 2.34 |
| Modified sluicing retrieval system | 2013 | 2043 | 200EW+ | 1.86×10 ¹ | 1.15 | 8.87×10 ⁻² | 2.96×10 ⁻⁴ | 7.98×10 ⁻¹ |
| Mobile retrieval system | 2013 | 2028 | 200EW+ | 2.88×10 ⁻¹ | 3.27×10 ⁻¹ | a | a | 1.15×10 ⁻¹ |
| Vacuum-based retrieval system | 2029 | 2043 | 200EW | 4.56×10 ⁻¹ | 5.17×10 ⁻¹ | a | a | 1.82×10 ⁻¹ |
| HLW Melter Interim Storage Facility | 2018 | 2145 | WTP_AS | a | a | a | a | a |
| Effluent Treatment Facility | 2006 | 2045 | WTP_PS | 9.84 | 2.67 | 9.34×10 ² | 1.33×10 ⁻² | 6.48×10 ⁻¹ |

Table G-13. Tank Closure Alternative 2B Criteria Pollutant Emissions (*continued*)

| Facility/System | Start Year | End Year | Location | Emission Rate (metric tons per year) | | | | |
|---|------------|----------|----------|--------------------------------------|-----------------------|-----------------------|-----------------------|-----------------------|
| | | | | Carbon Monoxide | Nitrogen Dioxide | PM ₁₀ | Sulfur Dioxide | VOCs |
| Operations (<i>continued</i>) | | | | | | | | |
| Evaporator replacement | 2006 | 2043 | 200E | 1.23×10 ¹ | 5.70×10 ¹ | 1.71×10 ¹ | 1.94×10 ⁻² | 4.66 |
| Borrow Area C | 2006 | 2052 | Area C | 8.52×10 ¹ | 1.12×10 ² | 2.30×10 ² | 1.20×10 ⁻¹ | 1.20×10 ¹ |
| Deactivation | | | | | | | | |
| IHLW Interim Storage Facility | 2067 | 2067 | WTP_AS | a | a | a | a | a |
| Waste Treatment Plant | 2044 | 2045 | WTP_AS | 2.36×10 ¹ | 5.24×10 ¹ | 9.08×10 ⁻¹ | 2.69 | 8.86×10 ⁻¹ |
| Modified sluicing retrieval system | 2013 | 2043 | 200EW+ | 4.76×10 ¹ | 2.01 | 1.77×10 ⁻¹ | 5.91×10 ⁻⁴ | 1.83 |
| Mobile retrieval system | 2013 | 2028 | 200EW | 3.13×10 ¹ | 2.45 | 2.04×10 ⁻¹ | 7.50×10 ⁻⁴ | 1.29 |
| Vacuum-based retrieval system | 2029 | 2043 | 200EW | 1.46 | 1.14×10 ⁻¹ | 1.04×10 ⁻² | 3.49×10 ⁻⁵ | 5.96×10 ⁻² |
| Cesium and Strontium Capsule Processing Facility | 2041 | 2041 | WTP_AS | 2.24×10 ¹ | 5.96×10 ⁻¹ | 2.55×10 ¹ | 3.00×10 ⁻² | 1.08 |
| Effluent Treatment Facility original | 2026 | 2026 | WTP_AS | 1.09×10 ² | 4.78×10 ¹ | 4.70×10 ² | 1.48×10 ⁻¹ | 8.47 |
| Effluent Treatment Facility replacement | 2056 | 2056 | WTP_AS | 1.09×10 ² | 4.78×10 ¹ | 4.70×10 ² | 1.48×10 ⁻¹ | 8.47 |
| Evaporator original | 2018 | 2018 | 200E | 1.66 | 7.70 | 7.07 | 2.62×10 ⁻³ | 6.28×10 ⁻¹ |
| Evaporator replacement | 2044 | 2044 | 200E | 1.66 | 7.70 | 7.07 | 2.62×10 ⁻³ | 6.28×10 ⁻¹ |
| Closure | | | | | | | | |
| Ancillary equipment grouting | 2013 | 2037 | 200EW | 3.46×10 ⁻¹ | 1.50 | 1.63 | 4.82×10 ⁻⁴ | 1.16×10 ⁻¹ |
| Ancillary equipment removal | 2032 | 2037 | 200EW | 3.28 | 1.50×10 ¹ | 4.40×10 ¹ | 4.92×10 ⁻³ | 1.19 |
| Decontamination and decommissioning of 10 selected facilities | 2018 | 2028 | 200EW | 2.53 | 9.81 | 8.56 | 3.22×10 ⁻³ | 7.93×10 ⁻¹ |
| Grout facility (tank-filling) construction | 2032 | 2033 | 200EW | 2.18 | 8.29 | 4.20 | 2.71×10 ⁻³ | 6.82×10 ⁻¹ |
| Grout facility (tank-filling) operations | 2034 | 2043 | 200EW | 2.25×10 ¹ | 8.32×10 ¹ | 4.51×10 ¹ | 2.70×10 ⁻² | 6.68 |
| Grout facility (tank-filling) deactivation | 2044 | 2044 | 200EW | 1.45 | 3.41 | 2.10×10 ¹ | 1.12×10 ⁻³ | 2.95×10 ⁻¹ |
| Containment structure construction | 2028 | 2031 | 200EW | 6.78×10 ¹ | 7.06 | 2.74 | 2.19×10 ⁻³ | 2.91 |
| BX and SX tank farm soil removal | 2032 | 2037 | 200EW | 3.99×10 ¹ | 1.13×10 ² | 2.56×10 ² | 3.73×10 ⁻² | 9.55 |
| Containment structure deactivation | 2038 | 2040 | 200EW | 9.04×10 ¹ | 9.39 | 3.09 | 2.92×10 ⁻³ | 3.88 |
| Modified Resource Conservation and Recovery Act Subtitle C barrier construction | 2039 | 2045 | 200EW | 1.64×10 ³ | 1.50×10 ³ | 3.48×10 ³ | 2.27 | 1.83×10 ² |
| Postclosure care | 2046 | 2145 | 200EW | a | a | a | a | a |

^a Emissions for this activity and pollutant were not calculated because annual fuel use for this activity and the resulting emissions would be small compared with those of other activities or would be zero.

Key: 200E=200-East Area; 200EW=200-East and 200-West Areas; 200EW+=200-East and 200-West Areas and Waste Treatment Plant area; HLW=high-level radioactive waste; IHLW=immobilized high-level radioactive waste; PM₁₀=particulate matter with an aerodynamic diameter less than or equal to 10 micrometers; VOC=volatile organic compound; WTP_AS=Waste Treatment Plant area source; WTP_PS=Waste Treatment Plant point source.

Source: SAIC 2007a, 2008.

Table G-14. Tank Closure Alternative 2B Toxic Pollutant Emissions

| Facility/System | Start Year | End Year | Location | Emission Rate (metric tons per year) | | | | | | |
|--|------------|----------|----------|--------------------------------------|-----------------------|-----------------------|-----------------------|-----------------------|-----------------------|-----------------------|
| | | | | Ammonia | Benzene | 1,3-Butadiene | Formaldehyde | Mercury | Toluene | Xylene |
| Construction | | | | | | | | | | |
| Canister Storage Building | 2006 | 2016 | 200E | a | a | a | a | a | a | a |
| IHLW Shipping/Transfer Facility | 2011 | 2013 | 200E | a | a | a | a | a | a | a |
| IHLW Interim Storage Modules | 2014 | 2022 | 200E | a | a | a | a | a | a | a |
| Other infrastructure upgrades | 2006 | 2034 | 200EW | a | a | a | a | a | a | a |
| Tank upgrades | 2006 | 2025 | 200EW | 7.82×10 ⁻² | a | a | a | a | a | a |
| Waste Treatment Plant | 2006 | 2017 | WTP_AS | 9.98×10 ⁻¹ | 2.09×10 ⁻¹ | 5.81×10 ⁻³ | 1.89×10 ⁻¹ | a | 1.31 | 3.93×10 ⁻¹ |
| Low-Activity Waste Vitrification Facility expansion | 2008 | 2017 | 200E | 7.08×10 ⁻² | 3.05×10 ⁻² | 4.50×10 ⁻⁴ | 1.74×10 ⁻² | a | 3.54×10 ⁻¹ | 1.01×10 ⁻¹ |
| Cesium and Strontium Capsule Processing Facility | 2035 | 2038 | WTP_AS | 2.22×10 ⁻¹ | 1.27×10 ⁻¹ | 1.49×10 ⁻³ | 6.26×10 ⁻² | a | 1.63 | 4.64×10 ⁻¹ |
| Waste receiver facilities | 2013 | 2017 | 200EW | a | a | a | a | a | a | a |
| Tank risers | 2013 | 2016 | 200EW | 2.18 | a | a | a | a | a | a |
| Modified sluicing retrieval system | 2013 | 2043 | 200EW+ | 2.17×10 ⁻¹ | a | a | a | a | a | a |
| Mobile retrieval system | 2013 | 2028 | 200EW | 2.50×10 ⁻¹ | a | a | a | a | a | a |
| Vacuum-based retrieval system | 2029 | 2043 | 200EW | 3.95×10 ⁻¹ | a | a | a | a | a | a |
| HLW Melter Interim Storage Facility 1 | 2015 | 2016 | WTP_AS | a | a | a | a | a | a | a |
| HLW Melter Interim Storage Facility 2 | 2029 | 2030 | WTP_AS | a | a | a | a | a | a | a |
| Effluent Treatment Facility | 2023 | 2025 | 200E | 3.81×10 ⁻¹ | 2.19×10 ⁻¹ | 2.55×10 ⁻³ | 1.08×10 ⁻¹ | a | 2.82 | 8.02×10 ⁻¹ |
| Evaporator replacement | 2015 | 2017 | 200E | 1.19×10 ⁻¹ | 6.80×10 ⁻² | 7.95×10 ⁻⁴ | 3.35×10 ⁻² | a | 8.74×10 ⁻¹ | 2.49×10 ⁻¹ |
| Underground transfer line 1,000-foot sections | 2009 | 2009 | 200EW+ | a | a | a | a | a | a | a |
| Operations | | | | | | | | | | |
| IHLW Interim Storage Facility | 2018 | 2066 | WTP_AS | a | a | a | a | a | a | a |
| Other infrastructure upgrades | 2006 | 2043 | 200EW | a | a | a | a | a | a | a |
| Routine operations | 2006 | 2043 | 200EW | 1.18×10 ¹ | a | a | a | a | a | a |
| Retrieval operations | 2006 | 2043 | 200EW | 4.09×10 ⁻² | a | a | a | a | a | a |
| Double-shell tank interim stabilization | 2006 | 2043 | 200EW | 2.68×10 ⁻¹ | a | a | a | a | a | a |
| Waste Treatment Plant | 2018 | 2043 | WTP_PS | 3.53 | 2.23×10 ⁻² | 8.05×10 ⁻⁶ | 2.49×10 ⁻⁴ | 6.97×10 ⁻² | 6.27×10 ⁻⁴ | 2.11×10 ⁻³ |
| Waste Treatment Plant, cesium and strontium capsules | 2040 | 2040 | WTP_PS | 3.53 | 2.23×10 ⁻² | 8.05×10 ⁻⁶ | 2.49×10 ⁻⁴ | a | 6.27×10 ⁻⁴ | 2.11×10 ⁻³ |

Table G-14. Tank Closure Alternative 2B Toxic Pollutant Emissions (continued)

| Facility/System | Start Year | End Year | Location | Emission Rate (metric tons per year) | | | | | | |
|---|------------|----------|----------|--------------------------------------|-----------------------|-----------------------|-----------------------|-----------------------|-----------------------|-----------------------|
| | | | | Ammonia | Benzene | 1,3-Butadiene | Formaldehyde | Mercury | Toluene | Xylene |
| Operations (continued) | | | | | | | | | | |
| Cesium and Strontium Capsule Processing Facility | 2039 | 2040 | WTP_AS | 3.80×10^{-3} | 6.24×10^{-3} | 3.53×10^{-5} | 2.11×10^{-3} | a | 9.58×10^{-2} | 2.70×10^{-2} |
| Modified sluicing retrieval system | 2013 | 2043 | 200EW+ | 2.17×10^{-1} | a | a | a | a | a | a |
| Mobile retrieval system | 2013 | 2028 | 200EW+ | 2.50×10^{-1} | a | a | a | a | a | a |
| Vacuum-based retrieval system | 2029 | 2043 | 200EW | 3.95×10^{-1} | a | a | a | a | a | a |
| HLW Melter Interim Storage Facility | 2018 | 2145 | WTP_AS | a | a | a | a | a | a | a |
| Effluent Treatment Facility | 2006 | 2045 | WTP_PS | 4.54×10^{-3} | 1.71×10^{-3} | 2.83×10^{-5} | 1.05×10^{-3} | a | 1.86×10^{-2} | 5.35×10^{-3} |
| Evaporator | 2006 | 2043 | 200E | 8.97×10^{-2} | 1.21×10^{-2} | 5.06×10^{-4} | 1.53×10^{-2} | a | 5.29×10^{-3} | 3.69×10^{-3} |
| Borrow Area C | 2006 | 2052 | Area C | 1.78×10^{-1} | 3.12×10^{-2} | 1.02×10^{-3} | 3.21×10^{-2} | a | 1.32×10^{-1} | 4.15×10^{-2} |
| Deactivation | | | | | | | | | | |
| IHLW Interim Storage Facility | 2067 | 2067 | WTP_AS | a | a | a | a | a | a | a |
| Waste Treatment Plant | 2044 | 2045 | WTP_AS | 3.53×10^{-1} | 2.23×10^{-3} | 8.05×10^{-7} | 2.49×10^{-5} | 9.06×10^{-2} | 6.27×10^{-5} | 2.11×10^{-4} |
| Modified sluicing retrieval system | 2013 | 2043 | 200EW+ | a | a | a | a | a | a | a |
| Mobile retrieval system | 2013 | 2028 | 200EW | a | a | a | a | a | a | a |
| Vacuum-based retrieval system | 2029 | 2043 | 200EW | a | a | a | a | a | a | a |
| Cesium and Strontium Capsule Processing Facility | 2041 | 2041 | WTP_AS | 1.75×10^{-3} | 2.88×10^{-3} | 1.63×10^{-5} | 9.76×10^{-4} | a | 4.42×10^{-2} | 1.25×10^{-2} |
| Effluent Treatment Facility original | 2026 | 2026 | WTP_AS | 7.88×10^{-2} | 2.23×10^{-2} | 4.73×10^{-4} | 1.64×10^{-2} | a | 2.00×10^{-1} | 5.81×10^{-2} |
| Effluent Treatment Facility replacement | 2056 | 2056 | WTP_AS | 7.88×10^{-2} | 2.23×10^{-2} | 4.73×10^{-4} | 1.64×10^{-2} | a | 2.00×10^{-1} | 5.81×10^{-2} |
| Evaporator original | 2018 | 2018 | 200E | 1.21×10^{-2} | 1.63×10^{-3} | 6.82×10^{-5} | 2.06×10^{-3} | a | 7.14×10^{-4} | 4.97×10^{-4} |
| Evaporator replacement | 2044 | 2044 | 200E | 1.21×10^{-2} | 1.63×10^{-3} | 6.82×10^{-5} | 2.06×10^{-3} | a | 7.14×10^{-4} | 4.97×10^{-4} |
| Closure | | | | | | | | | | |
| Ancillary equipment grouting | 2013 | 2037 | 200EW | 2.69×10^{-5} | a | a | a | a | a | a |
| Ancillary equipment removal | 2032 | 2037 | 200EW | 1.72×10^{-5} | a | a | a | a | a | a |
| Decontamination and decommissioning of 10 selected facilities | 2018 | 2028 | 200EW | a | a | a | a | a | a | a |
| Grout facility (tank-filling) construction | 2032 | 2033 | 200EW | 3.33×10^{-2} | a | a | a | a | a | a |
| Grout facility (tank-filling) operations | 2034 | 2043 | 200EW | 1.17×10^{-2} | a | a | a | a | a | a |
| Grout facility (tank-filling) deactivation | 2044 | 2044 | 200EW | a | a | a | a | a | a | a |
| Containment structure construction | 2028 | 2031 | 200EW | a | a | a | a | a | a | a |

Table G-14. Tank Closure Alternative 2B Toxic Pollutant Emissions (*continued*)

| Facility/System | Start Year | End Year | Location | Emission Rate (metric tons per year) | | | | | | |
|---|------------|----------|----------|--------------------------------------|-----------------------|-----------------------|-----------------------|---------|---------|-----------------------|
| | | | | Ammonia | Benzene | 1,3-Butadiene | Formaldehyde | Mercury | Toluene | Xylene |
| Closure (<i>continued</i>) | | | | | | | | | | |
| BX and SX tank farm soil removal | 2032 | 2037 | 200EW | 8.33×10 ⁻⁴ | a | a | a | a | a | a |
| Containment structure deactivation | 2038 | 2040 | 200EW | a | a | a | a | a | a | a |
| Modified Resource Conservation and Recovery Act Subtitle C barrier construction | 2039 | 2045 | 200EW | 2.41 | 4.80×10 ⁻¹ | 1.39×10 ⁻² | 4.49×10 ⁻¹ | a | 2.75 | 8.32×10 ⁻¹ |
| Postclosure care | 2046 | 2145 | 200EW | a | a | a | a | a | a | a |

^a Emissions for this activity and pollutant were not calculated because annual fuel use for this activity and the resulting emissions would be small compared with those of other activities or would be zero.

Key: 200E=200-East Area; 200EW=200-East and 200-West Areas; 200EW+=200-East and 200-West Areas and Waste Treatment Plant area; HLW=high-level radioactive waste; IHLW=immobilized high-level radioactive waste; WTP_AS=Waste Treatment Plant area source; WTP_PS=Waste Treatment Plant point source.

Source: SAIC 2007a, 2008.

Table G-15. Tank Closure Alternative 3A Criteria Pollutant Emissions

| Facility/System | Start Year | End Year | Location | Emission Rate (metric tons per year) | | | | |
|--|------------|----------|----------|--------------------------------------|-----------------------|-----------------------|-----------------------|-----------------------|
| | | | | Carbon Monoxide | Nitrogen Dioxide | PM ₁₀ | Sulfur Dioxide | VOCs |
| Construction | | | | | | | | |
| Canister Storage Building | 2006 | 2016 | 200E | 5.54 | 1.28 | 9.05×10 ⁻¹ | 4.02×10 ⁻⁴ | 2.86×10 ⁻¹ |
| IHLW Shipping/Transfer Facility | 2011 | 2013 | 200E | 5.68×10 ¹ | 6.72×10 ¹ | 9.80×10 ¹ | 2.18×10 ⁻² | 6.50 |
| IHLW Interim Storage Modules | 2014 | 2022 | 200E | 4.00×10 ¹ | 4.76×10 ¹ | 1.58×10 ² | 1.45×10 ⁻² | 4.33 |
| Other infrastructure upgrades | 2006 | 2034 | 200EW | 1.11 | 8.05×10 ⁻¹ | 1.13 | 2.54×10 ⁻⁴ | 9.43×10 ⁻² |
| Tank upgrades | 2006 | 2025 | 200EW | 3.49×10 ² | 4.41×10 ¹ | 8.07 | 1.38×10 ⁻² | 1.56×10 ¹ |
| Waste Treatment Plant | 2006 | 2017 | WTP_AS | 7.64×10 ² | 6.20×10 ² | 4.16×10 ² | 1.05 | 7.99×10 ¹ |
| Cesium and Strontium Capsule Processing Facility | 2035 | 2038 | WTP_AS | 8.41×10 ² | 1.22×10 ² | 1.80×10 ¹ | 1.13 | 4.78×10 ¹ |
| Waste receiver facilities | 2013 | 2017 | 200EW | 1.15×10 ² | 9.65×10 ¹ | 3.31×10 ² | 2.92×10 ⁻² | 9.94 |
| Tank risers | 2013 | 2016 | 200EW | 1.84×10 ¹ | 8.19 | 7.42×10 ⁻¹ | 1.72×10 ⁻³ | 2.06 |
| Modified sluicing retrieval system | 2013 | 2039 | 200EW+ | 7.68×10 ¹ | 2.96 | 1.64 | 7.11×10 ⁻⁴ | 3.01 |
| Mobile retrieval system | 2013 | 2026 | 200EW | 7.17×10 ¹ | 3.11×10 ¹ | 5.98 | 9.97×10 ⁻³ | 4.74 |
| Vacuum-based retrieval system | 2027 | 2039 | 200EW | 7.72×10 ¹ | 3.49×10 ¹ | 7.02 | 1.11×10 ⁻² | 5.25 |
| HLW Melter Interim Storage Facility | 2015 | 2016 | WTP_AS | 6.17×10 ⁻¹ | 1.39 | 1.72×10 ¹ | 2.87×10 ⁻⁴ | 6.73×10 ⁻² |
| Contact-Handled Mixed Transuranic Waste Facilities | 2008 | 2008 | 200EW | 3.27×10 ¹ | 7.22 | 7.03 | 4.41×10 ⁻² | 2.04 |
| Remote-Handled Mixed Transuranic Waste Facility | 2013 | 2014 | 200E | 2.68×10 ¹ | 5.92 | 3.02 | 3.62×10 ⁻² | 1.67 |
| Transuranic Waste Interim Storage Facility | 2008 | 2009 | WTP_AS | 8.66×10 ⁻¹ | 2.53 | 2.08×10 ¹ | 6.38×10 ⁻⁴ | 1.46×10 ⁻¹ |
| Bulk Vitrification Facility, 200-West Area | 2016 | 2017 | 200W | 8.96×10 ¹ | 1.98×10 ¹ | 1.22×10 ¹ | 1.21×10 ⁻¹ | 5.58 |
| Solid-Liquid Separations Facility | 2016 | 2017 | SUPW | 2.75×10 ¹ | 7.15 | 8.74 | 3.72×10 ⁻² | 1.79 |
| Bulk Vitrification Facility, 200-East Area | 2016 | 2017 | 200E | 8.95×10 ¹ | 1.98×10 ¹ | 1.22×10 ¹ | 1.21×10 ⁻¹ | 5.58 |
| Effluent Treatment Facility replacement 1 | 2023 | 2025 | 200E | 1.45×10 ³ | 2.09×10 ² | 9.48×10 ² | 1.96 | 8.25×10 ¹ |
| Evaporator replacement 1 | 2015 | 2017 | 200E | 4.51×10 ² | 6.53×10 ¹ | 1.76×10 ¹ | 6.07×10 ⁻¹ | 2.56×10 ¹ |
| Underground transfer line 1,000-foot sections | 2009 | 2009 | 200EW+ | 7.59×10 ¹ | 2.71×10 ¹ | 2.41×10 ¹ | 8.75×10 ⁻³ | 4.47 |
| Operations | | | | | | | | |
| IHLW Interim Storage Facility | 2018 | 2066 | WTP_AS | a | a | a | a | a |
| Other infrastructure upgrades | 2006 | 2039 | 200EW | a | a | a | a | a |
| Routine operations | 2006 | 2039 | 200EW | 1.36×10 ¹ | 1.55×10 ¹ | a | a | 5.40 |
| Retrieval operations | 2006 | 2039 | 200EW | 4.72×10 ⁻² | 5.35×10 ⁻² | a | a | 1.89×10 ⁻² |
| Double-shell tank interim stabilization | 2006 | 2039 | 200EW | 3.09×10 ⁻¹ | 3.51×10 ⁻¹ | a | a | 1.24×10 ⁻¹ |
| Waste Treatment Plant | 2018 | 2039 | WTP_PS | 1.01×10 ² | 2.22×10 ² | 3.61 | 1.08×10 ¹ | 3.66×10 ² |
| Waste Treatment Plant, cesium and strontium capsules | 2040 | 2040 | WTP_PS | 1.01×10 ² | 2.22×10 ² | 3.61 | 1.08×10 ¹ | 3.66×10 ² |

Table G-15. Tank Closure Alternative 3A Criteria Pollutant Emissions (*continued*)

| Facility/System | Start Year | End Year | Location | Emission Rate (metric tons per year) | | | | |
|--|------------|----------|----------|--------------------------------------|-----------------------|-----------------------|-----------------------|-----------------------|
| | | | | Carbon Monoxide | Nitrogen Dioxide | PM ₁₀ | Sulfur Dioxide | VOCs |
| Operations (<i>continued</i>) | | | | | | | | |
| Cesium and Strontium Capsule Processing Facility | 2039 | 2040 | WTP_AS | 4.85×10 ¹ | 1.29 | 5.53×10 ¹ | 6.49×10 ⁻² | 2.34 |
| Modified sluicing retrieval system | 2013 | 2039 | 200EW+ | 2.13×10 ¹ | 1.32 | 1.02×10 ⁻¹ | 3.39×10 ⁻⁴ | 9.16×10 ⁻¹ |
| Mobile retrieval system | 2013 | 2026 | 200EW+ | 3.29×10 ⁻¹ | 3.73×10 ⁻¹ | a | a | 1.32×10 ⁻¹ |
| Vacuum-based retrieval system | 2027 | 2039 | 200EW | 5.26×10 ⁻¹ | 5.97×10 ⁻¹ | a | a | 2.11×10 ⁻¹ |
| HLW Melter Interim Storage Facility | 2018 | 2141 | WTP_AS | a | a | a | a | a |
| Contact-Handled Mixed Transuranic Waste Facilities | 2009 | 2010 | 200EW | 1.38×10 ² | 1.26×10 ¹ | 8.55×10 ⁻¹ | 1.85×10 ⁻¹ | 7.32 |
| Remote-Handled Mixed Transuranic Waste Facility | 2015 | 2019 | 200E | 2.74×10 ¹ | 1.75 | 1.17×10 ⁻¹ | 3.68×10 ⁻² | 1.40 |
| Transuranic Waste Interim Storage Facility | 2009 | 2034 | WTP_AS | a | a | a | a | a |
| Bulk Vitrification Facility, 200-West Area | 2018 | 2039 | 200W | 7.80 | 1.66×10 ¹ | 1.76 | 4.44 | 8.25 |
| Solid-Liquid Separations Facility | 2018 | 2039 | SUPW | 7.25×10 ¹ | 1.24×10 ¹ | 8.54×10 ⁻¹ | 9.77×10 ⁻² | 4.26 |
| Bulk Vitrification Facility, 200-East Area | 2018 | 2039 | 200E | 6.95 | 2.58×10 ¹ | 2.75 | 6.80 | 7.90 |
| Effluent Treatment Facility | 2006 | 2042 | WTP_PS | 9.84 | 2.67 | 9.34×10 ² | 1.33×10 ⁻² | 6.48×10 ⁻¹ |
| Evaporator | 2006 | 2040 | 200E | 1.23×10 ¹ | 5.70×10 ¹ | 1.71×10 ¹ | 1.94×10 ⁻² | 4.66 |
| Borrow Area C | 2006 | 2052 | Area C | 8.52×10 ¹ | 1.12×10 ² | 2.30×10 ² | 1.20×10 ⁻¹ | 1.20×10 ¹ |
| Deactivation | | | | | | | | |
| Modified sluicing retrieval system | 2013 | 2039 | 200EW+ | 5.47×10 ¹ | 2.31 | 2.04×10 ⁻¹ | 6.79×10 ⁻⁴ | 2.10 |
| Mobile retrieval system | 2013 | 2026 | 200EW | 3.58×10 ¹ | 2.81 | 2.33×10 ⁻¹ | 8.57×10 ⁻⁴ | 1.48 |
| Vacuum-based retrieval system | 2027 | 2039 | 200EW | 1.68 | 1.32×10 ⁻¹ | 1.20×10 ⁻² | 4.03×10 ⁻⁵ | 6.87×10 ⁻² |
| IHLW Interim Storage Facility | 2067 | 2067 | WTP_AS | a | a | a | a | a |
| Waste Treatment Plant | 2041 | 2042 | WTP_AS | 1.01×10 ¹ | 2.22×10 ¹ | 3.61×10 ⁻¹ | 1.08 | 3.66×10 ¹ |
| Cesium and Strontium Capsule Processing Facility | 2041 | 2041 | WTP_AS | 2.24×10 ¹ | 5.96×10 ⁻¹ | 2.55×10 ¹ | 3.00×10 ⁻² | 1.08 |
| Contact-Handled Mixed Transuranic Waste Facilities | 2011 | 2012 | 200EW | 1.38×10 ¹ | 1.26 | 8.55×10 ⁻² | 1.85×10 ⁻² | 7.32×10 ⁻¹ |
| Remote-Handled Mixed Transuranic Waste Facility | 2020 | 2021 | 200E | 2.74 | 1.75×10 ⁻¹ | 1.17×10 ⁻² | 3.68×10 ⁻³ | 1.40×10 ⁻¹ |
| Transuranic Waste Interim Storage Facility | 2035 | 2035 | WTP_AS | a | a | a | a | a |
| Bulk Vitrification Facility, 200-West Area | | 2041 | 200W | 7.80×10 ⁻¹ | 1.66 | 1.76×10 ⁻¹ | 4.44×10 ⁻¹ | 8.25×10 ⁻¹ |
| Solid-Liquid Separations Facility | 2040 | 2041 | SUPW | 7.25 | 1.24 | 8.54×10 ⁻² | 9.77×10 ⁻³ | 4.26×10 ⁻¹ |
| Bulk Vitrification Facility, 200-East Area | 2040 | 2041 | 200E | 6.95×10 ⁻¹ | 2.58 | 2.75×10 ⁻¹ | 6.80×10 ⁻¹ | 7.90×10 ⁻¹ |
| Effluent Treatment Facility original | 2026 | 2026 | WTP_AS | 1.09×10 ² | 4.78×10 ¹ | 4.70×10 ² | 1.48×10 ⁻¹ | 8.47 |
| Effluent Treatment Facility replacement 1 | 2043 | 2043 | WTP_AS | 1.09×10 ² | 4.78×10 ¹ | 4.70×10 ² | 1.48×10 ⁻¹ | 8.47 |

Table G-15. Tank Closure Alternative 3A Criteria Pollutant Emissions (continued)

| Facility/System | Start Year | End Year | Location | Emission Rate (metric tons per year) | | | | |
|---|------------|----------|----------|--------------------------------------|----------------------|----------------------|-----------------------|-----------------------|
| | | | | Carbon Monoxide | Nitrogen Dioxide | PM ₁₀ | Sulfur Dioxide | VOCs |
| Deactivation (continued) | | | | | | | | |
| Evaporator original | 2018 | 2018 | 200E | 1.66 | 7.70 | 7.07 | 2.62×10 ⁻³ | 6.28×10 ⁻¹ |
| Evaporator replacement 1 | 2041 | 2041 | 200E | 1.66 | 7.70 | 7.07 | 2.62×10 ⁻³ | 6.28×10 ⁻¹ |
| Closure | | | | | | | | |
| Grout facility (tank-filling) construction | 2028 | 2029 | 200EW | 2.18 | 8.29 | 4.20 | 2.71×10 ⁻³ | 6.82×10 ⁻¹ |
| Grout facility (tank-filling) operations | 2030 | 2039 | 200EW | 2.25×10 ¹ | 8.32×10 ¹ | 4.51×10 ¹ | 2.70×10 ⁻² | 6.68 |
| Grout facility (tank-filling) deactivation | 2040 | 2040 | 200EW | 1.45 | 3.41 | 2.10×10 ¹ | 1.12×10 ⁻³ | 2.95×10 ⁻¹ |
| Ancillary equipment grouting | 2012 | 2032 | 200EW | 4.12×10 ⁻¹ | 1.79 | 1.94 | 5.73×10 ⁻⁴ | 1.38×10 ⁻¹ |
| Ancillary equipment removal | 2028 | 2033 | 200EW | 3.28 | 1.50×10 ¹ | 4.40×10 ¹ | 4.92×10 ⁻³ | 1.19 |
| BX and SX tank farm soil removal | 2028 | 2033 | 200EW | 3.99×10 ¹ | 1.13×10 ² | 2.56×10 ² | 3.73×10 ⁻² | 9.55 |
| Containment structure construction | 2024 | 2027 | 200EW | 6.78×10 ¹ | 7.06 | 2.74 | 2.19×10 ⁻³ | 2.91 |
| Containment structure deactivation | 2034 | 2036 | 200EW | 9.03×10 ¹ | 9.39 | 3.09 | 2.92×10 ⁻³ | 3.88 |
| Modified Resource Conservation and Recovery Act Subtitle C barrier construction | 2035 | 2041 | 200EW | 1.64×10 ³ | 1.50×10 ³ | 3.48×10 ³ | 2.27 | 1.83×10 ² |
| Decontamination and decommissioning of 10 selected facilities | 2018 | 2028 | 200EW | 2.53 | 9.81 | 8.56 | 3.22×10 ⁻³ | 7.93×10 ⁻¹ |
| Postclosure care | 2042 | 2141 | 200EW | a | a | a | a | a |

^a Emissions for this activity and pollutant were not calculated because annual fuel use for this activity and the resulting emissions would be small compared with those of other activities or would be zero.

Key: 200E=200-East Area; 200W=200-West Area; 200EW=200-East and 200-West Areas; 200EW+=200-East and 200-West Areas and Waste Treatment Plant area; HLW=high-level radioactive waste; IHLW=immobilized high-level radioactive waste; PM₁₀=particulate matter with an aerodynamic diameter less than or equal to 10 micrometers; SUPW=200-West Area supplemental treatment facility; VOC=volatile organic compound; WTP_AS=Waste Treatment Plant area source; WTP_PS=Waste Treatment Plant point source.

Source: SAIC 2007a, 2008.

Table G-16. Tank Closure Alternative 3A Toxic Pollutant Emissions

| Facility/System | Start Year | End Year | Location | Emission Rate (metric tons per year) | | | | | | |
|--|------------|----------|----------|--------------------------------------|-----------------------|-----------------------|-----------------------|---------|-----------------------|-----------------------|
| | | | | Ammonia | Benzene | 1,3-Butadiene | Formaldehyde | Mercury | Toluene | Xylene |
| Construction | | | | | | | | | | |
| Canister Storage Building | 2006 | 2016 | 200E | a | a | a | a | a | a | a |
| IHLW Shipping/Transfer Facility | 2011 | 2013 | 200E | a | a | a | a | a | a | a |
| IHLW Interim Storage Modules | 2014 | 2022 | 200E | a | a | a | a | a | a | a |
| Other infrastructure upgrades | 2006 | 2034 | 200EW | a | a | a | a | a | a | a |
| Tank upgrades | 2006 | 2025 | 200EW | 7.82×10 ⁻² | a | a | a | a | a | a |
| Waste Treatment Plant | 2006 | 2017 | WTP_AS | 9.98×10 ⁻¹ | 2.09×10 ⁻¹ | 5.81×10 ⁻³ | 1.89×10 ⁻¹ | a | 1.31 | 3.93×10 ⁻¹ |
| Cesium and Strontium Capsule Processing Facility | 2035 | 2038 | WTP_AS | 2.22×10 ⁻¹ | 1.27×10 ⁻¹ | 1.49×10 ⁻³ | 6.26×10 ⁻² | a | 1.63 | 4.64×10 ⁻¹ |
| Waste receiver facilities | 2013 | 2017 | 200EW | a | a | a | a | a | a | a |
| Tank risers | 2013 | 2016 | 200EW | 2.18 | a | a | a | a | a | a |
| Modified sluicing retrieval system | 2013 | 2039 | 200EW+ | 2.49×10 ⁻¹ | a | a | a | a | a | a |
| Mobile retrieval system | 2013 | 2026 | 200EW | 2.86×10 ⁻¹ | a | a | a | a | a | a |
| Vacuum-based retrieval system | 2027 | 2039 | 200EW | 4.56×10 ⁻¹ | a | a | a | a | a | a |
| HLW Melter Interim Storage Facility | 2015 | 2016 | WTP_AS | a | a | a | a | a | a | a |
| Contact-Handled Mixed Transuranic Waste Facilities | 2008 | 2008 | 200EW | 1.25×10 ⁻² | 5.38×10 ⁻³ | 7.94×10 ⁻⁵ | 3.07×10 ⁻³ | a | 6.25×10 ⁻² | 1.79×10 ⁻² |
| Remote-Handled Mixed Transuranic Waste Facility | 2013 | 2014 | 200E | 1.02×10 ⁻² | 4.42×10 ⁻³ | 6.51×10 ⁻⁵ | 2.52×10 ⁻³ | a | 5.12×10 ⁻² | 1.47×10 ⁻² |
| Transuranic Waste Interim Storage Facility | | 2009 | WTP_AS | a | a | a | a | a | a | a |
| Bulk Vitrification Facility, 200 West Area | 2016 | 2017 | 200W | 3.43×10 ⁻² | 1.48×10 ⁻² | 2.18×10 ⁻⁴ | 8.43×10 ⁻³ | a | 1.71×10 ⁻¹ | 4.90×10 ⁻² |
| Solid-Liquid Separations Facility | 2008 | 2016 | SUPW | 1.22×10 ⁻² | 4.74×10 ⁻³ | 7.63×10 ⁻⁵ | 2.87×10 ⁻³ | a | 5.23×10 ⁻² | 1.50×10 ⁻² |
| Bulk Vitrification Facility, 200-East Area | 2016 | 2017 | 200E | 3.43×10 ⁻² | 1.48×10 ⁻² | 2.18×10 ⁻⁴ | 8.43×10 ⁻³ | a | 1.71×10 ⁻¹ | 4.90×10 ⁻² |
| Effluent Treatment Facility replacement 1 | 2023 | 2025 | 200E | 3.81×10 ⁻¹ | 2.19×10 ⁻¹ | 2.55×10 ⁻³ | 1.08×10 ⁻¹ | a | 2.82 | 8.02×10 ⁻¹ |
| Evaporator replacement 1 | 2015 | 2017 | 200E | 1.19×10 ⁻¹ | 6.80×10 ⁻² | 7.95×10 ⁻⁴ | 3.35×10 ⁻² | a | 8.74×10 ⁻¹ | 2.49×10 ⁻¹ |
| Underground transfer line 1,000-foot sections | 2009 | 2009 | 200EW+ | a | a | a | a | a | a | a |
| Operations | | | | | | | | | | |
| IHLW Interim Storage Facility | 2018 | 2066 | WTP_AS | a | a | a | a | a | a | a |
| Other infrastructure upgrades | 2006 | 2039 | 200EW | a | a | a | a | a | a | a |
| Routine operations | 2006 | 2039 | 200EW | 1.18×10 ¹ | a | a | a | a | a | a |
| Retrieval operations | 2006 | 2039 | 200EW | 4.09×10 ⁻² | a | a | a | a | a | a |

Table G-16. Tank Closure Alternative 3A Toxic Pollutant Emissions (continued)

| Facility/System | Start Year | End Year | Location | Emission Rate (metric tons per year) | | | | | | |
|--|------------|----------|----------|--------------------------------------|-----------------------|-----------------------|-----------------------|-----------------------|-----------------------|-----------------------|
| | | | | Ammonia | Benzene | 1,3-Butadiene | Formaldehyde | Mercury | Toluene | Xylene |
| Operations (continued) | | | | | | | | | | |
| Double-shell tank interim stabilization | 2006 | 2039 | 200EW | 2.68×10 ⁻¹ | a | a | a | a | a | a |
| Waste Treatment Plant | 2018 | 2039 | WTP_PS | 1.51 | 9.54×10 ⁻³ | 3.44×10 ⁻⁶ | 1.06×10 ⁻⁴ | 6.11×10 ⁻² | 2.69×10 ⁻⁴ | 9.06×10 ⁻⁴ |
| Waste Treatment Plant, cesium and strontium capsules | 2040 | 2040 | WTP_PS | 1.51 | 9.54×10 ⁻³ | 3.44×10 ⁻⁶ | 1.06×10 ⁻⁴ | a | 2.69×10 ⁻⁴ | 9.06×10 ⁻⁴ |
| Cesium and Strontium Capsule Processing Facility | 2039 | 2040 | WTP_AS | 3.80×10 ⁻³ | 6.24×10 ⁻³ | 3.53×10 ⁻⁵ | 2.11×10 ⁻³ | a | 9.58×10 ⁻² | 2.70×10 ⁻² |
| Modified sluicing retrieval system | 2013 | 2039 | 200EW+ | 2.49×10 ⁻¹ | a | a | a | a | a | a |
| Mobile retrieval system | 2013 | 2026 | 200EW+ | 2.86×10 ⁻¹ | a | a | a | a | a | a |
| Vacuum-based retrieval system | 2027 | 2039 | 200EW | 4.56×10 ⁻¹ | a | a | a | a | a | a |
| HLW Melter Interim Storage Facility | 2018 | 2141 | WTP_AS | a | a | a | a | a | a | a |
| Contact-Handled Mixed Transuranic Waste Facilities | 2009 | 2010 | 200EW | 2.48×10 ⁻² | 1.94×10 ⁻² | 1.79×10 ⁻⁴ | 8.34×10 ⁻³ | a | 2.70×10 ⁻¹ | 7.66×10 ⁻² |
| Remote-Handled Mixed Transuranic Waste Facility | 2015 | 2019 | 200E | 3.75×10 ⁻³ | 3.73×10 ⁻³ | 2.89×10 ⁻⁵ | 1.46×10 ⁻³ | a | 5.39×10 ⁻² | 1.53×10 ⁻² |
| Transuranic Waste Interim Storage Facility | 2009 | 2034 | WTP_AS | a | a | a | a | a | a | a |
| Bulk Vitrification Facility, 200-West Area | 2018 | 2039 | 200W | 9.36×10 ⁻³ | 2.19×10 ⁻⁴ | 2.52×10 ⁻⁸ | 1.07×10 ⁻⁶ | 9.95×10 ⁻³ | 2.83×10 ⁻⁵ | 8.06×10 ⁻⁵ |
| Solid-Liquid Separations Facility | 2018 | 2039 | SUPW | 2.20×10 ⁻² | 1.13×10 ⁻² | 1.44×10 ⁻⁴ | 5.29×10 ⁻³ | a | 1.40×10 ⁻¹ | 3.99×10 ⁻² |
| Bulk Vitrification Facility, 200-East Area | 2018 | 2039 | 200E | 1.30×10 ⁻² | 2.09×10 ⁻⁴ | 3.27×10 ⁻⁸ | 1.24×10 ⁻⁶ | 1.10×10 ⁻² | 2.35×10 ⁻⁵ | 6.74×10 ⁻⁵ |
| Effluent Treatment Facility | 2006 | 2042 | WTP_PS | 4.54×10 ⁻³ | 1.71×10 ⁻³ | 2.83×10 ⁻⁵ | 1.05×10 ⁻³ | a | 1.86×10 ⁻² | 5.35×10 ⁻³ |
| Evaporator | 2006 | 2040 | 200E | 8.97×10 ⁻² | 1.21×10 ⁻² | 5.06×10 ⁻⁴ | 1.53×10 ⁻² | a | 5.29×10 ⁻³ | 3.69×10 ⁻³ |
| Borrow Area C | 2006 | 2052 | Area C | 1.78×10 ⁻¹ | 3.12×10 ⁻² | 1.02×10 ⁻³ | 3.21×10 ⁻² | a | 1.32×10 ⁻¹ | 4.15×10 ⁻² |
| Deactivation | | | | | | | | | | |
| Modified sluicing retrieval system | 2013 | 2039 | 200EW+ | a | a | a | a | a | a | a |
| Mobile retrieval system | 2013 | 2026 | 200EW | a | a | a | a | a | a | a |
| Vacuum-based retrieval system | 2027 | 2039 | 200EW | a | a | a | a | a | a | a |
| IHLW Interim Storage Facility | 2067 | 2067 | WTP_AS | a | a | a | a | a | a | a |
| Waste Treatment Plant | 2041 | 2042 | WTP_AS | 1.51×10 ⁻¹ | 9.54×10 ⁻⁴ | 3.44×10 ⁻⁷ | 1.06×10 ⁻⁵ | 6.11×10 ⁻³ | 2.69×10 ⁻⁵ | 9.06×10 ⁻⁵ |
| Cesium and Strontium Capsule Processing Facility | 2041 | 2041 | WTP_AS | 1.75×10 ⁻³ | 2.88×10 ⁻³ | 1.63×10 ⁻⁵ | 9.76×10 ⁻⁴ | a | 4.42×10 ⁻² | 1.25×10 ⁻² |
| Contact-Handled Mixed Transuranic Waste Facilities | 2011 | 2012 | 200EW | 2.48×10 ⁻³ | 1.94×10 ⁻³ | 1.79×10 ⁻⁵ | 8.34×10 ⁻⁴ | a | 2.70×10 ⁻² | 7.66×10 ⁻³ |

Table G-16. Tank Closure Alternative 3A Toxic Pollutant Emissions (*continued*)

| Facility/System | Start Year | End Year | Location | Emission Rate (metric tons per year) | | | | | | |
|---|------------|----------|----------|--------------------------------------|-----------------------|-----------------------|-----------------------|-----------------------|-----------------------|-----------------------|
| | | | | Ammonia | Benzene | 1,3-Butadiene | Formaldehyde | Mercury | Toluene | Xylene |
| Deactivation (<i>continued</i>) | | | | | | | | | | |
| Remote-Handled Mixed Transuranic Waste Facility | 2020 | 2021 | 200E | 3.75×10^{-4} | 3.73×10^{-4} | 2.89×10^{-6} | 1.46×10^{-4} | a | 5.39×10^{-3} | 1.53×10^{-3} |
| Transuranic Waste Interim Storage Facility | 2035 | 2035 | WTP_AS | a | a | a | a | a | a | a |
| Bulk Vitrification Facility, 200-West Area | 2040 | 2041 | 200W | 9.36×10^{-4} | 2.19×10^{-5} | 2.52×10^{-9} | 1.07×10^{-7} | 9.95×10^{-4} | 2.83×10^{-6} | 8.06×10^{-6} |
| Solid-Liquid Separations Facility | 2040 | 2041 | SUPW | 2.20×10^{-3} | 1.13×10^{-3} | 1.44×10^{-5} | 5.29×10^{-4} | a | 1.40×10^{-2} | 3.99×10^{-3} |
| Bulk Vitrification Facility, 200-East Area | 2040 | 2041 | 200E | 1.30×10^{-2} | 2.09×10^{-4} | 3.27×10^{-8} | 1.24×10^{-6} | 1.10×10^{-2} | 2.35×10^{-5} | 6.74×10^{-5} |
| Effluent Treatment Facility original | 2026 | 2026 | WTP_AS | 7.88×10^{-2} | 2.23×10^{-2} | 4.73×10^{-4} | 1.64×10^{-2} | a | 2.00×10^{-1} | 5.81×10^{-2} |
| Effluent Treatment Facility replacement 1 | 2043 | 2043 | WTP_AS | 7.88×10^{-2} | 2.23×10^{-2} | 4.73×10^{-4} | 1.64×10^{-2} | a | 2.00×10^{-1} | 5.81×10^{-2} |
| Evaporator original | 2018 | 2018 | 200E | 1.21×10^{-2} | 1.63×10^{-3} | 6.82×10^{-5} | 2.06×10^{-3} | a | 7.14×10^{-4} | 4.97×10^{-4} |
| Evaporator replacement 1 | 2041 | 2041 | 200E | 1.21×10^{-2} | 1.63×10^{-3} | 6.82×10^{-5} | 2.06×10^{-3} | a | 7.14×10^{-4} | 4.97×10^{-4} |
| Closure | | | | | | | | | | |
| Grout facility (tank-filling) construction | 2028 | 2029 | 200EW | 3.33×10^{-2} | a | a | a | a | a | a |
| Grout facility (tank-filling) operations | 2030 | 2039 | 200EW | 1.17×10^{-2} | a | a | a | a | a | a |
| Grout facility (tank-filling) deactivation | 2040 | 2040 | 200EW | a | a | a | a | a | a | a |
| Ancillary equipment grouting | 2012 | 2032 | 200EW | 3.20×10^{-5} | a | a | a | a | a | a |
| Ancillary equipment removal | 2028 | 2033 | 200EW | 1.72×10^{-5} | a | a | a | a | a | a |
| BX and SX tank farm soil removal | 2028 | 2033 | 200EW | 8.33×10^{-4} | a | a | a | a | a | a |
| Containment structure construction | 2024 | 2027 | 200EW | a | a | a | a | a | a | a |
| Containment structure deactivation | 2034 | 2036 | 200EW | a | a | a | a | a | a | a |
| Modified Resource Conservation and Recovery Act Subtitle C barrier construction | 2035 | 2041 | 200EW | 2.41 | 4.80×10^{-1} | 1.39×10^{-2} | 4.49×10^{-1} | a | 2.75 | 8.32×10^{-1} |
| Decontamination and decommissioning of 10 selected facilities | 2018 | 2028 | 200EW | a | a | a | a | a | a | a |
| Postclosure care | 2042 | 2141 | 200EW | a | a | a | a | a | a | a |

^a Emissions for this activity and pollutant were not calculated because annual fuel use for this activity and the resulting emissions would be small compared with those of other activities or would be zero.

Key: 200E=200-East Area; 200W=200-West Area; 200EW=200-East and 200-West Areas; 200EW+=200-East and 200-West Areas and Waste Treatment Plant area; HLW=high-level radioactive waste; IHLW=immobilized high-level radioactive waste; SUPW=200-West Area supplemental treatment facility; WTP_AS=Waste Treatment Plant area source; WTP_PS=Waste Treatment Plant point source.

Source: SAIC 2007a, 2008.

Table G-17. Tank Closure Alternative 3B Criteria Pollutant Emissions

| Facility/System | Start Year | End Year | Location | Emission Rate (metric tons per year) | | | | |
|--|------------|----------|----------|--------------------------------------|-----------------------|-----------------------|-----------------------|-----------------------|
| | | | | Carbon Monoxide | Nitrogen Dioxide | PM ₁₀ | Sulfur Dioxide | VOCs |
| Construction | | | | | | | | |
| Canister Storage Building | 2006 | 2016 | 200E | 5.54 | 1.28 | 9.05×10 ⁻¹ | 4.02×10 ⁻⁴ | 2.86×10 ⁻¹ |
| IHLW Shipping/Transfer Facility | 2011 | 2013 | 200E | 5.68×10 ¹ | 6.72×10 ¹ | 9.81×10 ¹ | 2.18×10 ⁻² | 6.50 |
| IHLW Interim Storage Modules | 2014 | 2022 | 200E | 4.00×10 ¹ | 4.76×10 ¹ | 1.58×10 ² | 1.45×10 ⁻² | 4.33 |
| Other infrastructure upgrades | 2006 | 2034 | 200EW | 1.11 | 8.05×10 ⁻¹ | 1.13 | 2.54×10 ⁻⁴ | 9.43×10 ⁻² |
| Tank upgrades | 2006 | 2025 | 200EW | 3.49×10 ² | 4.41×10 ¹ | 8.07 | 1.38×10 ⁻² | 1.56×10 ¹ |
| Waste Treatment Plant | 2006 | 2017 | WTP_AS | 7.64×10 ² | 6.20×10 ² | 4.16×10 ² | 1.05 | 7.99×10 ¹ |
| Cesium and Strontium Capsule Processing Facility | 2035 | 2038 | WTP_AS | 8.41×10 ² | 1.22×10 ² | 1.80×10 ¹ | 1.13 | 4.10 |
| Waste receiver facilities | 2013 | 2017 | 200EW | 1.15×10 ² | 9.65×10 ¹ | 3.31×10 ² | 2.92×10 ⁻² | 9.94 |
| Tank risers | 2013 | 2016 | 200EW | 1.84×10 ¹ | 8.19 | 7.42×10 ⁻¹ | 1.72×10 ⁻³ | 2.06 |
| Modified sluicing retrieval system | 2013 | 2039 | 200EW+ | 7.68×10 ¹ | 2.96 | 1.64 | 7.11×10 ⁻⁴ | 3.01 |
| Mobile retrieval system | 2013 | 2026 | 200EW | 7.17×10 ¹ | 3.11×10 ¹ | 5.98 | 9.97×10 ⁻³ | 4.74 |
| Vacuum-based retrieval system | 2027 | 2039 | 200EW | 7.72×10 ¹ | 3.49×10 ¹ | 7.02 | 1.11×10 ⁻² | 5.25 |
| HLW Melter Interim Storage Facility | 2015 | 2016 | WTP_AS | 6.17×10 ⁻¹ | 1.39 | 1.72×10 ¹ | 2.87×10 ⁻⁴ | 6.73×10 ⁻² |
| Contact-Handled Mixed Transuranic Waste Facilities | 2008 | 2008 | 200EW | 3.27×10 ¹ | 7.22 | 7.03 | 4.41×10 ⁻² | 2.04 |
| Remote-Handled Mixed Transuranic Waste Facility | 2013 | 2014 | 200E | 2.68×10 ¹ | 5.92 | 3.02 | 3.62×10 ⁻² | 1.67 |
| Transuranic Waste Interim Storage Facility | 2008 | 2009 | WTP_AS | 8.66×10 ⁻¹ | 2.53 | 2.08×10 ¹ | 6.38×10 ⁻⁴ | 1.46×10 ⁻¹ |
| Cast Stone Facility, 200-West Area | 2016 | 2017 | 200W | 6.11×10 ¹ | 1.35×10 ¹ | 2.57×10 ¹ | 8.25×10 ⁻² | 3.81 |
| Solid-Liquid Separations Facility | 2016 | 2017 | SUPW | 2.75×10 ¹ | 7.15 | 8.74 | 3.72×10 ⁻² | 1.79 |
| Cast Stone Facility, 200-East Area | 2016 | 2017 | 200E | 6.11×10 ¹ | 1.35×10 ¹ | 2.57×10 ¹ | 8.25×10 ⁻² | 3.81 |
| Effluent Treatment Facility replacement 1 | 2023 | 2025 | 200E | 1.45×10 ³ | 2.09×10 ² | 9.48×10 ² | 1.96 | 8.25×10 ¹ |
| Evaporator replacement 1 | 2015 | 2017 | 200E | 4.51×10 ² | 6.53×10 ¹ | 1.76×10 ¹ | 6.07×10 ⁻¹ | 2.56×10 ¹ |
| Underground transfer line 1,000-foot sections | 2009 | 2009 | 200EW+ | 7.59×10 ¹ | 2.71×10 ¹ | 2.41×10 ¹ | 8.75×10 ⁻³ | 4.47 |
| Operations | | | | | | | | |
| IHLW Interim Storage Facility | 2018 | 2066 | WTP_AS | a | a | a | a | a |
| Other infrastructure upgrades | 2006 | 2039 | 200EW | a | a | a | a | a |
| Routine operations | 2006 | 2039 | 200EW | 1.36×10 ¹ | 1.55×10 ¹ | a | a | 5.40 |
| Retrieval operations | 2006 | 2039 | 200EW | 4.72×10 ⁻² | 5.35×10 ⁻² | a | a | 1.89×10 ⁻² |
| Double-shell tank interim stabilization | 2006 | 2039 | 200EW | 3.09×10 ⁻¹ | 3.51×10 ⁻¹ | a | a | 1.24×10 ⁻¹ |
| Waste Treatment Plant | 2018 | 2039 | WTP_PS | 1.01×10 ² | 2.22×10 ² | 3.61 | 1.08×10 ¹ | 3.66×10 ² |
| Waste Treatment Plant, cesium and strontium capsules | 2040 | 2040 | WTP_PS | 1.01×10 ² | 2.22×10 ² | 3.61 | 1.08×10 ¹ | 3.66×10 ² |

Table G-17. Tank Closure Alternative 3B Criteria Pollutant Emissions (*continued*)

| Facility/System | Start Year | End Year | Location | Emission Rate (metric tons per year) | | | | |
|--|------------|----------|----------|--------------------------------------|-----------------------|-----------------------|-----------------------|-----------------------|
| | | | | Carbon Monoxide | Nitrogen Dioxide | PM ₁₀ | Sulfur Dioxide | VOCs |
| Operations (<i>continued</i>) | | | | | | | | |
| Cesium and Strontium Capsule Processing Facility | 2039 | 2040 | WTP_AS | 4.85×10 ¹ | 1.29 | 5.53×10 ¹ | 6.49×10 ⁻² | 2.34 |
| Modified sluicing retrieval system | 2013 | 2039 | 200EW+ | 2.13×10 ¹ | 1.32 | 1.02×10 ⁻¹ | 3.39×10 ⁻⁴ | 9.16×10 ⁻¹ |
| Mobile retrieval system | 2013 | 2026 | 200EW+ | 3.29×10 ⁻¹ | 3.73×10 ⁻¹ | a | a | 1.32×10 ⁻¹ |
| Vacuum-based retrieval system | 2027 | 2039 | 200EW | 5.26×10 ⁻¹ | 5.97×10 ⁻¹ | a | a | 2.11×10 ⁻¹ |
| HLW Melter Interim Storage Facility | 2018 | 2141 | WTP_AS | a | a | a | a | a |
| Contact-Handled Mixed Transuranic Waste Facilities | 2009 | 2010 | 200EW | 1.38×10 ² | 1.26×10 ¹ | 8.55×10 ⁻¹ | 1.85×10 ⁻¹ | 7.32 |
| Remote-Handled Mixed Transuranic Waste Facility | 2015 | 2019 | 200E | 2.74×10 ¹ | 1.75 | 1.17×10 ⁻¹ | 3.68×10 ⁻² | 1.40 |
| Transuranic Waste Interim Storage Facility | 2009 | 2034 | WTP_AS | a | a | a | a | a |
| Cast Stone Facility, 200-West Area | 2018 | 2039 | 200W | 1.48×10 ² | 3.20×10 ¹ | 2.25 | 2.00×10 ⁻¹ | 9.19 |
| Solid-Liquid Separations Facility | 2018 | 2039 | SUPW | 7.25×10 ¹ | 1.24×10 ¹ | 8.54×10 ⁻¹ | 9.77×10 ⁻² | 4.26 |
| Cast Stone Facility, 200-East Area | 2018 | 2039 | 200E | 1.27×10 ² | 4.88×10 ¹ | 3.45 | 1.73×10 ⁻¹ | 9.41 |
| Effluent Treatment Facility | 2006 | 2042 | WTP_PS | 9.84 | 2.67 | 9.34×10 ² | 1.33×10 ⁻² | 6.48×10 ⁻¹ |
| Evaporator | 2006 | 2040 | 200E | 1.23×10 ¹ | 5.70×10 ¹ | 1.71×10 ¹ | 1.94×10 ⁻² | 4.66 |
| Borrow Area C | 2006 | 2052 | Area C | 8.52×10 ¹ | 1.12×10 ² | 2.30×10 ² | 1.20×10 ⁻¹ | 1.20×10 ¹ |
| Deactivation | | | | | | | | |
| Modified sluicing retrieval system | 2013 | 2039 | 200EW+ | 5.47×10 ¹ | 2.31 | 2.04×10 ⁻¹ | 6.79×10 ⁻⁴ | 2.10 |
| Mobile retrieval system | 2013 | 2026 | 200EW | 3.58×10 ¹ | 2.81 | 2.33×10 ⁻¹ | 8.57×10 ⁻⁴ | 1.48 |
| Vacuum-based retrieval system | 2027 | 2039 | 200EW | 1.68 | 1.32×10 ⁻¹ | 1.20×10 ⁻² | 4.03×10 ⁻⁵ | 6.87×10 ⁻² |
| IHLW Interim Storage Facility | 2067 | 2067 | WTP_AS | a | a | a | a | a |
| Waste Treatment Plant | 2041 | 2042 | WTP_AS | 1.01×10 ¹ | 2.22×10 ¹ | 3.61×10 ⁻¹ | 1.08 | 3.66×10 ¹ |
| Cesium and Strontium Capsule Processing Facility | 2041 | 2041 | WTP_AS | 2.24×10 ¹ | 5.96×10 ⁻¹ | 2.55×10 ¹ | 3.00×10 ⁻² | 1.08 |
| Contact-Handled Mixed Transuranic Waste Facilities | 2011 | 2012 | 200EW | 1.38×10 ¹ | 1.26 | 8.55×10 ⁻² | 1.85×10 ⁻² | 7.32×10 ⁻¹ |
| Remote-Handled Mixed Transuranic Waste Facility | 2020 | 2021 | 200E | 2.74 | 1.75×10 ⁻¹ | 1.17×10 ⁻² | 3.68×10 ⁻³ | 1.40×10 ⁻¹ |
| Transuranic Waste Interim Storage Facility | 2035 | 2035 | WTP_AS | a | a | a | a | a |
| Cast Stone Facility, 200-West Area | 2040 | 2041 | 200W | 1.48×10 ¹ | 3.20 | 2.25×10 ⁻¹ | 2.00×10 ⁻² | 9.19×10 ⁻¹ |
| Solid-Liquid Separations Facility | 2040 | 2041 | SUPW | 7.25 | 1.24 | 8.54×10 ⁻² | 9.77×10 ⁻³ | 4.26×10 ⁻¹ |
| Cast Stone Facility, 200-East Area | 2040 | 2041 | 200E | 1.27×10 ¹ | 4.88 | 3.45×10 ⁻¹ | 1.73×10 ⁻² | 9.41×10 ⁻¹ |
| Effluent Treatment Facility original | 2026 | 2026 | WTP_AS | 1.09×10 ² | 4.78×10 ¹ | 4.70×10 ² | 1.48×10 ⁻¹ | 8.47 |
| Effluent Treatment Facility replacement 1 | 2043 | 2043 | WTP_AS | 1.09×10 ² | 4.78×10 ¹ | 4.70×10 ² | 1.48×10 ⁻¹ | 8.47 |

Table G-17. Tank Closure Alternative 3B Criteria Pollutant Emissions (continued)

| Facility/System | Start Year | End Year | Location | Emission Rate (metric tons per year) | | | | |
|---|------------|----------|----------|--------------------------------------|----------------------|----------------------|-----------------------|-----------------------|
| | | | | Carbon Monoxide | Nitrogen Dioxide | PM ₁₀ | Sulfur Dioxide | VOCs |
| Deactivation (continued) | | | | | | | | |
| Evaporator original | 2018 | 2018 | 200E | 1.66 | 7.70 | 7.07 | 2.62×10 ⁻³ | 6.28×10 ⁻¹ |
| Evaporator replacement 1 | 2041 | 2041 | 200E | 1.66 | 7.70 | 7.07 | 2.62×10 ⁻³ | 6.28×10 ⁻¹ |
| Closure | | | | | | | | |
| Grout facility (tank-filling) construction | 2028 | 2029 | 200EW | 2.18 | 8.29 | 4.20 | 2.71×10 ⁻³ | 6.82×10 ⁻¹ |
| Grout facility (tank-filling) operations | 2030 | 2039 | 200EW | 2.25×10 ¹ | 8.32×10 ¹ | 4.51×10 ¹ | 2.70×10 ⁻² | 6.68 |
| Grout facility (tank-filling) deactivation | 2040 | 2040 | 200EW | 1.45 | 3.41 | 2.10×10 ¹ | 1.12×10 ⁻³ | 2.95×10 ⁻¹ |
| Ancillary equipment grouting | 2012 | 2032 | 200EW | 4.12×10 ⁻¹ | 1.79 | 1.94 | 5.73×10 ⁻⁴ | 1.38×10 ⁻¹ |
| Ancillary equipment removal | 2028 | 2033 | 200EW | 3.28 | 1.50×10 ¹ | 4.40×10 ¹ | 4.92×10 ⁻³ | 1.19 |
| BX and SX tank farm soil removal | 2028 | 2033 | 200EW | 3.99×10 ¹ | 1.13×10 ² | 2.56×10 ² | 3.73×10 ⁻² | 9.55 |
| Containment structure construction | 2024 | 2027 | 200EW | 6.78×10 ¹ | 7.06 | 2.74 | 2.19×10 ⁻³ | 2.91 |
| Containment structure deactivation | 2034 | 2036 | 200EW | 9.03×10 ¹ | 9.39 | 3.09 | 2.92×10 ⁻³ | 3.88 |
| Modified Resource Conservation and Recovery Act Subtitle C barrier construction | 2035 | 2041 | 200EW | 1.64×10 ³ | 1.50×10 ³ | 3.48×10 ³ | 2.27 | 1.83×10 ² |
| Decontamination and decommissioning of 10 selected facilities | 2018 | 2028 | 200EW | 2.53 | 9.81 | 8.56 | 3.22×10 ⁻³ | 7.93×10 ⁻¹ |
| Postclosure care | 2042 | 2141 | 200EW | a | a | a | a | a |

^a Emissions for this activity and pollutant were not calculated because annual fuel use for this activity and the resulting emissions would be small compared with those of other activities or would be zero.

Key: 200E=200-East Area; 200W=200-West Area; 200EW=200-East and 200-West Areas; 200EW+=200-East and 200-West Areas and Waste Treatment Plant area; HLW=high-level radioactive waste; IHLW=immobilized high-level radioactive waste; PM₁₀=particulate matter with an aerodynamic diameter less than or equal to 10 micrometers; VOC=volatile organic compound; SUPW=200-West Area supplemental treatment facility; WTP_AS=Waste Treatment Plant area source; WTP_PS=Waste Treatment Plant point source.

Source: SAIC 2007a, 2008.

Table G-18. Tank Closure Alternative 3B Toxic Pollutant Emissions

| Facility/System | Start Year | End Year | Location | Emission Rate (metric tons per year) | | | | | | |
|--|------------|----------|----------|--------------------------------------|-----------------------|-----------------------|-----------------------|---------|-----------------------|-----------------------|
| | | | | Ammonia | Benzene | 1,3-Butadiene | Formaldehyde | Mercury | Toluene | Xylene |
| Construction | | | | | | | | | | |
| Canister Storage Building | 2006 | 2016 | 200E | a | a | a | a | a | a | a |
| IHLW Shipping/Transfer Facility | 2011 | 2013 | 200E | a | a | a | a | a | a | a |
| IHLW Interim Storage Modules | 2014 | 2022 | 200E | a | a | a | a | a | a | a |
| Other infrastructure upgrades | 2006 | 2034 | 200EW | a | a | a | a | a | a | a |
| Tank upgrades | 2006 | 2025 | 200EW | 7.82×10 ⁻² | a | a | a | a | a | a |
| Waste Treatment Plant | 2006 | 2017 | WTP_AS | 9.98×10 ⁻¹ | 2.09×10 ⁻¹ | 5.81×10 ⁻³ | 1.89×10 ⁻¹ | a | 1.31 | 3.93×10 ⁻¹ |
| Cesium and Strontium Capsule Processing Facility | 2035 | 2038 | WTP_AS | 2.22×10 ⁻¹ | 1.27×10 ⁻¹ | 1.49×10 ⁻³ | 6.26×10 ⁻² | a | 1.63 | 4.64×10 ⁻¹ |
| Waste receiver facilities | 2013 | 2017 | 200EW | a | a | a | a | a | a | a |
| Tank risers | 2013 | 2016 | 200EW | 2.18 | a | a | a | a | a | a |
| Modified sluicing retrieval system | 2013 | 2039 | 200EW+ | 2.49×10 ⁻¹ | a | a | a | a | a | a |
| Mobile retrieval system | 2013 | 2026 | 200EW | 2.86×10 ⁻¹ | a | a | a | a | a | a |
| Vacuum-based retrieval system | 2027 | 2039 | 200EW | 4.56×10 ⁻¹ | a | a | a | a | a | a |
| HLW Melter Interim Storage Facility | 2015 | 2016 | WTP_AS | a | a | a | a | a | a | a |
| Contact-Handled Mixed Transuranic Waste Facilities | 2008 | 2008 | 200EW | 1.25×10 ⁻² | 5.38×10 ⁻³ | 7.94×10 ⁻⁵ | 3.07×10 ⁻³ | a | 6.25×10 ⁻² | 1.79×10 ⁻² |
| Remote-Handled Mixed Transuranic Waste Facility | 2013 | 2014 | 200E | 1.02×10 ⁻² | 4.42×10 ⁻³ | 6.51×10 ⁻⁵ | 2.52×10 ⁻³ | a | 5.12×10 ⁻² | 1.47×10 ⁻² |
| Transuranic Waste Interim Storage Facility | | 2009 | WTP_AS | a | a | a | a | a | a | a |
| Cast Stone Facility, 200-West Area | 2016 | 2017 | 200W | 2.34×10 ⁻² | 1.01×10 ⁻² | 1.49×10 ⁻⁴ | 5.75×10 ⁻³ | a | 1.17×10 ⁻¹ | 3.35×10 ⁻² |
| Solid-Liquid Separations Facility | 2008 | 2016 | SUPW | 1.22×10 ⁻² | 4.74×10 ⁻³ | 7.63×10 ⁻⁵ | 2.87×10 ⁻³ | a | 5.23×10 ⁻² | 1.50×10 ⁻² |
| Cast Stone Facility, 200-East Area | 2016 | 2017 | 200E | 2.34×10 ⁻² | 1.01×10 ⁻² | 1.49×10 ⁻⁴ | 5.75×10 ⁻³ | a | 1.17×10 ⁻¹ | 3.35×10 ⁻² |
| Effluent Treatment Facility | 2023 | 2025 | 200E | 3.81×10 ⁻¹ | 2.19×10 ⁻¹ | 2.55×10 ⁻³ | 1.08×10 ⁻¹ | a | 2.82 | 8.02×10 ⁻¹ |
| Evaporator | 2015 | 2017 | 200E | 1.19×10 ⁻¹ | 6.80×10 ⁻² | 7.95×10 ⁻⁴ | 3.35×10 ⁻² | a | 8.74×10 ⁻¹ | 2.49×10 ⁻¹ |
| Underground transfer line 1,000-foot sections | 2009 | 2009 | 200EW+ | a | a | a | a | a | a | a |
| Operations | | | | | | | | | | |
| IHLW Interim Storage Facility | 2018 | 2066 | WTP_AS | a | a | a | a | a | a | a |
| Other infrastructure upgrades | 2006 | 2039 | 200EW | a | a | a | a | a | a | a |
| Routine operations | 2006 | 2039 | 200EW | 1.18×10 ¹ | a | a | a | a | a | a |
| Retrieval operations | 2006 | 2039 | 200EW | 4.09×10 ⁻² | a | a | a | a | a | a |

Table G–18. Tank Closure Alternative 3B Toxic Pollutant Emissions (continued)

| Facility/System | Start Year | End Year | Location | Emission Rate (metric tons per year) | | | | | | |
|--|------------|----------|----------|--------------------------------------|-----------------------|-----------------------|-----------------------|-----------------------|-----------------------|-----------------------|
| | | | | Ammonia | Benzene | 1,3-Butadiene | Formaldehyde | Mercury | Toluene | Xylene |
| Operations (continued) | | | | | | | | | | |
| Double-shell tank interim stabilization | 2006 | 2039 | 200EW | 2.68×10 ⁻¹ | a | a | a | a | a | a |
| Waste Treatment Plant | 2018 | 2039 | WTP_PS | 1.51 | 9.54×10 ⁻³ | 3.44×10 ⁻⁶ | 1.06×10 ⁻⁴ | 6.11×10 ⁻² | 2.69×10 ⁻⁴ | 9.06×10 ⁻⁴ |
| Waste Treatment Plant, cesium and strontium capsules | 2040 | 2040 | WTP_PS | 1.51 | 9.54×10 ⁻³ | 3.44×10 ⁻⁶ | 1.06×10 ⁻⁴ | a | 2.69×10 ⁻⁴ | 9.06×10 ⁻⁴ |
| Cesium and Strontium Capsule Processing Facility | 2039 | 2040 | WTP_AS | 3.80×10 ⁻³ | 6.24×10 ⁻³ | 3.53×10 ⁻⁵ | 2.11×10 ⁻³ | a | 9.58×10 ⁻² | 2.70×10 ⁻² |
| Modified sluicing retrieval system | 2013 | 2039 | 200EW+ | 2.49×10 ⁻¹ | a | a | a | a | a | a |
| Mobile retrieval system | 2013 | 2026 | 200EW+ | 2.86×10 ⁻¹ | a | a | a | a | a | a |
| Vacuum-based retrieval system | 2027 | 2039 | 200EW | 4.56×10 ⁻¹ | a | a | a | a | a | a |
| HLW Melter Interim Storage Facility | 2018 | 2141 | WTP_AS | a | a | a | a | a | a | a |
| Contact-Handled Mixed Transuranic Waste Facilities | 2009 | 2010 | 200EW | 2.48×10 ⁻² | 1.94×10 ⁻² | 1.79×10 ⁻⁴ | 8.34×10 ⁻³ | a | 2.70×10 ⁻¹ | 7.66×10 ⁻² |
| Remote-Handled Mixed Transuranic Waste Facility | 2015 | 2019 | 200E | 3.75×10 ⁻³ | 3.73×10 ⁻³ | 2.89×10 ⁻⁵ | 1.46×10 ⁻³ | a | 5.39×10 ⁻² | 1.53×10 ⁻² |
| Transuranic Waste Interim Storage Facility | 2009 | 2034 | WTP_AS | a | a | a | a | a | a | a |
| Cast Stone Facility, 200-West Area | 2018 | 2039 | 200W | 5.55×10 ⁻² | 2.43×10 ⁻² | 3.53×10 ⁻⁴ | 1.38×10 ⁻² | a | 2.84×10 ⁻¹ | 8.13×10 ⁻² |
| Solid-Liquid Separations Facility | 2018 | 2039 | SUPW | 2.20×10 ⁻² | 1.13×10 ⁻² | 1.44×10 ⁻⁴ | 5.29×10 ⁻³ | a | 1.40×10 ⁻¹ | 3.99×10 ⁻² |
| Cast Stone Facility, 200-East Area | 2018 | 2039 | 200E | 8.10×10 ⁻² | 2.48×10 ⁻² | 4.90×10 ⁻⁴ | 1.73×10 ⁻² | a | 2.36×10 ⁻¹ | 6.86×10 ⁻² |
| Effluent Treatment Facility replacement 1 | 2006 | 2042 | WTP_PS | 4.54×10 ⁻³ | 1.71×10 ⁻³ | 2.83×10 ⁻⁵ | 1.05×10 ⁻³ | a | 1.86×10 ⁻² | 5.35×10 ⁻³ |
| Evaporator replacement 1 | 2006 | 2040 | 200E | 8.97×10 ⁻² | 1.21×10 ⁻² | 5.06×10 ⁻⁴ | 1.53×10 ⁻² | a | 5.29×10 ⁻³ | 3.69×10 ⁻³ |
| Borrow Area C | 2006 | 2052 | Area C | 1.78×10 ⁻¹ | 3.12×10 ⁻² | 1.02×10 ⁻³ | 3.21×10 ⁻² | a | 1.32×10 ⁻¹ | 4.15×10 ⁻² |
| Deactivation | | | | | | | | | | |
| Modified sluicing retrieval system | 2013 | 2039 | 200EW+ | a | a | a | a | a | a | a |
| Mobile retrieval system | 2013 | 2026 | 200EW | a | a | a | a | a | a | a |
| Vacuum-based retrieval system | 2027 | 2039 | 200EW | a | a | a | a | a | a | a |
| IHLW Interim Storage Facility | 2067 | 2067 | WTP_AS | a | a | a | a | a | a | a |
| Waste Treatment Plant | 2041 | 2042 | WTP_AS | 1.51×10 ⁻¹ | 9.54×10 ⁻⁴ | 3.44×10 ⁻⁷ | 1.06×10 ⁻⁵ | 6.11×10 ⁻³ | 2.69×10 ⁻⁵ | 9.06×10 ⁻⁵ |
| Cesium and Strontium Capsule Processing Facility | 2041 | 2041 | WTP_AS | 1.75×10 ⁻³ | 2.88×10 ⁻³ | 1.63×10 ⁻⁵ | 9.76×10 ⁻⁴ | a | 4.42×10 ⁻² | 1.25×10 ⁻² |
| Contact-Handled Mixed Transuranic Waste Facilities | 2011 | 2012 | 200EW | 2.48×10 ⁻³ | 1.94×10 ⁻³ | 1.79×10 ⁻⁵ | 8.34×10 ⁻⁴ | a | 2.70×10 ⁻² | 7.66×10 ⁻³ |

Table G-18. Tank Closure Alternative 3B Toxic Pollutant Emissions (*continued*)

| Facility/System | Start Year | End Year | Location | Emission Rate (metric tons per year) | | | | | | |
|---|------------|----------|----------|--------------------------------------|-----------------------|-----------------------|-----------------------|---------|-----------------------|-----------------------|
| | | | | Ammonia | Benzene | 1,3-Butadiene | Formaldehyde | Mercury | Toluene | Xylene |
| Deactivation (<i>continued</i>) | | | | | | | | | | |
| Remote-Handled Mixed Transuranic Waste Facility | 2020 | 2021 | 200E | 3.75×10^{-4} | 3.73×10^{-4} | 2.89×10^{-6} | 1.46×10^{-4} | a | 5.39×10^{-3} | 1.53×10^{-3} |
| Transuranic Waste Interim Storage Facility | 2035 | 2035 | WTP_AS | a | a | a | a | a | a | a |
| Cast Stone Facility, 200-West Area | 2040 | 2041 | 200W | 5.55×10^{-3} | 2.43×10^{-3} | 3.53×10^{-5} | 1.38×10^{-3} | a | 2.84×10^{-2} | 8.13×10^{-3} |
| Solid-Liquid Separations Facility | 2040 | 2041 | SUPW | 2.20×10^{-3} | 1.13×10^{-3} | 1.44×10^{-5} | 5.29×10^{-4} | a | 1.40×10^{-2} | 3.99×10^{-3} |
| Cast Stone Facility, 200-East Area | 2040 | 2041 | 200E | 8.10×10^{-3} | 2.48×10^{-3} | 4.90×10^{-5} | 1.73×10^{-3} | a | 2.36×10^{-2} | 6.86×10^{-3} |
| Effluent Treatment Facility original | 2026 | 2026 | WTP_AS | 7.88×10^{-2} | 2.23×10^{-2} | 4.73×10^{-4} | 1.64×10^{-2} | a | 2.00×10^{-1} | 5.81×10^{-2} |
| Effluent Treatment Facility replacement 1 | 2043 | 2043 | WTP_AS | 7.88×10^{-2} | 2.23×10^{-2} | 4.73×10^{-4} | 1.64×10^{-2} | a | 2.00×10^{-1} | 5.81×10^{-2} |
| Evaporator original | 2018 | 2018 | 200E | 1.21×10^{-2} | 1.63×10^{-3} | 6.82×10^{-5} | 2.06×10^{-3} | a | 7.14×10^{-4} | 4.97×10^{-4} |
| Evaporator replacement 1 | 2041 | 2041 | 200E | 1.21×10^{-2} | 1.63×10^{-3} | 6.82×10^{-5} | 2.06×10^{-3} | a | 7.14×10^{-4} | 4.97×10^{-4} |
| Closure | | | | | | | | | | |
| Grout facility (tank-filling) construction | 2028 | 2029 | 200EW | 3.33×10^{-2} | a | a | a | a | a | a |
| Grout facility (tank-filling) operations | 2030 | 2039 | 200EW | 1.17×10^{-2} | a | a | a | a | a | a |
| Grout facility (tank-filling) deactivation | 2040 | 2040 | 200EW | a | a | a | a | a | a | a |
| Ancillary equipment grouting | 2012 | 2032 | 200EW | 3.20×10^{-5} | a | a | a | a | a | a |
| Ancillary equipment removal | 2028 | 2033 | 200EW | 1.72×10^{-5} | a | a | a | a | a | a |
| BX and SX tank farm soil removal | 2028 | 2033 | 200EW | 8.33×10^{-4} | a | a | a | a | a | a |
| Containment structure construction | 2024 | 2027 | 200EW | a | a | a | a | a | a | a |
| Containment structure deactivation | 2034 | 2036 | 200EW | a | a | a | a | a | a | a |
| Modified Resource Conservation and Recovery Act Subtitle C barrier construction | 2035 | 2041 | 200EW | 2.41 | 4.80×10^{-1} | 1.39×10^{-2} | 4.49×10^{-1} | a | 2.75 | 8.32×10^{-1} |
| Decontamination and decommissioning of 10 selected facilities | 2018 | 2028 | 200EW | a | a | a | a | a | a | a |
| Postclosure care | 2042 | 2141 | 200EW | a | a | a | a | a | a | a |

^a Emissions for this activity and pollutant were not calculated because annual fuel use for this activity and the resulting emissions would be small compared with those of other activities or would be zero.

Key: 200E=200-East Area; 200W=200-West Area; 200EW=200-East and 200-West Areas; 200EW+=200-East and 200-West Areas and Waste Treatment Plant area; HLW=high-level radioactive waste; IHLW=immobilized high-level radioactive waste; SUPW=200-West Area supplemental treatment facility; WTP_AS=Waste Treatment Plant area source; WTP_PS=Waste Treatment Plant point source.

Source: SAIC 2007a, 2008.

Table G–19. Tank Closure Alternative 3C Criteria Pollutant Emissions

| Facility/System | Start Year | End Year | Location | Emission Rate (metric tons per year) | | | | |
|--|------------|----------|----------|--------------------------------------|-----------------------|-----------------------|-----------------------|-----------------------|
| | | | | Carbon Monoxide | Nitrogen Dioxide | PM ₁₀ | Sulfur Dioxide | VOCs |
| Construction | | | | | | | | |
| Canister Storage Building | 2006 | 2016 | 200E | 5.54 | 1.28 | 9.05×10 ⁻¹ | 4.02×10 ⁻⁴ | 2.86×10 ⁻¹ |
| IHLW Shipping/Transfer Facility | 2011 | 2013 | 200E | 5.68×10 ¹ | 6.72×10 ¹ | 9.81×10 ¹ | 2.18×10 ⁻² | 6.50 |
| IHLW Interim Storage Modules | 2014 | 2022 | 200E | 4.00×10 ¹ | 4.76×10 ¹ | 1.58×10 ² | 1.45×10 ⁻² | 4.33 |
| Other infrastructure upgrades | 2006 | 2034 | 200EW | 1.11 | 8.05×10 ⁻¹ | 1.13 | 2.54×10 ⁻⁴ | 9.43×10 ⁻² |
| Tank upgrades | 2006 | 2025 | 200EW | 3.49×10 ² | 4.41×10 ¹ | 8.07 | 1.38×10 ⁻² | 1.56×10 ¹ |
| Waste Treatment Plant | 2006 | 2017 | WTP_AS | 7.64×10 ² | 6.20×10 ² | 4.16×10 ² | 1.05 | 7.99×10 ¹ |
| Cesium and Strontium Capsule Processing Facility | 2035 | 2038 | WTP_AS | 8.41×10 ² | 1.22×10 ² | 1.80×10 ¹ | 1.13 | 4.78×10 ¹ |
| Waste receiver facilities | 2013 | 2017 | 200EW | 1.15×10 ² | 9.65×10 ¹ | 3.31×10 ² | 2.92×10 ⁻² | 9.94 |
| Tank risers | 2013 | 2016 | 200EW | 1.84×10 ¹ | 8.19 | 7.42×10 ⁻¹ | 1.72×10 ⁻³ | 2.06 |
| Modified sluicing retrieval system | 2013 | 2039 | 200EW+ | 7.68×10 ¹ | 2.96 | 1.64 | 7.11×10 ⁻⁴ | 3.01 |
| Mobile retrieval system | 2013 | 2026 | 200EW | 7.17×10 ¹ | 3.11×10 ¹ | 5.98 | 9.97×10 ⁻³ | 4.74 |
| Vacuum-based retrieval system | 2027 | 2039 | 200EW | 7.72×10 ¹ | 3.49×10 ¹ | 7.02 | 1.11×10 ⁻² | 5.25 |
| HLW Melter Interim Storage Facility | 2015 | 2016 | WTP_AS | 6.17×10 ⁻¹ | 1.39 | 1.72×10 ¹ | 2.87×10 ⁻⁴ | 6.73×10 ⁻² |
| Contact-Handled Mixed Transuranic Waste Facilities | 2008 | 2008 | 200EW | 3.27×10 ¹ | 7.22 | 7.03 | 4.41×10 ⁻² | 2.04 |
| Remote-Handled Mixed Transuranic Waste Facility | 2013 | 2014 | 200E | 2.68×10 ¹ | 5.92 | 3.02 | 3.62×10 ⁻² | 1.67 |
| Transuranic Waste Interim Storage Facility | 2008 | 2009 | WTP_AS | 8.66×10 ⁻¹ | 2.53 | 2.08×10 ¹ | 6.38×10 ⁻⁴ | 1.46×10 ⁻¹ |
| Steam Reforming Facility, 200-West Area | 2016 | 2017 | 200W | 2.06×10 ² | 4.55×10 ¹ | 3.58×10 ¹ | 2.78×10 ⁻¹ | 1.28×10 ¹ |
| Solid-Liquid Separations Facility | 2016 | 2017 | SUPW | 2.75×10 ¹ | 7.15 | 8.74 | 3.72×10 ⁻² | 1.79 |
| Steam Reforming Facility, 200-East Area | 2016 | 2017 | 200E | 4.11×10 ² | 9.09×10 ¹ | 6.51×10 ¹ | 5.55×10 ⁻¹ | 2.56×10 ¹ |
| Effluent Treatment Facility replacement 1 | 2023 | 2025 | 200E | 1.45×10 ³ | 2.09×10 ² | 9.48×10 ² | 1.96 | 8.25×10 ¹ |
| Evaporator replacement 1 | 2015 | 2017 | 200E | 4.51×10 ² | 6.53×10 ¹ | 1.76×10 ¹ | 6.07×10 ⁻¹ | 2.56×10 ¹ |
| Underground transfer line 1,000-foot sections | 2009 | 2009 | 200EW+ | 7.59×10 ¹ | 2.71×10 ¹ | 2.41×10 ¹ | 8.75×10 ⁻³ | 4.47 |
| Operations | | | | | | | | |
| IHLW Interim Storage Facility | 2018 | 2066 | WTP_AS | a | a | a | a | a |
| Other infrastructure upgrades | 2006 | 2039 | 200EW | a | a | a | a | a |
| Routine operations | 2006 | 2039 | 200EW | 1.36×10 ¹ | 1.55×10 ¹ | a | a | 5.40 |
| Retrieval operations | 2006 | 2039 | 200EW | 4.72×10 ⁻² | 5.35×10 ⁻² | a | a | 1.89×10 ⁻² |
| Double-shell tank interim stabilization | 2006 | 2039 | 200EW | 3.09×10 ⁻¹ | 3.51×10 ⁻¹ | a | a | 1.24×10 ⁻¹ |
| Waste Treatment Plant | 2018 | 2039 | WTP_PS | 1.01×10 ² | 2.22×10 ² | 3.61 | 1.08×10 ¹ | 3.66×10 ² |
| Waste Treatment Plant, cesium and strontium capsules | 2040 | 2040 | WTP_PS | 1.01×10 ² | 2.22×10 ² | 3.61 | 1.08×10 ¹ | 3.66×10 ² |

Table G-19. Tank Closure Alternative 3C Criteria Pollutant Emissions (continued)

| Facility/System | Start Year | End Year | Location | Emission Rate (metric tons per year) | | | | |
|--|------------|----------|----------|--------------------------------------|-----------------------|-----------------------|-----------------------|-----------------------|
| | | | | Carbon Monoxide | Nitrogen Dioxide | PM ₁₀ | Sulfur Dioxide | VOCs |
| Operations (continued) | | | | | | | | |
| Cesium and Strontium Capsule Processing Facility | 2039 | 2040 | WTP_AS | 4.85×10 ¹ | 1.29 | 5.53×10 ¹ | 6.49×10 ⁻² | 2.34 |
| Modified sluicing retrieval system | 2013 | 2039 | 200EW+ | 2.13×10 ¹ | 1.32 | 1.02×10 ⁻¹ | 3.39×10 ⁻⁴ | 9.16×10 ⁻¹ |
| Mobile retrieval system | 2013 | 2026 | 200EW+ | 3.29×10 ⁻¹ | 3.73×10 ⁻¹ | a | a | 1.32×10 ⁻¹ |
| Vacuum-based retrieval system | 2027 | 2039 | 200EW | 5.26×10 ⁻¹ | 5.97×10 ⁻¹ | a | a | 2.11×10 ⁻¹ |
| HLW Melter Interim Storage Facility | 2018 | 2141 | WTP_AS | a | a | a | a | a |
| Contact-Handled Mixed Transuranic Waste Facilities | 2009 | 2010 | 200EW | 1.38×10 ² | 1.26×10 ¹ | 8.55×10 ⁻¹ | 1.85×10 ⁻¹ | 7.32 |
| Remote-Handled Mixed Transuranic Waste Facility | 2015 | 2019 | 200E | 2.74×10 ¹ | 1.75 | 1.17×10 ⁻¹ | 3.68×10 ⁻² | 1.40 |
| Transuranic Waste Interim Storage Facility | 2009 | 2034 | WTP_AS | a | a | a | a | a |
| Steam Reforming Facility, 200-West Area | 2018 | 2039 | 200W | 1.84×10 ² | 6.08×10 ¹ | 8.37×10 ⁻³ | 2.23×10 ⁻¹ | 2.53×10 ¹ |
| Solid-Liquid Separations Facility | 2018 | 2039 | SUPW | 7.25×10 ¹ | 1.24×10 ¹ | 8.54×10 ⁻¹ | 9.77×10 ⁻² | 4.26 |
| Steam Reforming Facility, 200-East Area | 2018 | 2039 | 200E | 2.40×10 ² | 7.59×10 ¹ | 7.71×10 ⁻³ | 1.89×10 ⁻¹ | 2.24×10 ¹ |
| Effluent Treatment Facility | 2006 | 2042 | WTP_PS | 9.84 | 2.67 | 9.34×10 ² | 1.33×10 ⁻² | 6.48×10 ⁻¹ |
| Evaporator | 2006 | 2040 | 200E | 1.23×10 ¹ | 5.70×10 ¹ | 1.71×10 ¹ | 1.94×10 ⁻² | 4.66 |
| Borrow Area C | 2006 | 2052 | Area C | 8.52×10 ¹ | 1.12×10 ² | 2.30×10 ² | 1.20×10 ⁻¹ | 1.20×10 ¹ |
| Deactivation | | | | | | | | |
| Modified sluicing retrieval system | 2013 | 2039 | 200EW+ | 5.47×10 ¹ | 2.31 | 2.04×10 ⁻¹ | 6.79×10 ⁻⁴ | 2.10 |
| Mobile retrieval system | 2013 | 2026 | 200EW+ | 3.58×10 ¹ | 2.81 | 2.33×10 ⁻¹ | 8.57×10 ⁻⁴ | 1.48 |
| Vacuum-based retrieval system | 2027 | 2039 | 200EW | 1.68 | 1.32×10 ⁻¹ | 1.20×10 ⁻² | 4.03×10 ⁻⁵ | 6.87×10 ⁻² |
| IHLW Interim Storage Facility | 2067 | 2067 | WTP_AS | a | a | a | a | a |
| Waste Treatment Plant | 2041 | 2042 | WTP_AS | 1.01×10 ¹ | 2.22×10 ¹ | 3.61×10 ⁻¹ | 1.08 | 3.66×10 ¹ |
| Cesium and Strontium Capsule Processing Facility | 2041 | 2041 | WTP_AS | 2.24×10 ¹ | 5.96×10 ⁻¹ | 2.55×10 ¹ | 3.00×10 ⁻² | 1.08 |
| Contact-Handled Mixed Transuranic Waste Facilities | 2011 | 2012 | 200EW | 1.38×10 ¹ | 1.26 | 8.55×10 ⁻² | 1.85×10 ⁻² | 7.32×10 ⁻¹ |
| Remote-Handled Mixed Transuranic Waste Facility | 2020 | 2021 | 200E | 2.74 | 1.75×10 ⁻¹ | 1.17×10 ⁻² | 3.68×10 ⁻³ | 1.40×10 ⁻¹ |
| Transuranic Waste Interim Storage Facility | 2035 | 2035 | WTP_AS | a | a | a | a | a |
| Steam Reforming Facility, 200-West Area | 2040 | 2041 | 200W | 1.84×10 ¹ | 6.08 | 8.37×10 ⁻⁴ | 2.23×10 ⁻² | 2.53 |
| Solid-Liquid Separations Facility | 2040 | 2041 | SUPW | 7.25 | 1.24 | 8.54×10 ⁻² | 9.77×10 ⁻³ | 4.26×10 ⁻¹ |
| Steam Reforming Facility, 200-East Area | 2040 | 2041 | 200E | 2.40×10 ¹ | 7.59 | 7.71×10 ⁻⁴ | 1.89×10 ⁻² | 2.24 |
| Effluent Treatment facility original | 2026 | 2026 | WTP_AS | 1.09×10 ² | 4.78×10 ¹ | 4.70×10 ² | 1.48×10 ⁻¹ | 8.47 |
| Effluent Treatment Facility replacement 1 | 2043 | 2043 | WTP_AS | 1.09×10 ² | 4.78×10 ¹ | 4.70×10 ² | 1.48×10 ⁻¹ | 8.47 |

Table G-19. Tank Closure Alternative 3C Criteria Pollutant Emissions (continued)

| Facility/System | Start Year | End Year | Location | Emission Rate (metric tons per year) | | | | |
|---|------------|----------|----------|--------------------------------------|----------------------|----------------------|-----------------------|-----------------------|
| | | | | Carbon Monoxide | Nitrogen Dioxide | PM ₁₀ | Sulfur Dioxide | VOCs |
| Deactivation (continued) | | | | | | | | |
| Evaporator original | 2018 | 2018 | 200E | 1.66 | 7.70 | 7.07 | 2.62×10 ⁻³ | 6.28×10 ⁻¹ |
| Evaporator replacement 1 | 2041 | 2041 | 200E | 1.66 | 7.70 | 7.07 | 2.62×10 ⁻³ | 6.28×10 ⁻¹ |
| Closure | | | | | | | | |
| Grout facility (tank-filling) construction | 2028 | 2029 | 200EW | 2.18 | 8.29 | 4.20 | 2.71×10 ⁻³ | 6.82×10 ⁻¹ |
| Grout facility (tank-filling) operations | 2030 | 2039 | 200EW | 2.25×10 ¹ | 8.32×10 ¹ | 4.51×10 ¹ | 2.70×10 ⁻² | 6.68 |
| Grout facility (tank-filling) deactivation | 2040 | 2040 | 200EW | 1.45 | 3.41 | 2.10×10 ¹ | 1.12×10 ⁻³ | 2.95×10 ⁻¹ |
| Ancillary equipment grouting | 2012 | 2032 | 200EW | 4.12×10 ⁻¹ | 1.79 | 1.94 | 5.73×10 ⁻⁴ | 1.38×10 ⁻¹ |
| Ancillary equipment removal | 2028 | 2033 | 200EW | 3.28 | 1.50×10 ¹ | 4.40×10 ¹ | 4.92×10 ⁻³ | 1.19 |
| BX and SX tank farm soil removal | 2028 | 2033 | 200EW | 3.99×10 ¹ | 1.13×10 ² | 2.56×10 ² | 3.73×10 ⁻² | 9.55 |
| Containment structure construction | 2024 | 2027 | 200EW | 6.78×10 ¹ | 7.06 | 2.74 | 2.19×10 ⁻³ | 2.91 |
| Containment structure deactivation | 2034 | 2036 | 200EW | 9.03×10 ¹ | 9.39 | 3.09 | 2.92×10 ⁻³ | 3.88 |
| Modified Resource Conservation and Recovery Act Subtitle C barrier construction | 2035 | 2041 | 200EW | 1.64×10 ³ | 1.50×10 ³ | 3.48×10 ³ | 2.27 | 1.83×10 ² |
| Decontamination and decommissioning of 10 selected facilities | 2018 | 2028 | 200EW | 2.53 | 9.81 | 8.56 | 3.22×10 ⁻³ | 7.93×10 ⁻¹ |
| Postclosure care | 2042 | 2141 | 200EW | a | a | a | a | a |

^a Emissions for this activity and pollutant were not calculated because annual fuel use for this activity and the resulting emissions would be small compared with those of other activities or would be zero.

Key: 200E=200-East Area; 200W=200-West Area; 200EW=200-East and 200-West Areas; 200EW+=200-East and 200-West Areas and Waste Treatment Plant area; HLW=high-level radioactive waste; IHLW=immobilized high-level radioactive waste; PM₁₀=particulate matter with an aerodynamic diameter less than or equal to 10 micrometers; VOC=volatile organic compound; SUPW=200-West Area supplemental treatment facility; WTP_AS=Waste Treatment Plant area source; WTP_PS=Waste Treatment Plant point source.

Source: SAIC 2007a, 2008.

Table G-20. Tank Closure Alternative 3C Toxic Pollutant Emissions

| Facility/System | Start Year | End Year | Location | Emission Rate (metric tons per year) | | | | | | |
|--|------------|----------|----------|--------------------------------------|-----------------------|-----------------------|-----------------------|---------|-----------------------|-----------------------|
| | | | | Ammonia | Benzene | 1,3-Butadiene | Formaldehyde | Mercury | Toluene | Xylene |
| Construction | | | | | | | | | | |
| Canister Storage Building | 2006 | 2016 | 200E | a | a | a | a | a | a | a |
| IHLW Shipping/Transfer Facility | 2011 | 2013 | 200E | a | a | a | a | a | a | a |
| IHLW Interim Storage Modules | 2014 | 2022 | 200E | a | a | a | a | a | a | a |
| Other infrastructure upgrades | 2006 | 2034 | 200EW | a | a | a | a | a | a | a |
| Tank upgrades | 2006 | 2025 | 200EW | 7.82×10 ⁻² | a | a | a | a | a | a |
| Waste Treatment Plant | 2006 | 2017 | WTP_AS | 9.98×10 ⁻¹ | 2.09×10 ⁻¹ | 5.81×10 ⁻³ | 1.89×10 ⁻¹ | a | 1.31 | 3.93×10 ⁻¹ |
| Cesium and Strontium Capsule Processing Facility | 2035 | 2038 | WTP_AS | 2.22×10 ⁻¹ | 1.27×10 ⁻¹ | 1.49×10 ⁻³ | 6.26×10 ⁻² | a | 1.63 | 4.64×10 ⁻¹ |
| Waste receiver facilities | 2013 | 2017 | 200EW | a | a | a | a | a | a | a |
| Tank risers | 2013 | 2016 | 200EW | 2.18 | a | a | a | a | a | a |
| Modified sluicing retrieval system | 2013 | 2039 | 200EW+ | 2.49×10 ⁻¹ | a | a | a | a | a | a |
| Mobile retrieval system | 2013 | 2026 | 200EW | 2.86×10 ⁻¹ | a | a | a | a | a | a |
| Vacuum-based retrieval system | 2027 | 2039 | 200EW | 4.56×10 ⁻¹ | a | a | a | a | a | a |
| HLW Melter Interim Storage Facility | 2015 | 2016 | WTP_AS | a | a | a | a | a | a | a |
| Contact-Handled Mixed Transuranic Waste Facilities | 2008 | 2008 | 200EW | 1.25×10 ⁻² | 5.38×10 ⁻³ | 7.94×10 ⁻⁵ | 3.07×10 ⁻³ | a | 6.25×10 ⁻² | 1.79×10 ⁻² |
| Remote-Handled Mixed Transuranic Waste Facility | 2013 | 2014 | 200E | 1.02×10 ⁻² | 4.42×10 ⁻³ | 6.51×10 ⁻⁵ | 2.52×10 ⁻³ | a | 5.12×10 ⁻² | 1.47×10 ⁻² |
| Transuranic Waste Interim Storage Facility | | 2009 | WTP_AS | a | a | a | a | a | a | a |
| Steam Reforming Facility, 200-West Area | 2016 | 2017 | 200W | 7.86×10 ⁻² | 3.39×10 ⁻² | 5.00×10 ⁻⁴ | 1.94×10 ⁻² | a | 3.93×10 ⁻¹ | 1.13×10 ⁻¹ |
| Solid-Liquid Separations Facility | 2008 | 2016 | SUPW | 1.22×10 ⁻² | 4.74×10 ⁻³ | 7.63×10 ⁻⁵ | 2.87×10 ⁻³ | a | 5.23×10 ⁻² | 1.50×10 ⁻² |
| Steam Reforming Facility, 200-East Area | 2016 | 2017 | 200E | 1.57×10 ⁻¹ | 6.78×10 ⁻² | 1.00×10 ⁻³ | 3.87×10 ⁻² | a | 7.86×10 ⁻¹ | 2.25×10 ⁻¹ |
| Effluent Treatment Facility replacement 1 | 2023 | 2025 | 200E | 3.81×10 ⁻¹ | 2.19×10 ⁻¹ | 2.55×10 ⁻³ | 1.08×10 ⁻¹ | a | 2.82 | 8.02×10 ⁻¹ |
| Evaporator replacement 1 | 2015 | 2017 | 200E | 1.19×10 ⁻¹ | 6.80×10 ⁻² | 7.95×10 ⁻⁴ | 3.35×10 ⁻² | a | 8.74×10 ⁻¹ | 2.49×10 ⁻¹ |
| Underground transfer line 1,000-foot sections | 2009 | 2009 | 200EW+ | a | a | a | a | a | a | a |
| Operations | | | | | | | | | | |
| IHLW Interim Storage Facility | 2018 | 2066 | WTP_AS | a | a | a | a | a | a | a |
| Other infrastructure upgrades | 2006 | 2039 | 200EW | a | a | a | a | a | a | a |
| Routine operations | 2006 | 2039 | 200EW | 1.18×10 ¹ | a | a | a | a | a | a |
| Retrieval operations | 2006 | 2039 | 200EW | 4.09×10 ⁻² | a | a | a | a | a | a |

Table G–20. Tank Closure Alternative 3C Toxic Pollutant Emissions (continued)

| Facility/System | Start Year | End Year | Location | Emission Rate (metric tons per year) | | | | | | |
|--|------------|----------|----------|--------------------------------------|-----------------------|-----------------------|-----------------------|-----------------------|-----------------------|-----------------------|
| | | | | Ammonia | Benzene | 1,3-Butadiene | Formaldehyde | Mercury | Toluene | Xylene |
| Operations (continued) | | | | | | | | | | |
| Double-shell tank interim stabilization | 2006 | 2039 | 200EW | 2.68×10 ⁻¹ | a | a | a | a | a | a |
| Waste Treatment Plant | 2018 | 2039 | WTP_PS | 1.51 | 9.54×10 ⁻³ | 3.44×10 ⁻⁶ | 1.06×10 ⁻⁴ | 6.11×10 ⁻² | 2.69×10 ⁻⁴ | 9.06×10 ⁻⁴ |
| Waste Treatment Plant, cesium and strontium capsules | 2040 | 2040 | WTP_PS | 1.51 | 9.54×10 ⁻³ | 3.44×10 ⁻⁶ | 1.06×10 ⁻⁴ | a | 2.69×10 ⁻⁴ | 9.06×10 ⁻⁴ |
| Cesium and Strontium Capsule Processing Facility | 2039 | 2040 | WTP_AS | 3.80×10 ⁻³ | 6.24×10 ⁻³ | 3.53×10 ⁻⁵ | 2.11×10 ⁻³ | a | 9.58×10 ⁻² | 2.70×10 ⁻² |
| Modified sluicing retrieval system | 2013 | 2039 | 200EW+ | 2.49×10 ⁻¹ | a | a | a | a | a | a |
| Mobile retrieval system | 2013 | 2026 | 200EW+ | 2.86×10 ⁻¹ | a | a | a | a | a | a |
| Vacuum-based retrieval system | 2027 | 2039 | 200EW | 4.56×10 ⁻¹ | a | a | a | a | a | a |
| HLW Melter Interim Storage Facility | 2018 | 2141 | WTP_AS | a | a | a | a | a | a | a |
| Contact-Handled Mixed Transuranic Waste Facilities | 2009 | 2010 | 200EW | 2.48×10 ⁻² | 1.94×10 ⁻² | 1.79×10 ⁻⁴ | 8.34×10 ⁻³ | a | 2.70×10 ⁻¹ | 7.66×10 ⁻² |
| Remote-Handled Mixed Transuranic Waste Facility | 2015 | 2019 | 200E | 3.75×10 ⁻³ | 3.73×10 ⁻³ | 2.89×10 ⁻⁵ | 1.46×10 ⁻³ | a | 5.39×10 ⁻² | 1.53×10 ⁻² |
| Transuranic Waste Interim Storage Facility | 2009 | 2034 | WTP_AS | a | a | a | a | a | a | a |
| Steam Reforming Facility, 200-West Area | 2018 | 2039 | 200W | 9.14×10 ⁻² | 6.60×10 ⁻⁴ | 2.10×10 ⁻⁷ | 6.65×10 ⁻⁶ | 9.96×10 ⁻³ | 3.02×10 ⁻⁵ | 9.41×10 ⁻⁵ |
| Solid-Liquid Separations Facility | 2018 | 2039 | SUPW | 2.20×10 ⁻² | 1.13×10 ⁻² | 1.44×10 ⁻⁴ | 5.29×10 ⁻³ | a | 1.40×10 ⁻¹ | 3.99×10 ⁻² |
| Steam Reforming Facility, 200-East Area | 2018 | 2039 | 200E | 8.26×10 ⁻² | 5.83×10 ⁻⁴ | 1.90×10 ⁻⁷ | 5.98×10 ⁻⁶ | 1.10×10 ⁻² | 2.51×10 ⁻⁵ | 7.88×10 ⁻⁵ |
| Effluent Treatment Facility | 2006 | 2042 | WTP_PS | 4.54×10 ⁻³ | 1.71×10 ⁻³ | 2.83×10 ⁻⁵ | 1.05×10 ⁻³ | a | 1.86×10 ⁻² | 5.35×10 ⁻³ |
| Evaporator | 2006 | 2040 | 200E | 8.97×10 ⁻² | 1.21×10 ⁻² | 5.06×10 ⁻⁴ | 1.53×10 ⁻² | a | 5.29×10 ⁻³ | 3.69×10 ⁻³ |
| Borrow Area C | 2006 | 2052 | Area C | 1.78×10 ⁻¹ | 3.12×10 ⁻² | 1.02×10 ⁻³ | 3.21×10 ⁻² | a | 1.32×10 ⁻¹ | 4.15×10 ⁻² |
| Deactivation | | | | | | | | | | |
| Modified sluicing retrieval system | 2013 | 2039 | 200EW+ | a | a | a | a | a | a | a |
| Mobile retrieval system | 2013 | 2026 | 200EW+ | a | a | a | a | a | a | a |
| Vacuum-based retrieval system | 2027 | 2039 | 200EW | a | a | a | a | a | a | a |
| IHLW Interim Storage Facility | 2067 | 2067 | WTP_AS | a | a | a | a | a | a | a |
| Waste Treatment Plant | 2041 | 2042 | WTP_AS | 1.51×10 ⁻¹ | 9.54×10 ⁻⁴ | 3.44×10 ⁻⁷ | 1.06×10 ⁻⁵ | 6.11×10 ⁻³ | 2.69×10 ⁻⁵ | 9.06×10 ⁻⁵ |
| Cesium and Strontium Capsule Processing Facility | 2041 | 2041 | WTP_AS | 1.75×10 ⁻³ | 2.88×10 ⁻³ | 1.63×10 ⁻⁵ | 9.76×10 ⁻⁴ | a | 4.42×10 ⁻² | 1.25×10 ⁻² |
| Contact-Handled Mixed Transuranic Waste Facilities | 2011 | 2012 | 200EW | 2.48×10 ⁻³ | 1.94×10 ⁻³ | 1.79×10 ⁻⁵ | 8.34×10 ⁻⁴ | a | 2.70×10 ⁻² | 7.66×10 ⁻³ |

Table G-20. Tank Closure Alternative 3C Toxic Pollutant Emissions (*continued*)

| Facility/System | Start Year | End Year | Location | Emission Rate (metric tons per year) | | | | | | |
|---|------------|----------|----------|--------------------------------------|-----------------------|-----------------------|-----------------------|-----------------------|-----------------------|-----------------------|
| | | | | Ammonia | Benzene | 1,3-Butadiene | Formaldehyde | Mercury | Toluene | Xylene |
| Deactivation (<i>continued</i>) | | | | | | | | | | |
| Remote-Handled Mixed Transuranic Waste Facility | 2020 | 2021 | 200E | 3.75×10^{-4} | 3.73×10^{-4} | 2.89×10^{-6} | 1.46×10^{-4} | a | 5.39×10^{-3} | 1.53×10^{-3} |
| Transuranic Waste Interim Storage Facility | 2035 | 2035 | WTP_AS | a | a | a | a | a | a | a |
| Steam Reforming Facility, 200-West Area | 2040 | 2041 | 200W | 9.14×10^{-3} | 6.60×10^{-5} | 2.10×10^{-8} | 6.65×10^{-7} | 9.96×10^{-4} | 3.02×10^{-6} | 9.41×10^{-6} |
| Solid-Liquid Separations Facility | 2040 | 2041 | SUPW | 2.20×10^{-3} | 1.13×10^{-3} | 1.44×10^{-5} | 5.29×10^{-4} | a | 1.40×10^{-2} | 3.99×10^{-3} |
| Steam Reforming Facility, 200-East Area | 2040 | 2041 | 200E | 8.26×10^{-3} | 5.83×10^{-5} | 1.90×10^{-8} | 5.98×10^{-7} | 1.10×10^{-3} | 2.51×10^{-6} | 7.88×10^{-6} |
| Effluent Treatment Facility original | 2026 | 2026 | WTP_AS | 7.88×10^{-2} | 2.23×10^{-2} | 4.73×10^{-4} | 1.64×10^{-2} | a | 2.00×10^{-1} | 5.81×10^{-2} |
| Effluent Treatment Facility replacement 1 | 2043 | 2043 | WTP_AS | 7.88×10^{-2} | 2.23×10^{-2} | 4.73×10^{-4} | 1.64×10^{-2} | a | 2.00×10^{-1} | 5.81×10^{-2} |
| Evaporator original | 2018 | 2018 | 200E | 1.21×10^{-2} | 1.63×10^{-3} | 6.82×10^{-5} | 2.06×10^{-3} | a | 7.14×10^{-4} | 4.97×10^{-4} |
| Evaporator replacement 1 | 2041 | 2041 | 200E | 1.21×10^{-2} | 1.63×10^{-3} | 6.82×10^{-5} | 2.06×10^{-3} | a | 7.14×10^{-4} | 4.97×10^{-4} |
| Closure | | | | | | | | | | |
| Grout facility (tank-filling) construction | 2028 | 2029 | 200EW | 3.33×10^{-2} | a | a | a | a | a | a |
| Grout facility (tank-filling) operations | 2030 | 2039 | 200EW | 1.17×10^{-2} | a | a | a | a | a | a |
| Grout facility (tank-filling) deactivation | 2040 | 2040 | 200EW | a | a | a | a | a | a | a |
| Ancillary equipment grouting | 2012 | 2032 | 200EW | 3.20×10^{-5} | a | a | a | a | a | a |
| Ancillary equipment removal | 2028 | 2033 | 200EW | 1.72×10^{-5} | a | a | a | a | a | a |
| BX and SX tank farm soil removal | 2028 | 2033 | 200EW | 8.33×10^{-4} | a | a | a | a | a | a |
| Containment structure construction | 2024 | 2027 | 200EW | a | a | a | a | a | a | a |
| Containment structure deactivation | 2034 | 2036 | 200EW | a | a | a | a | a | a | a |
| Modified Resource Conservation and Recovery Act Subtitle C barrier construction | 2035 | 2041 | 200EW | 2.41 | 4.80×10^{-1} | 1.39×10^{-2} | 4.49×10^{-1} | a | 2.75 | 8.32×10^{-1} |
| Decontamination and decommissioning of 10 selected facilities | 2018 | 2028 | 200EW | a | a | a | a | a | a | a |
| Postclosure care | 2042 | 2141 | 200EW | a | a | a | a | a | a | a |

^a Emissions for this activity and pollutant were not calculated because annual fuel use for this activity and the resulting emissions would be small compared with those of other activities or would be zero.

Key: 200E=200-East Area; 200W=200-West Area; 200EW=200-East and 200-West Areas; 200EW+=200-East and 200-West Areas and Waste Treatment Plant area; HLW=high-level radioactive waste; IHLW=immobilized high-level radioactive waste; SUPW=200-West Area supplemental treatment facility; WTP_AS=Waste Treatment Plant area source; WTP_PS=Waste Treatment Plant point source.

Source: SAIC 2007a, 2008.

Table G-21. Tank Closure Alternative 4 Criteria Pollutant Emissions

| Facility/System | Start Year | End Year | Location | Emission Rate (metric tons per year) | | | | |
|--|------------|----------|----------|--------------------------------------|-----------------------|-----------------------|-----------------------|-----------------------|
| | | | | Carbon Monoxide | Nitrogen Dioxide | PM ₁₀ | Sulfur Dioxide | VOCs |
| Construction | | | | | | | | |
| Canister Storage Building | 2006 | 2016 | 200E | 5.54 | 1.28 | 9.05×10 ⁻¹ | 4.02×10 ⁻⁴ | 2.86×10 ⁻¹ |
| IHLW Shipping/Transfer Facility | 2011 | 2013 | 200E | 5.68×10 ¹ | 6.72×10 ¹ | 9.81×10 ¹ | 2.18×10 ⁻² | 6.50 |
| IHLW Interim Storage Modules | 2014 | 2022 | 200E | 4.00×10 ¹ | 4.76×10 ¹ | 1.58×10 ² | 1.45×10 ⁻² | 4.34 |
| Other infrastructure upgrades | 2006 | 2034 | 200EW | 1.11 | 8.05×10 ⁻¹ | 1.13 | 2.54×10 ⁻⁴ | 9.43×10 ⁻² |
| Tank upgrades | 2006 | 2025 | 200EW | 3.49×10 ² | 4.41×10 ¹ | 8.07 | 1.38×10 ⁻² | 1.56×10 ¹ |
| Waste Treatment Plant | 2006 | 2017 | WTP_AS | 7.64×10 ² | 6.20×10 ² | 4.16×10 ² | 1.05 | 7.99×10 ¹ |
| Cesium and Strontium Capsule Processing Facility | 2038 | 2041 | 200E | 8.41×10 ² | 1.22×10 ² | 1.80×10 ¹ | 1.13 | 4.78×10 ¹ |
| Waste receiver facilities | 2013 | 2017 | 200EW | 1.15×10 ² | 9.65×10 ¹ | 3.31×10 ² | 2.92×10 ⁻² | 9.94 |
| Tank risers | 2013 | 2016 | 200EW | 2.01×10 ¹ | 8.94 | 8.10×10 ⁻¹ | 1.88×10 ⁻³ | 2.25 |
| Mobile retrieval system | 2013 | 2042 | 200EW | 8.98×10 ¹ | 3.90×10 ¹ | 7.49 | 1.25×10 ⁻² | 5.94 |
| Vacuum-based retrieval system | 2013 | 2042 | 200EW | 3.35×10 ¹ | 1.51×10 ¹ | 3.04 | 4.82×10 ⁻³ | 2.27 |
| Chemical wash system | 2013 | 2042 | 200EW | 2.27×10 ⁻¹ | 1.21 | 1.51×10 ⁻¹ | 3.78×10 ⁻⁴ | 7.56×10 ⁻² |
| HLW Melter Interim Storage Facility | 2015 | 2016 | WTP_AS | 6.17×10 ⁻¹ | 1.39 | 1.72×10 ¹ | 2.87×10 ⁻⁴ | 6.73×10 ⁻² |
| Contact-Handled Mixed Transuranic Waste Facilities | 2008 | 2008 | 200EW | 3.27×10 ¹ | 7.22 | 7.03 | 4.41×10 ⁻² | 2.04 |
| Remote-Handled Mixed Transuranic Waste Facility | 2013 | 2014 | 200E | 2.68×10 ¹ | 5.92 | 3.02 | 3.62×10 ⁻² | 1.67 |
| Transuranic Waste Interim Storage Facility | 2008 | 2009 | WTP_AS | 8.66×10 ⁻¹ | 2.53 | 2.08×10 ¹ | 6.38×10 ⁻⁴ | 1.46×10 ⁻¹ |
| Bulk Vitrification Facility | 2016 | 2017 | 200W | 8.96×10 ¹ | 1.98×10 ¹ | 1.22×10 ¹ | 1.21×10 ⁻¹ | 5.58 |
| Solid-Liquid Separations Facility | 2016 | 2017 | SUPW | 2.75×10 ¹ | 7.15 | 8.74 | 3.72×10 ⁻² | 1.79 |
| Cast Stone Facility | 2016 | 2017 | 200E | 6.11×10 ¹ | 1.35×10 ¹ | 2.57×10 ¹ | 8.25×10 ⁻² | 3.81 |
| Effluent Treatment Facility replacement 1 | 2023 | 2025 | 200E | 1.45×10 ³ | 2.09×10 ² | 9.48×10 ² | 1.96 | 8.25×10 ¹ |
| Evaporator replacement 1 | 2015 | 2017 | 200E | 4.51×10 ² | 6.53×10 ¹ | 1.76×10 ¹ | 6.07×10 ⁻¹ | 2.56×10 ¹ |
| Underground transfer line 1,000-foot sections | 2009 | 2009 | 200EW+ | 7.59×10 ¹ | 2.71×10 ¹ | 2.41×10 ¹ | 8.75×10 ⁻³ | 4.47 |
| Operations | | | | | | | | |
| IHLW Interim Storage Facility | 2018 | 2066 | 200E | a | a | a | a | a |
| Other infrastructure upgrades | 2006 | 2042 | 200EW | a | a | a | a | a |
| Routine operations | 2006 | 2042 | 200EW | 1.36×10 ¹ | 1.55×10 ¹ | a | a | 5.40 |
| Retrieval operations | 2006 | 2042 | 200EW | 4.72×10 ⁻² | 5.35×10 ⁻² | a | a | 1.89×10 ⁻² |

G-50

Draft Tank Closure and Waste Management Environmental Impact Statement for the
Hanford Site, Richland, Washington

Table G–21. Tank Closure Alternative 4 Criteria Pollutant Emissions (continued)

| Facility/System | Start Year | End Year | Location | Emission Rate (metric tons per year) | | | | |
|--|------------|----------|----------|--------------------------------------|-----------------------|-----------------------|-----------------------|-----------------------|
| | | | | Carbon Monoxide | Nitrogen Dioxide | PM ₁₀ | Sulfur Dioxide | VOCs |
| Operations (continued) | | | | | | | | |
| Double-shell tank interim stabilization | 2006 | 2042 | 200EW | 3.09×10 ⁻¹ | 3.51×10 ⁻¹ | a | a | 1.24×10 ⁻¹ |
| Waste Treatment Plant | 2018 | 2042 | WTP_PS | 1.01×10 ² | 2.17×10 ² | 3.03 | 9.43 | 3.67×10 ² |
| Waste Treatment Plant, cesium and strontium capsules | 2043 | 2043 | WTP_PS | 1.01×10 ² | 2.17×10 ² | 3.03 | 9.43 | 3.67×10 ² |
| Cesium and Strontium Capsule Processing Facility | 2042 | 2043 | WTP_AS | 4.85×10 ¹ | 1.29 | 5.53×10 ¹ | 6.49×10 ⁻² | 2.34 |
| Mobile retrieval system | 2013 | 2042 | 200EW | 4.13×10 ⁻¹ | 4.68×10 ⁻¹ | a | a | 1.65×10 ⁻¹ |
| Vacuum-based retrieval system | 2013 | 2042 | 200EW | 2.28×10 ⁻¹ | 2.58×10 ⁻¹ | a | a | 9.12×10 ⁻² |
| Chemical wash system | 2013 | 2042 | 200EW | 1.51×10 ⁻¹ | 5.29×10 ⁻¹ | 1.59 | 1.50×10 ⁻⁴ | a |
| HLW Melter Interim Storage Facility | 2018 | 2144 | WTP_AS | a | a | a | a | a |
| Contact-Handled Mixed Transuranic Waste Facilities | 2009 | 2010 | 200EW | 1.38×10 ² | 1.26×10 ¹ | 8.55×10 ⁻¹ | 1.85×10 ⁻¹ | 7.32 |
| Remote-Handled Mixed Transuranic Waste Facility | 2015 | 2019 | 200E | 2.74×10 ¹ | 1.75 | 1.17×10 ⁻¹ | 3.68×10 ⁻² | 1.40 |
| Transuranic Waste Interim Storage Facility | 2009 | 2034 | WTP_AS | a | a | a | a | a |
| Bulk Vitrification Facility | 2018 | 2039 | 200W | 7.81 | 1.68×10 ¹ | 1.78 | 4.48 | 8.25 |
| Solid-Liquid Separations Facility | 2018 | 2039 | SUPW | 7.25×10 ¹ | 1.24×10 ¹ | 8.54×10 ⁻¹ | 9.77×10 ⁻² | 4.26 |
| Cast Stone Facility | 2018 | 2039 | 200E | 1.27×10 ² | 4.88×10 ¹ | 3.46 | 1.73×10 ⁻¹ | 9.41 |
| Effluent Treatment Facility | 2006 | 2045 | WTP_PS | 9.84 | 2.67 | 9.34×10 ² | 1.33×10 ⁻² | 6.48×10 ⁻¹ |
| Evaporator | 2006 | 2042 | 200E | 1.23×10 ¹ | 5.70×10 ¹ | 1.71×10 ¹ | 1.94×10 ⁻² | 4.66 |
| Borrow Area C | 2006 | 2052 | Area C | 8.52×10 ¹ | 1.12×10 ² | 2.30×10 ² | 1.20×10 ⁻¹ | 1.20×10 ¹ |
| Deactivation | | | | | | | | |
| Mobile retrieval system | 2013 | 2042 | 200EW | 4.48×10 ¹ | 3.51 | 2.92×10 ⁻¹ | 1.07×10 ⁻³ | 1.85 |
| Vacuum-based retrieval system | 2013 | 2042 | 200EW | 7.29×10 ⁻¹ | 5.71×10 ⁻² | 5.19×10 ⁻³ | 1.74×10 ⁻⁵ | 2.98×10 ⁻² |
| Chemical wash system | 2013 | 2042 | 200EW | 2.09 | 3.69×10 ⁻¹ | 3.11×10 ⁻² | 1.18×10 ⁻⁴ | 9.94×10 ⁻² |
| IHLW Interim Storage Facility | 2067 | 2067 | WTP_AS | a | a | a | a | a |
| Waste Treatment Plant | 2044 | 2045 | WTP_AS | 1.01×10 ¹ | 2.17×10 ¹ | 3.03×10 ⁻¹ | 9.43×10 ⁻¹ | 3.67×10 ¹ |
| Cesium and Strontium Capsule Processing Facility | 2044 | 2044 | WTP_AS | 2.24×10 ¹ | 5.96×10 ⁻¹ | 2.55×10 ¹ | 3.00×10 ⁻² | 1.08 |
| Contact-Handled Mixed Transuranic Waste Facilities | 2011 | 2012 | 200EW | 1.38×10 ¹ | 1.26 | 8.55×10 ⁻² | 1.85×10 ⁻² | 7.32×10 ⁻¹ |
| Remote-Handled Mixed Transuranic Waste Facility | 2020 | 2021 | 200E | 2.74 | 1.75×10 ⁻¹ | 1.17×10 ⁻² | 3.68×10 ⁻³ | 1.40×10 ⁻¹ |
| Transuranic Waste Interim Storage Facility | 2035 | 2035 | WTP_AS | a | a | a | a | a |
| Bulk Vitrification Facility | 2040 | 2041 | 200W | 7.81×10 ⁻¹ | 1.68 | 1.78×10 ⁻¹ | 4.48×10 ⁻¹ | 8.25×10 ⁻¹ |

Table G–21. Tank Closure Alternative 4 Criteria Pollutant Emissions (continued)

| Facility/System | Start Year | End Year | Location | Emission Rate (metric tons per year) | | | | |
|---|------------|----------|----------|--------------------------------------|-----------------------|-----------------------|-----------------------|-----------------------|
| | | | | Carbon Monoxide | Nitrogen Dioxide | PM ₁₀ | Sulfur Dioxide | VOCs |
| Deactivation (continued) | | | | | | | | |
| Solid-Liquid Separations Facility | 2040 | 2041 | SUPW | 7.25 | 1.24 | 8.54×10 ⁻² | 9.77×10 ⁻³ | 4.26×10 ⁻¹ |
| Cast Stone Facility | 2040 | 2041 | 200E | 1.27×10 ¹ | 4.88 | 3.46×10 ⁻¹ | 1.73×10 ⁻² | 9.41×10 ⁻¹ |
| Effluent Treatment Facility original | 2026 | 2026 | WTP_AS | 1.09×10 ² | 4.78×10 ¹ | 4.70×10 ² | 1.48×10 ⁻¹ | 8.47 |
| Effluent Treatment Facility replacement 1 | 2046 | 2046 | WTP_AS | 1.09×10 ² | 4.78×10 ¹ | 4.70×10 ² | 1.48×10 ⁻¹ | 8.47 |
| Evaporator original | 2018 | 2018 | 200E | 1.66 | 7.70 | 7.07 | 2.62×10 ⁻³ | 6.28×10 ⁻¹ |
| Evaporator replacement 1 | 2043 | 2043 | 200E | 1.66 | 7.70 | 7.07 | 2.62×10 ⁻³ | 6.28×10 ⁻¹ |
| Closure | | | | | | | | |
| Grout facility (tank-filling) construction | 2031 | 2032 | 200EW | 2.18 | 8.29 | 4.20 | 2.71×10 ⁻³ | 6.82×10 ⁻¹ |
| Grout facility (tank-filling) operations | 2033 | 2042 | 200EW | 1.75×10 ¹ | 6.58×10 ¹ | 4.63 | 2.68×10 ⁻² | 5.53 |
| Grout facility (tank-filling) deactivation | 2043 | 2043 | 200EW | 1.45 | 3.41 | 2.10×10 ¹ | 1.12×10 ⁻³ | 2.95×10 ⁻¹ |
| Ancillary equipment grouting | 2012 | 2032 | 200EW | 2.98×10 ⁻¹ | 1.38 | 9.71×10 ⁻² | 4.70×10 ⁻⁴ | 1.13×10 ⁻¹ |
| Containment structure construction | 2018 | 2021 | 200EW | 6.78×10 ¹ | 7.06 | 2.74 | 2.19×10 ⁻³ | 2.91 |
| Containment structure deactivation | 2042 | 2044 | 200EW | 9.03×10 ¹ | 9.39 | 3.09 | 2.92×10 ⁻³ | 3.88 |
| Modified Resource Conservation and Recovery Act Subtitle C barrier construction | 2038 | 2044 | 200EW | 9.15×10 ² | 8.39×10 ² | 2.14×10 ³ | 1.27 | 1.03×10 ² |
| Decontamination and decommissioning of 10 selected facilities | 2018 | 2028 | 200EW | 2.53 | 9.81 | 8.56 | 3.22×10 ⁻³ | 7.93×10 ⁻¹ |
| Postclosure care | 2045 | 2144 | 200EW | a | a | a | a | a |
| BX tank farm removal | 2022 | 2033 | 200EW | 1.38×10 ¹ | 6.20×10 ¹ | 8.04 | 2.17×10 ⁻² | 5.08 |
| BX tank farm deep soil removal | 2034 | 2041 | 200E | 1.54×10 ¹ | 7.13×10 ¹ | 7.55 | 2.43×10 ⁻² | 5.82 |
| SX tank farm removal | 2022 | 2033 | 200EW | 1.72×10 ¹ | 7.75×10 ¹ | 1.01×10 ¹ | 2.71×10 ⁻² | 6.35 |
| SX tank farm deep soil removal | 2034 | 2041 | 200W | 4.69×10 ¹ | 2.18×10 ² | 2.31×10 ¹ | 7.40×10 ⁻² | 1.78×10 ¹ |
| Preprocessing Facility construction | 2019 | 2021 | 200E | 7.88×10 ² | 5.70×10 ² | 1.71×10 ² | 1.08 | 7.74×10 ¹ |
| Preprocessing Facility operations | 2022 | 2042 | 200E | 1.81×10 ¹ | 5.53 | 4.04×10 ⁻⁴ | 4.05×10 ⁻¹ | 1.77×10 ¹ |
| Preprocessing Facility deactivation | 2043 | 2043 | 200E | 1.90 | 5.81×10 ⁻¹ | 4.24×10 ⁻⁵ | 4.25×10 ⁻² | 1.86 |

^a Emissions for this activity and pollutant were not calculated because annual fuel use for this activity and the resulting emissions would be small compared with those of other activities or would be zero.

Key: 200E=200-East Area; 200W=200-West Area; 200EW=200-East and 200-West Areas; 200EW+=200-East and 200-West Areas and Waste Treatment Plant area; HLW=high-level radioactive waste; IHLW=immobilized high-level radioactive waste; PM₁₀=particulate matter with an aerodynamic diameter less than or equal to 10 micrometers; SUPW=200-West Area supplemental treatment facility; VOC=volatile organic compound; WTP_AS=Waste Treatment Plant area source; WTP_PS=Waste Treatment Plant point source.

Source: SAIC 2007a, 2008.

Table G-22. Tank Closure Alternative 4 Toxic Pollutant Emissions

| Facility/System | Start Year | End Year | Location | Emission Rate (metric tons per year) | | | | | | |
|--|------------|----------|----------|--------------------------------------|-----------------------|-----------------------|-----------------------|---------|-----------------------|-----------------------|
| | | | | Ammonia | Benzene | 1,3-Butadiene | Formaldehyde | Mercury | Toluene | Xylene |
| Construction | | | | | | | | | | |
| Canister Storage Building | 2006 | 2016 | 200E | a | a | a | a | a | a | a |
| IHLW Shipping/Transfer Facility | 2011 | 2013 | 200E | a | a | a | a | a | a | a |
| IHLW Interim Storage Modules | 2014 | 2022 | 200E | a | a | a | a | a | a | a |
| Other infrastructure upgrades | 2006 | 2034 | 200EW | a | a | a | a | a | a | a |
| Tank upgrades | 2006 | 2025 | 200EW | 7.82×10 ⁻² | a | a | a | a | a | a |
| Waste Treatment Plant | 2006 | 2017 | WTP_AS | 9.98×10 ⁻¹ | 2.09×10 ⁻¹ | 5.81×10 ⁻³ | 1.89×10 ⁻¹ | a | 1.31 | 3.93×10 ⁻¹ |
| Cesium and Strontium Capsule Processing Facility | 2038 | 2041 | 200E | 2.22×10 ⁻¹ | 1.27×10 ⁻¹ | 1.49×10 ⁻³ | 6.26×10 ⁻² | a | 1.63 | 4.64×10 ⁻¹ |
| Waste receiver facilities | 2013 | 2017 | 200EW | a | a | a | a | a | a | a |
| Tank risers | 2013 | 2016 | 200EW | 2.38 | a | a | a | a | a | a |
| Mobile retrieval system | 2013 | 2042 | 200EW | 3.58×10 ⁻¹ | a | a | a | a | a | a |
| Vacuum-based retrieval system | 2013 | 2042 | 200EW | 1.98×10 ⁻¹ | a | a | a | a | a | a |
| Chemical wash system | 2013 | 2042 | 200EW | 5.55×10 ⁻³ | a | a | a | a | a | a |
| HLW Melter Interim Storage Facility | 2015 | 2016 | WTP_AS | a | a | a | a | a | a | a |
| Contact-Handled Mixed Transuranic Waste Facilities | 2008 | 2008 | 200EW | 1.25×10 ⁻² | 5.38×10 ⁻³ | 7.94×10 ⁻⁵ | 3.07×10 ⁻³ | a | 6.25×10 ⁻² | 1.79×10 ⁻² |
| Remote-Handled Mixed Transuranic Waste Facility | 2013 | 2014 | 200E | 1.02×10 ⁻² | 4.42×10 ⁻³ | 6.51×10 ⁻⁵ | 2.52×10 ⁻³ | a | 5.12×10 ⁻² | 1.47×10 ⁻² |
| Transuranic Waste Interim Storage Facility | | 2009 | WTP_AS | a | a | a | a | a | a | a |
| Bulk Vitrification Facility | 2016 | 2017 | 200W | 3.43×10 ⁻² | 1.48×10 ⁻² | 2.18×10 ⁻⁴ | 8.43×10 ⁻³ | a | 1.71×10 ⁻¹ | 4.90×10 ⁻² |
| Solid-Liquid Separations Facility | 2008 | 2016 | SUPW | 1.22×10 ⁻² | 4.74×10 ⁻³ | 7.63×10 ⁻⁵ | 2.87×10 ⁻³ | a | 5.23×10 ⁻² | 1.50×10 ⁻² |
| Cast Stone Facility | 2016 | 2017 | 200E | 2.34×10 ⁻² | 1.01×10 ⁻² | 1.49×10 ⁻⁴ | 5.75×10 ⁻³ | a | 1.17×10 ⁻¹ | 3.35×10 ⁻² |
| Effluent Treatment Facility replacement 1 | 2023 | 2025 | 200E | 3.81×10 ⁻¹ | 2.19×10 ⁻¹ | 2.55×10 ⁻³ | 1.08×10 ⁻¹ | a | 2.82 | 8.02×10 ⁻¹ |
| Evaporator replacement 1 | 2015 | 2017 | 200E | 1.19×10 ⁻¹ | 6.80×10 ⁻² | 7.95×10 ⁻⁴ | 3.35×10 ⁻² | a | 8.74×10 ⁻¹ | 2.49×10 ⁻¹ |
| Underground transfer line 1,000-foot sections | 2009 | 2009 | 200EW+ | a | a | a | a | a | a | a |
| Operations | | | | | | | | | | |
| IHLW Interim Storage Facility | 2018 | 2066 | 200E | a | a | a | a | a | a | a |
| Other infrastructure upgrades | 2006 | 2042 | 200EW | a | a | a | a | a | a | a |
| Routine operations | 2006 | 2042 | 200EW | 1.18×10 ¹ | a | a | a | a | a | a |
| Retrieval operations | 2006 | 2042 | 200EW | 4.09×10 ⁻² | a | a | a | a | a | a |

Table G–22. Tank Closure Alternative 4 Toxic Pollutant Emissions (continued)

| Facility/System | Start Year | End Year | Location | Emission Rate (metric tons per year) | | | | | | |
|--|------------|----------|----------|--------------------------------------|-----------------------|-----------------------|-----------------------|-----------------------|-----------------------|-----------------------|
| | | | | Ammonia | Benzene | 1,3-Butadiene | Formaldehyde | Mercury | Toluene | Xylene |
| Operations (continued) | | | | | | | | | | |
| Double-shell tank interim stabilization | 2006 | 2042 | 200EW | 2.68×10 ⁻¹ | a | a | a | a | a | a |
| Waste Treatment Plant | 2018 | 2042 | WTP_PS | 1.51 | 9.55×10 ⁻³ | 3.45×10 ⁻⁶ | 1.07×10 ⁻⁴ | 5.44×10 ⁻² | 2.69×10 ⁻⁴ | 9.07×10 ⁻⁴ |
| Waste Treatment Plant, cesium and strontium capsules | 2043 | 2043 | WTP_PS | 1.51 | 9.55×10 ⁻³ | 3.45×10 ⁻⁶ | 1.07×10 ⁻⁴ | 5.44×10 ⁻² | 2.69×10 ⁻⁴ | 9.07×10 ⁻⁴ |
| Cesium and Strontium Capsule Processing Facility | 2042 | 2043 | WTP_AS | 3.80×10 ⁻³ | 6.24×10 ⁻³ | 3.53×10 ⁻⁵ | 2.11×10 ⁻³ | a | 9.58×10 ⁻² | 2.70×10 ⁻² |
| Mobile retrieval system | 2013 | 2042 | 200EW | 3.58×10 ⁻¹ | a | a | a | a | a | a |
| Vacuum-based retrieval system | 2013 | 2042 | 200EW | 1.98×10 ⁻¹ | a | a | a | a | a | a |
| Chemical wash system | 2013 | 2042 | 200EW | 5.55×10 ⁻³ | a | a | a | a | a | a |
| HLW Melter Interim Storage Facility | 2018 | 2144 | WTP_AS | a | a | a | a | a | a | a |
| Contact-Handled Mixed Transuranic Waste Facilities | 2009 | 2010 | 200EW | 2.48×10 ⁻² | 1.94×10 ⁻² | 1.79×10 ⁻⁴ | 8.34×10 ⁻³ | a | 2.70×10 ⁻¹ | 7.66×10 ⁻² |
| Remote-Handled Mixed Transuranic Waste Facility | 2015 | 2019 | 200E | 3.75×10 ⁻³ | 3.73×10 ⁻³ | 2.89×10 ⁻⁵ | 1.46×10 ⁻³ | a | 5.39×10 ⁻² | 1.53×10 ⁻² |
| Transuranic Waste Interim Storage Facility | 2009 | 2034 | WTP_AS | a | a | a | a | a | a | a |
| Bulk Vitrification Facility | 2018 | 2039 | 200W | 9.36×10 ⁻³ | 2.19×10 ⁻⁴ | 2.52×10 ⁻⁸ | 1.07×10 ⁻⁶ | 1.00×10 ⁻² | 2.83×10 ⁻⁵ | 8.06×10 ⁻⁵ |
| Solid-Liquid Separations Facility | 2018 | 2039 | SUPW | 2.20×10 ⁻² | 1.13×10 ⁻² | 1.44×10 ⁻⁴ | 5.29×10 ⁻³ | a | 1.40×10 ⁻¹ | 3.99×10 ⁻² |
| Cast Stone Facility | 2018 | 2039 | 200E | 8.10×10 ⁻² | 2.48×10 ⁻² | 4.90×10 ⁻⁴ | 1.73×10 ⁻² | a | 2.36×10 ⁻¹ | 6.86×10 ⁻² |
| Effluent Treatment Facility | 2006 | 2045 | WTP_PS | 4.54×10 ⁻³ | 1.71×10 ⁻³ | 2.83×10 ⁻⁵ | 1.05×10 ⁻³ | a | 1.86×10 ⁻² | 5.35×10 ⁻³ |
| Evaporator | 2006 | 2042 | 200E | 8.97×10 ⁻² | 1.21×10 ⁻² | 5.06×10 ⁻⁴ | 1.53×10 ⁻² | a | 5.29×10 ⁻³ | 3.69×10 ⁻³ |
| Borrow Area C | 2006 | 2052 | Area C | 1.78×10 ⁻¹ | 3.12×10 ⁻² | 1.02×10 ⁻³ | 3.21×10 ⁻² | a | 1.32×10 ⁻¹ | 4.15×10 ⁻² |
| Deactivation | | | | | | | | | | |
| Mobile retrieval system | 2013 | 2042 | 200EW | a | a | a | a | a | a | a |
| Vacuum-based retrieval system | 2013 | 2042 | 200EW | a | a | a | a | a | a | a |
| Chemical wash system | 2013 | 2042 | 200EW | a | a | a | a | a | a | a |
| IHLW Interim Storage Facility | 2067 | 2067 | WTP_AS | a | a | a | a | a | a | a |
| Waste Treatment Plant | 2044 | 2045 | WTP_AS | 1.51×10 ⁻¹ | 9.55×10 ⁻⁴ | 3.45×10 ⁻⁷ | 1.07×10 ⁻⁵ | 5.44×10 ⁻³ | 2.69×10 ⁻⁵ | 9.07×10 ⁻⁵ |
| Cesium and Strontium Capsule Processing Facility | 2044 | 2044 | WTP_AS | 1.75×10 ⁻³ | 2.88×10 ⁻³ | 1.63×10 ⁻⁵ | 9.76×10 ⁻⁴ | a | 4.42×10 ⁻² | 1.25×10 ⁻² |
| Contact-Handled Mixed Transuranic Waste Facilities | 2011 | 2012 | 200EW | 2.48×10 ⁻³ | 1.94×10 ⁻³ | 1.79×10 ⁻⁵ | 8.34×10 ⁻⁴ | a | 2.70×10 ⁻² | 7.66×10 ⁻³ |

Table G–22. Tank Closure Alternative 4 Toxic Pollutant Emissions (continued)

| Facility/System | Start Year | End Year | Location | Emission Rate (metric tons per year) | | | | | | |
|---|------------|----------|----------|--------------------------------------|-----------------------|-----------------------|-----------------------|-----------------------|-----------------------|-----------------------|
| | | | | Ammonia | Benzene | 1,3-Butadiene | Formaldehyde | Mercury | Toluene | Xylene |
| Deactivation (continued) | | | | | | | | | | |
| Remote-Handled Mixed Transuranic Waste Facility | 2020 | 2021 | 200E | 3.75×10 ⁻⁴ | 3.73×10 ⁻⁴ | 2.89×10 ⁻⁶ | 1.46×10 ⁻⁴ | a | 5.39×10 ⁻³ | 1.53×10 ⁻³ |
| Transuranic Waste Interim Storage Facility | 2035 | 2035 | WTP_AS | a | a | a | a | a | a | a |
| Bulk Vitrification Facility | 2040 | 2041 | 200W | 9.36×10 ⁻⁴ | 2.19×10 ⁻⁵ | 2.52×10 ⁻⁹ | 1.07×10 ⁻⁷ | 1.00×10 ⁻³ | 2.83×10 ⁻⁶ | 8.06×10 ⁻⁶ |
| Solid-Liquid Separations Facility | 2040 | 2041 | SUPW | 2.20×10 ⁻³ | 1.13×10 ⁻³ | 1.44×10 ⁻⁵ | 5.29×10 ⁻⁴ | a | 1.40×10 ⁻² | 3.99×10 ⁻³ |
| Cast Stone Facility | 2040 | 2041 | 200E | 8.10×10 ⁻³ | 2.48×10 ⁻³ | 4.90×10 ⁻⁵ | 1.73×10 ⁻³ | a | 2.36×10 ⁻² | 6.86×10 ⁻³ |
| Effluent Treatment Facility original | 2026 | 2026 | WTP_AS | 7.88×10 ⁻² | 2.23×10 ⁻² | 4.73×10 ⁻⁴ | 1.64×10 ⁻² | a | 2.00×10 ⁻¹ | 5.81×10 ⁻² |
| Effluent Treatment Facility replacement 1 | 2046 | 2046 | WTP_AS | 7.88×10 ⁻² | 2.23×10 ⁻² | 4.73×10 ⁻⁴ | 1.64×10 ⁻² | a | 2.00×10 ⁻¹ | 5.81×10 ⁻² |
| Evaporator original | 2018 | 2018 | 200E | 1.21×10 ⁻² | 1.63×10 ⁻³ | 6.82×10 ⁻⁵ | 2.06×10 ⁻³ | a | 7.14×10 ⁻⁴ | 4.97×10 ⁻⁴ |
| Evaporator replacement 1 | 2043 | 2043 | 200E | 1.21×10 ⁻² | 1.63×10 ⁻³ | 6.82×10 ⁻⁵ | 2.06×10 ⁻³ | a | 7.14×10 ⁻⁴ | 4.97×10 ⁻⁴ |
| Closure | | | | | | | | | | |
| Grout facility (tank-filling) construction | 2031 | 2032 | 200EW | 3.33×10 ⁻² | a | a | a | a | a | a |
| Grout facility (tank-filling) operations | 2033 | 2042 | 200EW | 1.04×10 ⁻¹ | 1.39×10 ⁻² | 5.83×10 ⁻⁴ | 1.76×10 ⁻² | a | 6.10×10 ⁻³ | 4.25×10 ⁻³ |
| Grout facility (tank-filling) deactivation | 2043 | 2043 | 200EW | a | a | a | a | a | a | a |
| Ancillary equipment grouting | 2012 | 2032 | 200EW | 2.17×10 ⁻³ | 2.92×10 ⁻⁴ | 1.22×10 ⁻⁵ | 3.70×10 ⁻⁴ | a | 1.28×10 ⁻⁴ | 8.93×10 ⁻⁵ |
| Containment structure construction | 2018 | 2021 | 200EW | a | a | a | a | a | a | a |
| Containment structure deactivation | 2042 | 2044 | 200EW | a | a | a | a | a | a | a |
| Modified Resource Conservation and Recovery Act Subtitle C barrier construction | 2038 | 2044 | 200EW | 1.35 | 7.60×10 ⁻² | 7.27×10 ⁻³ | 2.19×10 ⁻¹ | a | 7.60×10 ⁻² | 5.30×10 ⁻² |
| Decontamination and decommissioning of 10 selected facilities | 2018 | 2028 | 200EW | a | a | a | a | a | a | a |
| Postclosure care | 2045 | 2144 | 200EW | a | a | a | a | a | a | a |
| BX tank farm removal | 2022 | 2033 | 200EW | 9.76×10 ⁻² | 1.32×10 ⁻² | 5.50×10 ⁻⁴ | 1.66×10 ⁻² | a | 6.58×10 ⁻³ | 4.24×10 ⁻³ |
| BX tank farm deep soil removal | 2034 | 2041 | 200E | 1.12×10 ⁻¹ | 1.51×10 ⁻² | 6.32×10 ⁻⁴ | 1.91×10 ⁻² | a | 6.61×10 ⁻³ | 4.61×10 ⁻³ |
| SX tank farm removal | 2022 | 2033 | 200EW | 1.22×10 ⁻¹ | 1.65×10 ⁻² | 6.88×10 ⁻⁴ | 2.08×10 ⁻² | a | 8.22×10 ⁻³ | 5.30×10 ⁻³ |
| SX tank farm deep soil removal | 2034 | 2041 | 200W | 3.42×10 ⁻¹ | 4.61×10 ⁻² | 1.93×10 ⁻³ | 5.83×10 ⁻² | a | 2.02×10 ⁻² | 1.41×10 ⁻² |
| Preprocessing Facility construction | 2019 | 2021 | 200E | 9.20×10 ⁻¹ | 2.03×10 ⁻¹ | 5.38×10 ⁻³ | 1.77×10 ⁻¹ | a | 1.37 | 4.10×10 ⁻¹ |

Table G–22. Tank Closure Alternative 4 Toxic Pollutant Emissions (continued)

| Facility/System | Start Year | End Year | Location | Emission Rate (metric tons per year) | | | | | | |
|-------------------------------------|------------|----------|----------|--------------------------------------|-----------------------|-----------------------|-----------------------|---------|-----------------------|-----------------------|
| | | | | Ammonia | Benzene | 1,3-Butadiene | Formaldehyde | Mercury | Toluene | Xylene |
| Closure (continued) | | | | | | | | | | |
| Preprocessing Facility operations | 2022 | 2042 | 200E | 8.28×10^{-3} | 4.72×10^{-4} | 2.90×10^{-8} | 1.66×10^{-6} | a | 7.15×10^{-5} | 2.02×10^{-4} |
| Preprocessing Facility deactivation | 2043 | 2043 | 200E | 8.69×10^{-4} | 4.96×10^{-5} | 3.05×10^{-9} | 1.74×10^{-7} | a | 7.51×10^{-6} | 2.12×10^{-5} |

^a Emissions for this activity and pollutant were not calculated because annual fuel use for this activity and the resulting emissions would be small compared with those of other activities or would be zero.

Key: 200E=200-East Area; 200W=200-West Area; 200EW=200-East and 200-West Areas; 200EW+=200-East and 200-West Areas and Waste Treatment Plant area; HLW=high-level radioactive waste; IHLW=immobilized high-level radioactive waste; SUPW=200-West Area supplemental treatment facility; WTP_AS=Waste Treatment Plant area source; WTP_PS=Waste Treatment Plant point source.

Source: SAIC 2007a, 2008.

Table G-23. Tank Closure Alternative 5 Criteria Pollutant Emissions

| Facility/System | Start Year | End Year | Location | Emission Rate (metric tons per year) | | | | |
|--|------------|----------|----------|--------------------------------------|-----------------------|-----------------------|-----------------------|-----------------------|
| | | | | Carbon Monoxide | Nitrogen Dioxide | PM ₁₀ | Sulfur Dioxide | VOCs |
| Construction | | | | | | | | |
| Canister Storage Building | 2006 | 2016 | 200E | 5.54 | 1.28 | 9.05×10 ⁻¹ | 4.02×10 ⁻⁴ | 2.86×10 ⁻¹ |
| IHLW Shipping/Transfer Facility | 2011 | 2013 | 200E | 5.68×10 ¹ | 6.72×10 ¹ | 9.81×10 ¹ | 2.18×10 ⁻² | 6.50 |
| IHLW Interim Storage Modules | 2014 | 2019 | 200E | 4.00×10 ¹ | 4.76×10 ¹ | 1.58×10 ² | 1.45×10 ⁻² | 4.34 |
| Other infrastructure upgrades | 2006 | 2034 | 200EW | 1.11 | 8.05×10 ⁻¹ | 1.13 | 2.54×10 ⁻⁴ | 9.43×10 ⁻² |
| Tank upgrades | 2006 | 2025 | 200EW | 3.49×10 ² | 4.41×10 ¹ | 8.07 | 1.38×10 ⁻² | 1.56×10 ¹ |
| Waste Treatment Plant | 2006 | 2017 | WTP_AS | 7.65×10 ² | 6.21×10 ² | 1.25×10 ² | 1.06 | 8.00×10 ¹ |
| Cesium and Strontium Capsule Processing Facility | 2029 | 2032 | 200E | 8.41×10 ² | 1.22×10 ² | 1.80×10 ¹ | 1.13 | 4.78×10 ¹ |
| Waste receiver facilities | 2013 | 2017 | 200EW | 1.15×10 ² | 9.65×10 ¹ | 3.31×10 ² | 2.92×10 ⁻² | 9.94 |
| Tank risers | 2013 | 2016 | 200EW | 1.84×10 ¹ | 8.19 | 7.42×10 ⁻¹ | 1.72×10 ⁻³ | 2.06 |
| Double-shell tank replacement | 2014 | 2019 | 200EW+ | 3.72×10 ¹ | 3.11×10 ¹ | 1.93×10 ² | 9.19×10 ⁻³ | 3.15 |
| Sulfate Removal Facility | 2016 | 2017 | WTP_AS | 3.93×10 ² | 8.69×10 ¹ | 5.83×10 ¹ | 5.31×10 ⁻¹ | 2.45×10 ¹ |
| Modified sluicing retrieval system | 2013 | 2033 | 200EW | 7.14×10 ¹ | 2.75 | 1.52 | 6.60×10 ⁻⁴ | 2.80 |
| Mobile retrieval system | 2013 | 2023 | 200EW | 9.13×10 ¹ | 3.96×10 ¹ | 7.62 | 1.27×10 ⁻² | 6.04 |
| Vacuum-based retrieval system | 2024 | 2033 | 200EW | 1.00×10 ² | 4.54×10 ¹ | 9.12 | 1.45×10 ⁻² | 6.82 |
| HLW Melter Interim Storage Facility | 2015 | 2016 | WTP_AS | 6.17×10 ⁻¹ | 1.39 | 1.72×10 ¹ | 2.87×10 ⁻⁴ | 6.73×10 ⁻² |
| Contact-Handled Mixed Transuranic Waste Facilities | 2008 | 2008 | 200EW | 3.27×10 ¹ | 7.22 | 7.03 | 4.41×10 ⁻² | 2.04 |
| Remote-Handled Mixed Transuranic Waste Facility | 2013 | 2014 | 200E | 2.68×10 ¹ | 5.92 | 3.02 | 3.62×10 ⁻² | 1.67 |
| Transuranic Waste Interim Storage Facility | 2008 | 2009 | WTP_AS | 8.66×10 ⁻¹ | 2.53 | 2.08×10 ¹ | 6.38×10 ⁻⁴ | 1.46×10 ⁻¹ |
| Bulk Vitrification Facility | 2016 | 2017 | 200W | 8.96×10 ¹ | 1.98×10 ¹ | 1.22×10 ¹ | 1.21×10 ⁻¹ | 5.58 |
| Solid-Liquid Separations Facility | 2016 | 2017 | SUPW | 2.75×10 ¹ | 7.15 | 8.74 | 3.72×10 ⁻² | 1.79 |
| Cast Stone Facility | 2016 | 2017 | 200E | 6.11×10 ¹ | 1.35×10 ¹ | 2.57×10 ¹ | 8.25×10 ⁻² | 3.81 |
| Effluent Treatment Facility replacement 1 | 2023 | 2025 | 200E | 1.45×10 ³ | 2.09×10 ² | 9.48×10 ² | 1.96 | 8.25×10 ¹ |
| Evaporator replacement 1 | 2015 | 2017 | 200E | 4.51×10 ² | 6.53×10 ¹ | 1.76×10 ¹ | 6.07×10 ⁻¹ | 2.56×10 ¹ |
| Underground transfer line 1,000-foot sections | 2009 | 2009 | 200EW+ | 7.59×10 ¹ | 2.71×10 ¹ | 2.41×10 ¹ | 8.75×10 ⁻³ | 4.47 |
| Operations | | | | | | | | |
| IHLW Interim Storage Facility | 2018 | 2066 | 200E | a | a | a | a | a |
| Other infrastructure upgrades | 2006 | 2033 | 200EW | a | a | a | a | a |
| Routine operations | 2006 | 2033 | 200EW | 1.36×10 ¹ | 1.55×10 ¹ | a | a | 5.40 |
| Retrieval operations | 2006 | 2033 | 200EW | 4.72×10 ⁻² | 5.35×10 ⁻² | a | a | 1.89×10 ⁻² |
| Double-shell tank interim stabilization | 2006 | 2033 | 200EW | 3.09×10 ⁻¹ | 3.51×10 ⁻¹ | a | a | 1.24×10 ⁻¹ |
| Waste Treatment Plant | 2018 | 2033 | WTP_PS | 2.49×10 ² | 7.63×10 ² | 5.13 | 1.74×10 ¹ | 1.26×10 ³ |

Table G-23. Tank Closure Alternative 5 Criteria Pollutant Emissions (continued)

| Facility/System | Start Year | End Year | Location | Emission Rate (metric tons per year) | | | | |
|--|------------|----------|----------|--------------------------------------|-----------------------|-----------------------|-----------------------|-----------------------|
| | | | | Carbon Monoxide | Nitrogen Dioxide | PM ₁₀ | Sulfur Dioxide | VOCs |
| Operations (continued) | | | | | | | | |
| Waste Treatment Plant, cesium and strontium capsules | 2034 | 2034 | WTP_PS | 2.49×10 ² | 7.63×10 ² | 5.13 | 1.74×10 ¹ | 1.26×10 ³ |
| Cesium and Strontium Capsule Processing Facility | 2033 | 2034 | WTP_AS | 4.85×10 ¹ | 1.29 | 5.53×10 ¹ | 6.49×10 ⁻² | 2.34 |
| Double-shell tank replacement | 2020 | 2033 | 200EW+ | 2.12×10 ⁻² | 2.40×10 ⁻² | a | a | 8.47×10 ⁻³ |
| Sulfate Removal Facility | 2018 | 2033 | WTP_AS | 1.65×10 ² | 2.11×10 ¹ | 1.45 | 2.22×10 ⁻¹ | 9.18 |
| Modified sluicing retrieval system | 2013 | 2033 | 200EW | 1.98×10 ¹ | 1.23 | 9.46×10 ⁻² | 3.15×10 ⁻⁴ | 8.51×10 ⁻¹ |
| Mobile retrieval system | 2013 | 2023 | 200EW | 4.19×10 ⁻¹ | 4.75×10 ⁻¹ | a | a | 1.68×10 ⁻¹ |
| Vacuum-based retrieval system | 2024 | 2033 | 200EW | 6.84×10 ⁻¹ | 7.75×10 ⁻¹ | a | a | 2.74×10 ⁻¹ |
| HLW Melter Interim Storage Facility | 2018 | 2139 | WTP_AS | a | a | a | a | a |
| Contact-Handled Mixed Transuranic Waste Facilities | 2009 | 2010 | 200EW | 1.38×10 ² | 1.26×10 ¹ | 8.55×10 ⁻¹ | 1.85×10 ⁻¹ | 7.32 |
| Remote-Handled Mixed Transuranic Waste Facility | 2015 | 2019 | 200E | 2.74×10 ¹ | 1.75 | 1.17×10 ⁻¹ | 3.68×10 ⁻² | 1.40 |
| Transuranic Waste Interim Storage Facility | 2009 | 2034 | WTP_AS | a | a | a | a | a |
| Bulk Vitrification Facility | 2018 | 2033 | 200W | 1.07×10 ¹ | 2.09×10 ¹ | 2.21 | 5.58 | 1.13×10 ¹ |
| Solid-Liquid Separations Facility | 2018 | 2033 | SUPW | 9.97×10 ¹ | 1.70×10 ¹ | 1.17 | 1.34×10 ⁻¹ | 5.85 |
| Cast Stone Facility | 2018 | 2033 | 200E | 1.75×10 ² | 6.71×10 ¹ | 4.70 | 2.38×10 ⁻¹ | 1.29×10 ¹ |
| Effluent Treatment Facility | 2006 | 2036 | WTP_PS | 9.84 | 2.67 | 9.34×10 ² | 1.33×10 ⁻² | 6.48×10 ⁻¹ |
| Evaporator | 2006 | 2034 | 200E | 1.23×10 ¹ | 5.70×10 ¹ | 1.71×10 ¹ | 1.94×10 ⁻² | 4.66 |
| Borrow Area C | 2006 | 2052 | Area C | 8.52×10 ¹ | 1.12×10 ² | 2.30×10 ² | 1.20×10 ⁻¹ | 1.20×10 ¹ |
| Deactivation | | | | | | | | |
| Sulfate Removal Facility | 2034 | 2035 | WTP_AS | 1.65×10 ¹ | 2.11 | 1.45×10 ⁻¹ | 2.22×10 ⁻² | 9.18×10 ⁻¹ |
| Modified sluicing retrieval system | 2013 | 2033 | 200EW | 5.08×10 ¹ | 2.14 | 1.89×10 ⁻¹ | 6.31×10 ⁻⁴ | 1.96 |
| Mobile retrieval system | 2013 | 2023 | 200EW | 4.56×10 ¹ | 3.57 | 2.97×10 ⁻¹ | 1.09×10 ⁻³ | 1.88 |
| Vacuum-based retrieval system | 2024 | 2033 | 200EW | 2.19 | 1.71×10 ⁻¹ | 1.56×10 ⁻² | 5.23×10 ⁻⁵ | 8.94×10 ⁻² |
| IHLW Interim Storage Facility | 2067 | 2067 | WTP_AS | a | a | a | a | a |
| Waste Treatment Plant | 2035 | 2036 | WTP_AS | 2.38×10 ¹ | 8.10×10 ¹ | 1.52 | 1.64 | 1.19×10 ² |
| Cesium and Strontium Capsule Processing Facility | 2035 | 2035 | WTP_AS | 2.24×10 ¹ | 5.96×10 ⁻¹ | 2.55×10 ¹ | 3.00×10 ⁻² | 1.08 |
| Contact-Handled Mixed Transuranic Waste Facilities | 2011 | 2012 | 200EW | 1.38×10 ¹ | 1.26 | 8.55×10 ⁻² | 1.85×10 ⁻² | 7.32×10 ⁻¹ |
| Remote-Handled Mixed Transuranic Waste Facility | 2020 | 2021 | 200E | 2.74 | 1.75×10 ⁻¹ | 1.17×10 ⁻² | 3.68×10 ⁻³ | 1.40×10 ⁻¹ |
| Transuranic Waste Interim Storage Facility | 2035 | 2035 | WTP_AS | a | a | a | a | a |
| Bulk Vitrification Facility | 2034 | 2035 | 200W | 1.07 | 2.09 | 2.21×10 ⁻¹ | 5.58×10 ⁻¹ | 1.13 |
| Solid-Liquid Separations Facility | 2034 | 2035 | SUPW | 9.97 | 1.70 | 1.17×10 ⁻¹ | 1.34×10 ⁻² | 5.85×10 ⁻¹ |

Table G–23. Tank Closure Alternative 5 Criteria Pollutant Emissions (continued)

| Facility/System | Start Year | End Year | Location | Emission Rate (metric tons per year) | | | | |
|---|------------|----------|----------|--------------------------------------|----------------------|-----------------------|-----------------------|-----------------------|
| | | | | Carbon Monoxide | Nitrogen Dioxide | PM ₁₀ | Sulfur Dioxide | VOCs |
| Deactivation (continued) | | | | | | | | |
| Cast Stone Facility | 2034 | 2035 | 200E | 1.75×10 ¹ | 6.71 | 4.70×10 ⁻¹ | 2.38×10 ⁻² | 1.29 |
| Effluent Treatment Facility original | 2026 | 2026 | WTP_AS | 1.09×10 ² | 4.78×10 ¹ | 4.70×10 ² | 1.48×10 ⁻¹ | 8.47 |
| Effluent Treatment Facility replacement 1 | 2037 | 2037 | WTP_AS | 1.09×10 ² | 4.78×10 ¹ | 4.70×10 ² | 1.48×10 ⁻¹ | 8.47 |
| Evaporator original | 2018 | 2018 | 200E | 1.66 | 7.70 | 7.07 | 2.62×10 ⁻³ | 6.28×10 ⁻¹ |
| Evaporator replacement 1 | 2035 | 2035 | 200E | 1.66 | 7.70 | 7.07 | 2.62×10 ⁻³ | 6.28×10 ⁻¹ |
| Closure | | | | | | | | |
| Grout facility (tank-filling) construction | 2022 | 2023 | 200EW | 2.18 | 8.29 | 4.20 | 2.71×10 ⁻³ | 6.82×10 ⁻¹ |
| Grout facility (tank-filling) operations | 2024 | 2033 | 200EW | 2.25×10 ¹ | 8.32×10 ¹ | 4.51×10 ¹ | 2.70×10 ⁻² | 6.68 |
| Grout facility (tank-filling) deactivation | 2034 | 2034 | 200EW | 1.45 | 3.41 | 2.10×10 ¹ | 1.12×10 ⁻³ | 2.95×10 ⁻¹ |
| Ancillary equipment grouting | 2013 | 2033 | 200EW | 3.50×10 ⁻¹ | 1.52 | 1.65 | 4.87×10 ⁻⁴ | 1.18×10 ⁻¹ |
| Hanford barrier construction | 2029 | 2039 | 200EW | 1.74×10 ³ | 1.59×10 ³ | 3.48×10 ³ | 2.41 | 1.95×10 ² |
| Decontamination and decommissioning of 10 selected facilities | 2012 | 2022 | 200EW | 2.53 | 9.81 | 8.56 | 3.22×10 ⁻³ | 7.93×10 ⁻¹ |
| Postclosure care | 2040 | 2139 | 200EW | a | a | a | a | a |

^a Emissions for this activity and pollutant were not calculated because annual fuel use for this activity and the resulting emissions would be small compared with those of other activities or would be zero.

Key: 200E=200-East Area; 200W=200-West Area; 200EW=200-East and 200-West Areas; 200EW+=200-East and 200-West Areas and Waste Treatment Plant area; HLW=high-level radioactive waste; IHLW=immobilized high-level radioactive waste; PM₁₀=particulate matter with an aerodynamic diameter less than or equal to 10 micrometers; SUPW=200-West Area supplemental treatment facility; VOC=volatile organic compound; WTP_AS=Waste Treatment Plant area source; WTP_PS=Waste Treatment Plant point source.

Source: SAIC 2007a, 2008.

Table G-24. Tank Closure Alternative 5 Toxic Pollutant Emissions

| Facility/System | Start Year | End Year | Location | Emission Rate (metric tons per year) | | | | | | |
|--|------------|----------|----------|--------------------------------------|-----------------------|-----------------------|-----------------------|---------|-----------------------|-----------------------|
| | | | | Ammonia | Benzene | 1,3-Butadiene | Formaldehyde | Mercury | Toluene | Xylene |
| Construction | | | | | | | | | | |
| Canister Storage Building | 2006 | 2016 | 200E | a | a | a | a | a | a | a |
| IHLW Shipping/Transfer Facility | 2011 | 2013 | 200E | a | a | a | a | a | a | a |
| IHLW Interim Storage Modules | 2014 | 2019 | 200E | a | a | a | a | a | a | a |
| Other infrastructure upgrades | 2006 | 2034 | 200EW | a | a | a | a | a | a | a |
| Tank upgrades | 2006 | 2025 | 200EW | 7.82×10 ⁻² | a | a | a | a | a | a |
| Waste Treatment Plant | 2006 | 2017 | WTP_AS | 9.99×10 ⁻¹ | 2.10×10 ⁻¹ | 5.82×10 ⁻³ | 1.89×10 ⁻¹ | a | 1.31 | 3.94×10 ⁻¹ |
| Cesium and Strontium Capsule Processing Facility | 2029 | 2032 | 200E | 2.22×10 ⁻¹ | 1.27×10 ⁻¹ | 1.49×10 ⁻³ | 6.26×10 ⁻² | a | 1.63 | 4.64×10 ⁻¹ |
| Waste receiver facilities | 2013 | 2017 | 200EW | a | a | a | a | a | a | a |
| Tank risers | 2013 | 2016 | 200EW | 2.18 | a | a | a | a | a | a |
| Double-shell tank replacement | 2014 | 2019 | 200EW+ | a | a | a | a | a | a | a |
| Sulfate Removal Facility | 2016 | 2017 | WTP_AS | 1.50×10 ⁻¹ | 6.48×10 ⁻² | 9.55×10 ⁻⁴ | 3.70×10 ⁻² | a | 7.51×10 ⁻¹ | 2.15×10 ⁻¹ |
| Modified sluicing retrieval system | 2013 | 2033 | 200EW | 2.32×10 ⁻¹ | a | a | a | a | a | a |
| Mobile retrieval system | 2013 | 2023 | 200EW | 3.63×10 ⁻¹ | a | a | a | a | a | a |
| Vacuum-based retrieval system | 2024 | 2033 | 200EW | 5.93×10 ⁻¹ | a | a | a | a | a | a |
| HLW Melter Interim Storage Facility | 2015 | 2016 | WTP_AS | a | a | a | a | a | a | a |
| Contact-Handled Mixed Transuranic Waste Facilities | 2008 | 2008 | 200EW | 1.25×10 ⁻² | 5.38×10 ⁻³ | 7.94×10 ⁻⁵ | 3.07×10 ⁻³ | a | 6.25×10 ⁻² | 1.79×10 ⁻² |
| Remote-Handled Mixed Transuranic Waste Facility | 2013 | 2014 | 200E | 1.02×10 ⁻² | 4.42×10 ⁻³ | 6.51×10 ⁻⁵ | 2.52×10 ⁻³ | a | 5.12×10 ⁻² | 1.47×10 ⁻² |
| Transuranic Waste Interim Storage Facility | | 2009 | WTP_AS | a | a | a | a | a | a | a |
| Bulk Vitrification Facility | 2016 | 2017 | 200W | 3.43×10 ⁻² | 1.48×10 ⁻² | 2.18×10 ⁻⁴ | 8.43×10 ⁻³ | a | 1.71×10 ⁻¹ | 4.90×10 ⁻² |
| Solid-Liquid Separations Facility | 2008 | 2016 | SUPW | 1.22×10 ⁻² | 4.74×10 ⁻³ | 7.63×10 ⁻⁵ | 2.87×10 ⁻³ | a | 5.23×10 ⁻² | 1.50×10 ⁻² |
| Cast Stone Facility | 2016 | 2017 | 200E | 2.34×10 ⁻² | 1.01×10 ⁻² | 1.49×10 ⁻⁴ | 5.75×10 ⁻³ | a | 1.17×10 ⁻¹ | 3.35×10 ⁻² |
| Effluent Treatment Facility replacement 1 | 2023 | 2025 | 200E | 3.81×10 ⁻¹ | 2.19×10 ⁻¹ | 2.55×10 ⁻³ | 1.08×10 ⁻¹ | a | 2.82 | 8.02×10 ⁻¹ |
| Evaporator replacement 1 | 2015 | 2017 | 200E | 1.19×10 ⁻¹ | 6.80×10 ⁻² | 7.95×10 ⁻⁴ | 3.35×10 ⁻² | a | 8.74×10 ⁻¹ | 2.49×10 ⁻¹ |
| Underground transfer line 1,000-foot sections | 2009 | 2009 | 200EW+ | a | a | a | a | a | a | a |

Table G-24. Tank Closure Alternative 5 Toxic Pollutant Emissions (continued)

| Facility/System | Start Year | End Year | Location | Emission Rate (metric tons per year) | | | | | | |
|--|------------|----------|----------|--------------------------------------|-----------------------|-----------------------|-----------------------|-----------------------|-----------------------|-----------------------|
| | | | | Ammonia | Benzene | 1,3-Butadiene | Formaldehyde | Mercury | Toluene | Xylene |
| Operations | | | | | | | | | | |
| IHLW Interim Storage Facility | 2018 | 2066 | 200E | a | a | a | a | a | a | a |
| Other infrastructure upgrades | 2006 | 2033 | 200EW | a | a | a | a | a | a | a |
| Routine operations | 2006 | 2033 | 200EW | 1.18×10 ¹ | a | a | a | a | a | a |
| Retrieval operations | 2006 | 2033 | 200EW | 4.09×10 ⁻² | a | a | a | a | a | a |
| Double-shell tank interim stabilization | 2006 | 2033 | 200EW | 2.68×10 ⁻¹ | a | a | a | a | a | a |
| Waste Treatment Plant | 2018 | 2033 | WTP_PS | 5.69 | 3.28×10 ⁻² | 1.29×10 ⁻⁵ | 3.93×10 ⁻⁴ | 8.51×10 ⁻² | 5.02×10 ⁻⁴ | 1.97×10 ⁻³ |
| Waste Treatment Plant, cesium and strontium capsules | 2034 | 2034 | WTP_PS | 5.69 | 3.28×10 ⁻² | 1.29×10 ⁻⁵ | 3.93×10 ⁻⁴ | a | 5.02×10 ⁻⁴ | 1.97×10 ⁻³ |
| Cesium and Strontium Capsule Processing Facility | 2033 | 2034 | WTP_AS | 3.80×10 ⁻³ | 6.24×10 ⁻³ | 3.53×10 ⁻⁵ | 2.11×10 ⁻³ | a | 9.58×10 ⁻² | 2.70×10 ⁻² |
| Double-shell tank replacement | 2020 | 2033 | 200EW+ | 1.84×10 ⁻² | a | a | a | a | a | a |
| Sulfate Removal Facility | 2018 | 2033 | WTP_AS | 3.90×10 ⁻² | 2.44×10 ⁻² | 2.66×10 ⁻⁴ | 1.15×10 ⁻² | a | 3.21×10 ⁻¹ | 9.13×10 ⁻² |
| Modified sluicing retrieval system | 2013 | 2033 | 200EW | 2.32×10 ⁻¹ | a | a | a | a | a | a |
| Mobile retrieval system | 2013 | 2023 | 200EW | 3.63×10 ⁻¹ | a | a | a | a | a | a |
| Vacuum-based retrieval system | 2024 | 2033 | 200EW | 5.93×10 ⁻¹ | a | a | a | a | a | a |
| HLW Melter Interim Storage Facility | 2018 | 2139 | WTP_AS | a | a | a | a | a | a | a |
| Contact-Handled Mixed Transuranic Waste Facilities | 2009 | 2010 | 200EW | 2.48×10 ⁻² | 1.94×10 ⁻² | 1.79×10 ⁻⁴ | 8.34×10 ⁻³ | a | 2.70×10 ⁻¹ | 7.66×10 ⁻² |
| Remote-Handled Mixed Transuranic Waste Facility | 2015 | 2019 | 200E | 3.75×10 ⁻³ | 3.73×10 ⁻³ | 2.89×10 ⁻⁵ | 1.46×10 ⁻³ | a | 5.39×10 ⁻² | 1.53×10 ⁻² |
| Transuranic Waste Interim Storage Facility | 2009 | 2034 | WTP_AS | a | a | a | a | a | a | a |
| Bulk Vitrification Facility | 2018 | 2033 | 200W | 1.29×10 ⁻² | 3.01×10 ⁻⁴ | 3.46×10 ⁻⁸ | 1.47×10 ⁻⁶ | 1.24×10 ⁻² | 3.89×10 ⁻⁵ | 1.11×10 ⁻⁴ |
| Solid-Liquid Separations Facility | 2018 | 2033 | SUPW | 3.03×10 ⁻² | 1.55×10 ⁻² | 1.98×10 ⁻⁴ | 8.08×10 ⁻³ | a | 1.92×10 ⁻¹ | 5.49×10 ⁻² |
| Cast Stone Facility | 2018 | 2033 | 200E | 1.11×10 ⁻¹ | 3.41×10 ⁻² | 6.74×10 ⁻⁴ | 2.38×10 ⁻² | a | 3.25×10 ⁻¹ | 9.43×10 ⁻² |
| Effluent Treatment Facility | 2006 | 2036 | WTP_PS | 4.54×10 ⁻³ | 1.71×10 ⁻³ | 2.83×10 ⁻⁵ | 1.05×10 ⁻³ | a | 1.86×10 ⁻² | 5.35×10 ⁻³ |
| Evaporator | 2006 | 2034 | 200E | 8.97×10 ⁻² | 1.21×10 ⁻² | 5.06×10 ⁻⁴ | 1.53×10 ⁻² | a | 5.29×10 ⁻³ | 3.69×10 ⁻³ |
| Borrow Area C | 2006 | 2052 | Area C | 1.78×10 ⁻¹ | 3.12×10 ⁻² | 1.02×10 ⁻³ | 3.21×10 ⁻² | a | 1.32×10 ⁻¹ | 4.15×10 ⁻² |

Table G-24. Tank Closure Alternative 5 Toxic Pollutant Emissions (continued)

| Facility/System | Start Year | End Year | Location | Emission Rate (metric tons per year) | | | | | | | |
|--|------------|----------|----------|--------------------------------------|-----------------------|-----------------------|-----------------------|-----------------------|-----------------------|-----------------------|--|
| | | | | Ammonia | Benzene | 1,3-Butadiene | Formaldehyde | Mercury | Toluene | Xylene | |
| Deactivation | | | | | | | | | | | |
| Sulfate Removal Facility | 2034 | 2035 | WTP_AS | 3.90×10 ⁻³ | 2.44×10 ⁻³ | 2.66×10 ⁻⁵ | 1.15×10 ⁻³ | a | 3.21×10 ⁻² | 9.13×10 ⁻³ | |
| Modified sluicing retrieval system | 2013 | 2033 | 200EW | a | a | a | a | a | a | a | |
| Mobile retrieval system | 2013 | 2023 | 200EW | a | a | a | a | a | a | a | |
| Vacuum-based retrieval system | 2024 | 2033 | 200EW | a | a | a | a | a | a | a | |
| IHLW Interim Storage Facility | 2067 | 2067 | WTP_AS | a | a | a | a | a | a | a | |
| Waste Treatment Plant | 2035 | 2036 | WTP_AS | 5.36×10 ⁻¹ | 3.09×10 ⁻³ | 1.21×10 ⁻⁶ | 3.70×10 ⁻⁵ | 8.01×10 ⁻³ | 4.72×10 ⁻⁵ | 1.85×10 ⁻⁴ | |
| Cesium and Strontium Capsule Processing Facility | 2035 | 2035 | WTP_AS | 1.75×10 ⁻³ | 2.88×10 ⁻³ | 1.63×10 ⁻⁵ | 9.76×10 ⁻⁴ | a | 4.42×10 ⁻² | 1.25×10 ⁻² | |
| Contact-Handled Mixed Transuranic Waste Facilities | 2011 | 2012 | 200EW | 2.48×10 ⁻³ | 1.94×10 ⁻³ | 1.79×10 ⁻⁵ | 8.34×10 ⁻⁴ | a | 2.70×10 ⁻² | 7.66×10 ⁻³ | |
| Remote-Handled Mixed Transuranic Waste Facility | 2020 | 2021 | 200E | 3.75×10 ⁻⁴ | 3.73×10 ⁻⁴ | 2.89×10 ⁻⁶ | 1.46×10 ⁻⁴ | a | 5.39×10 ⁻³ | 1.53×10 ⁻³ | |
| Transuranic Waste Interim Storage Facility | 2035 | 2035 | WTP_AS | a | a | a | a | a | a | a | |
| Bulk Vitrification Facility | 2034 | 2035 | 200W | 1.29×10 ⁻³ | 3.01×10 ⁻⁵ | 3.46×10 ⁻⁹ | 1.47×10 ⁻⁷ | 1.24×10 ⁻³ | 3.89×10 ⁻⁶ | 1.11×10 ⁻⁵ | |
| Solid-Liquid Separations Facility | 2034 | 2035 | SUPW | 3.03×10 ⁻³ | 1.55×10 ⁻³ | 1.98×10 ⁻⁵ | 8.08×10 ⁻⁴ | a | 1.92×10 ⁻² | 5.49×10 ⁻³ | |
| Cast Stone Facility | 2034 | 2035 | 200E | 1.11×10 ⁻² | 3.41×10 ⁻³ | 6.74×10 ⁻⁵ | 2.38×10 ⁻³ | a | 3.25×10 ⁻² | 9.43×10 ⁻³ | |
| Effluent Treatment Facility original | 2026 | 2026 | WTP_AS | 7.88×10 ⁻² | 2.23×10 ⁻² | 4.73×10 ⁻⁴ | 1.64×10 ⁻² | a | 2.00×10 ⁻¹ | 5.81×10 ⁻² | |
| Effluent Treatment Facility replacement 1 | 2037 | 2037 | WTP_AS | 7.88×10 ⁻² | 2.23×10 ⁻² | 4.73×10 ⁻⁴ | 1.64×10 ⁻² | a | 2.00×10 ⁻¹ | 5.81×10 ⁻² | |
| Evaporator original | 2018 | 2018 | 200E | 1.21×10 ⁻² | 1.63×10 ⁻³ | 6.82×10 ⁻⁵ | 2.06×10 ⁻³ | a | 7.14×10 ⁻⁴ | 4.97×10 ⁻⁴ | |
| Evaporator replacement 1 | 2035 | 2035 | 200E | 1.21×10 ⁻² | 1.63×10 ⁻³ | 6.82×10 ⁻⁵ | 2.06×10 ⁻³ | a | 7.14×10 ⁻⁴ | 4.97×10 ⁻⁴ | |
| Closure | | | | | | | | | | | |
| Grout facility (tank-filling) construction | 2022 | 2023 | 200EW | 3.33×10 ⁻² | a | a | a | a | a | a | |
| Grout facility (tank-filling) operations | 2024 | 2033 | 200EW | 1.17×10 ⁻² | a | a | a | a | a | a | |
| Grout facility (tank-filling) deactivation | 2034 | 2034 | 200EW | a | a | a | a | a | a | a | |
| Ancillary equipment grouting | 2013 | 2033 | 200EW | 2.72×10 ⁻⁵ | a | a | a | a | a | a | |
| Hanford barrier construction | 2029 | 2039 | 200EW | 2.55 | 5.09×10 ⁻¹ | 1.48×10 ⁻² | 4.77×10 ⁻¹ | a | 2.91 | 8.83×10 ⁻¹ | |

Table G-24. Tank Closure Alternative 5 Toxic Pollutant Emissions (continued)

| Facility/System | Start Year | End Year | Location | Emission Rate (metric tons per year) | | | | | | |
|---|------------|----------|----------|--------------------------------------|---------|---------------|--------------|---------|---------|--------|
| | | | | Ammonia | Benzene | 1,3-Butadiene | Formaldehyde | Mercury | Toluene | Xylene |
| Closure (continued) | | | | | | | | | | |
| Decontamination and decommissioning of 10 selected Facilities | 2012 | 2022 | 200EW | a | a | a | a | a | a | a |
| Postclosure care | 2040 | 2139 | 200EW | a | a | a | a | a | a | a |

^a Emissions for this activity and pollutant were not calculated because annual fuel use for this activity and the resulting emissions would be small compared with those of other activities or would be zero.

Key: 200E=200-East Area; 200W=200-West Area; 200EW=200-East and 200-West Areas; 200EW+=200-East and 200-West Areas and Waste Treatment Plant area; HLW=high-level radioactive waste; IHLW=immobilized high-level radioactive waste; SUPW=200-West Area supplemental treatment facility; WTP_AS=Waste Treatment Plant area source; WTP_PS=Waste Treatment Plant point source.

Source: SAIC 2007a, 2008.

Table G-25. Tank Closure Alternative 6A, Base Case, Criteria Pollutant Emissions

| Facility/System | Start Year | End Year | Location | Emission Rate (metric tons per year) | | | | |
|--|------------|----------|----------|--------------------------------------|-----------------------|-----------------------|-----------------------|-----------------------|
| | | | | Carbon Monoxide | Nitrogen Dioxide | PM ₁₀ | Sulfur Dioxide | VOCs |
| Construction | | | | | | | | |
| Canister Storage Building | 2006 | 2016 | 200E | 5.54 | 1.28 | 9.05×10 ⁻¹ | 4.02×10 ⁻⁴ | 2.86×10 ⁻¹ |
| IHLW Shipping/Transfer Facility | 2011 | 2013 | 200E | 5.68×10 ¹ | 6.72×10 ¹ | 9.81×10 ¹ | 2.18×10 ⁻² | 6.50 |
| IHLW Interim Storage Modules | 2014 | 2157 | 200E | 5.33×10 ¹ | 6.35×10 ¹ | 2.10×10 ² | 1.94×10 ⁻² | 5.78 |
| Other infrastructure upgrades | 2006 | 2034 | 200EW | 1.11 | 9.43×10 ⁻² | 1.13 | 2.54×10 ⁻⁴ | 9.43×10 ⁻² |
| Tank upgrades | 2006 | 2025 | 200EW | 3.49×10 ² | 4.41×10 ¹ | 8.07 | 1.38×10 ⁻² | 1.56×10 ¹ |
| Waste Treatment Plant original | 2006 | 2017 | WTP_AS | 3.37×10 ² | 2.41×10 ² | 2.86×10 ² | 4.64×10 ⁻¹ | 3.29×10 ¹ |
| Cesium and Strontium Capsule Processing Facility | 2158 | 2161 | WTP_AS | 8.41×10 ² | 1.22×10 ² | 1.80×10 ¹ | 1.13 | 4.78×10 ¹ |
| Tank risers | 2013 | 2016 | 200EW | 2.01×10 ¹ | 8.94 | 8.10×10 ⁻¹ | 1.88×10 ⁻³ | 2.25 |
| Double-shell tank replacement 1 | 2029 | 2034 | 200EW+ | 2.60×10 ² | 2.17×10 ² | 1.35×10 ³ | 6.43×10 ⁻² | 2.20×10 ¹ |
| Double-shell tank replacement 2 | 2069 | 2074 | 200EW+ | 2.60×10 ² | 2.17×10 ² | 1.35×10 ³ | 6.43×10 ⁻² | 2.20×10 ¹ |
| Double-shell tank replacement 3 | 2109 | 2114 | 200EW+ | 2.60×10 ² | 2.17×10 ² | 1.35×10 ³ | 6.43×10 ⁻² | 2.20×10 ¹ |
| Mobile retrieval system | 2013 | 2162 | 200EW | 2.73×10 ¹ | 1.19×10 ¹ | 2.28 | 3.80×10 ⁻³ | 1.81 |
| Vacuum-based retrieval system | 2013 | 2162 | 200EW | 5.79 | 2.62 | 5.26×10 ⁻¹ | 8.34×10 ⁻⁴ | 3.94×10 ⁻¹ |
| Chemical wash system | 2013 | 2162 | 200EW | 5.84×10 ⁻² | 3.12×10 ⁻¹ | 3.89×10 ⁻² | 9.74×10 ⁻⁵ | 1.95×10 ⁻² |
| HLW Melter Interim Storage Facility 1 | 2017 | 2018 | WTP_AS | 6.17×10 ⁻¹ | 1.38 | 1.72×10 ¹ | 2.86×10 ⁻⁴ | 6.73×10 ⁻² |
| HLW Melter Interim Storage Facility 2 | 2037 | 2038 | WTP_AS | 6.17×10 ⁻¹ | 1.38 | 1.72×10 ¹ | 2.86×10 ⁻⁴ | 6.73×10 ⁻² |
| HLW Melter Interim Storage Facility 3 | 2057 | 2058 | WTP_AS | 6.17×10 ⁻¹ | 1.38 | 1.72×10 ¹ | 2.86×10 ⁻⁴ | 6.73×10 ⁻² |
| HLW Melter Interim Storage Facility 4 | 2077 | 2078 | WTP_AS | 6.17×10 ⁻¹ | 1.38 | 1.72×10 ¹ | 2.86×10 ⁻⁴ | 6.73×10 ⁻² |
| HLW Melter Interim Storage Facility 5 | 2097 | 2098 | WTP_AS | 6.17×10 ⁻¹ | 1.38 | 1.72×10 ¹ | 2.86×10 ⁻⁴ | 6.73×10 ⁻² |
| HLW Melter Interim Storage Facility 6 | 2117 | 2118 | WTP_AS | 6.17×10 ⁻¹ | 1.38 | 1.72×10 ¹ | 2.86×10 ⁻⁴ | 6.73×10 ⁻² |
| HLW Melter Interim Storage Facility 7 | 2137 | 2138 | WTP_AS | 6.17×10 ⁻¹ | 1.38 | 1.72×10 ¹ | 2.86×10 ⁻⁴ | 6.73×10 ⁻² |
| Underground transfer line replacement | 2064 | 2064 | 200EW+ | 7.59×10 ¹ | 2.71×10 ¹ | 2.41×10 ¹ | 8.75×10 ⁻³ | 4.47 |
| Waste Treatment Plant replacement 1 | 2067 | 2078 | WTP_AS | 3.30×10 ² | 2.36×10 ² | 2.34×10 ² | 4.54×10 ⁻¹ | 3.22×10 ¹ |
| Waste Treatment Plant replacement 2 | 2127 | 2138 | WTP_AS | 3.30×10 ² | 2.36×10 ² | 2.34×10 ² | 4.54×10 ⁻¹ | 3.22×10 ¹ |
| IHLW Shipping/Transfer Facility 1 | 2076 | 2078 | 200E | 5.68×10 ¹ | 6.72×10 ¹ | 9.81×10 ¹ | 2.18×10 ⁻² | 6.50 |
| IHLW Shipping/Transfer Facility 2 | 2136 | 2138 | 200E | 5.68×10 ¹ | 6.72×10 ¹ | 9.81×10 ¹ | 2.18×10 ⁻² | 6.50 |

Table G-25. Tank Closure Alternative 6A, Base Case, Criteria Pollutant Emissions (continued)

| Facility/System | Start Year | End Year | Location | Emission Rate (metric tons per year) | | | | |
|--|------------|----------|----------|--------------------------------------|-----------------------|-----------------------|-----------------------|-----------------------|
| | | | | Carbon Monoxide | Nitrogen Dioxide | PM ₁₀ | Sulfur Dioxide | VOCs |
| Construction (continued) | | | | | | | | |
| IHLW Shipping/Transfer Facility 3 | 2196 | 2198 | 200E | 5.68×10 ¹ | 6.72×10 ¹ | 9.81×10 ¹ | 2.18×10 ⁻² | 6.50 |
| IHLW Interim Storage Module, additional | 2078 | 2197 | 200E | 1.45×10 ² | 1.73×10 ² | 5.72×10 ² | 5.27×10 ⁻² | 1.57×10 ¹ |
| HLW Debris Storage Facility | 2041 | 2110 | 200EW | 3.37×10 ⁻¹ | 1.56 | 1.10×10 ⁻¹ | 5.31×10 ⁻⁴ | 1.28×10 ⁻¹ |
| Effluent Treatment Facility replacement 1 | 2023 | 2025 | 200E | 1.45×10 ³ | 2.09×10 ² | 9.48×10 ² | 1.96 | 8.25×10 ¹ |
| Effluent Treatment Facility replacement 2 | 2053 | 2055 | 200E | 1.45×10 ³ | 2.09×10 ² | 9.48×10 ² | 1.96 | 8.25×10 ¹ |
| Effluent Treatment Facility replacement 3 | 2083 | 2085 | 200E | 1.45×10 ³ | 2.09×10 ² | 9.48×10 ² | 1.96 | 8.25×10 ¹ |
| Effluent Treatment Facility replacement 4 | 2113 | 2115 | 200E | 1.45×10 ³ | 2.09×10 ² | 9.48×10 ² | 1.96 | 8.25×10 ¹ |
| Effluent Treatment Facility replacement 5 | 2143 | 2145 | 200E | 1.45×10 ³ | 2.09×10 ² | 9.48×10 ² | 1.96 | 8.25×10 ¹ |
| Evaporator replacement 1 | 2015 | 2017 | 200E | 4.51×10 ² | 6.53×10 ¹ | 1.76×10 ¹ | 6.07×10 ⁻¹ | 2.56×10 ¹ |
| Evaporator replacement 2 | 2040 | 2042 | 200E | 4.51×10 ² | 6.53×10 ¹ | 1.76×10 ¹ | 6.07×10 ⁻¹ | 2.56×10 ¹ |
| Evaporator replacement 3 | 2065 | 2067 | 200E | 4.51×10 ² | 6.53×10 ¹ | 1.76×10 ¹ | 6.07×10 ⁻¹ | 2.56×10 ¹ |
| Evaporator replacement 4 | 2090 | 2092 | 200E | 4.51×10 ² | 6.53×10 ¹ | 1.76×10 ¹ | 6.07×10 ⁻¹ | 2.56×10 ¹ |
| Evaporator replacement 5 | 2115 | 2117 | 200E | 4.51×10 ² | 6.53×10 ¹ | 1.76×10 ¹ | 6.07×10 ⁻¹ | 2.56×10 ¹ |
| Evaporator replacement 6 | 2140 | 2142 | 200E | 4.51×10 ² | 6.53×10 ¹ | 1.76×10 ¹ | 6.07×10 ⁻¹ | 2.56×10 ¹ |
| Underground transfer line 1,000-foot sections | 2009 | 2009 | 200EW+ | 7.59×10 ¹ | 2.71×10 ¹ | 2.41×10 ¹ | 8.75×10 ⁻³ | 4.47 |
| Operations | | | | | | | | |
| IHLW Interim Storage Facility | 2018 | 2262 | 200E | a | a | a | a | a |
| Other infrastructure upgrades | 2006 | 2162 | 200EW | a | a | a | a | a |
| Routine operations | 2006 | 2162 | 200EW | 1.36×10 ¹ | 1.55×10 ¹ | a | a | 5.40 |
| Retrieval operations | 2006 | 2162 | 200EW | 4.72×10 ⁻² | 5.35×10 ⁻² | a | a | 1.89×10 ⁻² |
| Double-shell tank interim stabilization | 2006 | 2162 | 200EW | 3.09×10 ⁻¹ | 3.51×10 ⁻¹ | a | a | 1.24×10 ⁻¹ |
| Waste Treatment Plant | 2018 | 2162 | WTP_PS | 2.71×10 ² | 5.32×10 ² | 2.08 | 1.07×10 ¹ | 9.91×10 ² |
| Waste Treatment Plant, cesium and strontium capsules | 2163 | 2163 | WTP_PS | 2.71×10 ² | 5.32×10 ² | 2.08 | 1.07×10 ¹ | 9.91×10 ² |
| Cesium and Strontium Capsule Processing Facility | 2162 | 2163 | WTP_AS | 4.85×10 ¹ | 1.29 | 5.53×10 ¹ | 6.49×10 ⁻² | 2.34 |
| Mobile retrieval system | 2013 | 2162 | 200EW | 1.26×10 ⁻¹ | 1.42×10 ⁻¹ | a | a | 5.02×10 ⁻² |
| Vacuum-based retrieval system | 2013 | 2162 | 200EW | 3.95×10 ⁻² | 4.47×10 ⁻² | a | a | 1.58×10 ⁻² |
| Chemical wash system | 2013 | 2162 | 200EW | 3.89×10 ⁻² | 1.36×10 ⁻¹ | 4.09×10 ⁻¹ | 3.87×10 ⁻⁵ | a |

Table G-25. Tank Closure Alternative 6A, Base Case, Criteria Pollutant Emissions (continued)

| Facility/System | Start Year | End Year | Location | Emission Rate (metric tons per year) | | | | |
|--|------------|----------|----------|--------------------------------------|-----------------------|-----------------------|-----------------------|-----------------------|
| | | | | Carbon Monoxide | Nitrogen Dioxide | PM ₁₀ | Sulfur Dioxide | VOCs |
| Operations (continued) | | | | | | | | |
| HLW Melter Interim Storage Facility | 2018 | 2262 | WTP_AS | a | a | a | a | a |
| HLW Debris Storage Facility | 2042 | 2262 | 200EW | a | a | a | a | a |
| Effluent Treatment Facility | 2006 | 2166 | WTP_PS | 9.84 | 2.67 | 9.34×10 ² | 1.33×10 ⁻² | 6.48×10 ⁻¹ |
| Evaporator | 2018 | 2163 | 200E | 1.23×10 ¹ | 5.70×10 ¹ | 1.71×10 ¹ | 1.94×10 ⁻² | 4.66 |
| Borrow Area C | 2006 | 2167 | Area C | 8.52×10 ¹ | 1.12×10 ² | 2.30×10 ² | 1.20×10 ⁻¹ | 1.20×10 ¹ |
| Deactivation | | | | | | | | |
| Mobile retrieval system | 2013 | 2162 | 200EW | 1.36×10 ¹ | 1.07 | 8.89×10 ⁻² | 3.27×10 ⁻⁴ | 5.63×10 ⁻¹ |
| Vacuum-based retrieval system | 2013 | 2162 | 200EW | 1.26×10 ⁻¹ | 9.89×10 ⁻³ | 8.99×10 ⁻⁴ | 3.02×10 ⁻⁶ | 5.15×10 ⁻³ |
| Chemical wash system | 2013 | 2162 | 200EW | 5.39×10 ⁻¹ | 9.51×10 ⁻² | 8.02×10 ⁻³ | 3.03×10 ⁻⁵ | 2.56×10 ⁻² |
| IHLW Interim Storage Facility | 2078 | 2197 | WTP_AS | a | a | a | a | a |
| Waste Treatment Plant original | | 2080 | WTP_AS | 1.51×10 ¹ | 2.97×10 ¹ | 1.16×10 ⁻¹ | 5.95×10 ⁻¹ | 5.54×10 ¹ |
| Waste Treatment Plant replacement 1 | 2138 | 2140 | WTP_AS | 1.51×10 ¹ | 2.97×10 ¹ | 1.16×10 ⁻¹ | 5.95×10 ⁻¹ | 5.54×10 ¹ |
| Waste Treatment Plant replacement 2 | 2164 | 2166 | WTP_AS | 1.51×10 ¹ | 2.97×10 ¹ | 1.16×10 ⁻¹ | 5.95×10 ⁻¹ | 5.54×10 ¹ |
| Cesium and Strontium Capsule Processing Facility | 2164 | 2164 | WTP_AS | 2.24×10 ¹ | 5.96×10 ⁻¹ | 2.55×10 ¹ | 3.00×10 ⁻² | 1.08 |
| Effluent Treatment Facility original | 2026 | 2026 | WTP_AS | 1.09×10 ² | 4.78×10 ¹ | 4.70×10 ² | 1.48×10 ⁻¹ | 8.47 |
| Effluent Treatment Facility replacement 1 | 2056 | 2056 | WTP_AS | 1.09×10 ² | 4.78×10 ¹ | 4.70×10 ² | 1.48×10 ⁻¹ | 8.47 |
| Effluent Treatment Facility replacement 2 | 2086 | 2086 | WTP_AS | 1.09×10 ² | 4.78×10 ¹ | 4.70×10 ² | 1.48×10 ⁻¹ | 8.47 |
| Effluent Treatment Facility replacement 3 | 2116 | 2116 | WTP_AS | 1.09×10 ² | 4.78×10 ¹ | 4.70×10 ² | 1.48×10 ⁻¹ | 8.47 |
| Effluent Treatment Facility replacement 4 | 2146 | 2146 | WTP_AS | 1.09×10 ² | 4.78×10 ¹ | 4.70×10 ² | 1.48×10 ⁻¹ | 8.47 |
| Effluent Treatment Facility replacement 5 | 2167 | 2167 | WTP_AS | 1.09×10 ² | 4.78×10 ¹ | 4.70×10 ² | 1.48×10 ⁻¹ | 8.47 |
| Evaporator original | 2078 | 2018 | 200E | 1.66 | 7.70 | 7.07 | 2.62×10 ⁻³ | 6.28×10 ⁻¹ |
| Evaporator replacement 1 | 2043 | 2043 | 200E | 1.66 | 7.70 | 7.07 | 2.62×10 ⁻³ | 6.28×10 ⁻¹ |
| Evaporator replacement 2 | 2068 | 2068 | 200E | 1.66 | 7.70 | 7.07 | 2.62×10 ⁻³ | 6.28×10 ⁻¹ |
| Evaporator replacement 3 | 2093 | 2093 | 200E | 1.66 | 7.70 | 7.07 | 2.62×10 ⁻³ | 6.28×10 ⁻¹ |
| Evaporator replacement 4 | 2118 | 2118 | 200E | 1.66 | 7.70 | 7.07 | 2.62×10 ⁻³ | 6.28×10 ⁻¹ |
| Evaporator replacement 5 | 2143 | 2143 | 200E | 1.66 | 7.70 | 7.07 | 2.62×10 ⁻³ | 6.28×10 ⁻¹ |
| Evaporator replacement 6 | 2168 | 2168 | 200E | 1.66 | 7.70 | 7.07 | 2.62×10 ⁻³ | 6.28×10 ⁻¹ |

Table G-25. Tank Closure Alternative 6A, Base Case, Criteria Pollutant Emissions (continued)

| Facility/System | Start Year | End Year | Location | Emission Rate (metric tons per year) | | | | |
|---|------------|----------|----------|--------------------------------------|----------------------|----------------------|-----------------------|-----------------------|
| | | | | Carbon Monoxide | Nitrogen Dioxide | PM ₁₀ | Sulfur Dioxide | VOCs |
| Closure | | | | | | | | |
| Containment structure construction 1 | 2038 | 2041 | 200EW | 6.78×10 ¹ | 7.06 | 2.74 | 2.19×10 ⁻³ | 2.91 |
| Containment structure construction 2 | 2061 | 2064 | 200EW | 6.78×10 ¹ | 7.06 | 2.74 | 2.19×10 ⁻³ | 2.91 |
| Containment structure construction 3 | 2084 | 2087 | 200EW | 6.78×10 ¹ | 7.06 | 2.74 | 2.19×10 ⁻³ | 2.91 |
| Containment structure construction 4 | 2107 | 2110 | 200EW | 6.78×10 ¹ | 7.06 | 2.74 | 2.19×10 ⁻³ | 2.91 |
| Containment structure construction 5 | 2122 | 2125 | 200EW | 6.78×10 ¹ | 7.06 | 2.74 | 2.19×10 ⁻³ | 2.91 |
| Containment structure construction 6 | 2138 | 2141 | 200EW | 6.78×10 ¹ | 7.06 | 2.74 | 2.19×10 ⁻³ | 2.91 |
| Containment structure deactivation 1 | 2062 | 2064 | 200EW | 9.03×10 ¹ | 9.39 | 3.09 | 2.92×10 ⁻³ | 3.88 |
| Containment structure deactivation 2 | 2085 | 2087 | 200EW | 9.03×10 ¹ | 9.39 | 3.09 | 2.92×10 ⁻³ | 3.88 |
| Containment structure deactivation 3 | 2108 | 2110 | 200EW | 9.03×10 ¹ | 9.39 | 3.09 | 2.92×10 ⁻³ | 3.88 |
| Containment structure deactivation 4 | 2123 | 2125 | 200EW | 9.03×10 ¹ | 9.39 | 3.09 | 2.92×10 ⁻³ | 3.88 |
| Containment structure deactivation 5 | 2146 | 2148 | 200EW | 9.03×10 ¹ | 9.39 | 3.09 | 2.92×10 ⁻³ | 1.94 |
| Containment structure deactivation 6 | 2138 | 2140 | 200EW | 9.03×10 ¹ | 9.39 | 3.09 | 2.92×10 ⁻³ | 1.94 |
| Containment structure deactivation 7 | 2162 | 2164 | 200EW | 9.03×10 ¹ | 9.39 | 3.09 | 2.92×10 ⁻³ | 3.88 |
| Decontamination and decommissioning of 10 selected facilities | 2018 | 2028 | 200EW | 2.53 | 9.81 | 8.56 | 3.22×10 ⁻³ | 7.93×10 ⁻¹ |
| Modified Resource Conservation and Recovery Act Subtitle C barrier construction | 2149 | 2150 | 200EW | 1.72×10 ³ | 1.57×10 ³ | 3.65×10 ³ | 2.38 | 1.93×10 ² |
| Postclosure care | 2151 | 2250 | 200EW | a | a | a | a | a |
| B tank farm removal | 2065 | 2076 | 200EW | 1.84×10 ¹ | 8.27×10 ¹ | 1.07×10 ¹ | 2.89×10 ⁻² | 6.78 |
| T tank farm removal | 2126 | 2137 | 200EW | 1.84×10 ¹ | 8.27×10 ¹ | 1.07×10 ¹ | 2.89×10 ⁻² | 6.78 |
| BY tank farm removal | 2111 | 2122 | 200EW | 1.38×10 ¹ | 6.20×10 ¹ | 8.04 | 2.17×10 ⁻² | 5.08 |
| BX tank farm removal | 2042 | 2053 | 200EW | 1.38×10 ¹ | 6.20×10 ¹ | 8.04 | 2.17×10 ⁻² | 5.08 |
| C tank farm removal | 2088 | 2099 | 200EW | 1.84×10 ¹ | 8.27×10 ¹ | 1.07×10 ¹ | 2.89×10 ⁻² | 6.78 |
| A tank farm removal | 2142 | 2153 | 200EW | 6.89 | 3.10×10 ¹ | 4.02 | 1.08×10 ⁻² | 2.54 |
| AX tank farm removal | 2142 | 2153 | 200EW | 1.84×10 ¹ | 8.27×10 ¹ | 1.07×10 ¹ | 2.89×10 ⁻² | 6.78 |
| S tank farm removal | 2126 | 2137 | 200EW | 1.38×10 ¹ | 6.20×10 ¹ | 8.04 | 2.17×10 ⁻² | 5.08 |
| TY tank farm removal | 2111 | 2122 | 200EW | 6.89 | 3.10×10 ¹ | 4.02 | 1.08×10 ⁻² | 2.54 |
| TX tank farm removal | 2088 | 2099 | 200EW | 2.07×10 ¹ | 9.31×10 ¹ | 1.21×10 ¹ | 3.25×10 ⁻² | 7.63 |

Table G-25. Tank Closure Alternative 6A, Base Case, Criteria Pollutant Emissions (*continued*)

| Facility/System | Start Year | End Year | Location | Emission Rate (metric tons per year) | | | | |
|-------------------------------------|------------|----------|----------|--------------------------------------|-----------------------|-----------------------|-----------------------|-----------------------|
| | | | | Carbon Monoxide | Nitrogen Dioxide | PM ₁₀ | Sulfur Dioxide | VOCs |
| Closure (<i>continued</i>) | | | | | | | | |
| U tank farm removal | 2065 | 2076 | 200EW | 1.84×10 ¹ | 8.27×10 ¹ | 1.07×10 ¹ | 2.89×10 ⁻² | 6.78 |
| SX tank farm removal | 2042 | 2053 | 200EW | 1.72×10 ¹ | 7.75×10 ¹ | 1.01×10 ¹ | 2.71×10 ⁻² | 6.35 |
| B tank farm deep soil removal | 2077 | 2084 | 200E | 3.84 | 1.78×10 ¹ | 1.89 | 6.06×10 ⁻³ | 1.46 |
| T tank farm deep soil removal | 2138 | 2145 | 200W | 2.95×10 ¹ | 1.37×10 ² | 1.45×10 ¹ | 4.66×10 ⁻² | 1.12×10 ¹ |
| BX tank farm deep soil removal | 2054 | 2061 | 200E | 1.23×10 ² | 5.71×10 ² | 6.04×10 ¹ | 1.94×10 ⁻¹ | 4.66×10 ¹ |
| C tank farm deep soil removal | 2100 | 2107 | 200EW | 2.33×10 ⁻¹ | 1.08 | 1.15×10 ⁻¹ | 3.68×10 ⁻⁴ | 8.82×10 ⁻² |
| A tank farm deep soil removal | 2154 | 2161 | 200E | 6.99×10 ⁻¹ | 3.24 | 3.43×10 ⁻¹ | 1.10×10 ⁻³ | 2.65×10 ⁻¹ |
| AX tank farm deep soil removal | 2154 | 2161 | 200E | 1.16×10 ¹ | 5.41×10 ¹ | 5.72 | 1.84×10 ⁻² | 4.41 |
| TX tank farm deep soil removal | 2100 | 2107 | 200EW | 3.67×10 ¹ | 1.70×10 ² | 1.80×10 ¹ | 5.79×10 ⁻² | 1.39×10 ¹ |
| U tank farm deep soil removal | 2077 | 2084 | 200EW | 1.92×10 ¹ | 8.92×10 ¹ | 9.44 | 3.03×10 ⁻² | 7.28 |
| SX tank farm deep soil removal | 2054 | 2061 | 200W | 4.69×10 ¹ | 2.18×10 ² | 2.31×10 ¹ | 7.40×10 ⁻² | 1.78×10 ¹ |
| Preprocessing Facility construction | 2039 | 2041 | 200E | 7.88×10 ² | 5.70×10 ² | 1.71×10 ² | 1.08 | 7.74×10 ¹ |
| Preprocessing Facility operations | 2042 | 2162 | 200E | 3.53×10 ⁻¹ | 1.30×10 ⁻¹ | 1.16×10 ⁻² | 3.60×10 ⁻² | 3.42×10 ⁻¹ |
| Preprocessing Facility deactivation | 2163 | 2163 | 200E | 5.54×10 ⁻² | 2.05×10 ⁻² | 1.82×10 ⁻³ | 5.65×10 ⁻³ | 5.38×10 ⁻² |

^a Emissions for this activity and pollutant were not calculated because annual fuel use for this activity and the resulting emissions would be small compared with those of other activities or would be zero.

Key: 200E=200-East Area; 200W=200-West Area; 200EW=200-East and 200-West Areas; 200EW+=200-East and 200-West Areas and Waste Treatment Plant area; HLW=high-level radioactive waste; IHLW=immobilized high-level radioactive waste; PM₁₀=particulate matter with an aerodynamic diameter less than or equal to 10 micrometers; VOC=volatile organic compound; WTP_AS=Waste Treatment Plant area source; WTP_PS=Waste Treatment Plant point source.

Source: SAIC 2007a, 2008.

Table G-26. Tank Closure Alternative 6A, Base Case, Toxic Pollutant Emissions

| Facility/System | Start Year | End Year | Location | Emission Rate (metric tons per year) | | | | | | |
|--|------------|----------|----------|--------------------------------------|-----------------------|-----------------------|-----------------------|---------|-----------------------|-----------------------|
| | | | | Ammonia | Benzene | 1,3-Butadiene | Formaldehyde | Mercury | Toluene | Xylene |
| Construction | | | | | | | | | | |
| Canister Storage Building | 2006 | 2016 | 200E | a | a | a | a | a | a | a |
| IHLW Shipping/Transfer Facility | 2011 | 2013 | 200E | a | a | a | a | a | a | a |
| IHLW Interim Storage Modules | 2014 | 2157 | 200E | a | a | a | a | a | a | a |
| Other infrastructure upgrades | 2006 | 2034 | 200EW | a | a | a | a | a | a | a |
| Tank upgrades | 2006 | 2025 | 200EW | 7.82×10 ⁻² | a | a | a | a | a | a |
| Waste Treatment Plant original | 2006 | 2017 | WTP_AS | 3.89×10 ⁻¹ | 8.63×10 ⁻² | 2.28×10 ⁻³ | 7.49×10 ⁻² | a | 5.89×10 ⁻¹ | 1.75×10 ⁻¹ |
| Cesium and Strontium Capsule Processing Facility | 2158 | 2161 | WTP_AS | 2.22×10 ⁻¹ | 1.27×10 ⁻¹ | 1.49×10 ⁻³ | 6.26×10 ⁻² | a | 1.63 | 4.64×10 ⁻¹ |
| Tank risers | 2013 | 2016 | 200EW | 2.38 | a | a | a | a | a | a |
| Double-shell tank replacement 1 | 2029 | 2034 | 200EW+ | a | a | a | a | a | a | a |
| Double-shell tank replacement 2 | 2069 | 2074 | 200EW+ | a | a | a | a | a | a | a |
| Double-shell tank replacement 3 | 2109 | 2114 | 200EW+ | a | a | a | a | a | a | a |
| Mobile retrieval system | 2013 | 2162 | 200EW | 1.09×10 ⁻¹ | a | a | a | a | a | a |
| Vacuum-based retrieval system | 2013 | 2162 | 200EW | 3.42×10 ⁻² | a | a | a | a | a | a |
| Chemical wash system | 2013 | 2162 | 200EW | 1.43×10 ⁻³ | a | a | a | a | a | a |
| HLW Melter Interim Storage Facility 1 | 2017 | 2018 | WTP_AS | a | a | a | a | a | a | a |
| HLW Melter Interim Storage Facility 2 | 2037 | 2038 | WTP_AS | a | a | a | a | a | a | a |
| HLW Melter Interim Storage Facility 3 | 2057 | 2058 | WTP_AS | a | a | a | a | a | a | a |
| HLW Melter Interim Storage Facility 4 | 2077 | 2078 | WTP_AS | a | a | a | a | a | a | a |
| HLW Melter Interim Storage Facility 5 | 2097 | 2098 | WTP_AS | a | a | a | a | a | a | a |
| HLW Melter Interim Storage Facility 6 | 2117 | 2118 | WTP_AS | a | a | a | a | a | a | a |
| HLW Melter Interim Storage Facility 7 | 2137 | 2138 | WTP_AS | a | a | a | a | a | a | a |
| Underground transfer line replacement | 2064 | 2064 | 200EW+ | a | a | a | a | a | a | a |
| Waste Treatment Plant replacement 1 | 2067 | 2078 | WTP_AS | 3.81×10 ⁻¹ | 8.45×10 ⁻² | 2.23×10 ⁻³ | 7.33×10 ⁻² | a | 5.76×10 ⁻¹ | 1.72×10 ⁻¹ |
| Waste Treatment Plant replacement 2 | 2127 | 2138 | WTP_AS | 3.81×10 ⁻¹ | 8.45×10 ⁻² | 2.23×10 ⁻³ | 7.33×10 ⁻² | a | 5.76×10 ⁻¹ | 1.72×10 ⁻¹ |
| IHLW Shipping/Transfer Facility 1 | 2076 | 2078 | 200E | a | a | a | a | a | a | a |
| IHLW Shipping/Transfer Facility 2 | 2136 | 2138 | 200E | a | a | a | a | a | a | a |
| IHLW Shipping/Transfer Facility 3 | 2196 | 2198 | 200E | a | a | a | a | a | a | a |

Table G-26. Tank Closure Alternative 6A, Base Case, Toxic Pollutant Emissions (continued)

| Facility/System | Start Year | End Year | Location | Emission Rate (metric tons per year) | | | | | | |
|--|------------|----------|----------|--------------------------------------|-----------------------|-----------------------|-----------------------|-----------------------|-----------------------|-----------------------|
| | | | | Ammonia | Benzene | 1,3-Butadiene | Formaldehyde | Mercury | Toluene | Xylene |
| Construction (continued) | | | | | | | | | | |
| IHLW Interim Storage Module, additional | 2078 | 2197 | 200E | a | a | a | a | a | a | a |
| HLW Debris Storage Facility | 2041 | 2110 | 200EW | 2.46×10 ⁻³ | 3.31×10 ⁻⁴ | 1.39×10 ⁻⁵ | 4.18×10 ⁻⁴ | a | 1.45×10 ⁻⁴ | 1.01×10 ⁻⁴ |
| Effluent Treatment Facility replacement 1 | 2023 | 2025 | 200E | 3.81×10 ⁻¹ | 2.19×10 ⁻¹ | 2.55×10 ⁻³ | 1.08×10 ⁻¹ | a | 2.82 | 8.02×10 ⁻¹ |
| Effluent Treatment Facility replacement 2 | 2053 | 2055 | 200E | 3.81×10 ⁻¹ | 2.19×10 ⁻¹ | 2.55×10 ⁻³ | 1.08×10 ⁻¹ | a | 2.82 | 8.02×10 ⁻¹ |
| Effluent Treatment Facility replacement 3 | 2083 | 2085 | 200E | 3.81×10 ⁻¹ | 2.19×10 ⁻¹ | 2.55×10 ⁻³ | 1.08×10 ⁻¹ | a | 2.82 | 8.02×10 ⁻¹ |
| Effluent Treatment Facility replacement 4 | 2113 | 2115 | 200E | 3.81×10 ⁻¹ | 2.19×10 ⁻¹ | 2.55×10 ⁻³ | 1.08×10 ⁻¹ | a | 2.82 | 8.02×10 ⁻¹ |
| Effluent Treatment Facility replacement 5 | 2143 | 2145 | 200E | 3.81×10 ⁻¹ | 2.19×10 ⁻¹ | 2.55×10 ⁻³ | 1.08×10 ⁻¹ | a | 2.82 | 8.02×10 ⁻¹ |
| Evaporator replacement 1 | 2015 | 2017 | 200E | 1.19×10 ⁻¹ | 6.80×10 ⁻² | 7.95×10 ⁻⁴ | 3.35×10 ⁻² | a | 8.74×10 ⁻¹ | 2.49×10 ⁻¹ |
| Evaporator replacement 2 | 2040 | 2042 | 200E | 1.19×10 ⁻¹ | 6.80×10 ⁻² | 7.95×10 ⁻⁴ | 3.35×10 ⁻² | a | 8.74×10 ⁻¹ | 2.49×10 ⁻¹ |
| Evaporator replacement 3 | 2065 | 2067 | 200E | 1.19×10 ⁻¹ | 6.80×10 ⁻² | 7.95×10 ⁻⁴ | 3.35×10 ⁻² | a | 8.74×10 ⁻¹ | 2.49×10 ⁻¹ |
| Evaporator replacement 4 | 2090 | 2092 | 200E | 1.19×10 ⁻¹ | 6.80×10 ⁻² | 7.95×10 ⁻⁴ | 3.35×10 ⁻² | a | 8.74×10 ⁻¹ | 2.49×10 ⁻¹ |
| Evaporator replacement 5 | 2115 | 2117 | 200E | 1.19×10 ⁻¹ | 6.80×10 ⁻² | 7.95×10 ⁻⁴ | 3.35×10 ⁻² | a | 8.74×10 ⁻¹ | 2.49×10 ⁻¹ |
| Evaporator replacement 6 | 2140 | 2142 | 200E | 1.19×10 ⁻¹ | 6.80×10 ⁻² | 7.95×10 ⁻⁴ | 3.35×10 ⁻² | a | 8.74×10 ⁻¹ | 2.49×10 ⁻¹ |
| Underground transfer line 1,000-foot sections | 2009 | 2009 | 200EW+ | a | a | a | a | a | a | a |
| Operations | | | | | | | | | | |
| IHLW Interim Storage Facility | 2018 | 2262 | 200E | a | a | a | a | a | a | a |
| Other infrastructure upgrades | 2006 | 2162 | 200EW | a | a | a | a | a | a | a |
| Routine operations | 2006 | 2162 | 200EW | 1.18×10 ¹ | a | a | a | a | a | a |
| Retrieval operations | 2006 | 2162 | 200EW | 4.09×10 ⁻² | a | a | a | a | a | a |
| Double-shell tank interim stabilization | 2006 | 2162 | 200EW | 2.68×10 ⁻¹ | a | a | a | a | a | a |
| Waste Treatment Plant | 2018 | 2162 | WTP_PS | 4.09 | 2.58×10 ⁻² | 9.32×10 ⁻⁶ | 2.88×10 ⁻⁴ | 1.26×10 ⁻² | 7.29×10 ⁻⁴ | 2.45×10 ⁻³ |
| Waste Treatment Plant, cesium and strontium capsules | 2163 | 2163 | WTP_PS | 4.09 | 2.58×10 ⁻² | 1.35×10 ⁻³ | 2.88×10 ⁻⁴ | a | 7.29×10 ⁻⁴ | 2.45×10 ⁻³ |
| Cesium and Strontium Capsule Processing Facility | 2162 | 2163 | WTP_AS | 3.80×10 ⁻³ | 6.24×10 ⁻³ | 3.53×10 ⁻⁵ | 2.11×10 ⁻³ | a | 9.58×10 ⁻² | 2.70×10 ⁻² |
| Mobile retrieval system | 2013 | 2162 | 200EW | 1.09×10 ⁻¹ | a | a | a | a | a | a |
| Vacuum-based retrieval system | 2013 | 2162 | 200EW | 3.42×10 ⁻² | a | a | a | a | a | a |
| Chemical wash system | 2013 | 2162 | 200EW | 1.43×10 ⁻³ | a | a | a | a | a | a |

Table G-26. Tank Closure Alternative 6A, Base Case, Toxic Pollutant Emissions (continued)

| Facility/System | Start Year | End Year | Location | Emission Rate (metric tons per year) | | | | | | |
|--|------------|----------|----------|--------------------------------------|-----------------------|-----------------------|-----------------------|-----------------------|-----------------------|-----------------------|
| | | | | Ammonia | Benzene | 1,3-Butadiene | Formaldehyde | Mercury | Toluene | Xylene |
| Operations (continued) | | | | | | | | | | |
| HLW Melter Interim Storage Facility | 2018 | 2262 | WTP_AS | a | a | a | a | a | a | a |
| HLW Debris Storage Facility | 2042 | 2262 | 200EW | a | a | a | a | a | a | a |
| Effluent Treatment Facility | 2006 | 2166 | WTP_PS | 4.54×10 ⁻³ | 1.71×10 ⁻³ | 2.83×10 ⁻⁵ | 1.05×10 ⁻³ | a | 1.86×10 ⁻² | 5.35×10 ⁻³ |
| Evaporator | 2018 | 2163 | 200E | 8.97×10 ⁻² | 1.21×10 ⁻² | 5.06×10 ⁻⁴ | 1.53×10 ⁻² | a | 5.29×10 ⁻³ | 3.69×10 ⁻³ |
| Borrow Area C | 2006 | 2167 | Area C | 1.78×10 ⁻¹ | 3.12×10 ⁻² | 1.02×10 ⁻³ | 3.21×10 ⁻² | a | 1.32×10 ⁻¹ | 4.15×10 ⁻² |
| Deactivation | | | | | | | | | | |
| Mobile retrieval system | 2013 | 2162 | 200EW | a | a | a | a | a | a | a |
| Vacuum-based retrieval system | 2013 | 2162 | 200EW | a | a | a | a | a | a | a |
| Chemical wash system | 2013 | 2162 | 200EW | a | a | a | a | a | a | a |
| IHLW Interim Storage Facility | 2078 | 2197 | WTP_AS | a | a | a | a | a | a | a |
| Waste Treatment Plant original | 2078 | 2080 | WTP_AS | 2.29×10 ⁻¹ | 1.44×10 ⁻³ | 5.21×10 ⁻⁷ | 1.61×10 ⁻⁵ | 7.08×10 ⁻⁴ | 4.07×10 ⁻⁵ | 1.37×10 ⁻⁴ |
| Waste Treatment Plant replacement 1 | 2138 | 2140 | WTP_AS | 2.29×10 ⁻¹ | 1.44×10 ⁻³ | 5.21×10 ⁻⁷ | 1.61×10 ⁻⁵ | 7.08×10 ⁻⁴ | 4.07×10 ⁻⁵ | 1.37×10 ⁻⁴ |
| Waste Treatment Plant replacement 2 | 2164 | 2166 | WTP_AS | 2.29×10 ⁻¹ | 1.44×10 ⁻³ | 5.21×10 ⁻⁷ | 1.61×10 ⁻⁵ | 7.08×10 ⁻⁴ | 4.07×10 ⁻⁵ | 1.37×10 ⁻⁴ |
| Cesium and Strontium Capsule Processing Facility | 2164 | 2164 | WTP_AS | 1.75×10 ⁻³ | 2.88×10 ⁻³ | 1.63×10 ⁻⁵ | 9.76×10 ⁻⁴ | a | 4.42×10 ⁻² | 1.25×10 ⁻² |
| Effluent Treatment Facility original | 2026 | 2026 | WTP_AS | 7.88×10 ⁻² | 2.23×10 ⁻² | 4.73×10 ⁻⁴ | 1.64×10 ⁻² | a | 2.00×10 ⁻¹ | 5.81×10 ⁻² |
| Effluent Treatment Facility replacement 1 | 2056 | 2056 | WTP_AS | 7.88×10 ⁻² | 2.23×10 ⁻² | 4.73×10 ⁻⁴ | 1.64×10 ⁻² | a | 2.00×10 ⁻¹ | 5.81×10 ⁻² |
| Effluent Treatment Facility replacement 2 | 2086 | 2086 | WTP_AS | 7.88×10 ⁻² | 2.23×10 ⁻² | 4.73×10 ⁻⁴ | 1.64×10 ⁻² | a | 2.00×10 ⁻¹ | 5.81×10 ⁻² |
| Effluent Treatment Facility replacement 3 | 2116 | 2116 | WTP_AS | 7.88×10 ⁻² | 2.23×10 ⁻² | 4.73×10 ⁻⁴ | 1.64×10 ⁻² | a | 2.00×10 ⁻¹ | 5.81×10 ⁻² |
| Effluent Treatment Facility replacement 4 | 2146 | 2146 | WTP_AS | 7.88×10 ⁻² | 2.23×10 ⁻² | 4.73×10 ⁻⁴ | 1.64×10 ⁻² | a | 2.00×10 ⁻¹ | 5.81×10 ⁻² |
| Effluent Treatment Facility replacement 5 | 2167 | 2167 | WTP_AS | 7.88×10 ⁻² | 2.23×10 ⁻² | 4.73×10 ⁻⁴ | 1.64×10 ⁻² | a | 2.00×10 ⁻¹ | 5.81×10 ⁻² |
| Evaporator original | 2018 | 2018 | 200E | 1.21×10 ⁻² | 1.63×10 ⁻³ | 6.82×10 ⁻⁵ | 2.06×10 ⁻³ | a | 7.14×10 ⁻⁴ | 4.97×10 ⁻⁴ |
| Evaporator replacement 1 | 2043 | 2043 | 200E | 1.21×10 ⁻² | 1.63×10 ⁻³ | 6.82×10 ⁻⁵ | 2.06×10 ⁻³ | a | 7.14×10 ⁻⁴ | 4.97×10 ⁻⁴ |
| Evaporator replacement 2 | 2068 | 2068 | 200E | 1.21×10 ⁻² | 1.63×10 ⁻³ | 6.82×10 ⁻⁵ | 2.06×10 ⁻³ | a | 7.14×10 ⁻⁴ | 4.97×10 ⁻⁴ |
| Evaporator replacement 3 | 2093 | 2093 | 200E | 1.21×10 ⁻² | 1.63×10 ⁻³ | 6.82×10 ⁻⁵ | 2.06×10 ⁻³ | a | 7.14×10 ⁻⁴ | 4.97×10 ⁻⁴ |
| Evaporator replacement 4 | 2118 | 2118 | 200E | 1.21×10 ⁻² | 1.63×10 ⁻³ | 6.82×10 ⁻⁵ | 2.06×10 ⁻³ | a | 7.14×10 ⁻⁴ | 4.97×10 ⁻⁴ |
| Evaporator replacement 5 | 2143 | 2143 | 200E | 1.21×10 ⁻² | 1.63×10 ⁻³ | 6.82×10 ⁻⁵ | 2.06×10 ⁻³ | a | 7.14×10 ⁻⁴ | 4.97×10 ⁻⁴ |
| Evaporator replacement 6 | 2168 | 2168 | 200E | 1.21×10 ⁻² | 1.63×10 ⁻³ | 6.82×10 ⁻⁵ | 2.06×10 ⁻³ | a | 7.14×10 ⁻⁴ | 4.97×10 ⁻⁴ |

Table G-26. Tank Closure Alternative 6A, Base Case, Toxic Pollutant Emissions (continued)

| Facility/System | Start Year | End Year | Location | Emission Rate (metric tons per year) | | | | | | |
|---|------------|----------|----------|--------------------------------------|-----------------------|-----------------------|-----------------------|---------|-----------------------|-----------------------|
| | | | | Ammonia | Benzene | 1,3-Butadiene | Formaldehyde | Mercury | Toluene | Xylene |
| Closure | | | | | | | | | | |
| Containment structure construction 1 | 2038 | 2041 | 200EW | a | a | a | a | a | a | a |
| Containment structure construction 2 | 2061 | 2064 | 200EW | a | a | a | a | a | a | a |
| Containment structure construction 3 | 2084 | 2087 | 200EW | a | a | a | a | a | a | a |
| Containment structure construction 4 | 2107 | 2110 | 200EW | a | a | a | a | a | a | a |
| Containment structure construction 5 | 2122 | 2125 | 200EW | a | a | a | a | a | a | a |
| Containment structure construction 6 | 2138 | 2141 | 200EW | a | a | a | a | a | a | a |
| Containment structure deactivation 1 | 2062 | 2064 | 200EW | a | a | a | a | a | a | a |
| Containment structure deactivation 2 | 2085 | 2087 | 200EW | a | a | a | a | a | a | a |
| Containment structure deactivation 3 | 2108 | 2110 | 200EW | a | a | a | a | a | a | a |
| Containment structure deactivation 4 | 2123 | 2125 | 200EW | a | a | a | a | a | a | a |
| Containment structure deactivation 5 | 2146 | 2148 | 200EW | a | a | a | a | a | a | a |
| Containment structure deactivation 6 | 2138 | 2140 | 200EW | a | a | a | a | a | a | a |
| Containment structure deactivation 7 | 2162 | 2164 | 200EW | a | a | a | a | a | a | a |
| Decontamination and decommissioning of 10 selected facilities | 2018 | 2028 | 200EW | a | a | a | a | a | a | a |
| Modified Resource Conservation and Recovery Act Subtitle C barrier construction | 2149 | 2150 | 200EW | 2.53 | 5.04×10 ⁻¹ | 1.46×10 ⁻² | 4.72×10 ⁻¹ | a | 2.88 | 8.74×10 ⁻¹ |
| Postclosure care | 2151 | 2250 | 200EW | a | a | a | a | a | a | a |
| B tank farm removal | 2065 | 2076 | 200EW | 1.30×10 ⁻¹ | 1.76×10 ⁻² | 7.34×10 ⁻⁴ | 2.22×10 ⁻² | a | 8.77×10 ⁻³ | 5.65×10 ⁻³ |
| T tank farm removal | 2126 | 2137 | 200EW | 1.30×10 ⁻¹ | 1.76×10 ⁻² | 7.34×10 ⁻⁴ | 2.22×10 ⁻² | a | 8.77×10 ⁻³ | 5.65×10 ⁻³ |
| BY tank farm removal | 2111 | 2122 | 200EW | 9.76×10 ⁻² | 1.32×10 ⁻² | 5.50×10 ⁻⁴ | 1.66×10 ⁻² | a | 6.58×10 ⁻³ | 4.24×10 ⁻³ |
| BX tank farm removal | 2042 | 2053 | 200EW | 9.76×10 ⁻² | 1.32×10 ⁻² | 5.50×10 ⁻⁴ | 1.66×10 ⁻² | a | 6.58×10 ⁻³ | 4.24×10 ⁻³ |
| C tank farm removal | 2088 | 2099 | 200EW | 1.30×10 ⁻¹ | 1.76×10 ⁻² | 7.34×10 ⁻⁴ | 2.22×10 ⁻² | a | 8.77×10 ⁻³ | 5.65×10 ⁻³ |
| A tank farm removal | 2142 | 2153 | 200EW | 4.88×10 ⁻² | 6.59×10 ⁻³ | 2.75×10 ⁻⁴ | 8.31×10 ⁻³ | a | 3.29×10 ⁻³ | 2.12×10 ⁻³ |
| AX tank farm removal | 2142 | 2153 | 200EW | 1.30×10 ⁻¹ | 1.76×10 ⁻² | 7.34×10 ⁻⁴ | 2.22×10 ⁻² | a | 8.77×10 ⁻³ | 5.65×10 ⁻³ |
| S tank farm removal | 2126 | 2137 | 200EW | 9.76×10 ⁻² | 1.32×10 ⁻² | 5.50×10 ⁻⁴ | 1.66×10 ⁻² | a | 6.58×10 ⁻³ | 4.24×10 ⁻³ |
| TY tank farm removal | 2111 | 2122 | 200EW | 4.88×10 ⁻² | 6.59×10 ⁻³ | 2.75×10 ⁻⁴ | 8.31×10 ⁻³ | a | 3.29×10 ⁻³ | 2.12×10 ⁻³ |
| TX tank farm removal | 2088 | 2099 | 200NEW | 1.46×10 ⁻¹ | 1.98×10 ⁻² | 8.25×10 ⁻⁴ | 2.49×10 ⁻² | a | 9.86×10 ⁻³ | 6.36×10 ⁻³ |
| U tank farm removal | 2065 | 2076 | 200EW | 1.30×10 ⁻¹ | 1.76×10 ⁻² | 7.34×10 ⁻⁴ | 2.22×10 ⁻² | a | 8.77×10 ⁻³ | 5.65×10 ⁻³ |
| SX tank farm removal | 2042 | 2053 | 200EW | 1.22×10 ⁻¹ | 1.65×10 ⁻² | 6.88×10 ⁻⁴ | 2.08×10 ⁻² | a | 8.22×10 ⁻³ | 5.30×10 ⁻³ |
| B tank farm deep soil removal | 2077 | 2084 | 200E | 2.80×10 ⁻² | 3.77×10 ⁻³ | 1.58×10 ⁻⁴ | 4.77×10 ⁻³ | a | 1.65×10 ⁻³ | 1.15×10 ⁻³ |
| T tank farm deep soil removal | 2138 | 2145 | 200W | 2.15×10 ⁻¹ | 2.90×10 ⁻² | 1.21×10 ⁻³ | 3.67×10 ⁻² | a | 1.27×10 ⁻² | 8.85×10 ⁻³ |

Table G-26. Tank Closure Alternative 6A, Base Case, Toxic Pollutant Emissions (continued)

| Facility/System | Start Year | End Year | Location | Emission Rate (metric tons per year) | | | | | | |
|-------------------------------------|------------|----------|----------|--------------------------------------|-----------------------|------------------------|-----------------------|-----------------------|-----------------------|-----------------------|
| | | | | Ammonia | Benzene | 1,3-Butadiene | Formaldehyde | Mercury | Toluene | Xylene |
| Closure (continued) | | | | | | | | | | |
| BX tank farm deep soil removal | 2054 | 2061 | 200E | 8.97×10^{-1} | 1.21×10^{-1} | 5.06×10^{-3} | 1.53×10^{-1} | a | 5.29×10^{-2} | 3.69×10^{-2} |
| C tank farm deep soil removal | 2100 | 2107 | 200EW | 1.70×10^{-3} | 2.29×10^{-4} | 9.58×10^{-6} | 2.89×10^{-4} | a | 1.00×10^{-4} | 6.99×10^{-5} |
| A tank farm deep soil removal | 2154 | 2161 | 200E | 5.10×10^{-3} | 6.86×10^{-4} | 2.88×10^{-5} | 8.68×10^{-4} | a | 3.01×10^{-4} | 2.10×10^{-4} |
| AX tank farm deep soil removal | 2154 | 2161 | 200E | 8.50×10^{-2} | 1.14×10^{-2} | 4.79×10^{-4} | 1.45×10^{-2} | a | 5.01×10^{-3} | 3.49×10^{-3} |
| TX tank farm deep soil removal | 2100 | 2107 | 200EW | 2.68×10^{-1} | 3.60×10^{-2} | 1.51×10^{-3} | 4.56×10^{-2} | a | 1.58×10^{-2} | 1.10×10^{-2} |
| U tank farm deep soil removal | 2077 | 2084 | 200EW | 1.40×10^{-1} | 1.89×10^{-2} | 7.91×10^{-4} | 2.39×10^{-2} | a | 8.27×10^{-3} | 5.76×10^{-3} |
| SX tank farm deep soil removal | 2054 | 2061 | 200W | 3.42×10^{-1} | 4.61×10^{-2} | 1.93×10^{-3} | 5.83×10^{-2} | a | 2.02×10^{-2} | 1.41×10^{-2} |
| Preprocessing Facility construction | 2039 | 2041 | 200E | 9.20×10^{-1} | 2.03×10^{-1} | 5.38×10^{-3} | 1.77×10^{-1} | a | 1.37 | 4.10×10^{-1} |
| Preprocessing Facility operations | 2042 | 2162 | 200E | 1.60×10^{-4} | 9.12×10^{-6} | 5.60×10^{-10} | 3.20×10^{-8} | 1.69×10^{-5} | 1.38×10^{-6} | 3.90×10^{-6} |
| Preprocessing Facility deactivation | 2163 | 2163 | 200E | 2.51×10^{-5} | 1.43×10^{-6} | 8.80×10^{-11} | 5.03×10^{-9} | a | 2.17×10^{-7} | 6.13×10^{-7} |

^a Emissions for this activity and pollutant were not calculated because annual fuel use for this activity and the resulting emissions would be small compared with those of other activities or would be zero.

Key: 200E=200-East Area; 200W=200-West Area; 200EW=200-East and 200-West Areas; 200EW+=200-East and 200-West Areas and Waste Treatment Plant area; HLW=high-level radioactive waste; IHLW=immobilized high-level radioactive waste; WTP_AS=Waste Treatment Plant area source; WTP_PS=Waste Treatment Plant point source.

Source: SAIC 2007a, 2008.

Table G-27. Tank Closure Alternative 6A, Option Case, Criteria Pollutant Emissions

| Facility/System | Start Year | End Year | Location | Emission Rate (metric tons per year) | | | | |
|--|------------|----------|----------|--------------------------------------|-----------------------|-----------------------|-----------------------|-----------------------|
| | | | | Carbon Monoxide | Nitrogen Dioxide | PM ₁₀ | Sulfur Dioxide | VOCs |
| Construction | | | | | | | | |
| Canister Storage Building | 2006 | 2016 | 200E | 5.54 | 1.28 | 9.05×10 ⁻¹ | 4.02×10 ⁻⁴ | 2.86×10 ⁻¹ |
| IHLW Shipping/Transfer Facility | 2011 | 2013 | 200E | 5.68×10 ¹ | 6.72×10 ¹ | 9.81×10 ¹ | 2.18×10 ⁻² | 6.50 |
| IHLW Interim Storage Modules | 2014 | 2157 | 200E | 5.33×10 ¹ | 6.35×10 ¹ | 2.10×10 ² | 1.94×10 ⁻² | 5.78 |
| Other infrastructure upgrades | 2006 | 2034 | 200EW | 1.11 | 8.05×10 ⁻¹ | 1.13 | 2.54×10 ⁻⁴ | 9.43×10 ⁻² |
| Tank upgrades | 2006 | 2025 | 200EW | 3.49×10 ² | 4.41×10 ¹ | 8.07 | 1.38×10 ⁻² | 1.56×10 ¹ |
| Waste Treatment Plant original | 2006 | 2017 | WTP_AS | 3.37×10 ² | 2.41×10 ² | 2.86×10 ² | 4.64×10 ⁻¹ | 3.29×10 ¹ |
| Cesium and Strontium Capsule Processing Facility | 2158 | 2161 | WTP_AS | 8.41×10 ² | 1.22×10 ² | 1.80×10 ¹ | 1.13 | 4.78×10 ¹ |
| Tank risers | 2013 | 2016 | 200EW | 2.01×10 ¹ | 8.94 | 8.10×10 ⁻¹ | 1.88×10 ⁻³ | 2.25 |
| Double-shell tank replacement 1 | 2029 | 2034 | 200EW+ | 2.60×10 ² | 2.17×10 ² | 1.35×10 ³ | 6.43×10 ⁻² | 2.20×10 ¹ |
| Double-shell tank replacement 2 | 2069 | 2074 | 200EW+ | 2.60×10 ² | 2.17×10 ² | 1.35×10 ³ | 6.43×10 ⁻² | 2.20×10 ¹ |
| Double-shell tank replacement 3 | 2109 | 2114 | 200EW+ | 2.60×10 ² | 2.17×10 ² | 1.35×10 ³ | 6.43×10 ⁻² | 2.20×10 ¹ |
| Mobile retrieval system | 2013 | 2162 | 200EW | 2.73×10 ¹ | 1.19×10 ¹ | 2.28 | 3.80×10 ⁻³ | 1.81 |
| Vacuum-based retrieval system | 2013 | 2162 | 200EW | 5.79 | 2.62 | 5.26×10 ⁻¹ | 8.34×10 ⁻⁴ | 3.94×10 ⁻¹ |
| Chemical wash system | 2013 | 2162 | 200EW | 5.84×10 ⁻² | 3.12×10 ⁻¹ | 3.89×10 ⁻² | 9.74×10 ⁻⁵ | 1.95×10 ⁻² |
| HLW Melter Interim Storage Facility 1 | 2017 | 2018 | WTP_AS | 6.17×10 ⁻¹ | 1.38 | 1.72×10 ¹ | 2.86×10 ⁻⁴ | 6.73×10 ⁻² |
| HLW Melter Interim Storage Facility 2 | 2037 | 2038 | WTP_AS | 6.17×10 ⁻¹ | 1.38 | 1.72×10 ¹ | 2.86×10 ⁻⁴ | 6.73×10 ⁻² |
| HLW Melter Interim Storage Facility 3 | 2057 | 2058 | WTP_AS | 6.17×10 ⁻¹ | 1.38 | 1.72×10 ¹ | 2.86×10 ⁻⁴ | 6.73×10 ⁻² |
| HLW Melter Interim Storage Facility 4 | 2077 | 2078 | WTP_AS | 6.17×10 ⁻¹ | 1.38 | 1.72×10 ¹ | 2.86×10 ⁻⁴ | 6.73×10 ⁻² |
| HLW Melter Interim Storage Facility 5 | 2097 | 2098 | WTP_AS | 6.17×10 ⁻¹ | 1.38 | 1.72×10 ¹ | 2.86×10 ⁻⁴ | 6.73×10 ⁻² |
| HLW Melter Interim Storage Facility 6 | 2117 | 2118 | WTP_AS | 6.17×10 ⁻¹ | 1.38 | 1.72×10 ¹ | 2.86×10 ⁻⁴ | 6.73×10 ⁻² |
| HLW Melter Interim Storage Facility 7 | 2137 | 2138 | WTP_AS | 6.17×10 ⁻¹ | 1.38 | 1.72×10 ¹ | 2.86×10 ⁻⁴ | 6.73×10 ⁻² |
| Underground transfer line replacement | 2064 | 2064 | 200EW+ | 7.59×10 ¹ | 2.71×10 ¹ | 2.41×10 ¹ | 8.75×10 ⁻³ | 4.47 |
| Waste Treatment Plant replacement 1 | 2067 | 2078 | WTP_AS | 3.30×10 ² | 2.36×10 ² | 2.34×10 ² | 4.54×10 ⁻¹ | 3.22×10 ¹ |
| Waste Treatment Plant replacement 2 | 2127 | 2138 | WTP_AS | 3.30×10 ² | 2.36×10 ² | 2.34×10 ² | 4.54×10 ⁻¹ | 3.22×10 ¹ |
| IHLW Shipping/Transfer Facility 1 | 2076 | 2078 | 200E | 5.68×10 ¹ | 6.72×10 ¹ | 9.81×10 ¹ | 2.18×10 ⁻² | 6.50 |
| IHLW Shipping/Transfer Facility 2 | 2136 | 2138 | 200E | 5.68×10 ¹ | 6.72×10 ¹ | 9.81×10 ¹ | 2.18×10 ⁻² | 6.50 |
| IHLW Shipping/Transfer Facility 3 | 2196 | 2198 | 200E | 5.68×10 ¹ | 6.72×10 ¹ | 9.81×10 ¹ | 2.18×10 ⁻² | 6.50 |

Table G-27. Tank Closure Alternative 6A, Option Case, Criteria Pollutant Emissions (continued)

| Facility/System | Start Year | End Year | Location | Emission Rate (metric tons per year) | | | | |
|--|------------|----------|----------|--------------------------------------|-----------------------|-----------------------|-----------------------|-----------------------|
| | | | | Carbon Monoxide | Nitrogen Dioxide | PM ₁₀ | Sulfur Dioxide | VOCs |
| Construction (continued) | | | | | | | | |
| IHLW Interim Storage Module, additional | 2078 | 2197 | 200E | 1.45×10 ² | 1.73×10 ² | 5.72×10 ² | 5.27×10 ⁻² | 1.57×10 ¹ |
| HLW Debris Storage Facility | 2041 | 2110 | 200EW | 3.37×10 ⁻¹ | 1.56 | 1.10×10 ⁻¹ | 5.31×10 ⁻⁴ | 1.28×10 ⁻¹ |
| Effluent Treatment Facility replacement 1 | 2023 | 2025 | 200E | 1.45×10 ³ | 2.09×10 ² | 9.48×10 ² | 1.96 | 8.25×10 ¹ |
| Effluent Treatment Facility replacement 2 | 2053 | 2055 | 200E | 1.45×10 ³ | 2.09×10 ² | 9.48×10 ² | 1.96 | 8.25×10 ¹ |
| Effluent Treatment Facility replacement 3 | 2083 | 2085 | 200E | 1.45×10 ³ | 2.09×10 ² | 9.48×10 ² | 1.96 | 8.25×10 ¹ |
| Effluent Treatment Facility replacement 4 | 2113 | 2115 | 200E | 1.45×10 ³ | 2.09×10 ² | 9.48×10 ² | 1.96 | 8.25×10 ¹ |
| Effluent Treatment Facility replacement 5 | 2143 | 2145 | 200E | 1.45×10 ³ | 2.09×10 ² | 9.48×10 ² | 1.96 | 8.25×10 ¹ |
| Evaporator replacement 1 | 2015 | 2017 | 200E | 4.51×10 ² | 6.53×10 ¹ | 1.76×10 ¹ | 6.07×10 ⁻¹ | 2.56×10 ¹ |
| Evaporator replacement 2 | 2040 | 2042 | 200E | 4.51×10 ² | 6.53×10 ¹ | 1.76×10 ¹ | 6.07×10 ⁻¹ | 2.56×10 ¹ |
| Evaporator replacement 3 | 2065 | 2067 | 200E | 4.51×10 ² | 6.53×10 ¹ | 1.76×10 ¹ | 6.07×10 ⁻¹ | 2.56×10 ¹ |
| Evaporator replacement 4 | 2090 | 2092 | 200E | 4.51×10 ² | 6.53×10 ¹ | 1.76×10 ¹ | 6.07×10 ⁻¹ | 2.56×10 ¹ |
| Evaporator replacement 5 | 2115 | 2117 | 200E | 4.51×10 ² | 6.53×10 ¹ | 1.76×10 ¹ | 6.07×10 ⁻¹ | 2.56×10 ¹ |
| Evaporator replacement 6 | 2140 | 2142 | 200E | 4.51×10 ² | 6.53×10 ¹ | 1.76×10 ¹ | 6.07×10 ⁻¹ | 2.56×10 ¹ |
| Underground transfer line 1,000-foot sections | 2009 | 2009 | 200EW+ | 7.59×10 ¹ | 2.71×10 ¹ | 2.41×10 ¹ | 8.75×10 ⁻³ | 4.47 |
| Operations | | | | | | | | |
| IHLW Interim Storage Facility | 2018 | 2262 | 200E | a | a | a | a | a |
| Other infrastructure upgrades | 2006 | 2162 | 200EW | a | a | a | a | a |
| Routine operations | 2006 | 2162 | 200EW | 1.36×10 ¹ | 1.55×10 ¹ | a | a | 5.40 |
| Retrieval operations | 2006 | 2162 | 200EW | 4.72×10 ⁻² | 5.35×10 ⁻² | a | a | 1.89×10 ⁻² |
| Double-shell tank interim stabilization | 2006 | 2162 | 200EW | 3.09×10 ⁻¹ | 3.51×10 ⁻¹ | a | a | 1.24×10 ⁻¹ |
| Waste Treatment Plant | 2018 | 2162 | WTP_PS | 2.71×10 ² | 5.32×10 ² | 2.08 | 1.07×10 ¹ | 9.91×10 ² |
| Waste Treatment Plant, cesium and strontium capsules | 2163 | 2163 | WTP_PS | 2.71×10 ² | 5.32×10 ² | 2.08 | 1.07×10 ¹ | 9.91×10 ² |
| Cesium and Strontium Capsule Processing Facility | 2162 | 2163 | WTP_AS | 4.85×10 ¹ | 1.29 | 5.53×10 ¹ | 6.49×10 ⁻² | 2.34 |
| Mobile retrieval system | 2013 | 2162 | 200EW | 1.26×10 ⁻¹ | 1.42×10 ⁻¹ | a | a | 5.02×10 ⁻² |
| Vacuum-based retrieval system | 2013 | 2162 | 200EW | 3.95×10 ⁻² | 4.47×10 ⁻² | a | a | 1.58×10 ⁻² |
| Chemical wash system | 2013 | 2162 | 200EW | 3.89×10 ⁻² | 1.36×10 ⁻¹ | 4.09×10 ⁻¹ | 3.87×10 ⁻⁵ | a |
| HLW Melter Interim Storage Facility | 2018 | 2262 | WTP_AS | a | a | a | a | a |

Table G-27. Tank Closure Alternative 6A, Option Case, Criteria Pollutant Emissions (continued)

| Facility/System | Start Year | End Year | Location | Emission Rate (metric tons per year) | | | | |
|--|------------|----------|----------|--------------------------------------|-----------------------|-----------------------|-----------------------|-----------------------|
| | | | | Carbon Monoxide | Nitrogen Dioxide | PM ₁₀ | Sulfur Dioxide | VOCs |
| Operations (continued) | | | | | | | | |
| HLW Debris Storage Facility | 2042 | 2262 | 200EW | a | a | a | a | a |
| Effluent Treatment Facility | 2006 | 2166 | WTP_PS | 9.84 | 2.67 | 9.34×10 ² | 1.33×10 ⁻² | 6.48×10 ⁻¹ |
| Evaporator | 2018 | 2163 | 200E | 1.23×10 ¹ | 5.70×10 ¹ | 1.71×10 ¹ | 1.94×10 ⁻² | 4.66 |
| Borrow Area C | 2006 | 2167 | Area C | 8.52×10 ¹ | 1.12×10 ² | 2.30×10 ² | 1.20×10 ⁻¹ | 1.20×10 ¹ |
| Deactivation | | | | | | | | |
| Mobile retrieval system | 2013 | 2162 | 200EW | 1.36×10 ¹ | 1.07 | 8.89×10 ⁻² | 3.27×10 ⁻⁴ | 5.63×10 ⁻¹ |
| Vacuum-based retrieval system | 2013 | 2162 | 200EW | 1.26×10 ⁻¹ | 9.89×10 ⁻³ | 8.99×10 ⁻⁴ | 3.02×10 ⁻⁶ | 5.15×10 ⁻³ |
| Chemical wash system | 2013 | 2162 | 200EW | 5.39×10 ⁻¹ | 9.51×10 ⁻² | 8.02×10 ⁻³ | 3.03×10 ⁻⁵ | 2.56×10 ⁻² |
| IHLW Interim Storage Facility | 2078 | 2197 | WTP_AS | a | a | a | a | a |
| Waste Treatment Plant original | 2079 | 2081 | WTP_AS | 1.51×10 ¹ | 2.97×10 ¹ | 1.16×10 ⁻¹ | 5.95×10 ⁻¹ | 5.54×10 ¹ |
| Waste Treatment Plant replacement 1 | 2139 | 2141 | WTP_AS | 1.51×10 ¹ | 2.97×10 ¹ | 1.16×10 ⁻¹ | 5.95×10 ⁻¹ | 5.54×10 ¹ |
| Waste Treatment Plant replacement 2 | 2164 | 2166 | WTP_AS | 1.51×10 ¹ | 2.97×10 ¹ | 1.16×10 ⁻¹ | 5.95×10 ⁻¹ | 5.54×10 ¹ |
| Cesium and Strontium Capsule Processing Facility | 2164 | 2164 | WTP_AS | 2.24×10 ¹ | 5.96×10 ⁻¹ | 2.55×10 ¹ | 3.00×10 ⁻² | 1.08 |
| Effluent Treatment Facility original | 2026 | 2026 | WTP_AS | 1.09×10 ² | 4.78×10 ¹ | 4.70×10 ² | 1.48×10 ⁻¹ | 8.47 |
| Effluent Treatment Facility replacement 1 | 2056 | 2056 | WTP_AS | 1.09×10 ² | 4.78×10 ¹ | 4.70×10 ² | 1.48×10 ⁻¹ | 8.47 |
| Effluent Treatment Facility replacement 2 | 2086 | 2086 | WTP_AS | 1.09×10 ² | 4.78×10 ¹ | 4.70×10 ² | 1.48×10 ⁻¹ | 8.47 |
| Effluent Treatment Facility replacement 3 | 2116 | 2116 | WTP_AS | 1.09×10 ² | 4.78×10 ¹ | 4.70×10 ² | 1.48×10 ⁻¹ | 8.47 |
| Effluent Treatment Facility replacement 4 | 2146 | 2146 | WTP_AS | 1.09×10 ² | 4.78×10 ¹ | 4.70×10 ² | 1.48×10 ⁻¹ | 8.47 |
| Effluent Treatment Facility replacement 5 | 2167 | 2167 | WTP_AS | 1.09×10 ² | 4.78×10 ¹ | 4.70×10 ² | 1.48×10 ⁻¹ | 8.47 |
| Evaporator original | 2018 | 2018 | 200E | 1.66 | 7.70 | 7.07 | 2.62×10 ⁻³ | 6.28×10 ⁻¹ |
| Evaporator replacement 1 | 2043 | 2043 | 200E | 1.66 | 7.70 | 7.07 | 2.62×10 ⁻³ | 6.28×10 ⁻¹ |
| Evaporator replacement 2 | 2068 | 2068 | 200E | 1.66 | 7.70 | 7.07 | 2.62×10 ⁻³ | 6.28×10 ⁻¹ |
| Evaporator replacement 3 | 2093 | 2093 | 200E | 1.66 | 7.70 | 7.07 | 2.62×10 ⁻³ | 6.28×10 ⁻¹ |
| Evaporator replacement 4 | 2118 | 2118 | 200E | 1.66 | 7.70 | 7.07 | 2.62×10 ⁻³ | 6.28×10 ⁻¹ |
| Evaporator replacement 5 | 2143 | 2143 | 200E | 1.66 | 7.70 | 7.07 | 2.62×10 ⁻³ | 6.28×10 ⁻¹ |
| Evaporator replacement 6 | 2168 | 2168 | 200E | 1.66 | 7.70 | 7.07 | 2.62×10 ⁻³ | 6.28×10 ⁻¹ |
| Closure | | | | | | | | |
| Containment structure construction 1 | 2038 | 2041 | 200EW | 6.78×10 ¹ | 7.06 | 2.74 | 2.19×10 ⁻³ | 2.91 |
| Containment structure construction 2 | 2061 | 2064 | 200EW | 6.78×10 ¹ | 7.06 | 2.74 | 2.19×10 ⁻³ | 2.91 |
| Containment structure construction 3 | 2084 | 2087 | 200EW | 6.78×10 ¹ | 7.06 | 2.74 | 2.19×10 ⁻³ | 2.91 |
| Containment structure construction 4 | 2107 | 2110 | 200EW | 6.78×10 ¹ | 7.06 | 2.74 | 2.19×10 ⁻³ | 2.91 |
| Containment structure construction 5 | 2122 | 2125 | 200EW | 6.78×10 ¹ | 7.06 | 2.74 | 2.19×10 ⁻³ | 2.91 |

Table G-27. Tank Closure Alternative 6A, Option Case, Criteria Pollutant Emissions (continued)

| Facility/System | Start Year | End Year | Location | Emission Rate (metric tons per year) | | | | |
|---|------------|----------|----------|--------------------------------------|----------------------|-----------------------|-----------------------|-----------------------|
| | | | | Carbon Monoxide | Nitrogen Dioxide | PM ₁₀ | Sulfur Dioxide | VOCs |
| Closure (continued) | | | | | | | | |
| Containment structure construction 6 | 2138 | 2141 | 200EW | 6.78×10 ¹ | 7.06 | 2.74 | 2.19×10 ⁻³ | 2.91 |
| Containment structure deactivation 1 | 2062 | 2064 | 200EW | 9.03×10 ¹ | 9.39 | 3.09 | 2.92×10 ⁻³ | 3.88 |
| Containment structure deactivation 2 | 2085 | 2087 | 200EW | 9.03×10 ¹ | 9.39 | 3.09 | 2.92×10 ⁻³ | 3.88 |
| Containment structure deactivation 3 | 2108 | 2110 | 200EW | 9.03×10 ¹ | 9.39 | 3.09 | 2.92×10 ⁻³ | 3.88 |
| Containment structure deactivation 4 | 2123 | 2125 | 200EW | 9.03×10 ¹ | 9.39 | 3.09 | 2.92×10 ⁻³ | 3.88 |
| Containment structure deactivation 5 | 2146 | 2148 | 200EW | 4.52×10 ¹ | 4.70 | 1.55 | 1.46×10 ⁻³ | 1.94 |
| Containment structure deactivation 6 | 2138 | 2140 | 200EW | 4.52×10 ¹ | 4.70 | 1.55 | 1.46×10 ⁻³ | 1.94 |
| Containment structure deactivation 7 | 2162 | 2164 | 200EW | 9.03×10 ¹ | 9.39 | 3.09 | 2.92×10 ⁻³ | 3.88 |
| Decontamination and decommissioning of 10 selected facilities | 2018 | 2028 | 200EW | 2.53 | 9.81 | 8.56 | 3.22×10 ⁻³ | 7.93×10 ⁻¹ |
| B tank farm removal | 2065 | 2076 | 200EW | 1.84×10 ¹ | 8.27×10 ¹ | 1.07×10 ¹ | 2.89×10 ⁻² | 6.78 |
| T tank farm removal | 2126 | 2137 | 200EW | 1.84×10 ¹ | 8.27×10 ¹ | 1.07×10 ¹ | 2.89×10 ⁻² | 6.78 |
| BY tank farm removal | 2111 | 2122 | 200EW | 1.38×10 ¹ | 6.20×10 ¹ | 8.04 | 2.17×10 ⁻² | 5.08 |
| BX tank farm removal | 2042 | 2053 | 200EW | 1.38×10 ¹ | 6.20×10 ¹ | 8.04 | 2.17×10 ⁻² | 5.08 |
| C tank farm removal | 2088 | 2099 | 200EW | 1.84×10 ¹ | 8.27×10 ¹ | 1.07×10 ¹ | 2.89×10 ⁻² | 6.78 |
| A tank farm removal | 2142 | 2153 | 200EW | 6.89 | 3.10×10 ¹ | 4.02 | 1.08×10 ⁻² | 2.54 |
| AX tank farm removal | 2142 | 2153 | 200EW | 1.84×10 ¹ | 8.27×10 ¹ | 1.07×10 ¹ | 2.89×10 ⁻² | 6.78 |
| S tank farm removal | 2126 | 2137 | 200EW | 1.38×10 ¹ | 6.20×10 ¹ | 8.04 | 2.17×10 ⁻² | 5.08 |
| TY tank farm removal | 2111 | 2122 | 200EW | 6.89 | 3.10×10 ¹ | 4.02 | 1.08×10 ⁻² | 2.54 |
| TX tank farm removal | 2088 | 2099 | 200EW | 2.07×10 ¹ | 9.31×10 ¹ | 1.21×10 ¹ | 3.25×10 ⁻² | 7.63 |
| U tank farm removal | 2065 | 2076 | 200EW | 1.84×10 ¹ | 8.27×10 ¹ | 1.07×10 ¹ | 2.89×10 ⁻² | 6.78 |
| SX tank farm removal | 2042 | 2053 | 200EW | 1.72×10 ¹ | 7.75×10 ¹ | 1.01×10 ¹ | 2.71×10 ⁻² | 6.35 |
| B tank farm deep soil removal | 2077 | 2084 | 200E | 3.84 | 1.78×10 ¹ | 1.89 | 6.06×10 ⁻³ | 1.46 |
| T tank farm deep soil removal | 2138 | 2145 | 200W | 2.95×10 ¹ | 1.37×10 ² | 1.45×10 ¹ | 4.66×10 ⁻² | 1.12×10 ¹ |
| BX tank farm deep soil removal | 2054 | 2061 | 200E | 1.23×10 ² | 5.71×10 ² | 6.04×10 ¹ | 1.94×10 ⁻¹ | 4.66×10 ¹ |
| C tank farm deep soil removal | 2100 | 2107 | 200E | 2.33×10 ⁻¹ | 1.08 | 1.15×10 ⁻¹ | 3.68×10 ⁻⁴ | 8.82×10 ⁻² |
| A tank farm deep soil removal | 2154 | 2161 | 200E | 6.99×10 ⁻¹ | 3.24 | 3.43×10 ⁻¹ | 1.10×10 ⁻³ | 2.65×10 ⁻¹ |
| AX tank farm deep soil removal | 2154 | 2161 | 200E | 1.16×10 ¹ | 5.41×10 ¹ | 5.72 | 1.84×10 ⁻² | 4.41 |
| TX tank farm deep soil removal | 2100 | 2107 | 200EW | 3.67×10 ¹ | 1.70×10 ² | 1.80×10 ¹ | 5.79×10 ⁻² | 1.39×10 ¹ |
| U tank farm deep soil removal | 2077 | 2084 | 200EW | 1.92×10 ¹ | 8.92×10 ¹ | 9.44 | 3.03×10 ⁻² | 7.28 |
| SX tank farm deep soil removal | 2054 | 2061 | 200E | 4.69×10 ¹ | 2.18×10 ² | 2.31×10 ¹ | 7.40×10 ⁻² | 1.78×10 ¹ |
| B Area cribs and trenches (ditches) removal | 2054 | 2084 | 200EW | 5.41×10 ¹ | 2.51×10 ² | 2.66×10 ¹ | 8.54×10 ⁻² | 2.05×10 ¹ |

Table G-27. Tank Closure Alternative 6A, Option Case, Criteria Pollutant Emissions (continued)

| Facility/System | Start Year | End Year | Location | Emission Rate (metric tons per year) | | | | |
|--|------------|----------|----------|--------------------------------------|-----------------------|-----------------------|-----------------------|-----------------------|
| | | | | Carbon Monoxide | Nitrogen Dioxide | PM ₁₀ | Sulfur Dioxide | VOCs |
| Closure (continued) | | | | | | | | |
| T Area cribs and trenches (ditches) removal | 2100 | 2145 | 200EW | 3.64×10 ¹ | 1.69×10 ² | 1.79×10 ¹ | 5.76×10 ⁻² | 1.38×10 ¹ |
| B and T Area cribs and trenches (ditches) construction 1 | 2050 | 2053 | 200EW | 6.78×10 ¹ | 7.06 | 2.74 | 2.19×10 ⁻³ | 2.91 |
| B and T Area cribs and trenches (ditches) construction 2 | 2096 | 2099 | 200EW | 6.78×10 ¹ | 7.06 | 2.74 | 2.19×10 ⁻³ | 2.91 |
| B and T Area cribs and trenches (ditches) deactivation 1 | 2085 | 2087 | 200EW | 9.03×10 ¹ | 9.39 | 3.09 | 2.92×10 ⁻³ | 3.88 |
| B and T Area cribs and trenches (ditches) deactivation 2 | 2146 | 2148 | 200EW | 9.03×10 ¹ | 9.39 | 3.09 | 2.92×10 ⁻³ | 3.88 |
| Preprocessing Facility construction | 2039 | 2041 | 200E | 1.58×10 ³ | 1.14×10 ³ | 3.41×10 ² | 2.18 | 1.55×10 ² |
| Preprocessing Facility operations | 2042 | 2162 | 200E | 1.32 | 3.53 | 3.17×10 ⁻¹ | 7.98×10 ⁻¹ | 1.20 |
| Preprocessing Facility deactivation | 2163 | 2163 | 200E | 2.07×10 ⁻¹ | 5.55×10 ⁻¹ | 4.99×10 ⁻² | 1.25×10 ⁻¹ | 1.89×10 ⁻¹ |

^a Emissions for this activity and pollutant were not calculated because annual fuel use for this activity and the resulting emissions would be small compared with those of other activities or would be zero.

Key: 200E=200-East Area; 200W=200-West Area; 200EW=200-East and 200-West Areas; 200EW+=200-East and 200-West Areas and Waste Treatment Plant area; HLW=high-level radioactive waste; IHLW=immobilized high-level radioactive waste; PM₁₀=particulate matter with an aerodynamic diameter less than or equal to 10 micrometers; VOC=volatile organic compound; WTP_AS=Waste Treatment Plant area source; WTP_PS=Waste Treatment Plant point source.

Source: SAIC 2007a, 2008.

Table G–28. Tank Closure Alternative 6A, Option Case, Toxic Pollutant Emissions

| Facility/System | Start Year | End Year | Location | Emission Rate (metric tons per year) | | | | | | |
|--|------------|----------|----------|--------------------------------------|-----------------------|-----------------------|-----------------------|---------|-----------------------|-----------------------|
| | | | | Ammonia | Benzene | 1,3-Butadiene | Formaldehyde | Mercury | Toluene | Xylene |
| Construction | | | | | | | | | | |
| Canister Storage Building | 2006 | 2016 | 200E | a | a | a | a | a | a | a |
| IHLW Shipping/Transfer Facility | 2011 | 2013 | 200E | a | a | a | a | a | a | a |
| IHLW Interim Storage Modules | 2014 | 2157 | 200E | a | a | a | a | a | a | a |
| Other infrastructure upgrades | 2006 | 2034 | 200EW | a | a | a | a | a | a | a |
| Tank upgrades | 2006 | 2025 | 200EW | 7.82×10 ⁻² | a | a | a | a | a | a |
| Waste Treatment Plant original | 2006 | 2017 | WTP_AS | 3.89×10 ⁻¹ | 8.63×10 ⁻² | 2.28×10 ⁻³ | 7.49×10 ⁻² | a | 5.89×10 ⁻¹ | 1.75×10 ⁻¹ |
| Cesium and Strontium Capsule Processing Facility | 2158 | 2161 | WTP_AS | 2.22×10 ⁻¹ | 1.27×10 ⁻¹ | 1.49×10 ⁻³ | 6.26×10 ⁻² | a | 1.63 | 4.64×10 ⁻¹ |
| Tank risers | 2013 | 2016 | 200EW | 2.38 | a | a | a | a | a | a |
| Double-shell tank replacement 1 | 2029 | 2034 | 200EW+ | a | a | a | a | a | a | a |
| Double-shell tank replacement 2 | 2069 | 2074 | 200EW+ | a | a | a | a | a | a | a |
| Double-shell tank replacement 3 | 2109 | 2114 | 200EW+ | a | a | a | a | a | a | a |
| Mobile retrieval system | 2013 | 2162 | 200EW | 1.09×10 ⁻¹ | a | a | a | a | a | a |
| Vacuum-based retrieval system | 2013 | 2162 | 200EW | 3.42×10 ⁻² | a | a | a | a | a | a |
| Chemical wash system | 2013 | 2162 | 200EW | 1.43×10 ⁻³ | a | a | a | a | a | a |
| HLW Melter Interim Storage Facility 1 | 2017 | 2018 | WTP_AS | a | a | a | a | a | a | a |
| HLW Melter Interim Storage Facility 2 | 2037 | 2038 | WTP_AS | a | a | a | a | a | a | a |
| HLW Melter Interim Storage Facility 3 | 2057 | 2058 | WTP_AS | a | a | a | a | a | a | a |
| HLW Melter Interim Storage Facility 4 | 2077 | 2078 | WTP_AS | a | a | a | a | a | a | a |
| HLW Melter Interim Storage Facility 5 | 2097 | 2098 | WTP_AS | a | a | a | a | a | a | a |
| HLW Melter Interim Storage Facility 6 | 2117 | 2118 | WTP_AS | a | a | a | a | a | a | a |
| HLW Melter Interim Storage Facility 7 | 2137 | 2138 | WTP_AS | a | a | a | a | a | a | a |
| Underground transfer line replacement | 2064 | 2064 | 200EW+ | a | a | a | a | a | a | a |
| Waste Treatment Plant replacement 1 | 2067 | 2078 | WTP_AS | 3.81×10 ⁻¹ | 8.45×10 ⁻² | 2.23×10 ⁻³ | 7.33×10 ⁻² | a | 5.76×10 ⁻¹ | 1.72×10 ⁻¹ |
| Waste Treatment Plant replacement 2 | 2127 | 2138 | WTP_AS | 3.81×10 ⁻¹ | 8.45×10 ⁻² | 2.23×10 ⁻³ | 7.33×10 ⁻² | a | 5.76×10 ⁻¹ | 1.72×10 ⁻¹ |
| IHLW Shipping/Transfer Facility 1 | 2076 | 2078 | 200E | a | a | a | a | a | a | a |
| IHLW Shipping/Transfer Facility 2 | 2136 | 2138 | 200E | a | a | a | a | a | a | a |
| IHLW Shipping/Transfer Facility 3 | 2196 | 2198 | 200E | a | a | a | a | a | a | a |
| IHLW Interim Storage Module, additional | 2078 | 2197 | 200E | a | a | a | a | a | a | a |
| HLW Debris Storage Facility | 2041 | 2110 | 200EW | 2.46×10 ⁻³ | 3.31×10 ⁻⁴ | 1.39×10 ⁻⁵ | 4.18×10 ⁻⁴ | a | 1.45×10 ⁻⁴ | 1.01×10 ⁻⁴ |

Table G–28. Tank Closure Alternative 6A, Option Case, Toxic Pollutant Emissions (continued)

| Facility/System | Start Year | End Year | Location | Emission Rate (metric tons per year) | | | | | | |
|--|------------|----------|----------|--------------------------------------|-----------------------|-----------------------|-----------------------|-----------------------|-----------------------|-----------------------|
| | | | | Ammonia | Benzene | 1,3-Butadiene | Formaldehyde | Mercury | Toluene | Xylene |
| Construction (continued) | | | | | | | | | | |
| Effluent Treatment Facility replacement 1 | 2023 | 2025 | 200E | 3.81×10 ⁻¹ | 2.19×10 ⁻¹ | 2.55×10 ⁻³ | 1.08×10 ⁻¹ | a | 2.82 | 8.02×10 ⁻¹ |
| Effluent Treatment Facility replacement 2 | 2053 | 2055 | 200E | 3.81×10 ⁻¹ | 2.19×10 ⁻¹ | 2.55×10 ⁻³ | 1.08×10 ⁻¹ | a | 2.82 | 8.02×10 ⁻¹ |
| Effluent Treatment Facility replacement 3 | 2083 | 2085 | 200E | 3.81×10 ⁻¹ | 2.19×10 ⁻¹ | 2.55×10 ⁻³ | 1.08×10 ⁻¹ | a | 2.82 | 8.02×10 ⁻¹ |
| Effluent Treatment Facility replacement 4 | 2113 | 2115 | 200E | 3.81×10 ⁻¹ | 2.19×10 ⁻¹ | 2.55×10 ⁻³ | 1.08×10 ⁻¹ | a | 2.82 | 8.02×10 ⁻¹ |
| Effluent Treatment Facility replacement 5 | 2143 | 2145 | 200E | 3.81×10 ⁻¹ | 2.19×10 ⁻¹ | 2.55×10 ⁻³ | 1.08×10 ⁻¹ | a | 2.82 | 8.02×10 ⁻¹ |
| Evaporator replacement 1 | 2015 | 2017 | 200E | 1.19×10 ⁻¹ | 6.80×10 ⁻² | 7.95×10 ⁻⁴ | 3.35×10 ⁻² | a | 8.74×10 ⁻¹ | 2.49×10 ⁻¹ |
| Evaporator replacement 2 | 2040 | 2042 | 200E | 1.19×10 ⁻¹ | 6.80×10 ⁻² | 7.95×10 ⁻⁴ | 3.35×10 ⁻² | a | 8.74×10 ⁻¹ | 2.49×10 ⁻¹ |
| Evaporator replacement 3 | 2065 | 2067 | 200E | 1.19×10 ⁻¹ | 6.80×10 ⁻² | 7.95×10 ⁻⁴ | 3.35×10 ⁻² | a | 8.74×10 ⁻¹ | 2.49×10 ⁻¹ |
| Evaporator replacement 4 | 2090 | 2092 | 200E | 1.19×10 ⁻¹ | 6.80×10 ⁻² | 7.95×10 ⁻⁴ | 3.35×10 ⁻² | a | 8.74×10 ⁻¹ | 2.49×10 ⁻¹ |
| Evaporator replacement 5 | 2115 | 2117 | 200E | 1.19×10 ⁻¹ | 6.80×10 ⁻² | 7.95×10 ⁻⁴ | 3.35×10 ⁻² | a | 8.74×10 ⁻¹ | 2.49×10 ⁻¹ |
| Evaporator replacement 6 | 2140 | 2142 | 200E | 1.19×10 ⁻¹ | 6.80×10 ⁻² | 7.95×10 ⁻⁴ | 3.35×10 ⁻² | a | 8.74×10 ⁻¹ | 2.49×10 ⁻¹ |
| Underground transfer line 1,000-foot sections | 2009 | 2009 | 200EW+ | a | a | a | a | a | a | a |
| Operations | | | | | | | | | | |
| IHLW Interim Storage Facility | 2018 | 2262 | 200E | a | a | a | a | a | a | a |
| Other infrastructure upgrades | 2006 | 2162 | 200EW | a | a | a | a | a | a | a |
| Routine operations | 2006 | 2162 | 200EW | 1.18×10 ¹ | a | a | a | a | a | a |
| Retrieval operations | 2006 | 2162 | 200EW | 4.09×10 ⁻² | a | a | a | a | a | a |
| Double-shell tank interim stabilization | 2006 | 2162 | 200EW | 2.68×10 ⁻¹ | a | a | a | a | a | a |
| Waste Treatment Plant | 2018 | 2162 | WTP_PS | 4.09 | 2.58×10 ⁻² | 9.32×10 ⁻⁶ | 2.88×10 ⁻⁴ | 1.26×10 ⁻² | 7.29×10 ⁻⁴ | 2.45×10 ⁻³ |
| Waste Treatment Plant, cesium and strontium capsules | 2163 | 2163 | WTP_PS | 4.09 | 2.58×10 ⁻² | 1.35×10 ⁻³ | 2.88×10 ⁻⁴ | a | 7.29×10 ⁻⁴ | 2.45×10 ⁻³ |
| Cesium and Strontium Capsule Processing Facility | 2162 | 2163 | WTP_AS | 3.80×10 ⁻³ | 6.24×10 ⁻³ | 3.53×10 ⁻⁵ | 2.11×10 ⁻³ | a | 9.58×10 ⁻² | 2.70×10 ⁻² |
| Mobile retrieval system | 2013 | 2162 | 200EW | 1.09×10 ⁻¹ | a | a | a | a | a | a |
| Vacuum-based retrieval system | 2013 | 2162 | 200EW | 3.42×10 ⁻² | a | a | a | a | a | a |
| Chemical wash system | 2013 | 2162 | 200EW | 1.43×10 ⁻³ | a | a | a | a | a | a |
| HLW Melter Interim Storage Facility | 2018 | 2262 | WTP_AS | a | a | a | a | a | a | a |
| HLW Debris Storage Facility | 2042 | 2262 | 200EW | a | a | a | a | a | a | a |
| Effluent Treatment Facility | 2006 | 2166 | WTP_PS | 4.54×10 ⁻³ | 1.71×10 ⁻³ | 2.83×10 ⁻⁵ | 1.05×10 ⁻³ | a | 1.86×10 ⁻² | 5.35×10 ⁻³ |
| Evaporator | 2018 | 2163 | 200E | 8.97×10 ⁻² | 1.21×10 ⁻² | 5.06×10 ⁻⁴ | 1.53×10 ⁻² | a | 5.29×10 ⁻³ | 3.69×10 ⁻³ |
| Borrow Area C | 2006 | 2167 | Area C | 1.78×10 ⁻¹ | 3.12×10 ⁻² | 1.02×10 ⁻³ | 3.21×10 ⁻² | a | 1.32×10 ⁻¹ | 4.15×10 ⁻² |

Table G–28. Tank Closure Alternative 6A, Option Case, Toxic Pollutant Emissions (continued)

| Facility/System | Start Year | End Year | Location | Emission Rate (metric tons per year) | | | | | | |
|--|------------|----------|----------|--------------------------------------|-----------------------|-----------------------|-----------------------|-----------------------|-----------------------|-----------------------|
| | | | | Ammonia | Benzene | 1,3-Butadiene | Formaldehyde | Mercury | Toluene | Xylene |
| Deactivation | | | | | | | | | | |
| Mobile retrieval system | 2013 | 2162 | 200EW | a | a | a | a | a | a | a |
| Vacuum-based retrieval system | 2013 | 2162 | 200EW | a | a | a | a | a | a | a |
| Chemical wash system | 2013 | 2162 | 200EW | a | a | a | a | a | a | a |
| IHLW Interim Storage Facility | 2078 | 2197 | WTP_AS | a | a | a | a | a | a | a |
| Waste Treatment Plant original | 2079 | 2081 | WTP_AS | 2.29×10 ⁻¹ | 1.44×10 ⁻³ | 5.21×10 ⁻⁷ | 1.61×10 ⁻⁵ | 7.08×10 ⁻⁴ | 4.07×10 ⁻⁵ | 1.37×10 ⁻⁴ |
| Waste Treatment Plant replacement 1 | 2139 | 2141 | WTP_AS | 2.29×10 ⁻¹ | 1.44×10 ⁻³ | 5.21×10 ⁻⁷ | 1.61×10 ⁻⁵ | 7.08×10 ⁻⁴ | 4.07×10 ⁻⁵ | 1.37×10 ⁻⁴ |
| Waste Treatment Plant replacement 2 | 2164 | 2166 | WTP_AS | 2.29×10 ⁻¹ | 1.44×10 ⁻³ | 5.21×10 ⁻⁷ | 1.61×10 ⁻⁵ | 7.08×10 ⁻⁴ | 4.07×10 ⁻⁵ | 1.37×10 ⁻⁴ |
| Cesium and Strontium Capsule Processing Facility | 2164 | 2164 | WTP_AS | 1.75×10 ⁻³ | 2.88×10 ⁻³ | 1.63×10 ⁻⁵ | 9.76×10 ⁻⁴ | a | 4.42×10 ⁻² | 1.25×10 ⁻² |
| Effluent Treatment Facility original | 2026 | 2026 | WTP_AS | 7.88×10 ⁻² | 2.23×10 ⁻² | 4.73×10 ⁻⁴ | 1.64×10 ⁻² | a | 2.00×10 ⁻¹ | 5.81×10 ⁻² |
| Effluent Treatment Facility replacement 1 | 2056 | 2056 | WTP_AS | 7.88×10 ⁻² | 2.23×10 ⁻² | 4.73×10 ⁻⁴ | 1.64×10 ⁻² | a | 2.00×10 ⁻¹ | 5.81×10 ⁻² |
| Effluent Treatment Facility replacement 2 | 2086 | 2086 | WTP_AS | 7.88×10 ⁻² | 2.23×10 ⁻² | 4.73×10 ⁻⁴ | 1.64×10 ⁻² | a | 2.00×10 ⁻¹ | 5.81×10 ⁻² |
| Effluent Treatment Facility replacement 3 | 2116 | 2116 | WTP_AS | 7.88×10 ⁻² | 2.23×10 ⁻² | 4.73×10 ⁻⁴ | 1.64×10 ⁻² | a | 2.00×10 ⁻¹ | 5.81×10 ⁻² |
| Effluent Treatment Facility replacement 4 | 2146 | 2146 | WTP_AS | 7.88×10 ⁻² | 2.23×10 ⁻² | 4.73×10 ⁻⁴ | 1.64×10 ⁻² | a | 2.00×10 ⁻¹ | 5.81×10 ⁻² |
| Effluent Treatment Facility replacement 5 | 2167 | 2167 | WTP_AS | 7.88×10 ⁻² | 2.23×10 ⁻² | 4.73×10 ⁻⁴ | 1.64×10 ⁻² | a | 2.00×10 ⁻¹ | 5.81×10 ⁻² |
| Evaporator original | 2018 | 2018 | 200E | 1.21×10 ⁻² | 1.63×10 ⁻³ | 6.82×10 ⁻⁵ | 2.06×10 ⁻³ | a | 7.14×10 ⁻⁴ | 4.97×10 ⁻⁴ |
| Evaporator replacement 1 | 2043 | 2043 | 200E | 1.21×10 ⁻² | 1.63×10 ⁻³ | 6.82×10 ⁻⁵ | 2.06×10 ⁻³ | a | 7.14×10 ⁻⁴ | 4.97×10 ⁻⁴ |
| Evaporator replacement 2 | 2068 | 2068 | 200E | 1.21×10 ⁻² | 1.63×10 ⁻³ | 6.82×10 ⁻⁵ | 2.06×10 ⁻³ | a | 7.14×10 ⁻⁴ | 4.97×10 ⁻⁴ |
| Evaporator replacement 3 | 2093 | 2093 | 200E | 1.21×10 ⁻² | 1.63×10 ⁻³ | 6.82×10 ⁻⁵ | 2.06×10 ⁻³ | a | 7.14×10 ⁻⁴ | 4.97×10 ⁻⁴ |
| Evaporator replacement 4 | 2118 | 2118 | 200E | 1.21×10 ⁻² | 1.63×10 ⁻³ | 6.82×10 ⁻⁵ | 2.06×10 ⁻³ | a | 7.14×10 ⁻⁴ | 4.97×10 ⁻⁴ |
| Evaporator replacement 5 | 2143 | 2143 | 200E | 1.21×10 ⁻² | 1.63×10 ⁻³ | 6.82×10 ⁻⁵ | 2.06×10 ⁻³ | a | 7.14×10 ⁻⁴ | 4.97×10 ⁻⁴ |
| Evaporator replacement 6 | 2168 | 2168 | 200E | 1.21×10 ⁻² | 1.63×10 ⁻³ | 6.82×10 ⁻⁵ | 2.06×10 ⁻³ | a | 7.14×10 ⁻⁴ | 4.97×10 ⁻⁴ |
| Closure | | | | | | | | | | |
| Containment structure construction 1 | 2038 | 2041 | 200EW | a | a | a | a | a | a | a |
| Containment structure construction 2 | 2061 | 2064 | 200EW | a | a | a | a | a | a | a |
| Containment structure construction 3 | 2084 | 2087 | 200EW | a | a | a | a | a | a | a |
| Containment structure construction 4 | 2107 | 2110 | 200EW | a | a | a | a | a | a | a |
| Containment structure construction 5 | 2122 | 2125 | 200EW | a | a | a | a | a | a | a |
| Containment structure construction 6 | 2138 | 2141 | 200EW | a | a | a | a | a | a | a |
| Containment structure deactivation 1 | 2062 | 2064 | 200EW | a | a | a | a | a | a | a |

Table G-28. Tank Closure Alternative 6A, Option Case, Toxic Pollutant Emissions (continued)

| Facility/System | Start Year | End Year | Location | Emission Rate (metric tons per year) | | | | | | |
|---|------------|----------|----------|--------------------------------------|-----------------------|-----------------------|-----------------------|---------|-----------------------|-----------------------|
| | | | | Ammonia | Benzene | 1,3-Butadiene | Formaldehyde | Mercury | Toluene | Xylene |
| Closure (continued) | | | | | | | | | | |
| Containment structure deactivation 2 | 2085 | 2087 | 200EW | a | a | a | a | a | a | a |
| Containment structure deactivation 3 | 2108 | 2110 | 200EW | a | a | a | a | a | a | a |
| Containment structure deactivation 4 | 2123 | 2125 | 200EW | a | a | a | a | a | a | a |
| Containment structure deactivation 5 | 2146 | 2148 | 200EW | a | a | a | a | a | a | a |
| Containment structure deactivation 6 | 2138 | 2140 | 200EW | a | a | a | a | a | a | a |
| Containment structure deactivation 7 | 2162 | 2164 | 200EW | a | a | a | a | a | a | a |
| Decontamination and decommissioning of 10 selected facilities | 2018 | 2028 | 200EW | a | a | a | a | a | a | a |
| B tank farm removal | 2065 | 2076 | 200EW | 1.30×10 ⁻¹ | 1.76×10 ⁻² | 7.34×10 ⁻⁴ | 2.22×10 ⁻² | a | 8.77×10 ⁻³ | 5.65×10 ⁻³ |
| T tank farm removal | 2126 | 2137 | 200EW | 1.30×10 ⁻¹ | 1.76×10 ⁻² | 7.34×10 ⁻⁴ | 2.22×10 ⁻² | a | 8.77×10 ⁻³ | 5.65×10 ⁻³ |
| BY tank farm removal | 2111 | 2122 | 200EW | 9.76×10 ⁻² | 1.32×10 ⁻² | 5.50×10 ⁻⁴ | 1.66×10 ⁻² | a | 6.58×10 ⁻³ | 4.24×10 ⁻³ |
| BX tank farm removal | 2042 | 2053 | 200EW | 9.76×10 ⁻² | 1.32×10 ⁻² | 5.50×10 ⁻⁴ | 1.66×10 ⁻² | a | 6.58×10 ⁻³ | 4.24×10 ⁻³ |
| C tank farm removal | 2088 | 2099 | 200EW | 1.30×10 ⁻¹ | 1.76×10 ⁻² | 7.34×10 ⁻⁴ | 2.22×10 ⁻² | a | 8.77×10 ⁻³ | 5.65×10 ⁻³ |
| A tank farm removal | 2142 | 2153 | 200EW | 4.88×10 ⁻² | 6.59×10 ⁻³ | 2.75×10 ⁻⁴ | 8.31×10 ⁻³ | a | 3.29×10 ⁻³ | 2.12×10 ⁻³ |
| AX tank farm removal | 2142 | 2153 | 200EW | 1.30×10 ⁻¹ | 1.76×10 ⁻² | 7.34×10 ⁻⁴ | 2.22×10 ⁻² | a | 8.77×10 ⁻³ | 5.65×10 ⁻³ |
| S tank farm removal | 2126 | 2137 | 200EW | 9.76×10 ⁻² | 1.32×10 ⁻² | 5.50×10 ⁻⁴ | 1.66×10 ⁻² | a | 6.58×10 ⁻³ | 4.24×10 ⁻³ |
| TY tank farm removal | 2111 | 2122 | 200EW | 4.88×10 ⁻² | 6.59×10 ⁻³ | 2.75×10 ⁻⁴ | 8.31×10 ⁻³ | a | 3.29×10 ⁻³ | 2.12×10 ⁻³ |
| TX tank farm removal | 2088 | 2099 | 200EW | 1.46×10 ⁻¹ | 1.98×10 ⁻² | 8.25×10 ⁻⁴ | 2.49×10 ⁻² | a | 9.86×10 ⁻³ | 6.36×10 ⁻³ |
| U tank farm removal | 2065 | 2076 | 200EW | 1.30×10 ⁻¹ | 1.76×10 ⁻² | 7.34×10 ⁻⁴ | 2.22×10 ⁻² | a | 8.77×10 ⁻³ | 5.65×10 ⁻³ |
| SX tank farm removal | 2042 | 2053 | 200EW | 1.22×10 ⁻¹ | 1.65×10 ⁻² | 6.88×10 ⁻⁴ | 2.08×10 ⁻² | a | 8.22×10 ⁻³ | 5.30×10 ⁻³ |
| B tank farm deep soil removal | 2077 | 2084 | 200E | 2.80×10 ⁻² | 3.77×10 ⁻³ | 1.58×10 ⁻⁴ | 4.77×10 ⁻³ | a | 1.65×10 ⁻³ | 1.15×10 ⁻³ |
| T tank farm deep soil removal | 2138 | 2145 | 200W | 2.15×10 ⁻¹ | 2.90×10 ⁻² | 1.21×10 ⁻³ | 3.67×10 ⁻² | a | 1.27×10 ⁻² | 8.85×10 ⁻³ |
| BX tank farm deep soil removal | 2054 | 2061 | 200E | 8.97×10 ⁻¹ | 1.21×10 ⁻¹ | 5.06×10 ⁻³ | 1.53×10 ⁻¹ | a | 5.29×10 ⁻² | 3.69×10 ⁻² |
| C tank farm deep soil removal | 2100 | 2107 | 200E | 1.70×10 ⁻³ | 2.29×10 ⁻⁴ | 9.58×10 ⁻⁶ | 2.89×10 ⁻⁴ | a | 1.00×10 ⁻⁴ | 6.99×10 ⁻⁵ |
| A tank farm deep soil removal | 2154 | 2161 | 200E | 5.10×10 ⁻³ | 6.86×10 ⁻⁴ | 2.88×10 ⁻⁵ | 8.68×10 ⁻⁴ | a | 3.01×10 ⁻⁴ | 2.10×10 ⁻⁴ |
| AX tank farm deep soil removal | 2154 | 2161 | 200E | 8.50×10 ⁻² | 1.14×10 ⁻² | 4.79×10 ⁻⁴ | 1.45×10 ⁻² | a | 5.01×10 ⁻³ | 3.49×10 ⁻³ |
| TX tank farm deep soil removal | 2100 | 2107 | 200EW | 2.68×10 ⁻¹ | 3.60×10 ⁻² | 1.51×10 ⁻³ | 4.56×10 ⁻² | a | 1.58×10 ⁻² | 1.10×10 ⁻² |
| U tank farm deep soil removal | 2077 | 2084 | 200EW | 1.40×10 ⁻¹ | 1.89×10 ⁻² | 7.91×10 ⁻⁴ | 2.39×10 ⁻² | a | 8.27×10 ⁻³ | 5.76×10 ⁻³ |
| SX tank farm deep soil removal | 2054 | 2061 | 200E | 3.42×10 ⁻¹ | 4.61×10 ⁻² | 1.93×10 ⁻³ | 5.83×10 ⁻² | a | 2.02×10 ⁻² | 1.41×10 ⁻² |
| B Area cribs and trenches (ditches) removal | 2054 | 2084 | 200EW | 3.95×10 ⁻¹ | 5.31×10 ⁻² | 2.23×10 ⁻³ | 6.72×10 ⁻² | a | 2.33×10 ⁻² | 1.62×10 ⁻² |

Table G–28. Tank Closure Alternative 6A, Option Case, Toxic Pollutant Emissions (continued)

| Facility/System | Start Year | End Year | Location | Emission Rate (metric tons per year) | | | | | | |
|--|------------|----------|----------|--------------------------------------|-----------------------|------------------------|-----------------------|---------|-----------------------|-----------------------|
| | | | | Ammonia | Benzene | 1,3-Butadiene | Formaldehyde | Mercury | Toluene | Xylene |
| Closure (continued) | | | | | | | | | | |
| T Area cribs and trenches (ditches) removal | 2100 | 2145 | 200EW | 2.66×10 ⁻¹ | 3.58×10 ⁻² | 1.50×10 ⁻³ | 4.53×10 ⁻² | a | 1.57×10 ⁻² | 1.09×10 ⁻² |
| B and T Area cribs and trenches (ditches) construction 1 | 2050 | 2053 | 200EW | a | a | a | a | a | a | a |
| B and T Area cribs and trenches (ditches) construction 2 | 2096 | 2099 | 200EW | a | a | a | a | a | a | a |
| B and T Area cribs and trenches (ditches) deactivation 1 | 2085 | 2087 | 200EW | a | a | a | a | a | a | a |
| B and T Area cribs and trenches (ditches) deactivation 2 | 2146 | 2148 | 200EW | a | a | a | a | a | a | a |
| Preprocessing Facility construction | 2039 | 2041 | 200E | 1.85 | 4.07×10 ⁻¹ | 1.08×10 ⁻² | 3.55×10 ⁻¹ | a | 2.76 | 8.22×10 ⁻¹ |
| Preprocessing Facility operations | 2042 | 2162 | 200E | 5.62×10 ⁻⁴ | 3.20×10 ⁻⁵ | 1.97×10 ⁻⁹ | 1.13×10 ⁻⁷ | a | 4.85×10 ⁻⁶ | 1.37×10 ⁻⁵ |
| Preprocessing Facility deactivation | 2163 | 2163 | 200E | 8.82×10 ⁻⁵ | 5.04×10 ⁻⁶ | 3.09×10 ⁻¹⁰ | 1.77×10 ⁻⁸ | a | 7.62×10 ⁻⁷ | 2.15×10 ⁻⁶ |

^a Emissions for this activity and pollutant were not calculated because annual fuel use for this activity and the resulting emissions would be small compared with those of other activities or would be zero.

Key: 200E=200-East Area; 200W=200-West Area; 200EW=200-East and 200-West Areas; 200EW+=200-East and 200-West Areas and Waste Treatment Plant area; HLW=high-level radioactive waste; IHLW=immobilized high-level radioactive waste; WTP_AS=Waste Treatment Plant area source; WTP_PS=Waste Treatment Plant point source.

Source: SAIC 2007a, 2008.

Table G-29. Tank Closure Alternative 6B, Base Case, Criteria Pollutant Emissions

| Facility/System | Start Year | End Year | Location | Emission Rate (metric tons per year) | | | | |
|---|------------|----------|----------|--------------------------------------|-----------------------|-----------------------|-----------------------|-----------------------|
| | | | | Carbon Monoxide | Nitrogen Dioxide | PM ₁₀ | Sulfur Dioxide | VOCs |
| Construction | | | | | | | | |
| Canister Storage Building | 2006 | 2016 | 200E | 5.54 | 1.28 | 9.05×10 ⁻¹ | 4.02×10 ⁻⁴ | 2.86×10 ⁻¹ |
| IHLW Shipping/Transfer Facility and one IHLW Interim Storage Module | 2011 | 2013 | 200E | 5.68×10 ¹ | 6.72×10 ¹ | 9.81×10 ¹ | 2.18×10 ⁻² | 6.50 |
| IHLW Interim Storage Modules, three additional | 2014 | 2022 | 200E | 4.00×10 ¹ | 4.76×10 ¹ | 1.58×10 ² | 1.45×10 ⁻² | 4.34 |
| Other infrastructure upgrades | 2006 | 2034 | 200EW | 1.11 | 8.05×10 ⁻¹ | 1.13 | 2.54×10 ⁻⁴ | 9.43×10 ⁻² |
| Tank upgrades | 2006 | 2025 | 200EW | 3.49×10 ² | 4.41×10 ¹ | 8.07 | 1.38×10 ⁻² | 1.56×10 ¹ |
| Waste Treatment Plant | 2006 | 2017 | WTP_AS | 7.64×10 ² | 6.20×10 ² | 4.16×10 ² | 1.05 | 7.99×10 ¹ |
| Low-Activity Waste Vitrification Facility expansion | 2008 | 2017 | 200E | 1.85×10 ² | 4.09×10 ¹ | 1.65×10 ² | 2.50×10 ⁻¹ | 1.15×10 ¹ |
| Cesium and Strontium Capsule Processing Facility | 2035 | 2038 | WTP_AS | 8.41×10 ² | 1.22×10 ² | 1.80×10 ¹ | 1.13 | 4.78×10 ¹ |
| Waste receiver facilities | 2013 | 2017 | 200EW | 1.15×10 ² | 9.65×10 ¹ | 3.31×10 ² | 2.92×10 ⁻² | 9.94 |
| Tank risers | 2013 | 2016 | 200EW | 2.01×10 ¹ | 8.94 | 8.10×10 ⁻¹ | 1.88×10 ⁻³ | 2.25 |
| Mobile retrieval system | 2013 | 2043 | 200EW | 8.69×10 ¹ | 3.77×10 ¹ | 7.25 | 1.21×10 ⁻² | 5.75 |
| Vacuum-based retrieval system | 2013 | 2043 | 200EW | 3.24×10 ¹ | 1.46×10 ¹ | 2.94 | 4.66×10 ⁻³ | 2.20 |
| Chemical wash system | 2013 | 2043 | 200EW | 2.19×10 ⁻¹ | 1.17 | 1.46×10 ⁻¹ | 3.66×10 ⁻⁴ | 7.32×10 ⁻² |
| HLW Melter Interim Storage Facility 1 | 2015 | 2016 | WTP_AS | 6.17×10 ⁻¹ | 1.39 | 1.72×10 ¹ | 2.87×10 ⁻⁴ | 6.73×10 ⁻² |
| HLW Melter Interim Storage Facility 2 | 2029 | 2030 | WTP_AS | 6.17×10 ⁻¹ | 1.39 | 1.72×10 ¹ | 2.87×10 ⁻⁴ | 6.73×10 ⁻² |
| Effluent Treatment Facility replacement 1 | 2023 | 2025 | 200E | 1.45×10 ³ | 2.09×10 ² | 9.48×10 ² | 1.96 | 8.25×10 ¹ |
| Effluent Treatment Facility replacement 2 | 2053 | 2055 | 200E | 1.45×10 ³ | 2.09×10 ² | 9.48×10 ² | 1.96 | 8.25×10 ¹ |
| Effluent Treatment Facility replacement 3 | 2083 | 2085 | 200E | 1.45×10 ³ | 2.09×10 ² | 9.48×10 ² | 1.96 | 8.25×10 ¹ |
| Evaporator replacement 1 | 2015 | 2017 | 200E | 4.51×10 ² | 6.53×10 ¹ | 1.76×10 ¹ | 6.07×10 ⁻¹ | 2.56×10 ¹ |
| Immobilized Low-Activity Waste Interim Storage Facilities | 2016 | 2043 | WTP_AS | 1.02 | 4.72 | 4.32×10 ¹ | 1.55×10 ⁻³ | 3.86×10 ⁻¹ |
| HLW Debris Storage Facilities | 2021 | 2090 | 200EW | 3.37×10 ⁻¹ | 1.56 | 1.10×10 ⁻¹ | 5.31×10 ⁻⁴ | 1.28×10 ⁻¹ |
| Underground transfer line 1,000-foot sections | 2009 | 2009 | 200EW+ | 7.59×10 ¹ | 2.71×10 ¹ | 2.41×10 ¹ | 8.75×10 ⁻³ | 4.47 |
| Operations | | | | | | | | |
| IHLW Interim Storage Facility | 2018 | 2066 | 200E | a | a | a | a | a |
| Other infrastructure upgrades | 2006 | 2043 | 200EW | a | a | a | a | a |
| Routine operations | 2006 | 2043 | 200EW | 1.36×10 ¹ | 1.55×10 ¹ | a | a | 5.40 |
| Retrieval operations | 2006 | 2043 | 200EW | 4.72×10 ⁻² | 5.35×10 ⁻² | a | a | 1.89×10 ⁻² |
| Double-shell tank interim stabilization | 2006 | 2043 | 200EW | 3.09×10 ⁻¹ | 3.51×10 ⁻¹ | a | a | 1.24×10 ⁻¹ |
| Waste Treatment Plant | 2018 | 2043 | WTP_PS | 2.36×10 ² | 5.24×10 ² | 9.08 | 2.69×10 ¹ | 8.56×10 ² |

Table G–29. Tank Closure Alternative 6B, Base Case, Criteria Pollutant Emissions (continued)

| Facility/System | Start Year | End Year | Location | Emission Rate (metric tons per year) | | | | |
|---|------------|----------|----------|--------------------------------------|-----------------------|-----------------------|-----------------------|-----------------------|
| | | | | Carbon Monoxide | Nitrogen Dioxide | PM ₁₀ | Sulfur Dioxide | VOCs |
| Operations (continued) | | | | | | | | |
| Waste Treatment Plant, cesium and strontium capsules | 2040 | 2040 | WTP_PS | 2.36×10 ² | 5.24×10 ² | 9.08 | 2.69×10 ¹ | 8.56×10 ² |
| Cesium and Strontium Capsule Processing Facility | 2039 | 2040 | WTP_AS | 4.85×10 ¹ | 1.29 | 5.53×10 ¹ | 6.49×10 ⁻² | 2.34 |
| Mobile retrieval system | 2013 | 2043 | 200EW | 3.99×10 ⁻¹ | 4.53×10 ⁻¹ | a | a | 1.60×10 ⁻¹ |
| Vacuum-based retrieval system | 2013 | 2043 | 200EW | 2.21×10 ⁻¹ | 2.50×10 ⁻¹ | a | a | 8.83×10 ⁻² |
| Chemical wash system | 2013 | 2043 | 200EW | 1.46×10 ⁻¹ | 5.12×10 ⁻¹ | 1.54 | 1.45×10 ⁻⁴ | a |
| HLW Melter Interim Storage Facility | 2018 | 2199 | WTP_AS | a | a | a | a | a |
| Effluent Treatment Facility | 2006 | 2100 | WTP_PS | 9.84 | 2.67 | 9.34×10 ² | 1.33×10 ⁻² | 6.48×10 ⁻¹ |
| Evaporator | 2006 | 2043 | 200E | 1.23×10 ¹ | 5.70×10 ¹ | 1.71×10 ¹ | 1.94×10 ⁻² | 1.56×10 ⁻¹ |
| Borrow Area C | 2006 | 2102 | Area C | 8.52×10 ¹ | 1.12×10 ² | 2.30×10 ² | 1.20×10 ⁻¹ | 1.20×10 ¹ |
| Immobilized Low-Activity Waste Interim Storage Facilities | 2018 | 2199 | WTP_AS | a | a | a | a | a |
| HLW Debris Storage Facilities | 2023 | 2199 | 200EW | a | a | a | a | a |
| Deactivation | | | | | | | | |
| Mobile retrieval system | 2013 | 2043 | 200EW | 4.34×10 ¹ | 3.40 | 2.83×10 ⁻¹ | 1.04×10 ⁻³ | 1.79 |
| Vacuum-based retrieval system | 2013 | 2043 | 200EW | 7.05×10 ⁻¹ | 5.53×10 ⁻² | 5.03×10 ⁻³ | 1.69×10 ⁻⁵ | 2.88×10 ⁻² |
| Chemical wash system | 2013 | 2043 | 200EW | 2.03 | 3.57×10 ⁻¹ | 3.01×10 ⁻² | 1.14×10 ⁻⁴ | 9.62×10 ⁻² |
| IHLW Interim Storage Facility | 2067 | 2067 | WTP_AS | a | a | a | a | a |
| Waste Treatment Plant | 2044 | 2045 | WTP_AS | 2.36×10 ¹ | 5.24×10 ¹ | 9.08×10 ⁻¹ | 2.69 | 8.56×10 ¹ |
| Cesium and Strontium Capsule Processing Facility | 2041 | 2041 | WTP_AS | 2.24×10 ¹ | 5.96×10 ⁻¹ | 2.55×10 ¹ | 3.00×10 ⁻² | 1.08 |
| Effluent Treatment Facility original | 2026 | 2026 | WTP_AS | 1.09×10 ² | 4.78×10 ¹ | 4.70×10 ² | 1.48×10 ⁻¹ | 8.47 |
| Effluent Treatment Facility replacement 1 | 2056 | 2056 | WTP_AS | 1.09×10 ² | 4.78×10 ¹ | 4.70×10 ² | 1.48×10 ⁻¹ | 8.47 |
| Effluent Treatment Facility replacement 2 | 2086 | 2086 | WTP_AS | 1.09×10 ² | 4.78×10 ¹ | 4.70×10 ² | 1.48×10 ⁻¹ | 8.47 |
| Effluent Treatment Facility replacement 3 | 2101 | 2101 | WTP_AS | 1.09×10 ² | 4.78×10 ¹ | 4.70×10 ² | 1.48×10 ⁻¹ | 8.47 |
| Evaporator original | 2018 | 2018 | 200E | 1.66 | 7.70 | 7.07 | 2.62×10 ⁻³ | 6.28×10 ⁻¹ |
| Evaporator replacement 1 | 2044 | 2044 | 200E | 1.66 | 7.70 | 7.07 | 2.62×10 ⁻³ | 6.28×10 ⁻¹ |
| Closure | | | | | | | | |
| Containment structure construction 1 | 2019 | 2022 | 200EW | 6.78×10 ¹ | 7.06 | 2.74 | 2.19×10 ⁻³ | 2.91 |
| Containment structure construction 2 | 2019 | 2022 | 200EW | 6.78×10 ¹ | 7.06 | 2.74 | 2.19×10 ⁻³ | 2.91 |
| Containment structure construction 3 | 2046 | 2049 | 200EW | 6.78×10 ¹ | 7.06 | 2.74 | 2.19×10 ⁻³ | 2.91 |
| Containment structure construction 4 | 2046 | 2049 | 200EW | 6.78×10 ¹ | 7.06 | 2.74 | 2.19×10 ⁻³ | 2.91 |
| Containment structure construction 5 | 2073 | 2076 | 200EW | 6.78×10 ¹ | 7.06 | 2.74 | 2.19×10 ⁻³ | 2.91 |

Table G–29. Tank Closure Alternative 6B, Base Case, Criteria Pollutant Emissions (continued)

| Facility/System | Start Year | End Year | Location | Emission Rate (metric tons per year) | | | | |
|---|------------|----------|----------|--------------------------------------|----------------------|-----------------------|-----------------------|-----------------------|
| | | | | Carbon Monoxide | Nitrogen Dioxide | PM ₁₀ | Sulfur Dioxide | VOCs |
| Closure (continued) | | | | | | | | |
| Containment structure construction 6 | 2073 | 2076 | 200EW | 6.78×10 ¹ | 7.06 | 2.74 | 2.19×10 ⁻³ | 2.91 |
| Containment structure deactivation 1 | 2043 | 2045 | 200EW | 9.03×10 ¹ | 9.39 | 3.09 | 2.92×10 ⁻³ | 3.88 |
| Containment structure deactivation 2 | 2043 | 2045 | 200EW | 9.03×10 ¹ | 9.39 | 3.09 | 2.92×10 ⁻³ | 3.88 |
| Containment structure deactivation 3 | 2070 | 2072 | 200EW | 9.03×10 ¹ | 9.39 | 3.09 | 2.92×10 ⁻³ | 3.88 |
| Containment structure deactivation 4 | 2062 | 2064 | 200EW | 9.03×10 ¹ | 9.39 | 3.09 | 2.92×10 ⁻³ | 3.88 |
| Containment structure deactivation 5 | 2089 | 2091 | 200EW | 4.52×10 ¹ | 4.70 | 1.55 | 1.46×10 ⁻³ | 1.94 |
| Containment structure deactivation 6 | 2097 | 2099 | 200EW | 4.52×10 ¹ | 4.70 | 1.55 | 1.46×10 ⁻³ | 1.94 |
| Containment structure deactivation 7 | 2097 | 2099 | 200EW | 9.03×10 ¹ | 9.39 | 3.09 | 2.92×10 ⁻³ | 3.88 |
| Modified Resource Conservation and Recovery Act Subtitle C barrier construction | 2100 | 2101 | 200EW | 1.72×10 ³ | 1.57×10 ³ | 3.65×10 ³ | 2.38 | 1.93×10 ² |
| Decontamination and decommissioning of 10 selected facilities | 2018 | 2028 | 200EW | 2.53 | 9.81 | 8.56 | 3.22×10 ⁻³ | 7.93×10 ⁻¹ |
| B tank farm removal | 2023 | 2034 | 200EW | 1.84×10 ¹ | 8.27×10 ¹ | 1.07×10 ¹ | 2.89×10 ⁻² | 6.78 |
| T tank farm removal | 2077 | 2088 | 200EW | 1.84×10 ¹ | 8.27×10 ¹ | 1.07×10 ¹ | 2.89×10 ⁻² | 6.78 |
| BY tank farm removal | 2050 | 2061 | 200EW | 1.38×10 ¹ | 6.20×10 ¹ | 8.04 | 2.17×10 ⁻² | 5.08 |
| BX tank farm removal | 2023 | 2034 | 200EW | 1.38×10 ¹ | 6.20×10 ¹ | 8.04 | 2.17×10 ⁻² | 5.08 |
| C tank farm removal | 2050 | 2061 | 200EW | 1.84×10 ¹ | 8.27×10 ¹ | 1.07×10 ¹ | 2.89×10 ⁻² | 6.78 |
| A tank farm removal | 2077 | 2088 | 200EW | 6.89 | 3.10×10 ¹ | 4.02 | 1.08×10 ⁻² | 2.54 |
| AX tank farm removal | 2077 | 2088 | 200EW | 1.84×10 ¹ | 8.27×10 ¹ | 1.07×10 ¹ | 2.89×10 ⁻² | 6.78 |
| S tank farm removal | 2077 | 2088 | 200EW | 1.38×10 ¹ | 6.20×10 ¹ | 8.04 | 2.17×10 ⁻² | 5.08 |
| TY tank farm removal | 2050 | 2061 | 200EW | 6.89 | 3.10×10 ¹ | 4.02 | 1.08×10 ⁻² | 2.54 |
| TX tank farm removal | 2050 | 2061 | 200EW | 2.07×10 ¹ | 9.31×10 ¹ | 1.21×10 ¹ | 3.25×10 ⁻² | 7.63 |
| U tank farm removal | 2023 | 2034 | 200EW | 1.84×10 ¹ | 8.27×10 ¹ | 1.07×10 ¹ | 2.89×10 ⁻² | 6.78 |
| SX tank farm removal | 2023 | 2034 | 200EW | 1.72×10 ¹ | 7.75×10 ¹ | 1.01×10 ¹ | 2.71×10 ⁻² | 6.35 |
| B tank farm deep soil removal | 2035 | 2042 | 200E | 3.84 | 1.78×10 ¹ | 1.89 | 6.06×10 ⁻³ | 1.46 |
| T tank farm deep soil removal | 2089 | 2096 | 200W | 2.95×10 ¹ | 1.37×10 ² | 1.45×10 ¹ | 4.66×10 ⁻² | 1.12×10 ¹ |
| BX tank farm deep soil removal | 2035 | 2042 | 200E | 1.23×10 ² | 5.71×10 ² | 6.04×10 ¹ | 1.94×10 ⁻¹ | 4.66×10 ¹ |
| C tank farm deep soil removal | 2062 | 2069 | 200E | 2.33×10 ⁻¹ | 1.08 | 1.15×10 ⁻¹ | 3.68×10 ⁻⁴ | 8.82×10 ⁻² |
| A tank farm deep soil removal | 2089 | 2096 | 200E | 6.99×10 ⁻¹ | 3.24 | 3.43×10 ⁻¹ | 1.10×10 ⁻³ | 2.65×10 ⁻¹ |
| AX tank farm deep soil removal | 2089 | 2096 | 200E | 1.16×10 ¹ | 5.41×10 ¹ | 5.72 | 1.84×10 ⁻² | 4.41 |
| TX tank farm deep soil removal | 2062 | 2069 | 200EW | 3.67×10 ¹ | 1.70×10 ² | 1.80×10 ¹ | 5.79×10 ⁻² | 1.39×10 ¹ |

Table G-29. Tank Closure Alternative 6B, Base Case, Criteria Pollutant Emissions (continued)

| Facility/System | Start Year | End Year | Location | Emission Rate (metric tons per year) | | | | |
|-------------------------------------|------------|----------|----------|--------------------------------------|-----------------------|-----------------------|-----------------------|-----------------------|
| | | | | Carbon Monoxide | Nitrogen Dioxide | PM ₁₀ | Sulfur Dioxide | VOCs |
| Closure (continued) | | | | | | | | |
| U tank farm deep soil removal | 2035 | 2042 | 200EW | 1.92×10 ¹ | 8.92×10 ¹ | 9.44 | 3.03×10 ⁻² | 7.28 |
| SX tank farm deep soil removal | 2035 | 2042 | 200W | 4.69×10 ¹ | 2.18×10 ² | 2.31×10 ¹ | 7.40×10 ⁻² | 1.78×10 ¹ |
| Preprocessing Facility construction | 2020 | 2022 | 200E | 7.88×10 ² | 5.70×10 ² | 1.71×10 ² | 1.08 | 7.74×10 ¹ |
| Preprocessing Facility operation | 2023 | 2099 | 200E | 3.53×10 ⁻¹ | 1.30×10 ⁻¹ | 1.16×10 ⁻² | 3.60×10 ⁻² | 3.42×10 ⁻¹ |
| Preprocessing Facility deactivation | 2100 | 2100 | 200E | 5.54×10 ⁻² | 2.05×10 ⁻² | 1.82×10 ⁻³ | 5.65×10 ⁻³ | 1.12×10 ⁻³ |
| Postclosure care | 2102 | 2201 | 200EW | a | a | a | a | a |

^a Emissions for this activity and pollutant were not calculated because annual fuel use for this activity and the resulting emissions would be small compared with those of other activities or would be zero.

Key: 200E=200-East Area; 200W=200-West Area; 200EW=200-East and 200-West Areas; 200EW+=200-East and 200-West Areas and Waste Treatment Plant area; HLW=high-level radioactive waste; IHLW=immobilized high-level radioactive waste; PM₁₀=particulate matter with an aerodynamic diameter less than or equal to 10 micrometers; VOC=volatile organic compound; WTP_AS=Waste Treatment Plant area source; WTP_PS=Waste Treatment Plant point source.

Source: SAIC 2007a, 2008.

Table G-30. Tank Closure Alternative 6B, Base Case, Toxic Pollutant Emissions

| Facility/System | Start Year | End Year | Location | Emission Rate (metric tons per year) | | | | | | |
|---|------------|----------|----------|--------------------------------------|-----------------------|-----------------------|-----------------------|---------|-----------------------|-----------------------|
| | | | | Ammonia | Benzene | 1,3-Butadiene | Formaldehyde | Mercury | Toluene | Xylene |
| Construction | | | | | | | | | | |
| Canister Storage Building | 2006 | 2016 | 200E | a | a | a | a | a | a | a |
| IHLW Shipping/Transfer Facility and one IHLW Interim Storage Module | 2011 | 2013 | 200E | a | a | a | a | a | a | a |
| IHLW Interim Storage Modules, three additional | 2014 | 2022 | 200E | a | a | a | a | a | a | a |
| Other infrastructure upgrades | 2006 | 2034 | 200EW | a | a | a | a | a | a | a |
| Tank upgrades | 2006 | 2025 | 200EW | 7.82×10^{-2} | a | a | a | a | a | a |
| Waste Treatment Plant | 2006 | 2017 | WTP_AS | 9.98×10^{-1} | 2.09×10^{-1} | 5.81×10^{-3} | 1.89×10^{-1} | a | 1.31 | 3.93×10^{-1} |
| Low-Activity Waste Vitrification Facility expansion | 2008 | 2017 | 200E | 7.08×10^{-2} | 3.05×10^{-2} | 4.50×10^{-4} | 1.74×10^{-2} | a | 3.54×10^{-1} | 1.01×10^{-1} |
| Cesium and Strontium Capsule Processing Facility | 2035 | 2038 | WTP_AS | 2.22×10^{-1} | 1.27×10^{-1} | 1.49×10^{-3} | 6.26×10^{-2} | a | 1.63 | 4.64×10^{-1} |
| Waste receiver facilities | 2013 | 2017 | 200EW | a | a | a | a | a | a | a |
| Tank risers | 2013 | 2016 | 200EW | 2.38 | a | a | a | a | a | a |
| Mobile retrieval system | 2013 | 2043 | 200EW | 3.46×10^{-1} | a | a | a | a | a | a |
| Vacuum-based retrieval system | 2013 | 2043 | 200EW | 1.91×10^{-1} | a | a | a | a | a | a |
| Chemical wash system | 2013 | 2043 | 200EW | 5.37×10^{-3} | a | a | a | a | a | a |
| HLW Melter Interim Storage Facility 1 | 2015 | 2016 | WTP_AS | a | a | a | a | a | a | a |
| HLW Melter Interim Storage Facility 2 | 2029 | 2030 | WTP_AS | a | a | a | a | a | a | a |
| Effluent Treatment Facility replacement 1 | 2023 | 2025 | 200E | 3.81×10^{-1} | 2.19×10^{-1} | 2.55×10^{-3} | 1.08×10^{-1} | a | 2.82 | 8.02×10^{-1} |
| Effluent Treatment Facility replacement 2 | 2053 | 2055 | 200E | 3.81×10^{-1} | 2.19×10^{-1} | 2.55×10^{-3} | 1.08×10^{-1} | a | 2.82 | 8.02×10^{-1} |
| Effluent Treatment Facility replacement 3 | 2083 | 2085 | 200E | 3.81×10^{-1} | 2.19×10^{-1} | 2.55×10^{-3} | 1.08×10^{-1} | a | 2.82 | 8.02×10^{-1} |
| Evaporator replacement 1 | 2015 | 2017 | 200E | 1.19×10^{-1} | 6.80×10^{-2} | 7.95×10^{-4} | 3.35×10^{-2} | a | 8.74×10^{-1} | 2.49×10^{-1} |
| Immobilized Low-Activity Waste Interim Storage Facilities | 2016 | 2043 | WTP_AS | 7.42×10^{-3} | 9.99×10^{-4} | a | a | a | 4.38×10^{-4} | 3.06×10^{-4} |
| HLW Debris Storage Facilities | 2021 | 2090 | 200EW | 2.46×10^{-3} | 3.31×10^{-4} | 1.39×10^{-5} | 4.18×10^{-4} | a | 1.45×10^{-4} | 1.01×10^{-4} |
| Underground transfer line 1,000-foot sections | 2009 | 2009 | 200EW+ | a | a | a | a | a | a | a |

Table G-30. Tank Closure Alternative 6B, Base Case, Toxic Pollutant Emissions (continued)

| Facility/System | Start Year | End Year | Location | Emission Rate (metric tons per year) | | | | | | |
|---|------------|----------|----------|--------------------------------------|-----------------------|-----------------------|-----------------------|-----------------------|-----------------------|-----------------------|
| | | | | Ammonia | Benzene | 1,3-Butadiene | Formaldehyde | Mercury | Toluene | Xylene |
| Deactivation | | | | | | | | | | |
| IHLW Interim Storage Facility | 2018 | 2066 | 200E | a | a | a | a | a | a | a |
| Other infrastructure upgrades | 2006 | 2043 | 200EW | a | a | a | a | a | a | a |
| Routine operations | 2006 | 2043 | 200EW | 1.18×10 ¹ | a | a | a | a | a | a |
| Retrieval operations | 2006 | 2043 | 200EW | 4.09×10 ⁻² | a | a | a | a | a | a |
| Double-shell tank interim stabilization | 2006 | 2043 | 200EW | 2.68×10 ⁻¹ | a | a | a | a | a | a |
| Waste Treatment Plant | 2018 | 2043 | WTP_PS | 3.53 | 2.23×10 ⁻² | 8.05×10 ⁻⁶ | 2.49×10 ⁻⁴ | 6.97×10 ⁻² | 6.27×10 ⁻⁴ | 2.11×10 ⁻³ |
| Waste Treatment Plant, cesium and strontium capsules | 2040 | 2040 | WTP_PS | 3.53 | 2.23×10 ⁻² | 8.05×10 ⁻⁶ | 2.49×10 ⁻⁴ | a | 6.27×10 ⁻⁴ | 2.11×10 ⁻³ |
| Cesium and Strontium Capsule Processing Facility | 2039 | 2040 | WTP_AS | 3.80×10 ⁻³ | 6.24×10 ⁻³ | 3.53×10 ⁻⁵ | 2.11×10 ⁻³ | a | 9.58×10 ⁻² | 2.70×10 ⁻² |
| Mobile retrieval system | 2013 | 2043 | 200EW | 3.46×10 ⁻¹ | a | a | a | a | a | a |
| Vacuum-based retrieval system | 2013 | 2043 | 200EW | 1.91×10 ⁻¹ | a | a | a | a | a | a |
| Chemical wash system | 2013 | 2043 | 200EW | 5.37×10 ⁻³ | a | a | a | a | a | a |
| HLW Melter Interim Storage Facility | 2018 | 2199 | WTP_AS | a | a | a | a | a | a | a |
| Effluent Treatment Facility | 2006 | 2100 | WTP_PS | 1.44 | 1.71×10 ⁻³ | 2.83×10 ⁻⁵ | 1.05×10 ⁻³ | a | 1.86×10 ⁻² | 5.35×10 ⁻³ |
| Evaporator | 2006 | 2043 | 200E | 8.97×10 ⁻² | 1.21×10 ⁻² | 5.06×10 ⁻⁴ | 1.53×10 ⁻² | a | 5.29×10 ⁻³ | 3.69×10 ⁻³ |
| Borrow Area C | 2006 | 2102 | Area C | 1.78×10 ⁻¹ | 3.12×10 ⁻² | 1.02×10 ⁻³ | 3.21×10 ⁻² | a | 1.32×10 ⁻¹ | 4.15×10 ⁻² |
| Immobilized Low-Activity Waste Interim Storage Facilities | 2018 | 2199 | WTP_AS | a | a | a | a | a | a | a |
| HLW Debris Storage Facilities | 2023 | 2199 | 200EW | a | a | a | a | a | a | a |
| Deactivation | | | | | | | | | | |
| Mobile retrieval system | 2013 | 2043 | 200EW | a | a | a | a | a | a | a |
| Vacuum-based retrieval system | 2013 | 2043 | 200EW | a | a | a | a | a | a | a |
| Chemical wash system | 2013 | 2043 | 200EW | a | a | a | a | a | a | a |
| IHLW Interim Storage Facility | 2067 | 2067 | WTP_AS | a | a | a | a | a | a | a |
| Waste Treatment Plant | 2044 | 2045 | WTP_AS | 3.53×10 ⁻¹ | 2.23×10 ⁻³ | 8.05×10 ⁻⁷ | 2.49×10 ⁻⁵ | 9.06×10 ⁻² | 6.27×10 ⁻⁵ | 2.11×10 ⁻⁴ |
| Cesium and Strontium Capsule Processing Facility | 2041 | 2041 | WTP_AS | 1.75×10 ⁻³ | 2.88×10 ⁻³ | 1.63×10 ⁻⁵ | 9.76×10 ⁻⁴ | a | 4.42×10 ⁻² | 1.25×10 ⁻² |
| Effluent Treatment Facility original | 2026 | 2026 | WTP_AS | 7.88×10 ⁻² | 2.23×10 ⁻² | 4.73×10 ⁻⁴ | 1.64×10 ⁻² | a | 2.00×10 ⁻¹ | 5.81×10 ⁻² |
| Effluent Treatment Facility replacement 1 | 2056 | 2056 | WTP_AS | 7.88×10 ⁻² | 2.23×10 ⁻² | 4.73×10 ⁻⁴ | 1.64×10 ⁻² | a | 2.00×10 ⁻¹ | 5.81×10 ⁻² |

Table G-30. Tank Closure Alternative 6B, Base Case, Toxic Pollutant Emissions (continued)

| Facility/System | Start Year | End Year | Location | Emission Rate (metric tons per year) | | | | | | |
|---|------------|----------|----------|--------------------------------------|-----------------------|-----------------------|-----------------------|---------|-----------------------|-----------------------|
| | | | | Ammonia | Benzene | 1,3-Butadiene | Formaldehyde | Mercury | Toluene | Xylene |
| Deactivation (continued) | | | | | | | | | | |
| Effluent Treatment Facility replacement 2 | 2086 | 2086 | WTP_AS | 7.88×10 ⁻² | 2.23×10 ⁻² | 4.73×10 ⁻⁴ | 1.64×10 ⁻² | a | 2.00×10 ⁻¹ | 5.81×10 ⁻² |
| Effluent Treatment Facility replacement 3 | 2101 | 2101 | WTP_AS | 7.88×10 ⁻² | 2.23×10 ⁻² | 4.73×10 ⁻⁴ | 1.64×10 ⁻² | a | 2.00×10 ⁻¹ | 5.81×10 ⁻² |
| Evaporator original | 2018 | 2018 | 200E | 1.21×10 ⁻² | 1.63×10 ⁻³ | 6.82×10 ⁻⁵ | 2.06×10 ⁻³ | a | 7.14×10 ⁻⁴ | 4.97×10 ⁻⁴ |
| Evaporator replacement | 2044 | 2044 | 200E | 1.21×10 ⁻² | 1.63×10 ⁻³ | 6.82×10 ⁻⁵ | 2.06×10 ⁻³ | a | 7.14×10 ⁻⁴ | 4.97×10 ⁻⁴ |
| Closure | | | | | | | | | | |
| Containment structure construction 1 | 2019 | 2022 | 200EW | a | a | a | a | a | a | a |
| Containment structure construction 2 | 2019 | 2022 | 200EW | a | a | a | a | a | a | a |
| Containment structure construction 3 | 2046 | 2049 | 200EW | a | a | a | a | a | a | a |
| Containment structure construction 4 | 2046 | 2049 | 200EW | a | a | a | a | a | a | a |
| Containment structure construction 5 | 2073 | 2076 | 200EW | a | a | a | a | a | a | a |
| Containment structure construction 6 | 2073 | 2076 | 200EW | a | a | a | a | a | a | a |
| Containment structure deactivation 1 | 2043 | 2045 | 200EW | a | a | a | a | a | a | a |
| Containment structure deactivation 2 | 2043 | 2045 | 200EW | a | a | a | a | a | a | a |
| Containment structure deactivation 3 | 2070 | 2072 | 200EW | a | a | a | a | a | a | a |
| Containment structure deactivation 4 | 2062 | 2064 | 200EW | a | a | a | a | a | a | a |
| Containment structure deactivation 5 | 2089 | 2091 | 200EW | a | a | a | a | a | a | a |
| Containment structure deactivation 6 | 2097 | 2099 | 200EW | a | a | a | a | a | a | a |
| Containment structure deactivation 7 | 2097 | 2099 | 200EW | a | a | a | a | a | a | a |
| Modified Resource Conservation and Recovery Act Subtitle C barrier construction | 2100 | 2101 | 200EW | 2.53 | 5.04×10 ⁻¹ | 1.46×10 ⁻² | 4.72×10 ⁻¹ | a | 2.88 | 8.74×10 ⁻¹ |
| Decontamination and decommissioning of 10 selected facilities | 2018 | 2028 | 200EW | a | a | a | a | a | a | a |
| B tank farm removal | 2023 | 2034 | 200EW | 1.30×10 ⁻¹ | 1.76×10 ⁻² | 7.34×10 ⁻⁴ | 2.22×10 ⁻² | a | 8.77×10 ⁻³ | 5.65×10 ⁻³ |
| T tank farm removal | 2077 | 2088 | 200EW | 1.30×10 ⁻¹ | 1.76×10 ⁻² | 7.34×10 ⁻⁴ | 2.22×10 ⁻² | a | 8.77×10 ⁻³ | 5.65×10 ⁻³ |
| Removal of BY tank farm | 2050 | 2061 | 200EW | 9.76×10 ⁻² | 1.32×10 ⁻² | 5.50×10 ⁻⁴ | 1.66×10 ⁻² | a | 6.58×10 ⁻³ | 4.24×10 ⁻³ |
| BX tank farm removal | 2023 | 2034 | 200EW | 9.76×10 ⁻² | 1.32×10 ⁻² | 5.50×10 ⁻⁴ | 1.66×10 ⁻² | a | 6.58×10 ⁻³ | 4.24×10 ⁻³ |
| C tank farm removal | 2050 | 2061 | 200EW | 1.30×10 ⁻¹ | 1.76×10 ⁻² | 7.34×10 ⁻⁴ | 2.22×10 ⁻² | a | 8.77×10 ⁻³ | 5.65×10 ⁻³ |
| A tank farm removal | 2077 | 2088 | 200EW | 4.88×10 ⁻² | 6.59×10 ⁻³ | 2.75×10 ⁻⁴ | 8.31×10 ⁻³ | a | 3.29×10 ⁻³ | 2.12×10 ⁻³ |
| AX tank farm removal | 2077 | 2088 | 200EW | 1.30×10 ⁻¹ | 1.76×10 ⁻² | 7.34×10 ⁻⁴ | 2.22×10 ⁻² | a | 8.77×10 ⁻³ | 5.65×10 ⁻³ |
| S tank farm removal | 2077 | 2088 | 200EW | 9.76×10 ⁻² | 1.32×10 ⁻² | 5.50×10 ⁻⁴ | 1.66×10 ⁻² | a | 6.58×10 ⁻³ | 4.24×10 ⁻³ |

Table G-30. Tank Closure Alternative 6B, Base Case, Toxic Pollutant Emissions (continued)

| Facility/System | Start Year | End Year | Location | Emission Rate (metric tons per year) | | | | | | |
|-------------------------------------|------------|----------|----------|--------------------------------------|-----------------------|------------------------|-----------------------|---------|-----------------------|-----------------------|
| | | | | Ammonia | Benzene | 1,3-Butadiene | Formaldehyde | Mercury | Toluene | Xylene |
| Closure (continued) | | | | | | | | | | |
| TY tank farm removal | 2050 | 2061 | 200EW | 4.88×10 ⁻² | 6.59×10 ⁻³ | 2.75×10 ⁻⁴ | 8.31×10 ⁻³ | a | 3.29×10 ⁻³ | 2.12×10 ⁻³ |
| TX tank farm removal | 2050 | 2061 | 200EW | 1.46×10 ⁻¹ | 1.98×10 ⁻² | 8.25×10 ⁻⁴ | 2.49×10 ⁻² | a | 9.86×10 ⁻³ | 6.36×10 ⁻³ |
| U tank farm removal | 2023 | 2034 | 200EW | 1.30×10 ⁻¹ | 1.76×10 ⁻² | 7.34×10 ⁻⁴ | 2.22×10 ⁻² | a | 8.77×10 ⁻³ | 5.65×10 ⁻³ |
| SX tank farm removal | 2023 | 2034 | 200EW | 1.22×10 ⁻¹ | 1.65×10 ⁻² | 6.88×10 ⁻⁴ | 2.08×10 ⁻² | a | 8.22×10 ⁻³ | 5.30×10 ⁻³ |
| B tank farm deep soil removal | 2035 | 2042 | 200E | 2.80×10 ⁻² | 3.77×10 ⁻³ | 1.58×10 ⁻⁴ | 4.77×10 ⁻³ | a | 1.65×10 ⁻³ | 1.15×10 ⁻³ |
| T tank farm deep soil removal | 2089 | 2096 | 200W | 2.15×10 ⁻¹ | 2.90×10 ⁻² | 1.21×10 ⁻³ | 3.67×10 ⁻² | a | 1.27×10 ⁻² | 8.85×10 ⁻³ |
| BX tank farm deep soil removal | 2035 | 2042 | 200E | 8.97×10 ⁻¹ | 1.21×10 ⁻¹ | 5.06×10 ⁻³ | 1.53×10 ⁻¹ | a | 5.29×10 ⁻² | 3.69×10 ⁻² |
| C tank farm deep soil removal | 2062 | 2069 | 200E | 1.70×10 ⁻³ | 2.29×10 ⁻⁴ | 9.58×10 ⁻⁶ | 2.89×10 ⁻⁴ | a | 1.00×10 ⁻⁴ | 6.99×10 ⁻⁵ |
| A tank farm deep soil removal | 2089 | 2096 | 200E | 5.10×10 ⁻³ | 6.86×10 ⁻⁴ | 2.88×10 ⁻⁵ | 8.68×10 ⁻⁴ | a | 3.01×10 ⁻⁴ | 2.10×10 ⁻⁴ |
| AX tank farm deep soil removal | 2089 | 2096 | 200E | 8.50×10 ⁻² | 1.14×10 ⁻² | 4.79×10 ⁻⁴ | 1.45×10 ⁻² | a | 5.01×10 ⁻³ | 3.49×10 ⁻³ |
| TX tank farm deep soil removal | 2062 | 2069 | 200EW | 2.68×10 ⁻¹ | 3.60×10 ⁻² | 1.51×10 ⁻³ | 4.56×10 ⁻² | a | 1.58×10 ⁻² | 1.10×10 ⁻² |
| U tank farm deep soil removal | 2035 | 2042 | 200EW | 1.40×10 ⁻¹ | 1.89×10 ⁻² | 7.91×10 ⁻⁴ | 2.39×10 ⁻² | a | 8.27×10 ⁻³ | 5.76×10 ⁻³ |
| SX tank farm deep soil removal | 2035 | 2042 | 200W | 3.42×10 ⁻¹ | 4.61×10 ⁻² | 1.93×10 ⁻³ | 5.83×10 ⁻² | a | 2.02×10 ⁻² | 1.41×10 ⁻² |
| Preprocessing Facility construction | 2020 | 2022 | 200E | 9.20×10 ⁻¹ | 2.03×10 ⁻¹ | 5.38×10 ⁻³ | 1.77×10 ⁻¹ | a | 1.37 | 4.10×10 ⁻¹ |
| Preprocessing Facility operations | 2023 | 2099 | 200E | 1.60×10 ⁻⁴ | 9.12×10 ⁻⁶ | 5.60×10 ⁻¹⁰ | 3.20×10 ⁻⁸ | a | 1.38×10 ⁻⁶ | 3.90×10 ⁻⁶ |
| Preprocessing Facility deactivation | 2100 | 2100 | 200E | 2.51×10 ⁻⁵ | 1.43×10 ⁻⁶ | 8.80×10 ⁻¹¹ | 5.03×10 ⁻⁹ | a | 2.17×10 ⁻⁷ | 6.13×10 ⁻⁷ |
| Postclosure care | 2102 | 2201 | 200EW | a | a | a | a | a | a | a |

^a Emissions for this activity and pollutant were not calculated because annual fuel use for this activity and the resulting emissions would be small compared with those of other activities or would be zero.

Key: 200E=200-East Area; 200W=200-West Area; 200EW=200-East and 200-West Areas; 200EW+=200-East and 200-West Areas and Waste Treatment Plant area; HLW=high-level radioactive waste; IHLW=immobilized high-level radioactive waste; WTP_AS=Waste Treatment Plant area source; WTP_PS=Waste Treatment Plant point source.

Source: SAIC 2007a, 2008.

Table G–31. Tank Closure Alternative 6B, Option Case, Criteria Pollutant Emissions

| Facility/System | Start Year | End Year | Location | Emission Rate (metric tons per year) | | | | |
|---|------------|----------|----------|--------------------------------------|-----------------------|-----------------------|-----------------------|-----------------------|
| | | | | Carbon Monoxide | Nitrogen Dioxide | PM ₁₀ | Sulfur Dioxide | VOCs |
| Construction | | | | | | | | |
| Canister Storage Building | 2006 | 2016 | 200E | 5.54 | 1.28 | 9.05×10 ⁻¹ | 4.02×10 ⁻⁴ | 2.86×10 ⁻¹ |
| IHLW Shipping/Transfer Facility and one IHLW Interim Storage Module | 2011 | 2013 | 200E | 5.68×10 ¹ | 6.72×10 ¹ | 9.81×10 ¹ | 2.18×10 ⁻² | 6.50 |
| IHLW Interim Storage Modules, three additional | 2014 | 2022 | 200E | 4.00×10 ¹ | 4.76×10 ¹ | 1.58×10 ² | 1.45×10 ⁻² | 4.34 |
| Other infrastructure upgrades | 2006 | 2034 | 200EW | 1.11 | 8.05×10 ⁻¹ | 1.13 | 2.54×10 ⁻⁴ | 9.43×10 ⁻² |
| Tank upgrades | 2006 | 2025 | 200EW | 3.49×10 ² | 4.41×10 ¹ | 8.07 | 1.38×10 ⁻² | 1.56×10 ¹ |
| Waste Treatment Plant | 2006 | 2017 | WTP_AS | 7.64×10 ² | 6.20×10 ² | 4.16×10 ² | 1.05 | 7.99×10 ¹ |
| Low-Activity Waste Vitrification Facility expansion | 2008 | 2017 | 200E | 1.85×10 ² | 4.09×10 ¹ | 1.65×10 ² | 2.50×10 ⁻¹ | 1.15×10 ¹ |
| Cesium and Strontium Capsule Processing Facility | 2035 | 2038 | WTP_AS | 8.41×10 ² | 1.22×10 ² | 1.80×10 ¹ | 1.13 | 4.78×10 ¹ |
| Waste receiver facilities | 2013 | 2017 | 200EW | 1.15×10 ² | 9.65×10 ¹ | 3.31×10 ² | 2.92×10 ⁻² | 9.94 |
| Tank risers | 2013 | 2016 | 200EW | 2.01×10 ¹ | 8.94 | 8.10×10 ⁻¹ | 1.88×10 ⁻³ | 2.25 |
| Mobile retrieval system | 2013 | 2043 | 200EW | 8.69×10 ¹ | 3.77×10 ¹ | 7.25 | 1.21×10 ⁻² | 5.75 |
| Vacuum-based retrieval system | 2013 | 2043 | 200EW | 3.24×10 ¹ | 1.46×10 ¹ | 2.94 | 4.66×10 ⁻³ | 2.20 |
| Chemical wash system | 2013 | 2043 | 200EW | 2.19×10 ⁻¹ | 1.17 | 1.46×10 ⁻¹ | 3.66×10 ⁻⁴ | 7.32×10 ⁻² |
| HLW Melter Interim Storage Facility 1 | 2015 | 2016 | WTP_AS | 6.17×10 ⁻¹ | 1.39 | 1.72×10 ¹ | 2.87×10 ⁻⁴ | 6.73×10 ⁻² |
| HLW Melter Interim Storage Facility 2 | 2029 | 2030 | WTP_AS | 6.17×10 ⁻¹ | 1.39 | 1.72×10 ¹ | 2.87×10 ⁻⁴ | 6.73×10 ⁻² |
| Effluent Treatment Facility replacement 1 | 2023 | 2025 | 200E | 1.45×10 ³ | 2.09×10 ² | 9.48×10 ² | 1.96 | 8.25×10 ¹ |
| Effluent Treatment Facility replacement 2 | 2053 | 2055 | 200E | 1.45×10 ³ | 2.09×10 ² | 9.48×10 ² | 1.96 | 8.25×10 ¹ |
| Effluent Treatment Facility replacement 3 | 2083 | 2085 | 200E | 1.45×10 ³ | 2.09×10 ² | 9.48×10 ² | 1.96 | 8.25×10 ¹ |
| Evaporator replacement 1 | 2015 | 2017 | 200E | 4.51×10 ² | 6.53×10 ¹ | 1.76×10 ¹ | 6.07×10 ⁻¹ | 2.56×10 ¹ |
| Immobilized Low-Activity Waste Interim Storage Facilities | 2016 | 2043 | WTP_AS | 1.02 | 4.72 | 4.32×10 ¹ | 1.55×10 ⁻³ | 3.86×10 ⁻¹ |
| HLW Debris Storage Facilities | 2021 | 2090 | 200EW | 3.37×10 ⁻¹ | 1.56 | 1.10×10 ⁻¹ | 5.31×10 ⁻⁴ | 1.28×10 ⁻¹ |
| Underground transfer line 1,000-foot sections | 2009 | 2009 | 200EW+ | 7.59×10 ¹ | 2.71×10 ¹ | 2.41×10 ¹ | 8.75×10 ⁻³ | 4.47 |
| Operations | | | | | | | | |
| IHLW Interim Storage Facility | 2018 | 2066 | 200E | a | a | a | a | a |
| Other infrastructure upgrades | 2006 | 2043 | 200EW | a | a | a | a | a |
| Routine operations | 2006 | 2043 | 200EW | 1.36×10 ¹ | 1.55×10 ¹ | a | a | 5.40 |
| Retrieval operations | 2006 | 2043 | 200EW | 4.72×10 ⁻² | 5.35×10 ⁻² | a | a | 1.89×10 ⁻² |
| Double-shell tank interim stabilization | 2006 | 2043 | 200EW | 3.09×10 ⁻¹ | 3.51×10 ⁻¹ | a | a | 1.24×10 ⁻¹ |

Table G–31. Tank Closure Alternative 6B, Option Case, Criteria Pollutant Emissions (continued)

| Facility/System | Start Year | End Year | Location | Emission Rate (metric tons per year) | | | | |
|---|------------|----------|----------|--------------------------------------|-----------------------|-----------------------|-----------------------|-----------------------|
| | | | | Carbon Monoxide | Nitrogen Dioxide | PM ₁₀ | Sulfur Dioxide | VOCs |
| Operations (continued) | | | | | | | | |
| Waste Treatment Plant | 2018 | 2043 | WTP_PS | 2.36×10 ² | 5.24×10 ² | 9.08 | 2.69×10 ¹ | 8.56×10 ² |
| Waste Treatment Plant, cesium and strontium capsules | 2040 | 2040 | WTP_PS | 2.36×10 ² | 5.24×10 ² | 9.08 | 2.69×10 ¹ | 8.56×10 ² |
| Cesium and Strontium Capsule Processing Facility | 2039 | 2040 | WTP_AS | 4.85×10 ¹ | 1.29 | 5.53×10 ¹ | 6.49×10 ⁻² | 2.34 |
| Mobile retrieval system | 2013 | 2043 | 200EW | 3.99×10 ⁻¹ | 4.53×10 ⁻¹ | a | a | 1.60×10 ⁻¹ |
| Vacuum-based retrieval system | 2013 | 2043 | 200EW | 2.21×10 ⁻¹ | 2.50×10 ⁻¹ | a | a | 8.83×10 ⁻² |
| Chemical wash system | 2013 | 2043 | 200EW | 1.46×10 ⁻¹ | 5.12×10 ⁻¹ | 1.54 | 1.45×10 ⁻⁴ | a |
| HLW Melter Interim Storage Facility | 2018 | 2199 | WTP_AS | a | a | a | a | a |
| Effluent Treatment Facility | 2006 | 2100 | WTP_PS | 9.84 | 2.67 | 9.34×10 ² | 1.33×10 ⁻² | 6.48×10 ⁻¹ |
| Evaporator | 2006 | 2043 | 200E | 1.21×10 ¹ | 5.60×10 ¹ | 1.70×10 ¹ | 1.90×10 ⁻² | 4.57 |
| Borrow Area C | 2006 | 2102 | Area C | 8.52×10 ¹ | 1.12×10 ² | 2.30×10 ² | 1.20×10 ⁻¹ | 1.20×10 ¹ |
| Immobilized Low-Activity Waste Interim Storage Facilities | 2018 | 2199 | WTP_AS | a | a | a | a | a |
| HLW Debris Storage Facilities | 2023 | 2199 | 200EW | a | a | a | a | a |
| Deactivation | | | | | | | | |
| Mobile retrieval system | 2013 | 2043 | 200EW | 4.34×10 ¹ | 3.40 | 2.83×10 ⁻¹ | 1.04×10 ⁻³ | 1.79 |
| Vacuum-based retrieval system | 2013 | 2043 | 200EW | 7.05×10 ⁻¹ | 5.53×10 ⁻² | 5.03×10 ⁻³ | 1.69×10 ⁻⁵ | 2.88×10 ⁻² |
| Chemical wash system | 2013 | 2043 | 200EW | 2.03 | 3.57×10 ⁻¹ | 3.01×10 ⁻² | 1.14×10 ⁻⁴ | 9.62×10 ⁻² |
| IHLW Interim Storage Facility | 2067 | 2067 | WTP_AS | a | a | a | a | a |
| Waste Treatment Plant | 2044 | 2045 | WTP_AS | 2.36×10 ¹ | 5.24×10 ¹ | 9.08×10 ⁻¹ | 2.69 | 8.56×10 ¹ |
| Cesium and Strontium Capsule Processing Facility | 2041 | 2041 | WTP_AS | 2.24×10 ¹ | 5.96×10 ⁻¹ | 2.55×10 ¹ | 3.00×10 ⁻² | 1.08 |
| Effluent Treatment Facility original | 2026 | 2026 | WTP_AS | 1.09×10 ² | 4.78×10 ¹ | 4.70×10 ² | 1.48×10 ⁻¹ | 8.47 |
| Effluent Treatment Facility replacement 1 | 2056 | 2056 | WTP_AS | 1.09×10 ² | 4.78×10 ¹ | 4.70×10 ² | 1.48×10 ⁻¹ | 8.47 |
| Effluent Treatment Facility replacement 2 | 2086 | 2086 | WTP_AS | 1.09×10 ² | 4.78×10 ¹ | 4.70×10 ² | 1.48×10 ⁻¹ | 8.47 |
| Effluent Treatment Facility replacement 3 | 2101 | 2101 | WTP_AS | 1.09×10 ² | 4.78×10 ¹ | 4.70×10 ² | 1.48×10 ⁻¹ | 8.47 |
| Evaporator original | 2018 | 2018 | 200E | 1.66 | 7.70 | 7.07 | 2.62×10 ⁻³ | 6.28×10 ⁻¹ |
| Evaporator replacement | 2044 | 2044 | 200E | 1.66 | 7.70 | 7.07 | 2.62×10 ⁻³ | 6.28×10 ⁻¹ |
| Closure | | | | | | | | |
| Containment structure construction 1 | 2019 | 2022 | 200EW | 1.36×10 ² | 1.41×10 ¹ | 5.48 | 4.38×10 ⁻³ | 5.81 |
| Containment structure construction 2 | 2046 | 2049 | 200EW | 1.36×10 ² | 1.41×10 ¹ | 5.48 | 4.38×10 ⁻³ | 5.81 |
| Containment structure construction 3 | 2073 | 2076 | 200EW | 1.36×10 ² | 1.41×10 ¹ | 5.48 | 4.38×10 ⁻³ | 5.81 |
| Containment structure deactivation 1 | 2043 | 2045 | 200EW | 1.81×10 ² | 1.88×10 ¹ | 6.19 | 5.84×10 ⁻³ | 7.75 |

Table G–31. Tank Closure Alternative 6B, Option Case, Criteria Pollutant Emissions (continued)

| Facility/System | Start Year | End Year | Location | Emission Rate (metric tons per year) | | | | |
|---|------------|----------|----------|--------------------------------------|----------------------|-----------------------|-----------------------|-----------------------|
| | | | | Carbon Monoxide | Nitrogen Dioxide | PM ₁₀ | Sulfur Dioxide | VOCs |
| Closure (continued) | | | | | | | | |
| Containment structure deactivation 2 | 2070 | 2072 | 200EW | 9.03×10 ¹ | 9.39 | 3.09 | 2.92×10 ⁻³ | 3.88 |
| Containment structure deactivation 3 | 2062 | 2064 | 200EW | 9.03×10 ¹ | 9.39 | 3.09 | 2.92×10 ⁻³ | 3.88 |
| Containment structure deactivation 4 | 2089 | 2091 | 200EW | 4.52×10 ¹ | 4.70 | 1.55 | 2.92×10 ⁻¹ | 1.94 |
| Containment structure deactivation 5 | 2097 | 2099 | 200EW | 1.36×10 ² | 1.41×10 ¹ | 4.64 | 8.77×10 ⁻¹ | 5.81 |
| Decontamination and decommissioning of 10 selected facilities | 2018 | 2028 | 200EW | 2.53 | 9.81 | 8.56 | 3.22×10 ⁻³ | 7.93×10 ⁻¹ |
| B tank farm removal | 2023 | 2034 | 200EW | 1.84×10 ¹ | 8.27×10 ¹ | 1.07×10 ¹ | 2.89×10 ⁻² | 6.78 |
| T tank farm removal | 2077 | 2088 | 200EW | 1.84×10 ¹ | 8.27×10 ¹ | 1.07×10 ¹ | 2.89×10 ⁻² | 6.78 |
| BY tank farm removal | 2050 | 2061 | 200EW | 1.38×10 ¹ | 6.20×10 ¹ | 8.04 | 2.17×10 ⁻² | 5.08 |
| BX tank farm removal | 2023 | 2034 | 200EW | 1.38×10 ¹ | 6.20×10 ¹ | 8.04 | 2.17×10 ⁻² | 5.08 |
| C tank farm removal | 2050 | 2061 | 200EW | 1.84×10 ¹ | 8.27×10 ¹ | 1.07×10 ¹ | 2.89×10 ⁻² | 6.78 |
| A tank farm removal | 2077 | 2088 | 200EW | 6.89 | 3.10×10 ¹ | 4.02 | 1.08×10 ⁻² | 2.54 |
| AX tank farm removal | 2077 | 2088 | 200EW | 1.84×10 ¹ | 8.27×10 ¹ | 1.07×10 ¹ | 2.89×10 ⁻² | 6.78 |
| S tank farm removal | 2077 | 2088 | 200EW | 1.38×10 ¹ | 6.20×10 ¹ | 8.04 | 2.17×10 ⁻² | 5.08 |
| TY tank farm removal | 2050 | 2061 | 200EW | 6.89 | 3.10×10 ¹ | 4.02 | 1.08×10 ⁻² | 2.54 |
| TX tank farm removal | 2050 | 2061 | 200EW | 2.07×10 ¹ | 9.31×10 ¹ | 1.21×10 ¹ | 3.25×10 ⁻² | 7.63 |
| U tank farm removal | 2023 | 2034 | 200EW | 1.84×10 ¹ | 8.27×10 ¹ | 1.07×10 ¹ | 2.89×10 ⁻² | 6.78 |
| SX tank farm removal | 2023 | 2034 | 200EW | 1.72×10 ¹ | 7.75×10 ¹ | 1.01×10 ¹ | 2.71×10 ⁻² | 6.35 |
| B tank farm deep soil removal | 2035 | 2042 | 200E | 3.84 | 1.78×10 ¹ | 1.89 | 6.06×10 ⁻³ | 1.46 |
| T tank farm deep soil removal | 2089 | 2096 | 200W | 2.95×10 ¹ | 1.37×10 ² | 1.45×10 ¹ | 4.66×10 ⁻² | 1.12×10 ¹ |
| BX tank farm deep soil removal | 2035 | 2042 | 200E | 1.23×10 ² | 5.71×10 ² | 6.04×10 ¹ | 1.94×10 ⁻¹ | 4.66×10 ¹ |
| C tank farm deep soil removal | 2062 | 2069 | 200E | 2.33×10 ⁻¹ | 1.08 | 1.15×10 ⁻¹ | 3.68×10 ⁻⁴ | 8.82×10 ⁻² |
| A tank farm deep soil removal | 2089 | 2096 | 200E | 6.99×10 ⁻¹ | 3.24 | 3.43×10 ⁻¹ | 1.10×10 ⁻³ | 2.65×10 ⁻¹ |
| AX tank farm deep soil removal | 2089 | 2096 | 200E | 1.16×10 ¹ | 5.41×10 ¹ | 5.72 | 1.84×10 ⁻² | 4.41 |
| TX tank farm deep soil removal | 2062 | 2069 | 200EW | 3.67×10 ¹ | 1.70×10 ² | 1.80×10 ¹ | 5.79×10 ⁻² | 1.39×10 ¹ |
| U tank farm deep soil removal | 2035 | 2042 | 200EW | 1.92×10 ¹ | 8.92×10 ¹ | 9.44 | 3.03×10 ⁻² | 7.28 |
| SX tank farm deep soil removal | 2035 | 2042 | 200W | 4.69×10 ¹ | 2.18×10 ² | 2.31×10 ¹ | 7.40×10 ⁻² | 1.78×10 ¹ |
| B Area cribs and trenches (ditches) removal | 2035 | 2061 | 200EW | 6.21×10 ¹ | 2.88×10 ² | 3.05×10 ¹ | 9.81×10 ⁻² | 2.35×10 ¹ |
| T Area cribs and trenches (ditches) removal | 2062 | 2096 | 200EW | 4.79×10 ¹ | 2.22×10 ² | 2.35×10 ¹ | 7.56×10 ⁻² | 1.82×10 ¹ |
| Containment structure construction 1 | 2029 | 2032 | 200EW | 6.78×10 ¹ | 7.06 | 2.74 | 2.19×10 ⁻³ | 2.91 |
| Containment structure construction 2 | 2056 | 2059 | 200EW | 6.78×10 ¹ | 7.06 | 2.74 | 2.19×10 ⁻³ | 2.91 |

Table G–31. Tank Closure Alternative 6B, Option Case, Criteria Pollutant Emissions (continued)

| Facility/System | Start Year | End Year | Location | Emission Rate (metric tons per year) | | | | |
|--------------------------------------|------------|----------|----------|--------------------------------------|-----------------------|-----------------------|-----------------------|-----------------------|
| | | | | Carbon Monoxide | Nitrogen Dioxide | PM ₁₀ | Sulfur Dioxide | VOCs |
| Closure (continued) | | | | | | | | |
| Containment structure deactivation 1 | 2062 | 2064 | 200EW | 9.03×10 ¹ | 9.39 | 3.09 | 2.92×10 ⁻³ | 3.88 |
| Containment structure deactivation 2 | 2097 | 2099 | 200EW | 9.03×10 ¹ | 9.39 | 3.09 | 2.92×10 ⁻³ | 3.88 |
| Preprocessing Facility construction | 2020 | 2022 | 200E | 1.58×10 ³ | 1.14×10 ³ | 3.41×10 ² | 2.18 | 1.55×10 ² |
| Preprocessing Facility operations | 2023 | 2099 | 200E | 2.07 | 5.55 | 4.99×10 ⁻¹ | 1.25 | 1.89 |
| Preprocessing Facility deactivation | 2100 | 2100 | 200E | 2.07×10 ⁻¹ | 5.55×10 ⁻¹ | 4.99×10 ⁻² | 1.25×10 ⁻¹ | 1.89×10 ⁻¹ |

^a Emissions for this activity and pollutant were not calculated because annual fuel use for this activity and the resulting emissions would be small compared with those of other activities or would be zero.

Key: 200E=200-East Area; 200W=200-West Area; 200EW=200-East and 200-West Areas; 200EW+=200-East and 200-West Areas and Waste Treatment Plant area; HLW=high-level radioactive waste; IHLW=immobilized high-level radioactive waste; PM₁₀=particulate matter with an aerodynamic diameter less than or equal to 10 micrometers; VOC=volatile organic compound; WTP_AS=Waste Treatment Plant area source; WTP_PS=Waste Treatment Plant point source.

Source: SAIC 2007a, 2008.

Table G-32. Tank Closure Alternative 6B, Option Case, Toxic Pollutant Emissions

| Facility/System | Start Year | End Year | Location | Emission Rate (metric tons per year) | | | | | | |
|---|------------|----------|----------|--------------------------------------|-----------------------|-----------------------|-----------------------|---------|-----------------------|-----------------------|
| | | | | Ammonia | Benzene | 1,3-Butadiene | Formaldehyde | Mercury | Toluene | Xylene |
| Construction | | | | | | | | | | |
| Canister Storage Building | 2006 | 2016 | 200E | a | a | a | a | a | a | a |
| IHLW Shipping/Transfer Facility and one IHLW Interim Storage Module | 2011 | 2013 | 200E | a | a | a | a | a | a | a |
| IHLW Interim Storage Modules, three additional | 2014 | 2022 | 200E | a | a | a | a | a | a | a |
| Other infrastructure upgrades | 2006 | 2034 | 200EW | a | a | a | a | a | a | a |
| Tank upgrades | 2006 | 2025 | 200EW | 7.82×10 ⁻² | a | a | a | a | a | a |
| Waste Treatment Plant | 2006 | 2017 | WTP_AS | 9.98×10 ⁻¹ | 2.09×10 ⁻¹ | 5.81×10 ⁻³ | 1.89×10 ⁻¹ | a | 1.31 | 3.93×10 ⁻¹ |
| Low-Activity Waste Vitrification Facility expansion | 2008 | 2017 | 200E | 7.08×10 ⁻² | 3.05×10 ⁻² | 4.50×10 ⁻⁴ | 1.74×10 ⁻² | a | 3.54×10 ⁻¹ | 1.01×10 ⁻¹ |
| Cesium and Strontium Capsule Processing Facility | 2035 | 2038 | WTP_AS | 2.22×10 ⁻¹ | 1.27×10 ⁻¹ | 1.49×10 ⁻³ | 6.26×10 ⁻² | a | 1.63 | 4.64×10 ⁻¹ |
| Waste receiver facilities | 2013 | 2017 | 200EW | a | a | a | a | a | a | a |
| Tank risers | 2013 | 2016 | 200EW | 2.38 | a | a | a | a | a | a |
| Mobile retrieval system | 2013 | 2043 | 200EW | 3.46×10 ⁻¹ | a | a | a | a | a | a |
| Vacuum-based retrieval system | 2013 | 2043 | 200EW | 1.91×10 ⁻¹ | a | a | a | a | a | a |
| Chemical wash system | 2013 | 2043 | 200EW | 5.37×10 ⁻³ | a | a | a | a | a | a |
| HLW Melter Interim Storage Facility 1 | 2015 | 2016 | WTP_AS | a | a | a | a | a | a | a |
| HLW Melter Interim Storage Facility 2 | 2029 | 2030 | WTP_AS | a | a | a | a | a | a | a |
| Effluent Treatment Facility replacement 1 | 2023 | 2025 | 200E | 3.81×10 ⁻¹ | 2.19×10 ⁻¹ | 2.55×10 ⁻³ | 1.08×10 ⁻¹ | a | 2.82 | 8.02×10 ⁻¹ |
| Effluent Treatment Facility replacement 2 | 2053 | 2055 | 200E | 3.81×10 ⁻¹ | 2.19×10 ⁻¹ | 2.55×10 ⁻³ | 1.08×10 ⁻¹ | a | 2.82 | 8.02×10 ⁻¹ |
| Effluent Treatment Facility replacement 3 | 2083 | 2085 | 200E | 3.81×10 ⁻¹ | 2.19×10 ⁻¹ | 2.55×10 ⁻³ | 1.08×10 ⁻¹ | a | 2.82 | 8.02×10 ⁻¹ |
| Evaporator replacement 1 | 2015 | 2017 | 200E | 1.19×10 ⁻¹ | 6.80×10 ⁻² | 7.95×10 ⁻⁴ | 3.35×10 ⁻² | a | 8.74×10 ⁻¹ | 2.49×10 ⁻¹ |
| Immobilized Low-Activity Waste Interim Storage Facilities | 2016 | 2043 | WTP_AS | 7.42×10 ⁻³ | 9.99×10 ⁻⁴ | a | a | a | 4.38×10 ⁻⁴ | 3.06×10 ⁻⁴ |
| HLW Debris Storage Facilities | 2021 | 2090 | 200EW | 2.46×10 ⁻³ | 3.31×10 ⁻⁴ | 1.39×10 ⁻⁵ | 4.18×10 ⁻⁴ | a | 1.45×10 ⁻⁴ | 1.01×10 ⁻⁴ |
| Underground transfer line 1,000-foot sections | 2009 | 2009 | 200EW+ | a | a | a | a | a | a | a |

Table G–32. Tank Closure Alternative 6B, Option Case, Toxic Pollutant Emissions (continued)

| Facility/System | Start Year | End Year | Location | Emission Rate (metric tons per year) | | | | | | |
|---|------------|----------|----------|--------------------------------------|-----------------------|-----------------------|-----------------------|-----------------------|-----------------------|-----------------------|
| | | | | Ammonia | Benzene | 1,3-Butadiene | Formaldehyde | Mercury | Toluene | Xylene |
| Operations | | | | | | | | | | |
| IHLW Interim Storage Facility | 2018 | 2066 | 200E | a | a | a | a | a | a | a |
| Other infrastructure upgrades | 2006 | 2043 | 200EW | a | a | a | a | a | a | a |
| Routine operations | 2006 | 2043 | 200EW | 1.18×10 ¹ | a | a | a | a | a | a |
| Retrieval operations | 2006 | 2043 | 200EW | 4.09×10 ⁻² | a | a | a | a | a | a |
| Double-shell tank interim stabilization | 2006 | 2043 | 200EW | 2.68×10 ⁻¹ | a | a | a | a | a | a |
| Waste Treatment Plant | 2018 | 2043 | WTP_PS | 3.53 | 2.23×10 ⁻² | 8.05×10 ⁻⁶ | 2.49×10 ⁻⁴ | 6.97×10 ⁻² | 6.27×10 ⁻⁴ | 2.11×10 ⁻³ |
| Waste Treatment Plant, cesium and strontium capsules | 2040 | 2040 | WTP_PS | 3.53 | 2.23×10 ⁻² | 8.05×10 ⁻⁶ | 2.49×10 ⁻⁴ | a | 6.27×10 ⁻⁴ | 2.11×10 ⁻³ |
| Cesium and Strontium Capsule Processing Facility | 2039 | 2040 | WTP_AS | 3.80×10 ⁻³ | 6.24×10 ⁻³ | 3.53×10 ⁻⁵ | 2.11×10 ⁻³ | a | 9.58×10 ⁻² | 2.70×10 ⁻² |
| Mobile retrieval system | 2013 | 2043 | 200EW | 3.46×10 ⁻¹ | a | a | a | a | a | a |
| Vacuum-based retrieval system | 2013 | 2043 | 200EW | 1.91×10 ⁻¹ | a | a | a | a | a | a |
| Chemical wash system | 2013 | 2043 | 200EW | 5.37×10 ⁻³ | a | a | a | a | a | a |
| HLW Melter Interim Storage Facility | 2018 | 2199 | WTP_AS | a | a | a | a | a | a | a |
| Effluent Treatment Facility | 2006 | 2100 | WTP_PS | 1.44 | 1.71×10 ⁻³ | 2.83×10 ⁻⁵ | 1.05×10 ⁻³ | a | 1.86×10 ⁻² | 5.35×10 ⁻³ |
| Evaporator | 2006 | 2043 | 200E | 8.80×10 ⁻² | 1.18×10 ⁻² | 4.96×10 ⁻⁴ | 1.50×10 ⁻² | a | 5.19×10 ⁻³ | 3.62×10 ⁻³ |
| Borrow Area C | 2006 | 2102 | Area C | 1.78×10 ⁻¹ | 3.12×10 ⁻² | 1.02×10 ⁻³ | 3.21×10 ⁻² | a | 1.32×10 ⁻¹ | 4.15×10 ⁻² |
| Immobilized Low-Activity Waste Interim Storage Facilities | 2018 | 2199 | WTP_AS | a | a | a | a | a | a | a |
| HLW Debris Storage Facilities | 2023 | 2199 | 200EW | a | a | a | a | a | a | a |
| Deactivation | | | | | | | | | | |
| Mobile retrieval system | 2013 | 2043 | 200EW | a | a | a | a | a | a | a |
| Vacuum-based retrieval system | 2013 | 2043 | 200EW | a | a | a | a | a | a | a |
| Chemical wash system | 2013 | 2043 | 200EW | a | a | a | a | a | a | a |
| IHLW Interim Storage Facility | 2067 | 2067 | WTP_AS | a | a | a | a | a | a | a |
| Waste Treatment Plant | 2044 | 2045 | WTP_AS | 3.53×10 ⁻¹ | 2.23×10 ⁻³ | 8.05×10 ⁻⁷ | 2.49×10 ⁻⁵ | 9.06×10 ⁻² | 6.27×10 ⁻⁵ | 2.11×10 ⁻⁴ |
| Cesium and Strontium Capsule Processing Facility | 2041 | 2041 | WTP_AS | 1.75×10 ⁻³ | 2.88×10 ⁻³ | 1.63×10 ⁻⁵ | 9.76×10 ⁻⁴ | a | 4.42×10 ⁻² | 1.25×10 ⁻² |
| Effluent Treatment Facility original | 2026 | 2026 | WTP_AS | 7.88×10 ⁻² | 2.23×10 ⁻² | 4.73×10 ⁻⁴ | 1.64×10 ⁻² | a | 2.00×10 ⁻¹ | 5.81×10 ⁻² |
| Effluent Treatment Facility replacement 1 | 2056 | 2056 | WTP_AS | 7.88×10 ⁻² | 2.23×10 ⁻² | 4.73×10 ⁻⁴ | 1.64×10 ⁻² | a | 2.00×10 ⁻¹ | 5.81×10 ⁻² |

Table G–32. Tank Closure Alternative 6B, Option Case, Toxic Pollutant Emissions (continued)

| Facility/System | Start Year | End Year | Location | Emission Rate (metric tons per year) | | | | | | |
|---|------------|----------|----------|--------------------------------------|-----------------------|-----------------------|-----------------------|---------|-----------------------|-----------------------|
| | | | | Ammonia | Benzene | 1,3-Butadiene | Formaldehyde | Mercury | Toluene | Xylene |
| Deactivation (continued) | | | | | | | | | | |
| Effluent Treatment Facility replacement 2 | 2086 | 2086 | WTP_AS | 7.88×10 ⁻² | 2.23×10 ⁻² | 4.73×10 ⁻⁴ | 1.64×10 ⁻² | a | 2.00×10 ⁻¹ | 5.81×10 ⁻² |
| Effluent Treatment Facility replacement 3 | 2101 | 2101 | WTP_AS | 7.88×10 ⁻² | 2.23×10 ⁻² | 4.73×10 ⁻⁴ | 1.64×10 ⁻² | a | 2.00×10 ⁻¹ | 5.81×10 ⁻² |
| Evaporator original | 2018 | 2018 | 200E | 1.21×10 ⁻² | 1.63×10 ⁻³ | 6.82×10 ⁻⁵ | 2.06×10 ⁻³ | a | 7.14×10 ⁻⁴ | 4.97×10 ⁻⁴ |
| Evaporator replacement | 2044 | 2044 | 200E | 1.21×10 ⁻² | 1.63×10 ⁻³ | 6.82×10 ⁻⁵ | 2.06×10 ⁻³ | a | 7.14×10 ⁻⁴ | 4.97×10 ⁻⁴ |
| Closure | | | | | | | | | | |
| Containment structure construction 1 | 2019 | 2022 | 200EW | a | a | a | a | a | a | a |
| Containment structure construction 2 | 2046 | 2049 | 200EW | a | a | a | a | a | a | a |
| Containment structure construction 3 | 2073 | 2076 | 200EW | a | a | a | a | a | a | a |
| Containment structure deactivation 1 | 2043 | 2045 | 200EW | a | a | a | a | a | a | a |
| Containment structure deactivation 2 | 2070 | 2072 | 200EW | a | a | a | a | a | a | a |
| Containment structure deactivation 3 | 2062 | 2064 | 200EW | a | a | a | a | a | a | a |
| Containment structure deactivation 4 | 2089 | 2091 | 200EW | a | a | a | a | a | a | a |
| Containment structure deactivation 5 | 2097 | 2099 | 200EW | a | a | a | a | a | a | a |
| Decontamination and decommissioning of 10 selected facilities | 2018 | 2028 | 200EW | a | a | a | a | a | a | a |
| B tank farm removal | 2023 | 2034 | 200EW | 1.30×10 ⁻¹ | 1.76×10 ⁻² | 7.34×10 ⁻⁴ | 2.22×10 ⁻² | a | 8.77×10 ⁻³ | 5.65×10 ⁻³ |
| T tank farm removal | 2077 | 2088 | 200EW | 1.30×10 ⁻¹ | 1.76×10 ⁻² | 7.34×10 ⁻⁴ | 2.22×10 ⁻² | a | 8.77×10 ⁻³ | 5.65×10 ⁻³ |
| BY tank farm removal | 2050 | 2061 | 200EW | 9.76×10 ⁻² | 1.32×10 ⁻² | 5.50×10 ⁻⁴ | 1.66×10 ⁻² | a | 6.58×10 ⁻³ | 4.24×10 ⁻³ |
| BX tank farm removal | 2023 | 2034 | 200EW | 9.76×10 ⁻² | 1.32×10 ⁻² | 5.50×10 ⁻⁴ | 1.66×10 ⁻² | a | 6.58×10 ⁻³ | 4.24×10 ⁻³ |
| C tank farm removal | 2050 | 2061 | 200EW | 1.30×10 ⁻¹ | 1.76×10 ⁻² | 7.34×10 ⁻⁴ | 2.22×10 ⁻² | a | 8.77×10 ⁻³ | 5.65×10 ⁻³ |
| A tank farm removal | 2077 | 2088 | 200EW | 4.88×10 ⁻² | 6.59×10 ⁻³ | 2.75×10 ⁻⁴ | 8.31×10 ⁻³ | a | 3.29×10 ⁻³ | 2.12×10 ⁻³ |
| AX tank farm removal | 2077 | 2088 | 200EW | 1.30×10 ⁻¹ | 1.76×10 ⁻² | 7.34×10 ⁻⁴ | 2.22×10 ⁻² | a | 8.77×10 ⁻³ | 5.65×10 ⁻³ |
| S tank farm removal | 2077 | 2088 | 200EW | 9.76×10 ⁻² | 1.32×10 ⁻² | 5.50×10 ⁻⁴ | 1.66×10 ⁻² | a | 6.58×10 ⁻³ | 4.24×10 ⁻³ |
| TY tank farm removal | 2050 | 2061 | 200EW | 4.88×10 ⁻² | 6.59×10 ⁻³ | 2.75×10 ⁻⁴ | 8.31×10 ⁻³ | a | 3.29×10 ⁻³ | 2.12×10 ⁻³ |
| TX tank farm removal | 2050 | 2061 | 200EW | 1.46×10 ⁻¹ | 1.98×10 ⁻² | 8.25×10 ⁻⁴ | 2.49×10 ⁻² | a | 9.86×10 ⁻³ | 6.36×10 ⁻³ |
| U tank farm removal | 2023 | 2034 | 200EW | 1.30×10 ⁻¹ | 1.76×10 ⁻² | 7.34×10 ⁻⁴ | 2.22×10 ⁻² | a | 8.77×10 ⁻³ | 5.65×10 ⁻³ |
| SX tank farm removal | 2023 | 2034 | 200EW | 1.22×10 ⁻¹ | 1.65×10 ⁻² | 6.88×10 ⁻⁴ | 2.08×10 ⁻² | a | 8.22×10 ⁻³ | 5.30×10 ⁻³ |
| B tank farm deep soil removal | 2035 | 2042 | 200E | 2.80×10 ⁻² | 3.77×10 ⁻³ | 1.58×10 ⁻⁴ | 4.77×10 ⁻³ | a | 1.65×10 ⁻³ | 1.15×10 ⁻³ |
| T tank farm deep soil removal | 2089 | 2096 | 200W | 2.15×10 ⁻¹ | 2.90×10 ⁻² | 1.21×10 ⁻³ | 3.67×10 ⁻² | a | 1.27×10 ⁻² | 8.85×10 ⁻³ |
| BX tank farm deep soil removal | 2035 | 2042 | 200E | 8.97×10 ⁻¹ | 1.21×10 ⁻¹ | 5.06×10 ⁻³ | 1.53×10 ⁻¹ | a | 5.29×10 ⁻² | 3.69×10 ⁻² |

Table G–32. Tank Closure Alternative 6B, Option Case, Toxic Pollutant Emissions (continued)

| Facility/System | Start Year | End Year | Location | Emission Rate (metric tons per year) | | | | | | |
|---|------------|----------|----------|--------------------------------------|-----------------------|------------------------|-----------------------|---------|-----------------------|-----------------------|
| | | | | Ammonia | Benzene | 1,3-Butadiene | Formaldehyde | Mercury | Toluene | Xylene |
| Closure (continued) | | | | | | | | | | |
| C tank farm deep soil removal | 2062 | 2069 | 200E | 1.70×10 ⁻³ | 2.29×10 ⁻⁴ | 9.58×10 ⁻⁶ | 2.89×10 ⁻⁴ | a | 1.00×10 ⁻⁴ | 6.99×10 ⁻⁵ |
| A tank farm deep soil removal | 2089 | 2096 | 200E | 5.10×10 ⁻³ | 6.86×10 ⁻⁴ | 2.88×10 ⁻⁵ | 8.68×10 ⁻⁴ | a | 3.01×10 ⁻⁴ | 2.10×10 ⁻⁴ |
| AX tank farm deep soil removal | 2089 | 2096 | 200E | 8.50×10 ⁻² | 1.14×10 ⁻² | 4.79×10 ⁻⁴ | 1.45×10 ⁻² | a | 5.01×10 ⁻³ | 3.49×10 ⁻³ |
| TX tank farm deep soil removal | 2062 | 2069 | 200EW | 2.68×10 ⁻¹ | 3.60×10 ⁻² | 1.51×10 ⁻³ | 4.56×10 ⁻² | a | 1.58×10 ⁻² | 1.10×10 ⁻² |
| U tank farm deep soil removal | 2035 | 2042 | 200EW | 1.40×10 ⁻¹ | 1.89×10 ⁻² | 7.91×10 ⁻⁴ | 2.39×10 ⁻² | a | 8.27×10 ⁻³ | 5.76×10 ⁻³ |
| SX tank farm deep soil removal | 2035 | 2042 | 200W | 3.42×10 ⁻¹ | 4.61×10 ⁻² | 1.93×10 ⁻³ | 5.83×10 ⁻² | a | 2.02×10 ⁻² | 1.41×10 ⁻² |
| B Area cribs and trenches (ditches) removal | 2035 | 2061 | 200EW | 4.53×10 ⁻¹ | 6.10×10 ⁻² | 2.56×10 ⁻³ | 7.71×10 ⁻² | a | 2.67×10 ⁻² | 1.86×10 ⁻² |
| T Area cribs and trenches (ditches) removal | 2062 | 2096 | 200EW | 3.50×10 ⁻¹ | 4.70×10 ⁻² | 1.97×10 ⁻³ | 5.95×10 ⁻² | a | 2.06×10 ⁻² | 1.44×10 ⁻² |
| Containment structure construction 1 | 2029 | 2032 | 200EW | a | a | a | a | a | a | a |
| Containment structure construction 2 | 2056 | 2059 | 200EW | a | a | a | a | a | a | a |
| Containment structure deactivation 1 | 2062 | 2064 | 200EW | a | a | a | a | a | a | a |
| Containment structure deactivation 2 | 2097 | 2099 | 200EW | a | a | a | a | a | a | a |
| Preprocessing Facility construction | 2020 | 2022 | 200E | 1.85 | 4.07×10 ⁻¹ | 1.08×10 ⁻² | 3.55×10 ⁻¹ | a | 2.76 | 8.22×10 ⁻¹ |
| Preprocessing Facility operations | 2023 | 2099 | 200E | 8.82×10 ⁻⁴ | 5.04×10 ⁻⁵ | 3.09×10 ⁻⁹ | 1.77×10 ⁻⁷ | a | 7.62×10 ⁻⁶ | 2.15×10 ⁻⁵ |
| Preprocessing Facility deactivation | 2100 | 2100 | 200E | 8.82×10 ⁻⁵ | 5.04×10 ⁻⁶ | 3.09×10 ⁻¹⁰ | 1.77×10 ⁻⁸ | a | 7.62×10 ⁻⁷ | 2.15×10 ⁻⁶ |

^a Emissions for this activity and pollutant were not calculated because annual fuel use for this activity and the resulting emissions would be small compared with those of other activities or would be zero.

Key: 200E=200-East Area; 200W=200-West Area; 200EW=200-East and 200-West Areas; 200EW+=200-East and 200-West Areas and Waste Treatment Plant area; HLW=high-level radioactive waste; IHLW=immobilized high-level radioactive waste; WTP_AS=Waste Treatment Plant area source; WTP_PS=Waste Treatment Plant point source.

Source: SAIC 2007a, 2008.

Table G-33. Tank Closure Alternative 6C Criteria Pollutant Emissions

| Facility/System | Start Year | End Year | Location | Emission Rate (metric tons per year) | | | | |
|---|------------|----------|----------|--------------------------------------|-----------------------|-----------------------|-----------------------|-----------------------|
| | | | | Carbon Monoxide | Nitrogen Dioxide | PM ₁₀ | Sulfur Dioxide | VOCs |
| Construction | | | | | | | | |
| Canister Storage Building | 2006 | 2016 | 200E | 5.54 | 2.86×10 ⁻¹ | 9.05×10 ⁻¹ | 4.02×10 ⁻⁴ | 2.86×10 ⁻¹ |
| IHLW Shipping/Transfer Facility | 2011 | 2013 | 200E | 5.68×10 ¹ | 6.72×10 ¹ | 9.81×10 ¹ | 2.18×10 ⁻² | 6.50 |
| IHLW Interim Storage Modules | 2014 | 2022 | 200E | 4.00×10 ¹ | 4.76×10 ¹ | 1.58×10 ² | 1.45×10 ⁻² | 4.34 |
| Other infrastructure upgrades | 2006 | 2034 | 200EW | 1.11 | 8.05×10 ⁻¹ | 1.13 | 2.54×10 ⁻⁴ | 9.43×10 ⁻² |
| Tank upgrades | 2006 | 2025 | 200EW | 3.49×10 ² | 4.41×10 ¹ | 8.07 | 1.38×10 ⁻² | 1.56×10 ¹ |
| Waste Treatment Plant | 2006 | 2017 | WTP_AS | 7.64×10 ² | 6.20×10 ² | 4.16×10 ² | 1.05 | 7.99×10 ¹ |
| Underground transfer line 1,000-foot sections | 2009 | 2009 | 200EW+ | 7.59×10 ¹ | 2.71×10 ¹ | 2.41×10 ¹ | 8.75×10 ⁻³ | 4.47 |
| Low-Activity Waste Vitrification Facility expansion | 2008 | 2017 | 200E | 1.85×10 ² | 4.09×10 ¹ | 1.65×10 ² | 2.50×10 ⁻¹ | 1.15×10 ¹ |
| Cesium and Strontium Capsule Processing Facility | 2035 | 2038 | WTP_AS | 8.41×10 ² | 1.22×10 ² | 1.80×10 ¹ | 1.13 | 4.78×10 ¹ |
| Waste receiver facilities | 2013 | 2017 | 200EW | 1.15×10 ² | 9.65×10 ¹ | 3.31×10 ² | 2.92×10 ⁻² | 9.94 |
| Tank risers | 2013 | 2016 | 200EW | 1.84×10 ¹ | 8.19 | 7.42×10 ⁻¹ | 1.72×10 ⁻³ | 2.06 |
| Modified sluicing retrieval system | 2013 | 2043 | 200EW | 6.69×10 ¹ | 2.58 | 1.43 | 6.19×10 ⁻⁴ | 2.62 |
| Mobile retrieval system | 2013 | 2028 | 200EW | 6.27×10 ¹ | 2.72×10 ¹ | 5.24 | 8.72×10 ⁻³ | 4.15 |
| Vacuum-based retrieval system | 2029 | 2043 | 200EW | 6.69×10 ¹ | 3.03×10 ¹ | 6.08 | 9.64×10 ⁻³ | 4.55 |
| HLW Melter Interim Storage Facility 1 | 2015 | 2016 | WTP_AS | 6.17×10 ⁻¹ | 1.39 | 1.72×10 ¹ | 2.87×10 ⁻⁴ | 6.73×10 ⁻² |
| HLW Melter Interim Storage Facility 2 | 2029 | 2030 | WTP_AS | 6.17×10 ⁻¹ | 1.39 | 1.72×10 ¹ | 2.87×10 ⁻⁴ | 6.73×10 ⁻² |
| Effluent Treatment Facility replacement 1 | 2023 | 2025 | 200E | 1.45×10 ³ | 2.09×10 ² | 9.48×10 ² | 1.96 | 8.25×10 ¹ |
| Evaporator replacement 1 | 2015 | 2017 | 200E | 8.47×10 ¹ | 1.59×10 ¹ | 1.42×10 ¹ | 1.14×10 ⁻¹ | 5.07 |
| Immobilized Low-Activity Waste Interim Storage Facilities | 2016 | 2043 | WTP_AS | 1.02 | 4.72 | 4.32×10 ¹ | 1.55×10 ⁻³ | 3.86×10 ⁻¹ |
| Operations | | | | | | | | |
| IHLW Interim Storage Facility | 2018 | 2066 | 200E | a | a | a | a | a |
| Other infrastructure upgrades | 2006 | 2043 | 200EW | a | a | a | a | a |
| Routine operations | 2006 | 2043 | 200EW | 1.36×10 ¹ | 1.55×10 ¹ | a | a | 5.40 |
| Retrieval operations | 2006 | 2043 | 200EW | 4.72×10 ⁻² | 5.35×10 ⁻² | a | a | 1.89×10 ⁻² |
| Double-shell tank interim stabilization | 2006 | 2043 | 200EW | 3.09×10 ⁻¹ | 3.51×10 ⁻¹ | a | a | 1.24×10 ⁻¹ |
| Waste Treatment Plant | 2018 | 2043 | WTP_PS | 2.36×10 ² | 5.24×10 ² | 9.08 | 2.69×10 ¹ | 8.56×10 ² |
| Waste Treatment Plant, cesium and strontium capsules | 2040 | 2040 | WTP_PS | 2.36×10 ² | 5.24×10 ² | 9.08 | 2.69×10 ¹ | 8.56×10 ² |
| Cesium and Strontium Capsule Processing Facility | 2039 | 2040 | WTP_AS | 4.85×10 ¹ | 1.29 | 5.53×10 ¹ | 6.49×10 ⁻² | 2.34 |
| Modified sluicing retrieval system | 2013 | 2043 | 200EW | 1.86×10 ¹ | 1.15 | 8.87×10 ⁻² | 2.96×10 ⁻⁴ | 7.98×10 ⁻¹ |

Table G-33. Tank Closure Alternative 6C Criteria Pollutant Emissions (continued)

| Facility/System | Start Year | End Year | Location | Emission Rate (metric tons per year) | | | | |
|---|------------|----------|----------|--------------------------------------|-----------------------|-----------------------|-----------------------|-----------------------|
| | | | | Carbon Monoxide | Nitrogen Dioxide | PM ₁₀ | Sulfur Dioxide | VOCs |
| Operations (continued) | | | | | | | | |
| Mobile retrieval system | 2013 | 2028 | 200EW | 2.88×10 ⁻¹ | 3.27×10 ⁻¹ | a | a | 1.15×10 ⁻¹ |
| Vacuum-based retrieval system | 2029 | 2043 | 200EW | 4.56×10 ⁻¹ | 5.17×10 ⁻¹ | a | a | 1.82×10 ⁻¹ |
| HLW Melter Interim Storage Facility | 2018 | 2145 | WTP_AS | a | a | a | a | a |
| Effluent Treatment Facility | 2006 | 2045 | WTP_PS | 9.84 | 2.67 | 9.34×10 ² | 1.33×10 ⁻² | 6.48×10 ⁻¹ |
| Evaporator | 2006 | 2043 | 200E | 1.23×10 ¹ | 5.70×10 ¹ | 1.71×10 ¹ | 1.94×10 ⁻² | 4.66 |
| Borrow Area C | 2006 | 2052 | Area C | 8.52×10 ¹ | 1.12×10 ² | 2.30×10 ² | 1.20×10 ⁻¹ | 1.20×10 ¹ |
| Immobilized Low-Activity Waste Interim Storage Facility | 2018 | 2145 | WTP_AS | a | a | a | a | a |
| Deactivation | | | | | | | | |
| IHLW Interim Storage Facility | 2067 | 2067 | WTP_AS | a | a | a | a | a |
| Waste Treatment Plant | 2044 | 2045 | WTP_AS | 2.36×10 ¹ | 5.24×10 ¹ | 9.08×10 ⁻¹ | 2.69 | 8.56×10 ¹ |
| Cesium and Strontium Capsule Processing Facility | 2041 | 2041 | WTP_AS | 2.24×10 ¹ | 5.96×10 ⁻¹ | 2.55×10 ¹ | 3.00×10 ⁻² | 1.08 |
| Effluent Treatment Facility original | 2026 | 2026 | WTP_AS | 1.09×10 ² | 4.78×10 ¹ | 4.70×10 ² | 1.48×10 ⁻¹ | 8.47 |
| Effluent Treatment Facility replacement 1 | 2046 | 2046 | WTP_AS | 1.09×10 ² | 4.78×10 ¹ | 4.70×10 ² | 1.48×10 ⁻¹ | 8.47 |
| Evaporator original | 2018 | 2018 | 200E | 1.66 | 7.70 | 7.07 | 2.62×10 ⁻³ | 6.28×10 ⁻¹ |
| Evaporator replacement 1 | 2044 | 2044 | 200E | 1.66 | 7.70 | 7.07 | 2.62×10 ⁻³ | 6.28×10 ⁻¹ |
| Modified sluicing retrieval system | 2013 | 2043 | 200EW | 4.76×10 ¹ | 2.01 | 1.77×10 ⁻¹ | 5.91×10 ⁻⁴ | 1.83 |
| Mobile retrieval system | 2013 | 2028 | 200EW | 3.13×10 ¹ | 2.45 | 2.04×10 ⁻¹ | 7.50×10 ⁻⁴ | 1.29 |
| Vacuum-based retrieval system | 2029 | 2043 | 200EW | 1.46 | 1.14×10 ⁻¹ | 1.04×10 ⁻² | 3.49×10 ⁻⁵ | 5.96×10 ⁻² |
| Closure | | | | | | | | |
| Ancillary equipment grouting | 2013 | 2037 | 200EW | 3.46×10 ⁻¹ | 1.50 | 1.63 | 4.82×10 ⁻⁴ | 1.16×10 ⁻¹ |
| Ancillary equipment removal | 2032 | 2037 | 200EW | 3.28 | 1.50×10 ¹ | 4.40×10 ¹ | 4.92×10 ⁻³ | 1.19 |
| Decontamination and decommissioning of 10 selected facilities | 2018 | 2028 | 200EW | 2.53 | 9.81 | 8.56 | 3.22×10 ⁻³ | 7.93×10 ⁻¹ |
| Grout facility (tank-filling) construction | 2032 | 2033 | 200EW | 2.18 | 8.29 | 4.20 | 2.71×10 ⁻³ | 6.82×10 ⁻¹ |
| Grout facility (tank-filling) operations | 2034 | 2043 | 200EW | 2.25×10 ¹ | 8.32×10 ¹ | 4.51×10 ¹ | 2.70×10 ⁻² | 6.68 |
| Grout facility (tank-filling) deactivation | 2044 | 2044 | 200EW | 1.45 | 3.41 | 2.10×10 ¹ | 1.12×10 ⁻³ | 2.95×10 ⁻¹ |
| Containment structure construction | 2028 | 2031 | 200EW | 6.78×10 ¹ | 7.06 | 2.74 | 2.19×10 ⁻³ | 2.91 |
| BX and SX tank farm deep soil removal | 2032 | 2037 | 200EW | 3.99×10 ¹ | 1.13×10 ² | 2.56×10 ² | 3.73×10 ⁻² | 9.55 |

Table G-33. Tank Closure Alternative 6C Criteria Pollutant Emissions (*continued*)

| Facility/System | Start Year | End Year | Location | Emission Rate (metric tons per year) | | | | |
|---|------------|----------|----------|--------------------------------------|----------------------|----------------------|-----------------------|----------------------|
| | | | | Carbon Monoxide | Nitrogen Dioxide | PM ₁₀ | Sulfur Dioxide | VOCs |
| Closure (<i>continued</i>) | | | | | | | | |
| Containment structure deactivation | 2038 | 2040 | 200EW | 9.03×10 ¹ | 9.39 | 3.09 | 2.92×10 ⁻³ | 3.88 |
| Modified Resource Conservation and Recovery Act Subtitle C barrier construction | 2039 | 2045 | 200EW | 1.64×10 ³ | 1.50×10 ³ | 3.48×10 ³ | 2.27 | 1.83×10 ² |
| Postclosure care | 2046 | 2145 | 200EW | a | a | a | a | a |

^a Emissions for this activity and pollutant were not calculated because annual fuel use for this activity and the resulting emissions would be small compared with those of other activities or would be zero.

Key: 200E=200-East Area; 200EW=200-East and 200-West Areas; 200EW+=200-East and 200-West Areas and Waste Treatment Plant area; HLW=high-level radioactive waste; IHLW=immobilized high-level radioactive waste; PM₁₀=particulate matter with an aerodynamic diameter less than or equal to 10 micrometers; VOC=volatile organic compound; WTP_AS=Waste Treatment Plant area source; WTP_PS=Waste Treatment Plant point source.

Source: SAIC 2007a, 2008.

Table G-34. Tank Closure Alternative 6C Toxic Pollutant Emissions

| Facility/System | Start Year | End Year | Location | Emission Rate (metric tons per year) | | | | | | |
|---|------------|----------|----------|--------------------------------------|-----------------------|-----------------------|-----------------------|-----------------------|-----------------------|-----------------------|
| | | | | Ammonia | Benzene | 1,3-Butadiene | Formaldehyde | Mercury | Toluene | Xylene |
| Construction | | | | | | | | | | |
| Canister Storage Building | 2006 | 2016 | 200E | a | a | a | a | a | a | a |
| IHLW Shipping/Transfer Facility | 2011 | 2013 | 200E | a | a | a | a | a | a | a |
| IHLW Interim Storage Modules | 2014 | 2022 | 200E | a | a | a | a | a | a | a |
| Other infrastructure upgrades | 2006 | 2034 | 200EW | a | a | a | a | a | a | a |
| Tank upgrades | 2006 | 2025 | 200EW | 7.82×10^{-2} | a | a | a | a | a | a |
| Waste Treatment Plant | 2006 | 2017 | WTP_AS | 9.98×10^{-1} | 2.09×10^{-1} | 5.81×10^{-3} | 1.89×10^{-1} | a | 3.93×10^{-1} | 3.93×10^{-1} |
| Underground transfer line 1,000-foot sections | 2009 | 2009 | 200EW+ | a | a | a | a | a | a | a |
| Low-Activity Waste Vitrification Facility expansion | 2008 | 2017 | 200E | 7.08×10^{-2} | 3.05×10^{-2} | 4.50×10^{-4} | 1.74×10^{-2} | a | 3.54×10^{-1} | 1.01×10^{-1} |
| Cesium and Strontium Capsule Processing Facility | 2035 | 2038 | WTP_AS | 2.22×10^{-1} | 1.27×10^{-1} | 1.49×10^{-3} | 6.26×10^{-2} | a | 1.63 | 4.64×10^{-1} |
| Waste receiver facilities | 2013 | 2017 | 200EW | a | a | a | a | a | a | a |
| Tank risers | 2013 | 2016 | 200EW | 2.18 | a | a | a | a | a | a |
| Modified sluicing retrieval system | 2013 | 2043 | 200EW | 2.17×10^{-1} | a | a | a | a | a | a |
| Mobile retrieval system | 2013 | 2028 | 200EW | 2.50×10^{-1} | a | a | a | a | a | a |
| Vacuum-based retrieval system | 2029 | 2043 | 200EW | 3.95×10^{-1} | a | a | a | a | a | a |
| HLW Melter Interim Storage Facility 1 | 2015 | 2016 | WTP_AS | a | a | a | a | a | a | a |
| HLW Melter Interim Storage Facility 2 | 2029 | 2030 | WTP_AS | a | a | a | a | a | a | a |
| Effluent Treatment Facility replacement 1 | 2023 | 2025 | 200E | 3.81×10^{-1} | 2.19×10^{-1} | 2.55×10^{-3} | 1.08×10^{-1} | a | 2.82 | 8.02×10^{-1} |
| Evaporator replacement 1 | 2015 | 2017 | 200E | 2.79×10^{-2} | 1.34×10^{-2} | 1.81×10^{-4} | 7.23×10^{-3} | a | 1.63×10^{-1} | 4.65×10^{-2} |
| Immobilized Low-Activity Waste Interim Storage Facilities | 2016 | 2043 | WTP_AS | 7.42×10^{-3} | 9.99×10^{-4} | a | a | a | 4.38×10^{-4} | 3.06×10^{-4} |
| Operations | | | | | | | | | | |
| IHLW Interim Storage Facility | 2018 | 2066 | 200E | a | a | a | a | a | a | a |
| Other infrastructure upgrades | 2006 | 2043 | 200EW | a | a | a | a | a | a | a |
| Routine operations | 2006 | 2043 | 200EW | 1.18×10^1 | a | a | a | a | a | a |
| Retrieval operations | 2006 | 2043 | 200EW | 4.09×10^{-2} | a | a | a | a | a | a |
| Double-shell tank interim stabilization | 2006 | 2043 | 200EW | 2.68×10^{-1} | a | a | a | a | a | a |
| Waste Treatment Plant | 2018 | 2043 | WTP_PS | 3.53 | 2.23×10^{-2} | 8.05×10^{-6} | 2.49×10^{-4} | 6.97×10^{-2} | 6.27×10^{-4} | 2.11×10^{-3} |

Table G-34. Tank Closure Alternative 6C Toxic Pollutant Emissions (continued)

| Facility/System | Start Year | End Year | Location | Emission Rate (metric tons per year) | | | | | | |
|---|------------|----------|----------|--------------------------------------|-----------------------|-----------------------|-----------------------|-----------------------|-----------------------|-----------------------|
| | | | | Ammonia | Benzene | 1,3-Butadiene | Formaldehyde | Mercury | Toluene | Xylene |
| Operations (continued) | | | | | | | | | | |
| Waste Treatment Plant, cesium and strontium capsules | 2040 | 2040 | WTP_PS | 3.53 | 2.23×10 ⁻² | 8.05×10 ⁻⁶ | 2.49×10 ⁻⁴ | a | 6.27×10 ⁻⁴ | 2.11×10 ⁻³ |
| Cesium and Strontium Capsule Processing Facility | 2039 | 2040 | WTP_AS | 3.80×10 ⁻³ | 6.24×10 ⁻³ | 3.53×10 ⁻⁵ | 2.11×10 ⁻³ | a | 9.58×10 ⁻² | 2.70×10 ⁻² |
| Modified sluicing retrieval system | 2013 | 2043 | 200EW | 2.17×10 ⁻¹ | a | a | a | a | a | a |
| Mobile retrieval system | 2013 | 2028 | 200EW | 2.50×10 ⁻¹ | a | a | a | a | a | a |
| Vacuum-based retrieval system | 2029 | 2043 | 200EW | 3.95×10 ⁻¹ | a | a | a | a | a | a |
| HLW Melter Interim Storage Facility | 2018 | 2145 | WTP_AS | a | a | a | a | a | a | a |
| Effluent Treatment Facility | 2006 | 2045 | WTP_PS | 1.44 | 1.71×10 ⁻³ | 2.83×10 ⁻⁵ | 1.05×10 ⁻³ | a | 1.86×10 ⁻² | 5.35×10 ⁻³ |
| Evaporator | 2006 | 2043 | 200E | 8.97×10 ⁻² | 1.21×10 ⁻² | 5.06×10 ⁻⁴ | 1.53×10 ⁻² | a | 5.29×10 ⁻³ | 3.69×10 ⁻³ |
| Borrow Area C | 2006 | 2052 | Area C | 1.78×10 ⁻¹ | 3.12×10 ⁻² | 1.02×10 ⁻³ | 3.21×10 ⁻² | a | 1.32×10 ⁻¹ | 4.15×10 ⁻² |
| Immobilized Low-Activity Waste Interim Storage Facility | 2018 | 2145 | WTP_AS | a | a | a | a | a | a | a |
| Deactivation | | | | | | | | | | |
| IHLW Interim Storage Facility | 2067 | 2067 | WTP_AS | a | a | a | a | a | a | a |
| Waste Treatment Plant | 2044 | 2045 | WTP_AS | 3.53×10 ⁻¹ | 2.23×10 ⁻³ | 8.05×10 ⁻⁷ | 2.49×10 ⁻⁵ | 9.06×10 ⁻² | 6.27×10 ⁻⁵ | 2.11×10 ⁻⁴ |
| Cesium and Strontium Capsule Processing Facility | 2041 | 2041 | WTP_AS | 1.75×10 ⁻³ | 2.88×10 ⁻³ | 1.63×10 ⁻⁵ | 9.76×10 ⁻⁴ | a | 4.42×10 ⁻² | 1.25×10 ⁻² |
| Effluent Treatment Facility original | 2026 | 2026 | WTP_AS | 7.88×10 ⁻² | 2.23×10 ⁻² | 4.73×10 ⁻⁴ | 1.64×10 ⁻² | a | 2.00×10 ⁻¹ | 5.81×10 ⁻² |
| Effluent Treatment Facility replacement 1 | 2046 | 2046 | WTP_AS | 7.88×10 ⁻² | 2.23×10 ⁻² | 4.73×10 ⁻⁴ | 1.64×10 ⁻² | a | 2.00×10 ⁻¹ | 5.81×10 ⁻² |
| Evaporator original | 2018 | 2018 | 200E | 1.21×10 ⁻² | 1.63×10 ⁻³ | 6.82×10 ⁻⁵ | 2.06×10 ⁻³ | a | 7.14×10 ⁻⁴ | 4.97×10 ⁻⁴ |
| Evaporator replacement 1 | 2044 | 2044 | 200E | 1.21×10 ⁻² | 1.63×10 ⁻³ | 6.82×10 ⁻⁵ | 2.06×10 ⁻³ | a | 7.14×10 ⁻⁴ | 4.97×10 ⁻⁴ |
| Modified sluicing retrieval system | 2013 | 2043 | 200EW | a | a | a | a | a | a | a |
| Mobile retrieval system | 2013 | 2028 | 200EW | a | a | a | a | a | a | a |
| Vacuum-based retrieval system | 2029 | 2043 | 200EW | a | a | a | a | a | a | a |
| Closure | | | | | | | | | | |
| Ancillary equipment grouting | 2013 | 2037 | 200EW | 2.69×10 ⁻⁵ | a | a | a | a | a | a |
| Ancillary equipment removal | 2032 | 2037 | 200EW | 1.72×10 ⁻⁵ | a | a | a | a | a | a |
| Decontamination and decommissioning of 10 selected facilities | 2018 | 2028 | 200EW | a | a | a | a | a | a | a |

Table G–34. Tank Closure Alternative 6C Toxic Pollutant Emissions (continued)

| Facility/System | Start Year | End Year | Location | Emission Rate (metric tons per year) | | | | | | |
|---|------------|----------|----------|--------------------------------------|-----------------------|-----------------------|-----------------------|---------|---------|-----------------------|
| | | | | Ammonia | Benzene | 1,3-Butadiene | Formaldehyde | Mercury | Toluene | Xylene |
| Closure (continued) | | | | | | | | | | |
| Grout facility (tank-filling) construction | 2032 | 2033 | 200EW | 3.33×10 ⁻² | a | a | a | a | a | a |
| Grout facility (tank-filling) operations | 2034 | 2043 | 200EW | 1.17×10 ⁻² | a | a | a | a | a | a |
| Grout facility (tank-filling) deactivation | 2044 | 2044 | 200EW | a | a | a | a | a | a | a |
| Containment structure construction | 2028 | 2031 | 200EW | a | a | a | a | a | a | a |
| BX and SX tank farm deep soil removal | 2032 | 2037 | 200EW | 8.33×10 ⁻⁴ | a | a | a | a | a | a |
| Containment structure deactivation | 2038 | 2040 | 200EW | a | a | a | a | a | a | a |
| Modified Resource Conservation and Recovery Act Subtitle C barrier construction | 2039 | 2045 | 200EW | 2.41 | 4.80×10 ⁻¹ | 1.39×10 ⁻² | 4.49×10 ⁻¹ | a | 2.75 | 8.32×10 ⁻¹ |
| Postclosure care | 2046 | 2145 | 200EW | a | a | a | a | a | a | a |

^a Emissions for this activity and pollutant were not calculated because annual fuel use for this activity and the resulting emissions would be small compared with those of other activities or would be zero.

Key: 200E=200-East Area; 200EW=200-East and 200-West Areas; 200EW+=200-East and 200-West Areas and Waste Treatment Plant area; HLW=high-level radioactive waste; IHLW=immobilized high-level radioactive waste; WTP_AS=Waste Treatment Plant area source; WTP_PS=Waste Treatment Plant point source.

Source: SAIC 2007a, 2008.

Table G-35. FFTF Decommissioning Alternative 1 Criteria Pollutant Emissions

| Facility/System | Start Year | End Year | Location | Emission Rate (metric tons per year) | | | | |
|-------------------------|------------|----------|----------|--------------------------------------|-----------------------|-----------------------|-----------------------|-----------------------|
| | | | | Carbon Monoxide | Nitrogen Dioxide | PM ₁₀ | Sulfur Dioxide | VOCs |
| Deactivation | | | | | | | | |
| Administrative controls | 2008 | 2107 | 400 Area | 1.12 | 2.91×10 ⁻² | 1.78×10 ⁻³ | 1.50×10 ⁻³ | 5.40×10 ⁻² |

Key: FFTF=Fast Flux Test Facility; PM₁₀=particulate matter with an aerodynamic diameter less than or equal to 10 micrometers; VOC=volatile organic compound.

Source: SAIC 2007b.

Table G-36. FFTF Decommissioning Alternative 1 Toxic Pollutant Emissions

| Facility/System | Start Year | End Year | Location | Emission Rate (metric tons per year) | | | | | | |
|-------------------------|------------|----------|----------|--------------------------------------|-----------------------|-----------------------|-----------------------|---------|-----------------------|-----------------------|
| | | | | Ammonia | Benzene | 1,3-Butadiene | Formaldehyde | Mercury | Toluene | Xylene |
| Deactivation | | | | | | | | | | |
| Administrative controls | 2008 | 2107 | 400 Area | 8.64×10 ⁻⁵ | 1.44×10 ⁻⁴ | 8.08×10 ⁻⁷ | 4.85×10 ⁻⁵ | a | 2.21×10 ⁻³ | 6.24×10 ⁻⁴ |

^a Emissions for this activity and pollutant were not calculated because annual fuel use for this activity and the resulting emissions would be small compared with those of other activities or would be zero.

Key: FFTF=Fast Flux Test Facility.

Source: SAIC 2007b.

Table G-37. FFTF Decommissioning Alternative 2 Criteria Pollutant Emissions for Hanford Activities

| Facility/System | Start Year | End Year | Location | Emission Rate (metric tons per year) | | | | |
|---|------------|----------|----------|--------------------------------------|-----------------------|-----------------------|-----------------------|-----------------------|
| | | | | Carbon Monoxide | Nitrogen Dioxide | PM ₁₀ | Sulfur Dioxide | VOCs |
| Decommissioning | | | | | | | | |
| Above-grade structure and equipment removal | 2013 | 2020 | 400 Area | 1.12×10 ¹ | 1.08×10 ¹ | 1.21×10 ¹ | 1.56×10 ⁻² | 1.29 |
| Backfill of Reactor Containment Building with grout | 2017 | 2017 | 400 Area | 1.31 | 6.06 | 1.86 | 2.06×10 ⁻³ | 4.95×10 ⁻¹ |
| Backfill of Buildings 491 East and West with grout | 2017 | 2017 | 400 Area | 8.47×10 ⁻¹ | 3.94 | 3.76 | 1.33×10 ⁻³ | 3.21×10 ⁻¹ |
| Grout facility construction | 2016 | 2016 | 400 Area | 4.35 | 1.66×10 ¹ | 8.39 | 1.08 | 1.38 |
| Grout facility operations | 2017 | 2017 | 400 Area | 7.97 | 3.70×10 ¹ | 2.60 | 1.26×10 ⁻² | 3.02 |
| Grout facility deactivation | 2018 | 2018 | 400 Area | 2.42 | 5.68 | 3.50×10 ¹ | 3.73×10 ⁻¹ | 7.84×10 ⁻¹ |
| Nonhazardous waste transportation | 2013 | 2020 | 400 Area | 4.37×10 ⁻³ | 2.03×10 ⁻² | 1.43×10 ⁻³ | 6.90×10 ⁻⁶ | 1.66×10 ⁻³ |
| Construction | | | | | | | | |
| Sodium Reaction Facility | 2015 | 2016 | 400 Area | 1.85×10 ² | 3.89×10 ¹ | 1.47×10 ¹ | 2.49×10 ⁻¹ | 1.14×10 ¹ |
| Remote Treatment Project | 2015 | 2016 | 400 Area | 1.41 | 6.53 | 2.74×10 ¹ | 2.22×10 ⁻³ | 5.31×10 ⁻¹ |
| Operations | | | | | | | | |
| Sodium preparation | 2017 | 2017 | 400 Area | a | a | a | a | a |
| Sodium Reaction Facility | 2017 | 2018 | 400 Area | a | a | a | a | a |
| Remote Treatment Project | 2017 | 2017 | 400 Area | a | a | a | a | a |
| Deactivation | | | | | | | | |
| Sodium Reaction Facility | 2019 | 2019 | 400 Area | 5.22×10 ¹ | 1.10×10 ¹ | 7.61×10 ⁻¹ | 7.05×10 ⁻² | 3.21 |
| Remote Treatment Project | 2018 | 2018 | 400 Area | a | a | a | a | a |
| Closure | | | | | | | | |
| Site regrading | 2021 | 2021 | 400 Area | 2.81×10 ¹ | 6.01×10 ¹ | 2.15×10 ¹ | 4.07×10 ⁻² | 5.61 |
| Site revegetation | 2021 | 2021 | 400 Area | 1.12 | 9.05×10 ⁻¹ | 1.73×10 ¹ | 1.55×10 ⁻³ | 1.17×10 ⁻¹ |
| Modified Resource Conservation and Recovery Act Subtitle C barrier construction | 2021 | 2021 | 400 Area | 9.36×10 ¹ | 6.74×10 ¹ | 1.42×10 ¹ | 1.29×10 ⁻¹ | 9.17 |
| Postclosure care | 2022 | 2121 | 400 Area | 1.86 | 4.84×10 ⁻² | 2.97×10 ⁻³ | 2.50×10 ⁻³ | 9.00×10 ⁻² |

^a Emissions for this activity and pollutant were not calculated because annual fuel use for this activity and the resulting emissions would be small compared with those of other activities or would be zero.

Key: FFTF=Fast Flux Test Facility; PM₁₀=particulate matter with an aerodynamic diameter less than or equal to 10 micrometers; VOC=volatile organic compound.

Source: SAIC 2007b.

Table G-38. FFTF Decommissioning Alternative 2 Toxic Pollutant Emissions for Hanford Activities

| Facility/System | Start Year | End Year | Location | Emission Rate (metric tons per year) | | | | | | |
|---|------------|----------|----------|--------------------------------------|-----------------------|-----------------------|-----------------------|---------|-----------------------|-----------------------|
| | | | | Ammonia | Benzene | 1,3-Butadiene | Formaldehyde | Mercury | Toluene | Xylene |
| Decommissioning | | | | | | | | | | |
| Above-grade structure and equipment removal | 2013 | 2020 | 400 Area | 1.72×10^{-2} | 3.38×10^{-3} | 9.97×10^{-5} | 3.20×10^{-3} | a | 1.87×10^{-2} | 5.67×10^{-3} |
| Backfill of Reactor Containment Building with grout | 2017 | 2017 | 400 Area | 9.54×10^{-3} | 1.28×10^{-3} | 5.38×10^{-5} | 1.62×10^{-3} | a | 5.62×10^{-4} | 3.92×10^{-4} |
| Backfill of Buildings 491 East and West with grout | 2017 | 2017 | 400 Area | 6.19×10^{-3} | 8.32×10^{-4} | 3.48×10^{-5} | 1.05×10^{-3} | a | 3.65×10^{-4} | 2.54×10^{-4} |
| Grout facility construction | 2016 | 2016 | 400 Area | 1.11×10^{-1} | 5.98×10^{-3} | 2.45×10^{-4} | 7.41×10^{-3} | a | 4.99×10^{-3} | 2.47×10^{-3} |
| Grout facility operations | 2017 | 2017 | 400 Area | 5.82×10^{-2} | 7.83×10^{-3} | 9.90×10^{-3} | 3.28×10^{-4} | a | 3.43×10^{-3} | 2.39×10^{-3} |
| Grout facility deactivation | 2018 | 2018 | 400 Area | a | 2.04×10^{-3} | 7.96×10^{-5} | 2.43×10^{-3} | a | 3.27×10^{-3} | 1.26×10^{-3} |
| Nonhazardous waste transportation | 2013 | 2020 | 400 Area | 3.19×10^{-5} | 4.29×10^{-6} | 1.80×10^{-7} | 5.43×10^{-6} | a | 1.88×10^{-6} | 1.31×10^{-6} |
| Construction | | | | | | | | | | |
| Sodium Reaction Facility | 2015 | 2016 | 400 Area | 9.16 | 3.01×10^{-2} | 4.32×10^{-4} | 1.69×10^{-2} | a | 3.54×10^{-1} | 1.01×10^{-1} |
| Remote Treatment Project | 2015 | 2016 | 400 Area | 1.03×10^{-2} | 1.38×10^{-3} | 5.76×10^{-5} | 1.74×10^{-3} | a | 6.03×10^{-4} | 4.21×10^{-4} |
| Operations | | | | | | | | | | |
| Sodium preparation | 2017 | 2017 | 400 Area | a | a | a | a | a | a | a |
| Sodium Reaction Facility | 2017 | 2018 | 400 Area | a | a | a | a | a | a | a |
| Remote Treatment Project | 2017 | 2017 | 400 Area | a | a | a | a | a | a | a |
| Deactivation | | | | | | | | | | |
| Sodium Reaction Facility | 2019 | 2019 | 400 Area | 1.91×10^{-2} | 8.50×10^{-3} | 1.22×10^{-4} | 4.77×10^{-3} | a | 1.00×10^{-1} | 2.86×10^{-2} |
| Remote Treatment Project | 2018 | 2018 | 400 Area | a | a | a | a | a | a | a |
| Closure | | | | | | | | | | |
| Site regrading | 2021 | 2021 | 400 Area | 9.51×10^{-2} | 1.46×10^{-2} | 5.40×10^{-4} | 1.66×10^{-2} | a | 3.57×10^{-2} | 1.24×10^{-2} |
| Site revegetation | 2021 | 2021 | 400 Area | 1.46×10^{-3} | 3.06×10^{-4} | 8.48×10^{-6} | 2.76×10^{-4} | a | 1.93×10^{-3} | 5.78×10^{-4} |
| Modified Resource Conservation and Recovery Act Subtitle C barrier construction | 2021 | 2021 | 400 Area | 1.09×10^{-1} | 2.40×10^{-2} | 6.36×10^{-4} | 2.09×10^{-2} | a | 1.63×10^{-1} | 4.86×10^{-2} |
| Postclosure care | 2022 | 2121 | 400 Area | 2.88×10^{-1} | 4.80×10^{-1} | 2.69×10^{-3} | 1.62×10^{-1} | a | 7.37 | 2.08 |

^a Emissions for this activity and pollutant were not calculated because annual fuel use for this activity and the resulting emissions would be small compared with those of other activities or would be zero.

Key: FFTF=Fast Flux Test Facility.

Source: SAIC 2007b.

Table G-39. FFTF Decommissioning Alternative 3 Criteria Pollutant Emissions for Hanford Activities

| Facility/System | Start Year | End Year | Location | Emission Rate (metric tons per year) | | | | |
|---|------------|----------|----------|--------------------------------------|-----------------------|-----------------------|-----------------------|-----------------------|
| | | | | Carbon Monoxide | Nitrogen Dioxide | PM ₁₀ | Sulfur Dioxide | VOCs |
| Decommissioning | | | | | | | | |
| Above-grade structure and equipment removal | 2013 | 2020 | 400 Area | 1.12×10 ¹ | 1.08×10 ¹ | 1.21×10 ¹ | 1.56×10 ⁻² | 1.29 |
| Removal of Reactor Containment Building below-grade vessels, piping, and components | 2013 | 2014 | 400 Area | 4.34×10 ¹ | 1.71×10 ¹ | 5.59 | 5.90×10 ⁻² | 5.13×10 ⁻³ |
| Grout facility construction | 2012 | 2012 | 400 Area | 7.27 | 2.77×10 ¹ | 1.40×10 ¹ | 1.80 | 2.30 |
| Grout facility operations | 2013 | 2014 | 400 Area | 3.98 | 1.85×10 ¹ | 1.30 | 6.29×10 ⁻³ | 1.51 |
| Grout facility deactivation | 2015 | 2015 | 400 Area | 2.42 | 5.68 | 3.50×10 ¹ | 3.73×10 ⁻¹ | 7.84×10 ⁻¹ |
| Nonhazardous waste transportation | 2013 | 2020 | 400 Area | 4.37×10 ⁻³ | 2.03×10 ⁻² | 1.43×10 ⁻³ | 6.90×10 ⁻⁶ | 1.66×10 ⁻³ |
| Construction | | | | | | | | |
| Sodium Reaction Facility | 2015 | 2016 | 400 Area | 1.85×10 ² | 3.89×10 ¹ | 1.47×10 ¹ | 2.49×10 ⁻¹ | 1.14×10 ¹ |
| Remote Treatment Project | 2015 | 2016 | 400 Area | 1.41 | 6.53 | 2.74×10 ¹ | 2.22×10 ⁻³ | 5.31×10 ⁻¹ |
| Operations | | | | | | | | |
| Sodium preparation | 2017 | 2017 | 400 Area | a | a | a | a | a |
| Sodium Reaction Facility | 2017 | 2018 | 400 Area | a | a | a | a | a |
| Remote Treatment Project | 2017 | 2017 | 400 Area | a | a | a | a | a |
| Deactivation | | | | | | | | |
| Sodium Reaction Facility | 2019 | 2019 | 400 Area | 5.22×10 ¹ | 1.10×10 ¹ | 7.61×10 ⁻¹ | 7.05×10 ⁻² | 3.21 |
| Remote Treatment Project | 2018 | 2018 | 400 Area | a | a | a | a | a |
| Closure | | | | | | | | |
| Site regrading | 2018 | 2018 | 400 Area | 4.00×10 ¹ | 8.01×10 ¹ | 2.51×10 ¹ | 5.77×10 ⁻² | 7.60 |
| Site revegetation | 2018 | 2018 | 400 Area | 1.27 | 1.02 | 1.95×10 ¹ | 1.75×10 ⁻³ | 1.32×10 ⁻¹ |
| Postclosure care | 2022 | 2121 | 400 Area | 1.86 | 4.84×10 ⁻² | 2.97×10 ⁻³ | 2.50×10 ⁻³ | 9.00×10 ⁻² |

^a Emissions for this activity and pollutant were not calculated because annual fuel use for this activity and the resulting emissions would be small compared with those of other activities or would be zero.

Key: FFTF=Fast Flux Test Facility; PM₁₀=particulate matter with an aerodynamic diameter less than or equal to 10 micrometers; VOC=volatile organic compound.

Source: SAIC 2007b.

Table G-40. FFTF Decommissioning Alternative 3 Toxic Pollutant Emissions for Hanford Activities

| Facility/System | Start Year | End Year | Location | Emission Rate (metric tons per year) | | | | | | |
|---|------------|----------|----------|--------------------------------------|-----------------------|-----------------------|-----------------------|---------|-----------------------|-----------------------|
| | | | | Ammonia | Benzene | 1,3-Butadiene | Formaldehyde | Mercury | Toluene | Xylene |
| Decommissioning | | | | | | | | | | |
| Above-grade structure and equipment removal | 2013 | 2020 | 400 Area | 1.72×10^{-2} | 3.38×10^{-3} | 9.97×10^{-5} | 3.20×10^{-3} | a | 1.87×10^{-2} | 5.67×10^{-3} |
| Removal of Reactor Containment Building below-grade vessels, piping, and components | 2013 | 2014 | 400 Area | 2.83×10^{-2} | 8.53×10^{-3} | 1.71×10^{-4} | 6.02×10^{-3} | a | 8.05×10^{-2} | 2.33×10^{-2} |
| Grout facility construction | 2012 | 2012 | 400 Area | 1.11×10^{-1} | 5.98×10^{-3} | 2.45×10^{-4} | 7.41×10^{-3} | a | 4.99×10^{-3} | 2.47×10^{-3} |
| Grout facility operations | 2013 | 2014 | 400 Area | 2.91×10^{-2} | 3.91×10^{-3} | 4.95×10^{-3} | 1.64×10^{-4} | a | 1.72×10^{-3} | 1.20×10^{-3} |
| Grout facility deactivation | 2015 | 2015 | 400 Area | a | 2.04×10^{-3} | 7.96×10^{-5} | 2.43×10^{-3} | a | 3.27×10^{-3} | 1.26×10^{-3} |
| Nonhazardous waste transportation | 2013 | 2020 | 400 Area | 3.19×10^{-5} | 4.29×10^{-6} | 1.80×10^{-7} | 5.43×10^{-6} | a | 1.88×10^{-6} | 1.31×10^{-6} |
| Construction | | | | | | | | | | |
| Sodium Reaction Facility | 2015 | 2016 | 400 Area | 9.16 | 3.01×10^{-2} | 4.32×10^{-4} | 1.69×10^{-2} | a | 3.54×10^{-1} | 1.01×10^{-1} |
| Remote Treatment Project | 2015 | 2016 | 400 Area | 1.03×10^{-2} | 1.38×10^{-3} | 5.76×10^{-5} | 1.74×10^{-3} | a | 6.03×10^{-4} | 4.21×10^{-4} |
| Operations | | | | | | | | | | |
| Sodium preparation | 2017 | 2017 | 400 Area | a | a | a | a | a | a | a |
| Sodium Reaction Facility | 2017 | 2018 | 400 Area | a | a | a | a | a | a | a |
| Remote Treatment Project | 2017 | 2017 | 400 Area | a | a | a | a | a | a | a |
| Deactivation | | | | | | | | | | |
| Sodium Reaction Facility | 2019 | 2019 | 400 Area | 1.91×10^{-2} | 8.50×10^{-3} | 1.22×10^{-4} | 4.77×10^{-3} | a | 1.00×10^{-1} | 2.86×10^{-2} |
| Remote Treatment Project | 2018 | 2018 | 400 Area | a | a | a | a | a | a | a |
| Closure | | | | | | | | | | |
| Site regrading | 2018 | 2018 | 400 Area | 1.27×10^{-1} | 1.98×10^{-2} | 7.21×10^{-4} | 2.23×10^{-2} | a | 5.27×10^{-2} | 1.79×10^{-2} |
| Site revegetation | 2018 | 2018 | 400 Area | 1.64×10^{-3} | 3.46×10^{-4} | 9.57×10^{-6} | 3.12×10^{-4} | a | 2.17×10^{-3} | 6.52×10^{-4} |
| Postclosure care | 2022 | 2121 | 400 Area | 2.88×10^{-1} | 4.80×10^{-1} | 2.69×10^{-3} | 1.62×10^{-1} | a | 7.37 | 2.08 |

^a Emissions for this activity and pollutant were not calculated because annual fuel use for this activity and the resulting emissions would be small compared with those of other activities or would be zero.

Key: FFTF=Fast Flux Test Facility.

Source: SAIC 2007b.

Table G-41. FFTF Decommissioning Alternative 2 Criteria Pollutant Emissions for Idaho National Laboratory Activities

| Facility/System | Start Year | End Year | Location | Emission Rate (metric tons per year) | | | | |
|----------------------------|------------|----------|----------|--------------------------------------|------------------|----------------------|-----------------------|-----------------------|
| | | | | Carbon Monoxide | Nitrogen Dioxide | PM ₁₀ | Sulfur Dioxide | VOCs |
| Construction | | | | | | | | |
| Sodium Processing Facility | 2014 | 2014 | MFC | 8.82 | 1.28 | 4.40 | 1.19×10 ⁻² | 5.02×10 ⁻¹ |
| Remote Treatment Project | 2015 | 2016 | MFC | 1.43 | 6.62 | 2.86×10 ¹ | 2.25×10 ⁻³ | 5.40×10 ⁻¹ |
| Operations | | | | | | | | |
| Sodium preparation | 2015 | 2015 | Hanford | a | a | a | a | a |
| Sodium Processing Facility | 2015 | 2016 | MFC | a | a | a | a | a |
| Remote Treatment Project | 2017 | 2017 | MFC | a | a | a | a | a |
| Deactivation | | | | | | | | |
| Sodium Processing Facility | 2016 | 2016 | MFC | a | a | a | a | a |
| Remote Treatment Project | 2018 | 2018 | MFC | a | a | a | a | a |

^a Emissions for this activity and pollutant were not calculated because annual fuel use for this activity and the resulting emissions would be small compared with those of other activities or would be zero.

Key: FFTF=Fast Flux Test Facility; Hanford=Hanford Site; MFC=Materials and Fuels Complex; PM₁₀=particulate matter with an aerodynamic diameter less than or equal to 10 micrometers; VOC=volatile organic compound.

Source: SAIC 2007b.

Table G-42. FFTF Decommissioning Alternative 2 Toxic Pollutant Emissions for Idaho National Laboratory Activities

| Facility/System | Start Year | End Year | Location | Emission Rate (metric tons per year) | | | | | | |
|----------------------------|------------|----------|----------|--------------------------------------|---------|---------------|--------------|---------|---------|--------|
| | | | | Ammonia | Benzene | 1,3-Butadiene | Formaldehyde | Mercury | Toluene | Xylene |
| Construction | | | | | | | | | | |
| Sodium Processing Facility | 2014 | 2014 | MFC | a | a | a | a | a | a | a |
| Remote Treatment Project | 2015 | 2016 | MFC | a | a | a | a | a | a | a |
| Operations | | | | | | | | | | |
| Sodium preparation | 2015 | 2015 | Hanford | a | a | a | a | a | a | a |
| Sodium Processing Facility | 2015 | 2016 | MFC | a | a | a | a | a | a | a |
| Remote Treatment Project | 2017 | 2017 | MFC | a | a | a | a | a | a | a |
| Deactivation | | | | | | | | | | |
| Sodium Processing Facility | 2016 | 2016 | MFC | a | a | a | a | a | a | a |
| Remote Treatment Project | 2018 | 2028 | MFC | a | a | a | a | a | a | a |

^a Emissions for this activity and pollutant were not calculated because annual fuel use for this activity and the resulting emissions would be small compared with those of other activities or would be zero.

Key: FFTF=Fast Flux Test Facility; Hanford=Hanford Site; MFC=Materials and Fuels Complex.

Source: SAIC 2007b.

Table G-43. FFTF Decommissioning Alternative 3 Criteria Pollutant Emissions for Idaho National Laboratory Activities

| Facility/System | Start Year | End Year | Location | Emission Rate (metric tons per year) | | | | |
|----------------------------|------------|----------|----------|--------------------------------------|------------------|----------------------|-----------------------|-----------------------|
| | | | | Carbon Monoxide | Nitrogen Dioxide | PM ₁₀ | Sulfur Dioxide | VOCs |
| Construction | | | | | | | | |
| Sodium Processing Facility | 2014 | 2014 | MFC | a | a | 4.40 | a | a |
| Remote Treatment Project | 2015 | 2016 | MFC | 1.43 | 6.62 | 2.86×10 ¹ | 2.25×10 ⁻³ | 5.40×10 ⁻¹ |
| Operations | | | | | | | | |
| Sodium preparation | 2015 | 2015 | Hanford | a | a | a | a | a |
| Sodium Processing Facility | 2015 | 2016 | MFC | a | a | a | a | a |
| Remote Treatment Project | 2017 | 2017 | MFC | a | a | a | a | a |
| Deactivation | | | | | | | | |
| Sodium Processing Facility | 2016 | 2016 | MFC | a | a | a | a | a |
| Remote Treatment Project | 2018 | 2018 | MFC | a | a | a | a | a |

^a Emissions for this activity and pollutant were not calculated because annual fuel use for this activity and the resulting emissions would be small compared with those of other activities or would be zero.

Key: FFTF=Fast Flux Test Facility; Hanford=Hanford Site; MFC=Materials and Fuels Complex; PM₁₀=particulate matter with an aerodynamic diameter less than or equal to 10 micrometers; VOC=volatile organic compound.

Source: SAIC 2007b.

Table G-44. FFTF Decommissioning Alternative 3 Toxic Pollutant Emissions for Idaho National Laboratory Activities

| Facility/System | Start Year | End Year | Location | Emission Rate (metric tons per year) | | | | | | |
|----------------------------|------------|----------|----------|--------------------------------------|---------|---------------|--------------|---------|---------|--------|
| | | | | Ammonia | Benzene | 1,3-Butadiene | Formaldehyde | Mercury | Toluene | Xylene |
| Construction | | | | | | | | | | |
| Sodium Processing Facility | 2014 | 2014 | MFC | a | a | a | a | a | a | a |
| Remote Treatment Project | 2015 | 2016 | MFC | a | a | a | a | a | a | a |
| Operations | | | | | | | | | | |
| Sodium preparation | 2015 | 2015 | Hanford | a | a | a | a | a | a | a |
| Sodium Processing Facility | 2015 | 2016 | MFC | a | a | a | a | a | a | a |
| Remote Treatment Project | 2017 | 2017 | MFC | a | a | a | a | a | a | a |
| Deactivation | | | | | | | | | | |
| Sodium Processing Facility | 2016 | 2016 | MFC | a | a | a | a | a | a | a |
| Remote Treatment Project | 2018 | 2018 | MFC | a | a | a | a | a | a | a |

^a Emissions for this activity and pollutant were not calculated because annual fuel use for this activity and the resulting emissions would be small compared with those of other activities or would be zero.

Key: FFTF=Fast Flux Test Facility; Hanford=Hanford Site; MFC=Materials and Fuels Complex.

Source: SAIC 2007b.

Table G-45. Waste Management Alternative 1 Criteria Pollutant Emissions

| Facility/System | Start Year | End Year | Location | Emission Rate (metric tons per year) | | | | | |
|--|------------|----------|----------|--------------------------------------|----------------------|----------------------|-----------------------|-----------------------|--|
| | | | | Carbon Monoxide | Nitrogen Dioxide | PM ₁₀ | Sulfur Dioxide | VOCs | |
| Operations | | | | | | | | | |
| Low-level radioactive waste burial grounds | 2007 | 2035 | 200W | 2.54 | 6.29 | 8.14×10 ¹ | 3.72×10 ⁻³ | 5.68×10 ⁻¹ | |
| Deactivation | | | | | | | | | |
| Integrated Disposal Facility | 2009 | 2009 | 200E | 5.33×10 ¹ | 2.40×10 ² | 8.08×10 ² | 8.37×10 ⁻² | 1.96×10 ¹ | |
| Postclosure care | 2036 | 2135 | 200EW | a | a | a | a | a | |

^a Emissions for this activity and pollutant were not calculated because annual fuel use for this activity and the resulting emissions would be small compared with those of other activities or would be zero.

Key: 200E=200-East Area; 200W=200-West Area; 200EW=200-East and 200-West Areas; PM₁₀=particulate matter with an aerodynamic diameter less than or equal to 10 micrometers; VOC=volatile organic compound.

Source: SAIC 2007c.

Table G-46. Waste Management Alternative 1 Toxic Pollutant Emissions

| Facility/System | Start Year | End Year | Location | Emission Rate (metric tons per year) | | | | | | |
|--|------------|----------|----------|--------------------------------------|-----------------------|-----------------------|-----------------------|---------|-----------------------|-----------------------|
| | | | | Ammonia | Benzene | 1,3-Butadiene | Formaldehyde | Mercury | Toluene | Xylene |
| Operations | | | | | | | | | | |
| Low-level radioactive waste burial grounds | 2007 | 2035 | 200W | 9.93×10 ⁻³ | 1.48×10 ⁻³ | 5.63×10 ⁻⁵ | 1.73×10 ⁻³ | a | 2.93×10 ⁻³ | 1.07×10 ⁻³ |
| Deactivation | | | | | | | | | | |
| Integrated Disposal Facility | 2009 | 2009 | 200E | 3.77×10 ⁻¹ | 5.09×10 ⁻² | 2.13×10 ⁻³ | 6.42×10 ⁻² | a | 2.54×10 ⁻² | 1.64×10 ⁻² |
| Postclosure care | 2036 | 2135 | 200EW | 8.12×10 ⁻³ | 2.48×10 ⁻³ | 4.92×10 ⁻⁵ | 1.74×10 ⁻³ | a | 2.36×10 ⁻² | 6.83×10 ⁻³ |
| Low-level radioactive waste burial grounds | 2007 | 2035 | 200W | 9.93×10 ⁻³ | 1.48×10 ⁻³ | 5.63×10 ⁻⁵ | 1.73×10 ⁻³ | a | 2.93×10 ⁻³ | 1.07×10 ⁻³ |

^a Emissions for this activity and pollutant were not calculated because annual fuel use for this activity and the resulting emissions would be small compared with those of other activities or would be zero.

Key: 200E=200-East Area; 200W=200-West Area; 200EW=200-East and 200-West Areas.

Source: SAIC 2007c.

Table G-47. Waste Management Alternative 2 (Treatment and Storage) Criteria Pollutant Emissions

| Facility/System | Start Year | End Year | Location | Emission Rate (metric tons per year) | | | | |
|---|------------|----------|----------|--------------------------------------|-----------------------|----------------------|-----------------------|-----------------------|
| | | | | Carbon Monoxide | Nitrogen Dioxide | PM ₁₀ | Sulfur Dioxide | VOCs |
| Construction | | | | | | | | |
| T Plant complex expansion | 2011 | 2012 | 200W | 6.27×10 ¹ | 1.16×10 ¹ | 2.69×10 ¹ | 8.46×10 ⁻² | 3.75 |
| Contact-Handled Mixed TRU/TRU waste facility (WRAP expansion) | 2011 | 2012 | 200W | 7.15×10 ² | 1.33×10 ² | 1.27×10 ² | 9.64×10 ⁻¹ | 4.27×10 ¹ |
| Remote-Handled Mixed TRU/TRU waste facility (WRAP expansion) | 2013 | 2018 | 200W | 5.26×10 ² | 7.62×10 ¹ | 8.10×10 ¹ | 7.08×10 ⁻¹ | 2.99×10 ¹ |
| Central Waste Complex expansion | 2011 | 2012 | 200W | 2.38×10 ² | 4.42×10 ¹ | 4.22×10 ¹ | 3.21×10 ⁻¹ | 1.42×10 ¹ |
| Operations | | | | | | | | |
| T Plant complex expansion | 2013 | 2050 | 200W | 1.05×10 ² | 4.87×10 ² | 4.30×10 ¹ | 1.66×10 ⁻¹ | 3.98×10 ¹ |
| Contact-Handled Mixed TRU/TRU waste facility (WRAP expansion) | 2013 | 2050 | 200W | 2.83×10 ⁻¹ | 1.31 | 1.14×10 ² | 4.47×10 ⁻⁴ | 1.07×10 ⁻¹ |
| Remote-Handled Mixed TRU/TRU waste facility (WRAP expansion) | 2019 | 2050 | 200W | 1.13×10 ⁻¹ | 5.25×10 ⁻¹ | 1.14×10 ² | 1.79×10 ⁻⁴ | 4.29×10 ⁻² |
| Central Waste Complex expansion | 2013 | 2050 | 200W | 6.04×10 ¹ | 1.15×10 ¹ | 4.91×10 ² | 8.15×10 ⁻² | 3.63 |
| Deactivation | | | | | | | | |
| T Plant complex expansion | 2051 | 2051 | 200W | 7.48 | 9.89 | 5.05 | 1.05×10 ⁻² | 1.06 |
| Contact-Handled Mixed TRU/TRU waste facility (WRAP expansion) | 2051 | 2051 | 200W | 1.41×10 ⁻¹ | 6.56×10 ⁻¹ | 9.48×10 ¹ | 2.23×10 ⁻⁴ | 5.36×10 ⁻² |
| Remote-Handled Mixed TRU/TRU waste facility (WRAP expansion) | 2051 | 2051 | 200W | 5.66×10 ⁻² | 2.63×10 ⁻¹ | 3.79×10 ¹ | 8.93×10 ⁻⁵ | 2.14×10 ⁻² |
| Central Waste Complex expansion | 2051 | 2051 | 200W | 3.02×10 ¹ | 5.75 | 1.02×10 ¹ | 4.07×10 ⁻² | 1.82 |

Key: 200W=200-West Area; PM₁₀=particulate matter with an aerodynamic diameter less than or equal to 10 micrometers; VOC=volatile organic compound; TRU=transuranic; WRAP=Waste Receiving and Processing Facility.

Source: SAIC 2007c.

Table G-48. Waste Management Alternative 2 (Treatment and Storage) Toxic Pollutant Emissions

| Facility/System | Start Year | End Year | Location | Emission Rate (metric tons per year) | | | | | | |
|---|------------|----------|----------|--------------------------------------|-----------------------|-----------------------|-----------------------|---------|-----------------------|-----------------------|
| | | | | Ammonia | Benzene | 1,3-Butadiene | Formaldehyde | Mercury | Toluene | Xylene |
| Construction | | | | | | | | | | |
| T Plant complex expansion | 2011 | 2012 | 200W | 2.05×10^{-2} | 9.92×10^{-3} | 1.33×10^{-4} | 5.32×10^{-3} | a | 1.21×10^{-1} | 3.45×10^{-2} |
| Contact-Handled Mixed TRU/TRU waste facility (WRAP expansion) | 2011 | 2012 | 200W | 2.34×10^{-1} | 1.13×10^{-1} | 1.51×10^{-3} | 6.06×10^{-2} | a | 1.38 | 3.93×10^{-1} |
| Remote-Handled Mixed TRU/TRU waste facility (WRAP expansion) | 2013 | 2018 | 200W | 1.38×10^{-1} | 7.93×10^{-2} | 5.57×10^{-3} | 2.34×10^{-1} | a | 1.02 | 2.90×10^{-1} |
| Central Waste Complex expansion | 2011 | 2012 | 200W | 7.79×10^{-2} | 3.77×10^{-2} | 5.05×10^{-4} | 2.02×10^{-2} | a | 4.59×10^{-1} | 1.31×10^{-1} |
| Operations | | | | | | | | | | |
| T Plant complex expansion | 2013 | 2050 | 200W | 7.66×10^{-1} | 1.03×10^{-1} | 4.32×10^{-3} | 1.30×10^{-1} | a | 4.52×10^{-2} | 3.15×10^{-2} |
| Contact-Handled Mixed TRU/TRU waste facility (WRAP expansion) | 2013 | 2050 | 200W | 2.06×10^{-3} | 2.78×10^{-4} | 1.16×10^{-5} | 3.51×10^{-4} | a | 1.22×10^{-4} | 8.48×10^{-5} |
| Remote-Handled Mixed TRU/TRU waste facility (WRAP expansion) | 2019 | 2050 | 200W | 8.26×10^{-4} | 1.11×10^{-4} | 4.66×10^{-6} | 1.41×10^{-4} | a | 4.87×10^{-5} | 3.39×10^{-5} |
| Central Waste Complex expansion | 2013 | 2050 | 200W | 2.02×10^{-2} | 9.62×10^{-3} | 1.31×10^{-4} | 5.20×10^{-3} | a | 1.16×10^{-1} | 3.32×10^{-2} |
| Deactivation | | | | | | | | | | |
| T Plant complex expansion | 2051 | 2051 | 200W | 3.11×10^{-1} | 2.76×10^{-3} | 9.03×10^{-5} | 2.84×10^{-3} | a | 1.16×10^{-2} | 3.63×10^{-3} |
| Contact-Handled Mixed TRU/TRU waste facility (WRAP expansion) | 2051 | 2051 | 200W | 1.03×10^{-3} | 1.39×10^{-4} | 5.82×10^{-6} | 1.76×10^{-4} | a | 6.09×10^{-5} | 4.24×10^{-5} |
| Remote-Handled Mixed TRU/TRU waste facility (WRAP expansion) | 2051 | 2051 | 200W | 4.13×10^{-4} | 5.56×10^{-5} | 2.33×10^{-6} | 7.03×10^{-5} | a | 2.44×10^{-5} | 1.70×10^{-5} |
| Central Waste Complex expansion | 2051 | 2051 | 200W | 1.01×10^{-2} | 4.81×10^{-3} | 6.53×10^{-5} | 2.60×10^{-3} | a | 5.81×10^{-2} | 1.66×10^{-2} |

^a Emissions for this activity and pollutant were not calculated because annual fuel use for this activity and the resulting emissions would be small compared with those of other activities or would be zero.

Key: 200W=200-West Area; TRU=transuranic; WRAP=Waste Receiving and Processing Facility.

Source: SAIC 2007c.

Table G-49. Waste Management Alternative 2, Disposal Group 1, Criteria Pollutant Emissions

| Facility/System | Start Year | End Year | Location | Emission Rate (metric tons per year) | | | | |
|--|------------|----------|----------|--------------------------------------|----------------------|-----------------------|-----------------------|-----------------------|
| | | | | Carbon Monoxide | Nitrogen Dioxide | PM ₁₀ | Sulfur Dioxide | VOCs |
| Construction | | | | | | | | |
| Integrated Disposal Facility | 2006 | 2008 | 200E | 9.29×10 ¹ | 3.32×10 ² | 2.13×10 ³ | 1.41×10 ⁻¹ | 2.81×10 ¹ |
| River Protection Project Disposal Facility | 2019 | 2021 | 200EW | 8.38×10 ¹ | 2.99×10 ² | 1.92×10 ³ | 1.28×10 ⁻¹ | 2.53×10 ¹ |
| Operations | | | | | | | | |
| Low-level radioactive waste burial grounds | 2007 | 2050 | 200W | 2.52 | 6.24 | 8.14×10 ¹ | 3.70×10 ⁻³ | 5.64×10 ⁻¹ |
| Integrated Disposal Facility | 2009 | 2050 | 200E | 2.88×10 ¹ | 7.40×10 ¹ | 2.11×10 ³ | 4.23×10 ⁻² | 6.63 |
| River Protection Project Disposal Facility | 2022 | 2050 | 200EW | 7.25×10 ¹ | 1.08×10 ² | 1.64×10 ² | 1.03×10 ⁻¹ | 1.11×10 ¹ |
| Closure | | | | | | | | |
| Integrated Disposal Facility | 2051 | 2052 | 200E | 2.21×10 ³ | 1.54×10 ³ | 3.34×10 ² | 3.04 | 2.13×10 ² |
| Postclosure care, Integrated Disposal Facility | 2053 | 2152 | 200E | 2.04×10 ¹ | 7.88 | 5.49×10 ⁻¹ | 2.77×10 ⁻² | 1.51 |
| River Protection Project Disposal Facility | 2051 | 2052 | 200EW | 1.99×10 ³ | 1.39×10 ³ | 3.01×10 ² | 2.74 | 1.92×10 ² |
| Postclosure care, River Protection Project Disposal Facility | 2053 | 2152 | 200EW | 1.84×10 ¹ | 7.11 | 4.96×10 ⁻¹ | 2.50×10 ⁻² | 1.37 |

Key: 200E=200-East Area; 200W=200-West Area; 200EW=200-East and 200-West Areas; PM₁₀=particulate matter with an aerodynamic diameter less than or equal to 10 micrometers; VOC=volatile organic compound.

Source: SAIC 2007c.

Table G-50. Waste Management Alternative 2, Disposal Group 1, Toxic Pollutant Emissions

| Facility/System | Start Year | End Year | Location | Emission Rate (metric tons per year) | | | | | | |
|--|------------|----------|----------|--------------------------------------|-----------------------|-----------------------|-----------------------|---------|-----------------------|-----------------------|
| | | | | Ammonia | Benzene | 1,3-Butadiene | Formaldehyde | Mercury | Toluene | Xylene |
| Construction | | | | | | | | | | |
| Integrated Disposal Facility | 2006 | 2008 | 200E | 5.23×10^{-1} | 7.29×10^{-2} | 2.95×10^{-3} | 8.96×10^{-2} | a | 7.32×10^{-2} | 3.34×10^{-2} |
| River Protection Project Disposal Facility | 2019 | 2021 | 200EW | 4.72×10^{-1} | 6.57×10^{-2} | 2.66×10^{-3} | 8.08×10^{-2} | a | 6.61×10^{-2} | 3.01×10^{-2} |
| Operations | | | | | | | | | | |
| Low-level radioactive waste burial grounds | 2007 | 2050 | 200W | 9.85×10^{-3} | 1.47×10^{-3} | 5.59×10^{-5} | 1.71×10^{-3} | a | 2.92×10^{-3} | 1.06×10^{-3} |
| Integrated Disposal Facility | 2009 | 2050 | 200E | 1.17×10^{-1} | 1.72×10^{-2} | 6.62×10^{-4} | 2.03×10^{-2} | a | 3.23×10^{-2} | 1.20×10^{-2} |
| River Protection Project Disposal Facility | 2022 | 2050 | 200EW | 1.71×10^{-1} | 2.89×10^{-2} | 9.80×10^{-4} | 3.06×10^{-2} | a | 1.08×10^{-1} | 3.45×10^{-2} |
| Closure | | | | | | | | | | |
| Integrated Disposal Facility | 2051 | 2052 | 200E | 2.48 | 5.58×10^{-1} | 1.45×10^{-2} | 4.80×10^{-1} | a | 3.87 | 1.15 |
| Postclosure care, Integrated Disposal Facility | 2053 | 2152 | 200E | 1.31×10^{-2} | 3.99×10^{-3} | 7.91×10^{-5} | 2.79×10^{-3} | a | 3.79×10^{-2} | 1.10×10^{-2} |
| River Protection Project Disposal Facility | 2051 | 2052 | 200EW | 2.24 | 5.03×10^{-1} | 1.31×10^{-2} | 4.33×10^{-1} | a | 3.50 | 1.04 |
| Postclosure care, River Protection Project Disposal Facility | 2053 | 2152 | 200EW | 1.18×10^{-2} | 3.60×10^{-3} | 7.14×10^{-5} | 2.52×10^{-3} | a | 3.42×10^{-2} | 9.91×10^{-3} |

^a Emissions for this activity and pollutant were not calculated because annual fuel use for this activity and the resulting emissions would be small compared with those of other activities or would be zero.

Key: 200E=200-East Area; 200W=200-West Area; 200EW=200-East and 200-West Areas.

Source: SAIC 2007c.

Table G-51. Waste Management Alternative 2, Disposal Group 2, Criteria Pollutant Emissions

| Facility/System | Start Year | End Year | Location | Emission Rate (metric tons per year) | | | | |
|--|------------|----------|----------|--------------------------------------|----------------------|-----------------------|-----------------------|-----------------------|
| | | | | Carbon Monoxide | Nitrogen Dioxide | PM ₁₀ | Sulfur Dioxide | VOCs |
| Construction | | | | | | | | |
| Integrated Disposal Facility | 2006 | 2008 | 200E | 3.28×10 ¹ | 1.17×10 ² | 7.52×10 ² | 5.00×10 ⁻² | 9.92 |
| River Protection Project Disposal Facility | 2019 | 2021 | 200EW | 6.49×10 ² | 2.32×10 ³ | 1.49×10 ⁴ | 9.89×10 ⁻¹ | 1.96×10 ² |
| Operations | | | | | | | | |
| Low-level radioactive waste burial grounds | 2007 | 2050 | 200W | 2.52 | 6.24 | 8.14×10 ¹ | 3.70×10 ⁻³ | 5.64×10 ⁻¹ |
| Integrated Disposal Facility | 2009 | 2100 | 200E | 1.02×10 ¹ | 2.61×10 ¹ | 7.46×10 ² | 1.50×10 ⁻² | 2.34 |
| River Protection Project Disposal Facility | 2022 | 2100 | 200EW | 5.62×10 ² | 8.35×10 ² | 1.27×10 ³ | 7.95×10 ⁻¹ | 8.59×10 ¹ |
| Closure | | | | | | | | |
| Integrated Disposal Facility | 2101 | 2102 | 200E | 7.81×10 ² | 5.42×10 ² | 1.18×10 ² | 1.07 | 7.51×10 ¹ |
| Postclosure care, Integrated Disposal Facility | 2103 | 2202 | 200E | 7.22 | 2.78 | 1.94×10 ⁻¹ | 9.80×10 ⁻³ | 5.35×10 ⁻¹ |
| River Protection Project Disposal Facility | 2101 | 2102 | 200EW | 1.54×10 ⁴ | 1.07×10 ⁴ | 2.34×10 ³ | 2.12×10 ¹ | 1.49×10 ³ |
| Postclosure care, River Protection Project Disposal Facility | 2103 | 2202 | 200EW | 1.43×10 ² | 5.51×10 ¹ | 3.84 | 1.94×10 ⁻¹ | 1.06×10 ¹ |

Key: 200E=200-East Area; 200W=200-West Area; 200EW=200-East and 200-West Areas; PM₁₀=particulate matter with an aerodynamic diameter less than or equal to 10 micrometers; VOC=volatile organic compound.

Source: SAIC 2007c.

Table G-52. Waste Management Alternative 2, Disposal Group 2, Toxic Pollutant Emissions

| Facility/System | Start Year | End Year | Location | Emission Rate (metric tons per year) | | | | | | |
|--|------------|----------|----------|--------------------------------------|-----------------------|-----------------------|-----------------------|---------|-----------------------|-----------------------|
| | | | | Ammonia | Benzene | 1,3-Butadiene | Formaldehyde | Mercury | Toluene | Xylene |
| Construction | | | | | | | | | | |
| Integrated Disposal Facility | 2006 | 2008 | 200E | 1.85×10^{-1} | 2.57×10^{-2} | 1.04×10^{-3} | 3.17×10^{-2} | a | 2.59×10^{-2} | 1.18×10^{-2} |
| River Protection Project Disposal Facility | 2019 | 2021 | 200EW | 3.65 | 5.09×10^{-1} | 2.06×10^{-2} | 6.26×10^{-1} | a | 5.12×10^{-1} | 2.34×10^{-1} |
| Operations | | | | | | | | | | |
| Low-level radioactive waste burial grounds | 2007 | 2050 | 200W | 9.85×10^{-3} | 1.47×10^{-3} | 5.59×10^{-5} | 1.71×10^{-3} | a | 2.92×10^{-3} | 1.06×10^{-3} |
| Integrated Disposal Facility | 2009 | 2100 | 200E | 4.13×10^{-2} | 6.09×10^{-3} | 2.34×10^{-4} | 7.16×10^{-3} | a | 1.14×10^{-2} | 4.22×10^{-3} |
| River Protection Project Disposal Facility | 2022 | 2100 | 200EW | 1.33 | 2.24×10^{-1} | 7.59×10^{-3} | 2.37×10^{-1} | a | 8.36×10^{-1} | 2.68×10^{-1} |
| Closure | | | | | | | | | | |
| Integrated Disposal Facility | 2101 | 2102 | 200E | 8.77×10^{-1} | 1.97×10^{-1} | 5.14×10^{-3} | 1.69×10^{-1} | a | 1.37 | 4.07×10^{-1} |
| Postclosure care, Integrated Disposal Facility | 2103 | 2202 | 200E | 4.62×10^{-3} | 1.41×10^{-3} | 2.80×10^{-5} | 9.87×10^{-4} | a | 1.34×10^{-2} | 3.88×10^{-3} |
| River Protection Project Disposal Facility | 2101 | 2102 | 200EW | 1.74×10^1 | 3.90 | 1.02×10^{-1} | 3.35 | a | 2.71×10^1 | 8.05 |
| Postclosure care, River Protection Project Disposal Facility | 2103 | 2202 | 200EW | 9.14×10^{-2} | 2.79×10^{-2} | 5.53×10^{-4} | 1.95×10^{-2} | a | 2.65×10^{-1} | 7.68×10^{-2} |

^a Emissions for this activity and pollutant were not calculated because annual fuel use for this activity and the resulting emissions would be small compared with those of other activities or would be zero.

Key: 200E=200-East Area; 200W=200-West Area; 200EW=200-East and 200-West Areas.

Source: SAIC 2007c.

Table G-53. Waste Management Alternative 2, Disposal Group 3, Criteria Pollutant Emissions

| Facility/System | Start Year | End Year | Location | Emission Rate (metric tons per year) | | | | |
|---|------------|----------|----------|--------------------------------------|----------------------|-----------------------|-----------------------|-----------------------|
| | | | | Carbon Monoxide | Nitrogen Dioxide | PM ₁₀ | Sulfur Dioxide | VOCs |
| Construction | | | | | | | | |
| Integrated Disposal Facility | 2006 | 2008 | 200E | 3.28×10 ¹ | 1.17×10 ² | 7.52×10 ² | 5.00×10 ⁻² | 9.92 |
| River Protection Project Disposal Facility | 2019 | 2021 | 200EW | 6.49×10 ² | 2.32×10 ³ | 1.49×10 ⁴ | 9.89×10 ⁻¹ | 1.96×10 ² |
| Operations | | | | | | | | |
| Low-level radioactive waste burial grounds | 2007 | 2050 | 200W | 2.52 | 6.24 | 8.14×10 ¹ | 3.70×10 ⁻³ | 5.64×10 ⁻¹ |
| Integrated Disposal Facility | 2009 | 2165 | 200E | 1.02×10 ¹ | 2.61×10 ¹ | 7.46×10 ² | 1.50×10 ⁻² | 2.34 |
| River Protection Project Disposal Facility | 2022 | 2165 | 200EW | 5.62×10 ² | 8.35×10 ² | 1.27×10 ³ | 7.95×10 ⁻¹ | 8.59×10 ¹ |
| Closure | | | | | | | | |
| Integrated Disposal Facility | 2166 | 2167 | 200E | 7.81×10 ² | 5.42×10 ² | 1.18×10 ² | 1.07 | 7.51×10 ¹ |
| Postclosure care, Integrated Disposal Facility | 2168 | 2267 | 200E | 7.22 | 2.78 | 1.94×10 ⁻¹ | 9.80×10 ⁻³ | 5.35×10 ⁻¹ |
| River Protection Project Disposal Facility | 2166 | 2167 | 200EW | 1.54×10 ⁴ | 1.07×10 ⁴ | 2.34×10 ³ | 2.12×10 ¹ | 1.49×10 ³ |
| Postclosure care, River Project Disposal Facility | 2168 | 2267 | 200EW | 1.43×10 ² | 5.51×10 ¹ | 3.84 | 1.94×10 ⁻¹ | 1.06×10 ¹ |

Key: 200E=200-East Area; 200W=200-West Area; 200EW=200-East and 200-West Areas; PM₁₀=particulate matter with an aerodynamic diameter less than or equal to 10 micrometers; VOC=volatile organic compound.

Source: SAIC 2007c.

Table G-54. Waste Management Alternative 2, Disposal Group 3, Toxic Pollutant Emissions

| Facility/System | Start Year | End Year | Location | Emission Rate (metric tons per year) | | | | | | |
|---|------------|----------|----------|--------------------------------------|-----------------------|-----------------------|-----------------------|---------|-----------------------|-----------------------|
| | | | | Ammonia | Benzene | 1,3-Butadiene | Formaldehyde | Mercury | Toluene | Xylene |
| Construction | | | | | | | | | | |
| Integrated Disposal Facility | 2006 | 2008 | 200E | 1.85×10^{-1} | 2.57×10^{-2} | 1.04×10^{-3} | 3.17×10^{-2} | a | 2.59×10^{-2} | 1.18×10^{-2} |
| River Protection Project Disposal Facility | 2019 | 2021 | 200EW | 3.65 | 5.09×10^{-1} | 2.06×10^{-2} | 6.26×10^{-1} | a | 5.12×10^{-1} | 2.34×10^{-1} |
| Operations | | | | | | | | | | |
| Low-level radioactive waste burial grounds | 2007 | 2050 | 200W | 9.85×10^{-3} | 1.47×10^{-3} | 5.59×10^{-5} | 1.71×10^{-3} | a | 2.92×10^{-3} | 1.06×10^{-3} |
| Integrated Disposal Facility | 2009 | 2165 | 200E | 4.13×10^{-2} | 6.09×10^{-3} | 2.34×10^{-4} | 7.16×10^{-3} | a | 1.14×10^{-2} | 4.22×10^{-3} |
| River Protection Project Disposal Facility | 2022 | 2165 | 200EW | 1.33 | 2.24×10^{-1} | 7.59×10^{-3} | 2.37×10^{-1} | a | 8.36×10^{-1} | 2.68×10^{-1} |
| Closure | | | | | | | | | | |
| Integrated Disposal Facility | 2166 | 2167 | 200E | 8.77×10^{-1} | 1.97×10^{-1} | 5.14×10^{-3} | 1.69×10^{-1} | a | 1.37 | 4.07×10^{-1} |
| Postclosure care, Integrated Disposal Facility | 2168 | 2267 | 200E | 4.62×10^{-3} | 1.41×10^{-3} | 2.80×10^{-5} | 9.87×10^{-4} | a | 1.34×10^{-2} | 3.88×10^{-3} |
| River Protection Project Disposal Facility | 2166 | 2167 | 200EW | 1.74×10^1 | 3.90 | 1.02×10^{-1} | 3.35 | a | 2.71×10^1 | 8.05 |
| Postclosure care, River Protection Project Disposal Facility | 2168 | 2267 | 200EW | 9.14×10^{-2} | 2.79×10^{-2} | 5.53×10^{-4} | 1.95×10^{-2} | a | 2.65×10^{-1} | 7.68×10^{-2} |

^a Emissions for this activity and pollutant were not calculated because annual fuel use for this activity and the resulting emissions would be small compared with those of other activities or would be zero.

Key: 200E=200-East Area; 200W=200-West Area; 200EW=200-East and 200-West Areas.

Source: SAIC 2007c.

Table G-55. Waste Management Alternative 3 (Treatment and Storage) Criteria Pollutant Emissions

| Facility/System | Start Year | End Year | Location | Emission Rate (metric tons per year) | | | | |
|---|------------|----------|----------|--------------------------------------|-----------------------|----------------------|-----------------------|-----------------------|
| | | | | Carbon Monoxide | Nitrogen Dioxide | PM ₁₀ | Sulfur Dioxide | VOCs |
| Construction | | | | | | | | |
| T Plant complex expansion | 2011 | 2012 | 200W | 6.27×10 ¹ | 1.16×10 ¹ | 2.69×10 ¹ | 8.46×10 ⁻² | 3.75 |
| Contact-Handled Mixed TRU/TRU waste facility (WRAP expansion) | 2011 | 2012 | 200W | 7.15×10 ² | 1.33×10 ² | 1.27×10 ² | 9.64×10 ⁻¹ | 4.27×10 ¹ |
| Remote-Handled Mixed TRU/TRU waste facility (WRAP expansion) | 2013 | 2018 | 200W | 5.26×10 ² | 7.62×10 ¹ | 8.10×10 ¹ | 7.08×10 ⁻¹ | 2.99×10 ¹ |
| Central Waste Complex expansion | 2011 | 2012 | 200W | 2.38×10 ² | 4.42×10 ¹ | 4.22×10 ¹ | 3.21×10 ⁻¹ | 1.42×10 ¹ |
| Operations | | | | | | | | |
| T Plant complex expansion | 2013 | 2050 | 200W | 1.05×10 ² | 4.87×10 ² | 4.30×10 ¹ | 1.66×10 ⁻¹ | 3.98×10 ¹ |
| Contact-Handled Mixed TRU/TRU waste facility (WRAP expansion) | 2013 | 2050 | 200W | 2.83×10 ⁻¹ | 1.31 | 1.14×10 ² | 4.47×10 ⁻⁴ | 1.07×10 ⁻¹ |
| Remote-Handled Mixed TRU/TRU waste facility (WRAP expansion) | 2019 | 2050 | 200W | 1.13×10 ⁻¹ | 5.25×10 ⁻¹ | 1.14×10 ² | 1.79×10 ⁻⁴ | 4.29×10 ⁻² |
| Central Waste Complex expansion | 2013 | 2050 | 200W | 6.04×10 ¹ | 1.15×10 ¹ | 4.91×10 ² | 8.15×10 ⁻² | 3.63 |
| Deactivation | | | | | | | | |
| T Plant complex expansion | 2051 | 2051 | 200W | 7.48 | 9.89 | 5.05 | 1.05×10 ⁻² | 1.06 |
| Contact-Handled Mixed TRU/TRU waste facility (WRAP expansion) | 2051 | 2051 | 200W | 1.41×10 ⁻¹ | 6.56×10 ⁻¹ | 9.48×10 ¹ | 2.23×10 ⁻⁴ | 5.36×10 ⁻² |
| Remote-Handled Mixed TRU/TRU waste facility (WRAP expansion) | 2051 | 2051 | 200W | 5.66×10 ⁻² | 2.63×10 ⁻¹ | 3.79×10 ¹ | 8.93×10 ⁻⁵ | 2.14×10 ⁻² |
| Central Waste Complex expansion | 2051 | 2051 | 200W | 3.02×10 ¹ | 5.75 | 1.02×10 ¹ | 4.07×10 ⁻² | 1.82 |

Key: 200W=200-West Area; PM₁₀=particulate matter with an aerodynamic diameter less than or equal to 10 micrometers; TRU=transuranic; VOC=volatile organic compound; WRAP=Waste Receiving and Processing Facility.

Source: SAIC 2007c.

Table G-56. Waste Management Alternative 3 (Treatment and Storage) Toxic Pollutant Emissions

| Facility/System | Start Year | End Year | Location | Emission Rate (metric tons per year) | | | | | | |
|---|------------|----------|----------|--------------------------------------|-----------------------|-----------------------|-----------------------|---------|-----------------------|-----------------------|
| | | | | Ammonia | Benzene | 1,3-Butadiene | Formaldehyde | Mercury | Toluene | Xylene |
| Construction | | | | | | | | | | |
| T Plant complex expansion | 2011 | 2012 | 200W | 2.05×10^{-2} | 9.92×10^{-3} | 1.33×10^{-4} | 5.32×10^{-3} | a | 1.21×10^{-1} | 3.45×10^{-2} |
| Contact-Handled Mixed TRU/TRU waste facility (WRAP expansion) | 2011 | 2012 | 200W | 2.34×10^{-1} | 1.13×10^{-1} | 1.51×10^{-3} | 6.06×10^{-2} | a | 1.38 | 3.93×10^{-1} |
| Remote-Handled Mixed TRU/TRU waste facility (WRAP expansion) | 2013 | 2018 | 200W | 1.38×10^{-1} | 7.93×10^{-2} | 5.57×10^{-3} | 2.34×10^{-1} | a | 1.02 | 2.90×10^{-1} |
| Central Waste Complex expansion | 2011 | 2012 | 200W | 7.79×10^{-2} | 3.77×10^{-2} | 5.05×10^{-4} | 2.02×10^{-2} | a | 4.59×10^{-1} | 1.31×10^{-1} |
| Operations | | | | | | | | | | |
| T Plant complex expansion | 2013 | 2050 | 200W | 7.66×10^{-1} | 1.03×10^{-1} | 4.32×10^{-3} | 1.30×10^{-1} | a | 4.52×10^{-2} | 3.15×10^{-2} |
| Contact-Handled Mixed TRU/TRU waste facility (WRAP expansion) | 2013 | 2050 | 200W | 2.06×10^{-3} | 2.78×10^{-4} | 1.16×10^{-5} | 3.51×10^{-4} | a | 1.22×10^{-4} | 8.48×10^{-5} |
| Remote-Handled Mixed TRU/TRU waste facility (WRAP expansion) | 2019 | 2050 | 200W | 8.26×10^{-4} | 1.11×10^{-4} | 4.66×10^{-6} | 1.41×10^{-4} | a | 4.87×10^{-5} | 3.39×10^{-5} |
| Central Waste Complex expansion | 2013 | 2050 | 200W | 2.02×10^{-2} | 9.62×10^{-3} | 1.31×10^{-4} | 5.20×10^{-3} | a | 1.16×10^{-1} | 3.32×10^{-2} |
| Deactivation | | | | | | | | | | |
| T Plant complex expansion | 2051 | 2051 | 200W | 3.11×10^{-1} | 2.76×10^{-3} | 9.03×10^{-5} | 2.84×10^{-3} | a | 1.16×10^{-2} | 3.63×10^{-3} |
| Contact-Handled Mixed TRU/TRU waste facility (WRAP expansion) | 2051 | 2051 | 200W | 1.03×10^{-3} | 1.39×10^{-4} | 5.82×10^{-6} | 1.76×10^{-4} | a | 6.09×10^{-5} | 4.24×10^{-5} |
| Remote-Handled Mixed TRU/TRU waste facility (WRAP expansion) | 2051 | 2051 | 200W | 4.13×10^{-4} | 5.56×10^{-5} | 2.33×10^{-6} | 7.03×10^{-5} | a | 2.44×10^{-5} | 1.70×10^{-5} |
| Central Waste Complex expansion | 2051 | 2051 | 200W | 1.01×10^{-2} | 4.81×10^{-3} | 6.53×10^{-5} | 2.60×10^{-3} | a | 5.81×10^{-2} | 1.66×10^{-2} |

^a Emissions for this activity and pollutant were not calculated because annual fuel use for this activity and the resulting emissions would be small compared with those of other activities or would be zero.

Key: 200W=200-West Area; TRU=transuranic; WRAP=Waste Receiving and Processing Facility.

Source: SAIC 2007c.

Table G-57. Waste Management Alternative 3, Disposal Group 1, Criteria Pollutant Emissions

| Facility/System | Start Year | End Year | Location | Emission Rate (metric tons per year) | | | | |
|---|------------|----------|----------|--------------------------------------|-----------------------|-----------------------|-----------------------|-----------------------|
| | | | | Carbon Monoxide | Nitrogen Dioxide | PM ₁₀ | Sulfur Dioxide | VOCs |
| Construction | | | | | | | | |
| Integrated Disposal Facility, 200-East Area | 2006 | 2008 | 200EW | 1.24×10 ² | 4.84×10 ² | 1.97×10 ³ | 1.91×10 ⁻¹ | 4.04×10 ¹ |
| Integrated Disposal Facility, 200-West Area | 2006 | 2008 | 200EW | 1.01×10 ² | 4.62×10 ² | 1.91×10 ² | 1.59×10 ⁻¹ | 3.78×10 ¹ |
| River Protection Project Disposal Facility | 2019 | 2021 | 200EW | 8.38×10 ¹ | 2.99×10 ² | 1.92×10 ³ | 1.28×10 ⁻¹ | 2.53×10 ¹ |
| Operations | | | | | | | | |
| Low-level radioactive waste burial grounds | 2007 | 2050 | 200W | 2.52 | 6.24 | 8.14×10 ¹ | 3.70×10 ⁻³ | 5.64×10 ⁻¹ |
| Integrated Disposal Facility, 200-East Area | 2009 | 2050 | 200E | 2.74×10 ¹ | 7.28×10 ¹ | 1.94×10 ³ | 4.05×10 ⁻² | 6.49 |
| Integrated Disposal Facility, 200-West Area | 2009 | 2050 | 200W | 9.00 | 3.73×10 ¹ | 1.61×10 ² | 1.40×10 ⁻² | 3.09 |
| River Protection Project Disposal Facility | 2022 | 2050 | 200EW | 7.25×10 ¹ | 1.08×10 ² | 1.64×10 ² | 1.03×10 ⁻¹ | 1.11×10 ¹ |
| Closure | | | | | | | | |
| Integrated Disposal Facility, 200-East Area | 2051 | 2052 | 200E | 2.05×10 ³ | 1.45×10 ³ | 3.09×10 ² | 2.82 | 1.99×10 ² |
| Integrated Disposal Facility, 200-West Area | 2051 | 2052 | 200W | 2.25×10 ² | 2.14×10 ² | 3.20×10 ¹ | 3.13×10 ⁻¹ | 2.58×10 ¹ |
| Postclosure care, Integrated Disposal Facility, 200-East Area | 2053 | 2152 | 200E | 1.87×10 ¹ | 7.23 | 5.04×10 ⁻¹ | 2.54×10 ⁻² | 1.39 |
| Postclosure care, Integrated Disposal Facility, 200-West Area | 2053 | 2152 | 200W | 1.54 | 5.92×10 ⁻¹ | 4.13×10 ⁻² | 2.09×10 ⁻³ | 1.14×10 ⁻¹ |
| River Protection Project Disposal Facility | 2051 | 2052 | 200EW | 1.99×10 ³ | 1.39×10 ³ | 3.01×10 ² | 2.74 | 1.92×10 ² |
| Postclosure care, River Protection Project Disposal Facility | 2053 | 2152 | 200EW | 1.84×10 ¹ | 7.11 | 4.96×10 ⁻¹ | 2.50×10 ⁻² | 1.37 |

Key: 200E=200-East Area; 200W=200-West Area; 200EW=200-East and 200-West Areas; PM₁₀=particulate matter with an aerodynamic diameter less than or equal to 10 micrometers; VOC=volatile organic compound.

Source: SAIC 2007c.

Table G-58. Waste Management Alternative 3, Disposal Group 1, Toxic Pollutant Emissions

| Facility/System | Start Year | End Year | Location | Emission Rate (metric tons per year) | | | | | | |
|---|------------|----------|----------|--------------------------------------|-----------------------|-----------------------|-----------------------|---------|-----------------------|-----------------------|
| | | | | Ammonia | Benzene | 1,3-Butadiene | Formaldehyde | Mercury | Toluene | Xylene |
| Construction | | | | | | | | | | |
| Integrated Disposal Facility, 200-East Area | 2006 | 2008 | 200EW | 7.62×10^{-1} | 1.05×10^{-1} | 4.30×10^{-3} | 1.30×10^{-1} | a | 8.38×10^{-2} | 4.22×10^{-2} |
| Integrated Disposal Facility, 200-West Area | 2006 | 2008 | 200EW | 7.27×10^{-1} | 9.80×10^{-2} | 4.10×10^{-3} | 1.24×10^{-1} | a | 4.61×10^{-2} | 3.08×10^{-2} |
| River Protection Project Disposal Facility | 2019 | 2021 | 200EW | 4.72×10^{-1} | 6.57×10^{-2} | 2.66×10^{-3} | 8.08×10^{-2} | a | 6.61×10^{-2} | 3.01×10^{-2} |
| Operations | | | | | | | | | | |
| Low-level radioactive waste burial grounds | 2007 | 2050 | 200W | 9.85×10^{-3} | 1.47×10^{-3} | 5.59×10^{-5} | 1.71×10^{-3} | a | 2.92×10^{-3} | 1.06×10^{-3} |
| Integrated Disposal Facility, 200-East Area | 2009 | 2050 | 200E | 1.15×10^{-1} | 1.69×10^{-2} | 6.52×10^{-4} | 1.99×10^{-2} | a | 3.01×10^{-2} | 1.13×10^{-2} |
| Integrated Disposal Facility, 200-West Area | 2009 | 2050 | 200W | 5.87×10^{-2} | 8.01×10^{-3} | 3.31×10^{-4} | 1.00×10^{-2} | a | 5.37×10^{-3} | 2.95×10^{-3} |
| River Protection Project Disposal Facility | 2022 | 2050 | 200EW | 1.71×10^{-1} | 2.89×10^{-2} | 9.80×10^{-4} | 3.06×10^{-2} | a | 1.08×10^{-1} | 3.45×10^{-2} |
| Closure | | | | | | | | | | |
| Integrated Disposal Facility, 200-East Area | 2051 | 2052 | 200E | 2.34 | 5.22×10^{-1} | 1.37×10^{-2} | 4.51×10^{-1} | a | 3.59 | 1.07 |
| Integrated Disposal Facility, 200-West Area | 2051 | 2052 | 200W | 3.43×10^{-1} | 6.74×10^{-2} | 1.98×10^{-3} | 6.37×10^{-2} | a | 3.76×10^{-1} | 1.14×10^{-1} |
| Postclosure care, Integrated Disposal Facility, 200-East Area | 2053 | 2152 | 200E | 1.20×10^{-2} | 3.66×10^{-3} | 7.26×10^{-5} | 2.56×10^{-3} | a | 3.48×10^{-2} | 1.01×10^{-2} |
| Postclosure care, Integrated Disposal Facility, 200-West Area | 2053 | 2152 | 200W | 9.83×10^{-4} | 3.00×10^{-4} | 5.95×10^{-6} | 2.10×10^{-4} | a | 2.85×10^{-3} | 8.26×10^{-4} |
| River Protection Project Disposal Facility | 2051 | 2052 | 200EW | 2.24 | 5.03×10^{-1} | 1.31×10^{-2} | 4.33×10^{-1} | a | 3.50 | 1.04 |
| Postclosure care, River Protection Project Disposal Facility | 2053 | 2152 | 200EW | 1.18×10^{-2} | 3.60×10^{-3} | 7.14×10^{-5} | 2.52×10^{-3} | a | 3.42×10^{-2} | 9.91×10^{-3} |

^a Emissions for this activity and pollutant were not calculated because annual fuel use for this activity and the resulting emissions would be small compared with other activities or would be zero.

Key: 200E=200-East Area; 200W=200-West Area; 200EW=200-East and 200-West Areas.

Source: SAIC 2007c.

Table G-59. Waste Management Alternative 3, Disposal Group 2, Criteria Pollutant Emissions

| Facility/System | Start Year | End Year | Location | Emission Rate (metric tons per year) | | | | |
|---|------------|----------|----------|--------------------------------------|-----------------------|-----------------------|-----------------------|-----------------------|
| | | | | Carbon Monoxide | Nitrogen Dioxide | PM ₁₀ | Sulfur Dioxide | VOCs |
| Construction | | | | | | | | |
| Integrated Disposal Facility, 200-East Area | 2006 | 2008 | 200EW | 1.07×10 ² | 4.68×10 ² | 6.35×10 ² | 1.67×10 ⁻¹ | 3.85×10 ¹ |
| Integrated Disposal Facility, 200-West Area | 2006 | 2008 | 200EW | 1.01×10 ² | 4.62×10 ² | 1.91×10 ² | 1.59×10 ⁻¹ | 3.78×10 ¹ |
| River Protection Project Disposal Facility | 2019 | 2021 | 200EW | 6.49×10 ² | 2.32×10 ³ | 1.49×10 ⁴ | 9.89×10 ⁻¹ | 1.96×10 ² |
| Operations | | | | | | | | |
| Low-level radioactive waste burial grounds | 2007 | 2050 | 200W | 2.52 | 6.24 | 8.14×10 ¹ | 3.70×10 ⁻³ | 5.64×10 ⁻¹ |
| Integrated Disposal Facility, 200-East Area | 2009 | 2100 | 200E | 9.62 | 2.76×10 ¹ | 6.04×10 ² | 1.43×10 ⁻² | 2.43 |
| Integrated Disposal Facility, 200-West Area | 2009 | 2050 | 200W | 9.00 | 3.73×10 ¹ | 1.61×10 ² | 1.40×10 ⁻² | 3.09 |
| River Protection Project Disposal Facility | 2022 | 2100 | 200EW | 5.62×10 ² | 8.35×10 ² | 1.27×10 ³ | 7.95×10 ⁻¹ | 8.59×10 ¹ |
| Closure | | | | | | | | |
| Integrated Disposal Facility, 200-East Area | 2101 | 2102 | 200E | 6.82×10 ² | 5.22×10 ² | 1.01×10 ² | 9.39×10 ⁻¹ | 6.91×10 ¹ |
| Integrated Disposal Facility, 200-West Area | 2051 | 2052 | 200W | 2.25×10 ² | 2.14×10 ² | 3.20×10 ¹ | 3.13×10 ⁻¹ | 2.58×10 ¹ |
| Postclosure care, Integrated Disposal Facility, 200-East Area | 2103 | 2202 | 200E | 5.83 | 2.25 | 1.57×10 ⁻¹ | 7.92×10 ⁻³ | 4.32×10 ⁻¹ |
| Postclosure care, Integrated Disposal Facility, 200-West Area | 2053 | 2152 | 200W | 1.54 | 5.92×10 ⁻¹ | 4.13×10 ⁻² | 2.09×10 ⁻³ | 1.14×10 ⁻¹ |
| River Protection Project Disposal Facility | 2101 | 2102 | 200EW | 1.54×10 ⁴ | 1.07×10 ⁴ | 2.34×10 ³ | 2.12×10 ¹ | 1.49×10 ³ |
| Postclosure care, River Protection Project Disposal Facility | 2103 | 2202 | 200EW | 1.43×10 ² | 5.51×10 ¹ | 3.84 | 1.94×10 ⁻¹ | 1.06×10 ¹ |

Key: 200E=200-East Area; 200W=200-West Area; 200EW=200-East and 200-West Areas; PM₁₀=particulate matter with an aerodynamic diameter less than or equal to 10 micrometers; VOC=volatile organic compound.

Source: SAIC 2007c.

Table G-60. Waste Management Alternative 3, Disposal Group 2, Toxic Pollutant Emissions

| Facility/System | Start Year | End Year | Location | Emission Rate (metric tons per year) | | | | | | |
|---|------------|----------|----------|--------------------------------------|-----------------------|-----------------------|-----------------------|---------|-----------------------|-----------------------|
| | | | | Ammonia | Benzene | 1,3-Butadiene | Formaldehyde | Mercury | Toluene | Xylene |
| Construction | | | | | | | | | | |
| Integrated Disposal Facility, 200-East Area | 2006 | 2008 | 200EW | 7.36×10 ⁻¹ | 9.97×10 ⁻² | 4.15×10 ⁻³ | 1.25×10 ⁻¹ | a | 5.55×10 ⁻² | 3.36×10 ⁻² |
| Integrated Disposal Facility, 200-West Area | 2006 | 2008 | 200EW | 7.27×10 ⁻¹ | 9.80×10 ⁻² | 4.10×10 ⁻³ | 1.24×10 ⁻¹ | a | 4.61×10 ⁻² | 3.08×10 ⁻² |
| River Protection Project Disposal Facility | 2019 | 2021 | 200EW | 3.65 | 5.09×10 ⁻¹ | 2.06×10 ⁻² | 6.26×10 ⁻¹ | a | 5.12×10 ⁻¹ | 2.34×10 ⁻¹ |
| Operations | | | | | | | | | | |
| Low-level radioactive waste burial grounds | 2007 | 2050 | 200W | 9.85×10 ⁻³ | 1.47×10 ⁻³ | 5.59×10 ⁻⁵ | 1.71×10 ⁻³ | a | 2.92×10 ⁻³ | 1.06×10 ⁻³ |
| Integrated Disposal Facility, 200-East Area | 2009 | 2100 | 200E | 4.36×10 ⁻² | 6.30×10 ⁻³ | 2.47×10 ⁻⁴ | 7.53×10 ⁻³ | a | 9.84×10 ⁻³ | 3.84×10 ⁻³ |
| Integrated Disposal Facility, 200-West Area | 2009 | 2050 | 200W | 5.87×10 ⁻² | 8.01×10 ⁻³ | 3.31×10 ⁻⁴ | 1.00×10 ⁻² | a | 5.37×10 ⁻³ | 2.95×10 ⁻³ |
| River Protection Project Disposal Facility | 2022 | 2100 | 200EW | 1.33 | 2.24×10 ⁻¹ | 7.59×10 ⁻³ | 2.37×10 ⁻¹ | a | 8.36×10 ⁻¹ | 2.68×10 ⁻¹ |
| Closure | | | | | | | | | | |
| Integrated Disposal Facility, 200-East Area | 2101 | 2102 | 200E | 8.42×10 ⁻¹ | 1.81×10 ⁻¹ | 4.91×10 ⁻³ | 1.61×10 ⁻¹ | a | 1.18 | 3.52×10 ⁻¹ |
| Integrated Disposal Facility, 200-West Area | 2051 | 2052 | 200W | 3.43×10 ⁻¹ | 6.74×10 ⁻² | 1.98×10 ⁻³ | 6.37×10 ⁻² | a | 3.76×10 ⁻¹ | 1.14×10 ⁻¹ |
| Postclosure care, Integrated Disposal Facility, 200-East Area | 2103 | 2202 | 200E | 3.74×10 ⁻³ | 1.14×10 ⁻³ | 2.26×10 ⁻⁵ | 7.98×10 ⁻⁴ | a | 1.08×10 ⁻² | 3.14×10 ⁻³ |
| Postclosure care, Integrated Disposal Facility, 200-West Area | 2053 | 2152 | 200W | 9.83×10 ⁻⁴ | 3.00×10 ⁻⁴ | 5.95×10 ⁻⁶ | 2.10×10 ⁻⁴ | a | 2.85×10 ⁻³ | 8.26×10 ⁻⁴ |
| River Protection Project Disposal Facility | 2101 | 2102 | 200EW | 1.74×10 ¹ | 3.90 | 1.02×10 ⁻¹ | 3.35 | a | 2.71×10 ¹ | 8.05 |
| Postclosure care, River Protection Project Disposal Facility | 2103 | 2202 | 200EW | 9.14×10 ⁻² | 2.79×10 ⁻² | 5.53×10 ⁻⁴ | 1.95×10 ⁻² | a | 2.65×10 ⁻¹ | 7.68×10 ⁻² |

^a Emissions for this activity and pollutant were not calculated because annual fuel use for this activity and the resulting emissions would be small compared with other activities or would be zero.

Key: 200E=200-East Area; 200W=200-West Area.

Source: SAIC 2007c.

Table G-61. Waste Management Alternative 3, Disposal Group 3, Criteria Pollutant Emissions

| Facility/System | Start Year | End Year | Location | Emission Rate (metric tons per year) | | | | |
|---|------------|----------|----------|--------------------------------------|-----------------------|-----------------------|-----------------------|-----------------------|
| | | | | Carbon Monoxide | Nitrogen Dioxide | PM ₁₀ | Sulfur Dioxide | VOCs |
| Construction | | | | | | | | |
| Integrated Disposal Facility, 200-East Area | 2006 | 2008 | 200EW | 1.07×10 ² | 4.68×10 ² | 6.35×10 ² | 1.67×10 ⁻¹ | 3.85×10 ¹ |
| Integrated Disposal Facility, 200-West Area | 2006 | 2008 | 200EW | 1.01×10 ² | 4.62×10 ² | 1.91×10 ² | 1.59×10 ⁻¹ | 3.78×10 ¹ |
| River Protection Project Disposal Facility | 2019 | 2021 | 200EW | 6.49×10 ² | 2.32×10 ³ | 1.49×10 ⁴ | 9.89×10 ⁻¹ | 1.96×10 ² |
| Operations | | | | | | | | |
| Low-level radioactive waste burial grounds | 2007 | 2050 | 200W | 2.52 | 6.24 | 8.14×10 ¹ | 3.70×10 ⁻³ | 5.64×10 ⁻¹ |
| Integrated Disposal Facility, 200-East Area | 2009 | 2165 | 200E | 8.23 | 2.12×10 ¹ | 6.03×10 ² | 1.21×10 ⁻² | 1.90 |
| Integrated Disposal Facility, 200-West Area | 2009 | 2050 | 200W | 9.00 | 3.73×10 ¹ | 1.61×10 ² | 1.40×10 ⁻² | 3.09 |
| River Protection Project Disposal Facility | 2022 | 2165 | 200EW | 5.62×10 ² | 8.35×10 ² | 1.27×10 ³ | 7.95×10 ⁻¹ | 8.59×10 ¹ |
| Closure | | | | | | | | |
| Integrated Disposal Facility, 200-East Area | 2166 | 2167 | 200E | 6.82×10 ² | 5.22×10 ² | 1.01×10 ² | 9.39×10 ⁻¹ | 6.91×10 ¹ |
| Integrated Disposal Facility, 200-West Area | 2051 | 2052 | 200W | 2.25×10 ² | 2.14×10 ² | 3.20×10 ¹ | 3.13×10 ⁻¹ | 2.58×10 ¹ |
| Postclosure care, Integrated Disposal Facility, 200-East Area | 2168 | 2267 | 200E | 5.83 | 2.25 | 1.57×10 ⁻¹ | 7.92×10 ⁻³ | 4.32×10 ⁻¹ |
| Postclosure care, Integrated Disposal Facility, 200-West Area | 2053 | 2152 | 200W | 1.54 | 5.92×10 ⁻¹ | 4.13×10 ⁻² | 2.09×10 ⁻³ | 1.14×10 ⁻¹ |
| River Protection Project Disposal Facility | 2166 | 2167 | 200EW | 1.54×10 ⁴ | 1.07×10 ⁴ | 2.34×10 ³ | 2.12×10 ¹ | 1.49×10 ³ |
| Postclosure care, River Protection Project Disposal Facility | 2168 | 2267 | 200EW | 1.43×10 ² | 5.51×10 ¹ | 3.84 | 1.94×10 ⁻¹ | 1.06×10 ¹ |

Key: 200E=200-East Area; 200W=200-West Area; PM₁₀=particulate matter with an aerodynamic diameter less than or equal to 10 micrometers; PM₁₀=particulate matter with an aerodynamic diameter less than or equal to 10 micrometers; VOC=volatile organic compound.

Source: SAIC 2007c.

Table G-62. Waste Management Alternative 3, Disposal Group 3, Toxic Pollutant Emissions

| Facility/System | Start Year | End Year | Location | Emission Rate (metric tons per year) | | | | | | |
|---|------------|----------|----------|--------------------------------------|-----------------------|-----------------------|-----------------------|---------|-----------------------|-----------------------|
| | | | | Ammonia | Benzene | 1,3-Butadiene | Formaldehyde | Mercury | Toluene | Xylene |
| Construction | | | | | | | | | | |
| Integrated Disposal Facility, 200-East Area | 2006 | 2008 | 200EW | 7.36×10^{-1} | 9.97×10^{-2} | 4.15×10^{-3} | 1.25×10^{-1} | a | 5.55×10^{-2} | 3.36×10^{-2} |
| Integrated Disposal Facility, 200-West Area | 2006 | 2008 | 200EW | 7.27×10^{-1} | 9.80×10^{-2} | 4.10×10^{-3} | 1.24×10^{-1} | a | 4.61×10^{-2} | 3.08×10^{-2} |
| River Protection Project Disposal Facility | 2019 | 2021 | 200EW | 3.65 | 5.09×10^{-1} | 2.06×10^{-2} | 6.26×10^{-1} | a | 5.12×10^{-1} | 2.34×10^{-1} |
| Operations | | | | | | | | | | |
| Low-level radioactive waste burial grounds | 2007 | 2050 | 200W | 9.85×10^{-3} | 1.47×10^{-3} | 5.59×10^{-5} | 1.71×10^{-3} | a | 2.92×10^{-3} | 1.06×10^{-3} |
| Integrated Disposal Facility, 200-East Area | 2009 | 2165 | 200E | 3.35×10^{-2} | 4.94×10^{-3} | 1.90×10^{-4} | 5.80×10^{-3} | a | 9.24×10^{-3} | 3.42×10^{-3} |
| Integrated Disposal Facility, 200-West Area | 2009 | 2050 | 200W | 5.87×10^{-2} | 8.01×10^{-3} | 3.31×10^{-4} | 1.00×10^{-2} | a | 5.37×10^{-3} | 2.95×10^{-3} |
| River Protection Project Disposal Facility | 2022 | 2165 | 200EW | 1.33 | 2.24×10^{-1} | 7.59×10^{-3} | 2.37×10^{-1} | a | 8.36×10^{-1} | 2.68×10^{-1} |
| Closure | | | | | | | | | | |
| Integrated Disposal Facility, 200-East Area | 2166 | 2167 | 200E | 8.42×10^{-1} | 1.81×10^{-1} | 4.91×10^{-3} | 1.61×10^{-1} | a | 1.18 | 3.52×10^{-1} |
| Integrated Disposal Facility, 200-West Area | 2051 | 2052 | 200W | 3.43×10^{-1} | 6.74×10^{-2} | 1.98×10^{-3} | 6.37×10^{-2} | a | 3.76×10^{-1} | 1.14×10^{-1} |
| Postclosure care, Integrated Disposal Facility, 200-East Area | 2168 | 2267 | 200E | 3.74×10^{-3} | 1.14×10^{-3} | 2.26×10^{-5} | 7.98×10^{-4} | a | 1.08×10^{-2} | 3.14×10^{-3} |
| Postclosure care, Integrated Disposal Facility, 200-West Area | 2053 | 2152 | 200W | 9.83×10^{-4} | 3.00×10^{-4} | 5.95×10^{-6} | 2.10×10^{-4} | a | 2.85×10^{-3} | 8.26×10^{-4} |
| River Protection Project Disposal Facility | 2166 | 2167 | 200EW | 1.74×10^1 | 3.90 | 1.02×10^{-1} | 3.35 | a | 2.71×10^1 | 8.05 |
| Postclosure care, River Protection Project Disposal Facility | 2168 | 2267 | 200EW | 9.14×10^{-2} | 2.79×10^{-2} | 5.53×10^{-4} | 1.95×10^{-2} | a | 2.65×10^{-1} | 7.68×10^{-2} |

^a Emissions for this activity and pollutant were not calculated because annual fuel use for this activity and the resulting emissions would be small compared with other activities or would be zero.

Key: 200E=200-East Area; 200W=200-West Area.

Source: SAIC 2007c.

Table G-63. Tank Closure Alternative 1 Criteria Pollutant Emissions from Mobile Sources

| Facility/System | Start Year | End Year | Emission Rate (metric tons per year) | | | |
|-------------------------------|------------|----------|--------------------------------------|----------------------|----------------------|-----------------------|
| | | | Carbon Monoxide | Nitrogen Dioxide | PM ₁₀ | Sulfur Dioxide |
| Construction | | | | | | |
| Canister Storage Building | 2006 | 2008 | a | a | a | a |
| Other infrastructure upgrades | 2006 | 2008 | a | a | a | a |
| Tank upgrades | 2006 | 2008 | a | a | a | a |
| Waste Treatment Plant | 2006 | 2008 | 1.08×10 ¹ | 5.03×10 ¹ | 4.13×10 ² | 1.71×10 ⁻² |
| Operations | | | | | | |
| Routine operations | 2006 | 2008 | 3.10×10 ¹ | 1.44×10 ² | 1.32×10 ¹ | 4.73×10 ⁻² |
| Closure | | | | | | |
| Administrative controls | 2008 | 2107 | 5.99×10 ¹ | 2.81×10 ² | 2.54×10 ¹ | 9.07×10 ⁻² |

^a Emissions for this activity and pollutant were not calculated because annual fuel use for this activity and the resulting emissions would be small compared with other activities or would be zero.

Key: PM₁₀=particulate matter with an aerodynamic diameter less than or equal to 10 micrometers.

Source: SAIC 2007a, 2008.

Table G-64. Tank Closure Alternative 1 Toxic Pollutant Emissions from Mobile Sources

| Facility/System | Start Year | End Year | Emission Rate (metric tons per year) | | | | | | |
|-------------------------------|------------|----------|--------------------------------------|-----------------------|-----------------------|-----------------------|---------|-----------------------|-----------------------|
| | | | Ammonia | Benzene | 1,3-Butadiene | Formaldehyde | Mercury | Toluene | Xylene |
| Construction | | | | | | | | | |
| Canister Storage Building | 2006 | 2008 | a | a | a | a | a | a | a |
| Other infrastructure upgrades | 2006 | 2008 | a | a | a | a | a | a | a |
| Tank upgrades | 2006 | 2008 | a | a | a | a | a | a | a |
| Waste Treatment Plant | 2006 | 2008 | 7.91×10 ⁻² | 1.06×10 ⁻² | 4.46×10 ⁻⁴ | 2.24×10 ⁻² | a | 4.66×10 ⁻³ | 3.25×10 ⁻³ |
| Operations | | | | | | | | | |
| Routine operations | 2006 | 2008 | 2.26×10 ⁻¹ | 3.42×10 ⁻² | a | a | a | 1.50×10 ⁻² | 1.04×10 ⁻² |
| Closure | | | | | | | | | |
| Administrative controls | 2008 | 2107 | 4.35×10 ⁻¹ | 6.62×10 ⁻² | a | a | a | 2.90×10 ⁻² | 2.00×10 ⁻² |

^a Emissions for this activity and pollutant were not calculated because annual fuel use for this activity and the resulting emissions would be small compared with other activities or would be zero.

Source: SAIC 2007a, 2008.

Table G-65. Tank Closure Alternative 2A Criteria Pollutant Emissions from Mobile Sources

| Facility/System | Start Year | End Year | Emission Rate (metric tons per year) | | | |
|--|------------|----------|--------------------------------------|----------------------|----------------------|-----------------------|
| | | | Carbon Monoxide | Nitrogen Dioxide | PM ₁₀ | Sulfur Dioxide |
| Construction | | | | | | |
| Underground transfer lines | 2009 | 2009 | a | a | a | a |
| Canister Storage Building | 2006 | 2016 | a | a | a | a |
| IHLW Shipping/Transfer Facility | 2011 | 2013 | a | a | a | a |
| IHLW Interim Storage Modules | 2014 | 2019 | a | a | a | a |
| Other infrastructure upgrades | 2006 | 2034 | a | a | a | a |
| Tank upgrades | 2006 | 2025 | a | a | a | a |
| Waste Treatment Plant | 2006 | 2017 | 1.08×10 ¹ | 5.03×10 ¹ | 4.13×10 ² | 1.71×10 ⁻² |
| Cesium and Strontium Capsule Processing Facility | 2088 | 2091 | 3.13 | 1.28×10 ¹ | 4.24×10 ² | 4.85×10 ⁻³ |
| Tank risers | 2013 | 2056 | a | a | a | a |
| Modified sluicing retrieval system | 2013 | 2092 | a | a | a | a |
| Mobile retrieval system | 2013 | 2052 | a | a | a | a |
| Vacuum-based retrieval system | 2053 | 2092 | a | a | a | a |
| HLW Melter Interim Storage Facility 1 | 2015 | 2016 | a | a | a | a |
| HLW Melter Interim Storage Facility 2 | 2040 | 2041 | a | a | a | a |
| HLW Melter Interim Storage Facility 3 | 2065 | 2066 | a | a | a | a |
| Double-shell tank replacement | 2013 | 2054 | a | a | a | a |
| Waste Treatment Plant replacement | 2065 | 2076 | 2.17×10 ¹ | 1.01×10 ² | 8.26×10 ² | 3.42×10 ⁻² |
| Underground transfer line replacement | 2044 | 2044 | a | a | a | a |
| Effluent Treatment Facility replacement 1 | 2023 | 2025 | 1.25×10 ¹ | 1.34×10 ¹ | 4.75×10 ² | 1.74×10 ⁻² |
| Effluent Treatment Facility replacement 2 | 2053 | 2055 | 1.25×10 ¹ | 1.34×10 ¹ | 4.75×10 ² | 1.74×10 ⁻² |
| Evaporator replacement 1 | 2015 | 2017 | 3.62 | 2.96 | 1.41×10 ² | 5.00×10 ⁻³ |
| Evaporator replacement 2 | 2040 | 2042 | 3.61 | 2.95 | 2.80×10 ² | 4.98×10 ⁻³ |
| Evaporator replacement 3 | 2065 | 2067 | 3.61 | 2.95 | 2.80×10 ² | 4.98×10 ⁻³ |
| Operations | | | | | | |
| IHLW Interim Storage Facility | 2018 | 2092 | a | a | a | a |
| Other infrastructure upgrades | 2006 | 2092 | a | a | a | a |
| Routine operations | 2006 | 2092 | 3.10×10 ¹ | 1.44×10 ² | 1.32×10 ¹ | 4.73×10 ⁻² |
| Retrieval operations | 2006 | 2092 | a | a | a | a |
| Double-shell tank interim stabilization | 2006 | 2092 | a | a | a | a |
| Waste Treatment Plant | 2018 | 2092 | 5.56 | 2.58×10 ¹ | 1.37×10 ² | 8.77×10 ⁻³ |

Table G-65. Tank Closure Alternative 2A Criteria Pollutant Emissions from Mobile Sources (continued)

| Facility/System | Start Year | End Year | Emission Rate (metric tons per year) | | | |
|--|------------|----------|--------------------------------------|-----------------------|-----------------------|-----------------------|
| | | | Carbon Monoxide | Nitrogen Dioxide | PM ₁₀ | Sulfur Dioxide |
| Operations (continued) | | | | | | |
| Waste Treatment Plant, cesium and strontium capsules | 2093 | 2093 | 5.56 | 2.58×10 ¹ | 1.37×10 ² | 8.77×10 ⁻³ |
| Cesium and Strontium Capsule Processing Facility | 2092 | 2093 | 2.71 | 1.12×10 ¹ | 8.61×10 ⁻¹ | 4.20×10 ⁻³ |
| Modified sluicing retrieval system | 2013 | 2092 | a | a | a | a |
| Mobile retrieval system | 2013 | 2052 | a | a | a | a |
| Vacuum-based retrieval system | 2053 | 2092 | a | a | a | a |
| HLW Melter Interim Storage Facility | 2018 | 2192 | a | a | a | a |
| Effluent Treatment Facility | 2006 | 2095 | 6.46×10 ² | 1.68×10 ¹ | 2.83×10 ³ | 8.66×10 ⁻¹ |
| Evaporator | 2006 | 2093 | 3.22 | 8.38×10 ⁻² | 8.51×10 ² | 4.32×10 ⁻³ |
| Borrow Area C | 2006 | 2102 | a | a | 4.24×10 ² | a |
| Deactivation | | | | | | |
| IHLW Interim Storage Facility | 2093 | 2093 | a | a | a | a |
| Waste Treatment Plant | 2078 | 2079 | 5.56×10 ⁻¹ | 2.58 | 1.37×10 ¹ | 8.77×10 ⁻⁴ |
| Modified sluicing retrieval system | 2013 | 2092 | a | a | a | a |
| Mobile retrieval system | 2013 | 2052 | a | a | a | a |
| Vacuum-based retrieval system | 2053 | 2092 | a | a | a | a |
| Administrative controls | 2094 | 2193 | 1.63×10 ¹ | 7.71×10 ⁻¹ | 8.44×10 ⁻² | 2.22×10 ⁻⁴ |
| Waste Treatment Plant replacement | 2094 | 2095 | 5.56×10 ⁻¹ | 2.58 | 1.37×10 ¹ | 8.77×10 ⁻⁴ |
| Cesium and Strontium Capsule Processing Facility | 2094 | 2094 | 1.31 | 5.16 | 3.78×10 ⁻¹ | 2.02×10 ⁻³ |
| Effluent Treatment Facility original | 2026 | 2026 | 3.23×10 ² | 8.41 | 1.95 | 4.33×10 ⁻¹ |
| Effluent Treatment Facility replacement 1 | 2056 | 2056 | 3.23×10 ² | 8.41 | 1.95 | 4.33×10 ⁻¹ |
| Effluent Treatment Facility replacement 2 | 2096 | 2096 | 3.23×10 ² | 8.41 | 1.95 | 4.33×10 ⁻¹ |
| Evaporator original | 2018 | 2018 | 7.89×10 ⁻¹ | 2.05×10 ⁻² | 2.75 | 1.06×10 ⁻³ |
| Evaporator replacement 1 | 2043 | 2043 | 7.89×10 ⁻¹ | 2.05×10 ⁻² | 8.25 | 1.06×10 ⁻³ |
| Evaporator replacement 2 | 2068 | 2068 | 7.89×10 ⁻¹ | 2.05×10 ⁻² | 8.25 | 1.06×10 ⁻³ |
| Evaporator replacement 3 | 2094 | 2094 | 7.89×10 ⁻¹ | 2.05×10 ⁻² | 8.25 | 1.06×10 ⁻³ |

Table G-65. Tank Closure Alternative 2A Criteria Pollutant Emissions from Mobile Sources (continued)

| Facility/System | Start Year | End Year | Emission Rate (metric tons per year) | | | |
|---|------------|----------|--------------------------------------|------------------|------------------|----------------|
| | | | Carbon Monoxide | Nitrogen Dioxide | PM ₁₀ | Sulfur Dioxide |
| Closure | | | | | | |
| Decontamination and decommissioning of 10 selected facilities | 2018 | 2028 | a | a | a | a |

^a Emissions for this activity and pollutant were not calculated because annual fuel use for this activity and the resulting emissions would be small compared with other activities or would be zero.

Key: HLW=high-level radioactive waste; IHLW=immobilized high-level radioactive waste; PM₁₀=particulate matter with an aerodynamic diameter less than or equal to 10 micrometers.

Source: SAIC 2007a, 2008.

Table G-66. Tank Closure Alternative 2A Toxic Pollutant Emissions from Mobile Sources

| Facility/System | Start Year | End Year | Emission Rate (metric tons per year) | | | | | | |
|--|------------|----------|--------------------------------------|-----------------------|-----------------------|-----------------------|---------|-----------------------|-----------------------|
| | | | Ammonia | Benzene | 1,3-Butadiene | Formaldehyde | Mercury | Toluene | Xylene |
| Construction | | | | | | | | | |
| Underground transfer lines | 2009 | 2009 | a | a | a | a | a | a | a |
| Canister Storage Building | 2006 | 2016 | a | a | a | a | a | a | a |
| IHLW Shipping/Transfer Facility | 2011 | 2013 | a | a | a | a | a | a | a |
| IHLW Interim Storage Modules | 2014 | 2019 | a | a | a | a | a | a | a |
| Other infrastructure upgrades | 2006 | 2034 | a | a | a | a | a | a | a |
| Tank upgrades | 2006 | 2025 | a | a | a | a | a | a | a |
| Waste Treatment Plant | 2006 | 2017 | 7.91×10 ⁻² | 1.06×10 ⁻² | 4.46×10 ⁻⁴ | 2.24×10 ⁻² | a | 4.66×10 ⁻³ | 3.25×10 ⁻³ |
| Cesium and Strontium Capsule Processing Facility | 2088 | 2091 | 2.01×10 ⁻² | 2.75×10 ⁻³ | 1.13×10 ⁻⁴ | 3.43×10 ⁻³ | a | 1.94×10 ⁻³ | 1.04×10 ⁻³ |
| Tank risers | 2013 | 2056 | a | a | a | a | a | a | a |
| Modified sluicing retrieval system | 2013 | 2092 | a | a | a | a | a | a | a |
| Mobile retrieval system | 2013 | 2052 | a | a | a | a | a | a | a |
| Vacuum-based retrieval system | 2053 | 2092 | a | a | a | a | a | a | a |
| HLW Melter Interim Storage Facility 1 | 2015 | 2016 | a | a | a | a | a | a | a |
| HLW Melter Interim Storage Facility 2 | 2040 | 2041 | a | a | a | a | a | a | a |
| HLW Melter Interim Storage Facility 3 | 2065 | 2066 | a | a | a | a | a | a | a |
| Double-shell tank replacement | 2013 | 2054 | a | a | a | a | a | a | a |
| Waste Treatment Plant replacement | 2065 | 2076 | 1.58×10 ⁻¹ | 2.13×10 ⁻² | 8.92×10 ⁻⁴ | 4.48×10 ⁻² | a | 9.33×10 ⁻³ | 6.50×10 ⁻³ |
| Underground transfer line replacement | 2044 | 2044 | a | a | a | a | a | a | a |
| Effluent Treatment Facility replacement 1 | 2023 | 2025 | 2.14×10 ⁻² | 4.02×10 ⁻³ | 1.23×10 ⁻⁴ | 3.93×10 ⁻³ | a | 2.02×10 ⁻² | 6.22×10 ⁻³ |
| Effluent Treatment Facility replacement 2 | 2053 | 2055 | 2.14×10 ⁻² | 4.02×10 ⁻³ | 1.23×10 ⁻⁴ | 3.93×10 ⁻³ | a | 2.02×10 ⁻² | 6.22×10 ⁻³ |
| Evaporator replacement 1 | 2015 | 2017 | 4.76×10 ⁻³ | 9.96×10 ⁻⁴ | 7.95×10 ⁻⁴ | 9.01×10 ⁻⁴ | a | 6.20×10 ⁻³ | 1.86×10 ⁻³ |
| Evaporator replacement 2 | 2040 | 2042 | 4.74×10 ⁻³ | 9.92×10 ⁻⁴ | 7.95×10 ⁻⁴ | 8.97×10 ⁻⁴ | a | 6.18×10 ⁻³ | 1.85×10 ⁻³ |
| Evaporator replacement 3 | 2065 | 2067 | 4.74×10 ⁻³ | 9.92×10 ⁻⁴ | 7.95×10 ⁻⁴ | 8.97×10 ⁻⁴ | a | 6.18×10 ⁻³ | 1.85×10 ⁻³ |
| Operations | | | | | | | | | |
| IHLW Interim Storage Facility | 2018 | 2092 | a | a | a | a | a | a | a |
| Other infrastructure upgrades | 2006 | 2092 | a | a | a | a | a | a | a |
| Routine operations | 2006 | 2092 | 2.26×10 ⁻¹ | 3.42×10 ⁻² | a | a | a | 1.50×10 ⁻² | 1.04×10 ⁻² |
| Retrieval operations | 2006 | 2092 | a | a | a | a | a | a | a |
| Double-shell tank interim stabilization | 2006 | 2092 | a | a | a | a | a | a | a |
| Waste Treatment Plant | 2018 | 2092 | 4.05×10 ⁻² | 5.46×10 ⁻³ | 2.29×10 ⁻⁴ | 6.90×10 ⁻³ | a | 2.39×10 ⁻³ | 1.67×10 ⁻³ |
| Waste Treatment Plant, cesium and strontium capsules | 2093 | 2093 | 4.05×10 ⁻² | 5.46×10 ⁻³ | 2.29×10 ⁻⁴ | 6.90×10 ⁻³ | a | 2.39×10 ⁻³ | 1.67×10 ⁻³ |

G-134

Draft Tank Closure and Waste Management Environmental Impact Statement for the Hanford Site, Richland, Washington

Table G–66. Tank Closure Alternative 2A Toxic Pollutant Emissions from Mobile Sources (continued)

| Facility/System | Start Year | End Year | Emission Rate (metric tons per year) | | | | | | |
|---|------------|----------|--------------------------------------|-----------------------|-----------------------|-----------------------|---------|-----------------------|-----------------------|
| | | | Ammonia | Benzene | 1,3-Butadiene | Formaldehyde | Mercury | Toluene | Xylene |
| Operations (continued) | | | | | | | | | |
| Cesium and Strontium Capsule Processing Facility | 2092 | 2093 | a | a | a | a | a | a | a |
| Modified sluicing retrieval system | 2013 | 2092 | a | a | a | a | a | a | a |
| Mobile retrieval system | 2013 | 2052 | a | a | a | a | a | a | a |
| Vacuum-based retrieval system | 2053 | 2092 | a | a | a | a | a | a | a |
| HLW Melter Interim Storage Facility | 2018 | 2192 | a | a | a | a | a | a | a |
| Effluent Treatment Facility | 2006 | 2095 | 4.99×10 ⁻² | 8.32×10 ⁻² | 4.67×10 ⁻⁴ | 2.80×10 ⁻² | a | 1.28 | 3.61×10 ⁻¹ |
| Evaporator | 2006 | 2093 | 2.49×10 ⁻⁴ | 4.15×10 ⁻⁴ | 2.33×10 ⁻⁶ | 1.40×10 ⁻⁴ | a | 6.38×10 ⁻³ | 1.80×10 ⁻³ |
| Borrow Area C | 2006 | 2102 | 1.78×10 ⁻¹ | 3.12×10 ⁻² | 1.02×10 ⁻³ | 3.21×10 ⁻² | a | 1.32×10 ⁻¹ | 4.15×10 ⁻² |
| Deactivation | | | | | | | | | |
| IHLW Interim Storage Facility | 2093 | 2093 | a | a | a | a | a | a | a |
| Waste Treatment Plant | 2078 | 2079 | 4.05×10 ⁻³ | 5.46×10 ⁻⁴ | 2.29×10 ⁻⁵ | 6.90×10 ⁻⁴ | a | 2.39×10 ⁻⁴ | 1.67×10 ⁻⁴ |
| Modified sluicing retrieval system | 2013 | 2092 | a | a | a | a | a | a | a |
| Mobile retrieval system | 2013 | 2052 | a | a | a | a | a | a | a |
| Vacuum-based retrieval system | 2053 | 2092 | a | a | a | a | a | a | a |
| Administrative controls | 2094 | 2193 | 1.81×10 ⁻³ | 2.18×10 ⁻³ | a | a | a | 3.18×10 ⁻² | 9.07×10 ⁻³ |
| Waste Treatment Plant replacement | 2094 | 2095 | 4.05×10 ⁻³ | 5.46×10 ⁻⁴ | 2.29×10 ⁻⁵ | 6.90×10 ⁻⁴ | a | 2.39×10 ⁻⁴ | 1.67×10 ⁻⁴ |
| Cesium and Strontium Capsule Processing Facility | 2094 | 2094 | 8.12×10 ⁻³ | 1.12×10 ⁻³ | 4.59×10 ⁻⁵ | 1.39×10 ⁻³ | a | 8.76×10 ⁻⁴ | 4.45×10 ⁻⁴ |
| Effluent Treatment Facility original | 2026 | 2026 | 2.50×10 ⁻² | 4.16×10 ⁻² | 2.34×10 ⁻⁴ | 1.40×10 ⁻² | a | 6.40×10 ⁻¹ | 1.81×10 ⁻¹ |
| Effluent Treatment Facility replacement 1 | 2056 | 2056 | 2.50×10 ⁻² | 4.16×10 ⁻² | 2.34×10 ⁻⁴ | 1.40×10 ⁻² | a | 6.40×10 ⁻¹ | 1.81×10 ⁻¹ |
| Effluent Treatment Facility replacement 2 | 2096 | 2096 | 2.50×10 ⁻² | 4.16×10 ⁻² | 2.34×10 ⁻⁴ | 1.40×10 ⁻² | a | 6.40×10 ⁻¹ | 1.81×10 ⁻¹ |
| Evaporator original | 2018 | 2018 | 6.10×10 ⁻⁵ | 1.02×10 ⁻⁴ | 5.70×10 ⁻⁷ | 3.42×10 ⁻⁵ | a | 1.56×10 ⁻³ | 4.40×10 ⁻⁴ |
| Evaporator replacement 1 | 2043 | 2043 | 6.10×10 ⁻⁵ | 1.02×10 ⁻⁴ | 5.70×10 ⁻⁷ | 3.42×10 ⁻⁵ | a | 1.56×10 ⁻³ | 4.40×10 ⁻⁴ |
| Evaporator replacement 2 | 2068 | 2068 | 6.10×10 ⁻⁵ | 1.02×10 ⁻⁴ | 5.70×10 ⁻⁷ | 3.42×10 ⁻⁵ | a | 1.56×10 ⁻³ | 4.40×10 ⁻⁴ |
| Evaporator replacement 3 | 2094 | 2094 | 6.10×10 ⁻⁵ | 1.02×10 ⁻⁴ | 5.70×10 ⁻⁷ | 3.42×10 ⁻⁵ | a | 1.56×10 ⁻³ | 4.40×10 ⁻⁴ |
| Closure | | | | | | | | | |
| Decontamination and decommissioning of 10 selected facilities | 2018 | 2028 | a | a | a | a | a | a | a |

^a Emissions for this activity and pollutant were not calculated because annual fuel use for this activity and the resulting emissions would be small compared with other activities or would be zero.

Key: HLW=high-level radioactive waste; IHLW=immobilized high-level radioactive waste.

Source: SAIC 2007a, 2008.

Table G-67. Tank Closure Alternative 2B Criteria Pollutant Emissions from Mobile Sources

| Facility/System | Start Year | End Year | Emission Rate (metric tons per year) | | | |
|--|------------|----------|--------------------------------------|----------------------|-----------------------|-----------------------|
| | | | Carbon Monoxide | Nitrogen Dioxide | PM ₁₀ | Sulfur Dioxide |
| Construction | | | | | | |
| Canister Storage Building | 2006 | 2016 | a | a | a | a |
| IHLW Shipping/Transfer Facility | 2011 | 2013 | a | a | a | a |
| IHLW Interim Storage Modules | 2014 | 2022 | a | a | a | a |
| Other infrastructure upgrades | 2006 | 2034 | a | a | a | a |
| Tank upgrades | 2006 | 2025 | a | a | a | a |
| Waste Treatment Plant | 2006 | 2017 | 1.08×10 ¹ | 5.03×10 ¹ | 4.13×10 ² | 1.71×10 ⁻² |
| Low-Activity Waste Vitrification Facility | 2008 | 2017 | 1.54 | 7.16 | 5.43×10 ¹ | 2.43×10 ⁻³ |
| Cesium and Strontium Capsule Processing Facility | 2035 | 2038 | 3.13 | 1.28×10 ¹ | 4.24×10 ² | 4.85×10 ⁻³ |
| Waste receiver facilities | 2013 | 2017 | a | a | a | a |
| Tank risers | 2013 | 2016 | a | a | a | a |
| Modified sluicing retrieval system | 2013 | 2043 | a | a | a | a |
| Mobile retrieval system | 2013 | 2028 | a | a | a | a |
| Vacuum-based retrieval system | 2029 | 2043 | a | a | a | a |
| HLW Melter Interim Storage Facility 1 | 2015 | 2016 | a | a | a | a |
| HLW Melter Interim Storage Facility 2 | 2029 | 2030 | a | a | a | a |
| Effluent Treatment replacement 1 | 2023 | 2025 | 1.25×10 ¹ | 1.34×10 ¹ | 4.75×10 ² | 1.74×10 ⁻² |
| Evaporator replacement 1 | 2015 | 2017 | 3.62 | 2.96 | 1.41×10 ² | 5.00×10 ⁻³ |
| Underground transfer line 1,000-foot sections | 2009 | 2009 | a | a | a | a |
| Operations | | | | | | |
| IHLW Interim Storage Facility | 2018 | 2066 | a | a | a | a |
| Other infrastructure upgrades | 2006 | 2043 | a | a | a | a |
| Routine operations | 2006 | 2043 | 3.10×10 ¹ | 1.44×10 ² | 1.32×10 ¹ | 4.73×10 ⁻² |
| Retrieval operations | 2006 | 2043 | a | a | a | a |
| Double-shell tank interim stabilization | 2006 | 2043 | a | a | a | a |
| Waste Treatment Plant | 2018 | 2043 | 2.34×10 ¹ | 1.08×10 ² | 5.07×10 ² | 3.69×10 ⁻² |
| Waste Treatment Plant, cesium and strontium capsules | 2040 | 2040 | 2.34×10 ¹ | 1.08×10 ² | 5.07×10 ² | 3.69×10 ⁻² |
| Cesium and Strontium Capsule Processing Facility | 2039 | 2040 | 2.71 | 1.12×10 ¹ | 8.61×10 ⁻¹ | 4.20×10 ⁻³ |
| Modified sluicing retrieval system | 2013 | 2043 | a | a | a | a |
| Mobile retrieval system | 2013 | 2028 | a | a | a | a |
| Vacuum-based retrieval system | 2029 | 2043 | a | a | a | a |

Table G-67. Tank Closure Alternative 2B Criteria Pollutant Emissions from Mobile Sources (continued)

| Facility/System | Start Year | End Year | Emission Rate (metric tons per year) | | | |
|---|------------|----------|--------------------------------------|-----------------------|-----------------------|-----------------------|
| | | | Carbon Monoxide | Nitrogen Dioxide | PM ₁₀ | Sulfur Dioxide |
| Operations (continued) | | | | | | |
| HLW Melter Interim Storage Facility | 2018 | 2145 | a | a | a | a |
| Effluent Treatment Facility | 2006 | 2045 | 6.46×10 ² | 1.68×10 ¹ | 4.03×10 ² | 8.66×10 ⁻¹ |
| Evaporator | 2006 | 2043 | 3.22 | 8.38×10 ⁻² | 3.81×10 ² | 4.32×10 ⁻³ |
| Borrow Area C | 2006 | 2052 | a | a | 4.24×10 ² | a |
| Deactivation | | | | | | |
| IHLW Interim Storage Facility | 2067 | 2067 | a | a | a | a |
| Waste Treatment Plant | 2044 | 2045 | 2.34 | 1.08×10 ¹ | 5.07×10 ¹ | 3.69×10 ⁻³ |
| Modified sluicing retrieval system | 2013 | 2043 | a | a | a | a |
| Mobile retrieval system | 2013 | 2028 | a | a | a | a |
| Vacuum-based retrieval system | 2029 | 2043 | a | a | a | a |
| Cesium and Strontium Capsule Processing Facility | 2041 | 2041 | 1.31 | 5.16 | 3.78×10 ⁻¹ | 2.02×10 ⁻³ |
| Effluent Treatment Facility original | 2026 | 2026 | 3.23×10 ² | 8.41 | 1.95 | 4.33×10 ⁻¹ |
| Effluent Treatment Facility replacement | 2056 | 2056 | 3.23×10 ² | 8.41 | 1.95 | 4.33×10 ⁻¹ |
| Evaporator original | 2018 | 2018 | 7.89×10 ⁻¹ | 2.05×10 ⁻² | 2.75 | 1.06×10 ⁻³ |
| Evaporator replacement | 2044 | 2044 | 7.89×10 ⁻¹ | 2.05×10 ⁻² | 2.75 | 1.06×10 ⁻³ |
| Closure | | | | | | |
| Ancillary equipment grouting | 2013 | 2037 | a | a | a | a |
| Ancillary equipment removal | 2032 | 2037 | a | a | a | a |
| Decontamination and decommissioning of 10 selected facilities | 2018 | 2028 | a | a | a | a |
| Grout facility (tank-filling) construction | 2032 | 2033 | a | a | a | a |
| Grout facility (tank-filling) operations | 2034 | 2043 | a | a | a | a |
| Grout facility (tank-filling) deactivation | 2044 | 2044 | a | a | a | a |
| Containment structure construction | 2028 | 2031 | a | a | a | a |
| BX and SX tank farm soil removal | 2032 | 2037 | a | a | a | a |
| Containment structure deactivation | 2038 | 2040 | a | a | a | a |
| Modified Resource Conservation and Recovery Act Subtitle C barrier construction | 2039 | 2045 | 1.70×10 ¹ | 7.88×10 ¹ | 6.68×10 ² | 2.68×10 ⁻² |

Table G-67. Tank Closure Alternative 2B Criteria Pollutant Emissions from Mobile Sources (continued)

| Facility/System | Start Year | End Year | Emission Rate (metric tons per year) | | | |
|----------------------------|------------|----------|--------------------------------------|------------------|------------------|----------------|
| | | | Carbon Monoxide | Nitrogen Dioxide | PM ₁₀ | Sulfur Dioxide |
| Closure (continued) | | | | | | |
| Postclosure care | 2046 | 2145 | a | a | a | a |

^a Emissions for this activity and pollutant were not calculated because annual fuel use for this activity and the resulting emissions would be small compared with other activities or would be zero.

Key: HLW=high-level radioactive waste; IHLW=immobilized high-level radioactive waste; PM₁₀=particulate matter with an aerodynamic diameter less than or equal to 10 micrometers.

Source: SAIC 2007a, 2008.

Table G–68. Tank Closure Alternative 2B Toxic Pollutant Emissions from Mobile Sources

| Facility/System | Start Year | End Year | Emission Rate (metric tons per year) | | | | | | |
|--|------------|----------|--------------------------------------|-----------------------|-----------------------|-----------------------|---------|-----------------------|-----------------------|
| | | | Ammonia | Benzene | 1,3-Butadiene | Formaldehyde | Mercury | Toluene | Xylene |
| Construction | | | | | | | | | |
| Canister Storage Building | 2006 | 2016 | a | a | a | a | a | a | a |
| IHLW Shipping/Transfer Facility | 2011 | 2013 | a | a | a | a | a | a | a |
| IHLW Interim Storage Modules | 2014 | 2022 | a | a | a | a | a | a | a |
| Other infrastructure upgrades | 2006 | 2034 | a | a | a | a | a | a | a |
| Tank upgrades | 2006 | 2025 | a | a | a | a | a | a | a |
| Waste Treatment Plant | 2006 | 2017 | 7.91×10^{-2} | 1.06×10^{-2} | 4.46×10^{-4} | 2.24×10^{-2} | a | 4.66×10^{-3} | 3.25×10^{-3} |
| Low-Activity Waste Vitrification Facility | 2008 | 2017 | 1.13×10^{-2} | 1.51×10^{-3} | 6.35×10^{-5} | 1.92×10^{-3} | a | 6.64×10^{-4} | 4.63×10^{-4} |
| Cesium and Strontium Capsule Processing Facility | 2035 | 2038 | 2.01×10^{-2} | 2.75×10^{-3} | 1.13×10^{-4} | 3.43×10^{-3} | a | 1.94×10^{-3} | 1.04×10^{-3} |
| Waste receiver facilities | 2013 | 2017 | a | a | a | a | a | a | a |
| Tank risers | 2013 | 2016 | a | a | a | a | a | a | a |
| Modified sluicing retrieval system | 2013 | 2043 | a | a | a | a | a | a | a |
| Mobile retrieval system | 2013 | 2028 | a | a | a | a | a | a | a |
| Vacuum-based retrieval system | 2029 | 2043 | a | a | a | a | a | a | a |
| HLW Melter Interim Storage Facility 1 | 2015 | 2016 | a | a | a | a | a | a | a |
| HLW Melter Interim Storage Facility 2 | 2029 | 2030 | a | a | a | a | a | a | a |
| Effluent Treatment Facility replacement 1 | 2023 | 2025 | 2.14×10^{-2} | 4.02×10^{-3} | 1.23×10^{-4} | 3.93×10^{-3} | a | 2.02×10^{-2} | 6.22×10^{-3} |
| Evaporator replacement 1 | 2015 | 2017 | 4.76×10^{-3} | 9.96×10^{-4} | 7.95×10^{-4} | 9.01×10^{-4} | a | 6.20×10^{-3} | 1.86×10^{-3} |
| Underground transfer line 1,000-foot sections | 2009 | 2009 | a | a | a | a | a | a | a |
| Operations | | | | | | | | | |
| IHLW Interim Storage Facility | 2018 | 2066 | a | a | a | a | a | a | a |
| Other infrastructure upgrades | 2006 | 2043 | a | a | a | a | a | a | a |
| Routine operations | 2006 | 2043 | 2.26×10^{-1} | 3.42×10^{-2} | a | a | a | 1.50×10^{-2} | 1.04×10^{-2} |
| Retrieval operations | 2006 | 2043 | a | a | a | a | a | a | a |
| Double-shell tank interim stabilization | 2006 | 2043 | a | a | a | a | a | a | a |
| Waste Treatment Plant | 2018 | 2043 | 1.71×10^{-1} | 2.30×10^{-2} | 9.62×10^{-4} | 2.90×10^{-2} | a | 1.01×10^{-2} | 7.01×10^{-3} |
| Waste Treatment Plant, cesium and strontium capsules | 2040 | 2040 | 1.71×10^{-1} | 2.30×10^{-2} | 9.62×10^{-4} | 2.90×10^{-2} | a | 1.01×10^{-2} | 7.01×10^{-3} |
| Cesium and Strontium Capsule Processing Facility | 2039 | 2040 | 1.76×10^{-2} | 2.40×10^{-3} | 9.93×10^{-5} | 3.00×10^{-3} | a | 1.63×10^{-3} | 8.90×10^{-4} |
| Modified sluicing retrieval system | 2013 | 2043 | a | a | a | a | a | a | a |

G-139

Appendix G • Air Quality Analysis

Table G–68. Tank Closure Alternative 2B Toxic Pollutant Emissions from Mobile Sources (continued)

| Facility/System | Start Year | End Year | Emission Rate (metric tons per year) | | | | | | |
|---|------------|----------|--------------------------------------|-----------------------|-----------------------|-----------------------|---------|-----------------------|-----------------------|
| | | | Ammonia | Benzene | 1,3-Butadiene | Formaldehyde | Mercury | Toluene | Xylene |
| Operations (continued) | | | | | | | | | |
| Mobile retrieval system | 2013 | 2028 | a | a | a | a | a | a | a |
| Vacuum-based retrieval system | 2029 | 2043 | a | a | a | a | a | a | a |
| HLW Melter Interim Storage Facility | 2018 | 2145 | a | a | a | a | a | a | a |
| Effluent Treatment Facility | 2006 | 2045 | 4.99×10 ⁻² | 8.32×10 ⁻² | 4.67×10 ⁻⁴ | 2.80×10 ⁻² | a | 1.28 | 3.61×10 ⁻¹ |
| Evaporator | 2006 | 2043 | 2.49×10 ⁻⁴ | 4.15×10 ⁻⁴ | 2.33×10 ⁻⁶ | 1.40×10 ⁻⁴ | a | 6.38×10 ⁻³ | 1.80×10 ⁻³ |
| Borrow Area C | 2006 | 2052 | a | a | a | a | a | a | a |
| Deactivation | | | | | | | | | |
| IHLW Interim Storage Facility | 2067 | 2067 | a | a | a | a | a | a | a |
| Waste Treatment Plant | 2044 | 2045 | 1.71×10 ⁻² | 2.30×10 ⁻³ | 9.62×10 ⁻⁵ | 2.90×10 ⁻³ | a | 1.01×10 ⁻³ | 7.01×10 ⁻⁴ |
| Modified sluicing retrieval system | 2013 | 2043 | a | a | a | a | a | a | a |
| Mobile retrieval system | 2013 | 2028 | a | a | a | a | a | a | a |
| Vacuum-based retrieval system | 2029 | 2043 | a | a | a | a | a | a | a |
| Cesium and Strontium Capsule Processing Facility | 2041 | 2041 | 8.12×10 ⁻³ | 1.12×10 ⁻³ | 4.59×10 ⁻⁵ | 1.39×10 ⁻³ | a | 8.76×10 ⁻⁴ | 4.45×10 ⁻⁴ |
| Effluent Treatment Facility original | 2026 | 2026 | 2.50×10 ⁻² | 4.16×10 ⁻² | 2.34×10 ⁻⁴ | 1.40×10 ⁻² | a | 6.40×10 ⁻¹ | 1.81×10 ⁻¹ |
| Effluent Treatment Facility replacement 1 | 2056 | 2056 | 2.50×10 ⁻² | 4.16×10 ⁻² | 2.34×10 ⁻⁴ | 1.40×10 ⁻² | a | 6.40×10 ⁻¹ | 1.81×10 ⁻¹ |
| Evaporator original | 2018 | 2018 | 6.10×10 ⁻⁵ | 1.02×10 ⁻⁴ | 5.70×10 ⁻⁷ | 3.42×10 ⁻⁵ | a | 1.56×10 ⁻³ | 4.40×10 ⁻⁴ |
| Evaporator replacement 1 | 2044 | 2044 | 6.10×10 ⁻⁵ | 1.02×10 ⁻⁴ | 5.70×10 ⁻⁷ | 3.42×10 ⁻⁵ | a | 1.56×10 ⁻³ | 4.40×10 ⁻⁴ |
| Closure | | | | | | | | | |
| Ancillary equipment grouting | 2013 | 2037 | a | a | a | a | a | a | a |
| Ancillary equipment removal | 2032 | 2037 | a | a | a | a | a | a | a |
| Decontamination and decommissioning of 10 selected facilities | 2018 | 2028 | a | a | a | a | a | a | a |
| Grout facility (tank-filling) construction | 2032 | 2033 | a | a | a | a | a | a | a |
| Grout facility (tank-filling) operations | 2034 | 2043 | a | a | a | a | a | a | a |
| Grout facility (tank-filling) deactivation | 2044 | 2044 | a | a | a | a | a | a | a |
| Containment structure construction | 2028 | 2031 | a | a | a | a | a | a | a |
| BX and SX tank farm soil removal | 2032 | 2037 | a | a | a | a | a | a | a |
| Containment structure deactivation | 2038 | 2040 | a | a | a | a | a | a | a |

G-140

Draft Tank Closure and Waste Management Environmental Impact Statement for the Hanford Site, Richland, Washington

Table G–68. Tank Closure Alternative 2B Toxic Pollutant Emissions from Mobile Sources (continued)

| Facility/System | Start Year | End Year | Emission Rate (metric tons per year) | | | | | | |
|---|------------|----------|--------------------------------------|-----------------------|-----------------------|-----------------------|---------|-----------------------|-----------------------|
| | | | Ammonia | Benzene | 1,3-Butadiene | Formaldehyde | Mercury | Toluene | Xylene |
| Closure (continued) | | | | | | | | | |
| Modified Resource Conservation and Recovery Act Subtitle C barrier construction | 2039 | 2045 | 1.24×10 ⁻¹ | 3.10×10 ⁻¹ | 1.30×10 ⁻² | 3.92×10 ⁻¹ | a | 1.36×10 ⁻¹ | 9.47×10 ⁻² |
| Postclosure care | 2046 | 2145 | a | a | a | a | a | a | a |

^a Emissions for this activity and pollutant were not calculated because annual fuel use for this activity and the resulting emissions would be small compared with other activities or would be zero.

Key: HLW=high-level radioactive waste; IHLW=immobilized high-level radioactive waste.

Source: SAIC 2007a, 2008.

Table G-69. Tank Closure Alternative 3A Criteria Pollutant Emissions from Mobile Sources

| Facility/System | Start Year | End Year | Emission Rate (metric tons per year) | | | |
|--|------------|----------|--------------------------------------|----------------------|-----------------------|-----------------------|
| | | | Carbon Monoxide | Nitrogen Dioxide | PM ₁₀ | Sulfur Dioxide |
| Construction | | | | | | |
| Canister Storage Building | 2006 | 2016 | a | a | a | a |
| IHLW Shipping/Transfer Facility | 2011 | 2013 | a | a | a | a |
| IHLW Interim Storage Modules | 2014 | 2022 | a | a | a | a |
| Other infrastructure upgrades | 2006 | 2034 | a | a | a | a |
| Tank upgrades | 2006 | 2025 | a | a | a | a |
| Waste Treatment Plant | 2006 | 2017 | 1.08×10 ¹ | 5.03×10 ¹ | 4.13×10 ² | 1.71×10 ⁻² |
| Cesium and Strontium Capsule Processing Facility | 2035 | 2038 | 3.13 | 1.28×10 ¹ | 4.24×10 ² | 4.85×10 ⁻³ |
| Waste receiver facilities | 2013 | 2017 | a | a | a | a |
| Tank risers | 2013 | 2016 | a | a | a | a |
| Modified sluicing retrieval system | 2013 | 2039 | a | a | a | a |
| Mobile retrieval system | 2013 | 2026 | a | a | a | a |
| Vacuum-based retrieval system | 2027 | 2039 | a | a | a | a |
| HLW Melter Interim Storage Facility | 2015 | 2016 | a | a | a | a |
| Contact-Handled Mixed Transuranic Waste Facilities | 2008 | 2008 | 5.81×10 ⁻¹ | 2.69 | 1.67×10 ¹ | 9.17×10 ⁻⁴ |
| Remote-Handled Mixed Transuranic Waste Facility | 2013 | 2014 | 4.73×10 ⁻¹ | 2.20 | 1.36×10 ¹ | 7.47×10 ⁻⁴ |
| Transuranic Waste Interim Storage Facility | 2008 | 2009 | a | a | a | a |
| Bulk Vitrification Facility, 200-West Area | 2016 | 2017 | 1.54 | 7.15 | 4.47×10 ¹ | 2.43×10 ⁻³ |
| Solid-Liquid Separations Facility | 2016 | 2017 | 2.41×10 ⁻¹ | 1.12 | 8.32 | 3.80×10 ⁻⁴ |
| Bulk Vitrification Facility, 200-East Area | 2016 | 2017 | 1.54 | 7.15 | 4.47×10 ¹ | 2.43×10 ⁻³ |
| Effluent Treatment Facility replacement 1 | 2023 | 2025 | 1.25×10 ¹ | 1.34×10 ¹ | 4.75×10 ² | 1.74×10 ⁻² |
| Evaporator replacement 1 | 2015 | 2017 | 3.62 | 2.96 | 1.41×10 ² | 5.00×10 ⁻³ |
| Underground transfer line 1,000-foot sections | 2009 | 2009 | a | a | a | a |
| Operations | | | | | | |
| IHLW Interim Storage Facility | 2018 | 2066 | a | a | a | a |
| Other infrastructure upgrades | 2006 | 2039 | a | a | a | a |
| Routine operations | 2006 | 2039 | 3.10×10 ¹ | 1.44×10 ² | 1.32×10 ¹ | 4.73×10 ⁻² |
| Retrieval operations | 2006 | 2039 | a | a | a | a |
| Double-shell tank interim stabilization | 2006 | 2039 | a | a | a | a |
| Waste Treatment Plant | 2018 | 2039 | 7.61 | 3.53×10 ¹ | 1.82×10 ² | 1.20×10 ⁻² |
| Waste Treatment Plant, cesium and strontium capsules | 2040 | 2040 | 7.61 | 3.53×10 ¹ | 1.82×10 ² | 1.20×10 ⁻² |
| Cesium and Strontium Capsule Processing Facility | 2039 | 2040 | 2.71 | 1.12×10 ¹ | 8.61×10 ⁻¹ | 4.20×10 ⁻³ |

Table G-69. Tank Closure Alternative 3A Criteria Pollutant Emissions from Mobile Sources (continued)

| Facility/System | Start Year | End Year | Emission Rate (metric tons per year) | | | |
|--|------------|----------|--------------------------------------|-----------------------|-----------------------|-----------------------|
| | | | Carbon Monoxide | Nitrogen Dioxide | PM ₁₀ | Sulfur Dioxide |
| Operations (continued) | | | | | | |
| Modified sluicing retrieval system | 2013 | 2039 | a | a | a | a |
| Mobile retrieval system | 2013 | 2026 | a | a | a | a |
| Vacuum-based retrieval system | 2027 | 2039 | a | a | a | a |
| HLW Melter Interim Storage Facility | 2018 | 2141 | a | a | a | a |
| Contact-Handled Mixed Transuranic Waste Facilities | 2009 | 2010 | 2.47 | 1.15×10 ¹ | 6.31×10 ¹ | 3.90×10 ⁻³ |
| Remote-Handled Mixed Transuranic Waste Facility | 2015 | 2019 | 1.86×10 ⁻² | 8.63×10 ⁻² | 4.75×10 ⁻¹ | 2.94×10 ⁻⁵ |
| Transuranic Waste Interim Storage Facility | 2009 | 2034 | a | a | a | a |
| Bulk Vitrification Facility, 200-West Area | 2018 | 2039 | 3.80 | 1.76×10 ¹ | 1.01×10 ² | 6.00×10 ⁻³ |
| Solid-Liquid Separations Facility | 2018 | 2039 | 1.09 | 5.07 | 2.79×10 ¹ | 1.72×10 ⁻³ |
| Bulk Vitrification Facility, 200-East Area | 2018 | 2039 | 6.26 | 2.91×10 ¹ | 1.67×10 ² | 9.89×10 ⁻³ |
| Effluent Treatment Facility | 2006 | 2042 | 6.46×10 ² | 1.68×10 ¹ | 3.37×10 ² | 8.66×10 ⁻¹ |
| Evaporator | 2006 | 2040 | 3.22 | 8.38×10 ⁻² | 5.14×10 ⁻³ | 4.32×10 ⁻³ |
| Borrow Area C | 2006 | 2052 | a | a | 4.24×10 ² | a |
| Deactivation | | | | | | |
| Modified sluicing retrieval system | 2013 | 2039 | a | a | a | a |
| Mobile retrieval system | 2013 | 2026 | a | a | a | a |
| Vacuum-based retrieval system | 2027 | 2039 | a | a | a | a |
| IHLW Interim Storage Facility | 2067 | 2067 | a | a | a | a |
| Waste Treatment Plant | 2041 | 2042 | 7.61×10 ⁻¹ | 3.53 | 1.82×10 ¹ | 1.20×10 ⁻³ |
| Cesium and Strontium Capsule Processing Facility | 2041 | 2041 | 1.31 | 5.16 | 3.78×10 ⁻¹ | 2.02×10 ⁻³ |
| Contact-Handled Mixed Transuranic Waste Facilities | 2011 | 2012 | 2.47×10 ⁻¹ | 1.15 | 6.31 | 3.90×10 ⁻⁴ |
| Remote-Handled Mixed Transuranic Waste Facility | 2020 | 2021 | 1.86×10 ⁻³ | 8.63×10 ⁻³ | 4.75×10 ⁻² | 2.94×10 ⁻⁶ |
| Transuranic Waste Interim Storage Facility | 2035 | 2035 | a | a | a | a |
| Bulk Vitrification Facility, 200-West Area | 2040 | 2041 | 3.80×10 ⁻¹ | 1.76 | 1.01×10 ¹ | 6.00×10 ⁻⁴ |
| Solid-Liquid Separations Facility | 2040 | 2041 | 1.09×10 ⁻¹ | 5.07×10 ⁻¹ | 2.79 | 1.72×10 ⁻⁴ |
| Bulk Vitrification Facility, 200-East Area | 2040 | 2041 | 6.26×10 ⁻¹ | 2.91 | 1.67×10 ¹ | 9.89×10 ⁻⁴ |
| Effluent Treatment Facility original | 2026 | 2026 | 3.23×10 ² | 8.41 | 1.95 | 4.33×10 ⁻¹ |
| Effluent Treatment Facility replacement | 2043 | 2043 | 3.23×10 ² | 8.41 | 1.95 | 4.33×10 ⁻¹ |
| Evaporator original | 2018 | 2018 | 7.89×10 ⁻¹ | 2.05×10 ⁻² | 2.75 | 1.06×10 ⁻³ |
| Evaporator replacement | 2041 | 2041 | 7.89×10 ⁻¹ | 2.05×10 ⁻² | 2.75 | 1.06×10 ⁻³ |

Table G–69. Tank Closure Alternative 3A Criteria Pollutant Emissions from Mobile Sources (continued)

| Facility/System | Start Year | End Year | Emission Rate (metric tons per year) | | | |
|---|------------|----------|--------------------------------------|----------------------|----------------------|-----------------------|
| | | | Carbon Monoxide | Nitrogen Dioxide | PM ₁₀ | Sulfur Dioxide |
| Closure | | | | | | |
| Grout facility (tank-filling) construction | 2028 | 2029 | a | a | a | a |
| Grout facility (tank-filling) operations | 2030 | 2039 | a | a | a | a |
| Grout facility (tank-filling) deactivation | 2040 | 2040 | a | a | a | a |
| Ancillary equipment grouting | 2012 | 2032 | a | a | a | a |
| Ancillary equipment removal | 2028 | 2033 | a | a | a | a |
| BX and SX tank farm soil removal | 2028 | 2033 | a | a | a | a |
| Containment structure construction | 2024 | 2027 | a | a | a | a |
| Containment structure deactivation | 2034 | 2036 | a | a | a | a |
| Modified Resource Conservation and Recovery Act Subtitle C barrier construction | 2035 | 2041 | 1.70×10 ¹ | 7.88×10 ¹ | 6.68×10 ² | 2.68×10 ⁻² |
| Decontamination and decommissioning of 10 selected facilities | 2018 | 2028 | a | a | a | a |
| Postclosure care | 2042 | 2141 | a | a | a | a |

^a Emissions for this activity and pollutant were not calculated because annual fuel use for this activity and the resulting emissions would be small compared with other activities or would be zero.

Key: HLW=high-level radioactive waste; IHLW=immobilized high-level radioactive waste; PM₁₀=particulate matter with an aerodynamic diameter less than or equal to 10 micrometers.

Source: SAIC 2007a, 2008.

Table G-70. Tank Closure Alternative 3A Toxic Pollutant Emissions from Mobile Sources

| Facility/System | Start Year | End Year | Emission Rate (metric tons per year) | | | | | | |
|--|------------|----------|--------------------------------------|-----------------------|-----------------------|-----------------------|---------|-----------------------|-----------------------|
| | | | Ammonia | Benzene | 1,3-Butadiene | Formaldehyde | Mercury | Toluene | Xylene |
| Construction | | | | | | | | | |
| Canister Storage Building | 2006 | 2016 | a | a | a | a | a | a | a |
| IHLW Shipping/Transfer Facility | 2011 | 2013 | a | a | a | a | a | a | a |
| IHLW Interim Storage Modules | 2014 | 2022 | a | a | a | a | a | a | a |
| Other infrastructure upgrades | 2006 | 2034 | a | a | a | a | a | a | a |
| Tank upgrades | 2006 | 2025 | a | a | a | a | a | a | a |
| Waste Treatment Plant | 2006 | 2017 | 7.91×10 ⁻² | 1.06×10 ⁻² | 4.46×10 ⁻⁴ | 2.24×10 ⁻² | a | 4.66×10 ⁻³ | 3.25×10 ⁻³ |
| Cesium and Strontium Capsule Processing Facility | 2035 | 2038 | 2.01×10 ⁻² | 2.75×10 ⁻³ | 1.13×10 ⁻⁴ | 3.43×10 ⁻³ | a | 1.94×10 ⁻³ | 1.04×10 ⁻³ |
| Waste receiver facilities | 2013 | 2017 | a | a | a | a | a | a | a |
| Tank risers | 2013 | 2016 | a | a | a | a | a | a | a |
| Modified sluicing retrieval system | 2013 | 2039 | a | a | a | a | a | a | a |
| Mobile retrieval system | 2013 | 2026 | a | a | a | a | a | a | a |
| Vacuum-based retrieval system | 2027 | 2039 | a | a | a | a | a | a | a |
| HLW Melter Interim Storage Facility | 2015 | 2016 | a | a | a | a | a | a | a |
| Contact-Handled Mixed Transuranic Waste Facilities | 2008 | 2008 | 4.24×10 ⁻³ | 5.70×10 ⁻⁴ | 2.39×10 ⁻⁵ | 7.21×10 ⁻⁴ | a | 2.50×10 ⁻⁴ | 1.74×10 ⁻⁴ |
| Remote-Handled Mixed Transuranic Waste Facility | 2013 | 2014 | 3.45×10 ⁻³ | 4.64×10 ⁻⁴ | 1.95×10 ⁻⁵ | 5.87×10 ⁻⁴ | a | 2.04×10 ⁻⁴ | 1.42×10 ⁻⁴ |
| Transuranic Waste Interim Storage Facility | 2008 | 2009 | a | a | a | a | a | a | a |
| Bulk Vitrification Facility, 200-West Area | 2016 | 2017 | 1.12×10 ⁻² | 3.68×10 ⁻² | 6.34×10 ⁻⁵ | 1.91×10 ⁻³ | a | 1.61×10 ⁻² | 1.12×10 ⁻² |
| Solid-Liquid Separations Facility | 2016 | 2017 | 1.76×10 ⁻³ | 2.37×10 ⁻⁴ | 9.91×10 ⁻⁶ | 2.99×10 ⁻⁴ | a | 1.04×10 ⁻⁴ | 7.23×10 ⁻⁵ |
| Bulk Vitrification Facility, 200-East Area | 2016 | 2017 | 1.12×10 ⁻² | 3.68×10 ⁻² | 6.34×10 ⁻⁵ | 1.91×10 ⁻³ | a | 1.61×10 ⁻² | 1.12×10 ⁻² |
| Effluent Treatment Facility replacement 1 | 2023 | 2025 | 2.14×10 ⁻² | 4.02×10 ⁻³ | 1.23×10 ⁻⁴ | 3.93×10 ⁻³ | a | 2.02×10 ⁻² | 6.22×10 ⁻³ |
| Evaporator replacement 1 | 2015 | 2017 | 4.76×10 ⁻³ | 9.96×10 ⁻⁴ | 7.95×10 ⁻⁴ | 9.01×10 ⁻⁴ | a | 6.20×10 ⁻³ | 1.86×10 ⁻³ |
| Underground transfer line 1,000-foot sections | 2009 | 2009 | a | a | a | a | a | a | a |
| Operations | | | | | | | | | |
| IHLW Interim Storage Facility | 2018 | 2066 | a | a | a | a | a | a | a |
| Other infrastructure upgrades | 2006 | 2039 | a | a | a | a | a | a | a |
| Routine operations | 2006 | 2039 | 2.26×10 ⁻¹ | 3.42×10 ⁻² | a | a | a | 1.50×10 ⁻² | 1.04×10 ⁻² |
| Retrieval operations | 2006 | 2039 | a | a | a | a | a | a | a |
| Double-shell tank interim stabilization | 2006 | 2039 | a | a | a | a | a | a | a |
| Waste Treatment Plant | 2018 | 2039 | 5.55×10 ⁻² | 7.47×10 ⁻³ | 3.13×10 ⁻⁴ | 9.45×10 ⁻³ | a | 3.28×10 ⁻³ | 2.28×10 ⁻³ |

G-145

Appendix G • Air Quality Analysis

Table G-70. Tank Closure Alternative 3A Toxic Pollutant Emissions from Mobile Sources (continued)

| Facility/System | Start Year | End Year | Emission Rate (metric tons per year) | | | | | | |
|--|------------|----------|--------------------------------------|-----------------------|-----------------------|-----------------------|---------|-----------------------|-----------------------|
| | | | Ammonia | Benzene | 1,3-Butadiene | Formaldehyde | Mercury | Toluene | Xylene |
| Operations (continued) | | | | | | | | | |
| Waste Treatment Plant, cesium and strontium capsules | 2040 | 2040 | 5.55×10 ⁻² | 7.47×10 ⁻³ | 3.13×10 ⁻⁴ | 9.45×10 ⁻³ | a | 3.28×10 ⁻³ | 2.28×10 ⁻³ |
| Cesium and Strontium Capsule Processing Facility | 2039 | 2040 | 1.76×10 ⁻² | 2.40×10 ⁻³ | 9.93×10 ⁻⁵ | 3.00×10 ⁻³ | a | 1.63×10 ⁻³ | 8.90×10 ⁻⁴ |
| Modified sluicing retrieval system | 2013 | 2039 | a | a | a | a | a | a | a |
| Mobile retrieval system | 2013 | 2026 | a | a | a | a | a | a | a |
| Vacuum-based retrieval system | 2027 | 2039 | a | a | a | a | a | a | a |
| HLW Melter Interim Storage Facility | 2018 | 2141 | a | a | a | a | a | a | a |
| Contact-Handled Mixed Transuranic Waste Facilities | 2009 | 2010 | 1.80×10 ⁻² | 2.43×10 ⁻³ | 1.02×10 ⁻⁴ | 3.07×10 ⁻³ | a | 1.06×10 ⁻³ | 7.41×10 ⁻⁴ |
| Remote-Handled Mixed Transuranic Waste Facility | 2015 | 2019 | 1.36×10 ⁻⁴ | 1.83×10 ⁻⁵ | 7.65×10 ⁻⁷ | 2.31×10 ⁻⁵ | a | 8.01×10 ⁻⁶ | 5.58×10 ⁻⁶ |
| Transuranic Waste Interim Storage Facility | 2009 | 2034 | a | a | a | a | a | a | a |
| Bulk Vitrification Facility, 200-West Area | 2018 | 2039 | 2.77×10 ⁻² | 9.08×10 ⁻² | 1.56×10 ⁻⁴ | 4.72×10 ⁻³ | a | 3.98×10 ⁻² | 2.77×10 ⁻² |
| Solid-Liquid Separations Facility | 2018 | 2039 | 7.97×10 ⁻³ | 1.07×10 ⁻³ | 4.49×10 ⁻⁵ | 1.36×10 ⁻³ | a | 4.70×10 ⁻⁴ | 3.27×10 ⁻⁴ |
| Bulk Vitrification Facility, 200-East Area | 2018 | 2039 | 4.57×10 ⁻² | 1.50×10 ⁻¹ | 2.58×10 ⁻⁴ | 7.78×10 ⁻³ | a | 6.56×10 ⁻² | 4.57×10 ⁻² |
| Effluent Treatment Facility | 2006 | 2042 | 4.99×10 ⁻² | 8.32×10 ⁻² | 4.67×10 ⁻⁴ | 2.80×10 ⁻² | a | 1.28 | 3.61×10 ⁻¹ |
| Evaporator | 2006 | 2040 | 2.49×10 ⁻⁴ | 4.15×10 ⁻⁴ | 2.33×10 ⁻⁶ | 1.40×10 ⁻⁴ | a | 6.38×10 ⁻³ | 1.80×10 ⁻³ |
| Borrow Area C | 2006 | 2052 | a | a | a | a | a | a | a |
| Deactivation | | | | | | | | | |
| Modified sluicing retrieval system | 2013 | 2039 | a | a | a | a | a | a | a |
| Mobile retrieval system | 2013 | 2026 | a | a | a | a | a | a | a |
| Vacuum-based retrieval system | 2027 | 2039 | a | a | a | a | a | a | a |
| IHLW Interim Storage Facility | 2067 | 2067 | a | a | a | a | a | a | a |
| Waste Treatment Plant | 2041 | 2042 | 5.55×10 ⁻³ | 7.47×10 ⁻⁴ | 3.13×10 ⁻⁵ | 9.45×10 ⁻⁴ | a | 3.28×10 ⁻⁴ | 2.28×10 ⁻⁴ |
| Cesium and Strontium Capsule Processing Facility | 2041 | 2041 | 8.12×10 ⁻³ | 1.12×10 ⁻³ | 4.59×10 ⁻⁵ | 1.39×10 ⁻³ | a | 8.76×10 ⁻⁴ | 4.45×10 ⁻⁴ |
| Contact-Handled Mixed Transuranic Waste Facilities | 2011 | 2012 | 1.80×10 ⁻³ | 2.43×10 ⁻⁴ | 1.02×10 ⁻⁵ | 3.07×10 ⁻⁴ | a | 1.06×10 ⁻⁴ | 7.41×10 ⁻⁵ |
| Remote-Handled Mixed Transuranic Waste Facility | 2020 | 2021 | 1.36×10 ⁻⁵ | 1.83×10 ⁻⁶ | 7.65×10 ⁻⁸ | 2.31×10 ⁻⁶ | a | 8.01×10 ⁻⁷ | 5.58×10 ⁻⁷ |
| Transuranic Waste Interim Storage Facility | 2035 | 2035 | a | a | a | a | a | a | a |
| Bulk Vitrification Facility, 200-West Area | 2040 | 2041 | 2.77×10 ⁻³ | 9.08×10 ⁻³ | 1.56×10 ⁻⁵ | 4.72×10 ⁻⁴ | a | 3.98×10 ⁻³ | 2.77×10 ⁻³ |
| Solid-Liquid Separations Facility | 2040 | 2041 | 7.97×10 ⁻⁴ | 1.07×10 ⁻⁴ | 4.49×10 ⁻⁶ | 1.36×10 ⁻⁴ | a | 4.70×10 ⁻⁵ | 3.27×10 ⁻⁵ |
| Bulk Vitrification Facility, 200-East Area | 2040 | 2041 | 4.57×10 ⁻² | 1.50×10 ⁻¹ | 2.58×10 ⁻⁴ | 7.78×10 ⁻³ | a | 6.56×10 ⁻² | 4.57×10 ⁻² |
| Effluent Treatment Facility original | 2026 | 2026 | 2.50×10 ⁻² | 4.16×10 ⁻² | 2.34×10 ⁻⁴ | 1.40×10 ⁻² | a | 6.40×10 ⁻¹ | 1.81×10 ⁻¹ |

G-146

Draft Tank Closure and Waste Management Environmental Impact Statement for the Hanford Site, Richland, Washington

Table G-70. Tank Closure Alternative 3A Toxic Pollutant Emissions from Mobile Sources (continued)

| Facility/System | Start Year | End Year | Emission Rate (metric tons per year) | | | | | | |
|---|------------|----------|--------------------------------------|-----------------------|-----------------------|-----------------------|---------|-----------------------|-----------------------|
| | | | Ammonia | Benzene | 1,3-Butadiene | Formaldehyde | Mercury | Toluene | Xylene |
| Deactivation (continued) | | | | | | | | | |
| Effluent Treatment Facility replacement | 2043 | 2043 | 2.50×10 ⁻² | 4.16×10 ⁻² | 2.34×10 ⁻⁴ | 1.40×10 ⁻² | a | 6.40×10 ⁻¹ | 1.81×10 ⁻¹ |
| Evaporator original | 2018 | 2018 | 6.10×10 ⁻⁵ | 1.02×10 ⁻⁴ | 5.70×10 ⁻⁷ | 3.42×10 ⁻⁵ | a | 1.56×10 ⁻³ | 4.40×10 ⁻⁴ |
| Evaporator replacement 1 | 2041 | 2041 | 6.10×10 ⁻⁵ | 1.02×10 ⁻⁴ | 5.70×10 ⁻⁷ | 3.42×10 ⁻⁵ | a | 1.56×10 ⁻³ | 4.40×10 ⁻⁴ |
| Closure | | | | | | | | | |
| Grout facility (tank-filling) construction | 2028 | 2029 | a | a | a | a | a | a | a |
| Grout facility (tank-filling) operations | 2030 | 2039 | a | a | a | a | a | a | a |
| Grout facility (tank-filling) deactivation | 2040 | 2040 | a | a | a | a | a | a | a |
| Ancillary equipment grouting | 2012 | 2032 | a | a | a | a | a | a | a |
| Ancillary equipment removal | 2028 | 2033 | a | a | a | a | a | a | a |
| BX and SX tank farm soil removal | 2028 | 2033 | a | a | a | a | a | a | a |
| Containment structure construction | 2024 | 2027 | a | a | a | a | a | a | a |
| Containment structure deactivation | 2034 | 2036 | a | a | a | a | a | a | a |
| Modified Resource Conservation and Recovery Act Subtitle C barrier construction | 2035 | 2041 | 1.24×10 ⁻¹ | 3.10×10 ⁻¹ | 1.30×10 ⁻² | 3.92×10 ⁻¹ | a | 1.36×10 ⁻¹ | 9.47×10 ⁻² |
| Decontamination and decommissioning of 10 selected facilities | 2018 | 2028 | a | a | a | a | a | a | a |
| Postclosure care | 2042 | 2141 | a | a | a | a | a | a | a |

^a Emissions for this activity and pollutant were not calculated because annual fuel use for this activity and the resulting emissions would be small compared with other activities or would be zero.

Key: HLW=high-level radioactive waste; IHLW=immobilized high-level radioactive waste.

Source: SAIC 2007a, 2008.

Table G-71. Tank Closure Alternative 3B Criteria Pollutant Emissions from Mobile Sources

| Facility/System | Start Year | End Year | Emission Rate (metric tons per year) | | | |
|--|------------|----------|--------------------------------------|----------------------|----------------------|-----------------------|
| | | | Carbon Monoxide | Nitrogen Dioxide | PM ₁₀ | Sulfur Dioxide |
| Construction | | | | | | |
| Canister Storage Building | 2006 | 2016 | a | a | a | a |
| IHLW Shipping/Transfer Facility | 2011 | 2013 | a | a | a | a |
| IHLW Interim Storage Modules | 2014 | 2022 | a | a | a | a |
| Other infrastructure upgrades | 2006 | 2034 | a | a | a | a |
| Tank upgrades | 2006 | 2025 | a | a | a | a |
| Waste Treatment Plant | 2006 | 2017 | 1.08×10 ¹ | 5.03×10 ¹ | 4.13×10 ² | 1.71×10 ⁻² |
| Cesium and Strontium Capsule Processing Facility | 2035 | 2038 | 3.13 | 1.28×10 ¹ | 4.24×10 ² | 4.85×10 ⁻³ |
| Waste receiver facilities | 2013 | 2017 | a | a | a | a |
| Tank risers | 2013 | 2016 | a | a | a | a |
| Modified sluicing retrieval system | 2013 | 2039 | a | a | a | a |
| Mobile retrieval system | 2013 | 2026 | a | a | a | a |
| Vacuum-based retrieval system | 2027 | 2039 | a | a | a | a |
| HLW Melter Interim Storage Facility | 2015 | 2016 | a | a | a | a |
| Contact-Handled Mixed Transuranic Waste Facilities | 2008 | 2008 | 5.81×10 ⁻¹ | 2.69 | 1.67×10 ¹ | 9.17×10 ⁻⁴ |
| Remote-Handled Mixed Transuranic Waste Facility | 2013 | 2014 | 4.73×10 ⁻¹ | 2.20 | 1.36×10 ¹ | 7.47×10 ⁻⁴ |
| Transuranic Waste Interim Storage Facility | 2008 | 2009 | a | a | a | a |
| Cast Stone Facility, 200-West Area | 2016 | 2017 | 1.05 | 4.89 | 3.05×10 ¹ | 1.66×10 ⁻³ |
| Solid-Liquid Separations Facility | 2016 | 2017 | 2.41×10 ⁻¹ | 1.12 | 8.32 | 3.80×10 ⁻⁴ |
| Cast Stone Facility, 200-East Area | 2016 | 2017 | 1.05 | 4.89 | 3.05×10 ¹ | 1.66×10 ⁻³ |
| Effluent Treatment Facility replacement 1 | 2023 | 2025 | 1.25×10 ¹ | 1.34×10 ¹ | 4.75×10 ² | 1.74×10 ⁻² |
| Evaporator replacement 1 | 2015 | 2017 | 3.62 | 2.96 | 4.74×10 ² | 5.00×10 ⁻³ |
| Underground transfer line 1,000-foot sections | 2009 | 2009 | a | a | a | a |
| Operations | | | | | | |
| IHLW Interim Storage Facility | 2018 | 2066 | a | a | a | a |
| Other infrastructure upgrades | 2006 | 2039 | a | a | a | a |
| Routine operations | 2006 | 2039 | 3.10×10 ¹ | 1.44×10 ² | 1.32×10 ¹ | 4.73×10 ⁻² |
| Retrieval operations | 2006 | 2039 | a | a | a | a |

Table G-71. Tank Closure Alternative 3B Criteria Pollutant Emissions from Mobile Sources (continued)

| Facility/System | Start Year | End Year | Emission Rate (metric tons per year) | | | |
|--|------------|----------|--------------------------------------|-----------------------|-----------------------|-----------------------|
| | | | Carbon Monoxide | Nitrogen Dioxide | PM ₁₀ | Sulfur Dioxide |
| Operations (continued) | | | | | | |
| Double-shell tank interim stabilization | 2006 | 2039 | a | a | a | a |
| Waste Treatment Plant | 2018 | 2039 | 8.08 | 3.75×10 ¹ | 1.92×10 ² | 1.28×10 ⁻² |
| Waste Treatment Plant, cesium and strontium capsules | 2040 | 2040 | 7.61 | 3.53×10 ¹ | 1.82×10 ² | 1.20×10 ⁻² |
| Cesium and Strontium Capsule Processing Facility | 2039 | 2040 | 2.71 | 1.12×10 ¹ | 8.61×10 ⁻¹ | 4.20×10 ⁻³ |
| Modified sluicing retrieval system | 2013 | 2039 | a | a | a | a |
| Mobile retrieval system | 2013 | 2026 | a | a | a | a |
| Vacuum-based retrieval system | 2027 | 2039 | a | a | a | a |
| HLW Melter Interim Storage Facility | 2018 | 2141 | a | a | a | a |
| Contact-Handled Mixed Transuranic Waste Facilities | 2009 | 2010 | 2.47 | 1.15×10 ¹ | 6.31×10 ¹ | 3.90×10 ⁻³ |
| Remote-Handled Mixed Transuranic Waste Facility | 2015 | 2019 | 1.86×10 ⁻² | 8.63×10 ⁻² | 4.75×10 ⁻¹ | 2.94×10 ⁻⁵ |
| Transuranic Waste Interim Storage Facility | 2009 | 2034 | a | a | a | a |
| Cast Stone Facility, 200-West Area | 2018 | 2039 | 9.98 | 4.63×10 ¹ | 2.52×10 ² | 1.58×10 ⁻² |
| Solid-Liquid Separations Facility | 2018 | 2039 | 1.09 | 5.07 | 2.79×10 ¹ | 1.72×10 ⁻³ |
| Cast Stone Facility, 200-East Area | 2018 | 2039 | 1.68×10 ¹ | 7.81×10 ¹ | 4.24×10 ² | 2.66×10 ⁻² |
| Effluent Treatment Facility | 2006 | 2042 | 6.46×10 ² | 1.68×10 ¹ | 3.37×10 ² | 8.66×10 ⁻¹ |
| Evaporator | 2006 | 2040 | 3.22 | 8.38×10 ⁻² | 1.35×10 ² | 4.32×10 ⁻³ |
| Borrow Area C | 2006 | 2052 | a | a | 4.24×10 ² | a |
| Deactivation | | | | | | |
| Modified sluicing retrieval system | 2013 | 2039 | a | a | a | a |
| Mobile retrieval system | 2013 | 2026 | a | a | a | a |
| Vacuum-based retrieval system | 2027 | 2039 | a | a | a | a |
| IHLW Interim Storage Facility | 2067 | 2067 | a | a | a | a |
| Waste Treatment Plant | 2041 | 2042 | 8.08×10 ⁻¹ | 3.75 | 1.92×10 ¹ | 1.28×10 ⁻³ |
| Cesium and Strontium Capsule Processing Facility | 2041 | 2041 | 1.31 | 5.16 | 3.78×10 ⁻¹ | 2.02×10 ⁻³ |
| Contact-Handled Mixed Transuranic Waste Facilities | 2011 | 2012 | 2.47×10 ⁻¹ | 1.15 | 6.31 | 3.90×10 ⁻⁴ |
| Remote-Handled Mixed Transuranic Waste Facility | 2020 | 2021 | 1.86×10 ⁻³ | 8.63×10 ⁻³ | 4.75×10 ⁻² | 2.94×10 ⁻⁶ |
| Transuranic Waste Interim Storage Facility | 2035 | 2035 | a | a | a | a |
| Cast Stone Facility, 200-West Area | 2040 | 2041 | 9.98×10 ⁻¹ | 4.63 | 2.52×10 ¹ | 1.58×10 ⁻³ |
| Solid-Liquid Separations Facility | 2040 | 2041 | 1.09×10 ⁻¹ | 5.07×10 ⁻¹ | 2.79 | 1.72×10 ⁻⁴ |
| Cast Stone Facility, 200-East Area | 2040 | 2041 | 1.68 | 7.81 | 4.24×10 ¹ | 2.66×10 ⁻³ |

Table G-71. Tank Closure Alternative 3B Criteria Pollutant Emissions from Mobile Sources (continued)

| Facility/System | Start Year | End Year | Emission Rate (metric tons per year) | | | |
|---|------------|----------|--------------------------------------|-----------------------|----------------------|-----------------------|
| | | | Carbon Monoxide | Nitrogen Dioxide | PM ₁₀ | Sulfur Dioxide |
| Deactivation (continued) | | | | | | |
| Effluent Treatment Facility original | 2026 | 2026 | 3.23×10 ² | 8.41 | 1.95 | 4.33×10 ⁻¹ |
| Effluent Treatment Facility replacement 1 | 2043 | 2043 | 3.23×10 ² | 8.41 | 1.95 | 4.33×10 ⁻¹ |
| Evaporator original | 2018 | 2018 | 7.89×10 ⁻¹ | 2.05×10 ⁻² | 2.75 | 1.06×10 ⁻³ |
| Evaporator replacement 1 | 2041 | 2041 | 7.89×10 ⁻¹ | 2.05×10 ⁻² | 2.75 | 1.06×10 ⁻³ |
| Closure | | | | | | |
| Grout facility (tank-filling) construction | 2028 | 2029 | a | a | a | a |
| Grout facility (tank-filling) operations | 2030 | 2039 | a | a | a | a |
| Grout facility (tank-filling) deactivation | 2040 | 2040 | a | a | a | a |
| Ancillary equipment grouting | 2012 | 2032 | a | a | a | a |
| Ancillary equipment removal | 2028 | 2033 | a | a | a | a |
| BX and SX tank farm soil removal | 2028 | 2033 | a | a | a | a |
| Containment structure construction | 2024 | 2027 | a | a | a | a |
| Containment structure deactivation | 2034 | 2036 | a | a | a | a |
| Modified Resource Conservation and Recovery Act Subtitle C barrier construction | 2035 | 2041 | 1.70×10 ¹ | 7.88×10 ¹ | 6.68×10 ² | 2.68×10 ⁻² |
| Decontamination and decommissioning of 10 selected facilities | 2018 | 2028 | a | a | a | a |
| Postclosure care | 2042 | 2141 | a | a | a | a |

^a Emissions for this activity and pollutant were not calculated because annual fuel use for this activity and the resulting emissions would be small compared with other activities or would be zero.

Key: HLW=high-level radioactive waste; IHLW=immobilized high-level radioactive waste; PM₁₀=particulate matter with an aerodynamic diameter less than or equal to 10 micrometers.

Source: SAIC 2007a, 2008.

Table G-72. Tank Closure Alternative 3B Toxic Pollutant Emissions from Mobile Sources

| Facility/System | Start Year | End Year | Emission Rate (metric tons per year) | | | | | | |
|--|------------|----------|--------------------------------------|-----------------------|-----------------------|-----------------------|---------|-----------------------|-----------------------|
| | | | Ammonia | Benzene | 1,3-Butadiene | Formaldehyde | Mercury | Toluene | Xylene |
| Construction | | | | | | | | | |
| Canister Storage Building | 2006 | 2016 | a | a | a | a | a | a | a |
| IHLW Shipping/Transfer Facility | 2011 | 2013 | a | a | a | a | a | a | a |
| IHLW Interim Storage Modules | 2014 | 2022 | a | a | a | a | a | a | a |
| Other infrastructure upgrades | 2006 | 2034 | a | a | a | a | a | a | a |
| Tank upgrades | 2006 | 2025 | a | a | a | a | a | a | a |
| Waste Treatment Plant | 2006 | 2017 | 7.91×10 ⁻² | 1.06×10 ⁻² | 4.46×10 ⁻⁴ | 2.24×10 ⁻² | a | 4.66×10 ⁻³ | 3.25×10 ⁻³ |
| Cesium and Strontium Capsule Processing Facility | 2035 | 2038 | 2.01×10 ⁻² | 2.75×10 ⁻³ | 1.13×10 ⁻⁴ | 3.43×10 ⁻³ | a | 1.94×10 ⁻³ | 1.04×10 ⁻³ |
| Waste receiver facilities | 2013 | 2017 | a | a | a | a | a | a | a |
| Tank risers | 2013 | 2016 | a | a | a | a | a | a | a |
| Modified sluicing retrieval system | 2013 | 2039 | a | a | a | a | a | a | a |
| Mobile retrieval system | 2013 | 2026 | a | a | a | a | a | a | a |
| Vacuum-based retrieval system | 2027 | 2039 | a | a | a | a | a | a | a |
| HLW Melter Interim Storage Facility | 2015 | 2016 | a | a | a | a | a | a | a |
| Contact-Handled Mixed Transuranic Waste Facilities | 2008 | 2008 | 4.24×10 ⁻³ | 5.70×10 ⁻⁴ | 2.39×10 ⁻⁵ | 7.21×10 ⁻⁴ | a | 2.50×10 ⁻⁴ | 1.74×10 ⁻⁴ |
| Remote-Handled Mixed Transuranic Waste Facility | 2013 | 2014 | 3.45×10 ⁻³ | 4.64×10 ⁻⁴ | 1.95×10 ⁻⁵ | 5.87×10 ⁻⁴ | a | 2.04×10 ⁻⁴ | 1.42×10 ⁻⁴ |
| Transuranic Waste Interim Storage Facility | 2008 | 2009 | a | a | a | a | a | a | a |
| Cast Stone Facility, 200-West Area | 2016 | 2017 | 7.69×10 ⁻³ | 1.03×10 ⁻³ | 4.33×10 ⁻⁵ | 1.31×10 ⁻³ | a | 4.53×10 ⁻⁴ | 3.16×10 ⁻⁴ |
| Solid-Liquid Separations Facility | 2016 | 2017 | 1.76×10 ⁻³ | 2.37×10 ⁻⁴ | 9.91×10 ⁻⁶ | 2.99×10 ⁻⁴ | a | 1.04×10 ⁻⁴ | 7.23×10 ⁻⁵ |
| Cast Stone Facility, 200-East Area | 2016 | 2017 | 7.69×10 ⁻³ | 1.03×10 ⁻³ | 4.33×10 ⁻⁵ | 1.31×10 ⁻³ | a | 4.53×10 ⁻⁴ | 3.16×10 ⁻⁴ |
| Effluent Treatment Facility replacement 1 | 2023 | 2025 | 2.14×10 ⁻² | 4.02×10 ⁻³ | 1.23×10 ⁻⁴ | 3.93×10 ⁻³ | a | 2.02×10 ⁻² | 6.22×10 ⁻³ |
| Evaporator replacement 1 | 2015 | 2017 | 4.76×10 ⁻³ | 9.96×10 ⁻⁴ | 7.95×10 ⁻⁴ | 9.01×10 ⁻⁴ | a | 6.20×10 ⁻³ | 1.86×10 ⁻³ |
| Underground transfer line 1,000-foot sections | 2009 | 2009 | a | a | a | a | a | a | a |
| Operations | | | | | | | | | |
| IHLW Interim Storage Facility | 2018 | 2066 | a | a | a | a | a | a | a |
| Other infrastructure upgrades | 2006 | 2039 | a | a | a | a | a | a | a |
| Routine operations | 2006 | 2039 | 2.26×10 ⁻¹ | 3.42×10 ⁻² | a | a | a | 1.50×10 ⁻² | 1.04×10 ⁻² |
| Retrieval operations | 2006 | 2039 | a | a | a | a | a | a | a |
| Double-shell tank interim stabilization | 2006 | 2039 | a | a | a | a | a | a | a |
| Waste Treatment Plant | 2018 | 2039 | 5.90×10 ⁻² | 7.94×10 ⁻³ | 3.33×10 ⁻⁴ | 1.00×10 ⁻² | a | 3.48×10 ⁻³ | 2.42×10 ⁻³ |

G-151

Appendix G • Air Quality Analysis

Table G-72. Tank Closure Alternative 3B Toxic Pollutant Emissions from Mobile Sources (continued)

| Facility/System | Start Year | End Year | Emission Rate (metric tons per year) | | | | | | |
|--|------------|----------|--------------------------------------|-----------------------|-----------------------|-----------------------|---------|-----------------------|-----------------------|
| | | | Ammonia | Benzene | 1,3-Butadiene | Formaldehyde | Mercury | Toluene | Xylene |
| Operations (continued) | | | | | | | | | |
| Waste Treatment Plant, cesium and strontium capsules | 2040 | 2040 | 5.55×10 ⁻² | 7.47×10 ⁻³ | 3.13×10 ⁻⁴ | 9.45×10 ⁻³ | a | 3.28×10 ⁻³ | 2.28×10 ⁻³ |
| Cesium and Strontium Capsule Processing Facility | 2039 | 2040 | 1.76×10 ⁻² | 2.40×10 ⁻³ | 9.93×10 ⁻⁵ | 3.00×10 ⁻³ | a | 1.63×10 ⁻³ | 8.90×10 ⁻⁴ |
| Modified sluicing retrieval system | 2013 | 2039 | a | a | a | a | a | a | a |
| Mobile retrieval system | 2013 | 2026 | a | a | a | a | a | a | a |
| Vacuum-based retrieval system | 2027 | 2039 | a | a | a | a | a | a | a |
| HLW Melter Interim Storage Facility | 2018 | 2141 | a | a | a | a | a | a | a |
| Contact-Handled Mixed Transuranic Waste Facilities | 2009 | 2010 | 1.80×10 ⁻² | 2.43×10 ⁻³ | 1.02×10 ⁻⁴ | 3.07×10 ⁻³ | a | 1.06×10 ⁻³ | 7.41×10 ⁻⁴ |
| Remote-Handled Mixed Transuranic Waste Facility | 2015 | 2019 | 1.36×10 ⁻⁴ | 1.83×10 ⁻⁵ | 7.65×10 ⁻⁷ | 2.31×10 ⁻⁵ | a | 8.01×10 ⁻⁶ | 5.58×10 ⁻⁶ |
| Transuranic Waste Interim Storage Facility | 2009 | 2034 | a | a | a | a | a | a | a |
| Cast Stone Facility, 200-West Area | 2018 | 2039 | 7.29×10 ⁻² | 9.81×10 ⁻³ | 4.11×10 ⁻⁴ | 1.24×10 ⁻² | a | 4.30×10 ⁻³ | 3.00×10 ⁻³ |
| Solid-Liquid Separations Facility | 2018 | 2039 | 7.97×10 ⁻³ | 1.07×10 ⁻³ | 4.49×10 ⁻⁵ | 1.36×10 ⁻³ | a | 4.70×10 ⁻⁴ | 3.27×10 ⁻⁴ |
| Cast Stone Facility, 200-East Area | 2018 | 2039 | 1.23×10 ⁻¹ | 1.65×10 ⁻² | 6.93×10 ⁻⁴ | 2.09×10 ⁻² | a | 7.25×10 ⁻³ | 5.05×10 ⁻³ |
| Effluent Treatment Facility | 2006 | 2042 | 4.99×10 ⁻² | 8.32×10 ⁻² | 4.67×10 ⁻⁴ | 2.80×10 ⁻² | a | 1.28 | 3.61×10 ⁻¹ |
| Evaporator | 2006 | 2040 | 2.49×10 ⁻⁴ | 4.15×10 ⁻⁴ | 2.33×10 ⁻⁶ | 1.40×10 ⁻⁴ | a | 6.38×10 ⁻³ | 1.80×10 ⁻³ |
| Borrow Area C | 2006 | 2052 | a | a | a | a | a | a | a |
| Deactivation | | | | | | | | | |
| Modified sluicing retrieval system | 2013 | 2039 | a | a | a | a | a | a | a |
| Mobile retrieval system | 2013 | 2026 | a | a | a | a | a | a | a |
| Vacuum-based retrieval system | 2027 | 2039 | a | a | a | a | a | a | a |
| IHLW Interim Storage Facility | 2067 | 2067 | a | a | a | a | a | a | a |
| Waste Treatment Plant | 2041 | 2042 | 5.90×10 ⁻³ | 7.94×10 ⁻⁴ | 3.33×10 ⁻⁵ | 1.00×10 ⁻³ | a | 3.48×10 ⁻⁴ | 2.42×10 ⁻⁴ |
| Cesium and Strontium Capsule Processing Facility | 2041 | 2041 | 8.12×10 ⁻³ | 1.12×10 ⁻³ | 4.59×10 ⁻⁵ | 1.39×10 ⁻³ | a | 8.76×10 ⁻⁴ | 4.45×10 ⁻⁴ |
| Contact-Handled Mixed Transuranic Waste Facilities | 2011 | 2012 | 1.80×10 ⁻³ | 2.43×10 ⁻⁴ | 1.02×10 ⁻⁵ | 3.07×10 ⁻⁴ | a | 1.06×10 ⁻⁴ | 7.41×10 ⁻⁵ |
| Remote-Handled Mixed Transuranic Waste Facility | 2020 | 2021 | 1.36×10 ⁻⁵ | 1.83×10 ⁻⁶ | 7.65×10 ⁻⁸ | 2.31×10 ⁻⁶ | a | 8.01×10 ⁻⁷ | 5.58×10 ⁻⁷ |
| Transuranic Waste Interim Storage Facility | 2035 | 2035 | a | a | a | a | a | a | a |
| Cast Stone Facility, 200-West Area | 2040 | 2041 | 7.29×10 ⁻³ | 9.81×10 ⁻⁴ | 4.11×10 ⁻⁵ | 1.24×10 ⁻³ | a | 4.30×10 ⁻⁴ | 3.00×10 ⁻⁴ |
| Solid-Liquid Separations Facility | 2040 | 2041 | 7.97×10 ⁻⁴ | 1.07×10 ⁻⁴ | 4.49×10 ⁻⁶ | 1.36×10 ⁻⁴ | a | 4.70×10 ⁻⁵ | 3.27×10 ⁻⁵ |
| Cast Stone Facility, 200-East Area | 2040 | 2041 | 1.23×10 ⁻² | 1.65×10 ⁻³ | 6.93×10 ⁻⁵ | 2.09×10 ⁻³ | a | 7.25×10 ⁻⁴ | 5.05×10 ⁻⁴ |
| Effluent Treatment Facility original | 2026 | 2026 | 2.50×10 ⁻² | 4.16×10 ⁻² | 2.34×10 ⁻⁴ | 1.40×10 ⁻² | a | 6.40×10 ⁻¹ | 1.81×10 ⁻¹ |

G-152

Draft Tank Closure and Waste Management Environmental Impact Statement for the Hanford Site, Richland, Washington

Table G–72. Tank Closure Alternative 3B Toxic Pollutant Emissions from Mobile Sources (continued)

| Facility/System | Start Year | End Year | Emission Rate (metric tons per year) | | | | | | |
|---|------------|----------|--------------------------------------|-----------------------|-----------------------|-----------------------|---------|-----------------------|-----------------------|
| | | | Ammonia | Benzene | 1,3-Butadiene | Formaldehyde | Mercury | Toluene | Xylene |
| Deactivation (continued) | | | | | | | | | |
| Effluent Treatment Facility replacement 1 | 2043 | 2043 | 2.50×10 ⁻² | 4.16×10 ⁻² | 2.34×10 ⁻⁴ | 1.40×10 ⁻² | a | 6.40×10 ⁻¹ | 1.81×10 ⁻¹ |
| Evaporator original | 2018 | 2018 | 6.10×10 ⁻⁵ | 1.02×10 ⁻⁴ | 5.70×10 ⁻⁷ | 3.42×10 ⁻⁵ | a | 1.56×10 ⁻³ | 4.40×10 ⁻⁴ |
| Evaporator replacement 1 | 2041 | 2041 | 6.10×10 ⁻⁵ | 1.02×10 ⁻⁴ | 5.70×10 ⁻⁷ | 3.42×10 ⁻⁵ | a | 1.56×10 ⁻³ | 4.40×10 ⁻⁴ |
| Closure | | | | | | | | | |
| Grout facility (tank-filling) construction | 2028 | 2029 | a | a | a | a | a | a | a |
| Grout facility (tank-filling) operations | 2030 | 2039 | a | a | a | a | a | a | a |
| Grout facility (tank-filling) deactivation | 2040 | 2040 | a | a | a | a | a | a | a |
| Ancillary equipment grouting | 2012 | 2032 | a | a | a | a | a | a | a |
| Ancillary equipment removal | 2028 | 2033 | a | a | a | a | a | a | a |
| BX and SX tank farm soil removal | 2028 | 2033 | a | a | a | a | a | a | a |
| Containment structure construction | 2024 | 2027 | a | a | a | a | a | a | a |
| Containment structure deactivation | 2034 | 2036 | a | a | a | a | a | a | a |
| Modified Resource Conservation and Recovery Act Subtitle C barrier construction | 2035 | 2041 | 1.24×10 ⁻¹ | 3.10×10 ⁻¹ | 1.30×10 ⁻² | 3.92×10 ⁻¹ | a | 1.36×10 ⁻¹ | 9.47×10 ⁻² |
| Decontamination and decommissioning of 10 selected facilities | 2018 | 2028 | a | a | a | a | a | a | a |
| Postclosure care | 2042 | 2141 | a | a | a | a | a | a | a |

^a Emissions for this activity and pollutant were not calculated because annual fuel use for this activity and the resulting emissions would be small compared with other activities or would be zero.

Key: HLW=high-level radioactive waste; IHLW=immobilized high-level radioactive waste.

Source: SAIC 2007a, 2008.

Table G-73. Tank Closure Alternative 3C Criteria Pollutant Emissions from Mobile Sources

| Facility/System | Start Year | End Year | Emission Rate (metric tons per year) | | | |
|--|------------|----------|--------------------------------------|----------------------|----------------------|-----------------------|
| | | | Carbon Monoxide | Nitrogen Dioxide | PM ₁₀ | Sulfur Dioxide |
| Construction | | | | | | |
| Canister Storage Building | 2006 | 2016 | a | a | a | a |
| IHLW Shipping/Transfer Facility | 2011 | 2013 | a | a | a | a |
| IHLW Interim Storage Modules | 2014 | 2022 | a | a | a | a |
| Other infrastructure upgrades | 2006 | 2034 | a | a | a | a |
| Tank upgrades | 2006 | 2025 | a | a | a | a |
| Waste Treatment Plant | 2006 | 2017 | 1.08×10 ¹ | 5.03×10 ¹ | 4.13×10 ² | 1.71×10 ⁻² |
| Cesium and Strontium Capsule Processing Facility | 2035 | 2038 | 3.13 | 1.28×10 ¹ | 4.24×10 ² | 4.85×10 ⁻³ |
| Waste receiver facilities | 2013 | 2017 | a | a | a | a |
| Tank risers | 2013 | 2016 | a | a | a | a |
| Modified sluicing retrieval system | 2013 | 2039 | a | a | a | a |
| Mobile retrieval system | 2013 | 2026 | a | a | a | a |
| Vacuum-based retrieval system | 2027 | 2039 | a | a | a | a |
| HLW Melter Interim Storage Facility | 2015 | 2016 | a | a | a | a |
| Contact-Handled Mixed Transuranic Waste Facilities | 2008 | 2008 | 5.81×10 ⁻¹ | 2.69 | 1.67×10 ¹ | 9.17×10 ⁻⁴ |
| Remote-Handled Mixed Transuranic Waste Facility | 2013 | 2014 | 4.73×10 ⁻¹ | 2.20 | 1.36×10 ¹ | 7.47×10 ⁻⁴ |
| Transuranic Waste Interim Storage Facility | 2008 | 2009 | a | a | a | a |
| Steam Reforming Facility, 200-West Area | 2016 | 2017 | 3.52 | 1.63×10 ¹ | 1.02×10 ² | 5.55×10 ⁻³ |
| Solid-Liquid Separations Facility | 2016 | 2017 | 2.41×10 ⁻¹ | 1.12 | 8.32 | 3.80×10 ⁻⁴ |
| Steam Reforming Facility, 200-East Area | 2016 | 2017 | 7.02 | 3.26×10 ¹ | 2.04×10 ² | 1.11×10 ⁻² |
| Effluent Treatment Facility replacement 1 | 2023 | 2025 | 1.25×10 ¹ | 1.34×10 ¹ | 4.75×10 ² | 1.74×10 ⁻² |
| Evaporator replacement 1 | 2015 | 2017 | 3.62 | 2.96 | 1.41×10 ² | 5.00×10 ⁻³ |
| Underground transfer line 1,000-foot sections | 2009 | 2009 | a | a | a | a |
| Operations | | | | | | |
| IHLW Interim Storage Facility | 2018 | 2066 | a | a | a | a |
| Other infrastructure upgrades | 2006 | 2039 | a | a | a | a |
| Routine operations | 2006 | 2039 | 3.10×10 ¹ | 1.44×10 ² | 1.32×10 ¹ | 4.73×10 ⁻² |
| Retrieval operations | 2006 | 2039 | a | a | a | a |
| Double-shell tank interim stabilization | 2006 | 2039 | a | a | a | a |
| Waste Treatment Plant | 2018 | 2039 | 7.61 | 3.53×10 ¹ | 1.82×10 ² | 1.20×10 ⁻² |
| Waste Treatment Plant, cesium and strontium capsules | 2040 | 2040 | 7.61 | 3.53×10 ¹ | 1.82×10 ² | 1.20×10 ⁻² |

Table G-73. Tank Closure Alternative 3C Criteria Pollutant Emissions from Mobile Sources (continued)

| Facility/System | Start Year | End Year | Emission Rate (metric tons per year) | | | |
|--|------------|----------|--------------------------------------|-----------------------|-----------------------|-----------------------|
| | | | Carbon Monoxide | Nitrogen Dioxide | PM ₁₀ | Sulfur Dioxide |
| Operations (continued) | | | | | | |
| Cesium and Strontium Capsule Processing Facility | 2039 | 2040 | 2.71 | 1.12×10 ¹ | 8.61×10 ⁻¹ | 4.20×10 ⁻³ |
| Modified sluicing retrieval system | 2013 | 2039 | a | a | a | a |
| Mobile retrieval system | 2013 | 2026 | a | a | a | a |
| Vacuum-based retrieval system | 2027 | 2039 | a | a | a | a |
| HLW Melter Interim Storage Facility | 2018 | 2141 | a | a | a | a |
| Contact-Handled Mixed Transuranic Waste Facilities | 2009 | 2010 | 2.47 | 1.15×10 ¹ | 6.31×10 ¹ | 3.90×10 ⁻³ |
| Remote-Handled Mixed Transuranic Waste Facility | 2015 | 2019 | 1.86×10 ⁻² | 8.63×10 ⁻² | 4.75×10 ⁻¹ | 2.94×10 ⁻⁵ |
| Transuranic Waste Interim Storage Facility | 2009 | 2034 | a | a | a | a |
| Steam Reforming Facility, 200-West Area | 2018 | 2039 | 1.20×10 ² | 5.59×10 ² | 2.80×10 ³ | 1.90×10 ⁻¹ |
| Solid-Liquid Separations Facility | 2018 | 2039 | 1.09 | 5.07 | 2.79×10 ¹ | 1.72×10 ⁻³ |
| Steam Reforming Facility, 200-East Area | 2018 | 2039 | 1.05×10 ² | 4.87×10 ² | 2.44×10 ³ | 1.66×10 ⁻¹ |
| Effluent Treatment Facility | 2006 | 2042 | 6.46×10 ² | 1.68×10 ¹ | 3.37×10 ² | 8.66×10 ⁻¹ |
| Evaporator | 2006 | 2040 | 3.22 | 8.38×10 ⁻² | 1.35×10 ² | 4.32×10 ⁻³ |
| Borrow Area C | 2006 | 2052 | a | a | 8.48×10 ² | a |
| Deactivation | | | | | | |
| Modified sluicing retrieval system | 2013 | 2039 | a | a | a | a |
| Mobile retrieval system | 2013 | 2026 | a | a | a | a |
| Vacuum-based retrieval system | 2027 | 2039 | a | a | a | a |
| IHLW Interim Storage Facility | 2067 | 2067 | a | a | a | a |
| Waste Treatment Plant | 2041 | 2042 | 7.61×10 ⁻¹ | 3.53 | 1.82×10 ¹ | 1.20×10 ⁻³ |
| Cesium and Strontium Capsule Processing Facility | 2041 | 2041 | 1.31 | 5.16 | 3.78×10 ⁻¹ | 2.02×10 ⁻³ |
| Contact-Handled Mixed Transuranic Waste Facilities | 2011 | 2012 | 2.47×10 ⁻¹ | 1.15 | 6.31 | 3.90×10 ⁻⁴ |
| Remote-Handled Mixed Transuranic Waste Facility | 2020 | 2021 | 1.86×10 ⁻³ | 8.63×10 ⁻³ | 4.75×10 ⁻² | 2.94×10 ⁻⁶ |
| Transuranic Waste Interim Storage Facility | 2035 | 2035 | a | a | a | a |
| Steam Reforming Facility, 200-West Area | 2040 | 2041 | 1.20×10 ¹ | 5.59×10 ¹ | 2.80×10 ² | 1.90×10 ⁻² |
| Solid-Liquid Separations Facility | 2040 | 2041 | 1.09×10 ⁻¹ | 5.07×10 ⁻¹ | 2.79 | 1.72×10 ⁻⁴ |
| Steam Reforming Facility, 200-East Area | 2040 | 2041 | 1.05×10 ¹ | 4.87×10 ¹ | 2.44×10 ² | 1.66×10 ⁻² |
| Effluent Treatment Facility original | 2026 | 2026 | 3.23×10 ² | 8.41 | 1.95 | 4.33×10 ⁻¹ |
| Effluent Treatment Facility replacement 1 | 2043 | 2043 | 3.23×10 ² | 8.41 | 1.95 | 4.33×10 ⁻¹ |

Table G-73. Tank Closure Alternative 3C Criteria Pollutant Emissions from Mobile Sources (continued)

| Facility/System | Start Year | End Year | Emission Rate (metric tons per year) | | | |
|---|------------|----------|--------------------------------------|-----------------------|----------------------|-----------------------|
| | | | Carbon Monoxide | Nitrogen Dioxide | PM ₁₀ | Sulfur Dioxide |
| Deactivation (continued) | | | | | | |
| Evaporator original | 2018 | 2018 | 7.89×10 ⁻¹ | 2.05×10 ⁻² | 2.75 | 1.06×10 ⁻³ |
| Evaporator replacement 1 | 2041 | 2041 | 7.89×10 ⁻¹ | 2.05×10 ⁻² | 2.75 | 1.06×10 ⁻³ |
| Closure | | | | | | |
| Grout facility (tank-filling) construction | 2028 | 2029 | a | a | a | a |
| Grout facility (tank-filling) operations | 2030 | 2039 | a | a | a | a |
| Grout facility (tank-filling) deactivation | 2040 | 2040 | a | a | a | a |
| Ancillary equipment grouting | 2012 | 2032 | a | a | a | a |
| Ancillary equipment removal | 2028 | 2033 | a | a | a | a |
| BX and SX tank farm soil removal | 2028 | 2033 | a | a | a | a |
| Containment structure construction | 2024 | 2027 | a | a | a | a |
| Containment structure deactivation | 2034 | 2036 | a | a | a | a |
| Modified Resource Conservation and Recovery Act Subtitle C barrier construction | 2035 | 2041 | 1.70×10 ¹ | 7.88×10 ¹ | 6.68×10 ² | 2.68×10 ⁻² |
| Decontamination and decommissioning of 10 selected facilities | 2018 | 2028 | a | a | a | a |
| Postclosure care | 2042 | 2141 | a | a | a | a |

^a Emissions for this activity and pollutant were not calculated because annual fuel use for this activity and the resulting emissions would be small compared with other activities or would be zero.

Key: HLW=high-level radioactive waste; IHLW=immobilized high-level radioactive waste; PM₁₀=particulate matter with an aerodynamic diameter less than or equal to 10 micrometers.

Source: SAIC 2007a, 2008.

Table G-74. Tank Closure Alternative 3C Toxic Pollutant Emissions from Mobile Sources

| Facility/System | Start Year | End Year | Emission Rate (metric tons per year) | | | | | | |
|--|------------|----------|--------------------------------------|-----------------------|-----------------------|-----------------------|---------|-----------------------|-----------------------|
| | | | Ammonia | Benzene | 1,3-Butadiene | Formaldehyde | Mercury | Toluene | Xylene |
| Construction | | | | | | | | | |
| Canister Storage Building | 2006 | 2016 | a | a | a | a | a | a | a |
| IHLW Shipping/Transfer Facility | 2011 | 2013 | a | a | a | a | a | a | a |
| IHLW Interim Storage Modules | 2014 | 2022 | a | a | a | a | a | a | a |
| Other infrastructure upgrades | 2006 | 2034 | a | a | a | a | a | a | a |
| Tank upgrades | 2006 | 2025 | a | a | a | a | a | a | a |
| Waste Treatment Plant | 2006 | 2017 | 7.91×10 ⁻² | 1.06×10 ⁻² | 4.46×10 ⁻⁴ | 2.24×10 ⁻² | a | 4.66×10 ⁻³ | 3.25×10 ⁻³ |
| Cesium and Strontium Capsule Processing Facility | 2035 | 2038 | 2.01×10 ⁻² | 2.75×10 ⁻³ | 1.13×10 ⁻⁴ | 3.43×10 ⁻³ | a | 1.94×10 ⁻³ | 1.04×10 ⁻³ |
| Waste receiver facilities | 2013 | 2017 | a | a | a | a | a | a | a |
| Tank risers | 2013 | 2016 | a | a | a | a | a | a | a |
| Modified sluicing retrieval system | 2013 | 2039 | a | a | a | a | a | a | a |
| Mobile retrieval system | 2013 | 2026 | a | a | a | a | a | a | a |
| Vacuum-based retrieval system | 2027 | 2039 | a | a | a | a | a | a | a |
| HLW Melter Interim Storage Facility | 2015 | 2016 | a | a | a | a | a | a | a |
| Contact-Handled Mixed Transuranic Waste Facilities | 2008 | 2008 | 4.24×10 ⁻³ | 5.70×10 ⁻⁴ | 2.39×10 ⁻⁵ | 7.21×10 ⁻⁴ | a | 2.50×10 ⁻⁴ | 1.74×10 ⁻⁴ |
| Remote-Handled Mixed Transuranic Waste Facility | 2013 | 2014 | 3.45×10 ⁻³ | 4.64×10 ⁻⁴ | 1.95×10 ⁻⁵ | 5.87×10 ⁻⁴ | a | 2.04×10 ⁻⁴ | 1.42×10 ⁻⁴ |
| Transuranic Waste Interim Storage Facility | 2008 | 2009 | a | a | a | a | a | a | a |
| Steam Reforming Facility, 200-West Area | 2016 | 2017 | 2.57×10 ⁻² | 3.45×10 ⁻³ | 1.45×10 ⁻⁴ | 4.37×10 ⁻³ | a | 1.51×10 ⁻³ | 1.05×10 ⁻³ |
| Solid-Liquid Separations Facility | 2016 | 2017 | 1.76×10 ⁻³ | 2.37×10 ⁻⁴ | 9.91×10 ⁻⁶ | 2.99×10 ⁻⁴ | a | 1.04×10 ⁻⁴ | 7.23×10 ⁻⁵ |
| Steam Reforming Facility, 200-East Area | 2016 | 2017 | 5.13×10 ⁻² | 6.90×10 ⁻³ | 2.89×10 ⁻⁴ | 8.72×10 ⁻³ | a | 3.02×10 ⁻³ | 2.11×10 ⁻³ |
| Effluent Treatment Facility replacement 1 | 2023 | 2025 | 2.14×10 ⁻² | 4.02×10 ⁻³ | 1.23×10 ⁻⁴ | 3.93×10 ⁻³ | a | 2.02×10 ⁻² | 6.22×10 ⁻³ |
| Evaporator replacement 1 | 2015 | 2017 | 4.76×10 ⁻³ | 9.96×10 ⁻⁴ | 7.95×10 ⁻⁴ | 9.01×10 ⁻⁴ | a | 6.20×10 ⁻³ | 1.86×10 ⁻³ |
| Underground transfer line 1,000-foot sections | 2009 | 2009 | a | a | a | a | a | a | a |
| Operations | | | | | | | | | |
| IHLW Interim Storage Facility | 2018 | 2066 | a | a | a | a | a | a | a |
| Other infrastructure upgrades | 2006 | 2039 | a | a | a | a | a | a | a |
| Routine operations | 2006 | 2039 | 2.26×10 ⁻¹ | 3.42×10 ⁻² | a | a | a | 1.50×10 ⁻² | 1.04×10 ⁻² |
| Retrieval operations | 2006 | 2039 | a | a | a | a | a | a | a |
| Double-shell tank interim stabilization | 2006 | 2039 | a | a | a | a | a | a | a |
| Waste Treatment Plant | 2018 | 2039 | 5.55×10 ⁻² | 7.47×10 ⁻³ | 3.13×10 ⁻⁴ | 9.45×10 ⁻³ | a | 3.28×10 ⁻³ | 2.28×10 ⁻³ |

Table G-74. Tank Closure Alternative 3C Toxic Pollutant Emissions from Mobile Sources (continued)

| Facility/System | Start Year | End Year | Emission Rate (metric tons per year) | | | | | | |
|--|------------|----------|--------------------------------------|-----------------------|-----------------------|-----------------------|---------|-----------------------|-----------------------|
| | | | Ammonia | Benzene | 1,3-Butadiene | Formaldehyde | Mercury | Toluene | Xylene |
| Operations (continued) | | | | | | | | | |
| Waste Treatment Plant, cesium and strontium capsules | 2040 | 2040 | 5.55×10^{-2} | 7.47×10^{-3} | 3.13×10^{-4} | 9.45×10^{-3} | a | 3.28×10^{-3} | 2.28×10^{-3} |
| Cesium and Strontium Capsule Processing Facility | 2039 | 2040 | 1.76×10^{-2} | 2.40×10^{-3} | 9.93×10^{-5} | 3.00×10^{-3} | a | 1.63×10^{-3} | 8.90×10^{-4} |
| Modified sluicing retrieval system | 2013 | 2039 | a | a | a | a | a | a | a |
| Mobile retrieval system | 2013 | 2026 | a | a | a | a | a | a | a |
| Vacuum-based retrieval system | 2027 | 2039 | a | a | a | a | a | a | a |
| HLW Melter Interim Storage Facility | 2018 | 2141 | a | a | a | a | a | a | a |
| Contact-Handled Mixed Transuranic Waste Facilities | 2009 | 2010 | 1.80×10^{-2} | 2.43×10^{-3} | 1.02×10^{-4} | 3.07×10^{-3} | a | 1.06×10^{-3} | 7.41×10^{-4} |
| Remote-Handled Mixed Transuranic Waste Facility | 2015 | 2019 | 1.36×10^{-4} | 1.83×10^{-5} | 7.65×10^{-7} | 2.31×10^{-5} | a | 8.01×10^{-6} | 5.58×10^{-6} |
| Transuranic Waste Interim Storage Facility | 2009 | 2034 | a | a | a | a | a | a | a |
| Steam Reforming Facility, 200-West Area | 2018 | 2039 | 8.79×10^{-1} | 1.18×10^{-1} | 4.96×10^{-3} | 1.50×10^{-1} | a | 5.18×10^{-2} | 3.61×10^{-2} |
| Solid-Liquid Separations Facility | 2018 | 2039 | 7.97×10^{-3} | 1.07×10^{-3} | 4.49×10^{-5} | 1.36×10^{-3} | a | 4.70×10^{-4} | 3.27×10^{-4} |
| Steam Reforming Facility, 200-East Area | 2018 | 2039 | 7.66×10^{-1} | 1.03×10^{-1} | 4.32×10^{-3} | 1.30×10^{-1} | a | 4.52×10^{-2} | 3.15×10^{-2} |
| Effluent Treatment Facility | 2006 | 2042 | 4.99×10^{-2} | 8.32×10^{-2} | 4.67×10^{-4} | 2.80×10^{-2} | a | 1.28 | 3.61×10^{-1} |
| Evaporator | 2006 | 2040 | 2.49×10^{-4} | 4.15×10^{-4} | 2.33×10^{-6} | 1.40×10^{-4} | a | 6.38×10^{-3} | 1.80×10^{-3} |
| Borrow Area C | 2006 | 2052 | a | a | a | a | a | a | a |
| Deactivation | | | | | | | | | |
| Modified sluicing retrieval system | 2013 | 2039 | a | a | a | a | a | a | a |
| Mobile retrieval system | 2013 | 2026 | a | a | a | a | a | a | a |
| Vacuum-based retrieval system | 2027 | 2039 | a | a | a | a | a | a | a |
| IHLW Interim Storage Facility | 2067 | 2067 | a | a | a | a | a | a | a |
| Waste Treatment Plant | 2041 | 2042 | 5.55×10^{-3} | 7.47×10^{-4} | 3.13×10^{-5} | 9.45×10^{-4} | a | 3.28×10^{-4} | 2.28×10^{-4} |
| Cesium and Strontium Capsule Processing Facility | 2041 | 2041 | 8.12×10^{-3} | 1.12×10^{-3} | 4.59×10^{-5} | 1.39×10^{-3} | a | 8.76×10^{-4} | 4.45×10^{-4} |
| Contact-Handled Mixed Transuranic Waste Facilities | 2011 | 2012 | 1.80×10^{-3} | 2.43×10^{-4} | 1.02×10^{-5} | 3.07×10^{-4} | a | 1.06×10^{-4} | 7.41×10^{-5} |
| Remote-Handled Mixed Transuranic Waste Facility | 2020 | 2021 | 1.36×10^{-5} | 1.83×10^{-6} | 7.65×10^{-8} | 2.31×10^{-6} | a | 8.01×10^{-7} | 5.58×10^{-7} |
| Transuranic Waste Interim Storage Facility | 2035 | 2035 | a | a | a | a | a | a | a |
| Steam Reforming Facility, 200-West Area | 2040 | 2041 | 8.79×10^{-2} | 1.18×10^{-2} | 4.96×10^{-4} | 1.50×10^{-2} | a | 5.18×10^{-3} | 3.61×10^{-3} |
| Solid-Liquid Separations Facility | 2040 | 2041 | 7.97×10^{-4} | 1.07×10^{-4} | 4.49×10^{-6} | 1.36×10^{-4} | a | 4.70×10^{-5} | 3.27×10^{-5} |
| Steam Reforming Facility, 200-East Area | 2040 | 2041 | 7.66×10^{-2} | 1.03×10^{-2} | 4.32×10^{-4} | 1.30×10^{-2} | a | 4.52×10^{-3} | 3.15×10^{-3} |

G-158

Table G-74. Tank Closure Alternative 3C Toxic Pollutant Emissions from Mobile Sources (continued)

| Facility/System | Start Year | End Year | Emission Rate (metric tons per year) | | | | | | |
|---|------------|----------|--------------------------------------|-----------------------|-----------------------|-----------------------|---------|-----------------------|-----------------------|
| | | | Ammonia | Benzene | 1,3-Butadiene | Formaldehyde | Mercury | Toluene | Xylene |
| Deactivation (continued) | | | | | | | | | |
| Effluent Treatment Facility original | 2026 | 2026 | 2.50×10 ⁻² | 4.16×10 ⁻² | 2.34×10 ⁻⁴ | 1.40×10 ⁻² | a | 6.40×10 ⁻¹ | 1.81×10 ⁻¹ |
| Effluent Treatment Facility replacement 1 | 2043 | 2043 | 2.50×10 ⁻² | 4.16×10 ⁻² | 2.34×10 ⁻⁴ | 1.40×10 ⁻² | a | 6.40×10 ⁻¹ | 1.81×10 ⁻¹ |
| Evaporator original | 2018 | 2018 | 6.10×10 ⁻⁵ | 1.02×10 ⁻⁴ | 5.70×10 ⁻⁷ | 3.42×10 ⁻⁵ | a | 1.56×10 ⁻³ | 4.40×10 ⁻⁴ |
| Evaporator replacement 1 | 2041 | 2041 | 6.10×10 ⁻⁵ | 1.02×10 ⁻⁴ | 5.70×10 ⁻⁷ | 3.42×10 ⁻⁵ | a | 1.56×10 ⁻³ | 4.40×10 ⁻⁴ |
| Closure | | | | | | | | | |
| Grout facility (tank-filling) construction | 2028 | 2029 | a | a | a | a | a | a | a |
| Grout facility (tank-filling) operations | 2030 | 2039 | a | a | a | a | a | a | a |
| Grout facility (tank-filling) deactivation | 2040 | 2040 | a | a | a | a | a | a | a |
| Ancillary equipment grouting | 2012 | 2032 | a | a | a | a | a | a | a |
| Ancillary equipment removal | 2028 | 2033 | a | a | a | a | a | a | a |
| BX and SX tank farm soil removal | 2028 | 2033 | a | a | a | a | a | a | a |
| Containment structure construction | 2024 | 2027 | a | a | a | a | a | a | a |
| Containment structure deactivation | 2034 | 2036 | a | a | a | a | a | a | a |
| Modified Resource Conservation and Recovery Act Subtitle C barrier construction | 2035 | 2041 | 1.24×10 ⁻¹ | 3.10×10 ⁻¹ | 1.30×10 ⁻² | 3.92×10 ⁻¹ | a | 1.36×10 ⁻¹ | 9.47×10 ⁻² |
| Decontamination and decommissioning of 10 selected facilities | 2018 | 2028 | a | a | a | a | a | a | a |
| Postclosure care | 2042 | 2141 | a | a | a | a | a | a | a |

^a Emissions for this activity and pollutant were not calculated because annual fuel use for this activity and the resulting emissions would be small compared with other activities or would be zero.

Key: HLW=high-level radioactive waste; IHLW=immobilized high-level radioactive waste.

Source: SAIC 2007a, 2008.

Table G-75. Tank Closure Alternative 4 Criteria Pollutant Emissions from Mobile Sources

| Facility/System | Start Year | End Year | Emission Rate (metric tons per year) | | | |
|--|------------|----------|--------------------------------------|----------------------|----------------------|-----------------------|
| | | | Carbon Monoxide | Nitrogen Dioxide | PM ₁₀ | Sulfur Dioxide |
| Construction | | | | | | |
| Canister Storage Building | 2006 | 2016 | a | a | a | a |
| IHLW Shipping/Transfer Facility | 2011 | 2013 | a | a | a | a |
| IHLW Interim Storage Modules | 2014 | 2022 | a | a | a | a |
| Other infrastructure upgrades | 2006 | 2034 | a | a | a | a |
| Tank upgrades | 2006 | 2025 | a | a | a | a |
| Waste Treatment Plant | 2006 | 2017 | 1.08×10 ¹ | 5.03×10 ¹ | 4.13×10 ² | 1.71×10 ⁻² |
| Cesium and Strontium Capsule Processing Facility | 2038 | 2041 | 3.13 | 1.28×10 ¹ | 4.24×10 ² | 4.85×10 ⁻³ |
| Waste receiver facilities | 2013 | 2017 | a | a | a | a |
| Tank risers | 2013 | 2016 | a | a | a | a |
| Mobile retrieval system | 2013 | 2042 | a | a | a | a |
| Vacuum-based retrieval system | 2013 | 2042 | a | a | a | a |
| Chemical wash system | 2013 | 2042 | a | a | a | a |
| HLW Melter Interim Storage Facility | 2015 | 2016 | a | a | a | a |
| Contact-Handled Mixed Transuranic Waste Facilities | 2008 | 2008 | 5.81×10 ⁻¹ | 2.69 | 1.67×10 ¹ | 9.17×10 ⁻⁴ |
| Remote-Handled Mixed Transuranic Waste Facility | 2013 | 2014 | 4.73×10 ⁻¹ | 2.20 | 1.36×10 ¹ | 7.47×10 ⁻⁴ |
| Transuranic Waste Interim Storage Facility | 2008 | 2009 | a | a | a | a |
| Bulk Vitrification Facility | 2016 | 2017 | 1.54 | 7.15 | 4.47×10 ¹ | 2.43×10 ⁻³ |
| Solid-Liquid Separations Facility | 2016 | 2017 | 2.41×10 ⁻¹ | 1.12 | 8.32 | 3.80×10 ⁻⁴ |
| Cast Stone Facility | 2016 | 2017 | 1.05 | 4.89 | 3.05×10 ¹ | 1.66×10 ⁻³ |
| Effluent Treatment Facility replacement 1 | 2023 | 2025 | 1.25×10 ¹ | 1.34×10 ¹ | 4.75×10 ² | 1.74×10 ⁻² |
| Evaporator replacement 1 | 2015 | 2017 | 3.62 | 2.96 | 1.41×10 ² | 5.00×10 ⁻³ |
| Underground transfer line 1,000-foot sections | 2009 | 2009 | a | a | a | a |
| Operations | | | | | | |
| IHLW Interim Storage Facility | 2018 | 2066 | a | a | a | a |
| Other infrastructure upgrades | 2006 | 2042 | a | a | a | a |
| Routine operations | 2006 | 2042 | 3.10×10 ¹ | 1.44×10 ² | 1.32×10 ¹ | 4.73×10 ⁻² |
| Retrieval operations | 2006 | 2042 | a | a | a | a |
| Double-shell tank interim stabilization | 2006 | 2042 | a | a | a | a |

Table G-75. Tank Closure Alternative 4 Criteria Pollutant Emissions from Mobile Sources (continued)

| Facility/System | Start Year | End Year | Emission Rate (metric tons per year) | | | |
|--|------------|----------|--------------------------------------|-----------------------|-----------------------|-----------------------|
| | | | Carbon Monoxide | Nitrogen Dioxide | PM ₁₀ | Sulfur Dioxide |
| Operations (continued) | | | | | | |
| Waste Treatment Plant | 2018 | 2042 | 7.24 | 3.36×10 ¹ | 1.74×10 ² | 1.14×10 ⁻² |
| Waste Treatment Plant, cesium and strontium capsules | 2043 | 2043 | 7.24 | 3.36×10 ¹ | 1.74×10 ² | 1.14×10 ⁻² |
| Cesium and Strontium Capsule Processing Facility | 2042 | 2043 | 2.71 | 1.12×10 ¹ | 8.61×10 ⁻¹ | 4.20×10 ⁻³ |
| Mobile retrieval system | 2013 | 2042 | a | a | a | a |
| Vacuum-based retrieval system | 2013 | 2042 | a | a | a | a |
| Chemical wash system | 2013 | 2042 | a | a | a | a |
| HLW Melter Interim Storage Facility | 2018 | 2144 | a | a | a | a |
| Contact-Handled Mixed Transuranic Waste Facilities | 2009 | 2010 | 2.47 | 1.15×10 ¹ | 6.31×10 ¹ | 3.90×10 ⁻³ |
| Remote-Handled Mixed Transuranic Waste Facility | 2015 | 2019 | 1.86×10 ⁻² | 8.63×10 ⁻² | 4.75×10 ⁻¹ | 2.94×10 ⁻⁵ |
| Transuranic Waste Interim Storage Facility | 2009 | 2034 | a | a | a | a |
| Bulk Vitrification Facility | 2018 | 2039 | 3.80 | 1.76×10 ¹ | 1.01×10 ² | 6.00×10 ⁻³ |
| Solid-Liquid Separations Facility | 2018 | 2039 | 1.09 | 5.07 | 2.79×10 ¹ | 1.72×10 ⁻³ |
| Cast Stone Facility | 2018 | 2039 | 1.68×10 ¹ | 7.81×10 ¹ | 4.24×10 ² | 2.66×10 ⁻² |
| Effluent Treatment Facility | 2006 | 2045 | 6.46×10 ² | 1.68×10 ¹ | 4.03×10 ² | 8.66×10 ⁻¹ |
| Evaporator | 2006 | 2042 | 3.22 | 8.38×10 ⁻² | 1.51×10 ² | 4.32×10 ⁻³ |
| Borrow Area C | 2006 | 2052 | a | a | 4.24×10 ² | a |
| Deactivation | | | | | | |
| Mobile retrieval system | 2013 | 2042 | a | a | a | a |
| Vacuum-based retrieval system | 2013 | 2042 | a | a | a | a |
| Chemical wash system | 2013 | 2042 | a | a | a | a |
| IHLW Interim Storage Facility | 2067 | 2067 | a | a | a | a |
| Waste Treatment Plant | 2044 | 2045 | 7.24×10 ⁻¹ | 3.36 | 1.74×10 ¹ | 1.14×10 ⁻³ |
| Cesium and Strontium Capsule Processing Facility | 2044 | 2044 | 1.31 | 5.16 | 3.78×10 ⁻¹ | 2.02×10 ⁻³ |
| Contact-Handled Mixed Transuranic Waste Facilities | 2011 | 2012 | 2.47×10 ⁻¹ | 1.15 | 6.31 | 3.90×10 ⁻⁴ |
| Remote-Handled Mixed Transuranic Waste Facility | 2020 | 2021 | 1.86×10 ⁻³ | 8.63×10 ⁻³ | 4.75×10 ⁻² | 2.94×10 ⁻⁶ |
| Transuranic Waste Interim Storage Facility | 2035 | 2035 | a | a | a | a |
| Bulk Vitrification Facility | 2040 | 2041 | 3.80×10 ⁻¹ | 1.76 | 1.01×10 ¹ | 6.00×10 ⁻⁴ |
| Solid-Liquid Separations Facility | 2040 | 2041 | 1.09×10 ⁻¹ | 5.07×10 ⁻¹ | 2.79 | 1.72×10 ⁻⁴ |
| Cast Stone Facility | 2040 | 2041 | 1.68 | 7.81 | 4.24×10 ¹ | 2.66×10 ⁻³ |
| Effluent Treatment Facility original | 2026 | 2026 | 3.23×10 ² | 8.41 | 1.95 | 4.33×10 ⁻¹ |

Table G-75. Tank Closure Alternative 4 Criteria Pollutant Emissions from Mobile Sources (continued)

| Facility/System | Start Year | End Year | Emission Rate (metric tons per year) | | | |
|---|------------|----------|--------------------------------------|-----------------------|----------------------|-----------------------|
| | | | Carbon Monoxide | Nitrogen Dioxide | PM ₁₀ | Sulfur Dioxide |
| Deactivation (continued) | | | | | | |
| Effluent Treatment Facility replacement 1 | 2046 | 2046 | 3.23×10 ² | 8.41 | 1.95 | 4.33×10 ⁻¹ |
| Evaporator original | 2018 | 2018 | 7.89×10 ⁻¹ | 2.05×10 ⁻² | 2.75 | 1.06×10 ⁻³ |
| Evaporator replacement 1 | 2043 | 2043 | 7.89×10 ⁻¹ | 2.05×10 ⁻² | 2.75 | 1.06×10 ⁻³ |
| Closure | | | | | | |
| Grout facility (tank-filling) construction | 2031 | 2032 | a | a | a | a |
| Grout facility (tank-filling) operations | 2033 | 2042 | a | a | a | a |
| Grout facility (tank-filling) deactivation | 2043 | 2043 | a | a | a | a |
| Ancillary equipment grouting | 2012 | 2032 | a | a | a | a |
| Containment structure construction | 2018 | 2021 | a | a | a | a |
| Containment structure deactivation | 2042 | 2044 | a | a | a | a |
| Modified Resource Conservation and Recovery Act Subtitle C barrier construction | 2038 | 2044 | a | a | a | a |
| Decontamination and decommissioning of 10 selected facilities | 2018 | 2028 | a | a | a | a |
| Postclosure care | 2045 | 2144 | a | a | a | a |
| BX tank farm removal | 2022 | 2033 | a | a | a | a |
| BX tank farm deep soil removal | 2034 | 2041 | a | a | a | a |
| SX tank farm removal | 2022 | 2033 | a | a | a | a |
| SX tank farm deep soil removal | 2034 | 2041 | a | a | a | a |
| Preprocessing Facility construction | 2019 | 2021 | 3.06×10 ¹ | 1.42×10 ² | 9.68×10 ² | 4.84×10 ⁻² |
| Preprocessing Facility operations | 2022 | 2042 | 8.79×10 ⁻¹ | 4.08 | 1.91×10 ¹ | 1.39×10 ⁻³ |
| Preprocessing Facility deactivation | 2043 | 2043 | 9.23×10 ⁻² | 4.29×10 ⁻¹ | 2.00 | 1.46×10 ⁻⁴ |

^a Emissions for this activity and pollutant were not calculated because annual fuel use for this activity and the resulting emissions would be small compared with other activities or would be zero.

Key: HLW=high-level radioactive waste; IHLW=immobilized high-level radioactive waste; PM₁₀=particulate matter with an aerodynamic diameter less than or equal to 10 micrometers.

Source: SAIC 2007a, 2008.

Table G-76. Tank Closure Alternative 4 Toxic Pollutant Emissions from Mobile Sources

| Facility/System | Start Year | End Year | Emission Rate (metric tons per year) | | | | | | |
|--|------------|----------|--------------------------------------|-----------------------|-----------------------|-----------------------|---------|-----------------------|-----------------------|
| | | | Ammonia | Benzene | 1,3-Butadiene | Formaldehyde | Mercury | Toluene | Xylene |
| Construction | | | | | | | | | |
| Canister Storage Building | 2006 | 2016 | a | a | a | a | a | a | a |
| IHLW Shipping/Transfer Facility | 2011 | 2013 | a | a | a | a | a | a | a |
| IHLW Interim Storage Modules | 2014 | 2022 | a | a | a | a | a | a | a |
| Other infrastructure upgrades | 2006 | 2034 | a | a | a | a | a | a | a |
| Tank upgrades | 2006 | 2025 | a | a | a | a | a | a | a |
| Waste Treatment Plant | 2006 | 2017 | 7.91×10 ⁻² | 1.06×10 ⁻² | 4.46×10 ⁻⁴ | 2.24×10 ⁻² | a | 4.66×10 ⁻³ | 3.25×10 ⁻³ |
| Cesium and Strontium Capsule Processing Facility | 2038 | 2041 | 2.01×10 ⁻² | 2.75×10 ⁻³ | 1.13×10 ⁻⁴ | 3.43×10 ⁻³ | a | 1.94×10 ⁻³ | 1.04×10 ⁻³ |
| Waste receiver facilities | 2013 | 2017 | a | a | a | a | a | a | a |
| Tank risers | 2013 | 2016 | a | a | a | a | a | a | a |
| Mobile retrieval system | 2013 | 2042 | a | a | a | a | a | a | a |
| Vacuum-based retrieval system | 2013 | 2042 | a | a | a | a | a | a | a |
| Chemical wash system | 2013 | 2042 | a | a | a | a | a | a | a |
| HLW Melter Interim Storage Facility | 2015 | 2016 | a | a | a | a | a | a | a |
| Contact-Handled Mixed Transuranic Waste Facilities | 2008 | 2008 | 4.24×10 ⁻³ | 5.70×10 ⁻⁴ | 2.39×10 ⁻⁵ | 7.21×10 ⁻⁴ | a | 2.50×10 ⁻⁴ | 1.74×10 ⁻⁴ |
| Remote-Handled Mixed Transuranic Waste Facility | 2013 | 2014 | 3.45×10 ⁻³ | 4.64×10 ⁻⁴ | 1.95×10 ⁻⁵ | 5.87×10 ⁻⁴ | a | 2.04×10 ⁻⁴ | 1.42×10 ⁻⁴ |
| Transuranic Waste Interim Storage Facility | 2008 | 2009 | a | a | a | a | a | a | a |
| Bulk Vitrification Facility | 2016 | 2017 | 1.12×10 ⁻² | 3.68×10 ⁻² | 6.34×10 ⁻⁵ | 1.91×10 ⁻³ | a | 1.61×10 ⁻² | 1.12×10 ⁻² |
| Solid-Liquid Separations Facility | 2016 | 2017 | 1.76×10 ⁻³ | 2.37×10 ⁻⁴ | 9.91×10 ⁻⁶ | 2.99×10 ⁻⁴ | a | 1.04×10 ⁻⁴ | 7.23×10 ⁻⁵ |
| Cast Stone Facility | 2016 | 2017 | 7.69×10 ⁻³ | 1.03×10 ⁻³ | 4.33×10 ⁻⁵ | 1.31×10 ⁻³ | a | 4.53×10 ⁻⁴ | 3.16×10 ⁻⁴ |
| Effluent Treatment Facility replacement 1 | 2023 | 2025 | 2.14×10 ⁻² | 4.02×10 ⁻³ | 1.23×10 ⁻⁴ | 3.93×10 ⁻³ | a | 2.02×10 ⁻² | 6.22×10 ⁻³ |
| Evaporator replacement 1 | 2015 | 2017 | 4.76×10 ⁻³ | 9.96×10 ⁻⁴ | 7.95×10 ⁻⁴ | 9.01×10 ⁻⁴ | a | 6.20×10 ⁻³ | 1.86×10 ⁻³ |
| Underground transfer line 1,000-foot sections | 2009 | 2009 | a | a | a | a | a | a | a |
| Operations | | | | | | | | | |
| IHLW Interim Storage Facility | 2018 | 2066 | a | a | a | a | a | a | a |
| Other infrastructure upgrades | 2006 | 2042 | a | a | a | a | a | a | a |
| Routine operations | 2006 | 2042 | 2.26×10 ⁻¹ | 3.42×10 ⁻² | a | a | a | 1.50×10 ⁻² | 1.04×10 ⁻² |
| Retrieval operations | 2006 | 2042 | a | a | a | a | a | a | a |
| Double-shell tank interim stabilization | 2006 | 2042 | a | a | a | a | a | a | a |
| Waste Treatment Plant | 2018 | 2042 | 5.28×10 ⁻² | 7.11×10 ⁻³ | 2.98×10 ⁻⁴ | 8.99×10 ⁻³ | a | 3.12×10 ⁻³ | 2.17×10 ⁻³ |
| Waste Treatment Plant, cesium and strontium capsules | 2043 | 2043 | 5.28×10 ⁻² | 7.11×10 ⁻³ | 2.98×10 ⁻⁴ | 8.99×10 ⁻³ | a | 3.12×10 ⁻³ | 2.17×10 ⁻³ |

Table G-76. Tank Closure Alternative 4 Toxic Pollutant Emissions from Mobile Sources (continued)

| Facility/System | Start Year | End Year | Emission Rate (metric tons per year) | | | | | | |
|--|------------|----------|--------------------------------------|-----------------------|-----------------------|-----------------------|---------|-----------------------|-----------------------|
| | | | Ammonia | Benzene | 1,3-Butadiene | Formaldehyde | Mercury | Toluene | Xylene |
| Operations (continued) | | | | | | | | | |
| Cesium and Strontium Capsule Processing Facility | 2042 | 2043 | 1.76×10 ⁻² | 2.40×10 ⁻³ | 9.93×10 ⁻⁵ | 3.00×10 ⁻³ | a | 1.63×10 ⁻³ | 8.90×10 ⁻⁴ |
| Mobile retrieval system | 2013 | 2042 | a | a | a | a | a | a | a |
| Vacuum-based retrieval system | 2013 | 2042 | a | a | a | a | a | a | a |
| Chemical wash system | 2013 | 2042 | a | a | a | a | a | a | a |
| HLW Melter Interim Storage Facility | 2018 | 2144 | a | a | a | a | a | a | a |
| Contact-Handled Mixed Transuranic Waste Facilities | 2009 | 2010 | 1.80×10 ⁻² | 2.43×10 ⁻³ | 1.02×10 ⁻⁴ | 3.07×10 ⁻³ | a | 1.06×10 ⁻³ | 7.41×10 ⁻⁴ |
| Remote-Handled Mixed Transuranic Waste Facility | 2015 | 2019 | 1.36×10 ⁻⁴ | 1.83×10 ⁻⁵ | 7.65×10 ⁻⁷ | 2.31×10 ⁻⁵ | a | 8.01×10 ⁻⁶ | 5.58×10 ⁻⁶ |
| Transuranic Waste Interim Storage Facility | 2009 | 2034 | a | a | a | a | a | a | a |
| Bulk Vitrification Facility | 2018 | 2039 | 2.77×10 ⁻² | 9.08×10 ⁻² | 1.56×10 ⁻⁴ | 4.72×10 ⁻³ | a | 3.98×10 ⁻² | 2.77×10 ⁻² |
| Solid-Liquid Separations Facility | 2018 | 2039 | 7.97×10 ⁻³ | 1.07×10 ⁻³ | 4.49×10 ⁻⁵ | 1.36×10 ⁻³ | a | 4.70×10 ⁻⁴ | 3.27×10 ⁻⁴ |
| Cast Stone Facility | 2018 | 2039 | 1.23×10 ⁻¹ | 1.65×10 ⁻² | 6.93×10 ⁻⁴ | 2.09×10 ⁻² | a | 7.25×10 ⁻³ | 5.05×10 ⁻³ |
| Effluent Treatment Facility | 2006 | 2045 | 4.99×10 ⁻² | 8.32×10 ⁻² | 4.67×10 ⁻⁴ | 2.80×10 ⁻² | a | 1.28 | 3.61×10 ⁻¹ |
| Evaporator | 2006 | 2042 | 2.49×10 ⁻⁴ | 4.15×10 ⁻⁴ | 2.33×10 ⁻⁶ | 1.40×10 ⁻⁴ | a | 6.38×10 ⁻³ | 1.80×10 ⁻³ |
| Borrow Area C | 2006 | 2052 | a | a | a | a | a | a | a |
| Deactivation | | | | | | | | | |
| Mobile retrieval system | 2013 | 2042 | a | a | a | a | a | a | a |
| Vacuum-based retrieval system | 2013 | 2042 | a | a | a | a | a | a | a |
| Chemical wash system | 2013 | 2042 | a | a | a | a | a | a | a |
| IHLW Interim Storage Facility | 2067 | 2067 | a | a | a | a | a | a | a |
| Waste Treatment Plant | 2044 | 2045 | 5.28×10 ⁻³ | 7.11×10 ⁻⁴ | 2.98×10 ⁻⁵ | 8.99×10 ⁻⁴ | a | 3.12×10 ⁻⁴ | 2.17×10 ⁻⁴ |
| Cesium and Strontium Capsule Processing Facility | 2044 | 2044 | 8.12×10 ⁻³ | 1.12×10 ⁻³ | 4.59×10 ⁻⁵ | 1.39×10 ⁻³ | a | 8.76×10 ⁻⁴ | 4.45×10 ⁻⁴ |
| Contact-Handled Mixed Transuranic Waste Facilities | 2011 | 2012 | 1.80×10 ⁻³ | 2.43×10 ⁻⁴ | 1.02×10 ⁻⁵ | 3.07×10 ⁻⁴ | a | 1.06×10 ⁻⁴ | 7.41×10 ⁻⁵ |
| Remote-Handled Mixed Transuranic Waste Facility | 2020 | 2021 | 1.36×10 ⁻⁵ | 1.83×10 ⁻⁶ | 7.65×10 ⁻⁸ | 2.31×10 ⁻⁶ | a | 8.01×10 ⁻⁷ | 5.58×10 ⁻⁷ |
| Transuranic Waste Interim Storage Facility | 2035 | 2035 | a | a | a | a | a | a | a |
| Bulk Vitrification Facility | 2040 | 2041 | 2.77×10 ⁻³ | 9.08×10 ⁻³ | 1.56×10 ⁻⁵ | 4.72×10 ⁻⁴ | a | 3.98×10 ⁻³ | 2.77×10 ⁻³ |
| Solid-Liquid Separations Facility | 2040 | 2041 | 7.97×10 ⁻⁴ | 1.07×10 ⁻⁴ | 4.49×10 ⁻⁶ | 1.36×10 ⁻⁴ | a | 4.70×10 ⁻⁵ | 3.27×10 ⁻⁵ |
| Cast Stone Facility | 2040 | 2041 | 1.23×10 ⁻² | 1.65×10 ⁻³ | 6.93×10 ⁻⁵ | 2.09×10 ⁻³ | a | 7.25×10 ⁻⁴ | 5.05×10 ⁻⁴ |
| Effluent Treatment Facility original | 2026 | 2026 | 2.50×10 ⁻² | 4.16×10 ⁻² | 2.34×10 ⁻⁴ | 1.40×10 ⁻² | a | 6.40×10 ⁻¹ | 1.81×10 ⁻¹ |
| Effluent Treatment Facility replacement 1 | 2046 | 2046 | 2.50×10 ⁻² | 4.16×10 ⁻² | 2.34×10 ⁻⁴ | 1.40×10 ⁻² | a | 6.40×10 ⁻¹ | 1.81×10 ⁻¹ |
| Evaporator original | 2018 | 2018 | 6.10×10 ⁻⁵ | 1.02×10 ⁻⁴ | 5.70×10 ⁻⁷ | 3.42×10 ⁻⁵ | a | 1.56×10 ⁻³ | 4.40×10 ⁻⁴ |
| Evaporator replacement 1 | 2043 | 2043 | 6.10×10 ⁻⁵ | 1.02×10 ⁻⁴ | 5.70×10 ⁻⁷ | 3.42×10 ⁻⁵ | a | 1.56×10 ⁻³ | 4.40×10 ⁻⁴ |

Table G-76. Tank Closure Alternative 4 Toxic Pollutant Emissions from Mobile Sources (*continued*)

| Facility/System | Start Year | End Year | Emission Rate (metric tons per year) | | | | | | | |
|---|------------|----------|--------------------------------------|-----------------------|-----------------------|-----------------------|---------|-----------------------|-----------------------|---|
| | | | Ammonia | Benzene | 1,3-Butadiene | Formaldehyde | Mercury | Toluene | Xylene | |
| Closure | | | | | | | | | | |
| Grout facility (tank-filling) construction | 2031 | 2032 | a | a | a | a | a | a | a | a |
| Grout facility (tank-filling) operations | 2033 | 2042 | a | a | a | a | a | a | a | a |
| Grout facility (tank-filling) deactivation | 2043 | 2043 | a | a | a | a | a | a | a | a |
| Ancillary equipment grouting | 2012 | 2032 | a | a | a | a | a | a | a | a |
| Containment structure construction | 2018 | 2021 | a | a | a | a | a | a | a | a |
| Containment structure deactivation | 2042 | 2044 | a | a | a | a | a | a | a | a |
| Modified Resource Conservation and Recovery Act Subtitle C barrier construction | 2038 | 2044 | a | a | a | a | a | a | a | a |
| Decontamination and decommissioning of 10 selected facilities | 2018 | 2028 | a | a | a | a | a | a | a | a |
| Postclosure care | 2045 | 2144 | a | a | a | a | a | a | a | a |
| BX tank farm removal | 2022 | 2033 | a | a | a | a | a | a | a | a |
| BX tank farm deep soil removal | 2034 | 2041 | a | a | a | a | a | a | a | a |
| SX tank farm removal | 2022 | 2033 | a | a | a | a | a | a | a | a |
| SX tank farm deep soil removal | 2034 | 2041 | a | a | a | a | a | a | a | a |
| Preprocessing Facility construction | 2019 | 2021 | 2.24×10^{-1} | 1.17×10^{-1} | 4.90×10^{-3} | 1.48×10^{-1} | a | 5.12×10^{-2} | 3.57×10^{-2} | |
| Preprocessing Facility operations | 2022 | 2042 | 6.42×10^{-3} | 6.97×10^{-4} | 2.92×10^{-5} | 8.81×10^{-4} | a | 3.05×10^{-4} | 2.13×10^{-4} | |
| Preprocessing Facility deactivation | 2043 | 2043 | 6.74×10^{-4} | 7.31×10^{-5} | 3.07×10^{-6} | 9.25×10^{-5} | a | 3.21×10^{-5} | 2.23×10^{-5} | |

^a Emissions for this activity and pollutant were not calculated because annual fuel use for this activity and the resulting emissions would be small compared with other activities or would be zero.

Key: HLW=high-level radioactive waste; IHLW=immobilized high-level radioactive waste.

Source: SAIC 2007a, 2008.

Table G-77. Tank Closure Alternative 5 Criteria Pollutant Emissions from Mobile Sources

| Facility/System | Start Year | End Year | Emission Rate (metric tons per year) | | | |
|--|------------|----------|--------------------------------------|----------------------|-----------------------|-----------------------|
| | | | Carbon Monoxide | Nitrogen Dioxide | PM ₁₀ | Sulfur Dioxide |
| Construction | | | | | | |
| Canister Storage Building | 2006 | 2016 | a | a | a | a |
| IHLW Shipping/Transfer Facility | 2011 | 2013 | a | a | a | a |
| IHLW Interim Storage Modules | 2014 | 2019 | a | a | a | a |
| Other infrastructure upgrades | 2006 | 2034 | a | a | a | a |
| Tank upgrades | 2006 | 2025 | a | a | a | a |
| Waste Treatment Plant | 2006 | 2017 | 8.57×10 ⁻¹ | 3.98 | 3.02×10 ¹ | 1.35×10 ⁻³ |
| Cesium and Strontium Capsule Processing Facility | 2029 | 2032 | 3.13 | 1.28×10 ¹ | 4.24×10 ² | 4.85×10 ⁻³ |
| Waste receiver facilities | 2013 | 2017 | a | a | a | a |
| Tank risers | 2013 | 2016 | a | a | a | a |
| Double-shell tank replacement | 2014 | 2019 | a | a | a | a |
| Sulfate Removal Facility | 2016 | 2017 | 6.71 | 3.11×10 ¹ | 1.95×10 ² | 1.06×10 ⁻² |
| Modified sluicing retrieval system | 2013 | 2033 | a | a | a | a |
| Mobile retrieval system | 2013 | 2023 | a | a | a | a |
| Vacuum-based retrieval system | 2024 | 2033 | a | a | a | a |
| HLW Melter Interim Storage Facility | 2015 | 2016 | a | a | a | a |
| Contact-Handled Mixed Transuranic Waste Facilities | 2008 | 2008 | 5.81×10 ⁻¹ | 2.69 | 1.67×10 ¹ | 9.17×10 ⁻⁴ |
| Remote-Handled Mixed Transuranic Waste Facility | 2013 | 2014 | 4.73×10 ⁻¹ | 2.20 | 1.36×10 ¹ | 7.47×10 ⁻⁴ |
| Transuranic Waste Interim Storage Facility | 2008 | 2009 | a | a | a | a |
| Bulk Vitrification Facility | 2016 | 2017 | 1.54 | 7.15 | 4.47×10 ¹ | 2.43×10 ⁻³ |
| Solid-Liquid Separations Facility | 2016 | 2017 | 2.41×10 ⁻¹ | 1.12 | 8.32 | 3.80×10 ⁻⁴ |
| Cast Stone Facility | 2016 | 2017 | 1.05 | 4.89 | 3.05×10 ¹ | 1.66×10 ⁻³ |
| Effluent Treatment Facility replacement 1 | 2023 | 2025 | 1.25×10 ¹ | 1.34×10 ¹ | 4.75×10 ² | 1.74×10 ⁻² |
| Evaporator replacement 1 | 2015 | 2017 | 3.62 | 2.96 | 1.41×10 ² | 5.00×10 ⁻³ |
| Underground transfer line 1,000-foot sections | 2009 | 2009 | a | a | a | a |
| Operations | | | | | | |
| IHLW Interim Storage Facility | 2018 | 2066 | a | a | a | a |
| Other infrastructure upgrades | 2006 | 2033 | a | a | a | a |
| Routine operations | 2006 | 2033 | 3.10×10 ¹ | 1.44×10 ² | 1.32×10 ¹ | 4.73×10 ⁻² |
| Retrieval operations | 2006 | 2033 | a | a | a | a |
| Double-shell tank interim stabilization | 2006 | 2033 | a | a | a | a |
| Waste Treatment Plant | 2018 | 2033 | 2.69×10 ¹ | 1.25×10 ² | 6.46×10 ² | 4.24×10 ⁻² |
| Waste Treatment Plant, cesium and strontium capsules | 2034 | 2034 | 2.69×10 ¹ | 1.25×10 ² | 6.46×10 ² | 4.24×10 ⁻² |
| Cesium and Strontium Capsule Processing Facility | 2033 | 2034 | 2.71 | 1.12×10 ¹ | 8.61×10 ⁻¹ | 4.20×10 ⁻³ |

Table G-77. Tank Closure Alternative 5 Criteria Pollutant Emissions from Mobile Sources (continued)

| Facility/System | Start Year | End Year | Emission Rate (metric tons per year) | | | |
|--|------------|----------|--------------------------------------|-----------------------|-----------------------|-----------------------|
| | | | Carbon Monoxide | Nitrogen Dioxide | PM ₁₀ | Sulfur Dioxide |
| Operations (continued) | | | | | | |
| Double-shell tank replacement | 2020 | 2033 | a | a | a | a |
| Sulfate Removal Facility | 2018 | 2033 | 6.19 | 2.87×10 ¹ | 1.51×10 ² | 9.77×10 ⁻³ |
| Modified sluicing retrieval system | 2013 | 2033 | a | a | a | a |
| Mobile retrieval system | 2013 | 2023 | a | a | a | a |
| Vacuum-based retrieval system | 2024 | 2033 | a | a | a | a |
| HLW Melter Interim Storage Facility | 2018 | 2139 | a | a | a | a |
| Contact-Handled Mixed Transuranic Waste Facilities | 2009 | 2010 | 2.47 | 1.15×10 ¹ | 6.31×10 ¹ | 3.90×10 ⁻³ |
| Remote-Handled Mixed Transuranic Waste Facility | 2015 | 2019 | 1.86×10 ⁻² | 8.63×10 ⁻² | 4.75×10 ⁻¹ | 2.94×10 ⁻⁵ |
| Transuranic Waste Interim Storage Facility | 2009 | 2034 | a | a | a | a |
| Bulk Vitrification Facility | 2018 | 2033 | 5.22 | 2.42×10 ¹ | 1.38×10 ² | 8.25×10 ⁻³ |
| Solid-Liquid Separations Facility | 2018 | 2033 | 1.50 | 6.97 | 3.83×10 ¹ | 2.37×10 ⁻³ |
| Cast Stone Facility | 2018 | 2033 | 2.31×10 ¹ | 1.07×10 ² | 5.84×10 ² | 3.65×10 ⁻² |
| Effluent Treatment Facility | 2006 | 2036 | 6.46×10 ² | 1.68×10 ¹ | 2.27×10 ² | 8.66×10 ⁻¹ |
| Evaporator | 2006 | 2034 | 3.22 | 8.38×10 ⁻² | 9.25×10 ¹ | 4.32×10 ⁻³ |
| Borrow Area C | 2006 | 2052 | a | a | 4.24×10 ² | a |
| Deactivation | | | | | | |
| Sulfate Removal Facility | 2034 | 2035 | 6.19×10 ⁻¹ | 2.87 | 1.51×10 ¹ | 9.77×10 ⁻⁴ |
| Modified sluicing retrieval system | 2013 | 2033 | a | a | a | a |
| Mobile retrieval system | 2013 | 2023 | a | a | a | a |
| Vacuum-based retrieval system | 2024 | 2033 | a | a | a | a |
| IHLW Interim Storage Facility | 2067 | 2067 | a | a | a | a |
| Waste Treatment Plant | 2035 | 2036 | 2.53 | 1.17×10 ¹ | 6.08×10 ¹ | 3.99×10 ⁻³ |
| Cesium and Strontium Capsule Processing Facility | 2035 | 2035 | 1.31 | 5.16 | 3.78×10 ⁻¹ | 2.02×10 ⁻³ |
| Contact-Handled Mixed Transuranic Waste Facilities | 2011 | 2012 | 2.47×10 ⁻¹ | 1.15 | 6.31 | 3.90×10 ⁻⁴ |
| Remote-Handled Mixed Transuranic Waste Facility | 2020 | 2021 | 1.86×10 ⁻³ | 8.63×10 ⁻³ | 4.75×10 ⁻² | 2.94×10 ⁻⁶ |
| Transuranic Waste Interim Storage Facility | 2035 | 2035 | a | a | a | a |
| Bulk Vitrification Facility | 2034 | 2035 | 5.22×10 ⁻¹ | 2.42 | 1.38×10 ¹ | 8.25×10 ⁻⁴ |
| Solid-Liquid Separations Facility | 2034 | 2035 | 1.50×10 ⁻¹ | 6.97×10 ⁻¹ | 3.83 | 2.37×10 ⁻⁴ |
| Cast Stone Facility | 2034 | 2035 | 2.31 | 1.07×10 ¹ | 5.84×10 ¹ | 3.65×10 ⁻³ |
| Effluent Treatment Facility original | 2026 | 2026 | 3.23×10 ² | 8.41 | 1.95 | 4.33×10 ⁻¹ |
| Effluent Treatment Facility replacement 1 | 2037 | 2037 | 3.23×10 ² | 8.41 | 1.95 | 4.33×10 ⁻¹ |
| Evaporator original | 2018 | 2018 | 7.89×10 ⁻¹ | 2.05×10 ⁻² | 2.75 | 1.06×10 ⁻³ |
| Evaporator replacement 1 | 2035 | 2035 | 7.89×10 ⁻¹ | 2.05×10 ⁻² | 2.75 | 1.06×10 ⁻³ |

Table G-77. Tank Closure Alternative 5 Criteria Pollutant Emissions from Mobile Sources (continued)

| Facility/System | Start Year | End Year | Emission Rate (metric tons per year) | | | |
|---|------------|----------|--------------------------------------|----------------------|----------------------|-----------------------|
| | | | Carbon Monoxide | Nitrogen Dioxide | PM ₁₀ | Sulfur Dioxide |
| Closure | | | | | | |
| Grout facility (tank-filling) construction | 2022 | 2023 | a | a | a | a |
| Grout facility (tank-filling) operations | 2024 | 2033 | a | a | a | a |
| Grout facility (tank-filling) deactivation | 2034 | 2034 | a | a | a | a |
| Ancillary equipment grouting | 2013 | 2033 | a | a | a | a |
| Hanford barrier construction | 2029 | 2039 | 1.80×10 ¹ | 8.37×10 ¹ | 7.09×10 ² | 2.85×10 ⁻² |
| Decontamination and decommissioning of 10 selected facilities | 2012 | 2022 | a | a | a | a |
| Postclosure care | 2040 | 2139 | a | a | a | a |

^a Emissions for this activity and pollutant were not calculated because annual fuel use for this activity and the resulting emissions would be small compared with other activities or would be zero.

Key: HLW=high-level radioactive waste; IHLW=immobilized high-level radioactive waste; PM₁₀=particulate matter with an aerodynamic diameter less than or equal to 10 micrometers.

Source: SAIC 2007a, 2008.

Table G-78. Tank Closure Alternative 5 Toxic Pollutant Emissions from Mobile Sources

| Facility/System | Start Year | End Year | Emission Rate (metric tons per year) | | | | | | |
|--|------------|----------|--------------------------------------|-----------------------|-----------------------|-----------------------|---------|-----------------------|-----------------------|
| | | | Ammonia | Benzene | 1,3-Butadiene | Formaldehyde | Mercury | Toluene | Xylene |
| Construction | | | | | | | | | |
| Canister Storage Building | 2006 | 2016 | a | a | a | a | a | a | a |
| IHLW Shipping/Transfer Facility | 2011 | 2013 | a | a | a | a | a | a | a |
| IHLW Interim Storage Modules | 2014 | 2019 | a | a | a | a | a | a | a |
| Other infrastructure upgrades | 2006 | 2034 | a | a | a | a | a | a | a |
| Tank upgrades | 2006 | 2025 | a | a | a | a | a | a | a |
| Waste Treatment Plant | 2006 | 2017 | 6.25×10 ⁻³ | 8.41×10 ⁻⁴ | 3.53×10 ⁻⁵ | 1.06×10 ⁻³ | a | 3.69×10 ⁻⁴ | 2.57×10 ⁻⁴ |
| Cesium and Strontium Capsule Processing Facility | 2029 | 2032 | 2.01×10 ⁻² | 2.75×10 ⁻³ | 1.13×10 ⁻⁴ | 3.43×10 ⁻³ | a | 1.94×10 ⁻³ | 1.04×10 ⁻³ |
| Waste receiver facilities | 2013 | 2017 | a | a | a | a | a | a | a |
| Tank risers | 2013 | 2016 | a | a | a | a | a | a | a |
| Double-shell tank replacement | 2014 | 2019 | a | a | a | a | a | a | a |
| Sulfate Removal Facility | 2016 | 2017 | 4.89×10 ⁻² | 6.59×10 ⁻³ | 2.76×10 ⁻⁴ | 8.33×10 ⁻³ | a | 2.89×10 ⁻³ | 2.01×10 ⁻³ |
| Modified sluicing retrieval system | 2013 | 2033 | a | a | a | a | a | a | a |
| Mobile retrieval system | 2013 | 2023 | a | a | a | a | a | a | a |
| Vacuum-based retrieval system | 2024 | 2033 | a | a | a | a | a | a | a |
| HLW Melter Interim Storage Facility | 2015 | 2016 | a | a | a | a | a | a | a |
| Contact-Handled Mixed Transuranic Waste Facilities | 2008 | 2008 | 4.24×10 ⁻³ | 5.70×10 ⁻⁴ | 2.39×10 ⁻⁵ | 7.21×10 ⁻⁴ | a | 2.50×10 ⁻⁴ | 1.74×10 ⁻⁴ |
| Remote-Handled Mixed Transuranic Waste Facility | 2013 | 2014 | 3.45×10 ⁻³ | 4.64×10 ⁻⁴ | 1.95×10 ⁻⁵ | 5.87×10 ⁻⁴ | a | 2.04×10 ⁻⁴ | 1.42×10 ⁻⁴ |
| Transuranic Waste Interim Storage Facility | 2008 | 2009 | a | a | a | a | a | a | a |
| Bulk Vitrification Facility | 2016 | 2017 | 1.12×10 ⁻² | 3.68×10 ⁻² | 6.34×10 ⁻⁵ | 1.91×10 ⁻³ | a | 1.61×10 ⁻² | 1.12×10 ⁻² |
| Solid-Liquid Separations Facility | 2016 | 2017 | 1.76×10 ⁻³ | 2.37×10 ⁻⁴ | 9.91×10 ⁻⁶ | 2.99×10 ⁻⁴ | a | 1.04×10 ⁻⁴ | 7.23×10 ⁻⁵ |
| Cast Stone Facility | 2016 | 2017 | 7.69×10 ⁻³ | 1.03×10 ⁻³ | 4.33×10 ⁻⁵ | 1.31×10 ⁻³ | a | 4.53×10 ⁻⁴ | 3.16×10 ⁻⁴ |
| Effluent Treatment Facility replacement 1 | 2023 | 2025 | 2.14×10 ⁻² | 4.02×10 ⁻³ | 1.23×10 ⁻⁴ | 3.93×10 ⁻³ | a | 2.02×10 ⁻² | 6.22×10 ⁻³ |
| Evaporator replacement 1 | 2015 | 2017 | 4.76×10 ⁻³ | 9.96×10 ⁻⁴ | 7.95×10 ⁻⁴ | 9.01×10 ⁻⁴ | a | 6.20×10 ⁻³ | 1.86×10 ⁻³ |
| Underground transfer line 1,000-foot sections | 2009 | 2009 | a | a | a | a | a | a | a |
| Operations | | | | | | | | | |
| IHLW Interim Storage Facility | 2018 | 2066 | a | a | a | a | a | a | a |
| Other infrastructure upgrades | 2006 | 2033 | a | a | a | a | a | a | a |
| Routine operations | 2006 | 2033 | 2.26×10 ⁻¹ | 3.42×10 ⁻² | a | a | a | 1.50×10 ⁻² | 1.04×10 ⁻² |
| Retrieval operations | 2006 | 2033 | a | a | a | a | a | a | a |
| Double-shell tank interim stabilization | 2006 | 2033 | a | a | a | a | a | a | a |
| Waste Treatment Plant | 2018 | 2033 | 1.96×10 ⁻¹ | 2.64×10 ⁻² | 1.11×10 ⁻³ | 3.34×10 ⁻² | a | 1.16×10 ⁻² | 8.06×10 ⁻³ |

Table G-78. Tank Closure Alternative 5 Toxic Pollutant Emissions from Mobile Sources (continued)

| Facility/System | Start Year | End Year | Emission Rate (metric tons per year) | | | | | | |
|--|------------|----------|--------------------------------------|-----------------------|-----------------------|-----------------------|---------|-----------------------|-----------------------|
| | | | Ammonia | Benzene | 1,3-Butadiene | Formaldehyde | Mercury | Toluene | Xylene |
| Operations (continued) | | | | | | | | | |
| Waste Treatment Plant, cesium and strontium capsules | 2034 | 2034 | 1.96×10^{-1} | 2.64×10^{-2} | 1.11×10^{-3} | 3.34×10^{-2} | a | 1.16×10^{-2} | 8.06×10^{-3} |
| Cesium and Strontium Capsule Processing Facility | 2033 | 2034 | 1.76×10^{-2} | 2.40×10^{-3} | 9.93×10^{-5} | 3.00×10^{-3} | a | 1.63×10^{-3} | 8.90×10^{-4} |
| Double-shell tank replacement | 2020 | 2033 | a | a | a | a | a | a | a |
| Sulfate Removal Facility | 2018 | 2033 | 4.52×10^{-2} | 6.08×10^{-3} | 2.55×10^{-4} | 7.69×10^{-3} | a | 2.66×10^{-3} | 1.86×10^{-3} |
| Modified sluicing retrieval system | 2013 | 2033 | a | a | a | a | a | a | a |
| Mobile retrieval system | 2013 | 2023 | a | a | a | a | a | a | a |
| Vacuum-based retrieval system | 2024 | 2033 | a | a | a | a | a | a | a |
| HLW Melter Interim Storage Facility | 2018 | 2139 | a | a | a | a | a | a | a |
| Contact-Handled Mixed Transuranic Waste Facilities | 2009 | 2010 | 1.80×10^{-2} | 2.43×10^{-3} | 1.02×10^{-4} | 3.07×10^{-3} | a | 1.06×10^{-3} | 7.41×10^{-4} |
| Remote-Handled Mixed Transuranic Waste Facility | 2015 | 2019 | 1.36×10^{-4} | 1.83×10^{-5} | 7.65×10^{-7} | 2.31×10^{-5} | a | 8.01×10^{-6} | 5.58×10^{-6} |
| Transuranic Waste Interim Storage Facility | 2009 | 2034 | a | a | a | a | a | a | a |
| Bulk Vitrification Facility | 2018 | 2033 | 3.81×10^{-2} | 1.25×10^{-1} | 2.15×10^{-4} | 6.49×10^{-3} | a | 5.47×10^{-2} | 3.81×10^{-2} |
| Solid-Liquid Separations Facility | 2018 | 2033 | 1.10×10^{-2} | 1.47×10^{-3} | 6.18×10^{-5} | 1.86×10^{-3} | a | 6.46×10^{-4} | 4.50×10^{-4} |
| Cast Stone Facility | 2018 | 2033 | 1.69×10^{-1} | 2.27×10^{-2} | 9.52×10^{-4} | 2.87×10^{-2} | a | 9.96×10^{-3} | 6.94×10^{-3} |
| Effluent Treatment Facility | 2006 | 2036 | 5.00×10^{-2} | 8.32×10^{-2} | 4.67×10^{-4} | 2.80×10^{-2} | a | 1.28 | 3.61×10^{-1} |
| Evaporator | 2006 | 2034 | 2.49×10^{-4} | 4.15×10^{-4} | 2.33×10^{-6} | 1.40×10^{-4} | a | 6.38×10^{-3} | 1.80×10^{-3} |
| Borrow Area C | 2006 | 2052 | a | a | a | a | a | a | a |
| Deactivation | | | | | | | | | |
| Sulfate Removal Facility | 2034 | 2035 | 4.52×10^{-3} | 6.08×10^{-4} | 2.55×10^{-5} | 7.69×10^{-4} | a | 2.66×10^{-4} | 1.86×10^{-4} |
| Modified sluicing retrieval system | 2013 | 2033 | a | a | a | a | a | a | a |
| Mobile retrieval system | 2013 | 2023 | a | a | a | a | a | a | a |
| Vacuum-based retrieval system | 2024 | 2033 | a | a | a | a | a | a | a |
| IHLW Interim Storage Facility | 2067 | 2067 | a | a | a | a | a | a | a |
| Waste Treatment Plant | 2035 | 2036 | 1.85×10^{-2} | 2.48×10^{-3} | 1.04×10^{-4} | 3.14×10^{-3} | a | 1.09×10^{-3} | 7.59×10^{-4} |
| Cesium and Strontium Capsule Processing Facility | 2035 | 2035 | 8.12×10^{-3} | 1.12×10^{-3} | 4.59×10^{-5} | 1.39×10^{-3} | a | 8.76×10^{-4} | 4.45×10^{-4} |
| Contact-Handled Mixed Transuranic Waste Facilities | 2011 | 2012 | 1.80×10^{-3} | 2.43×10^{-4} | 1.02×10^{-5} | 3.07×10^{-4} | a | 1.06×10^{-4} | 7.41×10^{-5} |
| Remote-Handled Mixed Transuranic Waste Facility | 2020 | 2021 | 1.36×10^{-5} | 1.83×10^{-6} | 7.65×10^{-8} | 2.31×10^{-6} | a | 8.01×10^{-7} | 5.58×10^{-7} |
| Transuranic Waste Interim Storage Facility | 2035 | 2035 | a | a | a | a | a | a | a |
| Bulk Vitrification Facility | 2034 | 2035 | 3.81×10^{-3} | 1.25×10^{-2} | 2.15×10^{-5} | 6.49×10^{-4} | a | 5.47×10^{-3} | 3.81×10^{-3} |
| Solid-Liquid Separations Facility | 2034 | 2035 | 1.10×10^{-3} | 1.47×10^{-4} | 6.18×10^{-6} | 1.86×10^{-4} | a | 6.46×10^{-5} | 4.50×10^{-5} |
| Cast Stone Facility | 2034 | 2035 | 1.69×10^{-2} | 2.27×10^{-3} | 9.52×10^{-5} | 2.87×10^{-3} | a | 9.96×10^{-4} | 6.94×10^{-4} |
| Effluent Treatment Facility original | 2026 | 2026 | 2.50×10^{-2} | 4.16×10^{-2} | 2.34×10^{-4} | 1.40×10^{-2} | a | 6.40×10^{-1} | 1.81×10^{-1} |

Table G-78. Tank Closure Alternative 5 Toxic Pollutant Emissions from Mobile Sources (continued)

| Facility/System | Start Year | End Year | Emission Rate (metric tons per year) | | | | | | |
|---|------------|----------|--------------------------------------|-----------------------|-----------------------|-----------------------|---------|-----------------------|-----------------------|
| | | | Ammonia | Benzene | 1,3-Butadiene | Formaldehyde | Mercury | Toluene | Xylene |
| Deactivation (continued) | | | | | | | | | |
| Effluent Treatment Facility replacement 1 | 2037 | 2037 | 2.50×10^{-2} | 4.16×10^{-2} | 2.34×10^{-4} | 1.40×10^{-2} | a | 6.40×10^{-1} | 1.81×10^{-1} |
| Evaporator original | 2018 | 2018 | 6.10×10^{-5} | 1.02×10^{-4} | 5.70×10^{-7} | 3.42×10^{-5} | a | 1.56×10^{-3} | 4.40×10^{-4} |
| Evaporator replacement 1 | 2035 | 2035 | 6.10×10^{-5} | 1.02×10^{-4} | 5.70×10^{-7} | 3.42×10^{-5} | a | 1.56×10^{-3} | 4.40×10^{-4} |
| Closure | | | | | | | | | |
| Grout facility (tank-filling) construction | 2022 | 2023 | a | a | a | a | a | a | a |
| Grout facility (tank-filling) operations | 2024 | 2033 | a | a | a | a | a | a | a |
| Grout facility (tank-filling) deactivation | 2034 | 2034 | a | a | a | a | a | a | a |
| Ancillary equipment grouting | 2013 | 2033 | a | a | a | a | a | a | a |
| Hanford barrier construction | 2029 | 2039 | 1.32×10^{-1} | 3.29×10^{-1} | 1.38×10^{-2} | 4.16×10^{-1} | a | 1.44×10^{-1} | 1.00×10^{-1} |
| Decontamination and decommissioning of 10 selected facilities | 2012 | 2022 | a | a | a | a | a | a | a |
| Postclosure care | 2040 | 2139 | a | a | a | a | a | a | a |

^a Emissions for this activity and pollutant were not calculated because annual fuel use for this activity and the resulting emissions would be small compared with other activities or would be zero.

Key: HLW=high-level radioactive waste; IHLW=immobilized high-level radioactive waste.

Source: SAIC 2007a, 2008.

Table G-79. Tank Closure Alternative 6A, Base Case, Criteria Pollutant Emissions from Mobile Sources

| Facility/System | Start Year | End Year | Emission Rate (metric tons per year) | | | |
|--|------------|----------|--------------------------------------|----------------------|----------------------|-----------------------|
| | | | Carbon Monoxide | Nitrogen Dioxide | PM ₁₀ | Sulfur Dioxide |
| Construction | | | | | | |
| Canister Storage Building | 2006 | 2016 | a | a | a | a |
| IHLW Shipping/Transfer Facility | 2011 | 2013 | a | a | a | a |
| IHLW Interim Storage Modules | 2014 | 2157 | a | a | a | a |
| Other infrastructure upgrades | 2006 | 2034 | a | a | a | a |
| Tank upgrades | 2006 | 2025 | a | a | a | a |
| Waste Treatment Plant original | 2006 | 2017 | 8.67 | 4.02×10 ¹ | 1.08×10 ² | 1.37×10 ⁻² |
| Cesium and Strontium Capsule Processing Facility | 2158 | 2161 | 3.13 | 1.28×10 ¹ | 4.24×10 ² | 4.85×10 ⁻³ |
| Tank risers | 2013 | 2016 | a | a | a | a |
| Double-shell tank replacement 1 | 2029 | 2034 | a | a | a | a |
| Double-shell tank replacement 2 | 2069 | 2074 | a | a | a | a |
| Double-shell tank replacement 3 | 2109 | 2114 | a | a | a | a |
| Mobile retrieval system | 2013 | 2162 | a | a | a | a |
| Vacuum-based retrieval system | 2013 | 2162 | a | a | a | a |
| Chemical wash system | 2013 | 2162 | a | a | a | a |
| HLW Melter Interim Storage Facility 1 | 2017 | 2018 | a | a | a | a |
| HLW Melter Interim Storage Facility 2 | 2037 | 2038 | a | a | a | a |
| HLW Melter Interim Storage Facility 3 | 2057 | 2058 | a | a | a | a |
| HLW Melter Interim Storage Facility 4 | 2077 | 2078 | a | a | a | a |
| HLW Melter Interim Storage Facility 5 | 2097 | 2098 | a | a | a | a |
| HLW Melter Interim Storage Facility 6 | 2117 | 2118 | a | a | a | a |
| HLW Melter Interim Storage Facility 7 | 2137 | 2138 | a | a | a | a |
| Underground transfer line replacement | 2064 | 2064 | a | a | a | a |
| Waste Treatment Plant replacement 1 | 2067 | 2078 | 6.46 | 3.00×10 ¹ | 8.32×10 ¹ | 1.02×10 ⁻² |
| Waste Treatment Plant replacement 2 | 2127 | 2138 | 6.46 | 3.00×10 ¹ | 8.32×10 ¹ | 1.02×10 ⁻² |
| IHLW Shipping/Transfer Facility 1 | 2076 | 2078 | a | a | a | a |
| IHLW Shipping/Transfer Facility 2 | 2136 | 2138 | a | a | a | a |
| IHLW Shipping/Transfer Facility 3 | 2196 | 2198 | a | a | a | a |
| IHLW Interim Storage Modules, additional | 2078 | 2197 | a | a | a | a |
| HLW Debris Storage Facility | 2041 | 2110 | a | a | a | a |
| Effluent Treatment Facility replacement 1 | 2023 | 2025 | 1.25×10 ¹ | 1.34×10 ¹ | 4.75×10 ² | 1.74×10 ⁻² |
| Effluent Treatment Facility replacement 2 | 2053 | 2055 | 1.24×10 ¹ | 1.33×10 ¹ | 1.89×10 ³ | 1.73×10 ⁻² |
| Effluent Treatment Facility replacement 3 | 2083 | 2085 | 1.24×10 ¹ | 1.33×10 ¹ | 1.89×10 ³ | 1.73×10 ⁻² |
| Effluent Treatment Facility replacement 4 | 2113 | 2115 | 1.24×10 ¹ | 1.33×10 ¹ | 1.89×10 ³ | 1.73×10 ⁻² |

Table G-79. Tank Closure Alternative 6A, Base Case, Criteria Pollutant Emissions from Mobile Sources (continued)

| Facility/System | Start Year | End Year | Emission Rate (metric tons per year) | | | |
|--|------------|----------|--------------------------------------|-----------------------|-----------------------|-----------------------|
| | | | Carbon Monoxide | Nitrogen Dioxide | PM ₁₀ | Sulfur Dioxide |
| Construction (continued) | | | | | | |
| Effluent Treatment Facility replacement 5 | 2143 | 2145 | 1.24×10 ¹ | 1.33×10 ¹ | 1.89×10 ³ | 1.73×10 ⁻² |
| Evaporator replacement 1 | 2015 | 2017 | 3.62 | 2.96 | 1.41×10 ² | 5.00×10 ⁻³ |
| Evaporator replacement 2 | 2040 | 2042 | 3.61 | 2.94 | 6.98×10 ² | 4.98×10 ⁻³ |
| Evaporator replacement 3 | 2065 | 2067 | 3.61 | 2.94 | 6.98×10 ² | 4.98×10 ⁻³ |
| Evaporator replacement 4 | 2090 | 2092 | 3.61 | 2.94 | 6.98×10 ² | 4.98×10 ⁻³ |
| Evaporator replacement 5 | 2115 | 2117 | 3.61 | 2.94 | 6.98×10 ² | 4.98×10 ⁻³ |
| Evaporator replacement 6 | 2140 | 2142 | 3.61 | 2.94 | 6.98×10 ² | 4.98×10 ⁻³ |
| Underground transfer line 1,000-foot sections | 2009 | 2009 | a | a | a | a |
| Operations | | | | | | |
| IHLW Interim Storage Facility | 2018 | 2262 | a | a | a | a |
| Other infrastructure upgrades | 2006 | 2162 | a | a | a | a |
| Routine operations | 2006 | 2162 | 3.10×10 ¹ | 1.44×10 ² | 1.32×10 ¹ | 4.73×10 ⁻² |
| Retrieval operations | 2006 | 2162 | a | a | a | a |
| Double-shell tank interim stabilization | 2006 | 2162 | a | a | a | a |
| Waste Treatment Plant | 2018 | 2162 | 2.98×10 ¹ | 1.38×10 ² | 5.83×10 ² | 4.70×10 ⁻² |
| Waste Treatment Plant, cesium and strontium capsules | 2163 | 2163 | 2.98×10 ¹ | 1.38×10 ² | 5.83×10 ² | 4.70×10 ⁻² |
| Cesium and Strontium Capsule Processing Facility | 2162 | 2163 | 2.71 | 1.12×10 ¹ | 8.61×10 ⁻¹ | 4.20×10 ⁻³ |
| Mobile retrieval system | 2013 | 2162 | a | a | a | a |
| Vacuum-based retrieval system | 2013 | 2162 | a | a | a | a |
| Chemical wash system | 2013 | 2162 | a | a | a | a |
| HLW Melter Interim Storage Facility | 2018 | 2262 | a | a | a | a |
| HLW Debris Storage Facility | 2042 | 2262 | a | a | a | a |
| Effluent Treatment Facility | 2006 | 2166 | 6.46×10 ² | 1.68×10 ¹ | 1.26×10 ⁴ | 8.66×10 ⁻¹ |
| Evaporator | 2018 | 2163 | 3.22 | 8.38×10 ⁻² | 2.34×10 ³ | 4.32×10 ⁻³ |
| Borrow Area C | 2006 | 2167 | a | a | 4.24×10 ² | a |
| Deactivation | | | | | | |
| Mobile retrieval system | 2013 | 2162 | a | a | a | a |
| Vacuum-based retrieval system | 2013 | 2162 | a | a | a | a |
| Chemical wash system | 2013 | 2162 | a | a | a | a |
| IHLW Interim Storage Facility | 2078 | 2197 | a | a | a | a |
| Waste Treatment Plant original | 2078 | 2080 | 6.92×10 ⁻¹ | 3.21 | 1.36×10 ¹ | 1.09×10 ⁻³ |
| Waste Treatment Plant replacement 1 | 2138 | 2140 | 6.92×10 ⁻¹ | 3.21 | 1.36×10 ¹ | 1.09×10 ⁻³ |
| Waste Treatment Plant replacement 2 | 2164 | 2166 | 6.92×10 ⁻¹ | 3.21 | 1.36×10 ¹ | 1.09×10 ⁻³ |

Table G-79. Tank Closure Alternative 6A, Base Case, Criteria Pollutant Emissions from Mobile Sources (continued)

| Facility/System | Start Year | End Year | Emission Rate (metric tons per year) | | | |
|---|------------|----------|--------------------------------------|-----------------------|-----------------------|-----------------------|
| | | | Carbon Monoxide | Nitrogen Dioxide | PM ₁₀ | Sulfur Dioxide |
| Deactivation (continued) | | | | | | |
| Cesium and Strontium Capsule Processing Facility | 2164 | 2164 | 1.31 | 5.16 | 3.78×10 ⁻¹ | 2.02×10 ⁻³ |
| Effluent Treatment Facility original | 2026 | 2026 | 3.23×10 ² | 8.40 | 8.66 | 4.33×10 ⁻¹ |
| Effluent Treatment Facility replacement 1 | 2056 | 2056 | 3.23×10 ² | 8.40 | 8.66 | 4.33×10 ⁻¹ |
| Effluent Treatment Facility replacement 2 | 2086 | 2086 | 3.23×10 ² | 8.40 | 8.66 | 4.33×10 ⁻¹ |
| Effluent Treatment Facility replacement 3 | 2116 | 2116 | 3.23×10 ² | 8.40 | 8.66 | 4.33×10 ⁻¹ |
| Effluent Treatment Facility replacement 4 | 2146 | 2146 | 3.23×10 ² | 8.40 | 8.66 | 4.33×10 ⁻¹ |
| Effluent Treatment Facility replacement 5 | 2167 | 2167 | 3.23×10 ² | 8.40 | 8.66 | 4.33×10 ⁻¹ |
| Evaporator original | 2018 | 2018 | 7.89×10 ⁻¹ | 2.05×10 ⁻² | 1.92×10 ¹ | 1.06×10 ⁻³ |
| Evaporator replacement 1 | 2043 | 2043 | 7.89×10 ⁻¹ | 2.05×10 ⁻² | 1.92×10 ¹ | 1.06×10 ⁻³ |
| Evaporator replacement 2 | 2068 | 2068 | 7.89×10 ⁻¹ | 2.05×10 ⁻² | 1.92×10 ¹ | 1.06×10 ⁻³ |
| Evaporator replacement 3 | 2093 | 2093 | 7.89×10 ⁻¹ | 2.05×10 ⁻² | 1.92×10 ¹ | 1.06×10 ⁻³ |
| Evaporator replacement 4 | 2118 | 2118 | 7.89×10 ⁻¹ | 2.05×10 ⁻² | 1.92×10 ¹ | 1.06×10 ⁻³ |
| Evaporator replacement 5 | 2143 | 2143 | 7.89×10 ⁻¹ | 2.05×10 ⁻² | 1.92×10 ¹ | 1.06×10 ⁻³ |
| Evaporator replacement 6 | 2168 | 2168 | 7.89×10 ⁻¹ | 2.05×10 ⁻² | 1.92×10 ¹ | 1.06×10 ⁻³ |
| Closure | | | | | | |
| Containment structure construction 1 | 2038 | 2041 | a | a | a | a |
| Containment structure construction 2 | 2061 | 2064 | a | a | a | a |
| Containment structure construction 3 | 2084 | 2087 | a | a | a | a |
| Containment structure construction 4 | 2107 | 2110 | a | a | a | a |
| Containment structure construction 5 | 2122 | 2125 | a | a | a | a |
| Containment structure construction 6 | 2138 | 2141 | a | a | a | a |
| Containment structure deactivation 1 | 2062 | 2064 | a | a | a | a |
| Containment structure deactivation 2 | 2085 | 2087 | a | a | a | a |
| Containment structure deactivation 3 | 2108 | 2110 | a | a | a | a |
| Containment structure deactivation 4 | 2123 | 2125 | a | a | a | a |
| Containment structure deactivation 5 | 2146 | 2148 | a | a | a | a |
| Containment structure deactivation 6 | 2138 | 2140 | a | a | a | a |
| Containment structure deactivation 7 | 2162 | 2164 | a | a | a | a |
| Decontamination and decommissioning of 10 selected facilities | 2018 | 2028 | a | a | a | a |
| Modified Resource Conservation and Recovery Act Subtitle C barrier construction | 2149 | 2150 | 1.78×10 ¹ | 8.28×10 ¹ | 7.01×10 ² | 2.81×10 ⁻² |
| Postclosure care | 2151 | 2250 | a | a | a | a |

Table G-79. Tank Closure Alternative 6A, Base Case, Criteria Pollutant Emissions from Mobile Sources (*continued*)

| Facility/System | Start Year | End Year | Emission Rate (metric tons per year) | | | |
|-------------------------------------|------------|----------|--------------------------------------|-----------------------|-----------------------|-----------------------|
| | | | Carbon Monoxide | Nitrogen Dioxide | PM ₁₀ | Sulfur Dioxide |
| Closure (<i>continued</i>) | | | | | | |
| B tank farm removal | 2065 | 2076 | a | a | a | a |
| T tank farm removal | 2126 | 2137 | a | a | a | a |
| BY tank farm removal | 2111 | 2122 | a | a | a | a |
| BX tank farm removal | 2042 | 2053 | a | a | a | a |
| C tank farm removal | 2088 | 2099 | a | a | a | a |
| A tank farm removal | 2142 | 2153 | a | a | a | a |
| AX tank farm removal | 2142 | 2153 | a | a | a | a |
| S tank farm removal | 2126 | 2137 | a | a | a | a |
| TY tank farm removal | 2111 | 2122 | a | a | a | a |
| TX tank farm removal | 2088 | 2099 | a | a | a | a |
| U tank farm removal | 2065 | 2076 | a | a | a | a |
| SX tank farm removal | 2042 | 2053 | a | a | a | a |
| B tank farm deep soil removal | 2077 | 2084 | a | a | a | a |
| T tank farm deep soil removal | 2138 | 2145 | a | a | a | a |
| BX tank farm deep soil removal | 2054 | 2061 | a | a | a | a |
| C tank farm deep soil removal | 2100 | 2107 | a | a | a | a |
| A tank farm deep soil removal | 2154 | 2161 | a | a | a | a |
| AX tank farm deep soil removal | 2154 | 2161 | a | a | a | a |
| TX tank farm deep soil removal | 2100 | 2107 | a | a | a | a |
| U tank farm deep soil removal | 2077 | 2084 | a | a | a | a |
| SX tank farm deep soil removal | 2054 | 2061 | a | a | a | a |
| Preprocessing Facility construction | 2039 | 2041 | 3.06×10 ¹ | 1.42×10 ² | 9.68×10 ² | 4.84×10 ⁻² |
| Preprocessing Facility operations | 2042 | 2162 | 1.88×10 ⁻² | 8.75×10 ⁻² | 4.09×10 ⁻¹ | 2.98×10 ⁻⁵ |
| Preprocessing Facility deactivation | 2163 | 2163 | 2.96×10 ⁻³ | 1.37×10 ⁻² | 6.42×10 ⁻² | 4.68×10 ⁻⁶ |

^a Emissions for this activity and pollutant were not calculated because annual fuel use for this activity and the resulting emissions would be small compared with other activities or would be zero.

Key: HLW=high-level radioactive waste; IHLW=immobilized high-level radioactive waste; PM₁₀=particulate matter with an aerodynamic diameter less than or equal to 10 micrometers.

Source: SAIC 2007a, 2008.

Table G–80. Tank Closure Alternative 6A, Base Case, Toxic Pollutant Emissions from Mobile Sources

| Facility/System | Start Year | End Year | Emission Rate (metric tons per year) | | | | | | |
|--|------------|----------|--------------------------------------|-----------------------|-----------------------|-----------------------|---------|-----------------------|-----------------------|
| | | | Ammonia | Benzene | 1,3-Butadiene | Formaldehyde | Mercury | Toluene | Xylene |
| Construction | | | | | | | | | |
| Canister Storage Building | 2006 | 2016 | a | a | a | a | a | a | a |
| IHLW Shipping/Transfer Facility | 2011 | 2013 | a | a | a | a | a | a | a |
| IHLW Interim Storage Modules | 2014 | 2157 | a | a | a | a | a | a | a |
| Other infrastructure upgrades | 2006 | 2034 | a | a | a | a | a | a | a |
| Tank upgrades | 2006 | 2025 | a | a | a | a | a | a | a |
| Waste Treatment Plant original | 2006 | 2017 | 6.33×10 ⁻² | 8.51×10 ⁻³ | 3.57×10 ⁻⁴ | 1.08×10 ⁻² | a | 8.51×10 ⁻³ | 8.51×10 ⁻³ |
| Cesium and Strontium Capsule Processing Facility | 2158 | 2161 | 2.01×10 ⁻² | 2.75×10 ⁻³ | 1.13×10 ⁻⁴ | 3.43×10 ⁻³ | a | 1.94×10 ⁻³ | 1.04×10 ⁻³ |
| Tank risers | 2013 | 2016 | a | a | a | a | a | a | a |
| Double-shell tank replacement 1 | 2029 | 2034 | a | a | a | a | a | a | a |
| Double-shell tank replacement 2 | 2069 | 2074 | a | a | a | a | a | a | a |
| Double-shell tank replacement 3 | 2109 | 2114 | a | a | a | a | a | a | a |
| Mobile retrieval system | 2013 | 2162 | a | a | a | a | a | a | a |
| Vacuum-based retrieval system | 2013 | 2162 | a | a | a | a | a | a | a |
| Chemical wash system | 2013 | 2162 | a | a | a | a | a | a | a |
| HLW Melter Interim Storage Facility 1 | 2017 | 2018 | a | a | a | a | a | a | a |
| HLW Melter Interim Storage Facility 2 | 2037 | 2038 | a | a | a | a | a | a | a |
| HLW Melter Interim Storage Facility 3 | 2057 | 2058 | a | a | a | a | a | a | a |
| HLW Melter Interim Storage Facility 4 | 2077 | 2078 | a | a | a | a | a | a | a |
| HLW Melter Interim Storage Facility 5 | 2097 | 2098 | a | a | a | a | a | a | a |
| HLW Melter Interim Storage Facility 6 | 2117 | 2118 | a | a | a | a | a | a | a |
| HLW Melter Interim Storage Facility 7 | 2137 | 2138 | a | a | a | a | a | a | a |
| Underground transfer line replacement | 2064 | 2064 | a | a | a | a | a | a | a |
| Waste Treatment Plant replacement 1 | 2067 | 2078 | 4.71×10 ⁻² | 6.34×10 ⁻³ | 2.66×10 ⁻⁴ | 8.02×10 ⁻³ | a | 6.34×10 ⁻³ | 6.34×10 ⁻³ |
| Waste Treatment Plant replacement 2 | 2127 | 2138 | 4.71×10 ⁻² | 6.34×10 ⁻³ | 2.66×10 ⁻⁴ | 8.02×10 ⁻³ | a | 6.34×10 ⁻³ | 6.34×10 ⁻³ |
| IHLW Shipping/Transfer Facility 1 | 2076 | 2078 | a | a | a | a | a | a | a |
| IHLW Shipping/Transfer Facility 2 | 2136 | 2138 | a | a | a | a | a | a | a |
| IHLW Shipping/Transfer Facility 3 | 2196 | 2198 | a | a | a | a | a | a | a |
| IHLW Interim Storage Modules, additional | 2078 | 2197 | a | a | a | a | a | a | a |
| HLW Debris Storage Facility | 2041 | 2110 | a | a | a | a | a | a | a |
| Effluent Treatment Facility replacement 1 | 2023 | 2025 | 2.14×10 ⁻² | 4.02×10 ⁻³ | 1.23×10 ⁻⁴ | 3.93×10 ⁻³ | a | 2.02×10 ⁻² | 6.22×10 ⁻³ |
| Effluent Treatment Facility replacement 2 | 2053 | 2055 | 2.13×10 ⁻² | 4.00×10 ⁻³ | 1.23×10 ⁻⁴ | 3.91×10 ⁻³ | a | 2.02×10 ⁻² | 6.19×10 ⁻³ |

G-176

Draft Tank Closure and Waste Management Environmental Impact Statement for the Hanford Site, Richland, Washington

Table G-80. Tank Closure Alternative 6A, Base Case, Toxic Pollutant Emissions from Mobile Sources (continued)

| Facility/System | Start Year | End Year | Emission Rate (metric tons per year) | | | | | | |
|--|------------|----------|--------------------------------------|-----------------------|-----------------------|-----------------------|---------|-----------------------|-----------------------|
| | | | Ammonia | Benzene | 1,3-Butadiene | Formaldehyde | Mercury | Toluene | Xylene |
| Construction (continued) | | | | | | | | | |
| Effluent Treatment Facility replacement 3 | 2083 | 2085 | 2.13×10 ⁻² | 4.00×10 ⁻³ | 1.23×10 ⁻⁴ | 3.91×10 ⁻³ | a | 2.02×10 ⁻² | 6.19×10 ⁻³ |
| Effluent Treatment Facility replacement 4 | 2113 | 2115 | 2.13×10 ⁻² | 4.00×10 ⁻³ | 1.23×10 ⁻⁴ | 3.91×10 ⁻³ | a | 2.02×10 ⁻² | 6.19×10 ⁻³ |
| Effluent Treatment Facility replacement 5 | 2143 | 2145 | 2.13×10 ⁻² | 4.00×10 ⁻³ | 1.23×10 ⁻⁴ | 3.91×10 ⁻³ | a | 2.02×10 ⁻² | 6.19×10 ⁻³ |
| Evaporator replacement 1 | 2015 | 2017 | 4.76×10 ⁻³ | 9.96×10 ⁻⁴ | 7.95×10 ⁻⁴ | 9.01×10 ⁻⁴ | a | 6.20×10 ⁻³ | 1.86×10 ⁻³ |
| Evaporator replacement 2 | 2040 | 2042 | 4.74×10 ⁻³ | 9.91×10 ⁻⁴ | 7.95×10 ⁻⁴ | 8.96×10 ⁻⁴ | a | 6.18×10 ⁻³ | 1.85×10 ⁻³ |
| Evaporator replacement 3 | 2065 | 2067 | 4.74×10 ⁻³ | 9.91×10 ⁻⁴ | 7.95×10 ⁻⁴ | 8.96×10 ⁻⁴ | a | 6.18×10 ⁻³ | 1.85×10 ⁻³ |
| Evaporator replacement 4 | 2090 | 2092 | 4.74×10 ⁻³ | 9.91×10 ⁻⁴ | 7.95×10 ⁻⁴ | 8.96×10 ⁻⁴ | a | 6.18×10 ⁻³ | 1.85×10 ⁻³ |
| Evaporator replacement 5 | 2115 | 2117 | 4.74×10 ⁻³ | 9.91×10 ⁻⁴ | 7.95×10 ⁻⁴ | 8.96×10 ⁻⁴ | a | 6.18×10 ⁻³ | 1.85×10 ⁻³ |
| Evaporator replacement 6 | 2140 | 2142 | 4.74×10 ⁻³ | 9.91×10 ⁻⁴ | 7.95×10 ⁻⁴ | 8.96×10 ⁻⁴ | a | 6.18×10 ⁻³ | 1.85×10 ⁻³ |
| Underground transfer line 1,000-foot sections | 2009 | 2009 | a | a | a | a | a | a | a |
| Operations | | | | | | | | | |
| IHLW Interim Storage Facility | 2018 | 2262 | a | a | a | a | a | a | a |
| Other infrastructure upgrades | 2006 | 2162 | a | a | a | a | a | a | a |
| Routine operations | 2006 | 2162 | 2.26×10 ⁻¹ | 3.42×10 ⁻² | a | a | a | 1.50×10 ⁻² | 1.04×10 ⁻² |
| Retrieval operations | 2006 | 2162 | a | a | a | a | a | a | a |
| Double-shell tank interim stabilization | 2006 | 2162 | a | a | a | a | a | a | a |
| Waste Treatment Plant | 2018 | 2162 | 2.17×10 ⁻¹ | 7.11×10 ⁻¹ | 1.23×10 ⁻³ | 3.70×10 ⁻² | a | 3.12×10 ⁻¹ | 2.17×10 ⁻¹ |
| Waste Treatment Plant, cesium and strontium capsules | 2163 | 2163 | 2.17×10 ⁻¹ | 7.11×10 ⁻¹ | 1.23×10 ⁻³ | 3.70×10 ⁻² | a | 3.12×10 ⁻¹ | 2.17×10 ⁻¹ |
| Cesium and Strontium Capsule Processing Facility | 2162 | 2163 | 1.76×10 ⁻² | 2.40×10 ⁻³ | 9.93×10 ⁻⁵ | 3.00×10 ⁻³ | a | 1.63×10 ⁻³ | 8.90×10 ⁻⁴ |
| Mobile retrieval system | 2013 | 2162 | a | a | a | a | a | a | a |
| Vacuum-based retrieval system | 2013 | 2162 | a | a | a | a | a | a | a |
| Chemical wash system | 2013 | 2162 | a | a | a | a | a | a | a |
| HLW Melter Interim Storage Facility | 2018 | 2262 | a | a | a | a | a | a | a |
| HLW Debris Storage Facility | 2042 | 2262 | a | a | a | a | a | a | a |
| Effluent Treatment Facility | 2006 | 2166 | 4.99×10 ⁻² | 8.32×10 ⁻² | 4.67×10 ⁻⁴ | 2.80×10 ⁻² | a | 1.28 | 3.61×10 ⁻¹ |
| Evaporator | 2018 | 2163 | 2.49×10 ⁻⁴ | 4.15×10 ⁻⁴ | 2.33×10 ⁻⁶ | 1.40×10 ⁻⁴ | a | 6.38×10 ⁻³ | 1.80×10 ⁻³ |
| Borrow Area C | 2006 | 2167 | a | a | a | a | a | a | a |
| Deactivation | | | | | | | | | |
| Mobile retrieval system | 2013 | 2162 | a | a | a | a | a | a | a |
| Vacuum-based retrieval system | 2013 | 2162 | a | a | a | a | a | a | a |
| Chemical wash system | 2013 | 2162 | a | a | a | a | a | a | a |
| IHLW Interim Storage Facility | 2078 | 2197 | a | a | a | a | a | a | a |

Table G-80. Tank Closure Alternative 6A, Base Case, Toxic Pollutant Emissions from Mobile Sources (continued)

| Facility/System | Start Year | End Year | Emission Rate (metric tons per year) | | | | | | |
|--|------------|----------|--------------------------------------|-----------------------|-----------------------|-----------------------|---------|-----------------------|-----------------------|
| | | | Ammonia | Benzene | 1,3-Butadiene | Formaldehyde | Mercury | Toluene | Xylene |
| Deactivation (continued) | | | | | | | | | |
| Waste Treatment Plant original | 2078 | 2080 | 5.05×10 ⁻³ | 1.65×10 ⁻² | 2.85×10 ⁻⁵ | 8.60×10 ⁻⁴ | a | 7.25×10 ⁻³ | 5.05×10 ⁻³ |
| Waste Treatment Plant replacement 1 | 2138 | 2140 | 5.05×10 ⁻³ | 1.65×10 ⁻² | 2.85×10 ⁻⁵ | 8.60×10 ⁻⁴ | a | 7.25×10 ⁻³ | 5.05×10 ⁻³ |
| Waste Treatment Plant replacement 2 | 2164 | 2166 | 5.05×10 ⁻³ | 1.65×10 ⁻² | 2.85×10 ⁻⁵ | 8.60×10 ⁻⁴ | a | 7.25×10 ⁻³ | 5.05×10 ⁻³ |
| Cesium and Strontium Capsule Processing Facility | 2164 | 2164 | 8.12×10 ⁻³ | 1.12×10 ⁻³ | 4.59×10 ⁻⁵ | 1.39×10 ⁻³ | a | 8.76×10 ⁻⁴ | 4.45×10 ⁻⁴ |
| Effluent Treatment Facility original | 2026 | 2026 | 2.50×10 ⁻² | 4.16×10 ⁻² | 2.34×10 ⁻⁴ | 1.40×10 ⁻² | a | 6.39×10 ⁻¹ | 1.80×10 ⁻¹ |
| Effluent Treatment Facility replacement 1 | 2056 | 2056 | 2.50×10 ⁻² | 4.16×10 ⁻² | 2.34×10 ⁻⁴ | 1.40×10 ⁻² | a | 6.39×10 ⁻¹ | 1.80×10 ⁻¹ |
| Effluent Treatment Facility replacement 2 | 2086 | 2086 | 2.50×10 ⁻² | 4.16×10 ⁻² | 2.34×10 ⁻⁴ | 1.40×10 ⁻² | a | 6.39×10 ⁻¹ | 1.80×10 ⁻¹ |
| Effluent Treatment Facility replacement 3 | 2116 | 2116 | 2.50×10 ⁻² | 4.16×10 ⁻² | 2.34×10 ⁻⁴ | 1.40×10 ⁻² | a | 6.39×10 ⁻¹ | 1.80×10 ⁻¹ |
| Effluent Treatment Facility replacement 4 | 2146 | 2146 | 2.50×10 ⁻² | 4.16×10 ⁻² | 2.34×10 ⁻⁴ | 1.40×10 ⁻² | a | 6.39×10 ⁻¹ | 1.80×10 ⁻¹ |
| Effluent Treatment Facility replacement 5 | 2167 | 2167 | 2.50×10 ⁻² | 4.16×10 ⁻² | 2.34×10 ⁻⁴ | 1.40×10 ⁻² | a | 6.39×10 ⁻¹ | 1.80×10 ⁻¹ |
| Evaporator original | 2018 | 2018 | 6.10×10 ⁻⁵ | 1.02×10 ⁻⁴ | 5.70×10 ⁻⁷ | 3.42×10 ⁻⁵ | a | 1.56×10 ⁻³ | 4.40×10 ⁻⁴ |
| Evaporator replacement 1 | 2043 | 2043 | 6.10×10 ⁻⁵ | 1.02×10 ⁻⁴ | 5.70×10 ⁻⁷ | 3.42×10 ⁻⁵ | a | 1.56×10 ⁻³ | 4.40×10 ⁻⁴ |
| Evaporator replacement 2 | 2068 | 2068 | 6.10×10 ⁻⁵ | 1.02×10 ⁻⁴ | 5.70×10 ⁻⁷ | 3.42×10 ⁻⁵ | a | 1.56×10 ⁻³ | 4.40×10 ⁻⁴ |
| Evaporator replacement 3 | 2093 | 2093 | 6.10×10 ⁻⁵ | 1.02×10 ⁻⁴ | 5.70×10 ⁻⁷ | 3.42×10 ⁻⁵ | a | 1.56×10 ⁻³ | 4.40×10 ⁻⁴ |
| Evaporator replacement 4 | 2118 | 2118 | 6.10×10 ⁻⁵ | 1.02×10 ⁻⁴ | 5.70×10 ⁻⁷ | 3.42×10 ⁻⁵ | a | 1.56×10 ⁻³ | 4.40×10 ⁻⁴ |
| Evaporator replacement 5 | 2143 | 2143 | 6.10×10 ⁻⁵ | 1.02×10 ⁻⁴ | 5.70×10 ⁻⁷ | 3.42×10 ⁻⁵ | a | 1.56×10 ⁻³ | 4.40×10 ⁻⁴ |
| Evaporator replacement 6 | 2168 | 2168 | 6.10×10 ⁻⁵ | 1.02×10 ⁻⁴ | 5.70×10 ⁻⁷ | 3.42×10 ⁻⁵ | a | 1.56×10 ⁻³ | 4.40×10 ⁻⁴ |
| Closure | | | | | | | | | |
| Containment structure construction 1 | 2038 | 2041 | a | a | a | a | a | a | a |
| Containment structure construction 2 | 2061 | 2064 | a | a | a | a | a | a | a |
| Containment structure construction 3 | 2084 | 2087 | a | a | a | a | a | a | a |
| Containment structure construction 4 | 2107 | 2110 | a | a | a | a | a | a | a |
| Containment structure construction 5 | 2122 | 2125 | a | a | a | a | a | a | a |
| Containment structure construction 6 | 2138 | 2141 | a | a | a | a | a | a | a |
| Containment structure deactivation 1 | 2062 | 2064 | a | a | a | a | a | a | a |
| Containment structure deactivation 2 | 2085 | 2087 | a | a | a | a | a | a | a |
| Containment structure deactivation 3 | 2108 | 2110 | a | a | a | a | a | a | a |
| Containment structure deactivation 4 | 2123 | 2125 | a | a | a | a | a | a | a |
| Containment structure deactivation 5 | 2146 | 2148 | a | a | a | a | a | a | a |
| Containment structure deactivation 6 | 2138 | 2140 | a | a | a | a | a | a | a |
| Containment structure deactivation 7 | 2162 | 2164 | a | a | a | a | a | a | a |

G-178

Draft Tank Closure and Waste Management Environmental Impact Statement for the Hanford Site, Richland, Washington

Table G-80. Tank Closure Alternative 6A, Base Case, Toxic Pollutant Emissions from Mobile Sources (continued)

| Facility/System | Start Year | End Year | Emission Rate (metric tons per year) | | | | | | | |
|---|------------|----------|--------------------------------------|-----------------------|-----------------------|-----------------------|---------|-----------------------|-----------------------|---|
| | | | Ammonia | Benzene | 1,3-Butadiene | Formaldehyde | Mercury | Toluene | Xylene | |
| Closure (continued) | | | | | | | | | | |
| Decontamination and decommissioning of 10 selected facilities | 2018 | 2028 | a | a | a | a | a | a | a | a |
| Modified Resource Conservation and Recovery Act Subtitle C barrier construction | 2149 | 2150 | 1.30×10 ⁻¹ | 3.25×10 ⁻¹ | 1.36×10 ⁻² | 4.12×10 ⁻¹ | a | 1.43×10 ⁻¹ | 9.94×10 ⁻² | |
| Postclosure care | 2151 | 2250 | a | a | a | a | a | a | a | a |
| B tank farm removal | 2065 | 2076 | a | a | a | a | a | a | a | a |
| T tank farm removal | 2126 | 2137 | a | a | a | a | a | a | a | a |
| BY tank farm removal | 2111 | 2122 | a | a | a | a | a | a | a | a |
| BX tank farm removal | 2042 | 2053 | a | a | a | a | a | a | a | a |
| C tank farm removal | 2088 | 2099 | a | a | a | a | a | a | a | a |
| A tank farm removal | 2142 | 2153 | a | a | a | a | a | a | a | a |
| AX tank farm removal | 2142 | 2153 | a | a | a | a | a | a | a | a |
| S tank farm removal | 2126 | 2137 | a | a | a | a | a | a | a | a |
| TY tank farm removal | 2111 | 2122 | a | a | a | a | a | a | a | a |
| TX tank farm removal | 2088 | 2099 | a | a | a | a | a | a | a | a |
| U tank farm removal | 2065 | 2076 | a | a | a | a | a | a | a | a |
| SX tank farm removal | 2042 | 2053 | a | a | a | a | a | a | a | a |
| B tank farm deep soil removal | 2077 | 2084 | a | a | a | a | a | a | a | a |
| T tank farm deep soil removal | 2138 | 2145 | a | a | a | a | a | a | a | a |
| BX tank farm deep soil removal | 2054 | 2061 | a | a | a | a | a | a | a | a |
| C tank farm deep soil removal | 2100 | 2107 | a | a | a | a | a | a | a | a |
| A tank farm deep soil removal | 2154 | 2161 | a | a | a | a | a | a | a | a |
| AX tank farm deep soil removal | 2154 | 2161 | a | a | a | a | a | a | a | a |
| TX tank farm deep soil removal | 2100 | 2107 | a | a | a | a | a | a | a | a |
| U tank farm deep soil removal | 2077 | 2084 | a | a | a | a | a | a | a | a |
| SX tank farm deep soil removal | 2054 | 2061 | a | a | a | a | a | a | a | a |
| Preprocessing Facility construction | 2039 | 2041 | 2.24×10 ⁻¹ | 1.17×10 ⁻¹ | 4.90×10 ⁻³ | 1.48×10 ⁻¹ | a | 5.12×10 ⁻² | 3.57×10 ⁻² | |
| Preprocessing Facility operations | 2042 | 2162 | 1.38×10 ⁻⁴ | 1.34×10 ⁻⁵ | 5.63×10 ⁻⁷ | 1.70×10 ⁻⁵ | a | 5.89×10 ⁻⁶ | 4.11×10 ⁻⁶ | |
| Preprocessing Facility deactivation | 2163 | 2163 | 2.16×10 ⁻⁵ | 2.11×10 ⁻⁶ | 8.85×10 ⁻⁸ | 2.67×10 ⁻⁶ | a | 9.26×10 ⁻⁷ | 6.45×10 ⁻⁷ | |

^a Emissions for this activity and pollutant were not calculated because annual fuel use for this activity and the resulting emissions would be small compared with other activities or would be zero.

Key: HLW=high-level radioactive waste; IHLW=immobilized high-level radioactive waste.

Source: SAIC 2007a, 2008.

Table G-81. Tank Closure Alternative 6A, Option Case, Criteria Pollutant Emissions from Mobile Sources

| Facility/System | Start Year | End Year | Emission Rate (metric tons per year) | | | |
|--|------------|----------|--------------------------------------|----------------------|----------------------|-----------------------|
| | | | Carbon Monoxide | Nitrogen Dioxide | PM ₁₀ | Sulfur Dioxide |
| Construction | | | | | | |
| Canister Storage Building | 2006 | 2016 | a | a | a | a |
| IHLW Shipping/Transfer Facility | 2011 | 2013 | a | a | a | a |
| IHLW Interim Storage Modules | 2014 | 2157 | a | a | a | a |
| Other infrastructure upgrades | 2006 | 2034 | a | a | a | a |
| Tank upgrades | 2006 | 2025 | a | a | a | a |
| Waste Treatment Plant original | 2006 | 2017 | 8.67 | 4.02×10 ¹ | 1.08×10 ² | 1.37×10 ⁻² |
| Cesium and Strontium Capsule Processing Facility | 2158 | 2161 | 3.13 | 1.28×10 ¹ | 4.24×10 ² | 4.85×10 ⁻³ |
| Tank risers | 2013 | 2016 | a | a | a | a |
| Double-shell tank replacement 1 | 2029 | 2034 | a | a | a | a |
| Double-shell tank replacement 2 | 2069 | 2074 | a | a | a | a |
| Double-shell tank replacement 3 | 2109 | 2114 | a | a | a | a |
| Mobile retrieval system | 2013 | 2162 | a | a | a | a |
| Vacuum-based retrieval system | 2013 | 2162 | a | a | a | a |
| Chemical wash system | 2013 | 2162 | a | a | a | a |
| HLW Melter Interim Storage Facility 1 | 2017 | 2018 | a | a | a | a |
| HLW Melter Interim Storage Facility 2 | 2037 | 2038 | a | a | a | a |
| HLW Melter Interim Storage Facility 3 | 2057 | 2058 | a | a | a | a |
| HLW Melter Interim Storage Facility 4 | 2077 | 2078 | a | a | a | a |
| HLW Melter Interim Storage Facility 5 | 2097 | 2098 | a | a | a | a |
| HLW Melter Interim Storage Facility 6 | 2117 | 2118 | a | a | a | a |
| HLW Melter Interim Storage Facility 7 | 2137 | 2138 | a | a | a | a |
| Underground transfer line replacement | 2064 | 2064 | a | a | a | a |
| Waste Treatment Plant replacement 1 | 2067 | 2078 | 6.46 | 3.00×10 ¹ | 8.32×10 ¹ | 1.02×10 ⁻² |
| Waste Treatment Plant replacement 2 | 2127 | 2138 | 6.46 | 3.00×10 ¹ | 8.32×10 ¹ | 1.02×10 ⁻² |
| IHLW Shipping/Transfer Facility 1 | 2076 | 2078 | a | a | a | a |
| IHLW Shipping/Transfer Facility 2 | 2136 | 2138 | a | a | a | a |
| IHLW Shipping/Transfer Facility 3 | 2196 | 2198 | a | a | a | a |
| IHLW Interim Storage Modules, additional | 2078 | 2197 | a | a | a | a |
| HLW Debris Storage Facility | 2041 | 2110 | a | a | a | a |
| Effluent Treatment Facility replacement 1 | 2023 | 2025 | 1.25×10 ¹ | 1.34×10 ¹ | 4.75×10 ² | 1.74×10 ⁻² |
| Effluent Treatment Facility replacement 2 | 2053 | 2055 | 1.24×10 ¹ | 1.33×10 ¹ | 6.77×10 ² | 1.73×10 ⁻² |
| Effluent Treatment Facility replacement 3 | 2083 | 2085 | 1.24×10 ¹ | 1.33×10 ¹ | 6.77×10 ² | 1.73×10 ⁻² |
| Effluent Treatment Facility replacement 4 | 2113 | 2115 | 1.24×10 ¹ | 1.33×10 ¹ | 6.77×10 ² | 1.73×10 ⁻² |

Table G-81. Tank Closure Alternative 6A, Option Case, Criteria Pollutant Emissions from Mobile Sources (continued)

| Facility/System | Start Year | End Year | Emission Rate (metric tons per year) | | | |
|--|------------|----------|--------------------------------------|-----------------------|-----------------------|-----------------------|
| | | | Carbon Monoxide | Nitrogen Dioxide | PM ₁₀ | Sulfur Dioxide |
| Construction (continued) | | | | | | |
| Effluent Treatment Facility replacement 5 | 2143 | 2145 | 1.24×10 ¹ | 1.33×10 ¹ | 6.77×10 ² | 1.73×10 ⁻² |
| Evaporator replacement 1 | 2015 | 2017 | 3.62 | 2.96 | 1.41×10 ² | 5.00×10 ⁻³ |
| Evaporator replacement 2 | 2040 | 2042 | 3.61 | 2.94 | 6.98×10 ² | 4.98×10 ⁻³ |
| Evaporator replacement 3 | 2065 | 2067 | 3.61 | 2.94 | 6.98×10 ² | 4.98×10 ⁻³ |
| Evaporator replacement 4 | 2090 | 2092 | 3.61 | 2.94 | 6.98×10 ² | 4.98×10 ⁻³ |
| Evaporator replacement 5 | 2115 | 2117 | 3.61 | 2.94 | 6.98×10 ² | 4.98×10 ⁻³ |
| Evaporator replacement 6 | 2140 | 2142 | 3.61 | 2.94 | 6.98×10 ² | 4.98×10 ⁻³ |
| Underground transfer line 1,000-foot sections | 2009 | 2009 | a | a | a | a |
| Operations | | | | | | |
| IHLW Interim Storage Facility | 2018 | 2262 | a | a | a | a |
| Other infrastructure upgrades | 2006 | 2162 | a | a | a | a |
| Routine operations | 2006 | 2162 | 3.10×10 ¹ | 1.44×10 ² | 1.32×10 ¹ | 4.73×10 ⁻² |
| Retrieval operations | 2006 | 2162 | a | a | a | a |
| Double-shell tank interim stabilization | 2006 | 2162 | a | a | a | a |
| Waste Treatment Plant | 2018 | 2162 | 2.98×10 ¹ | 1.38×10 ² | 5.83×10 ² | 4.70×10 ⁻² |
| Waste Treatment Plant, cesium and strontium capsules | 2163 | 2163 | 2.98×10 ¹ | 1.38×10 ² | 5.83×10 ² | 4.70×10 ⁻² |
| Cesium and Strontium Capsule Processing Facility | 2162 | 2163 | 2.71 | 1.12×10 ¹ | 8.61×10 ⁻¹ | 4.20×10 ⁻³ |
| Mobile retrieval system | 2013 | 2162 | a | a | a | a |
| Vacuum-based retrieval system | 2013 | 2162 | a | a | a | a |
| Chemical wash system | 2013 | 2162 | a | a | a | a |
| HLW Melter Interim Storage Facility | 2018 | 2262 | a | a | a | a |
| HLW Debris Storage Facility | 2042 | 2262 | a | a | a | a |
| Effluent Treatment Facility | 2006 | 2166 | 6.46×10 ² | 1.68×10 ¹ | 1.26×10 ⁴ | 8.66×10 ⁻¹ |
| Evaporator | 2018 | 2163 | 3.22 | 8.38×10 ⁻² | 5.14×10 ⁻³ | 4.32×10 ⁻³ |
| Borrow Area C | 2006 | 2167 | a | a | 4.24×10 ² | a |
| Deactivation | | | | | | |
| Mobile retrieval system | 2013 | 2162 | a | a | a | a |
| Vacuum-based retrieval system | 2013 | 2162 | a | a | a | a |
| Chemical wash system | 2013 | 2162 | a | a | a | a |
| IHLW Interim Storage Facility | 2078 | 2197 | a | a | a | a |
| Waste Treatment Plant original | 2079 | 2081 | 6.92×10 ⁻¹ | 3.21 | 1.36×10 ¹ | 1.09×10 ⁻³ |
| Waste Treatment Plant replacement 1 | 2139 | 2141 | 6.92×10 ⁻¹ | 3.21 | 1.36×10 ¹ | 1.09×10 ⁻³ |
| Waste Treatment Plant replacement 2 | 2164 | 2166 | 6.92×10 ⁻¹ | 3.21 | 1.36×10 ¹ | 1.09×10 ⁻³ |

Table G-81. Tank Closure Alternative 6A, Option Case, Criteria Pollutant Emissions from Mobile Sources (continued)

| Facility/System | Start Year | End Year | Emission Rate (metric tons per year) | | | |
|---|------------|----------|--------------------------------------|-----------------------|-----------------------|-----------------------|
| | | | Carbon Monoxide | Nitrogen Dioxide | PM ₁₀ | Sulfur Dioxide |
| Deactivation (continued) | | | | | | |
| Cesium and Strontium Capsule Processing Facility | 2164 | 2164 | 1.31 | 5.16 | 3.78×10 ⁻¹ | 2.02×10 ⁻³ |
| Effluent Treatment Facility original | 2026 | 2026 | 3.23×10 ² | 8.40 | 8.66 | 4.33×10 ⁻¹ |
| Effluent Treatment Facility replacement 1 | 2056 | 2056 | 3.23×10 ² | 8.40 | 8.66 | 4.33×10 ⁻¹ |
| Effluent Treatment Facility replacement 2 | 2086 | 2086 | 3.23×10 ² | 8.40 | 8.66 | 4.33×10 ⁻¹ |
| Effluent Treatment Facility replacement 3 | 2116 | 2116 | 3.23×10 ² | 8.40 | 8.66 | 4.33×10 ⁻¹ |
| Effluent Treatment Facility replacement 4 | 2146 | 2146 | 3.23×10 ² | 8.40 | 8.66 | 4.33×10 ⁻¹ |
| Effluent Treatment Facility replacement 5 | 2167 | 2167 | 3.23×10 ² | 8.40 | 8.66 | 4.33×10 ⁻¹ |
| Evaporator original | 2018 | 2018 | 7.89×10 ⁻¹ | 2.05×10 ⁻² | 1.92×10 ¹ | 1.06×10 ⁻³ |
| Evaporator replacement 1 | 2043 | 2043 | 7.89×10 ⁻¹ | 2.05×10 ⁻² | 1.92×10 ¹ | 1.06×10 ⁻³ |
| Evaporator replacement 2 | 2068 | 2068 | 7.89×10 ⁻¹ | 2.05×10 ⁻² | 1.92×10 ¹ | 1.06×10 ⁻³ |
| Evaporator replacement 3 | 2093 | 2093 | 7.89×10 ⁻¹ | 2.05×10 ⁻² | 1.92×10 ¹ | 1.06×10 ⁻³ |
| Evaporator replacement 4 | 2118 | 2118 | 7.89×10 ⁻¹ | 2.05×10 ⁻² | 1.92×10 ¹ | 1.06×10 ⁻³ |
| Evaporator replacement 5 | 2143 | 2143 | 7.89×10 ⁻¹ | 2.05×10 ⁻² | 1.92×10 ¹ | 1.06×10 ⁻³ |
| Evaporator replacement 6 | 2168 | 2168 | 7.89×10 ⁻¹ | 2.05×10 ⁻² | 1.92×10 ¹ | 1.06×10 ⁻³ |
| Closure | | | | | | |
| Containment structure construction 1 | 2038 | 2041 | a | a | a | a |
| Containment structure construction 2 | 2061 | 2064 | a | a | a | a |
| Containment structure construction 3 | 2084 | 2087 | a | a | a | a |
| Containment structure construction 4 | 2107 | 2110 | a | a | a | a |
| Containment structure construction 5 | 2122 | 2125 | a | a | a | a |
| Containment structure construction 6 | 2138 | 2141 | a | a | a | a |
| Containment structure deactivation 1 | 2062 | 2064 | a | a | a | a |
| Containment structure deactivation 2 | 2085 | 2087 | a | a | a | a |
| Containment structure deactivation 3 | 2108 | 2110 | a | a | a | a |
| Containment structure deactivation 4 | 2123 | 2125 | a | a | a | a |
| Containment structure deactivation 5 | 2146 | 2148 | a | a | a | a |
| Containment structure deactivation 6 | 2138 | 2140 | a | a | a | a |
| Containment structure deactivation 7 | 2162 | 2164 | a | a | a | a |
| Decontamination and decommissioning of 10 selected facilities | 2018 | 2028 | a | a | a | a |
| B tank farm removal | 2065 | 2076 | a | a | a | a |
| T tank farm removal | 2126 | 2137 | a | a | a | a |

Table G-81. Tank Closure Alternative 6A, Option Case, Criteria Pollutant Emissions from Mobile Sources (*continued*)

| Facility/System | Start Year | End Year | Emission Rate (metric tons per year) | | | |
|--|------------|----------|--------------------------------------|-----------------------|----------------------|-----------------------|
| | | | Carbon Monoxide | Nitrogen Dioxide | PM ₁₀ | Sulfur Dioxide |
| Closure (<i>continued</i>) | | | | | | |
| BY tank farm removal | 2111 | 2122 | a | a | a | a |
| BX tank farm removal | 2042 | 2053 | a | a | a | a |
| C tank farm removal | 2088 | 2099 | a | a | a | a |
| A tank farm removal | 2142 | 2153 | a | a | a | a |
| AX tank farm removal | 2142 | 2153 | a | a | a | a |
| S tank farm removal | 2126 | 2137 | a | a | a | a |
| TY tank farm removal | 2111 | 2122 | a | a | a | a |
| TX tank farm removal | 2088 | 2099 | a | a | a | a |
| U tank farm removal | 2065 | 2076 | a | a | a | a |
| SX tank farm removal | 2042 | 2053 | a | a | a | a |
| B tank farm deep soil removal | 2077 | 2084 | a | a | a | a |
| T tank farm deep soil removal | 2138 | 2145 | a | a | a | a |
| BX tank farm deep soil removal | 2054 | 2061 | a | a | a | a |
| C tank farm deep soil removal | 2100 | 2107 | a | a | a | a |
| A tank farm deep soil removal | 2154 | 2161 | a | a | a | a |
| AX tank farm deep soil removal | 2154 | 2161 | a | a | a | a |
| TX tank farm deep soil removal | 2100 | 2107 | a | a | a | a |
| U tank farm deep soil removal | 2077 | 2084 | a | a | a | a |
| SX tank farm deep soil removal | 2054 | 2061 | a | a | a | a |
| B Area cribs and trenches (ditches) removal | 2054 | 2084 | a | a | a | a |
| T Area cribs and trenches (ditches) removal | 2100 | 2145 | a | a | a | a |
| B & T Area cribs and trenches (ditches) construction 1 | 2050 | 2053 | a | a | a | a |
| B & T Area cribs and trenches (ditches) construction 2 | 2096 | 2099 | a | a | a | a |
| B & T Area cribs and trenches (ditches) deactivation 1 | 2085 | 2087 | a | a | a | a |
| B & T Area cribs and trenches (ditches) deactivation 2 | 2146 | 2148 | a | a | a | a |
| Preprocessing Facility construction | 2039 | 2041 | 2.68×10 ³ | 1.25×10 ⁴ | 5.88×10 ⁴ | 4.24 |
| Preprocessing Facility operations | 2042 | 2162 | 3.48×10 ⁻¹ | 1.62 | 7.55 | 5.50×10 ⁻⁴ |
| Preprocessing Facility deactivation | 2163 | 2163 | 5.47×10 ⁻² | 2.54×10 ⁻¹ | 1.19 | 8.64×10 ⁻⁵ |

^a Emissions for this activity and pollutant were not calculated because annual fuel use for this activity and the resulting emissions would be small compared with other activities or would be zero.

Key: HLW=high-level radioactive waste; IHLW=immobilized high-level radioactive waste; PM₁₀=particulate matter with an aerodynamic diameter less than or equal to 10 micrometers.

Source: SAIC 2007a, 2008.

Table G-82. Tank Closure Alternative 6A, Option Case, Toxic Pollutant Emissions from Mobile Sources

| Facility/System | Start Year | End Year | Emission Rate (metric tons per year) | | | | | | |
|--|------------|----------|--------------------------------------|-----------------------|-----------------------|-----------------------|---------|-----------------------|-----------------------|
| | | | Ammonia | Benzene | 1,3-Butadiene | Formaldehyde | Mercury | Toulene | Xylene |
| Construction | | | | | | | | | |
| Canister Storage Building | 2006 | 2016 | a | a | a | a | a | a | a |
| IHLW Shipping/Transfer Facility | 2011 | 2013 | a | a | a | a | a | a | a |
| IHLW Interim Storage Modules | 2014 | 2157 | a | a | a | a | a | a | a |
| Other infrastructure upgrades | 2006 | 2034 | a | a | a | a | a | a | a |
| Tank upgrades | 2006 | 2025 | a | a | a | a | a | a | a |
| Waste Treatment Plant original | 2006 | 2017 | 6.33×10 ⁻² | 8.51×10 ⁻³ | 3.57×10 ⁻⁴ | 1.08×10 ⁻² | a | 8.51×10 ⁻³ | 8.51×10 ⁻³ |
| Cesium and Strontium Capsule Processing Facility | 2158 | 2161 | 2.01×10 ⁻² | 2.75×10 ⁻³ | 1.13×10 ⁻⁴ | 3.43×10 ⁻³ | a | 1.94×10 ⁻³ | 1.04×10 ⁻³ |
| Tank risers | 2013 | 2016 | a | a | a | a | a | a | a |
| Double-shell tank replacement 1 | 2029 | 2034 | a | a | a | a | a | a | a |
| Double-shell tank replacement 2 | 2069 | 2074 | a | a | a | a | a | a | a |
| Double-shell tank replacement 3 | 2109 | 2114 | a | a | a | a | a | a | a |
| Mobile retrieval system | 2013 | 2162 | a | a | a | a | a | a | a |
| Vacuum-based retrieval system | 2013 | 2162 | a | a | a | a | a | a | a |
| Chemical wash system | 2013 | 2162 | a | a | a | a | a | a | a |
| HLW Melter Interim Storage Facility 1 | 2017 | 2018 | a | a | a | a | a | a | a |
| HLW Melter Interim Storage Facility 2 | 2037 | 2038 | a | a | a | a | a | a | a |
| HLW Melter Interim Storage Facility 3 | 2057 | 2058 | a | a | a | a | a | a | a |
| HLW Melter Interim Storage Facility 4 | 2077 | 2078 | a | a | a | a | a | a | a |
| HLW Melter Interim Storage Facility 5 | 2097 | 2098 | a | a | a | a | a | a | a |
| HLW Melter Interim Storage Facility 6 | 2117 | 2118 | a | a | a | a | a | a | a |
| HLW Melter Interim Storage Facility 7 | 2137 | 2138 | a | a | a | a | a | a | a |
| Underground transfer line replacement | 2064 | 2064 | a | a | a | a | a | a | a |
| Waste Treatment Plant replacement 1 | 2067 | 2078 | 4.71×10 ⁻² | 6.34×10 ⁻³ | 2.66×10 ⁻⁴ | 8.02×10 ⁻³ | a | 6.34×10 ⁻³ | 6.34×10 ⁻³ |
| Waste Treatment Plant replacement 2 | 2127 | 2138 | 4.71×10 ⁻² | 6.34×10 ⁻³ | 2.66×10 ⁻⁴ | 8.02×10 ⁻³ | a | 6.34×10 ⁻³ | 6.34×10 ⁻³ |
| IHLW Shipping/Transfer Facility 1 | 2076 | 2078 | a | a | a | a | a | a | a |
| IHLW Shipping/Transfer Facility 2 | 2136 | 2138 | a | a | a | a | a | a | a |
| IHLW Shipping/Transfer Facility 3 | 2196 | 2198 | a | a | a | a | a | a | a |
| IHLW Interim Storage Modules, additional | 2078 | 2197 | a | a | a | a | a | a | a |
| HLW Debris Storage Facility | 2041 | 2110 | a | a | a | a | a | a | a |
| Effluent Treatment Facility replacement 1 | 2023 | 2025 | 2.14×10 ⁻² | 4.02×10 ⁻³ | 1.23×10 ⁻⁴ | 3.93×10 ⁻³ | a | 2.02×10 ⁻² | 6.22×10 ⁻³ |
| Effluent Treatment Facility replacement 2 | 2053 | 2055 | 2.13×10 ⁻² | 4.00×10 ⁻³ | 1.23×10 ⁻⁴ | 3.91×10 ⁻³ | a | 2.02×10 ⁻² | 6.19×10 ⁻³ |

G-184

Draft Tank Closure and Waste Management Environmental Impact Statement for the Hanford Site, Richland, Washington

Table G-82. Tank Closure Alternative 6A, Option Case, Toxic Pollutant Emissions from Mobile Sources (continued)

| Facility/System | Start Year | End Year | Emission Rate (metric tons per year) | | | | | | |
|--|------------|----------|--------------------------------------|-----------------------|-----------------------|-----------------------|---------|-----------------------|-----------------------|
| | | | Ammonia | Benzene | 1,3-Butadiene | Formaldehyde | Mercury | Toulene | Xylene |
| Construction (continued) | | | | | | | | | |
| Effluent Treatment Facility replacement 3 | 2083 | 2085 | 2.13×10 ⁻² | 4.00×10 ⁻³ | 1.23×10 ⁻⁴ | 3.91×10 ⁻³ | a | 2.02×10 ⁻² | 6.19×10 ⁻³ |
| Effluent Treatment Facility replacement 4 | 2113 | 2115 | 2.13×10 ⁻² | 4.00×10 ⁻³ | 1.23×10 ⁻⁴ | 3.91×10 ⁻³ | a | 2.02×10 ⁻² | 6.19×10 ⁻³ |
| Effluent Treatment Facility replacement 5 | 2143 | 2145 | 2.13×10 ⁻² | 4.00×10 ⁻³ | 1.23×10 ⁻⁴ | 3.91×10 ⁻³ | a | 2.02×10 ⁻² | 6.19×10 ⁻³ |
| Evaporator replacement 1 | 2015 | 2017 | 4.76×10 ⁻³ | 9.96×10 ⁻⁴ | 7.95×10 ⁻⁴ | 9.01×10 ⁻⁴ | a | 6.20×10 ⁻³ | 1.86×10 ⁻³ |
| Evaporator replacement 2 | 2040 | 2042 | 4.74×10 ⁻³ | 9.91×10 ⁻⁴ | 7.95×10 ⁻⁴ | 8.96×10 ⁻⁴ | a | 6.18×10 ⁻³ | 1.85×10 ⁻³ |
| Evaporator replacement 3 | 2065 | 2067 | 4.74×10 ⁻³ | 9.91×10 ⁻⁴ | 7.95×10 ⁻⁴ | 8.96×10 ⁻⁴ | a | 6.18×10 ⁻³ | 1.85×10 ⁻³ |
| Evaporator replacement 4 | 2090 | 2092 | 4.74×10 ⁻³ | 9.91×10 ⁻⁴ | 7.95×10 ⁻⁴ | 8.96×10 ⁻⁴ | a | 6.18×10 ⁻³ | 1.85×10 ⁻³ |
| Evaporator replacement 5 | 2115 | 2117 | 4.74×10 ⁻³ | 9.91×10 ⁻⁴ | 7.95×10 ⁻⁴ | 8.96×10 ⁻⁴ | a | 6.18×10 ⁻³ | 1.85×10 ⁻³ |
| Evaporator replacement 6 | 2140 | 2142 | 4.74×10 ⁻³ | 9.91×10 ⁻⁴ | 7.95×10 ⁻⁴ | 8.96×10 ⁻⁴ | a | 6.18×10 ⁻³ | 1.85×10 ⁻³ |
| Underground transfer line 1,000-foot sections | 2009 | 2009 | a | a | a | a | a | a | a |
| Operations | | | | | | | | | |
| IHLW Interim Storage Facility | 2018 | 2262 | a | a | a | a | a | a | a |
| Other infrastructure upgrades | 2006 | 2162 | a | a | a | a | a | a | a |
| Routine operations | 2006 | 2162 | 2.26×10 ⁻¹ | 3.42×10 ⁻² | a | a | a | 1.50×10 ⁻² | 1.04×10 ⁻² |
| Retrieval operations | 2006 | 2162 | a | a | a | a | a | a | a |
| Double-shell tank interim stabilization | 2006 | 2162 | a | a | a | a | a | a | a |
| Waste Treatment Plant | 2018 | 2162 | 2.17×10 ⁻¹ | 7.11×10 ⁻¹ | 1.23×10 ⁻³ | 3.70×10 ⁻² | a | 3.12×10 ⁻¹ | 2.17×10 ⁻¹ |
| Waste Treatment Plant, cesium and strontium capsules | 2163 | 2163 | 2.17×10 ⁻¹ | 7.11×10 ⁻¹ | 1.23×10 ⁻³ | 3.70×10 ⁻² | a | 3.12×10 ⁻¹ | 2.17×10 ⁻¹ |
| Cesium and Strontium Capsule Processing Facility | 2162 | 2163 | 1.76×10 ⁻² | 2.40×10 ⁻³ | 9.93×10 ⁻⁵ | 3.00×10 ⁻³ | a | 1.63×10 ⁻³ | 8.90×10 ⁻⁴ |
| Mobile retrieval system | 2013 | 2162 | a | a | a | a | a | a | a |
| Vacuum-based retrieval system | 2013 | 2162 | a | a | a | a | a | a | a |
| Chemical wash system | 2013 | 2162 | a | a | a | a | a | a | a |
| HLW Melter Interim Storage Facility | 2018 | 2262 | a | a | a | a | a | a | a |
| HLW Debris Storage Facility | 2042 | 2262 | a | a | a | a | a | a | a |
| Effluent Treatment Facility | 2006 | 2166 | 4.99×10 ⁻² | 8.32×10 ⁻² | 4.67×10 ⁻⁴ | 2.80×10 ⁻² | a | 1.28 | 3.61×10 ⁻¹ |
| Evaporator | 2018 | 2163 | 2.49×10 ⁻⁴ | 4.15×10 ⁻⁴ | 2.33×10 ⁻⁶ | 1.40×10 ⁻⁴ | a | 6.38×10 ⁻³ | 1.80×10 ⁻³ |
| Borrow Area C | 2006 | 2167 | a | a | a | a | a | a | a |
| Deactivation | | | | | | | | | |
| Mobile retrieval system | 2013 | 2162 | a | a | a | a | a | a | a |
| Vacuum-based retrieval system | 2013 | 2162 | a | a | a | a | a | a | a |
| Chemical wash system | 2013 | 2162 | a | a | a | a | a | a | a |
| IHLW Interim Storage Facility | 2078 | 2197 | a | a | a | a | a | a | a |

Table G–82. Tank Closure Alternative 6A, Option Case, Toxic Pollutant Emissions from Mobile Sources (continued)

| Facility/System | Start Year | End Year | Emission Rate (metric tons per year) | | | | | | |
|---|------------|----------|--------------------------------------|-----------------------|-----------------------|-----------------------|---------|-----------------------|-----------------------|
| | | | Ammonia | Benzene | 1,3-Butadiene | Formaldehyde | Mercury | Toulene | Xylene |
| Deactivation (continued) | | | | | | | | | |
| Waste Treatment Plant original | 2079 | 2081 | 5.05×10 ⁻³ | 1.65×10 ⁻² | 2.85×10 ⁻⁵ | 8.60×10 ⁻⁴ | a | 7.25×10 ⁻³ | 5.05×10 ⁻³ |
| Waste Treatment Plant replacement 1 | 2139 | 2141 | 5.05×10 ⁻³ | 1.65×10 ⁻² | 2.85×10 ⁻⁵ | 8.60×10 ⁻⁴ | a | 7.25×10 ⁻³ | 5.05×10 ⁻³ |
| Waste Treatment Plant replacement 2 | 2164 | 2166 | 5.05×10 ⁻³ | 1.65×10 ⁻² | 2.85×10 ⁻⁵ | 8.60×10 ⁻⁴ | a | 7.25×10 ⁻³ | 5.05×10 ⁻³ |
| Cesium and Strontium Capsule Processing Facility | 2164 | 2164 | 8.12×10 ⁻³ | 1.12×10 ⁻³ | 4.59×10 ⁻⁵ | 1.39×10 ⁻³ | a | 8.76×10 ⁻⁴ | 4.45×10 ⁻⁴ |
| Effluent Treatment Facility original | 2026 | 2026 | 2.50×10 ⁻² | 4.16×10 ⁻² | 2.34×10 ⁻⁴ | 1.40×10 ⁻² | a | 6.39×10 ⁻¹ | 1.80×10 ⁻¹ |
| Effluent Treatment Facility replacement 1 | 2056 | 2056 | 2.50×10 ⁻² | 4.16×10 ⁻² | 2.34×10 ⁻⁴ | 1.40×10 ⁻² | a | 6.39×10 ⁻¹ | 1.80×10 ⁻¹ |
| Effluent Treatment Facility replacement 2 | 2086 | 2086 | 2.50×10 ⁻² | 4.16×10 ⁻² | 2.34×10 ⁻⁴ | 1.40×10 ⁻² | a | 6.39×10 ⁻¹ | 1.80×10 ⁻¹ |
| Effluent Treatment Facility replacement 3 | 2116 | 2116 | 2.50×10 ⁻² | 4.16×10 ⁻² | 2.34×10 ⁻⁴ | 1.40×10 ⁻² | a | 6.39×10 ⁻¹ | 1.80×10 ⁻¹ |
| Effluent Treatment Facility replacement 4 | 2146 | 2146 | 2.50×10 ⁻² | 4.16×10 ⁻² | 2.34×10 ⁻⁴ | 1.40×10 ⁻² | a | 6.39×10 ⁻¹ | 1.80×10 ⁻¹ |
| Effluent Treatment Facility replacement 5 | 2167 | 2167 | 2.50×10 ⁻² | 4.16×10 ⁻² | 2.34×10 ⁻⁴ | 1.40×10 ⁻² | a | 6.39×10 ⁻¹ | 1.80×10 ⁻¹ |
| Evaporator original | 2018 | 2018 | 6.10×10 ⁻⁵ | 1.02×10 ⁻⁴ | 5.70×10 ⁻⁷ | 3.42×10 ⁻⁵ | a | 1.56×10 ⁻³ | 4.40×10 ⁻⁴ |
| Evaporator replacement 1 | 2043 | 2043 | 6.10×10 ⁻⁵ | 1.02×10 ⁻⁴ | 5.70×10 ⁻⁷ | 3.42×10 ⁻⁵ | a | 1.56×10 ⁻³ | 4.40×10 ⁻⁴ |
| Evaporator replacement 2 | 2068 | 2068 | 6.10×10 ⁻⁵ | 1.02×10 ⁻⁴ | 5.70×10 ⁻⁷ | 3.42×10 ⁻⁵ | a | 1.56×10 ⁻³ | 4.40×10 ⁻⁴ |
| Evaporator replacement 3 | 2093 | 2093 | 6.10×10 ⁻⁵ | 1.02×10 ⁻⁴ | 5.70×10 ⁻⁷ | 3.42×10 ⁻⁵ | a | 1.56×10 ⁻³ | 4.40×10 ⁻⁴ |
| Evaporator replacement 4 | 2118 | 2118 | 6.10×10 ⁻⁵ | 1.02×10 ⁻⁴ | 5.70×10 ⁻⁷ | 3.42×10 ⁻⁵ | a | 1.56×10 ⁻³ | 4.40×10 ⁻⁴ |
| Evaporator replacement 5 | 2143 | 2143 | 6.10×10 ⁻⁵ | 1.02×10 ⁻⁴ | 5.70×10 ⁻⁷ | 3.42×10 ⁻⁵ | a | 1.56×10 ⁻³ | 4.40×10 ⁻⁴ |
| Evaporator replacement 6 | 2168 | 2168 | 6.10×10 ⁻⁵ | 1.02×10 ⁻⁴ | 5.70×10 ⁻⁷ | 3.42×10 ⁻⁵ | a | 1.56×10 ⁻³ | 4.40×10 ⁻⁴ |
| Closure | | | | | | | | | |
| Containment structure construction 1 | 2038 | 2041 | a | a | a | a | a | a | a |
| Containment structure construction 2 | 2061 | 2064 | a | a | a | a | a | a | a |
| Containment structure construction 3 | 2084 | 2087 | a | a | a | a | a | a | a |
| Containment structure construction 4 | 2107 | 2110 | a | a | a | a | a | a | a |
| Containment structure construction 5 | 2122 | 2125 | a | a | a | a | a | a | a |
| Containment structure construction 6 | 2138 | 2141 | a | a | a | a | a | a | a |
| Containment structure deactivation 1 | 2062 | 2064 | a | a | a | a | a | a | a |
| Containment structure deactivation 2 | 2085 | 2087 | a | a | a | a | a | a | a |
| Containment structure deactivation 3 | 2108 | 2110 | a | a | a | a | a | a | a |
| Containment structure deactivation 4 | 2123 | 2125 | a | a | a | a | a | a | a |
| Containment structure deactivation 5 | 2146 | 2148 | a | a | a | a | a | a | a |
| Containment structure deactivation 6 | 2138 | 2140 | a | a | a | a | a | a | a |
| Containment structure deactivation 7 | 2162 | 2164 | a | a | a | a | a | a | a |
| Decontamination and decommissioning of 10 selected facilities | 2018 | 2028 | a | a | a | a | a | a | a |

G-186

Table G–82. Tank Closure Alternative 6A, Option Case, Toxic Pollutant Emissions from Mobile Sources (continued)

| Facility/System | Start Year | End Year | Emission Rate (metric tons per year) | | | | | | |
|--|------------|----------|--------------------------------------|-----------------------|-----------------------|-----------------------|---------|-----------------------|-----------------------|
| | | | Ammonia | Benzene | 1,3-Butadiene | Formaldehyde | Mercury | Toulene | Xylene |
| Closure (continued) | | | | | | | | | |
| B tank farm removal | 2065 | 2076 | a | a | a | a | a | a | a |
| T tank farm removal | 2126 | 2137 | a | a | a | a | a | a | a |
| BY tank farm removal | 2111 | 2122 | a | a | a | a | a | a | a |
| BX tank farm removal | 2042 | 2053 | a | a | a | a | a | a | a |
| C tank farm removal | 2088 | 2099 | a | a | a | a | a | a | a |
| A tank farm removal | 2142 | 2153 | a | a | a | a | a | a | a |
| AX tank farm removal | 2142 | 2153 | a | a | a | a | a | a | a |
| S tank farm removal | 2126 | 2137 | a | a | a | a | a | a | a |
| TY tank farm removal | 2111 | 2122 | a | a | a | a | a | a | a |
| TX tank farm removal | 2088 | 2099 | a | a | a | a | a | a | a |
| U tank farm removal | 2065 | 2076 | a | a | a | a | a | a | a |
| SX tank farm removal | 2042 | 2053 | a | a | a | a | a | a | a |
| B tank farm deep soil removal | 2077 | 2084 | a | a | a | a | a | a | a |
| T tank farm deep soil removal | 2138 | 2145 | a | a | a | a | a | a | a |
| BX tank farm deep soil removal | 2054 | 2061 | a | a | a | a | a | a | a |
| C tank farm deep soil removal | 2100 | 2107 | a | a | a | a | a | a | a |
| A tank farm deep soil removal | 2154 | 2161 | a | a | a | a | a | a | a |
| AX tank farm deep soil removal | 2154 | 2161 | a | a | a | a | a | a | a |
| TX tank farm deep soil removal | 2100 | 2107 | a | a | a | a | a | a | a |
| U tank farm deep soil removal | 2077 | 2084 | a | a | a | a | a | a | a |
| SX tank farm deep soil removal | 2054 | 2061 | a | a | a | a | a | a | a |
| B Area cribs and trenches (ditches) removal | 2054 | 2084 | a | a | a | a | a | a | a |
| T Area cribs and trenches (ditches) removal | 2100 | 2145 | a | a | a | a | a | a | a |
| B and T Area cribs and trenches (ditches) construction 1 | 2050 | 2053 | a | a | a | a | a | a | a |
| B and T Area cribs and trenches (ditches) construction 2 | 2096 | 2099 | a | a | a | a | a | a | a |
| B and T Area cribs and trenches (ditches) deactivation 1 | 2085 | 2087 | a | a | a | a | a | a | a |
| B and T Area cribs and trenches (ditches) deactivation 2 | 2146 | 2148 | a | a | a | a | a | a | a |
| Preprocessing Facility construction | 2039 | 2041 | 1.96×10 ¹ | 2.34×10 ⁻¹ | 9.83×10 ⁻³ | 2.97×10 ⁻¹ | a | 1.03×10 ⁻¹ | 7.16×10 ⁻² |

Table G-82. Tank Closure Alternative 6A, Option Case, Toxic Pollutant Emissions from Mobile Sources (continued)

| Facility/System | Start Year | End Year | Emission Rate (metric tons per year) | | | | | | |
|-------------------------------------|------------|----------|--------------------------------------|-----------------------|-----------------------|-----------------------|---------|-----------------------|-----------------------|
| | | | Ammonia | Benzene | 1,3-Butadiene | Formaldehyde | Mercury | Toulene | Xylene |
| Closure (continued) | | | | | | | | | |
| Preprocessing Facility operations | 2042 | 2162 | 2.54×10 ⁻³ | 4.72×10 ⁻⁵ | 1.98×10 ⁻⁶ | 5.97×10 ⁻⁵ | a | 2.07×10 ⁻⁵ | 1.44×10 ⁻⁵ |
| Preprocessing Facility deactivation | 2163 | 2163 | 3.99×10 ⁻⁴ | 7.42×10 ⁻⁶ | 3.11×10 ⁻⁷ | 9.39×10 ⁻⁶ | a | 3.25×10 ⁻⁶ | 2.27×10 ⁻⁶ |

^a Emissions for this activity and pollutant were not calculated because annual fuel use for this activity and the resulting emissions would be small compared with other activities or would be zero.

Key: HLW=high-level radioactive waste; IHLW=immobilized high-level radioactive waste.

Source: SAIC 2007a, 2008.

Table G-83. Tank Closure Alternative 6B, Base Case, Criteria Pollutant Emissions from Mobile Sources

| Facility/System | Start Year | End Year | Emission Rate (metric tons per year) | | | |
|---|------------|----------|--------------------------------------|----------------------|----------------------|-----------------------|
| | | | Carbon Monoxide | Nitrogen Dioxide | PM ₁₀ | Sulfur Dioxide |
| Construction | | | | | | |
| Canister Storage Building | 2006 | 2016 | a | a | a | a |
| IHLW Shipping/Transfer Facility | 2011 | 2013 | a | a | a | a |
| IHLW Interim Storage Modules | 2014 | 2022 | a | a | a | a |
| Other infrastructure upgrades | 2006 | 2034 | a | a | a | a |
| Tank upgrades | 2006 | 2025 | a | a | a | a |
| Waste Treatment Plant | 2006 | 2017 | 1.08×10 ¹ | 5.03×10 ¹ | 4.13×10 ² | 1.71×10 ⁻² |
| Low-Activity Waste Vitrification Facility | 2008 | 2017 | 1.54 | 7.16 | 5.43×10 ¹ | 2.43×10 ⁻³ |
| Cesium and Strontium Capsule Processing Facility | 2035 | 2038 | 3.13 | 1.28×10 ¹ | 4.24×10 ² | 4.85×10 ⁻³ |
| Waste receiver facilities | 2013 | 2017 | a | a | a | a |
| Tank risers | 2013 | 2016 | a | a | a | a |
| Mobile retrieval system | 2013 | 2043 | a | a | a | a |
| Vacuum-based retrieval system | 2013 | 2043 | a | a | a | a |
| Chemical wash system | 2013 | 2043 | a | a | a | a |
| HLW Melter Interim Storage Facility 1 | 2015 | 2016 | a | a | a | a |
| HLW Melter Interim Storage Facility 2 | 2029 | 2030 | a | a | a | a |
| Effluent Treatment Facility replacement 1 | 2023 | 2025 | 1.25×10 ¹ | 1.34×10 ¹ | 4.75×10 ² | 1.74×10 ⁻² |
| Effluent Treatment Facility replacement 2 | 2053 | 2055 | 1.24×10 ¹ | 1.33×10 ¹ | 9.46×10 ² | 1.73×10 ⁻² |
| Effluent Treatment Facility replacement 3 | 2083 | 2085 | 1.24×10 ¹ | 1.33×10 ¹ | 9.46×10 ² | 1.73×10 ⁻² |
| Evaporator replacement 1 | 2015 | 2017 | 3.62 | 2.96 | 1.41×10 ² | 5.00×10 ⁻³ |
| Immobilized Low-Activity Waste Interim Storage Facilities | 2016 | 2043 | 5.50 | 2.55×10 ¹ | 1.37×10 ² | 8.42×10 ⁻³ |
| HLW Debris Storage Facilities | 2021 | 2090 | a | a | a | a |
| Underground transfer line 1,000-foot sections | 2009 | 2009 | a | a | a | a |
| Operations | | | | | | |
| IHLW Interim Storage Facility | 2018 | 2066 | a | a | a | a |
| Other infrastructure upgrades | 2006 | 2043 | a | a | a | a |
| Routine operations | 2006 | 2043 | 3.10×10 ¹ | 1.44×10 ² | 1.32×10 ¹ | 4.73×10 ⁻² |
| Retrieval operations | 2006 | 2043 | a | a | a | a |
| Double-shell tank interim stabilization | 2006 | 2043 | a | a | a | a |
| Waste Treatment Plant | 2018 | 2043 | 2.34×10 ¹ | 1.08×10 ² | 5.07×10 ² | 3.69×10 ⁻² |
| Waste Treatment Plant, cesium and strontium capsules | 2040 | 2040 | 2.34×10 ¹ | 1.08×10 ² | 5.07×10 ² | 3.69×10 ⁻² |
| Cesium and Strontium Capsule Processing Facility | 2039 | 2040 | 2.71 | 1.12×10 ¹ | 8.61×10 ¹ | 4.20×10 ⁻³ |
| Mobile retrieval system | 2013 | 2043 | a | a | a | a |
| Vacuum-based retrieval system | 2013 | 2043 | a | a | a | a |

Table G–83. Tank Closure Alternative 6B, Base Case, Criteria Pollutant Emissions from Mobile Sources (continued)

| Facility/System | Start Year | End Year | Emission Rate (metric tons per year) | | | |
|---|------------|----------|--------------------------------------|-----------------------|-----------------------|-----------------------|
| | | | Carbon Monoxide | Nitrogen Dioxide | PM ₁₀ | Sulfur Dioxide |
| Operations (continued) | | | | | | |
| Chemical wash system | 2013 | 2043 | a | a | a | a |
| HLW Melter Interim Storage Facility | 2018 | 2199 | a | a | a | a |
| Effluent Treatment Facility | 2006 | 2100 | 6.46×10 ² | 1.68×10 ¹ | 3.25×10 ³ | 8.66×10 ⁻¹ |
| Evaporator | 2006 | 2043 | 3.22 | 8.38×10 ⁻² | 1.59×10 ² | 4.32×10 ⁻³ |
| Borrow Area C | 2006 | 2102 | a | a | 4.24×10 ² | a |
| Immobilized Low-Activity Waste Interim Storage Facilities | 2018 | 2199 | a | a | a | a |
| HLW Debris Storage Facilities | 2023 | 2199 | a | a | a | a |
| Deactivation | | | | | | |
| Mobile retrieval system | 2013 | 2043 | a | a | a | a |
| Vacuum-based retrieval system | 2013 | 2043 | a | a | a | a |
| Chemical wash system | 2013 | 2043 | a | a | a | a |
| IHLW Interim Storage Facility | 2067 | 2067 | a | a | a | a |
| Waste Treatment Plant | 2044 | 2045 | 2.34 | 1.08×10 ¹ | 5.07×10 ¹ | 3.69×10 ⁻³ |
| Cesium and Strontium Capsule Processing Facility | 2041 | 2041 | 1.31 | 5.16 | 3.78×10 ⁻¹ | 2.02×10 ⁻³ |
| Effluent Treatment Facility original | 2026 | 2026 | 3.23×10 ² | 8.40 | 5.97 | 4.33×10 ⁻¹ |
| Effluent Treatment Facility replacement 1 | 2056 | 2056 | 3.23×10 ² | 8.40 | 5.97 | 4.33×10 ⁻¹ |
| Effluent Treatment Facility replacement 2 | 2086 | 2086 | 3.23×10 ² | 8.40 | 5.97 | 4.33×10 ⁻¹ |
| Effluent Treatment Facility replacement 3 | 2101 | 2101 | 3.23×10 ² | 8.40 | 5.97 | 4.33×10 ⁻¹ |
| Evaporator original | 2018 | 2018 | 7.89×10 ⁻¹ | 2.05×10 ⁻² | 2.75 | 1.06×10 ⁻³ |
| Evaporator replacement | 2044 | 2044 | 7.89×10 ⁻¹ | 2.05×10 ⁻² | 2.75 | 1.06×10 ⁻³ |
| Closure | | | | | | |
| Containment structure construction 1 | 2019 | 2022 | a | a | a | a |
| Containment structure construction 2 | 2019 | 2022 | a | a | a | a |
| Containment structure construction 3 | 2046 | 2049 | a | a | a | a |
| Containment structure construction 4 | 2046 | 2049 | a | a | a | a |
| Containment structure construction 5 | 2073 | 2076 | a | a | a | a |
| Containment structure construction 6 | 2073 | 2076 | a | a | a | a |
| Containment structure deactivation 1 | 2043 | 2045 | a | a | a | a |
| Containment structure deactivation 2 | 2043 | 2045 | a | a | a | a |
| Containment structure deactivation 3 | 2070 | 2072 | a | a | a | a |
| Containment structure deactivation 4 | 2062 | 2064 | a | a | a | a |
| Containment structure deactivation 5 | 2089 | 2091 | a | a | a | a |
| Containment structure deactivation 6 | 2097 | 2099 | a | a | a | a |

Table G-83. Tank Closure Alternative 6B, Base Case, Criteria Pollutant Emissions from Mobile Sources (*continued*)

| Facility/System | Start Year | End Year | Emission Rate (metric tons per year) | | | |
|---|------------|----------|--------------------------------------|-----------------------|-----------------------|-----------------------|
| | | | Carbon Monoxide | Nitrogen Dioxide | PM ₁₀ | Sulfur Dioxide |
| Closure (<i>continued</i>) | | | | | | |
| Containment structure deactivation 7 | 2097 | 2099 | a | a | a | a |
| Modified Resource Conservation and Recovery Act Subtitle C barrier construction | 2100 | 2101 | 1.78×10 ¹ | 8.28×10 ¹ | 7.01×10 ² | 2.81×10 ⁻² |
| Decontamination and decommissioning of 10 selected facilities | 2018 | 2028 | a | a | a | a |
| B tank farm removal | 2023 | 2034 | a | a | a | a |
| T tank farm removal | 2077 | 2088 | a | a | a | a |
| BY tank farm removal | 2050 | 2061 | a | a | a | a |
| BX tank farm removal | 2023 | 2034 | a | a | a | a |
| C tank farm removal | 2050 | 2061 | a | a | a | a |
| A tank farm removal | 2077 | 2088 | a | a | a | a |
| AX tank farm removal | 2077 | 2088 | a | a | a | a |
| S tank farm removal | 2077 | 2088 | a | a | a | a |
| TY tank farm removal | 2050 | 2061 | a | a | a | a |
| TX tank farm removal | 2050 | 2061 | a | a | a | a |
| U tank farm removal | 2023 | 2034 | a | a | a | a |
| SX tank farm removal | 2023 | 2034 | a | a | a | a |
| B tank farm deep soil removal | 2035 | 2042 | a | a | a | a |
| T tank farm deep soil removal | 2089 | 2096 | a | a | a | a |
| BX tank farm deep soil removal | 2035 | 2042 | a | a | a | a |
| C tank farm deep soil removal | 2062 | 2069 | a | a | a | a |
| A tank farm deep soil removal | 2089 | 2096 | a | a | a | a |
| AX tank farm deep soil removal | 2089 | 2096 | a | a | a | a |
| TX tank farm deep soil removal | 2062 | 2069 | a | a | a | a |
| U tank farm deep soil removal | 2035 | 2042 | a | a | a | a |
| SX tank farm deep soil removal | 2035 | 2042 | a | a | a | a |
| Preprocessing Facility construction | 2020 | 2022 | 3.06×10 ¹ | 1.42×10 ² | 9.68×10 ² | 4.84×10 ⁻² |
| Preprocessing Facility operations | 2023 | 2099 | 1.88×10 ⁻² | 8.75×10 ⁻² | 4.09×10 ⁻¹ | 2.98×10 ⁻⁵ |
| Preprocessing Facility deactivation | 2100 | 2100 | 2.96×10 ⁻³ | 1.37×10 ⁻² | 6.42×10 ⁻² | 4.68×10 ⁻⁶ |
| Postclosure care | 2102 | 2201 | a | a | a | a |

^a Emissions for this activity and pollutant were not calculated because annual fuel use for this activity and the resulting emissions would be small compared with other activities or would be zero.

Key: HLW=high-level radioactive waste; IHLW=immobilized high-level radioactive waste; PM₁₀=particulate matter with an aerodynamic diameter less than or equal to 10 micrometers.

Source: SAIC 2007a, 2008.

Table G-84. Tank Closure Alternative 6B, Base Case, Toxic Pollutant Emissions from Mobile Sources

| Facility/System | Start Year | End Year | Emission Rate (metric tons per year) | | | | | | |
|---|------------|----------|--------------------------------------|-----------------------|-----------------------|-----------------------|---------|-----------------------|-----------------------|
| | | | Ammonia | Benzene | 1,3-Butadiene | Formaldehyde | Mercury | Toluene | Xylene |
| Construction | | | | | | | | | |
| Canister Storage Building | 2006 | 2016 | a | a | a | a | a | a | a |
| IHLW Shipping/Transfer Facility | 2011 | 2013 | a | a | a | a | a | a | a |
| IHLW Interim Storage Modules | 2014 | 2022 | a | a | a | a | a | a | a |
| Other infrastructure upgrades | 2006 | 2034 | a | a | a | a | a | a | a |
| Tank upgrades | 2006 | 2025 | a | a | a | a | a | a | a |
| Waste Treatment Plant | 2006 | 2017 | 7.91×10 ⁻² | 1.06×10 ⁻² | 4.46×10 ⁻⁴ | 2.24×10 ⁻² | a | 4.66×10 ⁻³ | 3.25×10 ⁻³ |
| Low-Activity Waste Vitrification Facility | 2008 | 2017 | 1.13×10 ⁻² | 1.51×10 ⁻³ | 6.35×10 ⁻⁵ | 1.92×10 ⁻³ | a | 6.64×10 ⁻⁴ | 4.63×10 ⁻⁴ |
| Cesium and Strontium Capsule Processing Facility | 2035 | 2038 | 2.01×10 ⁻² | 2.75×10 ⁻³ | 1.13×10 ⁻⁴ | 3.43×10 ⁻³ | a | 1.94×10 ⁻³ | 1.04×10 ⁻³ |
| Waste receiver facilities | 2013 | 2017 | a | a | a | a | a | a | a |
| Tank risers | 2013 | 2016 | a | a | a | a | a | a | a |
| Mobile retrieval system | 2013 | 2043 | a | a | a | a | a | a | a |
| Vacuum-based retrieval system | 2013 | 2043 | a | a | a | a | a | a | a |
| Chemical wash system | 2013 | 2043 | a | a | a | a | a | a | a |
| HLW Melter Interim Storage Facility 1 | 2015 | 2016 | a | a | a | a | a | a | a |
| HLW Melter Interim Storage Facility 2 | 2029 | 2030 | a | a | a | a | a | a | a |
| Effluent Treatment Facility replacement 1 | 2023 | 2025 | 2.14×10 ⁻² | 4.02×10 ⁻³ | 1.23×10 ⁻⁴ | 3.93×10 ⁻³ | a | 2.02×10 ⁻² | 6.22×10 ⁻³ |
| Effluent Treatment Facility replacement 2 | 2053 | 2055 | 2.13×10 ⁻² | 4.00×10 ⁻³ | 1.23×10 ⁻⁴ | 3.92×10 ⁻³ | a | 2.02×10 ⁻² | 6.20×10 ⁻³ |
| Effluent Treatment Facility replacement 3 | 2083 | 2085 | 2.13×10 ⁻² | 4.00×10 ⁻³ | 1.23×10 ⁻⁴ | 3.92×10 ⁻³ | a | 2.02×10 ⁻² | 6.20×10 ⁻³ |
| Evaporator replacement 1 | 2015 | 2017 | 4.76×10 ⁻³ | 9.96×10 ⁻⁴ | 7.95×10 ⁻⁴ | 9.01×10 ⁻⁴ | a | 6.20×10 ⁻³ | 1.86×10 ⁻³ |
| Immobilized Low-Activity Waste Interim Storage Facilities | 2016 | 2043 | 4.01×10 ⁻² | 5.40×10 ⁻³ | a | a | a | 5.40×10 ⁻³ | 5.40×10 ⁻³ |
| HLW Debris Storage Facilities | 2021 | 2090 | a | a | a | a | a | a | a |
| Underground transfer line 1,000-foot sections | 2009 | 2009 | a | a | a | a | a | a | a |
| Operations | | | | | | | | | |
| IHLW Interim Storage Facility | 2018 | 2066 | a | a | a | a | a | a | a |
| Other infrastructure upgrades | 2006 | 2043 | a | a | a | a | a | a | a |
| Routine operations | 2006 | 2043 | 2.26×10 ⁻¹ | 3.42×10 ⁻² | a | a | a | 1.50×10 ⁻² | 1.04×10 ⁻² |
| Retrieval operations | 2006 | 2043 | a | a | a | a | a | a | a |
| Double-shell tank interim stabilization | 2006 | 2043 | a | a | a | a | a | a | a |
| Waste Treatment Plant | 2018 | 2043 | 1.71×10 ⁻¹ | 2.30×10 ⁻² | 9.62×10 ⁻⁴ | 2.90×10 ⁻² | a | 1.01×10 ⁻² | 7.01×10 ⁻³ |
| Waste Treatment Plant, cesium and strontium capsules | 2040 | 2040 | 1.71×10 ⁻¹ | 2.30×10 ⁻² | 9.62×10 ⁻⁴ | 2.90×10 ⁻² | a | 1.01×10 ⁻² | 7.01×10 ⁻³ |
| Cesium and Strontium Capsule Processing Facility | 2039 | 2040 | 1.76×10 ⁻² | 2.40×10 ⁻³ | 9.93×10 ⁻⁵ | 3.00×10 ⁻³ | a | 1.63×10 ⁻³ | 8.90×10 ⁻⁴ |
| Mobile retrieval system | 2013 | 2043 | a | a | a | a | a | a | a |

G-192

Draft Tank Closure and Waste Management Environmental Impact Statement for the Hanford Site, Richland, Washington

Table G-84. Tank Closure Alternative 6B, Base Case, Toxic Pollutant Emissions from Mobile Sources (continued)

| Facility/System | Start Year | End Year | Emission Rate (metric tons per year) | | | | | | |
|---|------------|----------|--------------------------------------|-----------------------|-----------------------|-----------------------|---------|-----------------------|-----------------------|
| | | | Ammonia | Benzene | 1,3-Butadiene | Formaldehyde | Mercury | Toluene | Xylene |
| Operations (continued) | | | | | | | | | |
| Vacuum-based retrieval system | 2013 | 2043 | a | a | a | a | a | a | a |
| Chemical wash system | 2013 | 2043 | a | a | a | a | a | a | a |
| HLW Melter Interim Storage Facility | 2018 | 2199 | a | a | a | a | a | a | a |
| Effluent Treatment Facility | 2006 | 2100 | 4.99×10 ⁻² | 8.32×10 ⁻² | 4.67×10 ⁻⁴ | 2.80×10 ⁻² | a | 1.28 | 3.61×10 ⁻¹ |
| Evaporator | 2006 | 2043 | 2.49×10 ⁻⁴ | 4.15×10 ⁻⁴ | 2.33×10 ⁻⁶ | 1.40×10 ⁻⁴ | a | 6.38×10 ⁻³ | 1.80×10 ⁻³ |
| Borrow Area C | 2006 | 2102 | a | a | a | a | a | a | a |
| Immobilized Low-Activity Waste Interim Storage Facilities | 2018 | 2199 | a | a | a | a | a | a | a |
| HLW Debris Storage Facilities | 2023 | 2199 | a | a | a | a | a | a | a |
| Deactivation | | | | | | | | | |
| Mobile retrieval system | 2013 | 2043 | a | a | a | a | a | a | a |
| Vacuum-based retrieval system | 2013 | 2043 | a | a | a | a | a | a | a |
| Chemical wash system | 2013 | 2043 | a | a | a | a | a | a | a |
| IHLW Interim Storage Facility | 2067 | 2067 | a | a | a | a | a | a | a |
| Waste Treatment Plant | 2044 | 2045 | 1.71×10 ⁻² | 2.30×10 ⁻³ | 9.62×10 ⁻⁵ | 2.90×10 ⁻³ | a | 1.01×10 ⁻³ | 7.01×10 ⁻⁴ |
| Cesium and Strontium Capsule Processing Facility | 2041 | 2041 | 8.12×10 ⁻³ | 1.12×10 ⁻³ | 4.59×10 ⁻⁵ | 1.39×10 ⁻³ | a | 8.76×10 ⁻⁴ | 4.45×10 ⁻⁴ |
| Effluent Treatment Facility original | 2026 | 2026 | 2.50×10 ⁻² | 4.16×10 ⁻² | 2.34×10 ⁻⁴ | 1.40×10 ⁻² | a | 6.39×10 ⁻¹ | 1.80×10 ⁻¹ |
| Effluent Treatment Facility replacement 1 | 2056 | 2056 | 2.50×10 ⁻² | 4.16×10 ⁻² | 2.34×10 ⁻⁴ | 1.40×10 ⁻² | a | 6.39×10 ⁻¹ | 1.80×10 ⁻¹ |
| Effluent Treatment Facility replacement 2 | 2086 | 2086 | 2.50×10 ⁻² | 4.16×10 ⁻² | 2.34×10 ⁻⁴ | 1.40×10 ⁻² | a | 6.39×10 ⁻¹ | 1.80×10 ⁻¹ |
| Effluent Treatment Facility replacement 3 | 2101 | 2101 | 2.50×10 ⁻² | 4.16×10 ⁻² | 2.34×10 ⁻⁴ | 1.40×10 ⁻² | a | 6.39×10 ⁻¹ | 1.80×10 ⁻¹ |
| Evaporator original | 2018 | 2018 | 6.10×10 ⁻⁵ | 1.02×10 ⁻⁴ | 5.70×10 ⁻⁷ | 3.42×10 ⁻⁵ | a | 1.56×10 ⁻³ | 4.40×10 ⁻⁴ |
| Evaporator replacement 1 | 2044 | 2044 | 6.10×10 ⁻⁵ | 1.02×10 ⁻⁴ | 5.70×10 ⁻⁷ | 3.42×10 ⁻⁵ | a | 1.56×10 ⁻³ | 4.40×10 ⁻⁴ |
| Closure | | | | | | | | | |
| Containment structure construction 1 | 2019 | 2022 | a | a | a | a | a | a | a |
| Containment structure construction 2 | 2019 | 2022 | a | a | a | a | a | a | a |
| Containment structure construction 3 | 2046 | 2049 | a | a | a | a | a | a | a |
| Containment structure construction 4 | 2046 | 2049 | a | a | a | a | a | a | a |
| Containment structure construction 5 | 2073 | 2076 | a | a | a | a | a | a | a |
| Containment structure construction 6 | 2073 | 2076 | a | a | a | a | a | a | a |
| Containment structure deactivation 1 | 2043 | 2045 | a | a | a | a | a | a | a |
| Containment structure deactivation 2 | 2043 | 2045 | a | a | a | a | a | a | a |
| Containment structure deactivation 3 | 2070 | 2072 | a | a | a | a | a | a | a |
| Containment structure deactivation 4 | 2062 | 2064 | a | a | a | a | a | a | a |

Table G-84. Tank Closure Alternative 6B, Base Case, Toxic Pollutant Emissions from Mobile Sources (continued)

| Facility/System | Start Year | End Year | Emission Rate (metric tons per year) | | | | | | |
|---|------------|----------|--------------------------------------|-----------------------|-----------------------|-----------------------|---------|-----------------------|-----------------------|
| | | | Ammonia | Benzene | 1,3-Butadiene | Formaldehyde | Mercury | Toluene | Xylene |
| Closure (continued) | | | | | | | | | |
| Containment structure deactivation 5 | 2089 | 2091 | a | a | a | a | a | a | a |
| Containment structure deactivation 6 | 2097 | 2099 | a | a | a | a | a | a | a |
| Containment structure deactivation 7 | 2097 | 2099 | a | a | a | a | a | a | a |
| Modified Resource Conservation and Recovery Act Subtitle C barrier construction | 2100 | 2101 | 1.30×10 ⁻¹ | 3.25×10 ⁻¹ | 1.36×10 ⁻² | 4.12×10 ⁻¹ | a | 1.43×10 ⁻¹ | 9.94×10 ⁻² |
| Decontamination and decommissioning of 10 selected facilities | 2018 | 2028 | a | a | a | a | a | a | a |
| B tank farm removal | 2023 | 2034 | a | a | a | a | a | a | a |
| T tank farm removal | 2077 | 2088 | a | a | a | a | a | a | a |
| BY tank farm removal | 2050 | 2061 | a | a | a | a | a | a | a |
| BX tank farm removal | 2023 | 2034 | a | a | a | a | a | a | a |
| C tank farm removal | 2050 | 2061 | a | a | a | a | a | a | a |
| A tank farm removal | 2077 | 2088 | a | a | a | a | a | a | a |
| AX tank farm removal | 2077 | 2088 | a | a | a | a | a | a | a |
| S tank farm removal | 2077 | 2088 | a | a | a | a | a | a | a |
| TY tank farm removal | 2050 | 2061 | a | a | a | a | a | a | a |
| TX tank farm removal | 2050 | 2061 | a | a | a | a | a | a | a |
| U tank farm removal | 2023 | 2034 | a | a | a | a | a | a | a |
| SX tank farm removal | 2023 | 2034 | a | a | a | a | a | a | a |
| B tank farm deep soil removal | 2035 | 2042 | a | a | a | a | a | a | a |
| T tank farm deep soil removal | 2089 | 2096 | a | a | a | a | a | a | a |
| BX tank farm deep soil removal | 2035 | 2042 | a | a | a | a | a | a | a |
| C tank farm deep soil removal | 2062 | 2069 | a | a | a | a | a | a | a |
| A tank farm deep soil removal | 2089 | 2096 | a | a | a | a | a | a | a |
| AX tank farm deep soil removal | 2089 | 2096 | a | a | a | a | a | a | a |
| TX tank farm deep soil removal | 2062 | 2069 | a | a | a | a | a | a | a |
| U tank farm deep soil removal | 2035 | 2042 | a | a | a | a | a | a | a |
| SX tank farm deep soil removal | 2035 | 2042 | a | a | a | a | a | a | a |
| Preprocessing Facility construction | 2020 | 2022 | 2.24×10 ⁻¹ | 1.17×10 ⁻¹ | 4.90×10 ⁻³ | 1.48×10 ⁻¹ | a | 5.12×10 ⁻² | 3.57×10 ⁻² |

Table G-84. Tank Closure Alternative 6B, Base Case, Toxic Pollutant Emissions from Mobile Sources (continued)

| Facility/System | Start Year | End Year | Emission Rate (metric tons per year) | | | | | | |
|-------------------------------------|------------|----------|--------------------------------------|-----------------------|-----------------------|-----------------------|---------|-----------------------|-----------------------|
| | | | Ammonia | Benzene | 1,3-Butadiene | Formaldehyde | Mercury | Toluene | Xylene |
| Closure (continued) | | | | | | | | | |
| Preprocessing Facility operations | 2023 | 2099 | 1.38×10 ⁻⁴ | 1.34×10 ⁻⁵ | 5.63×10 ⁻⁷ | 1.70×10 ⁻⁵ | a | 5.89×10 ⁻⁶ | 4.11×10 ⁻⁶ |
| Preprocessing Facility deactivation | 2100 | 2100 | 2.16×10 ⁻⁵ | 2.11×10 ⁻⁶ | 8.85×10 ⁻⁸ | 2.67×10 ⁻⁶ | a | 9.26×10 ⁻⁷ | 6.45×10 ⁻⁷ |
| Postclosure care | 2102 | 2201 | a | a | a | a | a | a | a |

^a Emissions for this activity and pollutant were not calculated because annual fuel use for this activity and the resulting emissions would be small compared with other activities or would be zero.

Key: HLW=high-level radioactive waste; IHLW=immobilized high-level radioactive waste.

Source: SAIC 2007a, 2008.

Table G-85. Tank Closure Alternative 6B, Option Case, Criteria Pollutant Emissions from Mobile Sources

| Facility/System | Start Year | End Year | Emission Rate (metric tons per year) | | | |
|---|------------|----------|--------------------------------------|----------------------|-----------------------|-----------------------|
| | | | Carbon Monoxide | Nitrogen Dioxide | PM ₁₀ | Sulfur Dioxide |
| Construction | | | | | | |
| Canister Storage Building | 2006 | 2016 | a | a | a | a |
| IHLW Shipping/Transfer Facility and one IHLW Interim Storage Module | 2011 | 2013 | a | a | a | a |
| IHLW Interim Storage Modules, three additional | 2014 | 2022 | a | a | a | a |
| Other infrastructure upgrades | 2006 | 2034 | a | a | a | a |
| Tank upgrades | 2006 | 2025 | a | a | a | a |
| Waste Treatment Plant | 2006 | 2017 | 1.08×10 ¹ | 5.03×10 ¹ | 4.13×10 ² | 1.71×10 ⁻² |
| Low-Activity Waste Vitrification Facility | 2008 | 2017 | 1.54 | 7.16 | 5.43×10 ¹ | 2.43×10 ⁻³ |
| Cesium and Strontium Capsule Processing Facility | 2035 | 2038 | 3.13 | 1.28×10 ¹ | 4.24×10 ² | 4.85×10 ⁻³ |
| Waste receiver facilities | 2013 | 2017 | a | a | a | a |
| Tank risers | 2013 | 2016 | a | a | a | a |
| Mobile retrieval system | 2013 | 2043 | a | a | a | a |
| Vacuum-based retrieval system | 2013 | 2043 | a | a | a | a |
| Chemical wash system | 2013 | 2043 | a | a | a | a |
| HLW Melter Interim Storage Facility 1 | 2015 | 2016 | a | a | a | a |
| HLW Melter Interim Storage Facility 2 | 2029 | 2030 | a | a | a | a |
| Effluent Treatment Facility replacement 1 | 2023 | 2025 | 1.25×10 ¹ | 1.34×10 ¹ | 4.75×10 ² | 1.74×10 ⁻² |
| Effluent Treatment Facility replacement 2 | 2053 | 2055 | 1.24×10 ¹ | 1.33×10 ¹ | 9.46×10 ² | 1.73×10 ⁻² |
| Effluent Treatment Facility replacement 3 | 2083 | 2085 | 1.24×10 ¹ | 1.33×10 ¹ | 9.46×10 ² | 1.73×10 ⁻² |
| Evaporator replacement 1 | 2015 | 2017 | 3.62 | 2.96 | 1.41×10 ² | 5.00×10 ⁻³ |
| Immobilized Low-Activity Waste Interim Storage Facilities | 2016 | 2043 | 5.50 | 2.55×10 ¹ | 1.37×10 ² | 8.42×10 ⁻³ |
| HLW Debris Storage Facilities | 2021 | 2090 | a | a | a | a |
| Underground transfer line 1,000-foot sections | 2009 | 2009 | a | a | a | a |
| Operations | | | | | | |
| IHLW Interim Storage Facility | 2018 | 2066 | a | a | a | a |
| Other infrastructure upgrades | 2006 | 2043 | a | a | a | a |
| Routine operations | 2006 | 2043 | 3.10×10 ¹ | 1.44×10 ² | 1.32×10 ¹ | 4.73×10 ⁻² |
| Retrieval operations | 2006 | 2043 | a | a | a | a |
| Double-shell tank interim stabilization | 2006 | 2043 | a | a | a | a |
| Waste Treatment Plant | 2018 | 2043 | 2.34×10 ¹ | 1.08×10 ² | 5.07×10 ² | 3.69×10 ⁻² |
| Waste Treatment Plant, cesium and strontium capsules | 2040 | 2040 | 2.34×10 ¹ | 1.08×10 ² | 5.07×10 ² | 3.69×10 ⁻² |
| Cesium and Strontium Capsule Processing Facility | 2039 | 2040 | 2.71 | 1.12×10 ¹ | 8.61×10 ⁻¹ | 4.20×10 ⁻³ |

Table G-85. Tank Closure Alternative 6B, Option Case, Criteria Pollutant Emissions from Mobile Sources (*continued*)

| Facility/System | Start Year | End Year | Emission Rate (metric tons per year) | | | |
|---|------------|----------|--------------------------------------|-----------------------|-----------------------|-----------------------|
| | | | Carbon Monoxide | Nitrogen Dioxide | PM ₁₀ | Sulfur Dioxide |
| Operations (<i>continued</i>) | | | | | | |
| Mobile retrieval system | 2013 | 2043 | a | a | a | a |
| Vacuum-based retrieval system | 2013 | 2043 | a | a | a | a |
| Chemical wash system | 2013 | 2043 | a | a | a | a |
| HLW Melter Interim Storage Facility | 2018 | 2199 | a | a | a | a |
| Effluent Treatment Facility | 2006 | 2100 | 6.46×10^2 | 1.68×10^1 | 3.25×10^3 | 8.66×10^{-1} |
| Evaporator | 2006 | 2043 | 3.22 | 8.38×10^{-2} | 1.59×10^2 | 4.32×10^{-3} |
| Borrow Area C | 2006 | 2102 | a | a | 4.24×10^2 | a |
| Immobilized Low-Activity Waste Interim Storage Facilities | 2018 | 2199 | a | a | a | a |
| HLW Debris Storage Facilities | 2023 | 2199 | a | a | a | a |
| Deactivation | | | | | | |
| Mobile retrieval system | 2013 | 2043 | a | a | a | a |
| Vacuum-based retrieval system | 2013 | 2043 | a | a | a | a |
| Chemical wash system | 2013 | 2043 | a | a | a | a |
| IHLW Interim Storage Facility | 2067 | 2067 | a | a | a | a |
| Waste Treatment Plant | 2044 | 2045 | 2.34 | 1.08×10^1 | 5.07×10^1 | 3.69×10^{-3} |
| Cesium and Strontium Capsule Processing Facility | 2041 | 2041 | 1.31 | 5.16 | 3.78×10^{-1} | 2.02×10^{-3} |
| Effluent Treatment Facility original | 2026 | 2026 | 3.23×10^2 | 8.40 | 5.97 | 4.33×10^{-1} |
| Effluent Treatment Facility replacement 1 | 2056 | 2056 | 3.23×10^2 | 8.40 | 5.97 | 4.33×10^{-1} |
| Effluent Treatment Facility replacement 2 | 2086 | 2086 | 3.23×10^2 | 8.40 | 5.97 | 4.33×10^{-1} |
| Effluent Treatment Facility replacement 3 | 2101 | 2101 | 3.23×10^2 | 8.40 | 5.97 | 4.33×10^{-1} |
| Evaporator original | 2018 | 2018 | 7.89×10^{-1} | 2.05×10^{-2} | 2.75 | 1.06×10^{-3} |
| Evaporator replacement | 2044 | 2044 | 7.89×10^{-1} | 2.05×10^{-2} | 2.75 | 1.06×10^{-3} |
| Closure | | | | | | |
| Containment structure construction 1 | 2019 | 2022 | a | a | a | a |
| Containment structure construction 2 | 2046 | 2049 | a | a | a | a |
| Containment structure construction 3 | 2073 | 2076 | a | a | a | a |
| Containment structure deactivation 1 | 2043 | 2045 | a | a | a | a |
| Containment structure deactivation 2 | 2070 | 2072 | a | a | a | a |
| Containment structure deactivation 3 | 2062 | 2064 | a | a | a | a |
| Containment structure deactivation 4 | 2089 | 2091 | a | a | a | a |
| Containment structure deactivation 5 | 2097 | 2099 | a | a | a | a |
| Decontamination and decommissioning of 10 selected facilities | 2018 | 2028 | a | a | a | a |
| B tank farm removal | 2023 | 2034 | a | a | a | a |

Table G-85. Tank Closure Alternative 6B, Option Case, Criteria Pollutant Emissions from Mobile Sources (continued)

| Facility/System | Start Year | End Year | Emission Rate (metric tons per year) | | | |
|---|------------|----------|--------------------------------------|-----------------------|----------------------|-----------------------|
| | | | Carbon Monoxide | Nitrogen Dioxide | PM ₁₀ | Sulfur Dioxide |
| Closure (continued) | | | | | | |
| T tank farm removal | 2077 | 2088 | a | a | a | a |
| BY tank farm removal | 2050 | 2061 | a | a | a | a |
| BX tank farm removal | 2023 | 2034 | a | a | a | a |
| C tank farm removal | 2050 | 2061 | a | a | a | a |
| A tank farm removal | 2077 | 2088 | a | a | a | a |
| AX tank farm removal | 2077 | 2088 | a | a | a | a |
| S tank farm removal | 2077 | 2088 | a | a | a | a |
| TY tank farm removal | 2050 | 2061 | a | a | a | a |
| TX tank farm removal | 2050 | 2061 | a | a | a | a |
| U tank farm removal | 2023 | 2034 | a | a | a | a |
| SX tank farm removal | 2023 | 2034 | a | a | a | a |
| B tank farm deep soil removal | 2035 | 2042 | a | a | a | a |
| T tank farm deep soil removal | 2089 | 2096 | a | a | a | a |
| BX tank farm deep soil removal | 2035 | 2042 | a | a | a | a |
| C tank farm deep soil removal | 2062 | 2069 | a | a | a | a |
| A tank farm deep soil removal | 2089 | 2096 | a | a | a | a |
| AX tank farm deep soil removal | 2089 | 2096 | a | a | a | a |
| TX tank farm deep soil removal | 2062 | 2069 | a | a | a | a |
| U tank farm deep soil removal | 2035 | 2042 | a | a | a | a |
| SX tank farm deep soil removal | 2035 | 2042 | a | a | a | a |
| B Area cribs and trenches (ditches) removal | 2035 | 2061 | a | a | a | a |
| T Area cribs and trenches (ditches) removal | 2062 | 2096 | a | a | a | a |
| Containment structure construction 1 | 2029 | 2032 | a | a | a | a |
| Containment structure construction 2 | 2056 | 2059 | a | a | a | a |
| Containment structure deactivation 1 | 2062 | 2064 | a | a | a | a |
| Containment structure deactivation 2 | 2097 | 2099 | a | a | a | a |
| Preprocessing Facility construction | 2020 | 2022 | 2.68×10 ³ | 1.25×10 ⁴ | 5.88×10 ⁴ | 4.24 |
| Preprocessing Facility operations | 2023 | 2099 | 5.47×10 ⁻¹ | 2.54 | 1.19×10 ¹ | 8.64×10 ⁻⁴ |
| Preprocessing Facility deactivation | 2100 | 2100 | 5.47×10 ⁻² | 2.54×10 ⁻¹ | 1.19 | 8.64×10 ⁻⁵ |

^a Emissions for this activity and pollutant were not calculated because annual fuel use for this activity and the resulting emissions would be small compared with other activities or would be zero.

Key: HLW=high-level radioactive waste; IHLW=immobilized high-level radioactive waste; PM₁₀=particulate matter with an aerodynamic diameter less than or equal to 10 micrometers.

Source: SAIC 2007a, 2008.

Table G-86. Tank Closure Alternative 6B, Option Case, Toxic Pollutant Emissions from Mobile Sources

| Facility/System | Start Year | End Year | Emission Rate (metric tons per year) | | | | | | |
|---|------------|----------|--------------------------------------|-----------------------|-----------------------|-----------------------|---------|-----------------------|-----------------------|
| | | | Ammonia | Benzene | 1,3-Butadiene | Formaldehyde | Mercury | Toluene | Xylene |
| Construction | | | | | | | | | |
| Canister Storage Building | 2006 | 2016 | a | a | a | a | a | a | a |
| IHLW Shipping/Transfer Facility and one IHLW Interim Storage Module | 2011 | 2013 | a | a | a | a | a | a | a |
| IHLW Interim Storage Modules, three additional | 2014 | 2022 | a | a | a | a | a | a | a |
| Other infrastructure upgrades | 2006 | 2034 | a | a | a | a | a | a | a |
| Tank upgrades | 2006 | 2025 | a | a | a | a | a | a | a |
| Waste Treatment Plant | 2006 | 2017 | 7.91×10 ⁻² | 1.06×10 ⁻² | 4.46×10 ⁻⁴ | 2.24×10 ⁻² | a | 4.66×10 ⁻³ | 3.25×10 ⁻³ |
| Low-Activity Waste Vitrification Facility | 2008 | 2017 | 1.13×10 ⁻² | 1.51×10 ⁻³ | 6.35×10 ⁻⁵ | 1.92×10 ⁻³ | a | 6.64×10 ⁻⁴ | 4.63×10 ⁻⁴ |
| Cesium and Strontium Capsule Processing Facility | 2035 | 2038 | 2.01×10 ⁻² | 2.75×10 ⁻³ | 1.13×10 ⁻⁴ | 3.43×10 ⁻³ | a | 1.94×10 ⁻³ | 1.04×10 ⁻³ |
| Waste receiver facilities | 2013 | 2017 | a | a | a | a | a | a | a |
| Tank risers | 2013 | 2016 | a | a | a | a | a | a | a |
| Mobile retrieval system | 2013 | 2043 | a | a | a | a | a | a | a |
| Vacuum-based retrieval system | 2013 | 2043 | a | a | a | a | a | a | a |
| Chemical wash system | 2013 | 2043 | a | a | a | a | a | a | a |
| HLW Melter Interim Storage Facility 1 | 2015 | 2016 | a | a | a | a | a | a | a |
| HLW Melter Interim Storage Facility 2 | 2029 | 2030 | a | a | a | a | a | a | a |
| Effluent Treatment Facility replacement 1 | 2023 | 2025 | 2.14×10 ⁻² | 4.02×10 ⁻³ | 1.23×10 ⁻⁴ | 3.93×10 ⁻³ | a | 2.02×10 ⁻² | 6.22×10 ⁻³ |
| Effluent Treatment Facility replacement 2 | 2053 | 2055 | 2.13×10 ⁻² | 4.00×10 ⁻³ | 1.23×10 ⁻⁴ | 3.92×10 ⁻³ | a | 2.02×10 ⁻² | 6.20×10 ⁻³ |
| Effluent Treatment Facility replacement 3 | 2083 | 2085 | 2.13×10 ⁻² | 4.00×10 ⁻³ | 1.23×10 ⁻⁴ | 3.92×10 ⁻³ | a | 2.02×10 ⁻² | 6.20×10 ⁻³ |
| Evaporator replacement 1 | 2015 | 2017 | 4.76×10 ⁻³ | 9.96×10 ⁻⁴ | 7.95×10 ⁻⁴ | 9.01×10 ⁻⁴ | a | 6.20×10 ⁻³ | 1.86×10 ⁻³ |
| Immobilized Low-Activity Waste Interim Storage Facilities | 2016 | 2043 | 4.01×10 ⁻² | 5.40×10 ⁻³ | a | a | a | 5.40×10 ⁻³ | 5.40×10 ⁻³ |
| HLW Debris Storage Facilities | 2021 | 2090 | a | a | a | a | a | a | a |
| Underground transfer line 1,000-foot sections | 2009 | 2009 | a | a | a | a | a | a | a |
| Operations | | | | | | | | | |
| IHLW Interim Storage Facility | 2018 | 2066 | a | a | a | a | a | a | a |
| Other infrastructure upgrades | 2006 | 2043 | a | a | a | a | a | a | a |
| Routine operations | 2006 | 2043 | 2.26×10 ⁻¹ | 3.42×10 ⁻² | a | a | a | 1.50×10 ⁻² | 1.04×10 ⁻² |
| Retrieval operations | 2006 | 2043 | a | a | a | a | a | a | a |
| Double-shell tank interim stabilization | 2006 | 2043 | a | a | a | a | a | a | a |
| Waste Treatment Plant | 2018 | 2043 | 1.71×10 ⁻¹ | 2.30×10 ⁻² | 9.62×10 ⁻⁴ | 2.90×10 ⁻² | a | 1.01×10 ⁻² | 7.01×10 ⁻³ |
| Waste Treatment Plant, cesium and strontium capsules | 2040 | 2040 | 1.71×10 ⁻¹ | 2.30×10 ⁻² | 9.62×10 ⁻⁴ | 2.90×10 ⁻² | a | 1.01×10 ⁻² | 7.01×10 ⁻³ |
| Cesium and Strontium Capsule Processing Facility | 2039 | 2040 | 1.76×10 ⁻² | 2.40×10 ⁻³ | 9.93×10 ⁻⁵ | 3.00×10 ⁻³ | a | 1.63×10 ⁻³ | 8.90×10 ⁻⁴ |
| Mobile retrieval system | 2013 | 2043 | a | a | a | a | a | a | a |

G-199

Appendix G - Air Quality Analysis

Table G-86. Tank Closure Alternative 6B, Option Case, Toxic Pollutant Emissions from Mobile Sources (continued)

| Facility/System | Start Year | End Year | Emission Rate (metric tons per year) | | | | | | |
|---|------------|----------|--------------------------------------|-----------------------|-----------------------|-----------------------|---------|-----------------------|-----------------------|
| | | | Ammonia | Benzene | 1,3-Butadiene | Formaldehyde | Mercury | Toluene | Xylene |
| Operations (continued) | | | | | | | | | |
| Vacuum-based retrieval system | 2013 | 2043 | a | a | a | a | a | a | a |
| Chemical wash system | 2013 | 2043 | a | a | a | a | a | a | a |
| HLW Melter Interim Storage Facility | 2018 | 2199 | a | a | a | a | a | a | a |
| Effluent Treatment Facility | 2006 | 2100 | 4.99×10 ⁻² | 8.32×10 ⁻² | 4.67×10 ⁻⁴ | 2.80×10 ⁻² | a | 1.28 | 3.61×10 ⁻¹ |
| Evaporator | 2006 | 2043 | 2.49×10 ⁻⁴ | 4.15×10 ⁻⁴ | 2.33×10 ⁻⁶ | 1.40×10 ⁻⁴ | a | 6.38×10 ⁻³ | 1.80×10 ⁻³ |
| Borrow Area C | 2006 | 2102 | a | a | a | a | a | a | a |
| Immobilized Low-Activity Waste Interim Storage Facilities | 2018 | 2199 | a | a | a | a | a | a | a |
| HLW Debris Storage Facilities | 2023 | 2199 | a | a | a | a | a | a | a |
| Deactivation | | | | | | | | | |
| Mobile retrieval system | 2013 | 2043 | a | a | a | a | a | a | a |
| Vacuum-based retrieval system | 2013 | 2043 | a | a | a | a | a | a | a |
| Chemical wash system | 2013 | 2043 | a | a | a | a | a | a | a |
| IHLW Interim Storage Facility | 2067 | 2067 | a | a | a | a | a | a | a |
| Waste Treatment Plant | 2044 | 2045 | 1.71×10 ⁻² | 2.30×10 ⁻³ | 9.62×10 ⁻⁵ | 2.90×10 ⁻³ | a | 1.01×10 ⁻³ | 7.01×10 ⁻⁴ |
| Cesium and Strontium Capsule Processing Facility | 2041 | 2041 | 8.12×10 ⁻³ | 1.12×10 ⁻³ | 4.59×10 ⁻⁵ | 1.39×10 ⁻³ | a | 8.76×10 ⁻⁴ | 4.45×10 ⁻⁴ |
| Effluent Treatment Facility original | 2026 | 2026 | 2.50×10 ⁻² | 4.16×10 ⁻² | 2.34×10 ⁻⁴ | 1.40×10 ⁻² | a | 6.39×10 ⁻¹ | 1.80×10 ⁻¹ |
| Effluent Treatment Facility replacement 1 | 2056 | 2056 | 2.50×10 ⁻² | 4.16×10 ⁻² | 2.34×10 ⁻⁴ | 1.40×10 ⁻² | a | 6.39×10 ⁻¹ | 1.80×10 ⁻¹ |
| Effluent Treatment Facility replacement 2 | 2086 | 2086 | 2.50×10 ⁻² | 4.16×10 ⁻² | 2.34×10 ⁻⁴ | 1.40×10 ⁻² | a | 6.39×10 ⁻¹ | 1.80×10 ⁻¹ |
| Effluent Treatment Facility replacement 3 | 2101 | 2101 | 2.50×10 ⁻² | 4.16×10 ⁻² | 2.34×10 ⁻⁴ | 1.40×10 ⁻² | a | 6.39×10 ⁻¹ | 1.80×10 ⁻¹ |
| Evaporator original | 2018 | 2018 | 6.10×10 ⁻⁵ | 1.02×10 ⁻⁴ | 5.70×10 ⁻⁷ | 3.42×10 ⁻⁵ | a | 1.56×10 ⁻³ | 4.40×10 ⁻⁴ |
| Evaporator replacement 1 | 2044 | 2044 | 6.10×10 ⁻⁵ | 1.02×10 ⁻⁴ | 5.70×10 ⁻⁷ | 3.42×10 ⁻⁵ | a | 1.56×10 ⁻³ | 4.40×10 ⁻⁴ |
| Closure | | | | | | | | | |
| Containment structure construction 1 | 2019 | 2022 | a | a | a | a | a | a | a |
| Containment structure construction 2 | 2046 | 2049 | a | a | a | a | a | a | a |
| Containment structure construction 3 | 2073 | 2076 | a | a | a | a | a | a | a |
| Containment structure deactivation 1 | 2043 | 2045 | a | a | a | a | a | a | a |
| Containment structure deactivation 2 | 2070 | 2072 | a | a | a | a | a | a | a |
| Containment structure deactivation 3 | 2062 | 2064 | a | a | a | a | a | a | a |
| Containment structure deactivation 4 | 2089 | 2091 | a | a | a | a | a | a | a |
| Containment structure deactivation 5 | 2097 | 2099 | a | a | a | a | a | a | a |
| Decontamination and decommissioning of 10 selected facilities | 2018 | 2028 | a | a | a | a | a | a | a |
| B tank farm removal | 2023 | 2034 | a | a | a | a | a | a | a |
| T tank farm removal | 2077 | 2088 | a | a | a | a | a | a | a |
| BY tank farm removal | 2050 | 2061 | a | a | a | a | a | a | a |

G-200

Draft Tank Closure and Waste Management Environmental Impact Statement for the Hanford Site, Richland, Washington

Table G-86. Tank Closure Alternative 6B, Option Case, Toxic Pollutant Emissions from Mobile Sources (continued)

| Facility/System | Start Year | End Year | Emission Rate (metric tons per year) | | | | | | |
|---|------------|----------|--------------------------------------|-----------------------|-----------------------|-----------------------|---------|-----------------------|-----------------------|
| | | | Ammonia | Benzene | 1,3-Butadiene | Formaldehyde | Mercury | Toluene | Xylene |
| Closure (continued) | | | | | | | | | |
| BX tank farm removal | 2023 | 2034 | a | a | a | a | a | a | a |
| C tank farm removal | 2050 | 2061 | a | a | a | a | a | a | a |
| A tank farm removal | 2077 | 2088 | a | a | a | a | a | a | a |
| AX tank farm removal | 2077 | 2088 | a | a | a | a | a | a | a |
| S tank farm removal | 2077 | 2088 | a | a | a | a | a | a | a |
| TY tank farm removal | 2050 | 2061 | a | a | a | a | a | a | a |
| TX tank farm removal | 2050 | 2061 | a | a | a | a | a | a | a |
| U tank farm removal | 2023 | 2034 | a | a | a | a | a | a | a |
| SX tank farm removal | 2023 | 2034 | a | a | a | a | a | a | a |
| B tank farm deep soil removal | 2035 | 2042 | a | a | a | a | a | a | a |
| T tank farm deep soil removal | 2089 | 2096 | a | a | a | a | a | a | a |
| BX tank farm deep soil removal | 2035 | 2042 | a | a | a | a | a | a | a |
| C tank farm deep soil removal | 2062 | 2069 | a | a | a | a | a | a | a |
| A tank farm deep soil removal | 2089 | 2096 | a | a | a | a | a | a | a |
| AX tank farm deep soil removal | 2089 | 2096 | a | a | a | a | a | a | a |
| TX tank farm deep soil removal | 2062 | 2069 | a | a | a | a | a | a | a |
| U tank farm deep soil removal | 2035 | 2042 | a | a | a | a | a | a | a |
| SX tank farm deep soil removal | 2035 | 2042 | a | a | a | a | a | a | a |
| B Area cribs and trenches (ditches) removal | 2035 | 2061 | a | a | a | a | a | a | a |
| T Area cribs and trenches (ditches) removal | 2062 | 2096 | a | a | a | a | a | a | a |
| Containment structure construction 1 | 2029 | 2032 | a | a | a | a | a | a | a |
| Containment structure construction 2 | 2056 | 2059 | a | a | a | a | a | a | a |
| Containment structure deactivation 1 | 2062 | 2064 | a | a | a | a | a | a | a |
| Containment structure deactivation 2 | 2097 | 2099 | a | a | a | a | a | a | a |
| Preprocessing Facility construction | 2020 | 2022 | 1.96×10 ¹ | 2.34×10 ⁻¹ | 9.83×10 ⁻³ | 2.97×10 ⁻¹ | a | 1.03×10 ⁻¹ | 7.16×10 ⁻² |
| Preprocessing Facility operations | 2023 | 2099 | 3.99×10 ⁻³ | 7.42×10 ⁻⁵ | 3.11×10 ⁻⁶ | 9.39×10 ⁻⁵ | a | 3.25×10 ⁻⁵ | 2.27×10 ⁻⁵ |
| Preprocessing Facility deactivation | 2100 | 2100 | 3.99×10 ⁻⁴ | 7.42×10 ⁻⁶ | 3.11×10 ⁻⁷ | 9.39×10 ⁻⁶ | a | 3.25×10 ⁻⁶ | 2.27×10 ⁻⁶ |

^a Emissions for this activity and pollutant were not calculated because annual fuel use for this activity and the resulting emissions would be small compared with other activities or would be zero.

Key: HLW=high-level radioactive waste; IHLW=immobilized high-level radioactive waste.

Source: SAIC 2007a, 2008.

Table G-87. Tank Closure Alternative 6C Criteria Pollutant Emissions from Mobile Sources

| Facility/System | Start Year | End Year | Emission Rate (metric tons per year) | | | |
|---|------------|----------|--------------------------------------|----------------------|-----------------------|-----------------------|
| | | | Carbon Monoxide | Nitrogen Dioxide | PM ₁₀ | Sulfur Dioxide |
| Construction | | | | | | |
| Canister Storage Building | 2006 | 2016 | a | a | a | a |
| IHLW Shipping/Transfer Facility | 2011 | 2013 | a | a | a | a |
| IHLW Interim Storage Modules | 2014 | 2022 | a | a | a | a |
| Other infrastructure upgrades | 2006 | 2034 | a | a | a | a |
| Tank upgrades | 2006 | 2025 | a | a | a | a |
| Waste Treatment Plant | 2006 | 2017 | 1.08×10 ¹ | 5.03×10 ¹ | 4.13×10 ² | 1.71×10 ⁻² |
| Underground transfer line 1,000-foot sections | 2009 | 2009 | a | a | a | a |
| Low-Activity Waste Vitrification Facility | 2008 | 2017 | 1.54 | 7.16 | 5.43×10 ¹ | 2.43×10 ⁻³ |
| Cesium and Strontium Capsule Processing Facility | 2035 | 2038 | 3.13 | 1.28×10 ¹ | 4.24×10 ² | 4.85×10 ⁻³ |
| Waste receiver facilities | 2013 | 2017 | a | a | a | a |
| Tank risers | 2013 | 2016 | a | a | a | a |
| Modified sluicing retrieval system | 2013 | 2043 | a | a | a | a |
| Mobile retrieval system | 2013 | 2028 | a | a | a | a |
| Vacuum-based retrieval system | 2029 | 2043 | a | a | a | a |
| HLW Melter Interim Storage Facility 1 | 2015 | 2016 | a | a | a | a |
| HLW Melter Interim Storage Facility 2 | 2029 | 2030 | a | a | a | a |
| Effluent Treatment Facility replacement 1 | 2023 | 2025 | 1.25×10 ¹ | 1.34×10 ¹ | 4.75×10 ² | 1.74×10 ⁻² |
| Evaporator replacement 1 | 2015 | 2017 | 1.16 | 2.19 | 1.41×10 ² | 1.67×10 ⁻³ |
| Immobilized Low-Activity Waste Interim Storage Facilities | 2016 | 2043 | 5.50 | 2.55×10 ¹ | 1.37×10 ² | 8.42×10 ⁻³ |
| Operations | | | | | | |
| IHLW Interim Storage Facility | 2018 | 2066 | a | a | a | a |
| Other infrastructure upgrades | 2006 | 2043 | a | a | a | a |
| Routine operations | 2006 | 2043 | 3.10×10 ¹ | 1.44×10 ² | 1.32×10 ¹ | 4.73×10 ⁻² |
| Retrieval operations | 2006 | 2043 | a | a | a | a |
| Double-shell tank interim stabilization | 2006 | 2043 | a | a | a | a |
| Waste Treatment Plant | 2018 | 2043 | 2.34×10 ¹ | 1.08×10 ² | 5.07×10 ² | 3.69×10 ⁻² |
| Waste Treatment Plant, cesium and strontium capsules | 2040 | 2040 | 2.34×10 ¹ | 1.08×10 ² | 5.07×10 ² | 3.69×10 ⁻² |
| Cesium and Strontium Capsule Processing Facility | 2039 | 2040 | 2.71 | 1.12×10 ¹ | 8.61×10 ⁻¹ | 4.20×10 ⁻³ |
| Modified sluicing retrieval system | 2013 | 2043 | a | a | a | a |
| Mobile retrieval system | 2013 | 2028 | a | a | a | a |
| Vacuum-based retrieval system | 2029 | 2043 | a | a | a | a |
| HLW Melter Interim Storage Facility | 2018 | 2145 | a | a | a | a |

Table G-87. Tank Closure Alternative 6C Criteria Pollutant Emissions from Mobile Sources (*continued*)

| Facility/System | Start Year | End Year | Emission Rate (metric tons per year) | | | |
|---|------------|----------|--------------------------------------|-----------------------|-----------------------|-----------------------|
| | | | Carbon Monoxide | Nitrogen Dioxide | PM ₁₀ | Sulfur Dioxide |
| Operations (<i>continued</i>) | | | | | | |
| Effluent Treatment Facility | 2006 | 2045 | 6.46×10 ² | 1.68×10 ¹ | 4.03×10 ² | 8.66×10 ⁻¹ |
| Evaporator | 2006 | 2043 | 3.22 | 8.38×10 ⁻² | 1.15×10 ⁻¹ | 4.32×10 ⁻³ |
| Borrow Area C | 2006 | 2052 | a | a | 4.24×10 ² | a |
| Immobilized Low-Activity Waste Interim Storage Facilities | 2018 | 2145 | a | a | a | a |
| Deactivation | | | | | | |
| IHLW Interim Storage Facility | 2067 | 2067 | a | a | a | a |
| Waste Treatment Plant | 2044 | 2045 | 2.34 | 1.08×10 ¹ | 5.07×10 ¹ | 3.69×10 ⁻³ |
| Cesium and Strontium Capsule Processing Facility | 2041 | 2041 | 1.31 | 5.16 | 3.78×10 ⁻¹ | 2.02×10 ⁻³ |
| Effluent Treatment Facility original | 2026 | 2026 | 3.23×10 ² | 8.41 | 1.95 | 4.33×10 ⁻¹ |
| Effluent Treatment Facility replacement 1 | 2046 | 2046 | 3.23×10 ² | 8.41 | 1.95 | 4.33×10 ⁻¹ |
| Evaporator original | 2018 | 2018 | 7.89×10 ⁻¹ | 2.05×10 ⁻² | 2.75 | 1.06×10 ⁻³ |
| Evaporator replacement 1 | 2044 | 2044 | 7.89×10 ⁻¹ | 2.05×10 ⁻² | 2.75 | 1.06×10 ⁻³ |
| Modified sluicing retrieval system | 2013 | 2043 | a | a | a | a |
| Mobile retrieval system | 2013 | 2028 | a | a | a | a |
| Vacuum-based retrieval system | 2029 | 2043 | a | a | a | a |
| Closure | | | | | | |
| Ancillary equipment grouting | 2013 | 2037 | a | a | a | a |
| Ancillary equipment removal | 2032 | 2037 | a | a | a | a |
| Decontamination and decommissioning of 10 selected facilities | 2018 | 2028 | a | a | a | a |
| Tank-filling grout facility construction | 2032 | 2033 | a | a | a | a |
| Tank-filling grout facility operations | 2034 | 2043 | a | a | a | a |
| Tank-filling grout facility deactivation | 2044 | 2044 | a | a | a | a |
| Containment structure construction | 2028 | 2031 | a | a | a | a |
| BX and SX tank farm soil removal | 2032 | 2037 | a | a | a | a |
| Containment structure deactivation | 2038 | 2040 | a | a | a | a |
| Modified Resource Conservation and Recovery Act Subtitle C barrier construction | 2039 | 2045 | 1.70×10 ¹ | 7.88×10 ¹ | 6.68×10 ² | 2.68×10 ⁻² |
| Postclosure care | 2046 | 2145 | a | a | a | a |

^a Emissions for this activity and pollutant were not calculated because annual fuel use for this activity and the resulting emissions would be small compared with other activities or would be zero.

Key: HLW=high-level radioactive waste; IHLW=immobilized high-level radioactive waste; PM₁₀=particulate matter with an aerodynamic diameter less than or equal to 10 micrometers.

Source: SAIC 2007a, 2008.

Table G-88. Tank Closure Alternative 6C Toxic Pollutant Emissions from Mobile Sources

| Facility/System | Start Year | End Year | Emission Rate (metric tons per year) | | | | | | |
|---|------------|----------|--------------------------------------|-----------------------|-----------------------|-----------------------|---------|-----------------------|-----------------------|
| | | | Ammonia | Benzene | 1,3-Butadiene | Formaldehyde | Mercury | Toluene | Xylene |
| Construction | | | | | | | | | |
| Canister Storage Building | 2006 | 2016 | a | a | a | a | a | a | a |
| IHLW Shipping/Transfer Facility | 2011 | 2013 | a | a | a | a | a | a | a |
| IHLW Interim Storage Modules | 2014 | 2022 | a | a | a | a | a | a | a |
| Other infrastructure upgrades | 2006 | 2034 | a | a | a | a | a | a | a |
| Tank upgrades | 2006 | 2025 | a | a | a | a | a | a | a |
| Waste Treatment Plant | 2006 | 2017 | 7.91×10 ⁻² | 1.06×10 ⁻² | 4.46×10 ⁻⁴ | 2.24×10 ⁻² | a | 4.66×10 ⁻³ | 3.25×10 ⁻³ |
| Underground transfer line 1,000-foot sections | 2009 | 2009 | a | a | a | a | a | a | a |
| Low-Activity Waste Vitrification Facility | 2008 | 2017 | 1.13×10 ⁻² | 1.51×10 ⁻³ | 6.35×10 ⁻⁵ | 1.92×10 ⁻³ | a | 6.64×10 ⁻⁴ | 4.63×10 ⁻⁴ |
| Cesium and Strontium Capsule Processing Facility | 2035 | 2038 | 2.01×10 ⁻² | 2.75×10 ⁻³ | 1.13×10 ⁻⁴ | 3.43×10 ⁻³ | a | 1.94×10 ⁻³ | 1.04×10 ⁻³ |
| Waste receiver facilities | 2013 | 2017 | a | a | a | a | a | a | a |
| Tank risers | 2013 | 2016 | a | a | a | a | a | a | a |
| Modified sluicing retrieval system | 2013 | 2043 | a | a | a | a | a | a | a |
| Mobile retrieval system | 2013 | 2028 | a | a | a | a | a | a | a |
| Vacuum-based retrieval system | 2029 | 2043 | a | a | a | a | a | a | a |
| HLW Melter Interim Storage Facility 1 | 2015 | 2016 | a | a | a | a | a | a | a |
| HLW Melter Interim Storage Facility 2 | 2029 | 2030 | a | a | a | a | a | a | a |
| Effluent Treatment Facility replacement 1 | 2023 | 2025 | 2.14×10 ⁻² | 4.02×10 ⁻³ | 1.23×10 ⁻⁴ | 3.93×10 ⁻³ | a | 2.02×10 ⁻² | 6.22×10 ⁻³ |
| Evaporator replacement 1 | 2015 | 2017 | 3.46×10 ⁻³ | 5.48×10 ⁻⁴ | 1.81×10 ⁻⁴ | 6.10×10 ⁻⁴ | a | 1.58×10 ⁻³ | 5.29×10 ⁻⁴ |
| Immobilized Low-Activity Waste Interim Storage Facilities | 2016 | 2043 | 4.01×10 ⁻² | 5.40×10 ⁻³ | a | a | a | 5.40×10 ⁻³ | 5.40×10 ⁻³ |
| Operations | | | | | | | | | |
| IHLW Interim Storage Facility | 2018 | 2066 | a | a | a | a | a | a | a |
| Other infrastructure upgrades | 2006 | 2043 | a | a | a | a | a | a | a |
| Routine operations | 2006 | 2043 | 2.26×10 ⁻¹ | 3.42×10 ⁻² | a | a | a | 1.50×10 ⁻² | 1.04×10 ⁻² |
| Retrieval operations | 2006 | 2043 | a | a | a | a | a | a | a |
| Double-shell tank interim stabilization | 2006 | 2043 | a | a | a | a | a | a | a |
| Waste Treatment Plant | 2018 | 2043 | 1.71×10 ⁻¹ | 2.30×10 ⁻² | 9.62×10 ⁻⁴ | 2.90×10 ⁻² | a | 1.01×10 ⁻² | 7.01×10 ⁻³ |
| Waste Treatment Plant, cesium and strontium capsules | 2040 | 2040 | 1.71×10 ⁻¹ | 2.30×10 ⁻² | 9.62×10 ⁻⁴ | 2.90×10 ⁻² | a | 1.01×10 ⁻² | 7.01×10 ⁻³ |

G-204

Draft Tank Closure and Waste Management Environmental Impact Statement for the Hanford Site, Richland, Washington

Table G–88. Tank Closure Alternative 6C Toxic Pollutant Emissions from Mobile Sources (continued)

| Facility/System | Start Year | End Year | Emission Rate (metric tons per year) | | | | | | |
|---|------------|----------|--------------------------------------|-----------------------|-----------------------|-----------------------|---------|-----------------------|-----------------------|
| | | | Ammonia | Benzene | 1,3-Butadiene | Formaldehyde | Mercury | Toluene | Xylene |
| Operations (continued) | | | | | | | | | |
| Cesium and Strontium Capsule Processing Facility | 2039 | 2040 | 1.76×10 ⁻² | 2.40×10 ⁻³ | 9.93×10 ⁻⁵ | 3.00×10 ⁻³ | a | 1.63×10 ⁻³ | 8.90×10 ⁻⁴ |
| Modified sluicing retrieval system | 2013 | 2043 | a | a | a | a | a | a | a |
| Mobile retrieval system | 2013 | 2028 | a | a | a | a | a | a | a |
| Vacuum-based retrieval system | 2029 | 2043 | a | a | a | a | a | a | a |
| HLW Melter Interim Storage Facility | 2018 | 2145 | a | a | a | a | a | a | a |
| Effluent Treatment Facility | 2006 | 2045 | 4.99×10 ⁻² | 8.32×10 ⁻² | 4.67×10 ⁻⁴ | 2.80×10 ⁻² | a | 1.28 | 3.61×10 ⁻¹ |
| Evaporator | 2006 | 2043 | 2.49×10 ⁻⁴ | 4.15×10 ⁻⁴ | 2.33×10 ⁻⁶ | 1.40×10 ⁻⁴ | a | 6.38×10 ⁻³ | 1.80×10 ⁻³ |
| Borrow Area C | 2006 | 2052 | a | a | a | a | a | a | a |
| Immobilized Low-Activity Waste Interim Storage Facilities | 2018 | 2145 | a | a | a | a | a | a | a |
| Deactivation | | | | | | | | | |
| IHLW Interim Storage Facility | 2067 | 2067 | a | a | a | a | a | a | a |
| Waste Treatment Plant | 2044 | 2045 | 1.71×10 ⁻² | 2.30×10 ⁻³ | 9.62×10 ⁻⁵ | 2.90×10 ⁻³ | a | 1.01×10 ⁻³ | 7.01×10 ⁻⁴ |
| Cesium and Strontium Capsule Processing Facility | 2041 | 2041 | 8.12×10 ⁻³ | 1.12×10 ⁻³ | 4.59×10 ⁻⁵ | 1.39×10 ⁻³ | a | 8.76×10 ⁻⁴ | 4.45×10 ⁻⁴ |
| Effluent Treatment Facility original | 2026 | 2026 | 2.50×10 ⁻² | 4.16×10 ⁻² | 2.34×10 ⁻⁴ | 1.40×10 ⁻² | a | 6.40×10 ⁻¹ | 1.81×10 ⁻¹ |
| Effluent Treatment Facility replacement 1 | 2046 | 2046 | 2.50×10 ⁻² | 4.16×10 ⁻² | 2.34×10 ⁻⁴ | 1.40×10 ⁻² | a | 6.40×10 ⁻¹ | 1.81×10 ⁻¹ |
| Evaporator original | 2018 | 2018 | 6.10×10 ⁻⁵ | 1.02×10 ⁻⁴ | 5.70×10 ⁻⁷ | 3.42×10 ⁻⁵ | a | 1.56×10 ⁻³ | 4.40×10 ⁻⁴ |
| Evaporator replacement 1 | 2044 | 2044 | 6.10×10 ⁻⁵ | 1.02×10 ⁻⁴ | 5.70×10 ⁻⁷ | 3.42×10 ⁻⁵ | a | 1.56×10 ⁻³ | 4.40×10 ⁻⁴ |
| Modified sluicing retrieval system | 2013 | 2043 | a | a | a | a | a | a | a |
| Mobile retrieval system | 2013 | 2028 | a | a | a | a | a | a | a |
| Vacuum-based retrieval system | 2029 | 2043 | a | a | a | a | a | a | a |
| Closure | | | | | | | | | |
| Ancillary equipment grouting | 2013 | 2037 | a | a | a | a | a | a | a |
| Ancillary equipment removal | 2032 | 2037 | a | a | a | a | a | a | a |
| Decontamination and decommissioning of 10 selected facilities | 2018 | 2028 | a | a | a | a | a | a | a |
| Tank-filling grout facility construction | 2032 | 2033 | a | a | a | a | a | a | a |
| Tank-filling grout facility operations | 2034 | 2043 | a | a | a | a | a | a | a |
| Tank-filling grout facility deactivation | 2044 | 2044 | a | a | a | a | a | a | a |
| Containment structure construction | 2028 | 2031 | a | a | a | a | a | a | a |
| BX and SX tank farm soil removal | 2032 | 2037 | a | a | a | a | a | a | a |

Table G-88. Tank Closure Alternative 6C Toxic Pollutant Emissions from Mobile Sources (continued)

| Facility/System | Start Year | End Year | Emission Rate (metric tons per year) | | | | | | |
|---|------------|----------|--------------------------------------|-----------------------|-----------------------|-----------------------|---------|-----------------------|-----------------------|
| | | | Ammonia | Benzene | 1,3-Butadiene | Formaldehyde | Mercury | Toluene | Xylene |
| Closure (continued) | | | | | | | | | |
| Containment structure deactivation | 2038 | 2040 | a | a | a | a | a | a | a |
| Modified Resource Conservation and Recovery Act Subtitle C barrier construction | 2039 | 2045 | 1.24×10 ⁻¹ | 3.10×10 ⁻¹ | 1.30×10 ⁻² | 3.92×10 ⁻¹ | a | 1.36×10 ⁻¹ | 9.47×10 ⁻² |
| Postclosure care | 2046 | 2145 | a | a | a | a | a | a | a |

^a Emissions for this activity and pollutant were not calculated because annual fuel use for this activity and the resulting emissions would be small compared with other activities or would be zero.

Key: HLW=high-level radioactive waste; IHLW=immobilized high-level radioactive waste.

Source: SAIC 2007a, 2008.

Table G–89. FFTF Decommissioning Alternative 1 Criteria Pollutant Emissions from Mobile Sources

| Facility/System | Start Year | End Year | Emission Rate from Mobile Sources (metric tons per year) | | | |
|-------------------------|------------|----------|--|------------------|-----------------------|----------------|
| | | | Carbon Monoxide | Nitrogen Dioxide | PM ₁₀ | Sulfur Dioxide |
| Deactivation | | | | | | |
| Administrative controls | 2008 | 2107 | a | a | 3.14×10 ⁻¹ | a |

^a Emissions for this activity and pollutant were not calculated because annual fuel use for this activity and the resulting emissions would be small compared with other activities or would be zero.

Key: FFTF=Fast Flux Test Facility; PM₁₀=particulate matter with an aerodynamic diameter less than or equal to 10 micrometers.

Source: SAIC 2007b.

Table G–90. FFTF Decommissioning Alternative 1 Toxic Pollutant Emissions from Mobile Sources

| Facility/System | Start Year | End Year | Emission Rate (metric tons per year) | | | | | | |
|-------------------------|------------|----------|--------------------------------------|---------|---------------|--------------|---------|---------|--------|
| | | | Ammonia | Benzene | 1,3-Butadiene | Formaldehyde | Mercury | Toluene | Xylene |
| Deactivation | | | | | | | | | |
| Administrative controls | 2008 | 2107 | a | a | a | a | a | a | a |

^a Emissions for this activity and pollutant were not calculated because annual fuel use for this activity and the resulting emissions would be small compared with other activities or would be zero.

Key: FFTF=Fast Flux Test Facility.

Source: SAIC 2007b.

Table G-91. FFTF Decommissioning Alternative 2 Criteria Pollutant Emissions from Mobile Sources

| Facility/System | Start Year | End Year | Emission Rate (metric tons per year) | | | |
|--|------------|----------|--------------------------------------|-----------------------|-----------------------|-----------------------|
| | | | Carbon Monoxide | Nitrogen Dioxide | PM ₁₀ | Sulfur Dioxide |
| Decommissioning | | | | | | |
| Above-grade structure and equipment removal | 2013 | 2020 | 4.38×10 ⁻¹ | 2.03 | 8.25×10 ² | 6.91×10 ⁻⁴ |
| Backfill of Reactor Containment Building with grout | 2017 | 2017 | 3.32×10 ⁻³ | 1.54×10 ⁻² | 1.48×10 ⁻¹ | 5.24×10 ⁻⁶ |
| Backfill of Buildings 491 East and West with grout | 2017 | 2017 | a | a | a | a |
| Grout facility construction | 2016 | 2016 | a | a | a | a |
| Grout facility operations | 2017 | 2017 | a | a | 2.18×10 ¹ | a |
| Grout facility deactivation | 2018 | 2018 | a | a | a | a |
| Nonhazardous waste transportation | 2013 | 2020 | a | a | 6.88×10 ⁻² | a |
| Construction | | | | | | |
| Hanford Site Sodium Reaction Facility | 2015 | 2016 | a | a | 3.24 | a |
| Hanford Site Remote Treatment Project | 2015 | 2016 | 4.45×10 ¹ | 3.20 | 8.28×10 ¹ | 5.97×10 ⁻² |
| Idaho National Laboratory Sodium Processing Facility | 2014 | 2014 | 8.83 | 1.28 | 8.78×10 ⁻² | 1.19×10 ⁻² |
| Idaho National Laboratory Remote Treatment Project | 2015 | 2016 | 4.42×10 ¹ | 3.19 | 2.14×10 ⁻¹ | 5.92×10 ⁻² |
| Operations | | | | | | |
| Hanford Site sodium preparation | 2017 | 2017 | 3.44 | 6.96×10 ⁻¹ | 2.00×10 ⁻¹ | 4.65×10 ⁻³ |
| Hanford Site Sodium Reaction Facility | 2017 | 2018 | 1.71×10 ⁻² | 7.96×10 ⁻² | 3.19×10 ⁻² | 2.71×10 ⁻⁵ |
| Hanford Site Remote Treatment Project | 2017 | 2017 | 2.05×10 ⁻³ | 9.53×10 ⁻³ | 6.92×10 ⁻² | 3.25×10 ⁻⁶ |
| Idaho National Laboratory sodium production | 2015 | 2015 | 3.44 | 6.96×10 ⁻¹ | 4.81×10 ⁻² | 4.65×10 ⁻³ |
| Idaho National Laboratory Sodium Processing Facility | 2015 | 2016 | 7.66×10 ⁻¹ | 3.56 | 2.50×10 ⁻¹ | 1.21×10 ⁻³ |
| Idaho National Laboratory Remote Treatment Project | 2017 | 2017 | 5.45×10 ⁻² | 2.53×10 ⁻¹ | 1.78×10 ⁻² | 8.60×10 ⁻⁵ |
| Deactivation | | | | | | |
| Hanford Site Sodium Reaction Facility | 2019 | 2019 | a | a | a | a |
| Hanford Site Remote Treatment Project | 2018 | 2018 | 1.03×10 ⁻³ | 4.76×10 ⁻³ | 3.46×10 ⁻² | 1.62×10 ⁻⁶ |
| Idaho National Laboratory Sodium Processing Facility | 2016 | 2016 | a | a | a | a |
| Idaho National Laboratory Remote Treatment Project | 2018 | 2018 | 1.03×10 ⁻³ | 4.76×10 ⁻³ | 3.35×10 ⁻⁴ | 1.62×10 ⁻⁶ |
| Closure | | | | | | |
| Site regrading | 2021 | 2021 | a | a | 1.45×10 ² | a |
| Site revegetation | 2021 | 2021 | a | a | a | a |
| Modified Resource Conservation and Recovery Act Subtitle C barrier construction | 2021 | 2021 | a | a | 1.84×10 ¹ | a |
| Postclosure care | 2022 | 2121 | a | a | a | a |

^a Emissions for this activity and pollutant were not calculated because annual fuel use for this activity and the resulting emissions would be small compared with other activities or would be zero.

Key: FFTF=Fast Flux Test Facility; PM₁₀=particulate matter with an aerodynamic diameter less than or equal to 10 micrometers.

Source: SAIC 2007b.

Table G-92. FFTF Decommissioning Alternative 2 Toxic Pollutant Emissions from Mobile Sources

| Facility/System | Start Year | End Year | Emission Rate (metric tons per year) | | | | | | |
|---|------------|----------|--------------------------------------|-----------------------|-----------------------|-----------------------|---------|-----------------------|-----------------------|
| | | | Ammonia | Benzene | 1,3-Butadiene | Formaldehyde | Mercury | Toluene | Xylene |
| Decommissioning | | | | | | | | | |
| Above-grade structure and equipment removal | 2013 | 2020 | 3.19×10^{-3} | 4.30×10^{-4} | 1.80×10^{-5} | 5.44×10^{-4} | a | 1.88×10^{-4} | 1.31×10^{-4} |
| Backfill of Reactor Containment Building with grout | 2017 | 2017 | 2.42×10^{-5} | 3.26×10^{-6} | 1.37×10^{-7} | 4.12×10^{-6} | a | 1.43×10^{-6} | 9.95×10^{-7} |
| Backfill of Buildings 491 East and West with grout | 2017 | 2017 | a | a | a | a | a | a | a |
| Grout facility construction | 2016 | 2016 | a | a | a | a | a | a | a |
| Grout facility operations | 2017 | 2017 | a | a | a | a | a | a | a |
| Grout facility deactivation | 2018 | 2018 | a | a | a | a | a | a | a |
| Nonhazardous waste transportation | 2013 | 2020 | a | a | a | a | a | a | a |
| Construction | | | | | | | | | |
| Hanford Site Sodium Reaction Facility | 2015 | 2016 | a | a | a | a | a | a | a |
| Hanford Site Remote Treatment Project | 2015 | 2016 | 6.62×10^{-3} | 6.12×10^{-3} | 4.99×10^{-5} | 2.45×10^{-3} | a | 1.32×10^{-3} | 2.47×10^{-2} |
| Idaho National Laboratory Sodium Processing Facility | 2014 | 2014 | 2.32×10^{-3} | 1.33×10^{-3} | 1.56×10^{-5} | 6.55×10^{-4} | a | 1.71×10^{-2} | 4.87×10^{-3} |
| Idaho National Laboratory Remote Treatment Project | 2015 | 2016 | 6.60×10^{-3} | 6.06×10^{-3} | 4.99×10^{-5} | 2.45×10^{-3} | a | 8.66×10^{-2} | 2.45×10^{-2} |
| Operations | | | | | | | | | |
| Hanford Site sodium preparation | 2017 | 2017 | 1.21×10^{-3} | 5.55×10^{-4} | 3.07×10^{-4} | 7.80×10^{-6} | a | 6.61×10^{-3} | 1.89×10^{-3} |
| Hanford Site Sodium Reaction Facility | 2017 | 2018 | 1.81×10^{-5} | 1.68×10^{-5} | 7.06×10^{-7} | 2.13×10^{-5} | a | 7.38×10^{-6} | 5.14×10^{-6} |
| Hanford Site Remote Treatment Project | 2017 | 2017 | 1.50×10^{-5} | 2.01×10^{-6} | 1.50×10^{-4} | 6.89×10^{-3} | a | 8.85×10^{-7} | 6.16×10^{-7} |
| Idaho National Laboratory sodium production | 2015 | 2015 | 1.21×10^{-3} | 5.55×10^{-4} | 3.07×10^{-4} | 7.80×10^{-6} | a | 6.61×10^{-3} | 1.89×10^{-3} |
| Idaho National Laboratory Sodium Processing Facility | 2015 | 2016 | a | 7.52×10^{-4} | 3.15×10^{-5} | 9.51×10^{-4} | a | 3.30×10^{-4} | 2.30×10^{-4} |
| Idaho National Laboratory Remote Treatment Project | 2017 | 2017 | 3.97×10^{-4} | 5.35×10^{-5} | 1.25×10^{-6} | 3.78×10^{-5} | a | 2.35×10^{-5} | 1.63×10^{-5} |
| Deactivation | | | | | | | | | |
| Hanford Site Sodium Reaction Facility | 2019 | 2019 | a | a | a | a | a | a | a |
| Hanford Site Remote Treatment Project | 2018 | 2018 | 7.48×10^{-6} | 1.01×10^{-6} | 3.74×10^{-8} | 1.13×10^{-6} | a | 4.42×10^{-7} | 3.08×10^{-7} |
| Idaho National Laboratory Sodium Processing Facility | 2016 | 2016 | a | a | a | a | a | a | a |
| Idaho National Laboratory Remote Treatment Project | 2018 | 2018 | 7.48×10^{-6} | 1.01×10^{-6} | 3.74×10^{-8} | 1.13×10^{-6} | a | 4.42×10^{-7} | 3.08×10^{-7} |
| Closure | | | | | | | | | |
| Site regrading | 2021 | 2021 | a | a | a | a | a | a | a |
| Site revegetation | 2021 | 2021 | a | a | a | a | a | a | a |
| Modified Resource Conservation and Recovery Act Subtitle C barrier construction | 2021 | 2021 | a | a | a | a | a | a | a |
| Postclosure care | 2022 | 2121 | a | a | a | a | a | a | a |

^a Emissions for this activity and pollutant were not calculated because annual fuel use for this activity and the resulting emissions would be small compared with other activities or would be zero.

Key: FFTF=Fast Flux Test Facility.

Source: SAIC 2007b.

Table G-93. FFTF Decommissioning Alternative 3 Criteria Pollutant Emissions from Mobile Sources

| Facility/System | Start Year | End Year | Emission Rate (metric tons per year) | | | |
|---|------------|----------|--------------------------------------|-----------------------|-----------------------|-----------------------|
| | | | Carbon Monoxide | Nitrogen Dioxide | PM ₁₀ | Sulfur Dioxide |
| Decommissioning | | | | | | |
| Above-grade structure and equipment removal | 2013 | 2020 | 4.38×10^{-1} | 2.03 | 8.25×10^2 | 6.91×10^{-4} |
| Removal of Reactor Containment Building below-grade vessels, piping, and components | 2013 | 2014 | 1.35×10^{-2} | 6.28×10^{-2} | 4.84×10^{-1} | 2.14×10^{-5} |
| Grout facility construction | 2012 | 2012 | a | a | a | a |
| Grout facility operations | 2013 | 2014 | a | a | 2.18×10^1 | a |
| Grout facility deactivation | 2015 | 2015 | a | a | a | a |
| Nonhazardous waste transportation | 2013 | 2020 | a | a | 6.88×10^{-2} | a |
| Construction | | | | | | |
| Hanford Site Sodium Reaction Facility | 2015 | 2016 | a | a | 3.24 | a |
| Hanford Site Remote Treatment Project | 2015 | 2016 | a | a | 8.28×10^1 | a |
| Idaho National Laboratory Sodium Processing Facility | 2014 | 2014 | 8.83 | 1.28 | 8.78×10^{-2} | 1.19×10^{-2} |
| Idaho National Laboratory Remote Treatment Project | 2015 | 2016 | 4.42×10^1 | 3.19 | 2.14×10^{-1} | 5.92×10^{-2} |
| Operations | | | | | | |
| Hanford Site sodium preparation | 2017 | 2017 | 3.44 | 6.96×10^{-1} | 2.00×10^{-1} | 4.65×10^{-3} |
| Hanford Site Sodium Reaction Facility | 2017 | 2018 | 1.71×10^{-2} | 7.96×10^{-2} | 3.19×10^{-2} | 2.71×10^{-5} |
| Hanford Site Remote Treatment Project | 2017 | 2017 | 2.05×10^{-3} | 9.53×10^{-3} | 6.92×10^{-2} | 3.25×10^{-6} |
| Idaho National Laboratory sodium preparation | 2015 | 2015 | 3.44 | 6.96×10^{-1} | 4.81×10^{-2} | 4.65×10^{-3} |
| Idaho National Laboratory Sodium Processing Facility | 2015 | 2016 | 7.66×10^{-1} | 3.56 | 2.50×10^{-1} | 1.21×10^{-3} |
| Idaho National Laboratory Remote Treatment Project | 2017 | 2017 | 5.45×10^{-2} | 2.53×10^{-1} | 1.78×10^{-2} | 8.60×10^{-5} |
| Deactivation | | | | | | |
| Hanford Site Sodium Reaction Facility | 2019 | 2019 | 1.03×10^{-3} | 4.76×10^{-3} | 3.46×10^{-2} | 1.62×10^{-6} |
| Hanford Site Remote Treatment Project | 2018 | 2018 | a | a | 2.18×10^2 | a |
| Idaho National Laboratory Sodium Processing Facility | 2016 | 2016 | a | a | a | a |
| Idaho National Laboratory Remote Treatment Project | 2018 | 2018 | 1.03×10^{-3} | 4.76×10^{-3} | 3.35×10^{-4} | 1.62×10^{-6} |
| Closure | | | | | | |
| Site regrading | 2018 | 2018 | a | a | 2.18×10^2 | a |
| Site revegetation | 2018 | 2018 | a | a | a | a |
| Postclosure care | 2022 | 2121 | a | a | a | a |

^a Emissions for this activity and pollutant were not calculated because annual fuel use for this activity and the resulting emissions would be small compared with other activities or would be zero.

Key: FFTF=Fast Flux Test Facility; PM₁₀=particulate matter with an aerodynamic diameter less than or equal to 10 micrometers.

Source: SAIC 2007b.

Table G-94. FFTF Decommissioning Alternative 3 Toxic Pollutant Emissions from Mobile Sources

| Facility/System | Start Year | End Year | Emission Rate (metric tons per year) | | | | | | |
|---|------------|----------|--------------------------------------|-----------------------|-----------------------|-----------------------|---------|-----------------------|-----------------------|
| | | | Ammonia | Benzene | 1,3-Butadiene | Formaldehyde | Mercury | Toluene | Xylene |
| Decommissioning | | | | | | | | | |
| Above-grade structure and equipment removal | 2013 | 2020 | 3.19×10 ⁻³ | 4.30×10 ⁻⁴ | 1.80×10 ⁻⁵ | 5.44×10 ⁻⁴ | a | 1.88×10 ⁻⁴ | 1.31×10 ⁻⁴ |
| Removal of Reactor Containment Building below-grade vessels, piping, and components | 2013 | 2014 | 9.88×10 ⁻⁵ | 1.33×10 ⁻⁵ | 5.57×10 ⁻⁷ | 1.68×10 ⁻⁵ | a | 5.82×10 ⁻⁶ | 4.06×10 ⁻⁶ |
| Grout facility construction | 2012 | 2012 | a | a | a | a | a | a | a |
| Grout facility operations | 2013 | 2014 | a | a | a | a | a | a | a |
| Grout facility deactivation | 2015 | 2015 | a | a | a | a | a | a | a |
| Nonhazardous waste transportation | 2013 | 2020 | a | a | a | a | a | a | a |
| Construction | | | | | | | | | |
| Hanford Site Sodium Reaction Facility | 2015 | 2016 | a | a | a | a | a | a | a |
| Hanford Site Remote Treatment Project | 2015 | 2016 | 6.62×10 ⁻³ | 6.12×10 ⁻³ | 4.99×10 ⁻⁵ | 2.45×10 ⁻³ | a | 1.32×10 ⁻³ | 2.47×10 ⁻² |
| Idaho National Laboratory Sodium Processing Facility | 2014 | 2014 | 2.32×10 ⁻³ | 1.33×10 ⁻³ | 1.56×10 ⁻⁵ | 6.55×10 ⁻⁴ | a | 1.71×10 ⁻² | 4.87×10 ⁻³ |
| Idaho National Laboratory Remote Treatment Project | 2015 | 2016 | 6.60×10 ⁻³ | 6.06×10 ⁻³ | 4.99×10 ⁻⁵ | 2.45×10 ⁻³ | a | 8.66×10 ⁻² | 2.45×10 ⁻² |
| Operations | | | | | | | | | |
| Hanford Site sodium preparation | 2017 | 2017 | 1.21×10 ⁻³ | 5.55×10 ⁻⁴ | 3.07×10 ⁻⁴ | 7.80×10 ⁻⁶ | a | 6.61×10 ⁻³ | 1.89×10 ⁻³ |
| Hanford Site Sodium Reaction Facility | 2017 | 2018 | 1.81×10 ⁻⁵ | 1.68×10 ⁻⁵ | 7.06×10 ⁻⁷ | 2.13×10 ⁻⁵ | a | 7.38×10 ⁻⁶ | 5.14×10 ⁻⁶ |
| Hanford Site Remote Treatment Project | 2017 | 2017 | 1.50×10 ⁻⁵ | 2.01×10 ⁻⁶ | 1.50×10 ⁻⁴ | 6.89×10 ⁻³ | a | 8.85×10 ⁻⁷ | 6.16×10 ⁻⁷ |
| Idaho National Laboratory sodium preparation | 2015 | 2015 | 1.21×10 ⁻³ | 5.55×10 ⁻⁴ | 3.07×10 ⁻⁴ | 7.80×10 ⁻⁶ | a | 6.61×10 ⁻³ | 1.89×10 ⁻³ |
| Idaho National Laboratory Sodium Processing Facility | 2015 | 2016 | a | 7.52×10 ⁻⁴ | 3.15×10 ⁻⁵ | 9.51×10 ⁻⁴ | a | 3.30×10 ⁻⁴ | 2.30×10 ⁻⁴ |
| Idaho National Laboratory Remote Treatment Project | 2017 | 2017 | 3.97×10 ⁻⁴ | 5.35×10 ⁻⁵ | 1.25×10 ⁻⁶ | 3.78×10 ⁻⁵ | a | 2.35×10 ⁻⁵ | 1.63×10 ⁻⁵ |
| Deactivation | | | | | | | | | |
| Hanford Site Sodium Reaction Facility | 2019 | 2019 | a | a | a | a | a | a | a |
| Hanford Site Remote Treatment Project | 2018 | 2018 | 7.48×10 ⁻⁶ | 1.01×10 ⁻⁶ | 3.74×10 ⁻⁸ | 1.13×10 ⁻⁶ | a | 4.42×10 ⁻⁷ | 3.08×10 ⁻⁷ |
| Idaho National Laboratory Sodium Processing Facility | 2016 | 2016 | a | a | a | a | a | a | a |
| Idaho National Laboratory Remote Treatment Project | 2018 | 2018 | 7.48×10 ⁻⁶ | 1.01×10 ⁻⁶ | 3.74×10 ⁻⁸ | 1.13×10 ⁻⁶ | a | 4.42×10 ⁻⁷ | 3.08×10 ⁻⁷ |
| Closure | | | | | | | | | |
| Site regrading | 2018 | 2018 | a | a | a | a | a | a | a |
| Site revegetation | 2018 | 2018 | a | a | a | a | a | a | a |
| Postclosure care | 2022 | 2121 | a | a | a | a | a | a | a |

^a Emissions for this activity and pollutant were not calculated because annual fuel use for this activity and the resulting emissions would be small compared with other activities or would be zero.

Key: FFTF=Fast Flux Test Facility.

Source: SAIC 2007c.

Table G-95. Waste Management Alternative 1 Criteria Pollutant Emissions from Mobile Sources

| Facility/System | Start Year | End Year | Emission Rate (metric tons per year) | | | |
|--|------------|----------|--------------------------------------|------------------|-----------------------|-----------------------|
| | | | Carbon Monoxide | Nitrogen Dioxide | PM ₁₀ | Sulfur Dioxide |
| Operations | | | | | | |
| Low-level radioactive waste burial grounds | 2007 | 2035 | a | a | 2.61 | a |
| Deactivation | | | | | | |
| Integrated Disposal Facility | 2009 | 2009 | a | a | 2.92×10 ² | a |
| Postclosure care | 2036 | 2135 | 1.27×10 ¹ | 4.89 | 6.13×10 ⁻¹ | 1.72×10 ⁻² |

^a Emissions for this activity and pollutant were not calculated because annual fuel use for this activity and the resulting emissions would be small compared with other activities or would be zero.

Key: PM₁₀=particulate matter with an aerodynamic diameter less than or equal to 10 micrometers.

Source: SAIC 2007c.

Table G-96. Waste Management Alternative 1 Toxic Pollutant Emissions from Mobile Sources

| Facility/System | Start Year | End Year | Emission Rate (metric tons per year) | | | | | | |
|--|------------|----------|--------------------------------------|---------|---------------|--------------|---------|---------|--------|
| | | | Ammonia | Benzene | 1,3-Butadiene | Formaldehyde | Mercury | Toluene | Xylene |
| Operations | | | | | | | | | |
| Low-level radioactive waste burial grounds | 2007 | 2035 | a | a | a | a | a | a | a |
| Deactivation | | | | | | | | | |
| Integrated Disposal Facility | 2009 | 2009 | a | a | a | a | a | a | a |
| Postclosure care | 2036 | 2135 | a | a | a | a | a | a | a |

^a Emissions for this activity and pollutant were not calculated because annual fuel use for this activity and the resulting emissions would be small compared with other activities or would be zero.

Source: SAIC 2007c.

Table G-97. Waste Management Alternative 2 (Treatment and Storage) Criteria Pollutant Emissions from Mobile Sources

| Facility/System | Start Year | End Year | Emission Rate (metric tons per year) | | | |
|---|------------|----------|--------------------------------------|-----------------------|----------------------|-----------------------|
| | | | Carbon Monoxide | Nitrogen Dioxide | PM ₁₀ | Sulfur Dioxide |
| Construction | | | | | | |
| T Plant complex expansion | 2011 | 2012 | 1.84 | 6.15 | 3.80×10 ¹ | 2.79×10 ⁻³ |
| Contact-Handled Mixed TRU/TRU waste facility (WRAP expansion) | 2011 | 2012 | 8.89 | 1.47×10 ¹ | 4.28×10 ² | 1.27×10 ⁻² |
| Remote-Handled Mixed TRU/TRU waste facility (WRAP expansion) | 2013 | 2018 | 4.23 | 3.53 | 7.67×10 ² | 5.84×10 ⁻³ |
| Central Waste Complex expansion | 2011 | 2012 | 2.98 | 4.94 | 1.44×10 ² | 4.25×10 ⁻³ |
| Operations | | | | | | |
| T Plant complex expansion | 2013 | 2050 | 9.93×10 ³ | 2.58×10 ² | 1.36×10 ⁴ | 1.33×10 ¹ |
| Contact-Handled Mixed TRU/TRU waste facility (WRAP expansion) | 2013 | 2050 | 7.69 | 2.00×10 ⁻¹ | 1.10×10 ⁴ | 1.03×10 ⁻² |
| Remote-Handled Mixed TRU/TRU waste facility (WRAP expansion) | 2019 | 2050 | 3.14 | 8.16×10 ⁻² | 3.12×10 ³ | 4.20×10 ⁻³ |
| Central Waste Complex expansion | 2013 | 2050 | 3.19 | 8.28×10 ⁻² | 5.11×10 ² | 4.27×10 ⁻³ |
| Deactivation | | | | | | |
| T Plant complex expansion | 2051 | 2051 | 7.48 | 9.89 | 6.64 | 1.05×10 ⁻² |
| Contact-Handled Mixed TRU/TRU waste facility (WRAP expansion) | 2051 | 2051 | 4.71 | 1.22×10 ⁻¹ | 2.32 | 6.31×10 ⁻³ |
| Remote-Handled Mixed TRU/TRU waste facility (WRAP expansion) | 2051 | 2051 | 1.88 | 4.90×10 ⁻² | 2.32 | 2.52×10 ⁻³ |
| Central Waste Complex expansion | 2051 | 2051 | 1.59 | 4.13×10 ⁻² | 1.69 | 2.13×10 ⁻³ |

Key: PM₁₀=particulate matter with an aerodynamic diameter less than or equal to 10 micrometers; TRU=transuranic; WRAP=Waste Receiving and Processing Facility.

Source: SAIC 2007c.

Table G-98. Waste Management Alternative 2 (Treatment and Storage) Toxic Pollutant Emissions from Mobile Sources

| Facility/System | Start Year | End Year | Emission Rate (metric tons per year) | | | | | | |
|---|------------|----------|--------------------------------------|-----------------------|-----------------------|-----------------------|---------|-----------------------|-----------------------|
| | | | Ammonia | Benzene | 1,3-Butadiene | Formaldehyde | Mercury | Toluene | Xylene |
| Construction | | | | | | | | | |
| T Plant complex expansion | 2011 | 2012 | 9.69×10 ⁻³ | 1.37×10 ⁻³ | 5.48×10 ⁻⁵ | 1.66×10 ⁻³ | a | 1.60×10 ⁻³ | 6.88×10 ⁻⁴ |
| Contact-Handled Mixed TRU/TRU waste facility (WRAP expansion) | 2011 | 2012 | 2.33×10 ⁻² | 3.82×10 ⁻³ | 1.33×10 ⁻⁴ | 4.14×10 ⁻³ | a | 1.27×10 ⁻² | 4.15×10 ⁻³ |
| Remote-Handled Mixed TRU/TRU waste facility (WRAP expansion) | 2013 | 2018 | 5.68×10 ⁻³ | 1.18×10 ⁻³ | 5.57×10 ⁻³ | 6.43×10 ⁻³ | a | 7.21×10 ⁻³ | 2.17×10 ⁻³ |
| Central Waste Complex expansion | 2011 | 2012 | 7.84×10 ⁻³ | 1.28×10 ⁻³ | 4.47×10 ⁻⁵ | 1.39×10 ⁻³ | a | 4.27×10 ⁻³ | 1.39×10 ⁻³ |
| Operations | | | | | | | | | |
| T Plant complex expansion | 2013 | 2050 | 7.28×10 ⁻¹ | 1.28 | 7.17×10 ⁻³ | 4.31×10 ⁻¹ | a | 1.96×10 ¹ | 5.54 |
| Contact-Handled Mixed TRU/TRU waste facility (WRAP expansion) | 2013 | 2050 | 5.95×10 ⁻⁴ | 9.90×10 ⁻⁴ | 5.56×10 ⁻⁶ | 3.34×10 ⁻⁴ | a | 1.52×10 ⁻² | 4.29×10 ⁻³ |
| Remote-Handled Mixed TRU/TRU waste facility (WRAP expansion) | 2019 | 2050 | 2.43×10 ⁻⁴ | 4.04×10 ⁻⁴ | 2.27×10 ⁻⁶ | 1.36×10 ⁻⁴ | a | 6.21×10 ⁻³ | 1.75×10 ⁻³ |
| Central Waste Complex expansion | 2013 | 2050 | 2.46×10 ⁻⁴ | 4.10×10 ⁻⁴ | 2.30×10 ⁻⁶ | 1.38×10 ⁻⁴ | a | 6.30×10 ⁻³ | 1.78×10 ⁻³ |
| Deactivation | | | | | | | | | |
| T Plant complex expansion | 2051 | 2051 | 8.26×10 ⁻⁴ | 2.76×10 ⁻³ | 9.03×10 ⁻⁵ | 2.84×10 ⁻³ | a | 1.16×10 ⁻² | 3.63×10 ⁻³ |
| Contact-Handled Mixed TRU/TRU waste facility (WRAP expansion) | 2051 | 2051 | 3.64×10 ⁻⁴ | 6.06×10 ⁻⁴ | 3.40×10 ⁻⁶ | 2.04×10 ⁻⁴ | a | 9.31×10 ⁻³ | 2.63×10 ⁻³ |
| Remote-Handled Mixed TRU/TRU waste facility (WRAP expansion) | 2051 | 2051 | 1.46×10 ⁻⁴ | 2.42×10 ⁻⁴ | 1.36×10 ⁻⁶ | 8.17×10 ⁻⁵ | a | 3.72×10 ⁻³ | 1.05×10 ⁻³ |
| Central Waste Complex expansion | 2051 | 2051 | 1.23×10 ⁻⁴ | 2.04×10 ⁻⁴ | 1.15×10 ⁻⁶ | 6.89×10 ⁻⁵ | a | 3.14×10 ⁻³ | 8.86×10 ⁻⁴ |

^a Emissions for this activity and pollutant were not calculated because annual fuel use for this activity and the resulting emissions would be small compared with other activities or would be zero.

Key: TRU=transuranic; WRAP=Waste Receiving and Processing Facility.

Source: SAIC 2007c.

Table G-99. Waste Management Alternative 2, Disposal Group 1, Criteria Pollutant Emissions from Mobile Sources

| Facility/System | Start Year | End Year | Emission Rate (metric tons per year) | | | |
|--|------------|----------|--------------------------------------|------------------|-----------------------|----------------|
| | | | Carbon Monoxide | Nitrogen Dioxide | PM ₁₀ | Sulfur Dioxide |
| Construction | | | | | | |
| Integrated Disposal Facility | 2006 | 2008 | a | a | 2.00×10 ³ | a |
| River Protection Project Disposal Facility | 2019 | 2021 | a | a | 6.64×10 ² | a |
| Operations | | | | | | |
| Low-level radioactive waste burial grounds | 2007 | 2050 | a | a | 2.61 | a |
| Integrated Disposal Facility | 2009 | 2050 | a | a | 2.69×10 ¹ | a |
| River Protection Project Disposal Facility | 2022 | 2050 | a | a | 7.05×10 ¹ | a |
| Closure | | | | | | |
| Integrated Disposal Facility | 2051 | 2052 | a | a | 4.62×10 ² | a |
| Postclosure care, Integrated Disposal Facility | 2053 | 2152 | a | a | 6.72×10 ⁻² | a |
| River Protection Project Disposal Facility | 2051 | 2052 | a | a | 1.52×10 ² | a |
| Postclosure care, River Protection Project Disposal Facility | 2053 | 2152 | a | a | 1.27×10 ⁻¹ | a |

^a Emissions for this activity and pollutant were not calculated because annual fuel use for this activity and the resulting emissions would be small compared with other activities or would be zero.

Key: PM₁₀=particulate matter with an aerodynamic diameter less than or equal to 10 micrometers.

Source: SAIC 2007c.

Table G-100. Waste Management Alternative 2, Disposal Group 1, Toxic Pollutant Emissions from Mobile Sources

| Facility/System | Start Year | End Year | Emission Rate (metric tons per year) | | | | | | |
|--|------------|----------|--------------------------------------|---------|---------------|--------------|---------|---------|--------|
| | | | Ammonia | Benzene | 1,3-Butadiene | Formaldehyde | Mercury | Toluene | Xylene |
| Construction | | | | | | | | | |
| Integrated Disposal Facility | 2006 | 2008 | a | a | a | a | a | a | a |
| River Protection Project Disposal Facility | 2019 | 2021 | a | a | a | a | a | a | a |
| Operations | | | | | | | | | |
| Low-level radioactive waste burial grounds | 2007 | 2050 | a | a | a | a | a | a | a |
| Integrated Disposal Facility | 2009 | 2050 | a | a | a | a | a | a | a |
| River Protection Project Disposal Facility | 2022 | 2050 | a | a | a | a | a | a | a |
| Closure | | | | | | | | | |
| Integrated Disposal Facility | 2051 | 2052 | a | a | a | a | a | a | a |
| Postclosure care, Integrated Disposal Facility | 2053 | 2152 | a | a | a | a | a | a | a |
| River Protection Project Disposal Facility | 2051 | 2052 | a | a | a | a | a | a | a |
| Postclosure care, River Protection Project Disposal Facility | 2053 | 2152 | a | a | a | a | a | a | a |

^a Emissions for this activity and pollutant were not calculated because annual fuel use for this activity and the resulting emissions would be small compared with other activities or would be zero.

Source: SAIC 2007c.

Table G-101. Waste Management Alternative 2, Disposal Group 2, Criteria Pollutant Emissions from Mobile Sources

| Facility/System | Start Year | End Year | Emission Rate (metric tons per year) | | | |
|--|------------|----------|--------------------------------------|------------------|-----------------------|----------------|
| | | | Carbon Monoxide | Nitrogen Dioxide | PM ₁₀ | Sulfur Dioxide |
| Construction | | | | | | |
| Integrated Disposal Facility | 2006 | 2008 | a | a | 7.06×10 ² | a |
| River Protection Project Disposal Facility | 2019 | 2021 | a | a | 5.15×10 ³ | a |
| Operations | | | | | | |
| Low-level radioactive waste burial grounds | 2007 | 2050 | a | a | 2.61 | a |
| Integrated Disposal Facility | 2009 | 2100 | a | a | 4.34 | a |
| River Protection Project Disposal Facility | 2022 | 2100 | a | a | 2.00×10 ² | a |
| Closure | | | | | | |
| Integrated Disposal Facility | 2101 | 2102 | a | a | 1.63×10 ² | a |
| Postclosure care, Integrated Disposal Facility | 2103 | 2202 | a | a | 2.38×10 ⁻² | a |
| River Protection Project Disposal Facility | 2101 | 2102 | a | a | 1.18×10 ³ | a |
| Postclosure care, River Protection Project Disposal Facility | 2103 | 2202 | a | a | 1.27×10 ⁻¹ | a |

^a Emissions for this activity and pollutant were not calculated because annual fuel use for this activity and the resulting emissions would be small compared with other activities or would be zero.

Key: PM₁₀=particulate matter with an aerodynamic diameter less than or equal to 10 micrometers.

Source: SAIC 2007c.

Table G-102. Waste Management Alternative 2, Disposal Group 2, Toxic Pollutant Emissions from Mobile Sources

| Facility/System | Start Year | End Year | Emission Rate (metric tons per year) | | | | | | |
|--|------------|----------|--------------------------------------|---------|---------------|--------------|---------|---------|--------|
| | | | Ammonia | Benzene | 1,3-Butadiene | Formaldehyde | Mercury | Toluene | Xylene |
| Construction | | | | | | | | | |
| Integrated Disposal Facility | 2006 | 2008 | a | a | a | a | a | a | a |
| River Protection Project Disposal Facility | 2019 | 2021 | a | a | a | a | a | a | a |
| Operations | | | | | | | | | |
| Low-level radioactive waste burial grounds | 2007 | 2050 | a | a | a | a | a | a | a |
| Integrated Disposal Facility | 2009 | 2100 | a | a | a | a | a | a | a |
| River Protection Project Disposal Facility | 2022 | 2100 | a | a | a | a | a | a | a |
| Closure | | | | | | | | | |
| Integrated Disposal Facility | 2101 | 2102 | a | a | a | a | a | a | a |
| Postclosure care, Integrated Disposal Facility | 2103 | 2202 | a | a | a | a | a | a | a |
| River Protection Project Disposal Facility | 2101 | 2102 | a | a | a | a | a | a | a |
| Postclosure care, River Protection Project Disposal Facility | 2103 | 2202 | a | a | a | a | a | a | a |

^a Emissions for this activity and pollutant were not calculated because annual fuel use for this activity and the resulting emissions would be small compared with other activities or would be zero.

Source: SAIC 2007c.

Table G-103. Waste Management Alternative 2, Disposal Group 3, Criteria Pollutant Emissions from Mobile Sources

| Facility/System | Start Year | End Year | Emission Rate (metric tons per year) | | | |
|---|------------|----------|--------------------------------------|------------------|-----------------------|----------------|
| | | | Carbon Monoxide | Nitrogen Dioxide | PM ₁₀ | Sulfur Dioxide |
| Construction | | | | | | |
| Integrated Disposal Facility | 2006 | 2008 | a | a | 7.06×10 ² | a |
| River Protection Project Disposal Facility | 2019 | 2021 | a | a | 5.15×10 ³ | a |
| Operations | | | | | | |
| Low-level radioactive waste burial grounds | 2007 | 2050 | a | a | 2.61 | a |
| Integrated Disposal Facility | 2009 | 2165 | a | a | 2.54 | a |
| River Protection Project Disposal Facility | 2022 | 2165 | a | a | 1.10×10 ² | a |
| Closure | | | | | | |
| Integrated Disposal Facility | 2166 | 2167 | a | a | 1.63×10 ² | a |
| Postclosure care, Integrated Disposal Facility | 2168 | 2267 | a | a | 2.38×10 ⁻² | a |
| River Protection Project Disposal Facility | 2166 | 2167 | a | a | 1.18×10 ³ | a |
| Postclosure care, River Project Disposal Facility | 2168 | 2267 | a | a | 1.27×10 ⁻¹ | a |

^a Emissions for this activity and pollutant were not calculated because annual fuel use for this activity and the resulting emissions would be small compared with other activities or would be zero.

Key: PM₁₀=particulate matter with an aerodynamic diameter less than or equal to 10 micrometers.

Source: SAIC 2007c.

Table G-104. Waste Management Alternative 2, Disposal Group 3, Toxic Pollutant Emissions from Mobile Sources

| Facility/System | Start Year | End Year | Emission Rate (metric tons per year) | | | | | | |
|---|------------|----------|--------------------------------------|---------|---------------|--------------|---------|---------|--------|
| | | | Ammonia | Benzene | 1,3-Butadiene | Formaldehyde | Mercury | Toluene | Xylene |
| Construction | | | | | | | | | |
| Integrated Disposal Facility | 2006 | 2008 | a | a | a | a | a | a | a |
| River Protection Project Disposal Facility | 2019 | 2021 | a | a | a | a | a | a | a |
| Operations | | | | | | | | | |
| Low-level radioactive waste burial grounds | 2007 | 2050 | a | a | a | a | a | a | a |
| Integrated Disposal Facility | 2009 | 2165 | a | a | a | a | a | a | a |
| River Protection Project Disposal Facility | 2022 | 2165 | a | a | a | a | a | a | a |
| Closure | | | | | | | | | |
| Integrated Disposal Facility | 2166 | 2167 | a | a | a | a | a | a | a |
| Postclosure care, Integrated Disposal Facility | 2168 | 2267 | a | a | a | a | a | a | a |
| River Protection Project Disposal Facility | 2166 | 2167 | a | a | a | a | a | a | a |
| Postclosure care, River Project Disposal Facility | 2168 | 2267 | a | a | a | a | a | a | a |

^a Emissions for this activity and pollutant were not calculated because annual fuel use for this activity and the resulting emissions would be small compared with other activities or would be zero.

Source: SAIC 2007c.

Table G-105. Waste Management Alternative 3 (Treatment and Storage) Criteria Pollutant Emissions from Mobile Sources

| Facility/System | Start Year | End Year | Emission Rate (metric tons per year) | | | |
|---|------------|----------|--------------------------------------|-----------------------|----------------------|-----------------------|
| | | | Carbon Monoxide | Nitrogen Dioxide | PM ₁₀ | Sulfur Dioxide |
| Construction | | | | | | |
| T Plant complex expansion | 2011 | 2012 | 1.84 | 6.15 | 3.80×10 ¹ | 2.79×10 ⁻³ |
| Contact-Handled Mixed TRU/TRU waste facility (WRAP expansion) | 2011 | 2012 | 8.89 | 1.47×10 ¹ | 4.28×10 ² | 1.27×10 ⁻² |
| Remote-Handled Mixed TRU/TRU waste facility (WRAP expansion) | 2013 | 2018 | 4.23 | 3.53 | 7.67×10 ² | 5.84×10 ⁻³ |
| Central Waste Complex expansion | 2011 | 2012 | 2.98 | 4.94 | 1.44×10 ² | 4.25×10 ⁻³ |
| Operations | | | | | | |
| T Plant complex expansion | 2013 | 2050 | 9.93×10 ³ | 2.58×10 ² | 1.36×10 ⁴ | 1.33×10 ¹ |
| Contact-Handled Mixed TRU/TRU waste facility (WRAP expansion) | 2013 | 2050 | 7.69 | 2.00×10 ⁻¹ | 1.10×10 ⁴ | 1.03×10 ⁻² |
| Remote-Handled Mixed TRU/TRU waste facility (WRAP expansion) | 2019 | 2050 | 3.14 | 8.16×10 ⁻² | 3.12×10 ³ | 4.20×10 ⁻³ |
| Central Waste Complex expansion | 2013 | 2050 | 3.19 | 8.28×10 ⁻² | 5.11×10 ² | 4.27×10 ⁻³ |
| Deactivation | | | | | | |
| T Plant complex expansion | 2051 | 2051 | 7.48 | 9.89 | 6.64 | 1.05×10 ⁻² |
| Contact-Handled Mixed TRU/TRU waste facility (WRAP expansion) | 2051 | 2051 | 4.71 | 1.22×10 ⁻¹ | 2.32 | 6.31×10 ⁻³ |
| Remote-Handled Mixed TRU/TRU waste facility (WRAP expansion) | 2051 | 2051 | 1.88 | 4.90×10 ⁻² | 2.32 | 2.52×10 ⁻³ |
| Central Waste Complex expansion | 2051 | 2051 | 1.59 | 4.13×10 ⁻² | 1.69 | 2.13×10 ⁻³ |

Key: PM₁₀=particulate matter with an aerodynamic diameter less than or equal to 10 micrometers; TRU=transuranic; WRAP=Waste Receiving and Processing Facility.

Source: SAIC 2007c.

Table G-106. Waste Management Alternative 3 (Treatment and Storage) Toxic Pollutant Emissions from Mobile Sources

| Facility/System | Start Year | End Year | Emission Rate (metric tons per year) | | | | | | |
|---|------------|----------|--------------------------------------|-----------------------|-----------------------|-----------------------|---------|-----------------------|-----------------------|
| | | | Ammonia | Benzene | 1,3-Butadiene | Formaldehyde | Mercury | Toluene | Xylene |
| Construction | | | | | | | | | |
| T Plant complex expansion | 2011 | 2012 | 9.69×10^{-3} | 1.37×10^{-3} | 5.48×10^{-5} | 1.66×10^{-3} | a | 1.60×10^{-3} | 6.88×10^{-4} |
| Contact-Handled Mixed TRU/TRU waste facility (WRAP expansion) | 2011 | 2012 | 2.33×10^{-2} | 3.82×10^{-3} | 1.33×10^{-4} | 4.14×10^{-3} | a | 1.27×10^{-2} | 4.15×10^{-3} |
| Remote-Handled Mixed TRU/TRU waste facility (WRAP expansion) | 2013 | 2018 | 5.68×10^{-3} | 1.18×10^{-3} | 5.57×10^{-3} | 6.43×10^{-3} | a | 7.21×10^{-3} | 2.17×10^{-3} |
| Central Waste Complex expansion | 2011 | 2012 | 7.84×10^{-3} | 1.28×10^{-3} | 4.47×10^{-5} | 1.39×10^{-3} | a | 4.27×10^{-3} | 1.39×10^{-3} |
| Operations | | | | | | | | | |
| T Plant complex expansion | 2013 | 2050 | 7.28×10^{-1} | 1.28 | 7.17×10^{-3} | 4.31×10^{-1} | a | 1.96×10^1 | 5.54 |
| Contact-Handled Mixed TRU/TRU waste facility (WRAP expansion) | 2013 | 2050 | 5.95×10^{-4} | 9.90×10^{-4} | 5.56×10^{-6} | 3.34×10^{-4} | a | 1.52×10^{-2} | 4.29×10^{-3} |
| Remote-Handled Mixed TRU/TRU waste facility (WRAP expansion) | 2019 | 2050 | 2.43×10^{-4} | 4.04×10^{-4} | 2.27×10^{-6} | 1.36×10^{-4} | a | 6.21×10^{-3} | 1.75×10^{-3} |
| Central Waste Complex expansion | 2013 | 2050 | 2.46×10^{-4} | 4.10×10^{-4} | 2.30×10^{-6} | 1.38×10^{-4} | a | 6.30×10^{-3} | 1.78×10^{-3} |
| Deactivation | | | | | | | | | |
| T Plant complex expansion | 2051 | 2051 | 8.26×10^{-4} | 2.76×10^{-3} | 9.03×10^{-5} | 2.84×10^{-3} | a | 1.16×10^{-2} | 3.63×10^{-3} |
| Contact-Handled Mixed TRU/TRU waste facility (WRAP expansion) | 2051 | 2051 | 3.64×10^{-4} | 6.06×10^{-4} | 3.40×10^{-6} | 2.04×10^{-4} | a | 9.31×10^{-3} | 2.63×10^{-3} |
| Remote-Handled Mixed TRU/TRU waste facility (WRAP expansion) | 2051 | 2051 | 1.46×10^{-4} | 2.42×10^{-4} | 1.36×10^{-6} | 8.17×10^{-5} | a | 3.72×10^{-3} | 1.05×10^{-3} |
| Central Waste Complex expansion | 2051 | 2051 | 1.23×10^{-4} | 2.04×10^{-4} | 1.15×10^{-6} | 6.89×10^{-5} | a | 3.14×10^{-3} | 8.86×10^{-4} |

^a Emissions for this activity and pollutant were not calculated because annual fuel use for this activity and the resulting emissions would be small compared with other activities or would be zero.

Key: TRU=transuranic; WRAP=Waste Receiving and Processing Facility.

Source: SAIC 2007c.

Table G-107. Waste Management Alternative 3, Disposal Group 1, Criteria Pollutant Emissions from Mobile Sources

| Facility/System | Start Year | End Year | Emission Rate (metric tons per year) | | | |
|---|------------|----------|--------------------------------------|------------------|-----------------------|----------------|
| | | | Carbon Monoxide | Nitrogen Dioxide | PM ₁₀ | Sulfur Dioxide |
| Construction | | | | | | |
| Integrated Disposal Facility, 200-East Area | 2006 | 2008 | a | a | 1.25×10 ³ | a |
| Integrated Disposal Facility, 200-West Area | 2006 | 2008 | a | a | 1.03×10 ² | a |
| River Protection Project Disposal Facility | 2019 | 2021 | a | a | 6.64×10 ² | a |
| Operations | | | | | | |
| Low-level radioactive waste burial grounds | 2007 | 2050 | a | a | 2.61 | a |
| Integrated Disposal Facility, 200-East Area | 2009 | 2050 | a | a | 2.47×10 ¹ | a |
| Integrated Disposal Facility, 200-West Area | 2009 | 2050 | a | a | 2.03 | a |
| River Protection Project Disposal Facility | 2022 | 2050 | a | a | 7.05×10 ¹ | a |
| Closure | | | | | | |
| Integrated Disposal Facility, 200-East Area | 2051 | 2052 | a | a | 3.32×10 ² | a |
| Integrated Disposal Facility, 200-West Area | 2051 | 2052 | a | a | 2.72×10 ¹ | a |
| Postclosure care, Integrated Disposal Facility, 200-East Area | 2053 | 2152 | a | a | 9.07×10 ⁻² | a |
| Postclosure care, Integrated Disposal Facility, 200-West Area | 2053 | 2152 | a | a | 7.43×10 ⁻³ | a |
| River Protection Project Disposal Facility | 2051 | 2052 | a | a | 1.52×10 ² | a |
| Postclosure care, River Protection Project Disposal Facility | 2053 | 2152 | a | a | 1.53×10 ⁻¹ | a |

^a Emissions for this activity and pollutant were not calculated because annual fuel use for this activity and the resulting emissions would be small compared with other activities or would be zero.

Key: PM₁₀=particulate matter with an aerodynamic diameter less than or equal to 10 micrometers.

Source: SAIC 2007c.

Table G-108. Waste Management Alternative 3, Disposal Group 1, Toxic Pollutant Emissions from Mobile Sources

| Facility/System | Start Year | End Year | Emission Rate (metric tons per year) | | | | | | |
|---|------------|----------|--------------------------------------|---------|---------------|--------------|---------|---------|--------|
| | | | Ammonia | Benzene | 1,3-Butadiene | Formaldehyde | Mercury | Toluene | Xylene |
| Construction | | | | | | | | | |
| Integrated Disposal Facility, 200-East Area | 2006 | 2008 | a | a | a | a | a | a | a |
| Integrated Disposal Facility, 200-West Area | 2006 | 2008 | a | a | a | a | a | a | a |
| River Protection Project Disposal Facility | 2019 | 2021 | a | a | a | a | a | a | a |
| Operations | | | | | | | | | |
| Low-level radioactive waste burial grounds | 2007 | 2050 | a | a | a | a | a | a | a |
| Integrated Disposal Facility, 200-East Area | 2009 | 2050 | a | a | a | a | a | a | a |
| Integrated Disposal Facility, 200-West Area | 2009 | 2050 | a | a | a | a | a | a | a |
| River Protection Project Disposal Facility | 2022 | 2050 | a | a | a | a | a | a | a |
| Closure | | | | | | | | | |
| Integrated Disposal Facility, 200-East Area | 2051 | 2052 | a | a | a | a | a | a | a |
| Integrated Disposal Facility, 200-West Area | 2051 | 2052 | a | a | a | a | a | a | a |
| Postclosure care, Integrated Disposal Facility, 200-East Area | 2053 | 2152 | a | a | a | a | a | a | a |
| Postclosure care, Integrated Disposal Facility, 200-West Area | 2053 | 2152 | a | a | a | a | a | a | a |
| River Protection Project Disposal Facility | 2051 | 2052 | a | a | a | a | a | a | a |
| Postclosure care, River Protection Project Disposal Facility | 2053 | 2152 | a | a | a | a | a | a | a |

^a Emissions for this activity and pollutant were not calculated because annual fuel use for this activity and the resulting emissions would be small compared with other activities or would be zero.

Source: SAIC 2007c.

Table G-109. Waste Management Alternative 3, Disposal Group 2, Criteria Pollutant Emissions from Mobile Sources

| Facility/System | Start Year | End Year | Emission Rate (metric tons per year) | | | |
|---|------------|----------|--------------------------------------|------------------|-----------------------|----------------|
| | | | Carbon Monoxide | Nitrogen Dioxide | PM ₁₀ | Sulfur Dioxide |
| Construction | | | | | | |
| Integrated Disposal Facility, 200-East Area | 2006 | 2008 | a | a | 3.91×10 ² | a |
| Integrated Disposal Facility, 200-West Area | 2006 | 2008 | a | a | 1.03×10 ² | a |
| River Protection Project Disposal Facility | 2019 | 2021 | a | a | 5.15×10 ³ | a |
| Operations | | | | | | |
| Low-level radioactive waste burial grounds | 2007 | 2050 | a | a | 2.61 | a |
| Integrated Disposal Facility, 200-East Area | 2009 | 2100 | a | a | 3.52 | a |
| Integrated Disposal Facility, 200-West Area | 2009 | 2050 | a | a | 2.03 | a |
| River Protection Project Disposal Facility | 2022 | 2100 | a | a | 2.00×10 ² | a |
| Closure | | | | | | |
| Integrated Disposal Facility, 200-East Area | 2101 | 2102 | a | a | 1.03×10 ² | a |
| Integrated Disposal Facility, 200-West Area | 2051 | 2052 | a | a | 2.72×10 ¹ | a |
| Postclosure care, Integrated Disposal Facility, 200-East Area | 2103 | 2202 | a | a | 2.83×10 ⁻² | a |
| Postclosure care, Integrated Disposal Facility, 200-West Area | 2053 | 2152 | a | a | 7.43×10 ⁻³ | a |
| River Protection Project Disposal Facility | 2101 | 2102 | a | a | 1.18×10 ³ | a |
| Postclosure care, River Protection Project Disposal Facility | 2103 | 2202 | a | a | 1.18 | a |

^a Emissions for this activity and pollutant were not calculated because annual fuel use for this activity and the resulting emissions would be small compared with other activities or would be zero.

Key: PM₁₀=particulate matter with an aerodynamic diameter less than or equal to 10 micrometers.

Source: SAIC 2007c.

Table G-110. Waste Management Alternative 3, Disposal Group 2, Toxic Pollutant Emissions from Mobile Sources

| Facility/System | Start Year | End Year | Emission Rate (metric tons per year) | | | | | | |
|---|------------|----------|--------------------------------------|---------|---------------|--------------|---------|---------|--------|
| | | | Ammonia | Benzene | 1,3-Butadiene | Formaldehyde | Mercury | Toluene | Xylene |
| Construction | | | | | | | | | |
| Integrated Disposal Facility, 200-East Area | 2006 | 2008 | a | a | a | a | a | a | a |
| Integrated Disposal Facility, 200-West Area | 2006 | 2008 | a | a | a | a | a | a | a |
| River Protection Project Disposal Facility | 2019 | 2021 | a | a | a | a | a | a | a |
| Operations | | | | | | | | | |
| Low-level radioactive waste burial grounds | 2007 | 2050 | a | a | a | a | a | a | a |
| Integrated Disposal Facility, 200-East Area | 2009 | 2100 | a | a | a | a | a | a | a |
| Integrated Disposal Facility, 200-West Area | 2009 | 2050 | a | a | a | a | a | a | a |
| River Protection Project Disposal Facility | 2022 | 2100 | a | a | a | a | a | a | a |
| Closure | | | | | | | | | |
| Integrated Disposal Facility, 200-East Area | 2101 | 2102 | a | a | a | a | a | a | a |
| Integrated Disposal Facility, 200-West Area | 2051 | 2052 | a | a | a | a | a | a | a |
| Postclosure care, Integrated Disposal Facility, 200-East Area | 2103 | 2202 | a | a | a | a | a | a | a |
| Postclosure care, Integrated Disposal Facility, 200-West Area | 2053 | 2152 | a | a | a | a | a | a | a |
| River Protection Project Disposal Facility | 2101 | 2102 | a | a | a | a | a | a | a |
| Postclosure care, River Protection Project Disposal Facility | 2103 | 2202 | a | a | a | a | a | a | a |

^a Emissions for this activity and pollutant were not calculated because annual fuel use for this activity and the resulting emissions would be small compared with other activities or would be zero.

Source: SAIC 2007c.

Table G-111. Waste Management Alternative 3, Disposal Group 3, Criteria Pollutant Emissions from Mobile Sources

| Facility/System | Start Year | End Year | Emission Rate (metric tons per year) | | | |
|---|------------|----------|--------------------------------------|------------------|-----------------------|----------------|
| | | | Carbon Monoxide | Nitrogen Dioxide | PM ₁₀ | Sulfur Dioxide |
| Construction | | | | | | |
| Integrated Disposal Facility, 200-East Area | 2006 | 2008 | a | a | 3.91×10 ² | a |
| Integrated Disposal Facility, 200-West Area | 2006 | 2008 | a | a | 1.03×10 ² | a |
| River Protection Project Disposal Facility | 2019 | 2021 | a | a | 5.15×10 ³ | a |
| Operations | | | | | | |
| Low-level radioactive waste burial grounds | 2007 | 2050 | a | a | 2.61 | a |
| Integrated Disposal Facility, 200-East Area | 2009 | 2165 | a | a | 2.06 | a |
| Integrated Disposal Facility, 200-West Area | 2009 | 2050 | a | a | 2.03 | a |
| River Protection Project Disposal Facility | 2022 | 2165 | a | a | 1.10×10 ² | a |
| Closure | | | | | | |
| Integrated Disposal Facility, 200-East Area | 2166 | 2167 | a | a | 1.03×10 ² | a |
| Integrated Disposal Facility, 200-West Area | 2051 | 2052 | a | a | 2.72×10 ¹ | a |
| Postclosure care, Integrated Disposal Facility, 200-East Area | 2168 | 2267 | a | a | 2.83×10 ⁻² | a |
| Postclosure care, Integrated Disposal Facility, 200-West Area | 2053 | 2152 | a | a | 7.43×10 ⁻³ | a |
| River Protection Project Disposal Facility | 2166 | 2167 | a | a | 1.18×10 ³ | a |
| Postclosure care, River Protection Project Disposal Facility | 2168 | 2267 | a | a | 1.18 | a |

^a Emissions for this activity and pollutant were not calculated because annual fuel use for this activity and the resulting emissions would be small compared with other activities or would be zero.

Key: PM₁₀=particulate matter with an aerodynamic diameter less than or equal to 10 micrometers.

Source: SAIC 2007c.

Table G-112. Waste Management Alternative 3, Disposal Group 3, Toxic Pollutant Emissions from Mobile Sources

| Facility/System | Start Year | End Year | Emission Rate (metric tons per year) | | | | | | |
|---|------------|----------|--------------------------------------|---------|---------------|--------------|---------|---------|--------|
| | | | Ammonia | Benzene | 1,3-Butadiene | Formaldehyde | Mercury | Toluene | Xylene |
| Construction | | | | | | | | | |
| Integrated Disposal Facility, 200-East Area | 2006 | 2008 | a | a | a | a | a | a | a |
| Integrated Disposal Facility, 200-West Area | 2006 | 2008 | a | a | a | a | a | a | a |
| River Protection Project Disposal Facility | 2019 | 2021 | a | a | a | a | a | a | a |
| Operations | | | | | | | | | |
| Low-level radioactive waste burial grounds | 2007 | 2050 | a | a | a | a | a | a | a |
| Integrated Disposal Facility, 200-East Area | 2009 | 2165 | a | a | a | a | a | a | a |
| Integrated Disposal Facility, 200-West Area | 2009 | 2050 | a | a | a | a | a | a | a |
| River Protection Project Disposal Facility | 2022 | 2165 | a | a | a | a | a | a | a |
| Closure | | | | | | | | | |
| Integrated Disposal Facility, 200-East Area | 2166 | 2167 | a | a | a | a | a | a | a |
| Integrated Disposal Facility, 200-West Area | 2051 | 2052 | a | a | a | a | a | a | a |
| Postclosure care, Integrated Disposal Facility, 200-East Area | 2168 | 2267 | a | a | a | a | a | a | a |
| Postclosure care, Integrated Disposal Facility, 200-West Area | 2053 | 2152 | a | a | a | a | a | a | a |
| River Protection Project Disposal Facility | 2166 | 2167 | a | a | a | a | a | a | a |
| Postclosure care, River Protection Project Disposal Facility | 2168 | 2267 | a | a | a | a | a | a | a |

^a Emissions for this activity and pollutant were not calculated because annual fuel use for this activity and the resulting emissions would be small compared with other activities or would be zero.

Source: SAIC 2007c.

G.3 AIR QUALITY IMPACTS UNDER THE ALTERNATIVES

Maximum concentrations of each air pollutant for defined averaging periods were calculated for each alternative. Using the average emissions for an activity, the maximum air pollutant concentrations at a point of public access was determined for the activity for each of the averaging periods. The combined impact for an averaging period was determined by summing the contributions for each pollutant and averaging period from all activities that would be ongoing during a year. The year (or years) with the highest concentration—the peak year—was identified for each pollutant for each averaging period for each alternative. The peak year can therefore differ depending on the pollutant and the averaging period. Presented in Tables G–113 through G–166 is a summary of the contribution of each activity to the peak-year concentrations. Totals may not equal the sum of the contributions due to rounding. The data in these tables correspond to the peak years identified in the summary tables in the air quality sections of Chapter 4. The total concentrations presented are the sums of highest possible peak year concentrations attributable to the various activities as modeled at different receptor locations. Therefore these totals are overestimates of the peak year concentrations. Included in the text of Chapter 4 is a discussion of the activities that would contribute to exceedances of the ambient standards; potential exceedances are indicated in the tables total row by bold type. The figures in Chapter 4 show the duration of the various activities and of potential exceedances of PM₁₀.

Results of the air quality modeling indicate possible exceedances of the 24-hour ambient standard for PM₁₀ and PM_{2.5} under all Tank Closure and Waste Management alternatives. The primary activities contributing to these exceedances vary by alternative. For tank closure, they include construction of certain major facilities such as the WTP and replacements, waste receiver facilities, modified RCRA Subtitle C barriers, Hanford landfill barriers, double-shell tanks, Contact-Handled Mixed Transuranic Waste Facilities, and the Effluent Treatment Facility and replacements, as well as operation of Borrow Area C. Major considerations in estimating construction-related particulate matter emissions include construction equipment types and activity, windblown particulates from disturbed areas, resuspension of road dust, fuel combustion, and concrete batch plant operations. Exceedances of the 24-hour PM₁₀ standard under the Tank Closure alternatives could occur over as few as 3 years under Tank Closure Alternative 1 to as many as 192 years under Tank Closure Alternative 6A, Base or Option Case. Similar exceedances of PM_{2.5} could occur.

The primary activities contributing to exceedances of the PM₁₀ and PM_{2.5} 24-hour ambient standards under Waste Management alternatives would include (1) construction and closure of major facilities such as the Integrated Disposal Facility and the River Protection Project Disposal Facility; (2) operation of the Central Waste Complex, Remote-Handled Mixed Transuranic/Transuranic waste facility (Waste Receiving and Processing Facility expansion), Contact-Handled Mixed Transuranic/Transuranic waste facility (Waste Receiving and Processing Facility expansion), Integrated Disposal Facility, and Central Waste Complex expansion storage facility; and (3) deactivation of the Integrated Disposal Facility. Exceedances of the 24-hour PM₁₀ standard could occur over as many as 162 years under Waste Management Alternative 2, Disposal Group 3.

Factored into estimates of particulate matter emissions from general construction activities are fugitive dust emissions from disturbed construction areas, including dust suspended by wind and by equipment and vehicle activity. The emission factor used for these estimates is intended to provide a gross estimate of total suspended particulate emissions, albeit an estimate for which more-detailed engineering of the construction activity would allow for a more-refined estimate of dust emissions. For the purpose of this analysis, emissions of PM₁₀ and PM_{2.5} from general construction activities were assumed to be the same as total suspended particulate emissions. The resulting estimate of general construction activity emissions, the primary contributor to construction particulate matter emissions, thus entails a substantial overestimate of PM₁₀ and PM_{2.5} emissions for the primary construction activities. Further, as discussed in

Chapter 4, the analysis did not consider appropriate emission controls that could be applied in the construction areas. A refined analysis of emissions based on more-detailed engineering of the construction activities and application of appropriate control technologies should result in substantially lower major construction-related emissions and ambient concentrations under each alternative.

The results of the air quality modeling also indicate possible exceedances of the 1-hour carbon monoxide standard under Tank Closure Alternatives 2A, 3A, 3B, 3C, and 5. Exceedances of that standard could occur over as many as 7 years under each of these alternatives. The primary activities contributing to these exceedances would include construction of certain large facilities such as the WTP, Cesium and Strontium Capsule Processing Facility, Sulfate Removal Facility, and modified RCRA Subtitle C barriers. Exceedances of the carbon monoxide standards are also indicated under the various disposal groups under Waste Management Alternatives 2 and 3. These carbon monoxide concentrations would result from combustion of fuel in construction equipment.

Table G–113. Tank Closure Alternative 1 Maximum Criteria Pollutant Concentrations of Peak Activity Periods

| Facility/System | Start Year | End Year | Concentration (micrograms per cubic meter) | | | | | | | | |
|-------------------------------|------------|----------|--|----------------------|-----------------------|----------------------------|-----------------------|-----------------------|-----------------------|-----------------------|-----------------------|
| | | | Carbon Monoxide | | Nitrogen Dioxide | PM ₁₀ | | Sulfur Dioxide | | | |
| | | | 1-hour | 8-hour | Annual | 24-hour | Annual | 1-hour | 3-hour | 24-hour | Annual |
| | | | 2008 | 2008 | 2008 | 2006–2008 | 2006–2008 | 2006–2008 | 2006–2008 | 2006–2008 | 2006–2008 |
| Construction | | | | | | | | | | | |
| Canister Storage Building | 2006 | 2008 | 4.37×10 ¹ | 6.76 | 6.39×10 ⁻³ | 4.82×10 ⁻¹ | 4.54×10 ⁻³ | 3.17×10 ⁻³ | 1.14×10 ⁻³ | 2.14×10 ⁻⁴ | 2.02×10 ⁻⁶ |
| Other infrastructure upgrades | 2006 | 2008 | 1.80×10 ¹ | 2.88 | 6.70×10 ⁻³ | 1.27 | 9.42×10 ⁻³ | 4.12×10 ⁻³ | 1.40×10 ⁻³ | 2.86×10 ⁻⁴ | 2.11×10 ⁻⁶ |
| Tank upgrades | 2006 | 2008 | 5.67×10 ³ | 9.09×10 ² | 3.67×10 ⁻¹ | 9.09 | 6.72×10 ⁻² | 2.24×10 ⁻¹ | 7.63×10 ⁻² | 1.56×10 ⁻² | 1.15×10 ⁻⁴ |
| Waste Treatment Plant | 2006 | 2008 | 1.72×10 ⁴ | 2.42×10 ³ | 7.81 | 5.36×10 ² | 5.23 | 2.38×10 ¹ | 7.92 | 1.36 | 1.33×10 ⁻² |
| Operations | | | | | | | | | | | |
| Routine operations | 2006 | 2008 | 5.72×10 ¹ | 1.50×10 ¹ | 8.27×10 ⁻² | b | b | b | b | b | b |
| Deactivation | | | | | | | | | | | |
| Administrative controls | 2008 | 2107 | 3.37×10 ² | 5.65×10 ¹ | 2.86×10 ⁻¹ | b | b | b | b | b | b |
| Total | | | 2.33×10 ⁴ | 3.41×10 ³ | 8.56 | 5.46×10² | 5.32 | 2.40×10 ¹ | 8.00 | 1.37 | 1.34×10 ⁻² |

^a This activity would not contribute to the concentration during the peak year(s) for this pollutant and averaging period.

^b Emissions for this activity and pollutant were not calculated because they would be small compared with those for other activities under this alternative, as explained in Section G.2.

Note: Total concentrations exceeding applicable standards are presented in **bold**.

Key: PM₁₀=particulate matter with an aerodynamic diameter less than or equal to 10 micrometers.

Source: SAIC 2007a, 2008.

Table G-114. Tank Closure Alternative 1 Maximum Toxic Pollutant Concentrations of Peak Activity Periods

| Facility/System | Start Year | End Year | Concentration (micrograms per cubic meter) | | | | | | |
|-------------------------------|------------|----------|--|-----------------------|-----------------------|-----------------------|---------|-----------|-----------------------|
| | | | Ammonia | Benzene | 1,3-Butadiene | Formaldehyde | Mercury | Toluene | Xylene |
| | | | 24-hour | Annual | Annual | Annual | 24-hour | 24-hour | 24-hour |
| | | | 2008 | 2006-2008 | 2006-2008 | 2006-2008 | c | 2006-2008 | 2006-2008 |
| Construction | | | | | | | | | |
| Canister Storage Building | 2006 | 2008 | b | b | b | b | b | b | b |
| Other infrastructure upgrades | 2006 | 2008 | b | b | b | b | b | b | b |
| Tank upgrades | 2006 | 2008 | 8.81×10^{-2} | b | b | b | b | b | b |
| Waste Treatment Plant | 2006 | 2008 | 1.29 | 2.64×10^{-3} | 7.32×10^{-5} | 2.38×10^{-3} | b | 1.69 | 5.06×10^{-1} |
| Operations | | | | | | | | | |
| Routine operations | 2006 | 2008 | 5.59 | b | b | b | b | b | b |
| Deactivation | | | | | | | | | |
| Administrative controls | 2008 | 2107 | 1.91×10^1 | b | b | b | b | b | b |
| Total | | | 2.61×10^1 | 2.64×10^{-3} | 7.32×10^{-5} | 2.38×10^{-3} | 0 | 1.69 | 5.06×10^{-1} |

^a This activity would not contribute to the concentration during the peak year(s) for this pollutant and averaging period.

^b Emissions for this activity and pollutant were not calculated because they would be small compared with those for other activities under this alternative, as explained in Section G.2.

^c There is no peak year because no emissions were calculated.

Note: Total concentrations exceeding applicable standards are presented in **bold**.

Source: SAIC 2007a, 2008.

Table G-115. Tank Closure Alternative 2A Maximum Criteria Pollutant Concentrations of Peak Activity Periods

| Facility/System | Start Year | End Year | Concentration (micrograms per cubic meter) | | | | | | | | |
|--|------------|----------|--|----------------------|-----------------------|-----------------------|-----------------------|-----------------------|-----------------------|-----------------------|-----------------------|
| | | | Carbon Monoxide | | Nitrogen Dioxide | PM ₁₀ | | Sulfur Dioxide | | | |
| | | | 1-hour | 8-hour | Annual | 24-hour | Annual | 1-hour | 3-hour | 24-hour | Annual |
| | | | 2065-2066 | 2065-2066 | 2065-2066 | 2065-2066 | 2065-2066 | 2065-2066 | 2065-2066 | 2065-2066 | 2065-2066 |
| Construction | | | | | | | | | | | |
| Underground transfer lines | 2009 | 2009 | a | a | a | a | a | a | a | a | a |
| Canister Storage Building | 2006 | 2016 | a | a | a | a | a | a | a | a | a |
| IHLW Shipping/Transfer Facility | 2011 | 2013 | a | a | a | a | a | a | a | a | a |
| IHLW Interim Storage Modules | 2014 | 2019 | a | a | a | a | a | a | a | a | a |
| Other infrastructure upgrades | 2006 | 2034 | a | a | a | a | a | a | a | a | a |
| Tank upgrades | 2006 | 2025 | a | a | a | a | a | a | a | a | a |
| Waste Treatment Plant original | 2006 | 2017 | a | a | a | a | a | a | a | a | a |
| Cesium and Strontium Capsule Processing Facility | 2088 | 2091 | a | a | a | a | a | a | a | a | a |
| Tank risers | 2013 | 2056 | a | a | a | a | a | a | a | a | a |
| Modified sluicing retrieval system | 2013 | 2092 | 5.38×10 ² | 8.62×10 ¹ | 1.06×10 ⁻² | 7.96×10 ⁻¹ | 5.88×10 ⁻³ | 4.97×10 ⁻³ | 1.69×10 ⁻³ | 3.45×10 ⁻⁴ | 2.55×10 ⁻⁶ |
| Mobile retrieval system | 2013 | 2052 | a | a | a | a | a | a | a | a | a |
| Vacuum-based retrieval system | 2053 | 2092 | 3.52×10 ² | 5.65×10 ¹ | 8.17×10 ⁻² | 2.22 | 1.64×10 ⁻² | 5.08×10 ⁻² | 1.73×10 ⁻² | 3.52×10 ⁻³ | 2.60×10 ⁻⁵ |
| HLW Melter Interim Storage Facility 1 | 2015 | 2016 | a | a | a | a | a | a | a | a | a |
| HLW Melter Interim Storage Facility 2 | 2040 | 2041 | a | a | a | a | a | a | a | a | a |
| HLW Melter Interim Storage Facility 3 | 2065 | 2066 | 1.39×10 ¹ | 1.96 | 1.75×10 ⁻² | 2.22×10 ¹ | 2.17×10 ⁻¹ | 6.46×10 ⁻³ | 2.15×10 ⁻³ | 3.69×10 ⁻⁴ | 3.61×10 ⁻⁶ |
| Double-shell tank replacement | 2013 | 2054 | a | a | a | a | a | a | a | a | a |
| Waste Treatment Plant replacement | 2065 | 2076 | 3.44×10 ⁴ | 4.85×10 ³ | 1.56×10 ¹ | 1.07×10 ³ | 1.05×10 ¹ | 4.75×10 ¹ | 1.58×10 ¹ | 2.72 | 2.66×10 ⁻² |
| Underground transfer line replacement | 2044 | 2044 | a | a | a | a | a | a | a | a | a |
| Effluent Treatment Facility replacement 1 | 2023 | 2025 | a | a | a | a | a | a | a | a | a |
| Effluent Treatment Facility replacement 2 | 2053 | 2055 | a | a | a | a | a | a | a | a | a |
| Evaporator replacement 1 | 2015 | 2017 | a | a | a | a | a | a | a | a | a |
| Evaporator replacement 2 | 2040 | 2042 | a | a | a | a | a | a | a | a | a |
| Evaporator replacement 3 | 2065 | 2067 | 3.56×10 ³ | 5.50×10 ² | 3.27×10 ⁻¹ | 9.34 | 8.79×10 ⁻² | 4.79 | 1.71 | 3.23×10 ⁻¹ | 3.04×10 ⁻³ |

Table G-115. Tank Closure Alternative 2A Maximum Criteria Pollutant Concentrations of Peak Activity Periods (continued)

| Facility/System | Start Year | End Year | Concentration (micrograms per cubic meter) | | | | | | | | |
|--|------------|----------|--|-----------------------|-----------------------|-----------------------|-----------------------|-----------------------|-----------------------|-----------------------|-----------------------|
| | | | Carbon Monoxide | | Nitrogen Dioxide | PM ₁₀ | | Sulfur Dioxide | | | |
| | | | 1-hour | 8-hour | Annual | 24-hour | Annual | 1-hour | 3-hour | 24-hour | Annual |
| | | | 2065-2066 | 2065-2066 | 2065-2066 | 2065-2066 | 2065-2066 | 2065-2066 | 2065-2066 | 2065-2066 | 2065-2066 |
| Operations | | | | | | | | | | | |
| IHLW Interim Storage Facility | 2018 | 2092 | b | b | b | b | b | b | b | b | b |
| Other infrastructure upgrades | 2006 | 2092 | b | b | b | b | b | b | b | b | b |
| Routine operations | 2006 | 2092 | 5.72×10 ¹ | 1.50×10 ¹ | 8.27×10 ⁻² | b | b | b | b | b | b |
| Retrieval operations | 2006 | 2092 | 7.66×10 ⁻¹ | 1.23×10 ⁻¹ | 4.45×10 ⁻⁴ | b | b | b | b | b | b |
| Double-shell tank interim stabilization | 2006 | 2092 | 7.66 | 1.28 | 6.50×10 ⁻³ | b | b | b | b | b | b |
| Waste Treatment Plant | 2018 | 2092 | 1.13×10 ² | 3.47×10 ¹ | 1.17 | 3.65×10 ⁻¹ | 1.70×10 ⁻² | 1.09×10 ¹ | 6.71 | 1.12 | 5.23×10 ⁻² |
| Waste Treatment Plant, cesium and strontium capsules | 2093 | 2093 | a | a | a | a | a | a | a | a | a |
| Cesium and Strontium Capsule Processing Facility | 2092 | 2093 | a | a | a | a | a | a | a | a | a |
| Modified sluicing retrieval system | 2013 | 2092 | 2.28×10 ² | 3.81×10 ¹ | 1.06×10 ⁻² | 7.11×10 ⁻² | 8.13×10 ⁻⁴ | 3.62×10 ⁻³ | 1.32×10 ⁻³ | 2.37×10 ⁻⁴ | 2.71×10 ⁻⁶ |
| Mobile retrieval system | 2013 | 2052 | a | a | a | a | a | a | a | a | a |
| Vacuum-based retrieval system | 2053 | 2092 | 2.40 | 3.85×10 ⁻¹ | 1.40×10 ⁻³ | b | b | b | b | b | b |
| HLW Melter Interim Storage Facility | 2018 | 2192 | b | b | b | b | b | b | b | b | b |
| Effluent Treatment Facility | 2006 | 2095 | 7.85 | 2.41 | 1.02×10 ⁻² | 7.66×10 ¹ | 3.57 | 1.06×10 ⁻² | 6.52×10 ⁻³ | 1.09×10 ⁻³ | 5.08×10 ⁻⁵ |
| Evaporator | 2006 | 2093 | 2.00×10 ² | 3.09×10 ¹ | 5.88×10 ⁻¹ | 1.87×10 ¹ | 1.76×10 ⁻¹ | 3.15×10 ⁻¹ | 1.13×10 ⁻¹ | 2.13×10 ⁻² | 2.00×10 ⁻⁴ |
| Borrow Area C | 2006 | 2102 | 6.91×10 ² | 2.83×10 ² | 4.42×10 ⁻¹ | 3.98×10 ² | 9.10×10 ⁻¹ | 9.72×10 ⁻¹ | 6.58×10 ⁻¹ | 2.07×10 ⁻¹ | 4.75×10 ⁻⁴ |
| Deactivation | | | | | | | | | | | |
| IHLW Interim Storage Facility | 2093 | 2093 | a | a | a | a | a | a | a | a | a |
| Waste Treatment Plant | 2078 | 2079 | a | a | a | a | a | a | a | a | a |
| Modified sluicing retrieval system | 2013 | 2092 | 3.83×10 ² | 6.14×10 ¹ | 8.28×10 ⁻³ | 9.88×10 ⁻² | 7.31×10 ⁻⁴ | 4.75×10 ⁻³ | 1.61×10 ⁻³ | 3.29×10 ⁻⁴ | 2.44×10 ⁻⁶ |
| Mobile retrieval system | 2013 | 2052 | a | a | a | a | a | a | a | a | a |
| Vacuum-based retrieval system | 2053 | 2092 | 7.68 | 1.23 | 3.09×10 ⁻⁴ | 3.79×10 ⁻³ | 2.80×10 ⁻⁵ | 1.84×10 ⁻⁴ | 6.25×10 ⁻⁵ | 1.27×10 ⁻⁵ | 9.42×10 ⁻⁸ |
| Administrative controls | 2094 | 2193 | a | a | a | a | a | a | a | a | a |
| Waste Treatment Plant replacement | 2094 | 2095 | a | a | a | a | a | a | a | a | a |
| Cesium and Strontium Capsule Processing Facility | 2094 | 2094 | a | a | a | a | a | a | a | a | a |
| Effluent Treatment Facility original | 2026 | 2026 | a | a | a | a | a | a | a | a | a |

G-234

Table G-115. Tank Closure Alternative 2A Maximum Criteria Pollutant Concentrations of Peak Activity Periods (*continued*)

| Facility/System | Start Year | End Year | Concentration (micrograms per cubic meter) | | | | | | | | |
|---|------------|----------|--|----------------------|----------------------|----------------------------|----------------------|----------------------|----------------------|-----------|-----------------------|
| | | | Carbon Monoxide | | Nitrogen Dioxide | PM ₁₀ | | Sulfur Dioxide | | | |
| | | | 1-hour | 8-hour | Annual | 24-hour | Annual | 1-hour | 3-hour | 24-hour | Annual |
| | | | 2065-2066 | 2065-2066 | 2065-2066 | 2065-2066 | 2065-2066 | 2065-2066 | 2065-2066 | 2065-2066 | 2065-2066 |
| Deactivation (<i>continued</i>) | | | | | | | | | | | |
| Effluent Treatment Facility replacement 1 | 2056 | 2056 | a | a | a | a | a | a | a | a | a |
| Effluent Treatment Facility replacement 2 | 2096 | 2096 | a | a | a | a | a | a | a | a | a |
| Evaporator original | 2018 | 2018 | a | a | a | a | a | a | a | a | a |
| Evaporator replacement 1 | 2043 | 2043 | a | a | a | a | a | a | a | a | a |
| Evaporator replacement 2 | 2068 | 2068 | a | a | a | a | a | a | a | a | a |
| Evaporator replacement 3 | 2094 | 2094 | a | a | a | a | a | a | a | a | a |
| Closure | | | | | | | | | | | |
| Decontamination and decommissioning of 10 selected facilities | 2018 | 2028 | a | a | a | a | a | a | a | a | a |
| Total | | | 4.06×10⁴ | 6.01×10 ³ | 1.84×10 ¹ | 1.60×10³ | 1.55×10 ¹ | 6.46×10 ¹ | 2.51×10 ¹ | 4.40 | 8.27×10 ⁻² |

^a This activity would not contribute to the concentration during the peak year(s) for this pollutant and averaging period.

^b Emissions for this activity and pollutant were not calculated because they would be small compared with those for other activities under this alternative, as explained in Section G.2.

Note: Total concentrations exceeding applicable standards are presented in **bold**.

Key: HLW=high-level radioactive waste; IHLW=immobilized high-level radioactive waste; PM₁₀=particulate matter with an aerodynamic diameter less than or equal to 10 micrometers.

Source: SAIC 2007a, 2008.

Table G-116. Tank Closure Alternative 2A Maximum Toxic Pollutant Concentrations of Peak Activity Periods

| Facility/System | Start Year | End Year | Concentration (micrograms per cubic meter) | | | | | | |
|--|------------|----------|--|-----------------------|-----------------------|-----------------------|-----------------------|-----------------------|-----------------------|
| | | | Ammonia | Benzene | 1,3-Butadiene | Formaldehyde | Mercury | Toluene | Xylene |
| | | | 24-hour | Annual | Annual | Annual | 24-hour | 24-hour | 24-hour |
| | | | 2094 | 2065-2067 | 2065-2067 | 2065-2067 | 2078-2079 | 2065-2067 | 2065-2067 |
| Construction | | | | | | | | | |
| Underground transfer lines | 2009 | 2009 | a | a | a | a | a | a | a |
| Canister Storage Building | 2006 | 2016 | a | a | a | a | a | a | a |
| IHLW Shipping/Transfer Facility | 2011 | 2013 | a | a | a | a | a | a | a |
| IHLW Interim Storage Modules | 2014 | 2019 | a | a | a | a | a | a | a |
| Other infrastructure upgrades | 2006 | 2034 | a | a | a | a | a | a | a |
| Tank upgrades | 2006 | 2025 | a | a | a | a | a | a | a |
| Waste Treatment Plant | 2006 | 2017 | a | a | a | a | a | a | a |
| Cesium and Strontium Capsule Processing Facility | 2088 | 2091 | a | a | a | a | a | a | a |
| Tank risers | 2013 | 2056 | a | a | a | a | a | a | a |
| Modified sluicing retrieval system | 2013 | 2092 | a | b | b | b | b | b | b |
| Mobile retrieval system | 2013 | 2052 | a | a | a | a | a | a | a |
| Vacuum-based retrieval system | 2053 | 2092 | a | b | b | b | b | b | b |
| HLW Melter Interim Storage Facility 1 | 2015 | 2016 | a | a | a | a | a | a | a |
| HLW Melter Interim Storage Facility 2 | 2040 | 2041 | a | a | a | a | a | a | a |
| HLW Melter Interim Storage Facility 3 | 2065 | 2066 | a | b | b | b | a | b | b |
| Double-shell tank replacement | 2013 | 2054 | a | a | a | a | a | a | a |
| Waste Treatment Plant replacement | 2065 | 2076 | a | 5.27×10 ⁻³ | 1.46×10 ⁻⁴ | 4.76×10 ⁻³ | a | 3.37 | 1.01 |
| Underground transfer line replacement | 2044 | 2044 | a | a | a | a | a | a | a |
| Effluent Treatment Facility replacement 1 | 2023 | 2025 | a | a | a | a | a | a | a |
| Effluent Treatment Facility replacement 2 | 2053 | 2055 | a | a | a | a | a | a | a |
| Evaporator replacement 1 | 2015 | 2017 | a | a | a | a | a | a | a |
| Evaporator replacement 2 | 2040 | 2042 | a | a | a | a | a | a | a |
| Evaporator replacement 3 | 2065 | 2067 | a | 3.41×10 ⁻⁴ | 3.98×10 ⁻⁶ | 1.68×10 ⁻⁴ | a | 4.65×10 ⁻¹ | 1.32×10 ⁻¹ |
| Operations | | | | | | | | | |
| IHLW Interim Storage Facility | 2018 | 2092 | a | b | b | b | b | b | b |
| Other infrastructure upgrades | 2006 | 2092 | a | b | b | b | b | b | b |
| Routine operations | 2006 | 2092 | a | b | b | b | b | b | b |
| Retrieval operations | 2006 | 2092 | a | b | b | b | b | b | b |
| Double-shell tank interim stabilization | 2006 | 2092 | a | b | b | b | b | b | b |
| Waste Treatment Plant | 2018 | 2092 | a | 5.12×10 ⁻⁵ | 1.85×10 ⁻⁸ | 5.72×10 ⁻⁷ | 2.78×10 ⁻³ | 3.09×10 ⁻⁵ | 1.04×10 ⁻⁴ |
| Waste Treatment Plant, cesium and strontium capsules | 2093 | 2093 | a | a | a | a | a | a | a |
| Cesium and Strontium Capsule Processing Facility | 2092 | 2093 | a | a | a | a | a | a | a |
| Modified sluicing retrieval system | 2013 | 2092 | a | b | b | b | b | b | b |
| Mobile retrieval system | 2013 | 2052 | a | a | a | a | a | a | a |

Table G-116. Tank Closure Alternative 2A Maximum Toxic Pollutant Concentrations of Peak Activity Periods (continued)

| Facility/System | Start Year | End Year | Concentration (micrograms per cubic meter) | | | | | | |
|---|------------|----------|--|-----------------------|-----------------------|-----------------------|-----------------------|-----------------------|-----------------------|
| | | | Ammonia | Benzene | 1,3-Butadiene | Formaldehyde | Mercury | Toluene | Xylene |
| | | | 24-hour 2094 | Annual 2065-2067 | Annual 2065-2067 | Annual 2065-2067 | 24-hour 2078-2079 | 24-hour 2065-2067 | 24-hour 2065-2067 |
| Operations (continued) | | | | | | | | | |
| Vacuum-based retrieval system | 2053 | 2092 | a | b | b | b | b | b | b |
| HLW Melter Interim Storage Facility | 2018 | 2192 | b | b | b | b | b | b | b |
| Effluent Treatment Facility | 2006 | 2095 | 3.72×10 ⁻⁴ | 6.54×10 ⁻⁶ | 1.08×10 ⁻⁷ | 4.03×10 ⁻⁶ | b | 1.53×10 ⁻³ | 4.39×10 ⁻⁴ |
| Evaporator | 2006 | 2093 | a | 1.24×10 ⁻⁴ | 5.22×10 ⁻⁶ | 1.57×10 ⁻⁴ | b | 5.79×10 ⁻³ | 4.04×10 ⁻³ |
| Borrow Area C | 2006 | 2102 | 3.08×10 ⁻¹ | 1.24×10 ⁻⁴ | 4.04×10 ⁻⁶ | 1.27×10 ⁻⁴ | b | 2.28×10 ⁻¹ | 7.18×10 ⁻² |
| Deactivation | | | | | | | | | |
| IHLW Interim Storage Facility | 2093 | 2093 | a | a | a | a | a | a | a |
| Waste Treatment Plant | 2078 | 2079 | a | a | a | a | 3.12×10 ⁻³ | a | a |
| Modified sluicing retrieval system | 2013 | 2092 | a | b | b | b | b | b | b |
| Mobile retrieval system | 2013 | 2052 | a | a | a | a | a | a | a |
| Vacuum-based retrieval system | 2053 | 2092 | a | b | b | b | b | b | b |
| Administrative controls | 2094 | 2193 | 1.91×10 ¹ | a | a | a | a | a | a |
| Waste Treatment Plant replacement | 2094 | 2095 | 1.95×10 ⁻¹ | a | a | a | a | a | a |
| Cesium and Strontium Capsule Processing Facility | 2094 | 2094 | 2.26×10 ⁻³ | a | a | a | a | a | a |
| Effluent Treatment Facility original | 2026 | 2026 | a | a | a | a | a | a | a |
| Effluent Treatment Facility replacement 1 | 2056 | 2056 | a | a | a | a | a | a | a |
| Effluent Treatment Facility replacement 2 | 2096 | 2096 | a | a | a | a | a | a | a |
| Evaporator original | 2018 | 2018 | a | a | a | a | a | a | a |
| Evaporator replacement 1 | 2043 | 2043 | a | a | a | a | a | a | a |
| Evaporator replacement 2 | 2068 | 2068 | a | a | a | a | a | a | a |
| Evaporator replacement 3 | 2094 | 2094 | 6.44×10 ⁻³ | a | a | a | a | a | a |
| Closure | | | | | | | | | |
| Decontamination and decommissioning of 10 selected facilities | 2018 | 2028 | a | a | a | a | a | a | a |
| Total | | | 1.96×10 ¹ | 5.92×10 ⁻³ | 1.60×10 ⁻⁴ | 5.22×10 ⁻³ | 5.90×10 ⁻³ | 4.07 | 1.22 |

^a This activity would not contribute to the concentration during the peak year(s) for this pollutant and averaging period.

^b Emissions for this activity and pollutant were not calculated because they would be small compared with those for other activities under this alternative, as explained in Section G.2.

Key: HLW=high-level radioactive waste; IHLW=immobilized high-level radioactive waste.

Source: SAIC 2007a, 2008.

Table G-117. Tank Closure Alternative 2B Maximum Criteria Pollutant Concentrations of Peak Activity Periods

| Facility/System | Start Year | End Year | Concentration (micrograms per cubic meter) | | | | | | | | |
|--|------------|----------|--|-----------------------|-----------------------|-----------------------|-----------------------|-----------------------|-----------------------|-----------------------|-----------------------|
| | | | Carbon Monoxide | | Nitrogen Dioxide | PM ₁₀ | | Sulfur Dioxide | | | |
| | | | 1-hour | 8-hour | Annual | 24-hour | Annual | 1-hour | 3-hour | 24-hour | Annual |
| | | | 2015–2016 | 2040 | 2040 | 2040 | 2040 | 2040 | 2040 | 2040 | 2040 |
| Construction | | | | | | | | | | | |
| Canister Storage Building | 2006 | 2016 | 4.37×10 ¹ | a | a | a | a | a | a | a | a |
| IHLW Shipping/Transfer Facility | 2011 | 2013 | b | a | a | a | a | a | a | a | a |
| IHLW Interim Storage Modules | 2014 | 2022 | 3.15×10 ² | a | a | a | a | a | a | a | a |
| Other infrastructure upgrades | 2006 | 2034 | 1.80×10 ¹ | a | a | a | a | a | a | a | a |
| Tank upgrades | 2006 | 2025 | 5.67×10 ³ | a | a | a | a | a | a | a | a |
| Waste Treatment Plant | 2006 | 2017 | 1.72×10 ⁴ | a | a | a | a | a | a | a | a |
| Low-Activity Waste Vitrification Facility | 2008 | 2017 | 1.46×10 ³ | a | a | a | a | a | a | a | a |
| Cesium and Strontium Capsule Processing Facility | 2035 | 2038 | a | a | a | a | a | a | a | a | a |
| Waste receiver facilities | 2013 | 2017 | 1.87×10 ³ | a | a | a | a | a | a | a | a |
| Tank risers | 2013 | 2016 | 2.99×10 ² | a | a | a | a | a | a | a | a |
| Modified sluicing retrieval system | 2013 | 2043 | 1.66×10 ³ | 2.78×10 ² | 4.78×10 ⁻² | 2.31 | 2.65×10 ⁻² | 1.53×10 ⁻² | 5.61×10 ⁻³ | 1.00×10 ⁻³ | 1.15×10 ⁻⁵ |
| Mobile retrieval system | 2013 | 2028 | 1.02×10 ³ | a | a | a | a | a | a | a | a |
| Vacuum-based retrieval system | 2029 | 2043 | a | 1.74×10 ² | 2.52×10 ⁻¹ | 6.85 | 5.06×10 ⁻² | 1.56×10 ⁻¹ | 5.32×10 ⁻² | 1.08×10 ⁻² | 8.02×10 ⁻⁵ |
| HLW Melter Interim Storage Facility 1 | 2015 | 2016 | 1.39×10 ¹ | a | a | a | a | a | a | a | a |
| HLW Melter Interim Storage Facility 2 | 2029 | 2030 | a | a | a | a | a | a | a | a | a |
| Effluent Treatment Facility replacement 1 | 2023 | 2025 | a | a | a | a | a | a | a | a | a |
| Evaporator replacement 1 | 2015 | 2017 | 3.56×10 ³ | a | a | a | a | a | a | a | a |
| Underground transfer line 1,000-foot sections | 2009 | 2009 | a | a | a | a | a | a | a | a | a |
| Operations | | | | | | | | | | | |
| IHLW Interim Storage Facility | 2018 | 2066 | a | b | b | b | b | b | b | b | b |
| Other infrastructure upgrades | 2006 | 2043 | b | b | b | b | b | b | b | b | b |
| Routine operations | 2006 | 2043 | 5.72×10 ¹ | 1.50×10 ¹ | 8.27×10 ⁻² | b | b | b | b | b | b |
| Retrieval operations | 2006 | 2043 | 7.66×10 ⁻¹ | 1.23×10 ⁻¹ | 4.45×10 ⁻⁴ | b | b | b | b | b | b |
| Double-shell tank interim stabilization | 2006 | 2043 | 5.02 | 8.05×10 ⁻¹ | 2.92×10 ⁻³ | b | b | b | b | b | b |
| Waste Treatment Plant | 2018 | 2043 | a | 8.11×10 ¹ | 2.80 | 1.04 | 4.86×10 ⁻² | 3.01×10 ¹ | 1.85×10 ¹ | 3.09 | 1.44×10 ⁻¹ |
| Waste Treatment Plant, cesium and strontium capsules | 2040 | 2040 | a | 8.11×10 ¹ | 2.80 | 1.04 | 4.86×10 ⁻² | 3.01×10 ¹ | 1.85×10 ¹ | 3.09 | 1.44×10 ⁻¹ |
| Cesium and Strontium Capsule Processing Facility | 2039 | 2040 | a | 6.26×10 ¹ | 1.53×10 ⁻² | 4.00×10 ¹ | 6.56×10 ⁻¹ | 5.14×10 ⁻¹ | 1.76×10 ⁻¹ | 4.70×10 ⁻² | 7.71×10 ⁻⁴ |
| Modified sluicing retrieval system | 2013 | 2043 | 4.60×10 ² | 7.70×10 ¹ | 2.14×10 ⁻² | 1.44×10 ⁻¹ | 1.64×10 ⁻³ | 7.32×10 ⁻³ | 2.68×10 ⁻³ | 4.79×10 ⁻⁴ | 5.48×10 ⁻⁶ |
| Mobile retrieval system | 2013 | 2028 | 7.14 | a | a | a | a | a | a | a | a |
| Vacuum-based retrieval system | 2029 | 2043 | a | 1.19 | 4.30×10 ⁻³ | b | b | b | b | b | b |
| HLW Melter Interim Storage Facility | 2018 | 2145 | a | b | b | b | b | b | b | b | b |
| Effluent Treatment Facility | 2006 | 2045 | 7.85 | 2.41 | 1.02×10 ⁻² | 7.66×10 ¹ | 3.57 | 1.06×10 ⁻² | 6.52×10 ⁻³ | 1.09×10 ⁻³ | 5.08×10 ⁻⁵ |

Table G-117. Tank Closure Alternative 2B Maximum Criteria Pollutant Concentrations of Peak Activity Periods (continued)

| Facility/System | Start Year | End Year | Concentration (micrograms per cubic meter) | | | | | | | | |
|---|------------|----------|--|----------------------|-----------------------|----------------------------|-----------------------|-----------------------|-----------------------|-----------------------|-----------------------|
| | | | Carbon Monoxide | | Nitrogen Dioxide | PM ₁₀ | | Sulfur Dioxide | | | |
| | | | 1-hour | 8-hour | Annual | 24-hour | Annual | 1-hour | 3-hour | 24-hour | Annual |
| | | | 2015-2016 | 2040 | 2040 | 2040 | 2040 | 2040 | 2040 | 2040 | 2040 |
| Operations (continued) | | | | | | | | | | | |
| Evaporator replacement | 2006 | 2043 | 2.00×10 ² | 3.09×10 ¹ | 5.88×10 ⁻¹ | 1.87×10 ¹ | 1.76×10 ⁻¹ | 3.15×10 ⁻¹ | 1.13×10 ⁻¹ | 2.13×10 ⁻² | 2.00×10 ⁻⁴ |
| Borrow Area C | 2006 | 2052 | 6.91×10 ² | 2.83×10 ² | 4.42×10 ⁻¹ | 3.98×10 ² | 9.10×10 ⁻¹ | 9.72×10 ⁻¹ | 6.58×10 ⁻¹ | 2.07×10 ⁻¹ | 4.75×10 ⁻⁴ |
| Deactivation | | | | | | | | | | | |
| IHLW Interim Storage Facility | 2067 | 2067 | a | a | a | a | a | a | a | a | a |
| Waste Treatment Plant | 2044 | 2045 | a | a | a | a | a | a | a | a | a |
| Modified sluicing retrieval system | 2013 | 2043 | 1.18×10 ³ | 1.98×10 ² | 3.72×10 ⁻² | 2.87×10 ⁻¹ | 3.29×10 ⁻³ | 1.46×10 ⁻² | 5.35×10 ⁻³ | 9.57×10 ⁻⁴ | 1.10×10 ⁻⁵ |
| Mobile retrieval system | 2013 | 2028 | 5.09×10 ² | a | a | a | a | a | a | a | a |
| Vacuum-based retrieval system | 2029 | 2043 | a | 3.79 | 9.51×10 ⁻⁴ | 1.17×10 ⁻² | 8.65×10 ⁻⁵ | 5.66×10 ⁻⁴ | 1.93×10 ⁻⁴ | 3.93×10 ⁻⁵ | 2.90×10 ⁻⁷ |
| Cesium and Strontium Capsule Processing Facility | 2041 | 2041 | a | a | a | a | a | a | a | a | a |
| Effluent Treatment Facility original | 2026 | 2026 | a | a | a | a | a | a | a | a | a |
| Effluent Treatment Facility replacement | 2056 | 2056 | a | a | a | a | a | a | a | a | a |
| Evaporator original | 2018 | 2018 | a | a | a | a | a | a | a | a | a |
| Evaporator replacement | 2044 | 2044 | a | a | a | a | a | a | a | a | a |
| Closure | | | | | | | | | | | |
| Ancillary equipment grouting | 2013 | 2037 | 5.61 | a | a | a | a | a | a | a | a |
| Ancillary equipment removal | 2032 | 2037 | a | a | a | a | a | a | a | a | a |
| Decontamination and decommissioning of 10 selected facilities | 2018 | 2028 | a | a | a | a | a | a | a | a | a |
| Grout facility (tank-filling) construction | 2032 | 2033 | a | a | a | a | a | a | a | a | a |
| Grout facility (tank-filling) operations | 2034 | 2043 | a | 5.86×10 ¹ | 6.92×10 ⁻¹ | 5.08×10 ¹ | 3.76×10 ⁻¹ | 4.39×10 ⁻¹ | 1.49×10 ⁻¹ | 3.04×10 ⁻² | 2.25×10 ⁻⁴ |
| Grout facility (tank-filling) deactivation | 2044 | 2044 | a | a | a | a | a | a | a | a | a |
| Containment structure construction | 2028 | 2031 | a | a | a | a | a | a | a | a | a |
| BX and SX tank farm soil removal | 2032 | 2037 | a | a | a | a | a | a | a | a | a |
| Containment structure deactivation | 2038 | 2040 | a | 2.35×10 ² | 7.82×10 ⁻² | 3.48 | 2.58×10 ⁻² | 4.74×10 ⁻² | 1.61×10 ⁻² | 3.29×10 ⁻³ | 2.43×10 ⁻⁵ |
| Modified Resource Conservation and Recovery Act Subtitle C barrier construction | 2039 | 2045 | a | 4.26×10 ³ | 1.25×10 ¹ | 3.91×10 ³ | 2.89×10 ¹ | 3.68×10 ¹ | 1.25×10 ¹ | 2.55 | 1.89×10 ⁻² |
| Postclosure care | 2046 | 2145 | a | a | a | a | a | a | a | a | a |
| Total | | | 3.63×10 ⁴ | 5.84×10 ³ | 2.04×10 ¹ | 4.51×10³ | 3.48×10 ¹ | 9.94×10 ¹ | 5.06×10 ¹ | 9.05 | 3.08×10 ⁻¹ |

^a This activity would not contribute to the concentration during the peak year(s) for this pollutant and averaging period.

^b Emissions for this activity and pollutant were not calculated because they would be small compared with those for other activities under this alternative, as explained in Section G.2.

Note: Total concentrations exceeding applicable standards are presented in **bold**.

Key: HLW=high-level radioactive waste; IHLW=immobilized high-level radioactive waste; PM₁₀=particulate matter with an aerodynamic diameter less than or equal to 10 micrometers.

Source: SAIC 2007a, 2008.

Table G-118. Tank Closure Alternative 2B Maximum Toxic Pollutant Concentrations of Peak Activity Periods

| Facility/System | Start Year | End Year | Concentration (micrograms per cubic meter) | | | | | | |
|--|------------|----------|--|-----------------------|-----------------------|-----------------------|-----------|-----------------------|-----------------------|
| | | | Ammonia | Benzene | 1,3-Butadiene | Formaldehyde | Mercury | Toluene | Xylene |
| | | | 24-hour | Annual | Annual | Annual | 24-hour | 24-hour | 24-hour |
| | | | 2015-2016 | 2040 | 2040 | 2040 | 2044-2045 | 2040 | 2040 |
| Construction | | | | | | | | | |
| Canister Storage Building | 2006 | 2016 | b | a | a | a | a | a | a |
| IHLW Shipping/Transfer Facility | 2011 | 2013 | a | a | a | a | a | a | a |
| IHLW Interim Storage Modules | 2014 | 2022 | b | a | a | a | a | a | a |
| Other infrastructure upgrades | 2006 | 2034 | b | a | a | a | a | a | a |
| Tank upgrades | 2006 | 2025 | 8.81×10^{-2} | a | a | a | a | a | a |
| Waste Treatment Plant | 2006 | 2017 | 1.29 | a | a | a | a | a | a |
| Low-Activity Waste Vitrification Facility | 2008 | 2017 | 3.76×10^{-2} | a | a | a | a | a | a |
| Cesium and Strontium Capsule Processing Facility | 2035 | 2038 | a | a | a | a | a | a | a |
| Waste receiver facilities | 2013 | 2017 | b | a | a | a | a | a | a |
| Tank risers | 2013 | 2016 | 2.46 | a | a | a | a | a | a |
| Modified sluicing retrieval system | 2013 | 2043 | 3.52×10^{-1} | b | b | b | a | b | b |
| Mobile retrieval system | 2013 | 2028 | 2.81×10^{-1} | a | a | a | a | a | a |
| Vacuum-based retrieval system | 2029 | 2043 | a | b | b | b | a | b | b |
| HLW Melter Interim Storage Facility 1 | 2015 | 2016 | b | a | a | a | a | a | a |
| HLW Melter Interim Storage Facility 2 | 2029 | 2030 | a | a | a | a | a | a | a |
| Effluent Treatment Facility replacement 1 | 2023 | 2025 | a | a | a | a | a | a | a |
| Evaporator replacement 1 | 2015 | 2017 | 6.32×10^{-2} | a | a | a | a | a | a |
| Underground transfer line 1,000-foot sections | 2009 | 2009 | a | a | a | a | a | a | a |
| Operations | | | | | | | | | |
| IHLW Interim Storage Facility | 2018 | 2066 | a | b | b | b | b | b | b |
| Other infrastructure upgrades | 2006 | 2043 | b | b | b | b | a | b | b |
| Routine operations | 2006 | 2043 | 5.59 | b | b | b | a | b | b |
| Retrieval operations | 2006 | 2043 | 4.60×10^{-2} | b | b | b | a | b | b |
| Double-shell tank interim stabilization | 2006 | 2043 | 3.02×10^{-1} | b | b | b | a | b | b |
| Waste Treatment Plant | 2018 | 2043 | a | 1.19×10^{-4} | 4.31×10^{-8} | 1.33×10^{-6} | a | 7.21×10^{-5} | 2.43×10^{-4} |
| Waste Treatment Plant, cesium and strontium capsules | 2040 | 2040 | a | 1.19×10^{-4} | 4.31×10^{-8} | 1.33×10^{-6} | a | 7.21×10^{-5} | 2.43×10^{-4} |
| Cesium and Strontium Capsule Processing Facility | 2039 | 2040 | a | 7.41×10^{-5} | 4.19×10^{-7} | 2.51×10^{-5} | a | 6.94×10^{-2} | 1.96×10^{-2} |
| Modified sluicing retrieval system | 2013 | 2043 | 3.52×10^{-1} | b | b | b | a | b | b |
| Mobile retrieval system | 2013 | 2028 | 4.05×10^{-1} | a | a | a | a | a | a |
| Vacuum-based retrieval system | 2029 | 2043 | a | b | b | b | a | b | b |
| HLW Melter Interim Storage Facility | 2018 | 2145 | a | b | b | b | b | b | b |
| Effluent Treatment Facility | 2006 | 2045 | 3.72×10^{-4} | 6.54×10^{-6} | 1.08×10^{-7} | 4.03×10^{-6} | b | 1.53×10^{-3} | 4.39×10^{-4} |
| Evaporator | 2006 | 2043 | 9.82×10^{-2} | 1.24×10^{-4} | 5.22×10^{-6} | 1.57×10^{-4} | a | 5.79×10^{-3} | 4.04×10^{-3} |
| Borrow Area C | 2006 | 2052 | 3.08×10^{-1} | 1.24×10^{-4} | 4.04×10^{-6} | 1.27×10^{-4} | b | 2.28×10^{-1} | 7.18×10^{-2} |

Table G-118. Tank Closure Alternative 2B Maximum Toxic Pollutant Concentrations of Peak Activity Periods (continued)

| Facility/System | Start Year | End Year | Concentration (micrograms per cubic meter) | | | | | | |
|---|------------|----------|--|-----------------------|-----------------------|-----------------------|-----------------------|-----------------|-----------------------|
| | | | Ammonia | Benzene | 1,3-Butadiene | Formaldehyde | Mercury | Toluene | Xylene |
| | | | 24-hour 2015-2016 | Annual 2040 | Annual 2040 | Annual 2040 | 24-hour 2044-2045 | 24-hour 2040 | 24-hour 2040 |
| Deactivation | | | | | | | | | |
| IHLW Interim Storage Facility | 2067 | 2067 | a | a | a | a | a | a | a |
| Waste Treatment Plant | 2044 | 2045 | a | a | a | a | 1.17×10 ⁻¹ | a | a |
| Modified sluicing retrieval system | 2013 | 2043 | b | b | b | b | a | b | b |
| Mobile retrieval system | 2013 | 2028 | b | a | a | a | a | a | a |
| Vacuum-based retrieval system | 2029 | 2043 | a | b | b | b | a | b | b |
| Cesium and Strontium Capsule Processing Facility | 2041 | 2041 | a | a | a | a | a | a | a |
| Effluent Treatment Facility original | 2026 | 2026 | a | a | a | a | a | a | a |
| Effluent Treatment Facility replacement 1 | 2056 | 2056 | a | a | a | a | a | a | a |
| Evaporator original | 2018 | 2018 | a | a | a | a | a | a | a |
| Evaporator replacement 1 | 2044 | 2044 | a | a | a | a | b | a | a |
| Closure | | | | | | | | | |
| Ancillary equipment grouting | 2013 | 2037 | 3.03×10 ⁻⁵ | a | a | a | a | a | a |
| Ancillary equipment removal | 2032 | 2037 | a | a | a | a | a | a | a |
| Decontamination and decommissioning of 10 selected facilities | 2018 | 2028 | a | a | a | a | a | a | a |
| Grout facility (tank-filling) construction | 2032 | 2033 | a | a | a | a | a | a | a |
| Grout facility (tank-filling) operations | 2034 | 2043 | a | b | b | b | a | b | b |
| Grout facility (tank-filling) deactivation | 2044 | 2044 | a | a | a | a | b | a | a |
| Containment structure construction | 2028 | 2031 | a | a | a | a | a | a | a |
| BX and SX tank farm soil removal | 2032 | 2037 | a | a | a | a | a | a | a |
| Containment structure deactivation | 2038 | 2040 | a | b | b | b | a | b | b |
| Modified Resource Conservation and Recovery Act Subtitle C barrier construction | 2039 | 2045 | a | 4.00×10 ⁻³ | 1.16×10 ⁻⁴ | 3.74×10 ⁻³ | b | 3.09 | 9.37×10 ⁻¹ |
| Postclosure care | 2046 | 2145 | a | a | a | a | a | a | a |
| Total | | | 1.17×10 ¹ | 4.56×10 ⁻³ | 1.26×10 ⁻⁴ | 4.06×10 ⁻³ | 1.17×10 ⁻¹ | 3.40 | 1.03 |

^a This activity would not contribute to the concentration during the peak year(s) for this pollutant and averaging period.

^b Emissions for this activity and pollutant were not calculated because they would be small compared with those for other activities under this alternative, as explained in Section G.2.

Key: HLW=high-level radioactive waste; IHLW=immobilized high-level radioactive waste.

Source: SAIC 2007a, 2008.

Table G-119. Tank Closure Alternative 3A Maximum Criteria Pollutant Concentrations of Peak Activity Periods

| Facility/System | Start Year | End Year | Concentration (micrograms per cubic meter) | | | | | | | | |
|--|------------|----------|--|-----------------------|-----------------------|-----------------------|-----------------------|-----------------------|-----------------------|-----------------------|-----------------------|
| | | | Carbon Monoxide | | Nitrogen Dioxide | PM ₁₀ | | Sulfur Dioxide | | | |
| | | | 1-hour | 8-hour | Annual | 24-hour | Annual | 1-hour | 3-hour | 24-hour | Annual |
| | | | 2035-2036 | 2035-2036 | 2035-2036 | 2039 | 2039 | 2035-2036 | 2035-2036 | 2035-2036 | 2035-2036 |
| Construction | | | | | | | | | | | |
| Canister Storage Building | 2006 | 2016 | a | a | a | a | a | a | a | a | a |
| IHLW Shipping/Transfer Facility | 2011 | 2013 | a | a | a | a | a | a | a | a | a |
| IHLW Interim Storage Modules | 2014 | 2022 | a | a | a | a | a | a | a | a | a |
| Other infrastructure upgrades | 2006 | 2034 | a | a | a | a | a | a | a | a | a |
| Tank upgrades | 2006 | 2025 | a | a | a | a | a | a | a | a | a |
| Waste Treatment Plant | 2006 | 2017 | a | a | a | a | a | a | a | a | a |
| Cesium and Strontium Capsule Processing Facility | 2035 | 2038 | 1.89×10 ⁴ | 2.67×10 ³ | 1.54 | a | a | 2.55×10 ¹ | 8.50 | 1.46 | 1.42×10 ⁻² |
| Waste receiver facilities | 2013 | 2017 | a | a | a | a | a | a | a | a | a |
| Tank risers | 2013 | 2016 | a | a | a | a | a | a | a | a | a |
| Modified sluicing retrieval system | 2013 | 2039 | 1.90×10 ³ | 3.19×10 ² | 5.49×10 ⁻² | 2.66 | 3.04×10 ⁻² | 1.76×10 ⁻² | 6.44×10 ⁻³ | 1.15×10 ⁻³ | 1.32×10 ⁻⁵ |
| Mobile retrieval system | 2013 | 2026 | a | a | a | a | a | a | a | a | a |
| Vacuum-based retrieval system | 2027 | 2039 | 1.25×10 ³ | 2.01×10 ² | 2.91×10 ⁻¹ | 7.90 | 5.84×10 ⁻² | 1.81×10 ⁻¹ | 6.14×10 ⁻² | 1.25×10 ⁻² | 9.26×10 ⁻⁵ |
| HLW Melter Interim Storage Facility | 2015 | 2016 | a | a | a | a | a | a | a | a | a |
| Contact-Handled Mixed Transuranic Waste Facilities | 2008 | 2008 | a | a | a | a | a | a | a | a | a |
| Remote-Handled Mixed Transuranic Waste Facility | 2013 | 2014 | a | a | a | a | a | a | a | a | a |
| Transuranic Waste Interim Storage Facility | 2008 | 2009 | a | a | a | a | a | a | a | a | a |
| Bulk Vitrification Facility, 200-West Area | 2016 | 2017 | a | a | a | a | a | a | a | a | a |
| Solid-Liquid Separations Facility | 2016 | 2017 | a | a | a | a | a | a | a | a | a |
| Bulk Vitrification Facility, 200-East Area | 2016 | 2017 | a | a | a | a | a | a | a | a | a |
| Effluent Treatment Facility replacement 1 | 2023 | 2025 | a | a | a | a | a | a | a | a | a |
| Evaporator replacement 1 | 2015 | 2017 | a | a | a | a | a | a | a | a | a |
| Underground transfer line 1,000-foot sections | 2009 | 2009 | a | a | a | a | a | a | a | a | a |
| Operations | | | | | | | | | | | |
| IHLW Interim Storage Facility | 2018 | 2066 | b | b | b | b | b | b | b | b | b |
| Other infrastructure upgrades | 2006 | 2039 | b | b | b | b | b | b | b | b | b |
| Routine operations | 2006 | 2039 | 5.72×10 ¹ | 1.50×10 ¹ | 8.27×10 ⁻² | b | b | b | b | b | b |
| Retrieval operations | 2006 | 2039 | 7.66×10 ⁻¹ | 1.23×10 ⁻¹ | 4.45×10 ⁻⁴ | b | b | b | b | b | b |
| Double-shell tank interim stabilization | 2006 | 2039 | 5.02 | 8.05×10 ⁻¹ | 2.92×10 ⁻³ | b | b | b | b | b | b |
| Waste Treatment Plant | 2018 | 2039 | 1.13×10 ² | 3.47×10 ¹ | 1.19 | 4.15×10 ⁻¹ | 1.93×10 ⁻² | 1.21×10 ¹ | 7.45 | 1.25 | 5.81×10 ⁻² |
| Waste Treatment Plant, cesium and strontium capsules | 2040 | 2040 | a | a | a | a | a | a | a | a | a |
| Cesium and Strontium Capsule Processing Facility | 2039 | 2040 | a | a | a | 4.00×10 ¹ | 6.56×10 ⁻¹ | a | a | a | a |

Table G-119. Tank Closure Alternative 3A Maximum Criteria Pollutant Concentrations of Peak Activity Periods (continued)

| Facility/System | Start Year | End Year | Concentration (micrograms per cubic meter) | | | | | | | | |
|--|------------|----------|--|----------------------|-----------------------|-----------------------|-----------------------|-----------------------|-----------------------|-----------------------|-----------------------|
| | | | Carbon Monoxide | | Nitrogen Dioxide | PM ₁₀ | | Sulfur Dioxide | | | |
| | | | 1-hour | 8-hour | Annual | 24-hour | Annual | 1-hour | 3-hour | 24-hour | Annual |
| | | | 2035-2036 | 2035-2036 | 2035-2036 | 2039 | 2039 | 2035-2036 | 2035-2036 | 2035-2036 | 2035-2036 |
| Operations (continued) | | | | | | | | | | | |
| Modified sluicing retrieval system | 2013 | 2039 | 5.28×10 ² | 8.85×10 ¹ | 2.45×10 ⁻² | 1.65×10 ⁻¹ | 1.89×10 ⁻³ | 8.41×10 ⁻³ | 3.07×10 ⁻³ | 5.50×10 ⁻⁴ | 6.29×10 ⁻⁶ |
| Mobile retrieval system | 2013 | 2026 | a | a | a | a | a | a | a | a | a |
| Vacuum-based retrieval system | 2027 | 2039 | 8.54 | 1.37 | 4.97×10 ⁻³ | b | b | b | b | b | b |
| HLW Melter Interim Storage Facility | 2018 | 2141 | b | b | b | b | b | b | b | b | b |
| Contact-Handled Mixed Transuranic Waste Facilities | 2009 | 2010 | a | a | a | a | a | a | a | a | a |
| Remote-Handled Mixed Transuranic Waste Facility | 2015 | 2019 | a | a | a | a | a | a | a | a | a |
| Transuranic Waste Interim Storage Facility | 2009 | 2034 | a | a | a | a | a | a | a | a | a |
| Bulk Vitrification Facility, 200-West Area | 2018 | 2039 | 3.98×10 ¹ | 1.09×10 ¹ | 8.08×10 ⁻² | 1.19 | 8.56×10 ⁻³ | 2.27×10 ¹ | 9.60 | 3.00 | 2.16×10 ⁻² |
| Solid-Liquid Separations Facility | 2018 | 2039 | 3.04×10 ³ | 4.35×10 ² | 1.29×10 ⁻¹ | 2.13 | 8.93×10 ⁻³ | 4.09 | 1.36 | 2.44×10 ⁻¹ | 1.02×10 ⁻³ |
| Bulk Vitrification Facility, 200-East Area | 2018 | 2039 | 2.28×10 ¹ | 4.89 | 1.38×10 ⁻¹ | 7.85×10 ⁻¹ | 1.47×10 ⁻² | 2.24×10 ¹ | 7.80 | 1.95 | 3.64×10 ⁻² |
| Effluent Treatment Facility | 2006 | 2042 | 7.85 | 2.41 | 1.02×10 ⁻² | 7.66×10 ¹ | 3.57 | 1.06×10 ⁻² | 6.52×10 ⁻³ | 1.09×10 ⁻³ | 5.08×10 ⁻⁵ |
| Evaporator | 2006 | 2040 | 2.00×10 ² | 3.09×10 ¹ | 5.88×10 ⁻¹ | 1.87×10 ¹ | 1.76×10 ⁻¹ | 3.15×10 ⁻¹ | 1.13×10 ⁻¹ | 2.13×10 ⁻² | 2.00×10 ⁻⁴ |
| Borrow Area C | 2006 | 2052 | 6.91×10 ² | 2.83×10 ² | 4.42×10 ⁻¹ | 3.98×10 ² | 9.10×10 ⁻¹ | 9.72×10 ⁻¹ | 6.58×10 ⁻¹ | 2.07×10 ⁻¹ | 4.75×10 ⁻⁴ |
| Deactivation | | | | | | | | | | | |
| Modified sluicing retrieval system | 2013 | 2039 | 1.36×10 ³ | 2.27×10 ² | 4.28×10 ⁻² | 3.30×10 ⁻¹ | 3.77×10 ⁻³ | 1.68×10 ⁻² | 6.15×10 ⁻³ | 1.10×10 ⁻³ | 1.26×10 ⁻⁵ |
| Mobile retrieval system | 2013 | 2026 | a | a | a | a | a | a | a | a | a |
| Vacuum-based retrieval system | 2027 | 2039 | 2.73×10 ¹ | 4.38 | 1.10×10 ⁻³ | 1.35×10 ⁻² | 9.98×10 ⁻⁵ | 6.54×10 ⁻⁴ | 2.22×10 ⁻⁴ | 4.53×10 ⁻⁵ | 3.35×10 ⁻⁷ |
| IHLW Interim Storage Facility | 2067 | 2067 | a | a | a | a | a | a | a | a | a |
| Waste Treatment Plant | 2041 | 2042 | a | a | a | a | a | a | a | a | a |
| Cesium and Strontium Capsule Processing Facility | 2041 | 2041 | a | a | a | a | a | a | a | a | a |
| Contact-Handled Mixed Transuranic Waste Facilities | 2011 | 2012 | a | a | a | a | a | a | a | a | a |
| Remote-Handled Mixed Transuranic Waste Facility | 2020 | 2021 | a | a | a | a | a | a | a | a | a |
| Transuranic Waste Interim Storage Facility | 2035 | 2035 | b | b | b | a | a | b | b | b | b |
| Bulk Vitrification Facility, 200-West Area | 2040 | 2041 | a | a | a | a | a | a | a | a | a |
| Solid-Liquid Separations Facility | 2040 | 2041 | a | a | a | a | a | a | a | a | a |
| Bulk Vitrification Facility, 200-East Area | 2040 | 2041 | a | a | a | a | a | a | a | a | a |
| Effluent Treatment Facility original | 2026 | 2026 | a | a | a | a | a | a | a | a | a |
| Effluent Treatment Facility replacement | 2043 | 2043 | a | a | a | a | a | a | a | a | a |
| Evaporator original | 2018 | 2018 | a | a | a | a | a | a | a | a | a |
| Evaporator replacement | 2041 | 2041 | a | a | a | a | a | a | a | a | a |

Table G-119. Tank Closure Alternative 3A Maximum Criteria Pollutant Concentrations of Peak Activity Periods (continued)

| Facility/System | Start Year | End Year | Concentration (micrograms per cubic meter) | | | | | | | | |
|---|------------|----------|--|----------------------------|----------------------------|----------------------------|----------------------------|----------------------------|----------------------------|----------------------------|-----------------------------|
| | | | Carbon Monoxide | | Nitrogen Dioxide | PM ₁₀ | | Sulfur Dioxide | | | |
| | | | 1-hour | 8-hour | Annual | 24-hour | Annual | 1-hour | 3-hour | 24-hour | Annual |
| | | | 2035–2036 | 2035–2036 | 2035–2036 | 2039 | 2039 | 2035–2036 | 2035–2036 | 2035–2036 | 2035–2036 |
| Closure | | | | | | | | | | | |
| Grout facility (tank-filling) construction | 2028 | 2029 | a | a | a | a | a | a | a | a | a |
| Grout facility (tank-filling) operations | 2030 | 2039 | 3.66×10 ² | 5.86×10 ¹ | 6.92×10 ⁻¹ | 5.08×10 ¹ | 3.76×10 ⁻¹ | 4.39×10 ⁻¹ | 1.49×10 ⁻¹ | 3.04×10 ⁻² | 2.25×10 ⁻⁴ |
| Grout facility (tank-filling) deactivation | 2040 | 2040 | a | a | a | a | a | a | a | a | a |
| Ancillary equipment grouting | 2012 | 2032 | a | a | a | a | a | a | a | a | a |
| Ancillary equipment removal | 2028 | 2033 | a | a | a | a | a | a | a | a | a |
| BX and SX tank farm soil removal | 2028 | 2033 | a | a | a | a | a | a | a | a | a |
| Containment structure construction | 2024 | 2027 | a | a | a | a | a | a | a | a | a |
| Containment structure deactivation | 2034 | 2036 | 1.47×10 ³ | 2.35×10 ² | 7.82×10 ⁻² | a | a | 4.74×10 ⁻² | 1.61×10 ⁻² | 3.29×10 ⁻³ | 2.43×10 ⁻⁵ |
| Modified Resource Conservation and Recovery Act Subtitle C barrier construction | 2035 | 2041 | 2.66×10 ⁴ | 4.26×10 ³ | 1.25×10 ¹ | 3.91×10 ³ | 2.89×10 ¹ | 3.68×10 ¹ | 1.25×10 ¹ | 2.55 | 1.89×10 ⁻² |
| Decontamination and decommissioning of 10 selected facilities | 2018 | 2028 | a | a | a | a | a | a | a | a | a |
| Postclosure care | 2042 | 2141 | a | a | a | a | a | a | a | a | a |
| Total | | | 5.66×10⁴ | 8.88×10³ | 1.79×10¹ | 4.51×10³ | 3.48×10¹ | 1.26×10² | 4.83×10¹ | 1.07×10¹ | 1.51×10⁻¹ |

^a This activity would not contribute to the concentration during the peak year(s) for this pollutant and averaging period.

^b Emissions for this activity and pollutant were not calculated because they would be small compared with those for other activities under this alternative, as explained in Section G.2.

Note: Total concentrations exceeding applicable standards are presented in **bold**.

Key: HLW=high-level radioactive waste; IHLW=immobilized high-level radioactive waste; PM₁₀=particulate matter with an aerodynamic diameter less than or equal to 10 micrometers.

Source: SAIC 2007a, 2008.

Table G-120. Tank Closure Alternative 3A Maximum Toxic Pollutant Concentrations of Peak Activity Periods

| Facility/System | Start Year | End Year | Concentration (micrograms per cubic meter) | | | | | | |
|--|------------|----------|--|-----------------------|-----------------------|-----------------------|-----------------------|-----------------------|-----------------------|
| | | | Ammonia | Benzene | 1,3-Butadiene | Formaldehyde | Mercury | Toluene | Xylene |
| | | | 24-hour | Annual | Annual | Annual | 24-hour | 24-hour | 24-hour |
| | | | 2094 | 2065-2067 | 2065-2067 | 2065-2067 | 2078-2079 | 2065-2067 | 2065-2067 |
| Construction | | | | | | | | | |
| Canister Storage Building | 2006 | 2016 | b | a | a | a | a | a | a |
| IHLW Shipping/Transfer Facility | 2011 | 2013 | a | a | a | a | a | a | a |
| IHLW Interim Storage Modules | 2014 | 2022 | b | a | a | a | b | a | a |
| Other infrastructure upgrades | 2006 | 2034 | b | a | a | a | b | a | a |
| Tank upgrades | 2006 | 2025 | 8.81×10^{-2} | a | a | a | b | a | a |
| Waste Treatment Plant | 2006 | 2017 | 1.29 | a | a | a | a | a | a |
| Cesium and Strontium Capsule Processing Facility | 2035 | 2038 | a | 1.60×10^{-3} | 1.87×10^{-5} | 7.88×10^{-4} | b | 2.10 | 5.97×10^{-1} |
| Waste receiver facilities | 2013 | 2017 | b | a | a | a | a | a | a |
| Tank risers | 2013 | 2016 | 2.46 | a | a | a | a | a | a |
| Modified sluicing retrieval system | 2013 | 2039 | 4.04×10^{-1} | b | b | b | b | b | b |
| Mobile retrieval system | 2013 | 2026 | 3.21×10^{-1} | a | a | a | b | a | a |
| Vacuum-based retrieval system | 2027 | 2039 | a | b | b | b | b | b | b |
| HLW Melter Interim Storage Facility | 2015 | 2016 | b | a | a | a | a | a | a |
| Contact-Handled Mixed Transuranic Waste Facilities | 2008 | 2008 | a | a | a | a | a | a | a |
| Remote-Handled Mixed Transuranic Waste Facility | 2013 | 2014 | a | a | a | a | a | a | a |
| Transuranic Waste Interim Storage Facility | 2008 | 2009 | a | a | a | a | a | a | a |
| Bulk Vitrification Facility, 200-West Area | 2016 | 2017 | 3.23×10^{-2} | a | a | a | a | a | a |
| Solid-Liquid Separations Facility | 2016 | 2017 | 3.04×10^{-2} | a | a | a | a | a | a |
| Bulk Vitrification Facility, 200-East Area | 2016 | 2017 | 1.82×10^{-2} | a | a | a | a | a | a |
| Effluent Treatment Facility replacement 1 | 2023 | 2025 | a | a | a | a | b | a | a |
| Evaporator replacement 1 | 2015 | 2017 | 6.32×10^{-2} | a | a | a | a | a | a |
| Underground transfer line 1,000-foot sections | 2009 | 2009 | a | a | a | a | a | a | a |
| Operations | | | | | | | | | |
| IHLW Interim Storage Facility | 2018 | 2066 | a | b | b | b | b | b | b |
| Other infrastructure upgrades | 2006 | 2039 | b | b | b | b | b | b | b |
| Routine operations | 2006 | 2039 | 5.59 | b | b | b | b | b | b |
| Retrieval operations | 2006 | 2039 | 4.60×10^{-2} | b | b | b | b | b | b |
| Double-shell tank interim stabilization | 2006 | 2039 | 3.02×10^{-1} | b | b | b | b | b | b |
| Waste Treatment Plant | 2018 | 2039 | a | 5.10×10^{-5} | 1.84×10^{-8} | 5.70×10^{-7} | 7.02×10^{-3} | 3.09×10^{-5} | 1.04×10^{-4} |
| Waste Treatment Plant, cesium and strontium capsules | 2040 | 2040 | a | a | a | a | a | a | a |
| Cesium and Strontium Capsule Processing Facility | 2039 | 2040 | a | a | a | a | b | a | a |
| Modified sluicing retrieval system | 2013 | 2039 | 4.04×10^{-1} | b | b | b | b | b | b |

Table G-120. Tank Closure Alternative 3A Maximum Toxic Pollutant Concentrations of Peak Activity Periods (continued)

| Facility/System | Start Year | End Year | Concentration (micrograms per cubic meter) | | | | | | |
|--|------------|----------|--|-----------------------|------------------------|-----------------------|-----------------------|-----------------------|-----------------------|
| | | | Ammonia | Benzene | 1,3-Butadiene | Formaldehyde | Mercury | Toluene | Xylene |
| | | | 24-hour 2094 | Annual 2065-2067 | Annual 2065-2067 | Annual 2065-2067 | 24-hour 2078-2079 | 24-hour 2065-2067 | 24-hour 2065-2067 |
| Operations (continued) | | | | | | | | | |
| Mobile retrieval system | 2013 | 2026 | 4.63×10 ⁻¹ | a | a | a | b | a | a |
| Vacuum-based retrieval system | 2027 | 2039 | a | b | b | b | b | b | b |
| HLW Melter Interim Storage Facility | 2018 | 2141 | a | b | b | b | b | b | b |
| Contact-Handled Mixed Transuranic Waste Facilities | 2009 | 2010 | a | a | a | a | a | a | a |
| Remote-Handled Mixed Transuranic Waste Facility | 2015 | 2019 | 1.99×10 ⁻³ | a | a | a | b | a | a |
| Transuranic Waste Interim Storage Facility | 2009 | 2034 | b | a | a | a | b | a | a |
| Bulk Vitrification Facility, 200-West Area | 2018 | 2039 | a | 1.06×10 ⁻⁶ | 1.23×10 ⁻¹⁰ | 5.20×10 ⁻⁹ | 6.72×10 ⁻³ | 1.91×10 ⁻⁵ | 5.44×10 ⁻⁵ |
| Solid-Liquid Separations Facility | 2018 | 2039 | a | 1.18×10 ⁻⁴ | 1.51×10 ⁻⁶ | 5.53×10 ⁻⁵ | b | 3.49×10 ⁻¹ | 9.96×10 ⁻² |
| Bulk Vitrification Facility, 200-East Area | 2018 | 2039 | a | 1.12×10 ⁻⁶ | 1.75×10 ⁻¹⁰ | 6.63×10 ⁻⁹ | 3.13×10 ⁻³ | 6.71×10 ⁻⁶ | 1.93×10 ⁻⁵ |
| Effluent Treatment Facility | 2006 | 2042 | 3.72×10 ⁻⁴ | 6.54×10 ⁻⁶ | 1.08×10 ⁻⁷ | 4.03×10 ⁻⁶ | b | 1.53×10 ⁻³ | 4.39×10 ⁻⁴ |
| Evaporator | 2006 | 2040 | 9.82×10 ⁻² | 1.24×10 ⁻⁴ | 5.22×10 ⁻⁶ | 1.57×10 ⁻⁴ | b | 5.79×10 ⁻³ | 4.04×10 ⁻³ |
| Borrow Area C | 2006 | 2052 | 3.08×10 ⁻¹ | 1.24×10 ⁻⁴ | 4.04×10 ⁻⁶ | 1.27×10 ⁻⁴ | b | 2.28×10 ⁻¹ | 7.18×10 ⁻² |
| Deactivation | | | | | | | | | |
| Modified sluicing retrieval system | 2013 | 2039 | b | b | b | b | b | b | b |
| Mobile retrieval system | 2013 | 2026 | b | a | a | a | b | a | a |
| Vacuum-based retrieval system | 2027 | 2039 | a | b | b | b | b | b | b |
| IHLW Interim Storage Facility | 2067 | 2067 | a | a | a | a | a | a | a |
| Waste Treatment Plant | 2041 | 2042 | a | a | a | a | a | a | a |
| Cesium and Strontium Capsule Processing Facility | 2041 | 2041 | a | a | a | a | a | a | a |
| Contact-Handled Mixed Transuranic Waste Facilities | 2011 | 2012 | a | a | a | a | a | a | a |
| Remote-Handled Mixed Transuranic Waste Facility | 2020 | 2021 | a | a | a | a | b | a | a |
| Transuranic Waste Interim Storage Facility | 2035 | 2035 | a | b | b | b | b | b | b |
| Bulk Vitrification Facility, 200-West Area | 2040 | 2041 | a | a | a | a | a | a | a |
| Solid-Liquid Separations Facility | 2040 | 2041 | a | a | a | a | a | a | a |
| Bulk Vitrification Facility, 200-East Area | 2040 | 2041 | a | a | a | a | a | a | a |
| Effluent Treatment Facility original | 2026 | 2026 | a | a | a | a | b | a | a |
| Effluent Treatment Facility replacement 1 | 2043 | 2043 | a | a | a | a | a | a | a |
| Evaporator original | 2018 | 2018 | a | a | a | a | b | a | a |
| Evaporator replacement 1 | 2041 | 2041 | a | a | a | a | a | a | a |
| Closure | | | | | | | | | |
| Grout facility (tank-filling) construction | 2028 | 2029 | a | a | a | a | b | a | a |
| Grout facility (tank-filling) operations | 2030 | 2039 | a | b | b | b | b | b | b |
| Grout facility (tank-filling) deactivation | 2040 | 2040 | a | a | a | a | a | a | a |
| Ancillary equipment grouting | 2012 | 2032 | 3.61×10 ⁻⁵ | a | a | a | b | a | a |

Table G-120. Tank Closure Alternative 3A Maximum Toxic Pollutant Concentrations of Peak Activity Periods (continued)

| Facility/System | Start Year | End Year | Concentration (micrograms per cubic meter) | | | | | | |
|---|------------|----------|--|-----------------------|-----------------------|-----------------------|-----------------------|----------------------|-----------------------|
| | | | Ammonia | Benzene | 1,3-Butadiene | Formaldehyde | Mercury | Toluene | Xylene |
| | | | 24-hour 2094 | Annual 2065-2067 | Annual 2065-2067 | Annual 2065-2067 | 24-hour 2078-2079 | 24-hour 2065-2067 | 24-hour 2065-2067 |
| Closure (continued) | | | | | | | | | |
| Ancillary equipment removal | 2028 | 2033 | a | a | a | a | b | a | a |
| BX and SX tank farm soil removal | 2028 | 2033 | a | a | a | a | b | a | a |
| Containment structure construction | 2024 | 2027 | a | a | a | a | b | a | a |
| Containment structure deactivation | 2034 | 2036 | a | b | b | b | b | b | b |
| Modified Resource Conservation and Recovery Act Subtitle C barrier construction | 2035 | 2041 | a | 4.00×10^{-3} | 1.16×10^{-4} | 3.74×10^{-3} | b | 3.09 | 9.37×10^{-1} |
| Decontamination and decommissioning of 10 selected facilities | 2018 | 2028 | a | a | a | a | b | a | a |
| Postclosure care | 2042 | 2141 | a | a | a | a | a | a | a |
| Total | | | 1.19×10^1 | 6.02×10^{-3} | 1.46×10^{-4} | 4.87×10^{-3} | 1.69×10^{-2} | 5.78 | 1.71 |

^a This activity would not contribute to the concentration during the peak year(s) for this pollutant and averaging period.

^b Emissions for this activity and pollutant were not calculated because they would be small compared with those for other activities under this alternative, as explained in Section G.2.

Note: Total concentrations exceeding applicable standards are presented in **bold**.

Key: HLW=high-level radioactive waste; IHLW=immobilized high-level radioactive waste.

Source: SAIC 2007a, 2008.

Table G-121. Tank Closure Alternative 3B Maximum Criteria Pollutant Concentrations of Peak Activity Periods

| Facility/System | Start Year | End Year | Concentration (micrograms per cubic meter) | | | | | | | | |
|--|------------|----------|--|-----------------------|-----------------------|-----------------------|-----------------------|-----------------------|-----------------------|-----------------------|-----------------------|
| | | | Carbon Monoxide | | Nitrogen Dioxide | PM ₁₀ | | Sulfur Dioxide | | | |
| | | | 1-hour | 8-hour | Annual | 24-hour | Annual | 1-hour | 3-hour | 24-hour | Annual |
| | | | 2035-2036 | 2035-2036 | 2035-2036 | 2039 | 2039 | 2035-2036 | 2035-2036 | 2035-2036 | 2035-2036 |
| Construction | | | | | | | | | | | |
| Canister Storage Building | 2006 | 2016 | a | a | a | a | a | a | a | a | a |
| IHLW Shipping/Transfer Facility | 2011 | 2013 | a | a | a | a | a | a | a | a | a |
| IHLW Interim Storage Modules | 2014 | 2022 | a | a | a | a | a | a | a | a | a |
| Other infrastructure upgrades | 2006 | 2034 | a | a | a | a | a | a | a | a | a |
| Tank upgrades | 2006 | 2025 | a | a | a | a | a | a | a | a | a |
| Waste Treatment Plant | 2006 | 2017 | a | a | a | a | a | a | a | a | a |
| Cesium and Strontium Capsule Processing Facility | 2035 | 2038 | 1.89×10 ⁴ | 2.67×10 ³ | 1.54 | a | a | 2.55×10 ¹ | 8.50 | 1.46 | 1.42×10 ⁻² |
| Waste receiver facilities | 2013 | 2017 | a | a | a | a | a | a | a | a | a |
| Tank risers | 2013 | 2016 | a | a | a | a | a | a | a | a | a |
| Modified sluicing retrieval system | 2013 | 2039 | 1.90×10 ³ | 3.19×10 ² | 5.49×10 ⁻² | 2.66 | 3.04×10 ⁻² | 1.76×10 ⁻² | 6.44×10 ⁻³ | 1.15×10 ⁻³ | 1.32×10 ⁻⁵ |
| Mobile retrieval system | 2013 | 2026 | a | a | a | a | a | a | a | a | a |
| Vacuum-based retrieval system | 2027 | 2039 | 1.25×10 ³ | 2.01×10 ² | 2.91×10 ⁻¹ | 7.90 | 5.84×10 ⁻² | 1.81×10 ⁻¹ | 6.14×10 ⁻² | 1.25×10 ⁻² | 9.26×10 ⁻⁵ |
| HLW Melter Interim Storage Facility | 2015 | 2016 | a | a | a | a | a | a | a | a | a |
| Contact-Handled Mixed Transuranic Waste Facilities | 2008 | 2008 | a | a | a | a | a | a | a | a | a |
| Remote-Handled Mixed Transuranic Waste Facility | 2013 | 2014 | a | a | a | a | a | a | a | a | a |
| Transuranic Waste Interim Storage Facility | 2008 | 2009 | a | a | a | a | a | a | a | a | a |
| Cast Stone Facility, 200-West Area | 2016 | 2017 | a | a | a | a | a | a | a | a | a |
| Solid-Liquid Separations Facility | 2016 | 2017 | a | a | a | a | a | a | a | a | a |
| Cast Stone Facility, 200-East Area | 2016 | 2017 | a | a | a | a | a | a | a | a | a |
| Effluent Treatment Facility replacement 1 | 2023 | 2025 | a | a | a | a | a | a | a | a | a |
| Evaporator replacement 1 | 2015 | 2017 | a | a | a | a | a | a | a | a | a |
| Underground transfer line 1,000-foot sections | 2009 | 2009 | a | a | a | a | a | a | a | a | a |
| Operations | | | | | | | | | | | |
| IHLW Interim Storage Facility | 2018 | 2066 | b | b | b | b | b | b | b | b | b |
| Other infrastructure upgrades | 2006 | 2039 | b | b | b | b | b | b | b | b | b |
| Routine operations | 2006 | 2039 | 5.72×10 ¹ | 1.50×10 ¹ | 8.27×10 ⁻² | b | b | b | b | b | b |
| Retrieval operations | 2006 | 2039 | 7.66×10 ⁻¹ | 1.23×10 ⁻¹ | 4.45×10 ⁻⁴ | b | b | b | b | b | b |
| Double-shell tank interim stabilization | 2006 | 2039 | 5.02 | 8.05×10 ⁻¹ | 2.92×10 ⁻³ | b | b | b | b | b | b |
| Waste Treatment Plant | 2018 | 2039 | 1.13×10 ² | 3.47×10 ¹ | 1.19 | 4.15×10 ⁻¹ | 1.93×10 ⁻² | 1.21×10 ¹ | 7.45 | 1.25 | 5.81×10 ⁻² |
| Waste Treatment Plant, cesium and strontium capsules | 2040 | 2040 | a | a | a | a | a | a | a | a | a |

Table G–121. Tank Closure Alternative 3B Maximum Criteria Pollutant Concentrations of Peak Activity Periods (continued)

| Facility/System | Start Year | End Year | Concentration (micrograms per cubic meter) | | | | | | | | |
|--|------------|----------|--|----------------------|-----------------------|-----------------------|-----------------------|-----------------------|-----------------------|-----------------------|-----------------------|
| | | | Carbon Monoxide | | Nitrogen Dioxide | PM ₁₀ | | Sulfur Dioxide | | | |
| | | | 1-hour | 8-hour | Annual | 24-hour | Annual | 1-hour | 3-hour | 24-hour | Annual |
| | | | 2035–2036 | 2035–2036 | 2035–2036 | 2039 | 2039 | 2035–2036 | 2035–2036 | 2035–2036 | 2035–2036 |
| Operations (continued) | | | | | | | | | | | |
| Cesium and Strontium Capsule Processing Facility | 2039 | 2040 | a | a | a | 4.00×10 ¹ | 6.56×10 ⁻¹ | a | a | a | a |
| Modified sluicing retrieval system | 2013 | 2039 | 5.28×10 ² | 8.85×10 ¹ | 2.45×10 ⁻² | 1.65×10 ⁻¹ | 1.89×10 ⁻³ | 8.41×10 ⁻³ | 3.07×10 ⁻³ | 5.50×10 ⁻⁴ | 6.29×10 ⁻⁶ |
| Mobile retrieval system | 2013 | 2026 | a | a | a | a | a | a | a | a | a |
| Vacuum-based retrieval system | 2027 | 2039 | 8.54 | 1.37 | 4.97×10 ⁻³ | b | b | b | b | b | b |
| HLW Melter Interim Storage Facility | 2018 | 2141 | b | b | b | b | b | b | b | b | b |
| Contact-Handled Mixed Transuranic Waste Facilities | 2009 | 2010 | a | a | a | a | a | a | a | a | a |
| Remote-Handled Mixed Transuranic Waste Facility | 2015 | 2019 | a | a | a | a | a | a | a | a | a |
| Transuranic Waste Interim Storage Facility | 2009 | 2034 | a | a | a | a | a | a | a | a | a |
| Cast Stone Facility, 200-West Area | 2018 | 2039 | 7.58×10 ² | 2.07×10 ² | 1.56×10 ⁻¹ | 1.52 | 1.09×10 ⁻² | 1.02 | 4.33×10 ⁻¹ | 1.35×10 ⁻¹ | 9.75×10 ⁻⁴ |
| Solid-Liquid Separations Facility | 2018 | 2039 | 3.04×10 ³ | 4.35×10 ² | 1.29×10 ⁻¹ | 2.13 | 8.93×10 ⁻³ | 4.09 | 1.36 | 2.44×10 ⁻¹ | 1.02×10 ⁻³ |
| Cast Stone Facility, 200-East Area | 2018 | 2039 | 4.18×10 ² | 8.95×10 ¹ | 2.61×10 ⁻¹ | 9.88×10 ⁻¹ | 1.85×10 ⁻² | 5.68×10 ⁻¹ | 1.98×10 ⁻¹ | 4.95×10 ⁻² | 9.25×10 ⁻⁴ |
| Effluent Treatment Facility | 2006 | 2042 | 7.85 | 2.41 | 1.02×10 ⁻² | 7.66×10 ¹ | 3.57 | 1.06×10 ⁻² | 6.52×10 ⁻³ | 1.09×10 ⁻³ | 5.08×10 ⁻⁵ |
| Evaporator | 2006 | 2040 | 2.00×10 ² | 3.09×10 ¹ | 5.88×10 ⁻¹ | 1.87×10 ¹ | 1.76×10 ⁻¹ | 3.15×10 ⁻¹ | 1.13×10 ⁻¹ | 2.13×10 ⁻² | 2.00×10 ⁻⁴ |
| Borrow Area C | 2006 | 2052 | 6.91×10 ² | 2.83×10 ² | 4.42×10 ⁻¹ | 3.98×10 ² | 9.10×10 ⁻¹ | 9.72×10 ⁻¹ | 6.58×10 ⁻¹ | 2.07×10 ⁻¹ | 4.75×10 ⁻⁴ |
| Deactivation | | | | | | | | | | | |
| Modified sluicing retrieval system | 2013 | 2039 | 1.36×10 ³ | 2.27×10 ² | 4.28×10 ⁻² | 3.30×10 ⁻¹ | 3.77×10 ⁻³ | 1.68×10 ⁻² | 6.15×10 ⁻³ | 1.10×10 ⁻³ | 1.26×10 ⁻⁵ |
| Mobile retrieval system | 2013 | 2026 | a | a | a | a | a | a | a | a | a |
| Vacuum-based retrieval system | 2027 | 2039 | 2.73×10 ¹ | 4.38 | 1.10×10 ⁻³ | 1.35×10 ⁻² | 9.98×10 ⁻⁵ | 6.54×10 ⁻⁴ | 2.22×10 ⁻⁴ | 4.53×10 ⁻⁵ | 3.35×10 ⁻⁷ |
| IHLW Interim Storage Facility | 2067 | 2067 | a | a | a | a | a | a | a | a | a |
| Waste Treatment Plant | 2041 | 2042 | a | a | a | a | a | a | a | a | a |
| Cesium and Strontium Capsule Processing Facility | 2041 | 2041 | a | a | a | a | a | a | a | a | a |
| Contact-Handled Mixed Transuranic Waste Facilities | 2011 | 2012 | a | a | a | a | a | a | a | a | a |
| Remote-Handled Mixed Transuranic Waste Facility | 2020 | 2021 | a | a | a | a | a | a | a | a | a |
| Transuranic Waste Interim Storage Facility | 2035 | 2035 | b | b | b | a | a | b | b | b | b |
| Cast Stone Facility, 200-West Area | 2040 | 2041 | a | a | a | a | a | a | a | a | a |
| Solid-Liquid Separations Facility | 2040 | 2041 | a | a | a | a | a | a | a | a | a |
| Cast Stone Facility, 200-East Area | 2040 | 2041 | a | a | a | a | a | a | a | a | a |
| Effluent Treatment Facility original | 2026 | 2026 | a | a | a | a | a | a | a | a | a |
| Effluent Treatment Facility replacement 1 | 2043 | 2043 | a | a | a | a | a | a | a | a | a |

Table G-121. Tank Closure Alternative 3B Maximum Criteria Pollutant Concentrations of Peak Activity Periods (continued)

| Facility/System | Start Year | End Year | Concentration (micrograms per cubic meter) | | | | | | | | |
|---|------------|----------|--|----------------------------|----------------------------|----------------------------|----------------------------|----------------------------|----------------------------|-----------------------|-----------------------------|
| | | | Carbon Monoxide | | Nitrogen Dioxide | PM ₁₀ | | Sulfur Dioxide | | | |
| | | | 1-hour | 8-hour | Annual | 24-hour | Annual | 1-hour | 3-hour | 24-hour | Annual |
| | | | 2035-2036 | 2035-2036 | 2035-2036 | 2039 | 2039 | 2035-2036 | 2035-2036 | 2035-2036 | 2035-2036 |
| Deactivation (continued) | | | | | | | | | | | |
| Evaporator original | 2018 | 2018 | a | a | a | a | a | a | a | a | a |
| Evaporator replacement 1 | 2041 | 2041 | a | a | a | a | a | a | a | a | a |
| Closure | | | | | | | | | | | |
| Grout facility (tank-filling) construction | 2028 | 2029 | a | a | a | a | a | a | a | a | a |
| Grout facility (tank-filling) operations | 2030 | 2039 | 3.66×10 ² | 5.86×10 ¹ | 6.92×10 ⁻¹ | 5.08×10 ¹ | 3.76×10 ⁻¹ | 4.39×10 ⁻¹ | 1.49×10 ⁻¹ | 3.04×10 ⁻² | 2.25×10 ⁻⁴ |
| Grout facility (tank-filling) deactivation | 2040 | 2040 | a | a | a | a | a | a | a | a | a |
| Ancillary equipment grouting | 2012 | 2032 | a | a | a | a | a | a | a | a | a |
| Ancillary equipment removal | 2028 | 2033 | a | a | a | a | a | a | a | a | a |
| BX and SX tank farm soil removal | 2028 | 2033 | a | a | a | a | a | a | a | a | a |
| Containment structure construction | 2024 | 2027 | a | a | a | a | a | a | a | a | a |
| Containment structure deactivation | 2034 | 2036 | 1.47×10 ³ | 2.35×10 ² | 7.82×10 ⁻² | a | a | 4.74×10 ⁻² | 1.61×10 ⁻² | 3.29×10 ⁻³ | 2.43×10 ⁻⁵ |
| Modified Resource Conservation and Recovery Act Subtitle C barrier construction | 2035 | 2041 | 2.66×10 ⁴ | 4.26×10 ³ | 1.25×10 ¹ | 3.91×10 ³ | 2.89×10 ¹ | 3.68×10 ¹ | 1.25×10 ¹ | 2.55 | 1.89×10 ⁻² |
| Decontamination and decommissioning of 10 selected facilities | 2018 | 2028 | a | a | a | a | a | a | a | a | a |
| Postclosure care | 2042 | 2141 | a | a | a | a | a | a | a | a | a |
| Total | | | 5.77×10⁴ | 9.16×10³ | 1.81×10¹ | 4.51×10³ | 3.48×10¹ | 8.21×10¹ | 3.15×10¹ | 5.96 | 9.52×10⁻² |

^a This activity would not contribute to the concentration during the peak year(s) for this pollutant and averaging period.

^b Emissions for this activity and pollutant were not calculated because they would be small compared with those for other activities under this alternative, as explained in Section G.2.

Note: Total concentrations exceeding applicable standards are presented in **bold**.

Key: HLW=high-level radioactive waste; IHLW=immobilized high-level radioactive waste; PM₁₀=particulate matter with an aerodynamic diameter less than or equal to 10 micrometers.

Source: SAIC 2007a, 2008.

Table G-122. Tank Closure Alternative 3B Maximum Toxic Pollutant Concentrations of Peak Activity Periods

| Facility/System | Start Year | End Year | Concentration (micrograms per cubic meter) | | | | | | |
|--|------------|----------|--|-----------------------|-----------------------|-----------------------|----------------------|-----------------------|-----------------------|
| | | | Ammonia | Benzene | 1,3-Butadiene | Formaldehyde | Mercury | Toluene | Xylene |
| | | | 24-hour 2016 | Annual 2035-2038 | Annual 2035-2038 | Annual 2035-2038 | 24-hour 2041-2042 | 24-hour 2035-2038 | 24-hour 2035-2038 |
| Construction | | | | | | | | | |
| Canister Storage Building | 2006 | 2016 | b | a | a | a | a | a | a |
| IHLW Shipping/Transfer Facility | 2011 | 2013 | a | a | a | a | a | a | a |
| IHLW Interim Storage Modules | 2014 | 2022 | b | a | a | a | a | a | a |
| Other infrastructure upgrades | 2006 | 2034 | b | a | a | a | a | a | a |
| Tank upgrades | 2006 | 2025 | 8.81×10 ⁻² | a | a | a | a | a | a |
| Waste Treatment Plant | 2006 | 2017 | 1.29 | a | a | a | a | a | a |
| Cesium and Strontium Capsule Processing Facility | 2035 | 2038 | a | 1.60×10 ⁻³ | 1.87×10 ⁻⁵ | 7.88×10 ⁻⁴ | a | 2.10 | 5.97×10 ⁻¹ |
| Waste receiver facilities | 2013 | 2017 | b | a | a | a | a | a | a |
| Tank risers | 2013 | 2016 | 2.46 | a | a | a | a | a | a |
| Modified sluicing retrieval system | 2013 | 2039 | 4.04×10 ⁻¹ | b | b | b | a | b | b |
| Mobile retrieval system | 2013 | 2026 | 3.21×10 ⁻¹ | a | a | a | a | a | a |
| Vacuum-based retrieval system | 2027 | 2039 | a | b | b | b | a | b | b |
| HLW Melter Interim Storage Facility | 2015 | 2016 | b | a | a | a | a | a | a |
| Contact-Handled Mixed Transuranic Waste Facilities | 2008 | 2008 | a | a | a | a | a | a | a |
| Remote-Handled Mixed Transuranic Waste Facility | 2013 | 2014 | a | a | a | a | a | a | a |
| Transuranic Waste Interim Storage Facility | 2008 | 2009 | a | a | a | a | a | a | a |
| Cast Stone Facility, 200-West Area | 2016 | 2017 | 2.20×10 ⁻² | a | a | a | a | a | a |
| Solid-Liquid Separations Facility | 2016 | 2017 | 3.04×10 ⁻² | a | a | a | a | a | a |
| Cast Stone Facility, 200-East Area | 2016 | 2017 | 1.24×10 ⁻² | a | a | a | a | a | a |
| Effluent Treatment Facility replacement 1 | 2023 | 2025 | a | a | a | a | a | a | a |
| Evaporator replacement 1 | 2015 | 2017 | 6.32×10 ⁻² | a | a | a | a | a | a |
| Underground transfer line 1,000-foot sections | 2009 | 2009 | a | a | a | a | a | a | a |
| Operations | | | | | | | | | |
| IHLW Interim Storage Facility | 2018 | 2066 | a | b | b | b | b | b | b |
| Other infrastructure upgrades | 2006 | 2039 | b | b | b | b | a | b | b |
| Routine operations | 2006 | 2039 | 5.59 | b | b | b | a | b | b |
| Retrieval operations | 2006 | 2039 | 4.60×10 ⁻² | b | b | b | a | b | b |
| Double-shell tank interim stabilization | 2006 | 2039 | 3.02×10 ⁻¹ | b | b | b | a | b | b |
| Waste Treatment Plant | 2018 | 2039 | a | 5.10×10 ⁻⁵ | 1.84×10 ⁻⁸ | 5.70×10 ⁻⁷ | a | 3.09×10 ⁻⁵ | 1.04×10 ⁻⁴ |

Table G-122. Tank Closure Alternative 3B Maximum Toxic Pollutant Concentrations of Peak Activity Periods (continued)

| Facility/System | Start Year | End Year | Concentration (micrograms per cubic meter) | | | | | | |
|--|------------|----------|--|-----------------------|-----------------------|-----------------------|-----------------------|-----------------------|-----------------------|
| | | | Ammonia | Benzene | 1,3-Butadiene | Formaldehyde | Mercury | Toluene | Xylene |
| | | | 24-hour 2016 | Annual 2035-2038 | Annual 2035-2038 | Annual 2035-2038 | 24-hour 2041-2042 | 24-hour 2035-2038 | 24-hour 2035-2038 |
| Operations (continued) | | | | | | | | | |
| Waste Treatment Plant, cesium and strontium capsules | 2040 | 2040 | a | a | a | a | a | a | a |
| Cesium and Strontium Capsule Processing Facility | 2039 | 2040 | a | a | a | a | a | a | a |
| Modified sluicing retrieval system | 2013 | 2039 | 4.04×10 ⁻¹ | b | b | b | a | b | b |
| Mobile retrieval system | 2013 | 2026 | 4.63×10 ⁻¹ | a | a | a | a | a | a |
| Vacuum-based retrieval system | 2027 | 2039 | a | b | b | b | a | b | b |
| HLW Melter Interim Storage Facility | 2018 | 2141 | a | b | b | b | b | b | b |
| Contact-Handled Mixed Transuranic Waste Facilities | 2009 | 2010 | a | a | a | a | a | a | a |
| Remote-Handled Mixed Transuranic Waste Facility | 2015 | 2019 | 1.99×10 ⁻³ | a | a | a | a | a | a |
| Transuranic Waste Interim Storage Facility | 2009 | 2034 | b | a | a | a | a | a | a |
| Cast Stone Facility, 200-West Area | 2018 | 2039 | a | 1.18×10 ⁻⁴ | 1.72×10 ⁻⁶ | 6.69×10 ⁻⁵ | a | 1.92×10 ⁻¹ | 5.49×10 ⁻² |
| Solid-Liquid Separations Facility | 2018 | 2039 | a | 1.18×10 ⁻⁴ | 1.51×10 ⁻⁶ | 5.53×10 ⁻⁵ | a | 3.49×10 ⁻¹ | 9.96×10 ⁻² |
| Cast Stone Facility, 200-East Area | 2018 | 2039 | a | 1.33×10 ⁻⁴ | 2.62×10 ⁻⁶ | 9.27×10 ⁻⁵ | a | 6.76×10 ⁻² | 1.96×10 ⁻² |
| Effluent Treatment Facility | 2006 | 2042 | 3.72×10 ⁻⁴ | 6.54×10 ⁻⁶ | 1.08×10 ⁻⁷ | 4.03×10 ⁻⁶ | b | 1.53×10 ⁻³ | 4.39×10 ⁻⁴ |
| Evaporator | 2006 | 2040 | 9.82×10 ⁻² | 1.24×10 ⁻⁴ | 5.22×10 ⁻⁶ | 1.57×10 ⁻⁴ | a | 5.79×10 ⁻³ | 4.04×10 ⁻³ |
| Borrow Area C | 2006 | 2052 | 3.08×10 ⁻¹ | 1.24×10 ⁻⁴ | 4.04×10 ⁻⁶ | 1.27×10 ⁻⁴ | b | 2.28×10 ⁻¹ | 7.18×10 ⁻² |
| Deactivation | | | | | | | | | |
| Modified sluicing retrieval system | 2013 | 2039 | b | b | b | b | a | b | b |
| Mobile retrieval system | 2013 | 2026 | b | a | a | a | a | a | a |
| Vacuum-based retrieval system | 2027 | 2039 | a | b | b | b | a | b | b |
| IHLW Interim Storage Facility | 2067 | 2067 | a | a | a | a | a | a | a |
| Waste Treatment Plant | 2041 | 2042 | a | a | a | a | 7.87×10 ⁻³ | a | a |
| Cesium and Strontium Capsule Processing Facility | 2041 | 2041 | a | a | a | a | b | a | a |
| Contact-Handled Mixed Transuranic Waste Facilities | 2011 | 2012 | a | a | a | a | a | a | a |
| Remote-Handled Mixed Transuranic Waste Facility | 2020 | 2021 | a | a | a | a | a | a | a |
| Transuranic Waste Interim Storage Facility | 2035 | 2035 | a | b | b | b | a | b | b |
| Cast Stone Facility, 200-West Area | 2040 | 2041 | a | a | a | a | b | a | a |
| Solid-Liquid Separations Facility | 2040 | 2041 | a | a | a | a | b | a | a |
| Cast Stone Facility, 200-East Area | 2040 | 2041 | a | a | a | a | b | a | a |

G-252

Table G-122. Tank Closure Alternative 3B Maximum Toxic Pollutant Concentrations of Peak Activity Periods (continued)

| Facility/System | Start Year | End Year | Concentration (micrograms per cubic meter) | | | | | | |
|---|------------|----------|--|-----------------------|-----------------------|-----------------------|-----------------------|----------------------|-----------------------|
| | | | Ammonia | Benzene | 1,3-Butadiene | Formaldehyde | Mercury | Toluene | Xylene |
| | | | 24-hour 2016 | Annual 2035–2038 | Annual 2035–2038 | Annual 2035–2038 | 24-hour 2041–2042 | 24-hour 2035–2038 | 24-hour 2035–2038 |
| Deactivation (continued) | | | | | | | | | |
| Effluent Treatment Facility original | 2026 | 2026 | a | a | a | a | a | a | a |
| Effluent Treatment Facility replacement | 2043 | 2043 | a | a | a | a | a | a | a |
| Evaporator original | 2018 | 2018 | a | a | a | a | a | a | a |
| Evaporator replacement | 2041 | 2041 | a | a | a | a | b | a | a |
| Closure | | | | | | | | | |
| Grout facility (tank-filling) construction | 2028 | 2029 | a | a | a | a | a | a | a |
| Grout facility (tank-filling) operations | 2030 | 2039 | a | b | b | b | a | b | b |
| Grout facility (tank-filling) deactivation | 2040 | 2040 | a | a | a | a | a | a | a |
| Ancillary equipment grouting | 2012 | 2032 | 3.61×10 ⁻⁵ | a | a | a | a | a | a |
| Ancillary equipment removal | 2028 | 2033 | a | a | a | a | a | a | a |
| BX and SX tank farm soil removal | 2028 | 2033 | a | a | a | a | a | a | a |
| Containment structure construction | 2024 | 2027 | a | a | a | a | a | a | a |
| Containment structure deactivation | 2034 | 2036 | a | b | b | b | a | b | b |
| Modified Resource Conservation and Recovery Act Subtitle C barrier construction | 2035 | 2041 | a | 4.00×10 ⁻³ | 1.16×10 ⁻⁴ | 3.74×10 ⁻³ | b | 3.09 | 9.37×10 ⁻¹ |
| Decontamination and decommissioning of 10 selected facilities | 2018 | 2028 | a | a | a | a | a | a | a |
| Postclosure care | 2042 | 2141 | a | a | a | a | b | a | a |
| Total | | | 1.19×10 ¹ | 6.27×10 ⁻³ | 1.50×10 ⁻⁴ | 5.03×10 ⁻³ | 7.87×10 ⁻³ | 6.03 | 1.78 |

^a This activity would not contribute to the concentration during the peak year(s) for this pollutant and averaging period.

^b Emissions for this activity and pollutant were not calculated because they would be small compared with those for other activities under this alternative, as explained in Section G.2.

Note: Total concentrations exceeding applicable standards are presented in **bold**.

Key: HLW=high-level radioactive waste; IHLW=immobilized high-level radioactive waste.

Source: SAIC 2007a, 2008.

Table G-123. Tank Closure Alternative 3C Maximum Criteria Pollutant Concentrations of Peak Activity Periods

| Facility/System | Start Year | End Year | Concentration (micrograms per cubic meter) | | | | | | | | |
|--|------------|----------|--|-----------------------|-----------------------|-----------------------|-----------------------|-----------------------|-----------------------|-----------------------|-----------------------|
| | | | Carbon Monoxide | | Nitrogen Dioxide | PM ₁₀ | | Sulfur Dioxide | | | |
| | | | 1-hour | 8-hour | Annual | 24-hour | Annual | 1-hour | 3-hour | 24-hour | Annual |
| | | | 2035-2036 | 2035-2036 | 2035-2036 | 2039 | 2039 | 2035-2036 | 2035-2036 | 2035-2036 | 2035-2036 |
| Construction | | | | | | | | | | | |
| Canister Storage Building | 2006 | 2016 | a | a | a | a | a | a | a | a | a |
| IHLW Shipping/Transfer Facility | 2011 | 2013 | a | a | a | a | a | a | a | a | a |
| IHLW Interim Storage Modules | 2014 | 2022 | a | a | a | a | a | a | a | a | a |
| Other infrastructure upgrades | 2006 | 2034 | a | a | a | a | a | a | a | a | a |
| Tank upgrades | 2006 | 2025 | a | a | a | a | a | a | a | a | a |
| Waste Treatment Plant | 2006 | 2017 | a | a | a | a | a | a | a | a | a |
| Cesium and Strontium Capsule Processing Facility | 2035 | 2038 | 1.89×10 ⁴ | 2.67×10 ³ | 1.54 | a | a | 2.55×10 ¹ | 8.50 | 1.46 | 1.42×10 ⁻² |
| Waste receiver facilities | 2013 | 2017 | a | a | a | a | a | a | a | a | a |
| Tank risers | 2013 | 2016 | a | a | a | a | a | a | a | a | a |
| Modified sluicing retrieval system | 2013 | 2039 | 1.90×10 ³ | 3.19×10 ² | 5.49×10 ⁻² | 2.66 | 3.04×10 ⁻² | 1.76×10 ⁻² | 6.44×10 ⁻³ | 1.15×10 ⁻³ | 1.32×10 ⁻⁵ |
| Mobile retrieval system | 2013 | 2026 | a | a | a | a | a | a | a | a | a |
| Vacuum-based retrieval system | 2027 | 2039 | 1.25×10 ³ | 2.01×10 ² | 2.91×10 ⁻¹ | 7.90 | 5.84×10 ⁻² | 1.81×10 ⁻¹ | 6.14×10 ⁻² | 1.25×10 ⁻² | 9.26×10 ⁻⁵ |
| HLW Melter Interim Storage Facility | 2015 | 2016 | a | a | a | a | a | a | a | a | a |
| Contact-Handled Mixed Transuranic Waste Facilities | 2008 | 2008 | a | a | a | a | a | a | a | a | a |
| Remote-Handled Mixed Transuranic Waste Facility | 2013 | 2014 | a | a | a | a | a | a | a | a | a |
| Transuranic Waste Interim Storage Facility | 2008 | 2009 | a | a | a | a | a | a | a | a | a |
| Steam Reforming Facility, 200-West Area | 2016 | 2017 | a | a | a | a | a | a | a | a | a |
| Solid-Liquid Separations Facility | 2016 | 2017 | a | a | a | a | a | a | a | a | a |
| Steam Reforming Facility, 200-East Area | 2016 | 2017 | a | a | a | a | a | a | a | a | a |
| Effluent Treatment Facility replacement 1 | 2023 | 2025 | a | a | a | a | a | a | a | a | a |
| Evaporator replacement 1 | 2015 | 2017 | a | a | a | a | a | a | a | a | a |
| Underground transfer line 1,000-foot sections | 2009 | 2009 | a | a | a | a | a | a | a | a | a |
| Operations | | | | | | | | | | | |
| IHLW Interim Storage Facility | 2018 | 2066 | b | b | b | b | b | b | b | b | b |
| Other infrastructure upgrades | 2006 | 2039 | b | b | b | b | b | b | b | b | b |
| Routine operations | 2006 | 2039 | 5.72×10 ¹ | 1.50×10 ¹ | 8.27×10 ⁻² | b | b | b | b | b | b |
| Retrieval operations | 2006 | 2039 | 7.66×10 ⁻¹ | 1.23×10 ⁻¹ | 4.45×10 ⁻⁴ | b | b | b | b | b | b |
| Double-shell tank interim stabilization | 2006 | 2039 | 5.02 | 8.05×10 ⁻¹ | 2.92×10 ⁻³ | b | b | b | b | b | b |
| Waste Treatment Plant | 2018 | 2039 | 1.13×10 ² | 3.47×10 ¹ | 1.19 | 4.15×10 ⁻¹ | 1.93×10 ⁻² | 1.21×10 ¹ | 7.45 | 1.25 | 5.81×10 ⁻² |
| Waste Treatment Plant, cesium and strontium capsules | 2040 | 2040 | a | a | a | a | a | a | a | a | a |
| Cesium and Strontium Capsule Processing Facility | 2039 | 2040 | a | a | a | 4.00×10 ¹ | 6.56×10 ⁻¹ | a | a | a | a |

Table G-123. Tank Closure Alternative 3C Maximum Criteria Pollutant Concentrations of Peak Activity Periods (continued)

| Facility/System | Start Year | End Year | Concentration (micrograms per cubic meter) | | | | | | | | |
|--|------------|----------|--|----------------------|-----------------------|-----------------------|-----------------------|-----------------------|-----------------------|-----------------------|-----------------------|
| | | | Carbon Monoxide | | Nitrogen Dioxide | PM ₁₀ | | Sulfur Dioxide | | | |
| | | | 1-hour | 8-hour | Annual | 24-hour | Annual | 1-hour | 3-hour | 24-hour | Annual |
| | | | 2035-2036 | 2035-2036 | 2035-2036 | 2039 | 2039 | 2035-2036 | 2035-2036 | 2035-2036 | 2035-2036 |
| Operations (continued) | | | | | | | | | | | |
| Modified sluicing retrieval system | 2013 | 2039 | 5.28×10 ² | 8.85×10 ¹ | 2.45×10 ⁻² | 1.65×10 ⁻¹ | 1.89×10 ⁻³ | 8.41×10 ⁻³ | 3.07×10 ⁻³ | 5.50×10 ⁻⁴ | 6.29×10 ⁻⁶ |
| Mobile retrieval system | 2013 | 2026 | a | a | a | a | a | a | a | a | a |
| Vacuum-based retrieval system | 2027 | 2039 | 8.54 | 1.37 | 4.97×10 ⁻³ | b | b | b | b | b | b |
| HLW Melter Interim Storage Facility | 2018 | 2141 | b | b | b | b | b | b | b | b | b |
| Contact-Handled Mixed Transuranic Waste Facilities | 2009 | 2010 | a | a | a | a | a | a | a | a | a |
| Remote-Handled Mixed Transuranic Waste Facility | 2015 | 2019 | a | a | a | a | a | a | a | a | a |
| Transuranic Waste Interim Storage Facility | 2009 | 2034 | a | a | a | a | a | a | a | a | a |
| Steam Reforming Facility, 200-West Area | 2018 | 2039 | 5.63×10 ² | 1.54×10 ² | 1.77×10 ⁻¹ | 3.39×10 ⁻³ | 2.44×10 ⁻⁵ | 6.83×10 ⁻¹ | 2.90×10 ⁻¹ | 9.03×10 ⁻² | 6.51×10 ⁻⁴ |
| Solid-Liquid Separations Facility | 2018 | 2039 | 3.04×10 ³ | 4.35×10 ² | 1.29×10 ⁻¹ | 2.13 | 8.93×10 ⁻³ | 4.09 | 1.36 | 2.44×10 ⁻¹ | 1.02×10 ⁻³ |
| Steam Reforming Facility, 200-East Area | 2018 | 2039 | 4.73×10 ² | 1.01×10 ² | 2.44×10 ⁻¹ | 1.32×10 ⁻³ | 2.48×10 ⁻⁵ | 3.73×10 ⁻¹ | 1.30×10 ⁻¹ | 3.25×10 ⁻² | 6.07×10 ⁻⁴ |
| Effluent Treatment Facility | 2006 | 2042 | 7.85 | 2.41 | 1.02×10 ⁻² | 7.66×10 ¹ | 3.57 | 1.06×10 ⁻² | 6.52×10 ⁻³ | 1.09×10 ⁻³ | 5.08×10 ⁻⁵ |
| Evaporator | 2006 | 2040 | 2.00×10 ² | 3.09×10 ¹ | 5.88×10 ⁻¹ | 1.87×10 ¹ | 1.76×10 ⁻¹ | 3.15×10 ⁻¹ | 1.13×10 ⁻¹ | 2.13×10 ⁻² | 2.00×10 ⁻⁴ |
| Borrow Area C | 2006 | 2052 | 6.91×10 ² | 2.83×10 ² | 4.42×10 ⁻¹ | 3.98×10 ² | 9.10×10 ⁻¹ | 9.72×10 ⁻¹ | 6.58×10 ⁻¹ | 2.07×10 ⁻¹ | 4.75×10 ⁻⁴ |
| Deactivation | | | | | | | | | | | |
| Modified sluicing retrieval system | 2013 | 2039 | 1.36×10 ³ | 2.27×10 ² | 4.28×10 ⁻² | 3.30×10 ⁻¹ | 3.77×10 ⁻³ | 1.68×10 ⁻² | 6.15×10 ⁻³ | 1.10×10 ⁻³ | 1.26×10 ⁻⁵ |
| Mobile retrieval system | 2013 | 2026 | a | a | a | a | a | a | a | a | a |
| Vacuum-based retrieval system | 2027 | 2039 | 2.73×10 ¹ | 4.38 | 1.10×10 ⁻³ | 1.35×10 ⁻² | 9.98×10 ⁻⁵ | 6.54×10 ⁻⁴ | 2.22×10 ⁻⁴ | 4.53×10 ⁻⁵ | 3.35×10 ⁻⁷ |
| IHLW Interim Storage Facility | 2067 | 2067 | a | a | a | a | a | a | a | a | a |
| Waste Treatment Plant | 2041 | 2042 | a | a | a | a | a | a | a | a | a |
| Cesium and Strontium Capsule Processing Facility | 2041 | 2041 | a | a | a | a | a | a | a | a | a |
| Contact-Handled Mixed Transuranic Waste Facilities | 2011 | 2012 | a | a | a | a | a | a | a | a | a |
| Remote-Handled Mixed Transuranic Waste Facility | 2020 | 2021 | a | a | a | a | a | a | a | a | a |
| Transuranic Waste Interim Storage Facility | 2035 | 2035 | b | b | b | a | a | b | b | b | b |
| Steam Reforming Facility, 200-West Area | 2040 | 2041 | a | a | a | a | a | a | a | a | a |
| Solid-Liquid Separations Facility | 2040 | 2041 | a | a | a | a | a | a | a | a | a |
| Steam Reforming Facility, 200-East Area | 2040 | 2041 | a | a | a | a | a | a | a | a | a |
| Effluent Treatment Facility original | 2026 | 2026 | a | a | a | a | a | a | a | a | a |
| Effluent Treatment Facility replacement 1 | 2043 | 2043 | a | a | a | a | a | a | a | a | a |
| Evaporator original | 2018 | 2018 | a | a | a | a | a | a | a | a | a |
| Evaporator replacement 1 | 2041 | 2041 | a | a | a | a | a | a | a | a | a |

Table G-123. Tank Closure Alternative 3C Maximum Criteria Pollutant Concentrations of Peak Activity Periods (continued)

| Facility/System | Start Year | End Year | Concentration (micrograms per cubic meter) | | | | | | | | |
|---|------------|----------|--|----------------------|-----------------------|----------------------------|-----------------------|-----------------------|-----------------------|-----------------------|-----------------------|
| | | | Carbon Monoxide | | Nitrogen Dioxide | PM ₁₀ | | Sulfur Dioxide | | | |
| | | | 1-hour | 8-hour | Annual | 24-hour | Annual | 1-hour | 3-hour | 24-hour | Annual |
| | | | 2035-2036 | 2035-2036 | 2035-2036 | 2039 | 2039 | 2035-2036 | 2035-2036 | 2035-2036 | 2035-2036 |
| Closure | | | | | | | | | | | |
| Grout facility (tank-filling) construction | 2028 | 2029 | a | a | a | a | a | a | a | a | a |
| Grout facility (tank-filling) operations | 2030 | 2039 | 3.66×10 ² | 5.86×10 ¹ | 6.92×10 ⁻¹ | 5.08×10 ¹ | 3.76×10 ⁻¹ | 4.39×10 ⁻¹ | 1.49×10 ⁻¹ | 3.04×10 ⁻² | 2.25×10 ⁻⁴ |
| Grout facility (tank-filling) deactivation | 2040 | 2040 | a | a | a | a | a | a | a | a | a |
| Ancillary equipment grouting | 2012 | 2032 | a | a | a | a | a | a | a | a | a |
| Ancillary equipment removal | 2028 | 2033 | a | a | a | a | a | a | a | a | a |
| BX and SX tank farm soil removal -closure | 2028 | 2033 | a | a | a | a | a | a | a | a | a |
| Containment structure construction | 2024 | 2027 | a | a | a | a | a | a | a | a | a |
| Containment structure deactivation | 2034 | 2036 | 1.47×10 ³ | 2.35×10 ² | 7.82×10 ⁻² | a | a | 4.74×10 ⁻² | 1.61×10 ⁻² | 3.29×10 ⁻³ | 2.43×10 ⁻⁵ |
| Modified Resource Conservation and Recovery Act Subtitle C barrier construction | 2035 | 2041 | 2.66×10 ⁴ | 4.26×10 ³ | 1.25×10 ¹ | 3.91×10 ³ | 2.89×10 ¹ | 3.68×10 ¹ | 1.25×10 ¹ | 2.55 | 1.89×10 ⁻² |
| Decontamination and decommissioning of 10 selected facilities | 2018 | 2028 | a | a | a | a | a | a | a | a | a |
| Postclosure care | 2042 | 2141 | a | a | a | a | a | a | a | a | a |
| Total | | | 5.76×10⁴ | 9.12×10 ³ | 1.81×10 ¹ | 4.51×10³ | 3.47×10 ¹ | 8.16×10 ¹ | 3.13×10 ¹ | 5.90 | 9.46×10 ⁻² |

^a This activity would not contribute to the concentration during the peak year(s) for this pollutant and averaging period.

^b Emissions for this activity and pollutant were not calculated because they would be small compared with those for other activities under this alternative, as explained in Section G.2.

Note: Total concentrations exceeding applicable standards are presented in **bold**.

Key: HLW=high-level radioactive waste; IHLW=immobilized high-level radioactive waste; PM₁₀=particulate matter with an aerodynamic diameter less than or equal to 10 micrometers.

Source: SAIC 2007a, 2008.

Table G-124. Tank Closure Alternative 3C Maximum Toxic Pollutant Concentrations of Peak Activity Periods

| Facility/System | Start Year | End Year | Concentration (micrograms per cubic meter) | | | | | | |
|--|------------|----------|--|-----------------------|-----------------------|-----------------------|-----------------------|-----------------------|-----------------------|
| | | | Ammonia | Benzene | 1,3-Butadiene | Formaldehyde | Mercury | Toluene | Xylene |
| | | | 24-hour 2016 | Annual 2035-2038 | Annual 2035-2038 | Annual 2035-2038 | 24-hour 2018-2039 | 24-hour 2035-2038 | 24-hour 2035-2038 |
| Construction | | | | | | | | | |
| Canister Storage Building | 2006 | 2016 | b | a | a | a | a | a | a |
| IHLW Shipping/Transfer Facility | 2011 | 2013 | a | a | a | a | a | a | a |
| IHLW Interim Storage Modules | 2014 | 2022 | b | a | a | a | b | a | a |
| Other infrastructure upgrades | 2006 | 2034 | b | a | a | a | b | a | a |
| Tank upgrades | 2006 | 2025 | 8.81×10 ⁻² | a | a | a | b | a | a |
| Waste Treatment Plant | 2006 | 2017 | 1.29 | a | a | a | a | a | a |
| Cesium and Strontium Capsule Processing Facility | 2035 | 2038 | a | 1.60×10 ⁻³ | 1.87×10 ⁻⁵ | 7.88×10 ⁻⁴ | b | 2.10 | 5.97×10 ⁻¹ |
| Waste receiver facilities | 2013 | 2017 | b | a | a | a | a | a | a |
| Tank risers | 2013 | 2016 | 2.46 | a | a | a | a | a | a |
| Modified sluicing retrieval system | 2013 | 2039 | 4.04×10 ⁻¹ | b | b | b | b | b | b |
| Mobile retrieval system | 2013 | 2026 | 3.21×10 ⁻¹ | a | a | a | b | a | a |
| Vacuum-based retrieval system | 2027 | 2039 | a | b | b | b | b | b | b |
| HLW Melter Interim Storage Facility | 2015 | 2016 | b | a | a | a | a | a | a |
| Contact-Handled Mixed Transuranic Waste Facilities | 2008 | 2008 | a | a | a | a | a | a | a |
| Remote-Handled Mixed Transuranic Waste Facility | 2013 | 2014 | a | a | a | a | a | a | a |
| Transuranic Waste Interim Storage Facility | 2008 | 2009 | a | a | a | a | a | a | a |
| Steam Reforming Facility, 200-West Area | 2016 | 2017 | 7.41×10 ⁻² | a | a | a | a | a | a |
| Solid-Liquid Separations Facility | 2016 | 2017 | 3.04×10 ⁻² | a | a | a | a | a | a |
| Steam Reforming Facility, 200-East Area | 2016 | 2017 | 8.37×10 ⁻² | a | a | a | a | a | a |
| Effluent Treatment Facility replacement 1 | 2023 | 2025 | a | a | a | a | b | a | a |
| Evaporator replacement 1 | 2015 | 2017 | 6.32×10 ⁻² | a | a | a | a | a | a |
| Underground transfer lines | 2009 | 2009 | a | a | a | a | a | a | a |
| Operations | | | | | | | | | |
| IHLW Interim Storage Facility | 2018 | 2066 | a | b | b | b | b | b | b |
| Other infrastructure upgrades | 2006 | 2039 | b | b | b | b | b | b | b |
| Routine operations | 2006 | 2039 | 5.59 | b | b | b | b | b | b |
| Retrieval operations | 2006 | 2039 | 4.60×10 ⁻² | b | b | b | b | b | b |
| Double-shell tank interim stabilization | 2006 | 2039 | 3.02×10 ⁻¹ | b | b | b | b | b | b |
| Waste Treatment Plant | 2018 | 2039 | a | 5.10×10 ⁻⁵ | 1.84×10 ⁻⁸ | 5.70×10 ⁻⁷ | 7.02×10 ⁻³ | 3.09×10 ⁻⁵ | 1.04×10 ⁻⁴ |

Table G-124. Tank Closure Alternative 3C Maximum Toxic Pollutant Concentrations of Peak Activity Periods (continued)

| Facility/System | Start Year | End Year | Concentration (micrograms per cubic meter) | | | | | | |
|--|------------|----------|--|-----------------------|------------------------|-----------------------|-----------------------|-----------------------|-----------------------|
| | | | Ammonia | Benzene | 1,3-Butadiene | Formaldehyde | Mercury | Toluene | Xylene |
| | | | 24-hour 2016 | Annual 2035-2038 | Annual 2035-2038 | Annual 2035-2038 | 24-hour 2018-2039 | 24-hour 2035-2038 | 24-hour 2035-2038 |
| Operations (continued) | | | | | | | | | |
| Waste Treatment Plant, cesium and strontium capsules | 2040 | 2040 | a | a | a | a | a | a | a |
| Cesium and Strontium Capsule Processing Facility | 2039 | 2040 | a | a | a | a | b | a | a |
| Modified sluicing retrieval system | 2013 | 2039 | 4.04×10 ⁻¹ | b | b | b | b | b | b |
| Mobile retrieval system | 2013 | 2026 | 4.63×10 ⁻¹ | a | a | a | b | a | a |
| Vacuum-based retrieval system | 2027 | 2039 | a | b | b | b | b | b | b |
| HLW Melter Interim Storage Facility | 2018 | 2141 | a | b | b | b | b | b | b |
| Contact-Handled Mixed Transuranic Waste Facilities | 2009 | 2010 | a | a | a | a | a | a | a |
| Remote-Handled Mixed Transuranic Waste Facility | 2015 | 2019 | 1.99×10 ⁻³ | a | a | a | b | a | a |
| Transuranic Waste Interim Storage Facility | 2009 | 2034 | b | a | a | a | b | a | a |
| Steam Reforming Facility, 200-West Area | 2018 | 2039 | a | 1.93×10 ⁻⁶ | 6.14×10 ⁻¹⁰ | 1.94×10 ⁻⁸ | 4.04×10 ⁻³ | 1.23×10 ⁻⁵ | 3.81×10 ⁻⁵ |
| Solid-Liquid Separations Facility | 2018 | 2039 | a | 1.18×10 ⁻⁴ | 1.51×10 ⁻⁶ | 5.53×10 ⁻⁵ | b | 3.49×10 ⁻¹ | 9.96×10 ⁻² |
| Steam Reforming Facility, 200-East Area | 2018 | 2039 | a | 1.87×10 ⁻⁶ | 6.09×10 ⁻¹⁰ | 1.92×10 ⁻⁸ | 1.88×10 ⁻³ | 4.31×10 ⁻⁶ | 1.35×10 ⁻⁵ |
| Effluent Treatment Facility | 2006 | 2042 | 3.72×10 ⁻⁴ | 6.54×10 ⁻⁶ | 1.08×10 ⁻⁷ | 4.03×10 ⁻⁶ | b | 1.53×10 ⁻³ | 4.39×10 ⁻⁴ |
| Evaporator | 2006 | 2040 | 9.82×10 ⁻² | 1.24×10 ⁻⁴ | 5.22×10 ⁻⁶ | 1.57×10 ⁻⁴ | b | 5.79×10 ⁻³ | 4.04×10 ⁻³ |
| Borrow Area C | 2006 | 2052 | 3.08×10 ⁻¹ | 1.24×10 ⁻⁴ | 4.04×10 ⁻⁶ | 1.27×10 ⁻⁴ | b | 2.28×10 ⁻¹ | 7.18×10 ⁻² |
| Deactivation | | | | | | | | | |
| Modified sluicing retrieval system | 2013 | 2039 | b | b | b | b | b | b | b |
| Mobile retrieval system | 2013 | 2026 | b | a | a | a | b | a | a |
| Vacuum-based retrieval system | 2027 | 2039 | a | b | b | b | b | b | b |
| IHLW Interim Storage Facility | 2067 | 2067 | a | a | a | a | a | a | a |
| Waste Treatment Plant | 2041 | 2042 | a | a | a | a | a | a | a |
| Cesium and Strontium Capsule Processing Facility | 2041 | 2041 | a | a | a | a | a | a | a |
| Contact-Handled Mixed Transuranic Waste Facilities | 2011 | 2012 | a | a | a | a | a | a | a |
| Remote-Handled Mixed Transuranic Waste Facility | 2020 | 2021 | a | a | a | a | b | a | a |
| Transuranic Waste Interim Storage Facility | 2035 | 2035 | a | b | b | b | b | b | b |
| Steam Reforming Facility, 200-West Area | 2040 | 2041 | a | a | a | a | a | a | a |
| Solid-Liquid Separations Facility | 2040 | 2041 | a | a | a | a | a | a | a |
| Steam Reforming Facility, 200-East Area | 2040 | 2041 | a | a | a | a | a | a | a |

G-258

Table G-124. Tank Closure Alternative 3C Maximum Toxic Pollutant Concentrations of Peak Activity Periods (continued)

| Facility/System | Start Year | End Year | Concentration (micrograms per cubic meter) | | | | | | |
|---|------------|----------|--|-----------------------|-----------------------|-----------------------|-----------------------|----------------------|-----------------------|
| | | | Ammonia | Benzene | 1,3-Butadiene | Formaldehyde | Mercury | Toluene | Xylene |
| | | | 24-hour 2016 | Annual 2035-2038 | Annual 2035-2038 | Annual 2035-2038 | 24-hour 2018-2039 | 24-hour 2035-2038 | 24-hour 2035-2038 |
| Deactivation (continued) | | | | | | | | | |
| Effluent Treatment Facility original | 2026 | 2026 | a | a | a | a | b | a | a |
| Effluent Treatment Facility replacement 1 | 2043 | 2043 | a | a | a | a | a | a | a |
| Evaporator original | 2018 | 2018 | a | a | a | a | b | a | a |
| Evaporator replacement 1 | 2041 | 2041 | a | a | a | a | a | a | a |
| Closure | | | | | | | | | |
| Grout facility (tank-filling) construction | 2028 | 2029 | a | a | a | a | b | a | a |
| Grout facility (tank-filling) operations | 2030 | 2039 | a | b | b | b | b | b | b |
| Grout facility (tank-filling) deactivation | 2040 | 2040 | a | a | a | a | a | a | a |
| Ancillary equipment grouting | 2012 | 2032 | 3.61×10^{-5} | a | a | a | b | a | a |
| Ancillary equipment removal | 2028 | 2033 | a | a | a | a | b | a | a |
| BX and SX tank farm soil removal-closure | 2028 | 2033 | a | a | a | a | b | a | a |
| Containment structure construction | 2024 | 2027 | a | a | a | a | b | a | a |
| Containment structure deactivation | 2034 | 2036 | a | b | b | b | b | b | b |
| Modified Resource Conservation and Recovery Act Subtitle C barrier construction | 2035 | 2041 | a | 4.00×10^{-3} | 1.16×10^{-4} | 3.74×10^{-3} | b | 3.09 | 9.37×10^{-1} |
| Decontamination and decommissioning of 10 selected facilities | 2018 | 2028 | a | a | a | a | b | a | a |
| Postclosure care | 2042 | 2141 | a | a | a | a | a | a | a |
| Total | | | 1.20×10^1 | 6.02×10^{-3} | 1.46×10^{-4} | 4.87×10^{-3} | 1.29×10^{-2} | 5.78 | 1.71 |

^a This activity would not contribute to the concentration during the peak year(s) for this pollutant and averaging period.

^b Emissions for this activity and pollutant were not calculated because they would be small compared with those for other activities under this alternative, as explained in Section G.2.

Key: HLW=high-level radioactive waste; IHLW=immobilized high-level radioactive waste.

Source: SAIC 2007a, 2008.

Table G-125. Tank Closure Alternative 4 Maximum Criteria Pollutant Concentrations of Peak Activity Periods

| Facility/System | Start Year | End Year | Concentration (micrograms per cubic meter) | | | | | | | | | |
|--|------------|----------|--|-----------------------|-----------------------|-----------------------|-----------------------|-----------------------|-----------------------|-----------------------|-----------------------|---|
| | | | Carbon Monoxide | | Nitrogen Dioxide | PM ₁₀ | | Sulfur Dioxide | | | | |
| | | | 1-hour | 8-hour | Annual | 24-hour | Annual | 1-hour | 3-hour | 24-hour | Annual | |
| | | | 2016 | 2016 | 2038–2039 | 2042 | 2042 | 2038–2039 | 2038–2039 | 2038–2039 | 2038–2039 | |
| Construction | | | | | | | | | | | | |
| Canister Storage Building | 2006 | 2016 | 4.37×10 ¹ | 6.76 | a | a | a | a | a | a | a | a |
| IHLW Shipping/Transfer Facility | 2011 | 2013 | a | a | a | a | a | a | a | a | a | a |
| IHLW Interim Storage Modules | 2014 | 2022 | 3.15×10 ² | 4.88×10 ¹ | a | a | a | a | a | a | a | a |
| Other infrastructure upgrades | 2006 | 2034 | 1.80×10 ¹ | 2.88 | a | a | a | a | a | a | a | a |
| Tank upgrades | 2006 | 2025 | 5.67×10 ³ | 9.09×10 ² | a | a | a | a | a | a | a | a |
| Waste Treatment Plant | 2006 | 2017 | 1.72×10 ⁴ | 2.42×10 ³ | a | a | a | a | a | a | a | a |
| Cesium and Strontium Capsule Processing Facility | 2038 | 2041 | a | a | 6.13×10 ⁻¹ | a | a | 8.92 | 3.19 | 6.02×10 ⁻¹ | 5.67×10 ⁻³ | |
| Waste receiver facilities | 2013 | 2017 | 1.87×10 ³ | 2.99×10 ² | a | a | a | a | a | a | a | a |
| Tank risers | 2013 | 2016 | 3.26×10 ² | 5.23×10 ¹ | a | a | a | a | a | a | a | a |
| Mobile retrieval system | 2013 | 2042 | 1.46×10 ³ | 2.34×10 ² | 3.25×10 ⁻¹ | 8.44 | 6.24×10 ⁻² | 2.03×10 ⁻¹ | 6.89×10 ⁻² | 1.41×10 ⁻² | 1.04×10 ⁻⁴ | |
| Vacuum-based retrieval system | 2013 | 2042 | 5.43×10 ² | 8.71×10 ¹ | 1.26×10 ⁻¹ | 3.42 | 2.53×10 ⁻² | 7.82×10 ⁻² | 2.66×10 ⁻² | 5.42×10 ⁻³ | 4.01×10 ⁻⁵ | |
| Chemical wash system | 2013 | 2042 | 3.68 | 5.90×10 ⁻¹ | 1.01×10 ⁻² | 1.70×10 ⁻¹ | 1.26×10 ⁻³ | 6.14×10 ⁻³ | 2.09×10 ⁻³ | 4.26×10 ⁻⁴ | 3.15×10 ⁻⁶ | |
| HLW Melter Interim Storage Facility | 2015 | 2016 | 1.39×10 ¹ | 1.96 | a | a | a | a | a | a | a | a |
| Contact-Handled Mixed Transuranic Waste Facilities | 2008 | 2008 | a | a | a | a | a | a | a | a | a | a |
| Remote-Handled Mixed Transuranic Waste Facility | 2013 | 2014 | a | a | a | a | a | a | a | a | a | a |
| Transuranic Waste Interim Storage Facility | 2008 | 2009 | a | a | a | a | a | a | a | a | a | a |
| Bulk Vitrification Facility | 2016 | 2017 | 1.08×10 ³ | 1.97×10 ² | a | a | a | a | a | a | a | a |
| Solid-Liquid Separations Facility | 2016 | 2017 | 1.15×10 ³ | 1.65×10 ² | a | a | a | a | a | a | a | a |
| Cast Stone Facility | 2016 | 2017 | 4.82×10 ² | 7.46×10 ¹ | a | a | a | a | a | a | a | a |
| Effluent Treatment Facility replacement 1 | 2023 | 2025 | a | a | a | a | a | a | a | a | a | a |
| Evaporator replacement 1 | 2015 | 2017 | 3.56×10 ³ | 5.50×10 ² | a | a | a | a | a | a | a | a |
| Underground transfer line 1,000-foot sections | 2009 | 2009 | a | a | a | a | a | a | a | a | a | a |
| Operations | | | | | | | | | | | | |
| IHLW Interim Storage Facility | 2018 | 2066 | a | a | b | b | b | b | b | b | b | b |
| Other infrastructure upgrades | 2006 | 2042 | b | b | b | b | b | b | b | b | b | b |
| Routine operations | 2006 | 2042 | 5.72×10 ¹ | 1.50×10 ¹ | 8.27×10 ⁻² | b | b | b | b | b | b | b |
| Retrieval operations | 2006 | 2042 | 7.66×10 ⁻¹ | 1.23×10 ⁻¹ | 4.45×10 ⁻⁴ | b | b | b | b | b | b | b |
| Double-shell tank interim stabilization | 2006 | 2042 | 5.02 | 8.05×10 ⁻¹ | 2.92×10 ⁻³ | b | b | b | b | b | b | b |
| Waste Treatment Plant | 2018 | 2042 | a | a | 1.16 | 3.48×10 ⁻¹ | 1.62×10 ⁻² | 1.06×10 ¹ | 6.48 | 1.08 | 5.05×10 ⁻² | |
| Waste Treatment Plant, cesium and strontium capsules | 2043 | 2043 | a | a | a | a | a | a | a | a | a | a |
| Cesium and Strontium Capsule Processing Facility | 2042 | 2043 | a | a | a | 4.00×10 ¹ | 6.56×10 ⁻¹ | a | a | a | a | a |
| Mobile retrieval system | 2013 | 2042 | 6.70 | 1.07 | 3.89×10 ⁻³ | b | b | b | b | b | b | b |
| Vacuum-based retrieval system | 2013 | 2042 | 3.70 | 5.94×10 ⁻¹ | 2.15×10 ⁻³ | b | b | b | b | b | b | b |

Table G–125. Tank Closure Alternative 4 Maximum Criteria Pollutant Concentrations of Peak Activity Periods (continued)

| Facility/System | Start Year | End Year | Concentration (micrograms per cubic meter) | | | | | | | | |
|--|------------|----------|--|-----------------------|-----------------------|-----------------------|-----------------------|-----------------------|-----------------------|-----------------------|-----------------------|
| | | | Carbon Monoxide | | Nitrogen Dioxide | PM ₁₀ | | Sulfur Dioxide | | | |
| | | | 1-hour | 8-hour | Annual | 24-hour | Annual | 1-hour | 3-hour | 24-hour | Annual |
| | | | 2016 | 2016 | 2038–2039 | 2042 | 2042 | 2038–2039 | 2038–2039 | 2038–2039 | 2038–2039 |
| Operations (continued) | | | | | | | | | | | |
| Chemical wash system | 2013 | 2042 | 2.45 | 3.94×10 ⁻¹ | 4.40×10 ⁻³ | 1.79 | 1.32×10 ⁻² | 2.44×10 ⁻³ | 8.29×10 ⁻⁴ | 1.69×10 ⁻⁴ | 1.25×10 ⁻⁶ |
| HLW Melter Interim Storage Facility | 2018 | 2144 | a | a | b | b | b | b | b | b | b |
| Contact-Handled Mixed Transuranic Waste Facilities | 2009 | 2010 | a | a | a | a | a | a | a | a | a |
| Remote-Handled Mixed Transuranic Waste Facility | 2015 | 2019 | 2.16×10 ² | 3.35×10 ¹ | a | a | a | a | a | a | a |
| Transuranic Waste Interim Storage Facility | 2009 | 2034 | b | b | a | a | a | a | a | a | a |
| Bulk Vitrification Facility | 2018 | 2039 | a | a | 8.16×10 ⁻² | a | a | 2.29×10 ¹ | 9.69 | 3.02 | 2.18×10 ⁻² |
| Solid-Liquid Separations Facility | 2018 | 2039 | a | a | 1.29×10 ⁻¹ | a | a | 4.09 | 1.36 | 2.44×10 ⁻¹ | 1.02×10 ⁻³ |
| Cast Stone Facility | 2018 | 2039 | a | a | 2.61×10 ⁻¹ | a | a | 5.68×10 ⁻¹ | 1.98×10 ⁻¹ | 4.95×10 ⁻² | 9.25×10 ⁻⁴ |
| Effluent Treatment Facility | 2006 | 2045 | 7.85 | 2.41 | 1.02×10 ⁻² | 7.66×10 ¹ | 3.57 | 1.06×10 ⁻² | 6.52×10 ⁻³ | 1.09×10 ⁻³ | 5.08×10 ⁻⁵ |
| Evaporator | 2006 | 2042 | 2.00×10 ² | 3.09×10 ¹ | 5.88×10 ⁻¹ | 1.87×10 ¹ | 1.76×10 ⁻¹ | 3.15×10 ⁻¹ | 1.13×10 ⁻¹ | 2.13×10 ⁻² | 2.00×10 ⁻⁴ |
| Borrow Area C | 2006 | 2052 | 6.91×10 ² | 2.83×10 ² | 4.42×10 ⁻¹ | 3.98×10 ² | 9.10×10 ⁻¹ | 9.72×10 ⁻¹ | 6.58×10 ⁻¹ | 2.07×10 ⁻¹ | 4.75×10 ⁻⁴ |
| Deactivation | | | | | | | | | | | |
| Mobile retrieval system | 2013 | 2042 | 7.28×10 ² | 1.17×10 ² | 2.92×10 ⁻² | 3.29×10 ⁻¹ | 2.43×10 ⁻³ | 1.74×10 ⁻² | 5.92×10 ⁻³ | 1.21×10 ⁻³ | 8.93×10 ⁻⁶ |
| Vacuum-based retrieval system | 2013 | 2042 | 1.18×10 ¹ | 1.90 | 4.76×10 ⁻⁴ | 5.85×10 ⁻³ | 4.32×10 ⁻⁵ | 2.83×10 ⁻⁴ | 9.63×10 ⁻⁵ | 1.96×10 ⁻⁵ | 1.45×10 ⁻⁷ |
| Chemical wash system | 2013 | 2042 | 3.40×10 ¹ | 5.45 | 3.07×10 ⁻³ | 3.51×10 ⁻² | 2.59×10 ⁻⁴ | 1.91×10 ⁻³ | 6.49×10 ⁻⁴ | 1.32×10 ⁻⁴ | 9.79×10 ⁻⁷ |
| IHLW Interim Storage Facility | 2067 | 2067 | a | a | a | a | a | a | a | a | a |
| Waste Treatment Plant | 2044 | 2045 | a | a | a | a | a | a | a | a | a |
| Cesium and Strontium Capsule Processing Facility | 2044 | 2044 | a | a | a | a | a | a | a | a | a |
| Contact-Handled Mixed Transuranic Waste Facilities | 2011 | 2012 | a | a | a | a | a | a | a | a | a |
| Remote-Handled Mixed Transuranic Waste Facility | 2020 | 2021 | a | a | a | a | a | a | a | a | a |
| Transuranic Waste Interim Storage Facility | 2035 | 2035 | a | a | a | a | a | a | a | a | a |
| Bulk Vitrification Facility | 2040 | 2041 | a | a | a | a | a | a | a | a | a |
| Solid-Liquid Separations Facility | 2040 | 2041 | a | a | a | a | a | a | a | a | a |
| Cast Stone Facility | 2040 | 2041 | a | a | a | a | a | a | a | a | a |
| Effluent Treatment Facility original | 2026 | 2026 | a | a | a | a | a | a | a | a | a |
| Effluent Treatment Facility replacement | 2046 | 2046 | a | a | a | a | a | a | a | a | a |
| Evaporator original | 2018 | 2018 | a | a | a | a | a | a | a | a | a |
| Evaporator replacement | 2043 | 2043 | a | a | a | a | a | a | a | a | a |
| Closure | | | | | | | | | | | |
| Grout facility (tank-filling) construction | 2031 | 2032 | a | a | a | a | a | a | a | a | a |
| Grout facility (tank-filling) operations | 2033 | 2042 | a | a | 5.48×10 ⁻¹ | 5.21 | 3.85×10 ⁻² | 4.35×10 ⁻¹ | 1.48×10 ⁻¹ | 3.02×10 ⁻² | 2.23×10 ⁻⁴ |
| Grout facility (tank-filling) deactivation | 2043 | 2043 | a | a | a | a | a | a | a | a | a |
| Ancillary equipment grouting | 2012 | 2032 | 4.83 | 7.74×10 ⁻¹ | a | a | a | a | a | a | a |
| Containment structure construction | 2018 | 2021 | a | a | a | a | a | a | a | a | a |

Table G–125. Tank Closure Alternative 4 Maximum Criteria Pollutant Concentrations of Peak Activity Periods (continued)

| Facility/System | Start Year | End Year | Concentration (micrograms per cubic meter) | | | | | | | | |
|---|------------|----------|--|----------------------|-----------------------|----------------------------|-----------------------|-----------------------|-----------------------|-----------------------|-----------------------|
| | | | Carbon Monoxide | | Nitrogen Dioxide | PM ₁₀ | | Sulfur Dioxide | | | |
| | | | 1-hour | 8-hour | Annual | 24-hour | Annual | 1-hour | 3-hour | 24-hour | Annual |
| | | | 2016 | 2016 | 2038–2039 | 2042 | 2042 | 2038–2039 | 2038–2039 | 2038–2039 | 2038–2039 |
| Closure (continued) | | | | | | | | | | | |
| Containment structure deactivation | 2042 | 2044 | a | a | a | 3.48 | 2.58×10 ⁻² | a | a | a | a |
| Modified Resource Conservation and Recovery Act Subtitle C barrier construction | 2038 | 2044 | a | a | 6.98 | 2.40×10 ³ | 1.78×10 ¹ | 2.06×10 ¹ | 7.00 | 1.43 | 1.06×10 ⁻² |
| Decontamination and decommissioning of 10 selected facilities | 2018 | 2028 | a | a | a | a | a | a | a | a | a |
| Postclosure care | 2045 | 2144 | a | a | a | a | a | a | a | a | a |
| BX tank farm removal | 2022 | 2033 | a | a | a | a | a | a | a | a | a |
| BX tank farm deep soil removal | 2034 | 2041 | a | a | 3.57×10 ⁻¹ | a | a | 1.91×10 ⁻¹ | 6.85×10 ⁻² | 1.29×10 ⁻² | 1.22×10 ⁻⁴ |
| SX tank farm removal | 2022 | 2033 | a | a | a | a | a | a | a | a | a |
| SX tank farm deep soil removal | 2034 | 2041 | a | a | 1.31 | a | a | 8.92×10 ⁻¹ | 3.43×10 ⁻¹ | 6.98×10 ⁻² | 4.46×10 ⁻⁴ |
| Preprocessing Facility construction | 2019 | 2021 | a | a | a | a | a | a | a | a | a |
| Preprocessing Facility operations | 2022 | 2042 | a | a | 2.49×10 ⁻² | 9.72×10 ⁻⁵ | 1.82×10 ⁻⁶ | 1.12 | 3.91×10 ⁻¹ | 9.74×10 ⁻² | 1.82×10 ⁻³ |
| Preprocessing Facility deactivation | 2043 | 2043 | a | a | a | a | a | a | a | a | a |
| Total | | | 3.57×10 ⁴ | 5.55×10 ³ | 1.31×10 ¹ | 2.96×10³ | 2.33×10 ¹ | 7.18×10 ¹ | 2.98×10 ¹ | 6.89 | 9.39×10 ⁻² |

^a This activity would not contribute to the concentration during the peak year(s) for this pollutant and averaging period.

^b Emissions for this activity and pollutant were not calculated because they would be small compared with those for other activities under this alternative, as explained in Section G.2.

Note: Total concentrations exceeding applicable standards are presented in **bold**.

Key: HLW=high-level radioactive waste; IHLW=immobilized high-level radioactive waste; PM₁₀=particulate matter with an aerodynamic diameter less than or equal to 10 micrometers.

Source: SAIC 2007a, 2008.

Table G–126. Tank Closure Alternative 4 Maximum Toxic Pollutant Concentrations of Peak Activity Periods

| Facility/System | Start Year | End Year | Concentration (micrograms per cubic meter) | | | | | | |
|--|------------|----------|--|-----------------------|-----------------------|-----------------------|-----------|-----------------------|-----------------------|
| | | | Ammonia | Benzene | 1,3-Butadiene | Formaldehyde | Mercury | Toluene | Xylene |
| | | | 24-hour | Annual | Annual | Annual | 24-hour | 24-hour | 24-hour |
| | | | 2016 | 2016–2017 | 2038–2039 | 2038–2039 | 2018–2039 | 2016–2017 | 2016–2017 |
| Construction | | | | | | | | | |
| Canister Storage Building | 2006 | 2016 | b | b | a | a | a | b | b |
| IHLW Shipping/Transfer Facility | 2011 | 2013 | a | a | a | a | a | a | a |
| IHLW Interim Storage Modules | 2014 | 2022 | b | b | a | a | b | b | b |
| Other infrastructure upgrades | 2006 | 2034 | b | b | a | a | b | b | b |
| Tank upgrades | 2006 | 2025 | 8.81×10 ⁻² | b | a | a | b | b | b |
| Waste Treatment Plant | 2006 | 2017 | 1.29 | 2.64×10 ⁻³ | a | a | a | 1.69 | 5.06×10 ⁻¹ |
| Cesium and Strontium Capsule Processing Facility | 2038 | 2041 | a | a | 7.45×10 ⁻⁶ | 3.14×10 ⁻⁴ | b | a | a |
| Waste receiver facilities | 2013 | 2017 | b | b | a | a | a | b | b |
| Tank risers | 2013 | 2016 | 2.68 | b | a | a | a | b | b |
| Mobile retrieval system | 2013 | 2042 | 4.03×10 ⁻¹ | b | b | b | b | b | b |
| Vacuum-based retrieval system | 2013 | 2042 | 2.23×10 ⁻¹ | b | b | b | b | b | b |
| Chemical wash system | 2013 | 2042 | 6.25×10 ⁻³ | b | b | b | b | b | b |
| HLW Melter Interim Storage Facility | 2015 | 2016 | b | b | a | a | a | b | b |
| Contact-Handled Mixed Transuranic Waste Facilities | 2008 | 2008 | a | a | a | a | a | a | a |
| Remote-Handled Mixed Transuranic Waste Facility | 2013 | 2014 | a | a | a | a | a | a | a |
| Transuranic Waste Interim Storage Facility | 2008 | 2009 | a | a | a | a | a | a | a |
| Bulk Vitrification Facility | 2016 | 2017 | 3.23×10 ⁻² | 8.90×10 ⁻⁵ | a | a | a | 1.61×10 ⁻¹ | 4.62×10 ⁻² |
| Solid-Liquid Separations Facility | 2016 | 2017 | 3.04×10 ⁻² | 4.95×10 ⁻⁵ | a | a | a | 1.30×10 ⁻¹ | 3.75×10 ⁻² |
| Cast Stone Facility | 2016 | 2017 | 1.24×10 ⁻² | 5.05×10 ⁻⁵ | a | a | a | 6.22×10 ⁻² | 1.78×10 ⁻² |
| Effluent Treatment Facility replacement 1 | 2023 | 2025 | a | a | a | a | b | a | a |
| Evaporator replacement 1 | 2015 | 2017 | 6.32×10 ⁻² | 3.41×10 ⁻⁴ | a | a | a | 4.65×10 ⁻¹ | 1.32×10 ⁻¹ |
| Underground transfer line 1,000-foot sections | 2009 | 2009 | a | a | a | a | a | a | a |
| Operations | | | | | | | | | |
| IHLW Interim Storage Facility | 2018 | 2066 | a | a | b | b | b | a | a |
| Other infrastructure upgrades | 2006 | 2042 | b | b | b | b | b | b | b |
| Routine operations | 2006 | 2042 | 5.59 | b | b | b | b | b | b |

Table G-126. Tank Closure Alternative 4 Maximum Toxic Pollutant Concentrations of Peak Activity Periods (continued)

| Facility/System | Start Year | End Year | Concentration (micrograms per cubic meter) | | | | | | |
|--|------------|----------|--|-----------------------|------------------------|-----------------------|-----------------------|-----------------------|-----------------------|
| | | | Ammonia | Benzene | 1,3-Butadiene | Formaldehyde | Mercury | Toluene | Xylene |
| | | | 24-hour | Annual | Annual | Annual | 24-hour | 24-hour | 24-hour |
| | | | 2016 | 2016-2017 | 2038-2039 | 2038-2039 | 2018-2039 | 2016-2017 | 2016-2017 |
| Operations (continued) | | | | | | | | | |
| Retrieval operations | 2006 | 2042 | 4.60×10 ⁻² | b | b | b | b | b | b |
| Double-shell tank interim stabilization | 2006 | 2042 | 3.02×10 ⁻¹ | b | b | b | b | b | b |
| Waste Treatment Plant | 2018 | 2042 | a | a | 1.85×10 ⁻⁸ | 5.71×10 ⁻⁷ | 6.25×10 ⁻³ | a | a |
| Waste Treatment Plant, cesium and strontium capsules | 2043 | 2043 | a | a | a | a | a | a | a |
| Cesium and Strontium Capsule Processing Facility | 2042 | 2043 | a | a | a | a | a | a | a |
| Mobile retrieval system | 2013 | 2042 | 4.03×10 ⁻¹ | b | b | b | b | b | b |
| Vacuum-based retrieval system | 2013 | 2042 | 2.23×10 ⁻¹ | b | b | b | b | b | b |
| Chemical wash system | 2013 | 2042 | 6.25×10 ⁻³ | b | b | b | b | b | b |
| HLW Melter Interim Storage Facility | 2018 | 2144 | a | a | b | b | b | a | a |
| Contact-Handled Mixed Transuranic Waste Facilities | 2009 | 2010 | a | a | a | a | a | a | a |
| Remote-Handled Mixed Transuranic Waste Facility | 2015 | 2019 | 1.99×10 ⁻³ | 1.87×10 ⁻⁵ | a | a | b | 2.87×10 ⁻² | 8.12×10 ⁻³ |
| Transuranic Waste Interim Storage Facility | 2009 | 2034 | b | b | a | a | b | b | b |
| Bulk Vitrification Facility | 2018 | 2039 | a | a | 1.23×10 ⁻¹⁰ | 5.20×10 ⁻⁹ | 6.78×10 ⁻³ | a | a |
| Solid-Liquid Separations Facility | 2018 | 2039 | a | a | 1.51×10 ⁻⁶ | 5.53×10 ⁻⁵ | b | a | a |
| Cast Stone Facility | 2018 | 2039 | a | a | 2.62×10 ⁻⁶ | 9.27×10 ⁻⁵ | b | a | a |
| Effluent Treatment Facility | 2006 | 2045 | 3.72×10 ⁻⁴ | 6.54×10 ⁻⁶ | 1.08×10 ⁻⁷ | 4.03×10 ⁻⁶ | b | 1.53×10 ⁻³ | 4.39×10 ⁻⁴ |
| Evaporator | 2006 | 2042 | 9.82×10 ⁻² | 1.24×10 ⁻⁴ | 5.22×10 ⁻⁶ | 1.57×10 ⁻⁴ | b | 5.79×10 ⁻³ | 4.04×10 ⁻³ |
| Borrow Area C | 2006 | 2052 | 3.08×10 ⁻¹ | 1.24×10 ⁻⁴ | 4.04×10 ⁻⁶ | 1.27×10 ⁻⁴ | b | 2.28×10 ⁻¹ | 7.18×10 ⁻² |
| Deactivation | | | | | | | | | |
| Mobile retrieval system | 2013 | 2042 | b | b | b | b | b | b | b |
| Vacuum-based retrieval system | 2013 | 2042 | b | b | b | b | b | b | b |
| Chemical wash system | 2013 | 2042 | b | b | b | b | b | b | b |
| IHLW Interim Storage Facility | 2067 | 2067 | a | a | a | a | a | a | a |
| Waste Treatment Plant | 2044 | 2045 | a | a | a | a | a | a | a |
| Cesium and Strontium Capsule Processing Facility | 2044 | 2044 | a | a | a | a | a | a | a |
| Contact-Handled Mixed Transuranic Waste Facilities | 2011 | 2012 | a | a | a | a | a | a | a |

Table G–126. Tank Closure Alternative 4 Maximum Toxic Pollutant Concentrations of Peak Activity Periods (continued)

| Facility/System | Start Year | End Year | Concentration (micrograms per cubic meter) | | | | | | |
|---|------------|----------|--|-----------------------|-----------------------|-----------------------|-----------|-----------------------|-----------------------|
| | | | Ammonia | Benzene | 1,3-Butadiene | Formaldehyde | Mercury | Toluene | Xylene |
| | | | 24-hour | Annual | Annual | Annual | 24-hour | 24-hour | 24-hour |
| | | | 2016 | 2016–2017 | 2038–2039 | 2038–2039 | 2018–2039 | 2016–2017 | 2016–2017 |
| Deactivation (continued) | | | | | | | | | |
| Remote-Handled Mixed Transuranic Waste Facility | 2020 | 2021 | a | a | a | a | b | a | a |
| Transuranic Waste Interim Storage Facility | 2035 | 2035 | a | a | a | a | b | a | a |
| Bulk Vitrification Facility | 2040 | 2041 | a | a | a | a | a | a | a |
| Solid-Liquid Separations Facility | 2040 | 2041 | a | a | a | a | a | a | a |
| Cast Stone Facility | 2040 | 2041 | a | a | a | a | a | a | a |
| Effluent Treatment Facility original | 2026 | 2026 | a | a | a | a | b | a | a |
| Effluent Treatment Facility replacement 1 | 2046 | 2046 | a | a | a | a | a | a | a |
| Evaporator original | 2018 | 2018 | a | a | a | a | b | a | a |
| Evaporator replacement 1 | 2043 | 2043 | a | a | a | a | a | a | a |
| Closure | | | | | | | | | |
| Grout facility (tank-filling) construction | 2031 | 2032 | a | a | a | a | b | a | a |
| Grout facility (tank-filling) operations | 2033 | 2042 | a | a | 4.85×10^{-6} | 1.46×10^{-4} | b | a | a |
| Grout facility (tank-filling) deactivation | 2043 | 2043 | a | a | a | a | a | a | a |
| Ancillary equipment grouting | 2012 | 2032 | 2.44×10^{-3} | 2.43×10^{-6} | a | a | b | 1.44×10^{-4} | 1.00×10^{-4} |
| Containment structure construction | 2018 | 2021 | a | a | a | a | b | a | a |
| Containment structure deactivation | 2042 | 2044 | a | a | a | a | a | a | a |
| Modified Resource Conservation and Recovery Act Subtitle C barrier construction | 2038 | 2044 | a | a | 6.05×10^{-5} | 1.82×10^{-3} | b | a | a |
| Decontamination and decommissioning of 10 selected facilities | 2018 | 2028 | a | a | a | a | b | a | a |
| Postclosure care | 2045 | 2144 | a | a | a | a | a | a | a |
| BX tank farm removal | 2022 | 2033 | a | a | a | a | b | a | a |
| BX tank farm deep soil removal | 2034 | 2041 | a | a | 3.17×10^{-6} | 9.56×10^{-5} | b | a | a |
| SX tank farm removal | 2022 | 2033 | a | a | a | a | b | a | a |
| SX tank farm deep soil removal | 2034 | 2041 | a | a | 1.16×10^{-5} | 3.51×10^{-4} | b | a | a |
| Preprocessing Facility construction | 2019 | 2021 | a | a | a | a | b | a | a |

Table G–126. Tank Closure Alternative 4 Maximum Toxic Pollutant Concentrations of Peak Activity Periods (continued)

| Facility/System | Start Year | End Year | Concentration (micrograms per cubic meter) | | | | | | |
|-------------------------------------|------------|----------|--|-----------------------|------------------------|-----------------------|-----------------------|-----------|-----------------------|
| | | | Ammonia | Benzene | 1,3-Butadiene | Formaldehyde | Mercury | Toluene | Xylene |
| | | | 24-hour | Annual | Annual | Annual | 24-hour | 24-hour | 24-hour |
| | | | 2016 | 2016–2017 | 2038–2039 | 2038–2039 | 2018–2039 | 2016–2017 | 2016–2017 |
| Closure (continued) | | | | | | | | | |
| Preprocessing Facility operations | 2022 | 2042 | a | a | 1.31×10^{-10} | 7.47×10^{-9} | b | a | a |
| Preprocessing Facility deactivation | 2043 | 2043 | a | a | a | a | a | a | a |
| Total | | | 1.18×10^1 | 3.44×10^{-3} | 1.01×10^{-4} | 3.17×10^{-3} | 1.30×10^{-2} | 2.77 | 8.25×10^{-1} |

^a This activity would not contribute to the concentration during the peak year(s) for this pollutant and averaging period.

^b Emissions for this activity and pollutant were not calculated because they would be small compared with those for other activities under this alternative, as explained in Section G.2.

Key: HLW=high-level radioactive waste; IHLW=immobilized high-level radioactive waste.

Source: SAIC 2007a, 2008.

Table G-127. Tank Closure Alternative 5 Maximum Criteria Pollutant Concentrations of Peak Activity Periods

| Facility/System | Start Year | End Year | Concentration (micrograms per cubic meter) | | | | | | | | |
|--|------------|----------|--|----------------------|-----------------------|------------------|--------|-----------------------|-----------------------|-----------------------|-----------------------|
| | | | Carbon Monoxide | | Nitrogen Dioxide | PM ₁₀ | | Sulfur Dioxide | | | |
| | | | 1-hour | 8-hour | Annual | 24-hour | Annual | 1-hour | 3-hour | 24-hour | Annual |
| | | | 2016 | 2029-2032 | 2029-2032 | 2037 | 2037 | 2029-2032 | 2029-2032 | 2029-2032 | 2029-2032 |
| Construction | | | | | | | | | | | |
| Canister Storage Building | 2006 | 2016 | 4.37×10 ¹ | a | a | a | a | a | a | a | a |
| IHLW Shipping/Transfer Facility | 2011 | 2013 | a | a | a | a | a | a | a | a | a |
| IHLW Interim Storage Modules | 2014 | 2019 | 3.15×10 ² | a | a | a | a | a | a | a | a |
| Other infrastructure upgrades | 2006 | 2034 | 1.80×10 ¹ | 2.88 | 6.70×10 ⁻³ | a | a | 4.12×10 ⁻³ | 1.40×10 ⁻³ | 2.86×10 ⁻⁴ | 2.11×10 ⁻⁶ |
| Tank upgrades | 2006 | 2025 | 5.67×10 ³ | a | a | a | a | a | a | a | a |
| Waste Treatment Plant | 2006 | 2017 | 1.72×10 ⁴ | a | a | a | a | a | a | a | a |
| Cesium and Strontium Capsule Processing Facility | 2029 | 2032 | a | 1.03×10 ³ | 6.13×10 ⁻¹ | a | a | 8.92 | 3.19 | 6.02×10 ⁻¹ | 5.67×10 ⁻³ |
| Waste receiver facilities | 2013 | 2017 | 1.87×10 ³ | a | a | a | a | a | a | a | a |
| Tank risers | 2013 | 2016 | 2.99×10 ² | a | a | a | a | a | a | a | a |
| Double-shell tank replacement | 2014 | 2019 | 9.21×10 ² | a | a | a | a | a | a | a | a |
| Sulfate Removal Facility | 2016 | 2017 | 8.85×10 ³ | a | a | a | a | a | a | a | a |
| Modified sluicing retrieval system | 2013 | 2033 | 1.16×10 ³ | 1.86×10 ² | 2.29×10 ⁻² | a | a | 1.07×10 ⁻² | 3.64×10 ⁻³ | 7.43×10 ⁻⁴ | 5.50×10 ⁻⁶ |
| Mobile retrieval system | 2013 | 2023 | 1.48×10 ³ | a | a | a | a | a | a | a | a |
| Vacuum-based retrieval system | 2024 | 2033 | a | 2.61×10 ² | 3.78×10 ⁻¹ | a | a | 2.35×10 ⁻¹ | 7.98×10 ⁻² | 1.63×10 ⁻² | 1.20×10 ⁻⁴ |
| HLW Melter Interim Storage Facility | 2015 | 2016 | 1.39×10 ¹ | a | a | a | a | a | a | a | a |
| Contact-Handled Mixed Transuranic Waste Facilities | 2008 | 2008 | a | a | a | a | a | a | a | a | a |
| Remote-Handled Mixed Transuranic Waste Facility | 2013 | 2014 | a | a | a | a | a | a | a | a | a |
| Transuranic Waste Interim Storage Facility | 2008 | 2009 | a | a | a | a | a | a | a | a | a |
| Bulk Vitrification Facility | 2016 | 2017 | 1.08×10 ³ | a | a | a | a | a | a | a | a |
| Solid-Liquid Separations Facility | 2016 | 2017 | 1.15×10 ³ | a | a | a | a | a | a | a | a |
| Cast Stone Facility | 2016 | 2017 | 4.82×10 ² | a | a | a | a | a | a | a | a |
| Effluent Treatment Facility replacement 1 | 2023 | 2025 | a | a | a | a | a | a | a | a | a |
| Evaporator replacement 1 | 2015 | 2017 | 3.56×10 ³ | a | a | a | a | a | a | a | a |
| Underground transfer line 1,000-foot sections | 2009 | 2009 | a | a | a | a | a | a | a | a | a |
| Operations | | | | | | | | | | | |
| IHLW Interim Storage Facility | 2018 | 2066 | a | b | b | b | b | b | b | b | b |
| Other infrastructure upgrades | 2006 | 2033 | b | b | b | a | a | b | b | b | b |
| Routine operations | 2006 | 2033 | 5.72×10 ¹ | 1.50×10 ¹ | 8.27×10 ⁻² | a | a | b | b | b | b |

Table G–127. Tank Closure Alternative 5 Maximum Criteria Pollutant Concentrations of Peak Activity Periods (continued)

| Facility/System | Start Year | End Year | Concentration (micrograms per cubic meter) | | | | | | | | |
|--|------------|----------|--|-----------------------|-----------------------|----------------------|-----------------------|-----------------------|-----------------------|-----------------------|-----------------------|
| | | | Carbon Monoxide | | Nitrogen Dioxide | PM ₁₀ | | Sulfur Dioxide | | | |
| | | | 1-hour | 8-hour | Annual | 24-hour | Annual | 1-hour | 3-hour | 24-hour | Annual |
| | | | 2016 | 2029–2032 | 2029–2032 | 2037 | 2037 | 2029–2032 | 2029–2032 | 2029–2032 | 2029–2032 |
| Operations (continued) | | | | | | | | | | | |
| Retrieval operations | 2006 | 2033 | 7.66×10 ⁻¹ | 1.23×10 ⁻¹ | 4.45×10 ⁻⁴ | a | a | b | b | b | b |
| Double-shell tank interim stabilization | 2006 | 2033 | 5.02 | 8.05×10 ⁻¹ | 2.92×10 ⁻³ | a | a | b | b | b | b |
| Waste Treatment Plant | 2018 | 2033 | a | 8.58×10 ¹ | 4.08 | a | a | 1.95×10 ¹ | 1.19×10 ¹ | 2.00 | 9.31×10 ⁻² |
| Waste Treatment Plant, cesium and strontium capsules | 2034 | 2034 | a | a | a | a | a | a | a | a | a |
| Cesium and Strontium Capsule Processing Facility | 2033 | 2034 | a | a | a | a | a | a | a | a | a |
| Double-shell tank replacement | 2020 | 2033 | a | 8.79×10 ⁻² | 4.45×10 ⁻⁴ | a | a | b | b | b | b |
| Sulfate Removal Facility | 2018 | 2033 | a | 2.18×10 ² | 2.55×10 ⁻¹ | a | a | 1.79 | 6.13×10 ⁻¹ | 1.64×10 ⁻¹ | 2.69×10 ⁻³ |
| Modified sluicing retrieval system | 2013 | 2033 | 3.22×10 ² | 5.15×10 ¹ | 1.02×10 ⁻² | a | a | 5.12×10 ⁻³ | 1.74×10 ⁻³ | 3.55×10 ⁻⁴ | 2.63×10 ⁻⁶ |
| Mobile retrieval system | 2013 | 2023 | 6.81 | a | a | a | a | a | a | a | a |
| Vacuum-based retrieval system | 2024 | 2033 | a | 1.78 | 6.45×10 ⁻³ | a | a | b | b | b | b |
| HLW Melter Interim Storage Facility | 2018 | 2139 | a | b | b | b | b | b | b | b | b |
| Contact-Handled Mixed Transuranic Waste Facilities | 2009 | 2010 | a | a | a | a | a | a | a | a | a |
| Remote-Handled Mixed Transuranic Waste Facility | 2015 | 2019 | 2.16×10 ² | a | a | a | a | a | a | a | a |
| Transuranic Waste Interim Storage Facility | 2009 | 2034 | b | b | b | a | a | b | b | b | b |
| Bulk Vitrification Facility | 2018 | 2033 | a | 1.49×10 ¹ | 1.02×10 ⁻¹ | a | a | 2.85×10 ¹ | 1.21×10 ¹ | 3.77 | 2.72×10 ⁻² |
| Solid-Liquid Separations Facility | 2018 | 2033 | a | 5.98×10 ² | 1.78×10 ⁻¹ | a | a | 5.63 | 1.88 | 3.35×10 ⁻¹ | 1.40×10 ⁻³ |
| Cast Stone Facility | 2018 | 2033 | a | 1.23×10 ² | 3.59×10 ⁻¹ | a | a | 7.82×10 ⁻¹ | 2.73×10 ⁻¹ | 6.80×10 ⁻² | 1.27×10 ⁻³ |
| Effluent Treatment Facility | 2006 | 2036 | 7.85 | 2.41 | 1.02×10 ⁻² | a | a | 1.06×10 ⁻² | 6.52×10 ⁻³ | 1.09×10 ⁻³ | 5.08×10 ⁻⁵ |
| Evaporator | 2006 | 2034 | 2.00×10 ² | 3.09×10 ¹ | 5.88×10 ⁻¹ | a | a | 3.15×10 ⁻¹ | 1.13×10 ⁻¹ | 2.13×10 ⁻² | 2.00×10 ⁻⁴ |
| Borrow Area C | 2006 | 2052 | 6.91×10 ² | 2.83×10 ² | 4.42×10 ⁻¹ | 3.98×10 ² | 9.10×10 ⁻¹ | 9.72×10 ⁻¹ | 6.58×10 ⁻¹ | 2.07×10 ⁻¹ | 4.75×10 ⁻⁴ |
| Deactivation | | | | | | | | | | | |
| Sulfate Removal Facility | 2034 | 2035 | a | a | a | a | a | a | a | a | a |
| Modified sluicing retrieval system | 2013 | 2033 | 8.25×10 ² | 1.32×10 ² | 1.79×10 ⁻² | a | a | 1.02×10 ⁻² | 3.48×10 ⁻³ | 7.10×10 ⁻⁴ | 5.25×10 ⁻⁶ |
| Mobile retrieval system | 2013 | 2023 | 7.40×10 ² | a | a | a | a | a | a | a | a |
| Vacuum-based retrieval system | 2024 | 2033 | a | 5.69 | 1.43×10 ⁻³ | a | a | 8.50×10 ⁻⁴ | 2.89×10 ⁻⁴ | 5.89×10 ⁻⁵ | 4.36×10 ⁻⁷ |
| IHLW Interim Storage Facility | 2067 | 2067 | a | a | a | a | a | a | a | a | a |
| Waste Treatment Plant | 2035 | 2036 | a | a | a | a | a | a | a | a | a |

Table G–127. Tank Closure Alternative 5 Maximum Criteria Pollutant Concentrations of Peak Activity Periods (continued)

| Facility/System | Start Year | End Year | Concentration (micrograms per cubic meter) | | | | | | | | |
|---|------------|----------|--|-----------------------|-----------------------|----------------------------|----------------------|-----------------------|-----------------------|-----------------------|-----------------------|
| | | | Carbon Monoxide | | Nitrogen Dioxide | PM ₁₀ | | Sulfur Dioxide | | | |
| | | | 1-hour | 8-hour | Annual | 24-hour | Annual | 1-hour | 3-hour | 24-hour | Annual |
| | | | 2016 | 2029–2032 | 2029–2032 | 2037 | 2037 | 2029–2032 | 2029–2032 | 2029–2032 | 2029–2032 |
| Deactivation (continued) | | | | | | | | | | | |
| Cesium and Strontium Capsule Processing Facility | 2035 | 2035 | a | a | a | a | a | a | a | a | a |
| Contact-Handled Mixed Transuranic Waste Facilities | 2011 | 2012 | a | a | a | a | a | a | a | a | a |
| Remote-Handled Mixed Transuranic Waste Facility | 2020 | 2021 | a | a | a | a | a | a | a | a | a |
| Transuranic Waste Interim Storage Facility | 2035 | 2035 | a | a | a | a | a | a | a | a | a |
| Bulk Vitrification Facility | 2034 | 2035 | a | a | a | a | a | a | a | a | a |
| Solid-Liquid Separations Facility | 2034 | 2035 | a | a | a | a | a | a | a | a | a |
| Cast Stone Facility | 2034 | 2035 | a | a | a | a | a | a | a | a | a |
| Effluent Treatment Facility original | 2026 | 2026 | a | a | a | a | a | a | a | a | a |
| Effluent Treatment Facility replacement 1 | 2037 | 2037 | a | a | a | 6.06×10 ² | 5.92 | a | a | a | a |
| Evaporator original | 2018 | 2018 | a | a | a | a | a | a | a | a | a |
| Evaporator replacement 1 | 2035 | 2035 | a | a | a | a | a | a | a | a | a |
| Closure | | | | | | | | | | | |
| Grout facility (tank-filling) construction | 2022 | 2023 | a | a | a | a | a | a | a | a | a |
| Grout facility (tank-filling) operations | 2024 | 2033 | a | 5.86×10 ¹ | 6.92×10 ⁻¹ | a | a | 4.39×10 ⁻¹ | 1.49×10 ⁻¹ | 3.04×10 ⁻² | 2.25×10 ⁻⁴ |
| Grout facility (tank-filling) deactivation | 2034 | 2034 | a | a | a | a | a | a | a | a | a |
| Ancillary equipment grouting | 2013 | 2033 | 5.68 | 9.11×10 ⁻¹ | 1.27×10 ⁻² | a | a | 7.91×10 ⁻³ | 2.69×10 ⁻³ | 5.49×10 ⁻⁴ | 4.06×10 ⁻⁶ |
| Hanford barrier construction | 2029 | 2039 | a | 4.52×10 ³ | 1.32×10 ¹ | 3.92×10 ³ | 2.90×10 ¹ | 3.90×10 ¹ | 1.33×10 ¹ | 2.71 | 2.00×10 ⁻² |
| Decontamination and decommissioning of 10 selected facilities | 2012 | 2022 | 4.10×10 ¹ | a | a | a | a | a | a | a | a |
| Postclosure care | 2040 | 2139 | a | a | a | a | a | a | a | a | a |
| Total | | | 4.73×10⁴ | 7.62×10 ³ | 2.11×10 ¹ | 4.92×10³ | 3.58×10 ¹ | 1.06×10 ² | 4.43×10 ¹ | 9.92 | 1.52×10 ⁻¹ |

^a This activity would not contribute to the concentration during the peak year(s) for this pollutant and averaging period.

^b Emissions for this activity and pollutant were not calculated because they would be small compared with those for other activities under this alternative, as explained in Section G.2.

Note: Total concentrations exceeding applicable standards are presented in **bold**.

Key: HLW=high-level radioactive waste; IHLW=immobilized high-level radioactive waste; PM₁₀=particulate matter with an aerodynamic diameter less than or equal to 10 micrometers.

Source: SAIC 2007a, 2008.

Table G-128. Tank Closure Alternative 5 Maximum Toxic Pollutant Concentrations of Peak Activity Periods

| Facility/System | Start Year | End Year | Concentration (micrograms per cubic meter) | | | | | | |
|--|------------|----------|--|-----------------------|-----------------------|-----------------------|-----------------------|-----------------------|-----------------------|
| | | | Ammonia | Benzene | 1,3-Butadiene | Formaldehyde | Mercury | Toluene | Xylene |
| | | | 24-hour | Annual | Annual | Annual | 24-hour | 24-hour | 24-hour |
| | | | 2029-2032 | 2029-2032 | 2029-2032 | 2029-2032 | 2018-2033 | 2029-2032 | 2029-2032 |
| Construction | | | | | | | | | |
| Canister Storage Building | 2006 | 2016 | a | a | a | a | a | a | a |
| IHLW Shipping/Transfer Facility | 2011 | 2013 | a | a | a | a | a | a | a |
| IHLW Interim Storage Modules | 2014 | 2019 | a | a | a | a | b | a | a |
| Other infrastructure upgrades | 2006 | 2034 | b | b | b | b | b | b | b |
| Tank upgrades | 2006 | 2025 | a | a | a | a | b | a | a |
| Waste Treatment Plant | 2006 | 2017 | a | a | a | a | a | a | a |
| Cesium and Strontium Capsule Processing Facility | 2029 | 2032 | 1.18×10 ⁻¹ | 6.35×10 ⁻⁴ | 7.45×10 ⁻⁶ | 3.14×10 ⁻⁴ | b | 8.67×10 ⁻¹ | 2.47×10 ⁻¹ |
| Waste receiver facilities | 2013 | 2017 | a | a | a | a | a | a | a |
| Tank risers | 2013 | 2016 | a | a | a | a | a | a | a |
| Double-shell tank replacement | 2014 | 2019 | a | a | a | a | b | a | a |
| Sulfate Removal Facility | 2016 | 2017 | a | a | a | a | a | a | a |
| Modified sluicing retrieval system | 2013 | 2033 | 2.61×10 ⁻¹ | b | b | b | b | b | b |
| Mobile retrieval system | 2013 | 2023 | a | a | a | a | b | a | a |
| Vacuum-based retrieval system | 2024 | 2033 | 6.68×10 ⁻¹ | b | b | b | b | b | b |
| HLW Melter Interim Storage Facility | 2015 | 2016 | a | a | a | a | a | a | a |
| Contact-Handled Mixed Transuranic Waste Facilities | 2008 | 2008 | a | a | a | a | a | a | a |
| Remote-Handled Mixed Transuranic Waste Facility | 2013 | 2014 | a | a | a | a | a | a | a |
| Transuranic Waste Interim Storage Facility | 2008 | 2009 | a | a | a | a | a | a | a |
| Bulk Vitrification Facility | 2016 | 2017 | a | a | a | a | a | a | a |
| Solid-Liquid Separations Facility | 2016 | 2017 | a | a | a | a | a | a | a |
| Cast Stone Facility | 2016 | 2017 | a | a | a | a | a | a | a |
| Effluent Treatment Facility replacement 1 | 2023 | 2025 | a | a | a | a | b | a | a |
| Evaporator replacement 1 | 2015 | 2017 | a | a | a | a | a | a | a |
| Underground transfer lines | 2009 | 2009 | a | a | a | a | a | a | a |
| Operations | | | | | | | | | |
| IHLW Interim Storage Facility | 2018 | 2066 | b | b | b | b | b | b | b |
| Other infrastructure upgrades | 2006 | 2033 | b | b | b | b | b | b | b |
| Routine operations | 2006 | 2033 | 5.59 | b | b | b | b | b | b |
| Retrieval operations | 2006 | 2033 | 4.60×10 ⁻² | b | b | b | b | b | b |
| Double-shell tank interim stabilization | 2006 | 2033 | 3.02×10 ⁻¹ | b | b | b | b | b | b |
| Waste Treatment Plant | 2018 | 2033 | 6.54×10 ⁻¹ | 1.76×10 ⁻⁴ | 6.90×10 ⁻⁸ | 2.10×10 ⁻⁶ | 9.78×10 ⁻³ | 5.76×10 ⁻⁵ | 2.26×10 ⁻⁴ |
| Waste Treatment Plant, cesium and strontium capsules | 2034 | 2034 | a | a | a | a | a | a | a |
| Cesium and Strontium Capsule Processing Facility | 2033 | 2034 | a | a | a | a | b | a | a |
| Double-shell tank replacement | 2020 | 2033 | 2.97×10 ⁻² | b | b | b | b | b | b |

Table G-128. Tank Closure Alternative 5 Maximum Toxic Pollutant Concentrations of Peak Activity Periods (continued)

| Facility/System | Start Year | End Year | Concentration (micrograms per cubic meter) | | | | | | |
|--|------------|----------|--|-----------------------|------------------------|-----------------------|-----------------------|-----------------------|-----------------------|
| | | | Ammonia | Benzene | 1,3-Butadiene | Formaldehyde | Mercury | Toluene | Xylene |
| | | | 24-hour | Annual | Annual | Annual | 24-hour | 24-hour | 24-hour |
| | | | 2029-2032 | 2029-2032 | 2029-2032 | 2029-2032 | 2018-2033 | 2029-2032 | 2029-2032 |
| Operations (continued) | | | | | | | | | |
| Sulfate Removal Facility | 2018 | 2033 | 2.88×10 ⁻² | 2.95×10 ⁻⁴ | 3.22×10 ⁻⁶ | 1.40×10 ⁻⁴ | b | 2.37×10 ⁻¹ | 6.74×10 ⁻² |
| Modified sluicing retrieval system | 2013 | 2033 | 2.61×10 ⁻¹ | b | b | b | b | b | b |
| Mobile retrieval system | 2013 | 2023 | a | a | a | a | b | a | a |
| Vacuum-based retrieval system | 2024 | 2033 | 6.68×10 ⁻¹ | b | b | b | b | b | b |
| HLW Melter Interim Storage Facility | 2018 | 2139 | b | b | b | b | b | b | b |
| Contact-Handled Mixed Transuranic Waste Facilities | 2009 | 2010 | a | a | a | a | a | a | a |
| Remote-Handled Mixed Transuranic Waste Facility | 2015 | 2019 | a | a | a | a | b | a | a |
| Transuranic Waste Interim Storage Facility | 2009 | 2034 | b | b | b | b | b | b | b |
| Bulk Vitrification Facility | 2018 | 2033 | 8.69×10 ⁻³ | 1.46×10 ⁻⁶ | 1.68×10 ⁻¹⁰ | 7.15×10 ⁻⁹ | 8.39×10 ⁻³ | 2.63×10 ⁻⁵ | 7.48×10 ⁻⁵ |
| Solid-Liquid Separations Facility | 2018 | 2033 | 7.55×10 ⁻² | 1.62×10 ⁻⁴ | 2.07×10 ⁻⁶ | 8.45×10 ⁻⁵ | b | 4.80×10 ⁻¹ | 1.37×10 ⁻¹ |
| Cast Stone Facility | 2018 | 2033 | 3.18×10 ⁻² | 1.82×10 ⁻⁴ | 3.60×10 ⁻⁶ | 1.27×10 ⁻⁴ | b | 9.30×10 ⁻² | 2.70×10 ⁻² |
| Effluent Treatment Facility | 2006 | 2036 | 3.72×10 ⁻⁴ | 6.54×10 ⁻⁶ | 1.08×10 ⁻⁷ | 4.03×10 ⁻⁶ | b | 1.53×10 ⁻³ | 4.39×10 ⁻⁴ |
| Evaporator | 2006 | 2034 | 9.82×10 ⁻² | 1.24×10 ⁻⁴ | 5.22×10 ⁻⁶ | 1.57×10 ⁻⁴ | b | 5.79×10 ⁻³ | 4.04×10 ⁻³ |
| Borrow Area C | 2006 | 2052 | 3.08×10 ⁻¹ | 1.24×10 ⁻⁴ | 4.04×10 ⁻⁶ | 1.27×10 ⁻⁴ | b | 2.28×10 ⁻¹ | 7.18×10 ⁻² |
| Deactivation | | | | | | | | | |
| Sulfate Removal Facility | 2034 | 2035 | a | a | a | a | a | a | a |
| Modified sluicing retrieval system | 2013 | 2033 | b | b | b | b | b | b | b |
| Mobile retrieval system | 2013 | 2023 | a | a | a | a | b | a | a |
| Vacuum-based retrieval system | 2024 | 2033 | b | b | b | b | b | b | b |
| IHLW Interim Storage Facility | 2067 | 2067 | a | a | a | a | a | a | a |
| Waste Treatment Plant | 2035 | 2036 | a | a | a | a | a | a | a |
| Cesium and Strontium Capsule Processing Facility | 2035 | 2035 | a | a | a | a | a | a | a |
| Contact-Handled Mixed Transuranic Waste Facilities | 2011 | 2012 | a | a | a | a | a | a | a |
| Remote-Handled Mixed Transuranic Waste Facility | 2020 | 2021 | a | a | a | a | b | a | a |
| Transuranic Waste Interim Storage Facility | 2035 | 2035 | a | a | a | a | a | a | a |
| Bulk Vitrification Facility | 2034 | 2035 | a | a | a | a | a | a | a |
| Solid-Liquid Separations Facility | 2034 | 2035 | a | a | a | a | a | a | a |
| Cast Stone Facility | 2034 | 2035 | a | a | a | a | a | a | a |
| Effluent Treatment Facility original | 2026 | 2026 | a | a | a | a | b | a | a |
| Effluent Treatment Facility replacement 1 | 2037 | 2037 | a | a | a | a | a | a | a |
| Evaporator original | 2018 | 2018 | a | a | a | a | b | a | a |
| Evaporator replacement 1 | 2035 | 2035 | a | a | a | a | a | a | a |

Table G–128. Tank Closure Alternative 5 Maximum Toxic Pollutant Concentrations of Peak Activity Periods (continued)

| Facility/System | Start Year | End Year | Concentration (micrograms per cubic meter) | | | | | | |
|---|------------|----------|--|-----------------------|-----------------------|-----------------------|-----------------------|-----------|-----------------------|
| | | | Ammonia | Benzene | 1,3-Butadiene | Formaldehyde | Mercury | Toluene | Xylene |
| | | | 24-hour | Annual | Annual | Annual | 24-hour | 24-hour | 24-hour |
| | | | 2029–2032 | 2029–2032 | 2029–2032 | 2029–2032 | 2018–2033 | 2029–2032 | 2029–2032 |
| Closure | | | | | | | | | |
| Grout facility (tank-filling) construction | 2022 | 2023 | a | a | a | a | b | a | a |
| Grout facility (tank-filling) operations | 2024 | 2033 | 1.32×10^{-2} | b | b | b | b | b | b |
| Grout facility (tank-filling) deactivation | 2034 | 2034 | a | a | a | a | a | a | a |
| Ancillary equipment grouting | 2013 | 2033 | 3.07×10^{-5} | b | b | b | b | b | b |
| Hanford barrier construction | 2029 | 2039 | 2.87 | 4.24×10^{-3} | 1.23×10^{-4} | 3.97×10^{-3} | b | 3.28 | 9.94×10^{-1} |
| Decontamination and decommissioning of 10 selected facilities | 2012 | 2022 | a | a | a | a | b | a | a |
| Postclosure care | 2040 | 2139 | a | a | a | a | a | a | a |
| Total | | | 1.20×10^1 | 5.94×10^{-3} | 1.49×10^{-4} | 4.92×10^{-3} | 1.82×10^{-2} | 5.19 | 1.55 |

^a This activity would not contribute to the concentration during the peak year(s) for this pollutant and averaging period.

^b Emissions for this activity and pollutant were not calculated because they would be small compared with those for other activities under this alternative, as explained in Section G.2.

Key: HLW=high-level radioactive waste; IHLW=immobilized high-level radioactive waste.

Source: SAIC 2007a, 2008.

Table G-129. Tank Closure Alternative 6A, Base Case, Maximum Criteria Pollutant Concentrations of Peak Activity Periods

| Facility/System | Start Year | End Year | Concentration (micrograms per cubic meter) | | | | | | | | | |
|--|------------|----------|--|-----------------------|-----------------------|-----------------------|-----------------------|-----------------------|-----------------------|-----------------------|-----------------------|-----------|
| | | | Carbon Monoxide | | Nitrogen Dioxide | PM ₁₀ | | Sulfur Dioxide | | | | |
| | | | 1-hour | 8-hour | Annual | 24-hour | Annual | 1-hour | 3-hour | 24-hour | Annual | |
| | | | 2149-2150 | 2149-2150 | 2149-2150 | 2149-2150 | 2149-2150 | 2149-2150 | 2149-2150 | 2149-2150 | 2149-2150 | 2149-2150 |
| Construction | | | | | | | | | | | | |
| Canister Storage Building | 2006 | 2016 | a | a | a | a | a | a | a | a | a | a |
| IHLW Shipping/Transfer Facility | 2011 | 2013 | a | a | a | a | a | a | a | a | a | a |
| IHLW Interim Storage Modules | 2014 | 2157 | 4.20×10 ⁻² | 6.50×10 ¹ | 3.18×10 ⁻¹ | 1.12×10 ² | 1.05 | 1.53×10 ⁻¹ | 5.47×10 ⁻² | 1.03×10 ⁻² | 9.71×10 ⁻⁵ | |
| Other infrastructure upgrades | 2006 | 2034 | a | a | a | a | a | a | a | a | a | a |
| Tank upgrades | 2006 | 2025 | a | a | a | a | a | a | a | a | a | a |
| Waste Treatment Plant original | 2006 | 2017 | a | a | a | a | a | a | a | a | a | a |
| Cesium and Strontium Capsule Processing Facility | 2158 | 2161 | a | a | a | a | a | a | a | a | a | a |
| Tank risers | 2013 | 2016 | a | a | a | a | a | a | a | a | a | a |
| Double-shell tank replacement 1 | 2029 | 2034 | a | a | a | a | a | a | a | a | a | a |
| Double-shell tank replacement 2 | 2069 | 2074 | a | a | a | a | a | a | a | a | a | a |
| Double-shell tank replacement 3 | 2109 | 2114 | a | a | a | a | a | a | a | a | a | a |
| Mobile retrieval system | 2013 | 2162 | 4.44×10 ⁻² | 7.11×10 ¹ | 9.88×10 ⁻² | 2.57 | 1.90×10 ⁻² | 6.17×10 ⁻² | 2.10×10 ⁻² | 4.28×10 ⁻³ | 3.16×10 ⁻⁵ | |
| Vacuum-based retrieval system | 2013 | 2162 | 9.40×10 ¹ | 1.51×10 ¹ | 2.18×10 ⁻² | 5.92×10 ⁻¹ | 4.38×10 ⁻³ | 1.35×10 ⁻² | 4.60×10 ⁻³ | 9.39×10 ⁻⁴ | 6.94×10 ⁻⁶ | |
| Chemical wash system | 2013 | 2162 | 9.48×10 ⁻¹ | 1.52×10 ⁻¹ | 2.59×10 ⁻³ | 4.38×10 ⁻² | 3.24×10 ⁻⁴ | 1.58×10 ⁻³ | 5.37×10 ⁻⁴ | 1.10×10 ⁻⁴ | 8.11×10 ⁻⁷ | |
| HLW Melter Interim Storage Facility 1 | 2017 | 2018 | a | a | a | a | a | a | a | a | a | a |
| HLW Melter Interim Storage Facility 2 | 2037 | 2038 | a | a | a | a | a | a | a | a | a | a |
| HLW Melter Interim Storage Facility 3 | 2057 | 2058 | a | a | a | a | a | a | a | a | a | a |
| HLW Melter Interim Storage Facility 4 | 2077 | 2078 | a | a | a | a | a | a | a | a | a | a |
| HLW Melter Interim Storage Facility 5 | 2097 | 2098 | a | a | a | a | a | a | a | a | a | a |
| HLW Melter Interim Storage Facility 6 | 2117 | 2118 | a | a | a | a | a | a | a | a | a | a |
| HLW Melter Interim Storage Facility 7 | 2137 | 2138 | a | a | a | a | a | a | a | a | a | a |
| Underground transfer line replacement | 2064 | 2064 | a | a | a | a | a | a | a | a | a | a |
| Waste Treatment Plant replacement 1 | 2067 | 2078 | a | a | a | a | a | a | a | a | a | a |
| Waste Treatment Plant replacement 2 | 2127 | 2138 | a | a | a | a | a | a | a | a | a | a |
| IHLW Shipping/Transfer Facility 1 | 2076 | 2078 | a | a | a | a | a | a | a | a | a | a |
| IHLW Shipping/Transfer Facility 2 | 2136 | 2138 | a | a | a | a | a | a | a | a | a | a |
| IHLW Shipping/Transfer Facility 3 | 2196 | 2198 | a | a | a | a | a | a | a | a | a | a |
| IHLW Interim Storage Module, additional | 2078 | 2197 | 1.14×10 ³ | 1.77×10 ² | 8.65×10 ⁻¹ | 3.04×10 ² | 2.87 | 4.15×10 ⁻¹ | 1.49×10 ⁻¹ | 2.80×10 ⁻² | 2.64×10 ⁻⁴ | |
| HLW Debris Storage Facility | 2041 | 2110 | a | a | a | a | a | a | a | a | a | a |
| Effluent Treatment Facility replacement 1 | 2023 | 2025 | a | a | a | a | a | a | a | a | a | a |
| Effluent Treatment Facility replacement 2 | 2053 | 2055 | a | a | a | a | a | a | a | a | a | a |
| Effluent Treatment Facility replacement 3 | 2083 | 2085 | a | a | a | a | a | a | a | a | a | a |

Table G-129. Tank Closure Alternative 6A, Base Case, Maximum Criteria Pollutant Concentrations of Peak Activity Periods (continued)

| Facility/System | Start Year | End Year | Concentration (micrograms per cubic meter) | | | | | | | | |
|--|------------|----------|--|-----------------------|-----------------------|-----------------------|-----------------------|-----------------------|-----------------------|-----------------------|-----------------------|
| | | | Carbon Monoxide | | Nitrogen Dioxide | PM ₁₀ | | Sulfur Dioxide | | | |
| | | | 1-hour | 8-hour | Annual | 24-hour | Annual | 1-hour | 3-hour | 24-hour | Annual |
| | | | 2149-2150 | 2149-2150 | 2149-2150 | 2149-2150 | 2149-2150 | 2149-2150 | 2149-2150 | 2149-2150 | 2149-2150 |
| Construction (continued) | | | | | | | | | | | |
| Effluent Treatment Facility replacement 4 | 2113 | 2115 | a | a | a | a | a | a | a | a | a |
| Effluent Treatment Facility replacement 5 | 2143 | 2145 | a | a | a | a | a | a | a | a | a |
| Evaporator replacement 1 | 2015 | 2017 | a | a | a | a | a | a | a | a | a |
| Evaporator replacement 2 | 2040 | 2042 | a | a | a | a | a | a | a | a | a |
| Evaporator replacement 3 | 2065 | 2067 | a | a | a | a | a | a | a | a | a |
| Evaporator replacement 4 | 2090 | 2092 | a | a | a | a | a | a | a | a | a |
| Evaporator replacement 5 | 2115 | 2117 | a | a | a | a | a | a | a | a | a |
| Evaporator replacement 6 | 2140 | 2142 | a | a | a | a | a | a | a | a | a |
| Underground transfer line 1,000-foot sections | 2009 | 2009 | a | a | a | a | a | a | a | a | a |
| Operations | | | | | | | | | | | |
| IHLW Interim Storage Facility | 2018 | 2262 | b | b | b | b | b | b | b | b | b |
| Other infrastructure upgrades | 2006 | 2162 | b | b | b | b | b | b | b | b | b |
| Routine operations | 2006 | 2162 | 5.72×10 ¹ | 1.50×10 ¹ | 8.27×10 ⁻² | b | b | b | b | b | b |
| Retrieval operations | 2006 | 2162 | 7.66×10 ⁻¹ | 1.23×10 ⁻¹ | 4.45×10 ⁻⁴ | b | b | b | b | b | b |
| Double-shell tank interim stabilization | 2006 | 2162 | 5.02 | 8.05×10 ⁻¹ | 2.92×10 ⁻³ | b | b | b | b | b | b |
| Waste Treatment Plant | 2018 | 2162 | 3.03×10 ² | 9.32×10 ¹ | 2.85 | 2.39×10 ⁻¹ | 1.11×10 ⁻² | 1.19×10 ¹ | 7.32 | 1.22 | 5.70×10 ⁻² |
| Waste Treatment Plant, cesium and strontium capsules | 2163 | 2163 | a | a | a | a | a | a | a | a | a |
| Cesium and Strontium Capsule Processing Facility | 2162 | 2163 | a | a | a | a | a | a | a | a | a |
| Mobile retrieval system | 2013 | 2162 | 2.04 | 3.27×10 ⁻¹ | 1.18×10 ⁻³ | b | b | b | b | b | b |
| Vacuum-based retrieval system | 2013 | 2162 | 6.41×10 ⁻¹ | 1.03×10 ⁻¹ | 3.72×10 ⁻⁴ | b | b | b | b | b | b |
| Chemical wash system | 2013 | 2162 | 6.32×10 ⁻¹ | 1.01×10 ⁻¹ | 1.13×10 ⁻³ | 4.60×10 ⁻¹ | 3.40×10 ⁻³ | 6.28×10 ⁻⁴ | 2.14×10 ⁻⁴ | 4.36×10 ⁻⁵ | 3.22×10 ⁻⁷ |
| HLW Melter Interim Storage Facility | 2018 | 2262 | b | b | b | b | b | b | b | b | b |
| HLW Debris Storage Facility | 2042 | 2262 | b | b | b | b | b | b | b | b | b |
| Effluent Treatment Facility | 2006 | 2166 | 7.85 | 2.41 | 1.02×10 ⁻² | 7.66×10 ¹ | 3.57 | 1.06×10 ⁻² | 6.52×10 ⁻³ | 1.09×10 ⁻³ | 5.08×10 ⁻⁵ |
| Evaporator | 2018 | 2163 | 2.00×10 ² | 3.09×10 ¹ | 5.88×10 ⁻¹ | 1.87×10 ¹ | 1.76×10 ⁻¹ | 3.15×10 ⁻¹ | 1.13×10 ⁻¹ | 2.13×10 ⁻² | 2.00×10 ⁻⁴ |
| Borrow Area C | 2006 | 2167 | 6.91×10 ² | 2.83×10 ² | 4.42×10 ⁻¹ | 3.98×10 ² | 9.10×10 ⁻¹ | 9.72×10 ⁻¹ | 6.58×10 ⁻¹ | 2.07×10 ⁻¹ | 4.75×10 ⁻⁴ |
| Deactivation | | | | | | | | | | | |
| Mobile retrieval system | 2013 | 2162 | 2.22×10 ² | 3.55×10 ¹ | 8.90×10 ⁻³ | 1.00×10 ⁻¹ | 7.40×10 ⁻⁴ | 5.30×10 ⁻³ | 1.80×10 ⁻³ | 3.68×10 ⁻⁴ | 2.72×10 ⁻⁶ |
| Vacuum-based retrieval system | 2013 | 2162 | 2.05 | 3.28×10 ⁻¹ | 8.23×10 ⁻⁵ | 1.01×10 ⁻³ | 7.48×10 ⁻⁶ | 4.90×10 ⁻⁵ | 1.67×10 ⁻⁵ | 3.40×10 ⁻⁶ | 2.51×10 ⁻⁸ |
| Chemical wash system | 2013 | 2162 | 8.75 | 1.40 | 7.91×10 ⁻⁴ | 9.03×10 ⁻³ | 6.68×10 ⁻⁵ | 4.92×10 ⁻⁴ | 1.67×10 ⁻⁴ | 3.41×10 ⁻⁵ | 2.52×10 ⁻⁷ |
| IHLW Interim Storage Facility | 2078 | 2197 | b | b | b | b | b | b | b | b | b |

G-274

Table G-129. Tank Closure Alternative 6A, Base Case, Maximum Criteria Pollutant Concentrations of Peak Activity Periods (continued)

| Facility/System | Start Year | End Year | Concentration (micrograms per cubic meter) | | | | | | | | |
|---|------------|----------|--|-----------|------------------|------------------|-----------|----------------|-----------|-----------|-----------|
| | | | Carbon Monoxide | | Nitrogen Dioxide | PM ₁₀ | | Sulfur Dioxide | | | |
| | | | 1-hour | 8-hour | Annual | 24-hour | Annual | 1-hour | 3-hour | 24-hour | Annual |
| | | | 2149-2150 | 2149-2150 | 2149-2150 | 2149-2150 | 2149-2150 | 2149-2150 | 2149-2150 | 2149-2150 | 2149-2150 |
| Deactivation (continued) | | | | | | | | | | | |
| Waste Treatment Plant original | 2078 | 2080 | a | a | a | a | a | a | a | a | a |
| Waste Treatment Plant replacement 1 | 2138 | 2140 | a | a | a | a | a | a | a | a | a |
| Waste Treatment Plant replacement 2 | 2164 | 2166 | a | a | a | a | a | a | a | a | a |
| Cesium and Strontium Capsule Processing Facility | 2164 | 2164 | a | a | a | a | a | a | a | a | a |
| Effluent Treatment Facility original | 2026 | 2026 | a | a | a | a | a | a | a | a | a |
| Effluent Treatment Facility replacement 1 | 2056 | 2056 | a | a | a | a | a | a | a | a | a |
| Effluent Treatment Facility replacement 2 | 2086 | 2086 | a | a | a | a | a | a | a | a | a |
| Effluent Treatment Facility replacement 3 | 2116 | 2116 | a | a | a | a | a | a | a | a | a |
| Effluent Treatment Facility replacement 4 | 2146 | 2146 | a | a | a | a | a | a | a | a | a |
| Effluent Treatment Facility replacement 5 | 2167 | 2167 | a | a | a | a | a | a | a | a | a |
| Evaporator original | 2018 | 2018 | a | a | a | a | a | a | a | a | a |
| Evaporator replacement 1 | 2043 | 2043 | a | a | a | a | a | a | a | a | a |
| Evaporator replacement 2 | 2068 | 2068 | a | a | a | a | a | a | a | a | a |
| Evaporator replacement 3 | 2093 | 2093 | a | a | a | a | a | a | a | a | a |
| Evaporator replacement 4 | 2118 | 2118 | a | a | a | a | a | a | a | a | a |
| Evaporator replacement 5 | 2143 | 2143 | a | a | a | a | a | a | a | a | a |
| Evaporator replacement 6 | 2168 | 2168 | a | a | a | a | a | a | a | a | a |
| Closure | | | | | | | | | | | |
| Containment structure construction 1 | 2038 | 2041 | a | a | a | a | a | a | a | a | a |
| Containment structure construction 2 | 2061 | 2064 | a | a | a | a | a | a | a | a | a |
| Containment structure construction 3 | 2084 | 2087 | a | a | a | a | a | a | a | a | a |
| Containment structure construction 4 | 2107 | 2110 | a | a | a | a | a | a | a | a | a |
| Containment structure construction 5 | 2122 | 2125 | a | a | a | a | a | a | a | a | a |
| Containment structure construction 6 | 2138 | 2141 | a | a | a | a | a | a | a | a | a |
| Containment structure deactivation 1 | 2062 | 2064 | a | a | a | a | a | a | a | a | a |
| Containment structure deactivation 2 | 2085 | 2087 | a | a | a | a | a | a | a | a | a |
| Containment structure deactivation 3 | 2108 | 2110 | a | a | a | a | a | a | a | a | a |
| Containment structure deactivation 4 | 2123 | 2125 | a | a | a | a | a | a | a | a | a |
| Containment structure deactivation 5 | 2146 | 2148 | a | a | a | a | a | a | a | a | a |
| Containment structure deactivation 6 | 2138 | 2140 | a | a | a | a | a | a | a | a | a |
| Containment structure deactivation 7 | 2162 | 2164 | a | a | a | a | a | a | a | a | a |
| Decontamination and decommissioning of 10 selected facilities | 2018 | 2028 | a | a | a | a | a | a | a | a | a |

Table G-129. Tank Closure Alternative 6A, Base Case, Maximum Criteria Pollutant Concentrations of Peak Activity Periods (continued)

| Facility/System | Start Year | End Year | Concentration (micrograms per cubic meter) | | | | | | | | | |
|---|------------|----------|--|-----------------------|-----------------------|----------------------------|-----------------------|-----------------------|-----------------------|-----------------------|-----------------------|-----------|
| | | | Carbon Monoxide | | Nitrogen Dioxide | PM ₁₀ | | Sulfur Dioxide | | | | |
| | | | 1-hour | 8-hour | Annual | 24-hour | Annual | 1-hour | 3-hour | 24-hour | Annual | |
| | | | 2149-2150 | 2149-2150 | 2149-2150 | 2149-2150 | 2149-2150 | 2149-2150 | 2149-2150 | 2149-2150 | 2149-2150 | 2149-2150 |
| Closure (continued) | | | | | | | | | | | | |
| Modified Resource Conservation and Recovery Act Subtitle C barrier construction | 2149 | 2150 | 2.79×10 ⁴ | 4.47×10 ³ | 1.31×10 ¹ | 4.11×10 ³ | 3.04×10 ¹ | 3.87×10 ¹ | 1.31×10 ¹ | 2.68 | 1.98×10 ⁻² | |
| Postclosure care | 2151 | 2250 | a | a | a | a | a | a | a | a | a | |
| B tank farm removal | 2065 | 2076 | a | a | a | a | a | a | a | a | a | |
| T tank farm removal | 2126 | 2137 | a | a | a | a | a | a | a | a | a | |
| BY tank farm removal | 2111 | 2122 | a | a | a | a | a | a | a | a | a | |
| BX tank farm removal | 2042 | 2053 | a | a | a | a | a | a | a | a | a | |
| C tank farm removal | 2088 | 2099 | a | a | a | a | a | a | a | a | a | |
| A tank farm removal | 2142 | 2153 | 1.12×10 ² | 1.79×10 ¹ | 2.58×10 ⁻¹ | 4.53 | 3.35×10 ⁻² | 1.76×10 ⁻¹ | 5.98×10 ⁻² | 1.22×10 ⁻² | 9.01×10 ⁻⁵ | |
| AX tank farm removal | 2142 | 2153 | 2.98×10 ² | 4.78×10 ¹ | 6.89×10 ⁻¹ | 1.21×10 ¹ | 8.93×10 ⁻² | 4.69×10 ⁻¹ | 1.59×10 ⁻¹ | 3.25×10 ⁻² | 2.40×10 ⁻⁴ | |
| S tank farm removal | 2126 | 2137 | a | a | a | a | a | a | a | a | a | |
| TY tank farm removal | 2111 | 2122 | a | a | a | a | a | a | a | a | a | |
| TX tank farm removal | 2088 | 2099 | a | a | a | a | a | a | a | a | a | |
| U tank farm removal | 2065 | 2076 | a | a | a | a | a | a | a | a | a | |
| SX tank farm removal | 2042 | 2053 | a | a | a | a | a | a | a | a | a | |
| B tank farm deep soil removal | 2077 | 2084 | a | a | a | a | a | a | a | a | a | |
| T tank farm deep soil removal | 2138 | 2145 | a | a | a | a | a | a | a | a | a | |
| BX tank farm deep soil removal | 2054 | 2061 | a | a | a | a | a | a | a | a | a | |
| C tank farm deep soil removal | 2100 | 2107 | a | a | a | a | a | a | a | a | a | |
| A tank farm deep soil removal | 2154 | 2161 | a | a | a | a | a | a | a | a | a | |
| AX tank farm deep soil removal | 2154 | 2161 | a | a | a | a | a | a | a | a | a | |
| TX tank farm deep soil removal | 2100 | 2107 | a | a | a | a | a | a | a | a | a | |
| U tank farm deep soil removal | 2077 | 2084 | a | a | a | a | a | a | a | a | a | |
| SX tank farm deep soil removal | 2054 | 2061 | a | a | a | a | a | a | a | a | a | |
| Preprocessing Facility construction | 2039 | 2041 | a | a | a | a | a | a | a | a | a | |
| Preprocessing Facility operations | 2042 | 2162 | 9.76×10 ⁻¹ | 2.09×10 ⁻¹ | 5.87×10 ⁻⁴ | 2.79×10 ⁻³ | 5.22×10 ⁻⁵ | 9.95×10 ⁻² | 3.47×10 ⁻² | 8.66×10 ⁻³ | 1.62×10 ⁻⁴ | |
| Preprocessing Facility deactivation | 2163 | 2163 | a | a | a | a | a | a | a | a | a | |
| Total | | | 3.19×10 ⁴ | 5.33×10 ³ | 1.93×10 ¹ | 5.04×10³ | 3.91×10 ¹ | 5.33×10 ¹ | 2.17×10 ¹ | 4.23 | 7.85×10 ⁻² | |

^a This activity would not contribute to the concentration during the peak year(s) for this pollutant and averaging period.

^b Emissions for this activity and pollutant were not calculated because they would be small compared with those for other activities under this alternative, as explained in Section G.2.

Note: Total concentrations exceeding applicable standards are presented in **bold**.

Key: HLW=high-level radioactive waste; IHLW=immobilized high-level radioactive waste; PM₁₀=particulate matter with an aerodynamic diameter less than or equal to 10 micrometers.

Source: SAIC 2007a, 2008.

Table G-130. Tank Closure Alternative 6A, Base Case, Maximum Toxic Pollutant Concentrations of Peak Activity Periods

| Facility/System | Start Year | End Year | Concentration (micrograms per cubic meter) | | | | | | |
|--|------------|----------|--|---------------------|---------------------|---------------------|----------------------|----------------------|----------------------|
| | | | Ammonia | Benzene | 1,3-Butadiene | Formaldehyde | Mercury | Toluene | Xylene |
| | | | 24-hour 2149-2150 | Annual 2149-2150 | Annual 2149-2150 | Annual 2149-2150 | 24-hour 2078-2140 | 24-hour 2149-2150 | 24-hour 2149-2150 |
| Construction | | | | | | | | | |
| Canister Storage Building | 2006 | 2016 | a | a | a | a | a | a | a |
| IHLW Shipping/Transfer Facility | 2011 | 2013 | a | a | a | a | a | a | a |
| IHLW Interim Storage Modules | 2014 | 2157 | b | b | b | b | b | b | b |
| Other infrastructure upgrades | 2006 | 2034 | a | a | a | a | a | a | a |
| Tank upgrades | 2006 | 2025 | a | a | a | a | a | a | a |
| Waste Treatment Plant original | 2006 | 2017 | a | a | a | a | a | a | a |
| Cesium and Strontium Capsule Processing Facility | 2158 | 2161 | a | a | a | a | a | a | a |
| Tank risers | 2013 | 2016 | a | a | a | a | a | a | a |
| Double-shell tank replacement 1 | 2029 | 2034 | a | a | a | a | a | a | a |
| Double-shell tank replacement 2 | 2069 | 2074 | a | a | a | a | a | a | a |
| Double-shell tank replacement 3 | 2109 | 2114 | a | a | a | a | a | a | a |
| Mobile retrieval system | 2013 | 2162 | 1.23×10 ⁻¹ | b | b | b | b | b | b |
| Vacuum-based retrieval system | 2013 | 2162 | 3.85×10 ⁻² | b | b | b | b | b | b |
| Chemical wash system | 2013 | 2162 | 1.61×10 ⁻³ | b | b | b | b | b | b |
| HLW Melter Interim Storage Facility 1 | 2017 | 2018 | a | a | a | a | a | a | a |
| HLW Melter Interim Storage Facility 2 | 2037 | 2038 | a | a | a | a | a | a | a |
| HLW Melter Interim Storage Facility 3 | 2057 | 2058 | a | a | a | a | a | a | a |
| HLW Melter Interim Storage Facility 4 | 2077 | 2078 | a | a | a | a | b | a | a |
| HLW Melter Interim Storage Facility 5 | 2097 | 2098 | a | a | a | a | a | a | a |
| HLW Melter Interim Storage Facility 6 | 2117 | 2118 | a | a | a | a | a | a | a |
| HLW Melter Interim Storage Facility 7 | 2137 | 2138 | a | a | a | a | a | a | a |
| Underground transfer line replacement | 2064 | 2064 | a | a | a | a | a | a | a |
| Waste Treatment Plant replacement 1 | 2067 | 2078 | a | a | a | a | b | a | a |
| Waste Treatment Plant replacement 2 | 2127 | 2138 | a | a | a | a | a | a | a |
| IHLW Shipping/Transfer Facility 1 | 2076 | 2078 | a | a | a | a | b | a | a |
| IHLW Shipping/Transfer Facility 2 | 2136 | 2138 | a | a | a | a | a | a | a |
| IHLW Shipping/Transfer Facility 3 | 2196 | 2198 | a | a | a | a | a | a | a |
| IHLW Interim Storage Module, additional | 2078 | 2197 | b | b | b | b | b | b | b |
| HLW Debris Storage Facility | 2041 | 2110 | a | a | a | a | b | a | a |
| Effluent Treatment Facility replacement 1 | 2023 | 2025 | a | a | a | a | a | a | a |
| Effluent Treatment Facility replacement 2 | 2053 | 2055 | a | a | a | a | a | a | a |
| Effluent Treatment Facility replacement 3 | 2083 | 2085 | a | a | a | a | a | a | a |
| Effluent Treatment Facility replacement 4 | 2113 | 2115 | a | a | a | a | a | a | a |
| Effluent Treatment Facility replacement 5 | 2143 | 2145 | a | a | a | a | a | a | a |

Table G-130. Tank Closure Alternative 6A, Base Case, Maximum Toxic Pollutant Concentrations of Peak Activity Periods (continued)

| Facility/System | Start Year | End Year | Concentration (micrograms per cubic meter) | | | | | | | |
|--|------------|----------|--|-----------------------|-----------------------|-----------------------|-----------------------|-----------------------|-----------------------|---|
| | | | Ammonia | Benzene | 1,3-Butadiene | Formaldehyde | Mercury | Toluene | Xylene | |
| | | | 24-hour | Annual | Annual | Annual | 24-hour | 24-hour | 24-hour | |
| | | | 2149-2150 | 2149-2150 | 2149-2150 | 2149-2150 | 2078-2140 | 2149-2150 | 2149-2150 | |
| Construction (continued) | | | | | | | | | | |
| Evaporator replacement 1 | 2015 | 2017 | a | a | a | a | a | a | a | a |
| Evaporator replacement 2 | 2040 | 2042 | a | a | a | a | a | a | a | a |
| Evaporator replacement 3 | 2065 | 2067 | a | a | a | a | a | a | a | a |
| Evaporator replacement 4 | 2090 | 2092 | a | a | a | a | a | a | a | a |
| Evaporator replacement 5 | 2115 | 2117 | a | a | a | a | a | a | a | a |
| Evaporator replacement 6 | 2140 | 2142 | a | a | a | a | a | a | a | a |
| Underground transfer line 1,000-foot sections | 2009 | 2009 | a | a | a | a | a | a | a | a |
| Operations | | | | | | | | | | |
| IHLW Interim Storage Facility | 2018 | 2262 | b | b | b | b | b | b | b | b |
| Other infrastructure upgrades | 2006 | 2162 | b | b | b | b | b | b | b | b |
| Routine operations | 2006 | 2162 | 5.59 | b | b | b | b | b | b | b |
| Retrieval operations | 2006 | 2162 | 4.60×10 ⁻² | b | b | b | b | b | b | b |
| Double-shell tank interim stabilization | 2006 | 2162 | 3.02×10 ⁻¹ | b | b | b | b | b | b | b |
| Waste Treatment Plant | 2018 | 2162 | 4.70×10 ⁻¹ | 1.38×10 ⁻⁴ | 4.98×10 ⁻⁸ | 1.54×10 ⁻⁶ | 1.45×10 ⁻³ | 8.37×10 ⁻⁵ | 2.82×10 ⁻⁴ | |
| Waste Treatment Plant, cesium and strontium capsules | 2163 | 2163 | a | a | a | a | a | a | a | a |
| Cesium and Strontium Capsule Processing Facility | 2162 | 2163 | a | a | a | a | a | a | a | a |
| Mobile retrieval system | 2013 | 2162 | 1.23×10 ⁻¹ | b | b | b | b | b | b | b |
| Vacuum-based retrieval system | 2013 | 2162 | 3.85×10 ⁻² | b | b | b | b | b | b | b |
| Chemical wash system | 2013 | 2162 | 1.61×10 ⁻³ | b | b | b | b | b | b | b |
| HLW Melter Interim Storage Facility | 2018 | 2262 | b | b | b | b | b | b | b | b |
| HLW Debris Storage Facility | 2042 | 2262 | b | b | b | b | b | b | b | b |
| Effluent Treatment Facility | 2006 | 2166 | 3.72×10 ⁻⁴ | 6.54×10 ⁻⁶ | 1.08×10 ⁻⁷ | 4.03×10 ⁻⁶ | b | 1.53×10 ⁻³ | 4.39×10 ⁻⁴ | |
| Evaporator | 2018 | 2163 | 9.82×10 ⁻² | 1.24×10 ⁻⁴ | 5.22×10 ⁻⁶ | 1.57×10 ⁻⁴ | b | 5.79×10 ⁻³ | 4.04×10 ⁻³ | |
| Borrow Area C | 2006 | 2167 | 3.08×10 ⁻¹ | 1.24×10 ⁻⁴ | 4.04×10 ⁻⁶ | 1.27×10 ⁻⁴ | b | 2.28×10 ⁻¹ | 7.18×10 ⁻² | |
| Deactivation | | | | | | | | | | |
| Mobile retrieval system | 2013 | 2162 | b | b | b | b | b | b | b | b |
| Vacuum-based retrieval system | 2013 | 2162 | b | b | b | b | b | b | b | b |
| Chemical wash system | 2013 | 2162 | b | b | b | b | b | b | b | b |
| IHLW Interim Storage Facility | 2078 | 2197 | b | b | b | b | b | b | b | b |
| Waste Treatment Plant original | 2078 | 2080 | a | a | a | a | 9.11×10 ⁻⁴ | a | a | a |
| Waste Treatment Plant replacement 1 | 2138 | 2140 | a | a | a | a | a | a | a | a |
| Waste Treatment Plant replacement 2 | 2164 | 2166 | a | a | a | a | a | a | a | a |
| Cesium and Strontium Capsule Processing Facility | 2164 | 2164 | a | a | a | a | a | a | a | a |
| Effluent Treatment Facility original | 2026 | 2026 | a | a | a | a | a | a | a | a |

Table G–130. Tank Closure Alternative 6A, Base Case, Maximum Toxic Pollutant Concentrations of Peak Activity Periods (continued)

| Facility/System | Start Year | End Year | Concentration (micrograms per cubic meter) | | | | | | |
|---|------------|----------|--|-----------------------|-----------------------|-----------------------|----------------------|----------------------|-----------------------|
| | | | Ammonia | Benzene | 1,3-Butadiene | Formaldehyde | Mercury | Toluene | Xylene |
| | | | 24-hour 2149–2150 | Annual 2149–2150 | Annual 2149–2150 | Annual 2149–2150 | 24-hour 2078–2140 | 24-hour 2149–2150 | 24-hour 2149–2150 |
| Deactivation (continued) | | | | | | | | | |
| Effluent Treatment Facility replacement 1 | 2056 | 2056 | a | a | a | a | a | a | a |
| Effluent Treatment Facility replacement 2 | 2086 | 2086 | a | a | a | a | a | a | a |
| Effluent Treatment Facility replacement 3 | 2116 | 2116 | a | a | a | a | a | a | a |
| Effluent Treatment Facility replacement 4 | 2146 | 2146 | a | a | a | a | a | a | a |
| Effluent Treatment Facility replacement 5 | 2167 | 2167 | a | a | a | a | a | a | a |
| Evaporator original | 2018 | 2018 | a | a | a | a | a | a | a |
| Evaporator replacement 1 | 2043 | 2043 | a | a | a | a | a | a | a |
| Evaporator replacement 2 | 2068 | 2068 | a | a | a | a | a | a | a |
| Evaporator replacement 3 | 2093 | 2093 | a | a | a | a | a | a | a |
| Evaporator replacement 4 | 2118 | 2118 | a | a | a | a | a | a | a |
| Evaporator replacement 5 | 2143 | 2143 | a | a | a | a | a | a | a |
| Evaporator replacement 6 | 2168 | 2168 | a | a | a | a | a | a | a |
| Closure | | | | | | | | | |
| Containment structure construction 1 | 2038 | 2041 | a | a | a | a | a | a | a |
| Containment structure construction 2 | 2061 | 2064 | a | a | a | a | a | a | a |
| Containment structure construction 3 | 2084 | 2087 | a | a | a | a | a | a | a |
| Containment structure construction 4 | 2107 | 2110 | a | a | a | a | a | a | a |
| Containment structure construction 5 | 2122 | 2125 | a | a | a | a | a | a | a |
| Containment structure construction 6 | 2138 | 2141 | a | a | a | a | a | a | a |
| Containment structure deactivation 1 | 2062 | 2064 | a | a | a | a | a | a | a |
| Containment structure deactivation 2 | 2085 | 2087 | a | a | a | a | a | a | a |
| Containment structure deactivation 3 | 2108 | 2110 | a | a | a | a | a | a | a |
| Containment structure deactivation 4 | 2123 | 2125 | a | a | a | a | a | a | a |
| Containment structure deactivation 5 | 2146 | 2148 | a | a | a | a | a | a | a |
| Containment structure deactivation 6 | 2138 | 2140 | a | a | a | a | a | a | a |
| Containment structure deactivation 7 | 2162 | 2164 | a | a | a | a | a | a | a |
| Decontamination and decommissioning of 10 selected facilities | 2018 | 2028 | a | a | a | a | a | a | a |
| Modified Resource Conservation and Recovery Act Subtitle C barrier construction | 2149 | 2150 | 2.84 | 4.20×10 ⁻³ | 1.22×10 ⁻⁴ | 3.93×10 ⁻³ | a | 3.25 | 9.84×10 ⁻¹ |
| Postclosure care | 2151 | 2250 | a | a | a | a | a | a | a |
| B tank farm removal | 2065 | 2076 | a | a | a | a | a | a | a |
| T tank farm removal | 2126 | 2137 | a | a | a | a | a | a | a |
| BY tank farm removal | 2111 | 2122 | a | a | a | a | a | a | a |

Table G–130. Tank Closure Alternative 6A, Base Case, Maximum Toxic Pollutant Concentrations of Peak Activity Periods (continued)

| Facility/System | Start Year | End Year | Concentration (micrograms per cubic meter) | | | | | | |
|-------------------------------------|------------|----------|--|-----------------------|------------------------|------------------------|-----------------------|-----------------------|-----------------------|
| | | | Ammonia | Benzene | 1,3-Butadiene | Formaldehyde | Mercury | Toluene | Xylene |
| | | | 24-hour | Annual | Annual | Annual | 24-hour | 24-hour | 24-hour |
| | | | 2149–2150 | 2149–2150 | 2149–2150 | 2149–2150 | 2078–2140 | 2149–2150 | 2149–2150 |
| Closure (continued) | | | | | | | | | |
| BX tank farm removal | 2042 | 2053 | a | a | a | a | a | a | a |
| C tank farm removal | 2088 | 2099 | a | a | a | a | a | a | a |
| A tank farm removal | 2142 | 2153 | 5.49×10 ⁻² | 5.48×10 ⁻⁵ | 2.29×10 ⁻⁶ | 6.92×10 ⁻⁵ | a | 3.70×10 ⁻³ | 2.39×10 ⁻³ |
| AX tank farm removal | 2142 | 2153 | 1.46×10 ⁻¹ | 1.46×10 ⁻⁴ | 6.11×10 ⁻⁶ | 1.84×10 ⁻⁴ | a | 9.87×10 ⁻³ | 6.37×10 ⁻³ |
| S tank farm removal | 2126 | 2137 | a | a | a | a | a | a | a |
| TY tank farm removal | 2111 | 2122 | a | a | a | a | a | a | a |
| TX tank farm removal | 2088 | 2099 | a | a | a | a | a | a | a |
| U tank farm removal | 2065 | 2076 | a | a | a | a | a | a | a |
| SX tank farm removal | 2042 | 2053 | a | a | a | a | a | a | a |
| B tank farm deep soil removal | 2077 | 2084 | a | a | a | a | b | a | a |
| T tank farm deep soil removal | 2138 | 2145 | a | a | a | a | a | a | a |
| BX tank farm deep soil removal | 2054 | 2061 | a | a | a | a | a | a | a |
| C tank farm deep soil removal | 2100 | 2107 | a | a | a | a | a | a | a |
| A tank farm deep soil removal | 2154 | 2161 | a | a | a | a | a | a | a |
| AX tank farm deep soil removal | 2154 | 2161 | a | a | a | a | a | a | a |
| TX tank farm deep soil removal | 2100 | 2107 | a | a | a | a | a | a | a |
| U tank farm deep soil removal | 2077 | 2084 | a | a | a | a | b | a | a |
| SX tank farm deep soil removal | 2054 | 2061 | a | a | a | a | a | a | a |
| Preprocessing Facility construction | 2039 | 2041 | a | a | a | a | a | a | a |
| Preprocessing Facility operations | 2042 | 2162 | 3.84×10 ⁻⁵ | 4.10×10 ⁻⁸ | 2.52×10 ⁻¹² | 1.44×10 ⁻¹⁰ | 4.06×10 ⁻⁶ | 3.32×10 ⁻⁷ | 9.39×10 ⁻⁷ |
| Preprocessing Facility deactivation | 2163 | 2163 | a | a | a | a | a | a | a |
| Total | | | 1.02×10 ¹ | 4.79×10 ⁻³ | 1.40×10 ⁻⁴ | 4.47×10 ⁻³ | 2.37×10 ⁻³ | 3.50 | 1.07 |

^a This activity would not contribute to the concentration during the peak year(s) for this pollutant and averaging period.

^b Emissions for this activity and pollutant were not calculated because they would be small compared with those for other activities under this alternative, as explained in Section G.2.

Note: Total concentrations exceeding applicable standards are presented in **bold**.

Key: HLW=high-level radioactive waste; IHLW=immobilized high-level radioactive waste.

Source: SAIC 2007a, 2008.

Table G-131. Tank Closure Alternative 6A, Option Case, Maximum Criteria Pollutant Concentrations of Peak Activity Periods

| Facility/System | Start Year | End Year | Concentration (micrograms per cubic meter) | | | | | | | | |
|--|------------|----------|--|-----------------------|-----------------------|-----------------------|-----------------------|-----------------------|-----------------------|-----------------------|-----------------------|
| | | | Carbon Monoxide | | Nitrogen Dioxide | PM ₁₀ | | Sulfur Dioxide | | | |
| | | | 1-hour | 8-hour | Annual | 24-hour | Annual | 1-hour | 3-hour | 24-hour | Annual |
| | | | 2113-2114 | 2113-2114 | 2069-2074 | 2113-2114 | 2113-2114 | 2158-2161 | 2158-2161 | 2115 | 2158-2161 |
| Construction | | | | | | | | | | | |
| Canister Storage Building | 2006 | 2016 | a | a | a | a | a | a | a | a | a |
| IHLW Shipping/Transfer Facility | 2011 | 2013 | a | a | a | a | a | a | a | a | a |
| IHLW Interim Storage Modules | 2014 | 2157 | 4.20×10 ² | 6.50×10 ¹ | 3.18×10 ⁻¹ | 1.12×10 ² | 1.05 | a | a | 1.03×10 ⁻² | a |
| Other infrastructure upgrades | 2006 | 2034 | a | a | a | a | a | a | a | a | a |
| Tank upgrades | 2006 | 2025 | a | a | a | a | a | a | a | a | a |
| Waste Treatment Plant original | 2006 | 2017 | a | a | a | a | a | a | a | a | a |
| Cesium and Strontium Capsule Processing Facility | 2158 | 2161 | a | a | a | a | a | 2.55×10 ¹ | 8.50 | a | 1.42×10 ⁻² |
| Tank risers | 2013 | 2016 | a | a | a | a | a | a | a | a | a |
| Double-shell tank replacement 1 | 2029 | 2034 | a | a | a | a | a | a | a | a | a |
| Double-shell tank replacement 2 | 2069 | 2074 | a | a | 4.03 | a | a | a | a | a | a |
| Double-shell tank replacement 3 | 2109 | 2114 | 6.45×10 ³ | 1.08×10 ³ | a | 2.19×10 ³ | 2.51×10 ¹ | a | a | a | a |
| Mobile retrieval system | 2013 | 2162 | 4.44×10 ² | 7.11×10 ¹ | 9.88×10 ⁻² | 2.57 | 1.90×10 ⁻² | 6.17×10 ⁻² | 2.10×10 ⁻² | 4.28×10 ⁻³ | 3.16×10 ⁻⁵ |
| Vacuum-based retrieval system | 2013 | 2162 | 9.40×10 ¹ | 1.51×10 ¹ | 2.18×10 ⁻² | 5.92×10 ⁻¹ | 4.38×10 ⁻³ | 1.35×10 ⁻² | 4.60×10 ⁻³ | 9.39×10 ⁻⁴ | 6.94×10 ⁻⁶ |
| Chemical wash system | 2013 | 2162 | 9.48×10 ⁻¹ | 1.52×10 ⁻¹ | 2.59×10 ⁻³ | 4.38×10 ⁻² | 3.24×10 ⁻⁴ | 1.58×10 ⁻³ | 5.37×10 ⁻⁴ | 1.10×10 ⁻⁴ | 8.11×10 ⁻⁷ |
| HLW Melter Interim Storage Facility 1 | 2017 | 2018 | a | a | a | a | a | a | a | a | a |
| HLW Melter Interim Storage Facility 2 | 2037 | 2038 | a | a | a | a | a | a | a | a | a |
| HLW Melter Interim Storage Facility 3 | 2057 | 2058 | a | a | a | a | a | a | a | a | a |
| HLW Melter Interim Storage Facility 4 | 2077 | 2078 | a | a | a | a | a | a | a | a | a |
| HLW Melter Interim Storage Facility 5 | 2097 | 2098 | a | a | a | a | a | a | a | a | a |
| HLW Melter Interim Storage Facility 6 | 2117 | 2118 | a | a | a | a | a | a | a | a | a |
| HLW Melter Interim Storage Facility 7 | 2137 | 2138 | a | a | a | a | a | a | a | a | a |
| Underground transfer line replacement | 2064 | 2064 | a | a | a | a | a | a | a | a | a |
| Waste Treatment Plant replacement 1 | 2067 | 2078 | a | a | 2.97 | a | a | a | a | a | a |
| Waste Treatment Plant replacement 2 | 2127 | 2138 | a | a | a | a | a | a | a | a | a |
| IHLW Shipping/Transfer Facility 1 | 2076 | 2078 | a | a | a | a | a | a | a | a | a |
| IHLW Shipping/Transfer Facility 2 | 2136 | 2138 | a | a | a | a | a | a | a | a | a |

Table G-131. Tank Closure Alternative 6A, Option Case, Maximum Criteria Pollutant Concentrations of Peak Activity Periods (continued)

| Facility/System | Start Year | End Year | Concentration (micrograms per cubic meter) | | | | | | | | |
|--|------------|----------|--|-----------------------|-----------------------|-----------------------|-----------------------|-----------------------|-----------------------|-----------------------|-----------------------|
| | | | Carbon Monoxide | | Nitrogen Dioxide | PM ₁₀ | | Sulfur Dioxide | | | |
| | | | 1-hour | 8-hour | Annual | 24-hour | Annual | 1-hour | 3-hour | 24-hour | Annual |
| | | | 2113-2114 | 2113-2114 | 2069-2074 | 2113-2114 | 2113-2114 | 2158-2161 | 2158-2161 | 2115 | 2158-2161 |
| Construction (continued) | | | | | | | | | | | |
| IHLW Shipping/Transfer Facility 3 | 2196 | 2198 | a | a | a | a | a | a | a | a | a |
| IHLW Interim Storage Modules, additional | 2078 | 2197 | 1.14×10 ³ | 1.77×10 ² | a | 3.04×10 ² | 2.87 | 4.15×10 ⁻¹ | 1.49×10 ⁻¹ | 2.80×10 ⁻² | 2.64×10 ⁻⁴ |
| HLW Debris Storage Facility | 2041 | 2110 | a | a | 1.30×10 ⁻² | a | a | a | a | a | a |
| Effluent Treatment Facility replacement 1 | 2023 | 2025 | a | a | a | a | a | a | a | a | a |
| Effluent Treatment Facility replacement 2 | 2053 | 2055 | a | a | a | a | a | a | a | a | a |
| Effluent Treatment Facility replacement 3 | 2083 | 2085 | a | a | a | a | a | a | a | a | a |
| Effluent Treatment Facility replacement 4 | 2113 | 2115 | 1.15×10 ⁴ | 1.77×10 ³ | a | 5.05×10 ² | 4.75 | a | a | 1.04 | a |
| Effluent Treatment Facility replacement 5 | 2143 | 2145 | a | a | a | a | a | a | a | a | a |
| Evaporator replacement 1 | 2015 | 2017 | a | a | a | a | a | a | a | a | a |
| Evaporator replacement 2 | 2040 | 2042 | a | a | a | a | a | a | a | a | a |
| Evaporator replacement 3 | 2065 | 2067 | a | a | a | a | a | a | a | a | a |
| Evaporator replacement 4 | 2090 | 2092 | a | a | a | a | a | a | a | a | a |
| Evaporator replacement 5 | 2115 | 2117 | a | a | a | a | a | a | a | 3.23×10 ⁻¹ | a |
| Evaporator replacement 6 | 2140 | 2142 | a | a | a | a | a | a | a | a | a |
| Underground transfer line 1,000-foot sections | 2009 | 2009 | a | a | a | a | a | a | a | a | a |
| Operations | | | | | | | | | | | |
| IHLW Interim Storage Facility | 2018 | 2262 | b | b | b | b | b | b | b | b | b |
| Other infrastructure upgrades | 2006 | 2162 | b | b | b | b | b | b | b | b | b |
| Routine operations | 2006 | 2162 | 5.72×10 ⁻¹ | 1.50×10 ⁻¹ | 8.27×10 ⁻² | b | b | b | b | b | b |
| Retrieval operations | 2006 | 2162 | 7.66×10 ⁻¹ | 1.23×10 ⁻¹ | 4.45×10 ⁻⁴ | b | b | b | b | b | b |
| Double-shell tank interim stabilization | 2006 | 2162 | 5.02 | 8.05×10 ⁻¹ | 2.92×10 ⁻³ | b | b | b | b | b | b |
| Waste Treatment Plant | 2018 | 2162 | 3.03×10 ² | 9.32×10 ¹ | 2.85 | 2.39×10 ⁻¹ | 1.11×10 ⁻² | 1.19×10 ¹ | 7.32 | 1.22 | 5.70×10 ⁻² |
| Waste Treatment Plant, cesium and strontium capsules | 2163 | 2163 | a | a | a | a | a | a | a | a | a |
| Cesium and Strontium Capsule Processing Facility | 2162 | 2163 | a | a | a | a | a | a | a | a | a |
| Mobile retrieval system | 2013 | 2162 | 2.04 | 3.27×10 ⁻¹ | 1.18×10 ⁻³ | b | b | b | b | b | b |
| Vacuum-based retrieval system | 2013 | 2162 | 6.41×10 ⁻¹ | 1.03×10 ⁻¹ | 3.72×10 ⁻⁴ | b | b | b | b | b | b |
| Chemical wash system | 2013 | 2162 | 6.32×10 ⁻¹ | 1.01×10 ⁻¹ | 1.13×10 ⁻³ | 4.60×10 ⁻¹ | 3.40×10 ⁻³ | 6.28×10 ⁻⁴ | 2.14×10 ⁻⁴ | 4.36×10 ⁻⁵ | 3.22×10 ⁻⁷ |
| HLW Melter Interim Storage Facility | 2018 | 2262 | b | b | b | b | b | b | b | b | b |
| HLW Debris Storage Facility | 2042 | 2262 | b | b | b | b | b | b | b | b | b |
| Effluent Treatment Facility | 2006 | 2166 | 7.85 | 2.41 | 1.02×10 ⁻² | 7.66×10 ¹ | 3.57 | 1.06×10 ⁻² | 6.52×10 ⁻³ | 1.09×10 ⁻³ | 5.08×10 ⁻⁵ |
| Evaporator | 2018 | 2163 | 2.00×10 ² | 3.09×10 ¹ | 5.88×10 ⁻¹ | 1.87×10 ¹ | 1.76×10 ⁻¹ | 3.15×10 ⁻¹ | 1.13×10 ⁻¹ | 2.13×10 ⁻² | 2.00×10 ⁻⁴ |

Table G-131. Tank Closure Alternative 6A, Option Case, Maximum Criteria Pollutant Concentrations of Peak Activity Periods (continued)

| Facility/System | Start Year | End Year | Concentration (micrograms per cubic meter) | | | | | | | | |
|--|------------|----------|--|-----------------------|-----------------------|-----------------------|-----------------------|-----------------------|-----------------------|-----------------------|-----------------------|
| | | | Carbon Monoxide | | Nitrogen Dioxide | PM ₁₀ | | Sulfur Dioxide | | | |
| | | | 1-hour | 8-hour | Annual | 24-hour | Annual | 1-hour | 3-hour | 24-hour | Annual |
| | | | 2113-2114 | 2113-2114 | 2069-2074 | 2113-2114 | 2113-2114 | 2158-2161 | 2158-2161 | 2115 | 2158-2161 |
| Operations (continued) | | | | | | | | | | | |
| Borrow Area C | 2006 | 2167 | 6.91×10 ² | 2.83×10 ² | 4.42×10 ⁻¹ | 3.98×10 ² | 9.10×10 ⁻¹ | 9.72×10 ⁻¹ | 6.58×10 ⁻¹ | 2.07×10 ⁻¹ | 4.75×10 ⁻⁴ |
| Deactivation | | | | | | | | | | | |
| Mobile retrieval system | 2013 | 2162 | 2.22×10 ² | 3.55×10 ¹ | 8.90×10 ⁻³ | 1.00×10 ⁻¹ | 7.40×10 ⁻⁴ | 5.30×10 ⁻³ | 1.80×10 ⁻³ | 3.68×10 ⁻⁴ | 2.72×10 ⁻⁶ |
| Vacuum-based retrieval system | 2013 | 2162 | 2.05 | 3.28×10 ⁻¹ | 8.23×10 ⁻⁵ | 1.01×10 ⁻³ | 7.48×10 ⁻⁶ | 4.90×10 ⁻⁵ | 1.67×10 ⁻⁵ | 3.40×10 ⁻⁶ | 2.51×10 ⁻⁸ |
| Chemical wash system | 2013 | 2162 | 8.75 | 1.40 | 7.91×10 ⁻⁴ | 9.03×10 ⁻³ | 6.68×10 ⁻⁵ | 4.92×10 ⁻⁴ | 1.67×10 ⁻⁴ | 3.41×10 ⁻⁵ | 2.52×10 ⁻⁷ |
| IHLW Interim Storage Facility | 2078 | 2197 | b | b | a | b | b | b | b | b | b |
| Waste Treatment Plant original | 2079 | 2081 | a | a | a | a | a | a | a | a | a |
| Waste Treatment Plant replacement 1 | 2139 | 2141 | a | a | a | a | a | a | a | a | a |
| Waste Treatment Plant replacement 2 | 2164 | 2166 | a | a | a | a | a | a | a | a | a |
| Cesium and Strontium Capsule Processing Facility | 2164 | 2164 | a | a | a | a | a | a | a | a | a |
| Effluent Treatment Facility original | 2026 | 2026 | a | a | a | a | a | a | a | a | a |
| Effluent Treatment Facility replacement 1 | 2056 | 2056 | a | a | a | a | a | a | a | a | a |
| Effluent Treatment Facility replacement 2 | 2086 | 2086 | a | a | a | a | a | a | a | a | a |
| Effluent Treatment Facility replacement 3 | 2116 | 2116 | a | a | a | a | a | a | a | a | a |
| Effluent Treatment Facility replacement 4 | 2146 | 2146 | a | a | a | a | a | a | a | a | a |
| Effluent Treatment Facility replacement 5 | 2167 | 2167 | a | a | a | a | a | a | a | a | a |
| Evaporator original | 2018 | 2018 | a | a | a | a | a | a | a | a | a |
| Evaporator replacement 1 | 2043 | 2043 | a | a | a | a | a | a | a | a | a |
| Evaporator replacement 2 | 2068 | 2068 | a | a | a | a | a | a | a | a | a |
| Evaporator replacement 3 | 2093 | 2093 | a | a | a | a | a | a | a | a | a |
| Evaporator replacement 4 | 2118 | 2118 | a | a | a | a | a | a | a | a | a |
| Evaporator replacement 5 | 2143 | 2143 | a | a | a | a | a | a | a | a | a |
| Evaporator replacement 6 | 2168 | 2168 | a | a | a | a | a | a | a | a | a |
| Closure | | | | | | | | | | | |
| Containment structure construction 1 | 2038 | 2041 | a | a | a | a | a | a | a | a | a |
| Containment structure construction 2 | 2061 | 2064 | a | a | a | a | a | a | a | a | a |
| Containment structure construction 3 | 2084 | 2087 | a | a | a | a | a | a | a | a | a |

Table G-131. Tank Closure Alternative 6A, Option Case, Maximum Criteria Pollutant Concentrations of Peak Activity Periods (continued)

| Facility/System | Start Year | End Year | Concentration (micrograms per cubic meter) | | | | | | | | | |
|---|------------|----------|--|----------------------|-----------------------|------------------|-----------------------|----------------|-----------|-----------------------|-----------|---|
| | | | Carbon Monoxide | | Nitrogen Dioxide | PM ₁₀ | | Sulfur Dioxide | | | | |
| | | | 1-hour | 8-hour | Annual | 24-hour | Annual | 1-hour | 3-hour | 24-hour | Annual | |
| | | | 2113-2114 | 2113-2114 | 2069-2074 | 2113-2114 | 2113-2114 | 2158-2161 | 2158-2161 | 2115 | 2158-2161 | |
| Closure (continued) | | | | | | | | | | | | |
| Containment structure construction 4 | 2107 | 2110 | a | a | a | a | a | a | a | a | a | a |
| Containment structure construction 5 | 2122 | 2125 | a | a | a | a | a | a | a | a | a | a |
| Containment structure construction 6 | 2138 | 2141 | a | a | a | a | a | a | a | a | a | a |
| Containment structure deactivation 1 | 2062 | 2064 | a | a | a | a | a | a | a | a | a | a |
| Containment structure deactivation 2 | 2085 | 2087 | a | a | a | a | a | a | a | a | a | a |
| Containment structure deactivation 3 | 2108 | 2110 | a | a | a | a | a | a | a | a | a | a |
| Containment structure deactivation 4 | 2123 | 2125 | a | a | a | a | a | a | a | a | a | a |
| Containment structure deactivation 5 | 2146 | 2148 | a | a | a | a | a | a | a | a | a | a |
| Containment structure deactivation 6 | 2138 | 2140 | a | a | a | a | a | a | a | a | a | a |
| Containment structure deactivation 7 | 2162 | 2164 | a | a | a | a | a | a | a | a | a | a |
| Decontamination and decommissioning of 10 selected facilities | 2018 | 2028 | a | a | a | a | a | a | a | a | a | a |
| B tank farm removal | 2065 | 2076 | a | a | 6.89×10 ⁻¹ | a | a | a | a | a | a | a |
| T tank farm removal | 2126 | 2137 | a | a | a | a | a | a | a | a | a | a |
| BY tank farm removal | 2111 | 2122 | 2.24×10 ² | 3.59×10 ¹ | a | 9.06 | 6.70×10 ⁻² | a | a | 2.44×10 ⁻² | a | a |
| BX tank farm removal | 2042 | 2053 | a | a | a | a | a | a | a | a | a | a |
| C tank farm removal | 2088 | 2099 | a | a | a | a | a | a | a | a | a | a |
| A tank farm removal | 2142 | 2153 | a | a | a | a | a | a | a | a | a | a |
| AX tank farm removal | 2142 | 2153 | a | a | a | a | a | a | a | a | a | a |
| S tank farm removal | 2126 | 2137 | a | a | a | a | a | a | a | a | a | a |
| TY tank farm removal | 2111 | 2122 | 1.12×10 ² | 1.79×10 ¹ | a | 4.53 | 3.35×10 ⁻² | a | a | 1.22×10 ⁻² | a | a |
| TX tank farm removal | 2088 | 2099 | a | a | a | a | a | a | a | a | a | a |
| U tank farm removal | 2065 | 2076 | a | a | 6.89×10 ⁻¹ | a | a | a | a | a | a | a |
| SX tank farm removal | 2042 | 2053 | a | a | a | a | a | a | a | a | a | a |
| B tank farm deep soil removal | 2077 | 2084 | a | a | a | a | a | a | a | a | a | a |
| T tank farm deep soil removal | 2138 | 2145 | a | a | a | a | a | a | a | a | a | a |
| BX tank farm deep soil removal | 2054 | 2061 | a | a | a | a | a | a | a | a | a | a |
| C tank farm deep soil removal | 2100 | 2107 | a | a | a | a | a | a | a | a | a | a |

Table G-131. Tank Closure Alternative 6A, Option Case, Maximum Criteria Pollutant Concentrations of Peak Activity Periods (continued)

| Facility/System | Start Year | End Year | Concentration (micrograms per cubic meter) | | | | | | | | |
|--|------------|----------|--|-----------------------|-----------------------|----------------------------|-----------------------|-----------------------|-----------------------|-----------------------|-----------------------|
| | | | Carbon Monoxide | | Nitrogen Dioxide | PM ₁₀ | | Sulfur Dioxide | | | |
| | | | 1-hour | 8-hour | Annual | 24-hour | Annual | 1-hour | 3-hour | 24-hour | Annual |
| | | | 2113-2114 | 2113-2114 | 2069-2074 | 2113-2114 | 2113-2114 | 2158-2161 | 2158-2161 | 2115 | 2158-2161 |
| Closure (continued) | | | | | | | | | | | |
| A tank farm deep soil removal | 2154 | 2161 | a | a | a | a | a | 8.70×10 ⁻³ | 3.11×10 ⁻³ | a | 5.53×10 ⁻⁶ |
| AX tank farm deep soil removal | 2154 | 2161 | a | a | a | a | a | 1.45×10 ⁻¹ | 5.19×10 ⁻² | a | 9.21×10 ⁻⁵ |
| TX tank farm deep soil removal | 2100 | 2107 | a | a | a | a | a | a | a | a | a |
| U tank farm deep soil removal | 2077 | 2084 | a | a | a | a | a | a | a | a | a |
| SX tank farm deep soil removal | 2054 | 2061 | a | a | a | a | a | a | a | a | a |
| B Area cribs and trenches (ditches) removal | 2054 | 2084 | a | a | 2.09 | a | a | a | a | a | a |
| T Area cribs and trenches (ditches) removal | 2100 | 2145 | 5.92×10 ² | 9.49×10 ¹ | a | 2.02×10 ¹ | 1.49×10 ⁻¹ | a | a | 6.48×10 ⁻² | a |
| B and T Area cribs and trenches (ditches) construction 1 | 2050 | 2053 | a | a | a | a | a | a | a | a | a |
| B and T Area cribs and trenches (ditches) construction 2 | 2096 | 2099 | a | a | a | a | a | a | a | a | a |
| B and T Area cribs and trenches (ditches) deactivation 1 | 2085 | 2087 | a | a | a | a | a | a | a | a | a |
| B and T Area cribs and trenches (ditches) deactivation 2 | 2146 | 2148 | a | a | a | a | a | a | a | a | a |
| Preprocessing Facility construction | 2039 | 2041 | a | a | a | a | a | a | a | a | a |
| Preprocessing Facility operations | 2042 | 2162 | 3.65 | 7.81×10 ⁻¹ | 1.59×10 ⁻² | 7.64×10 ⁻² | 1.43×10 ⁻³ | 2.21 | 7.71×10 ⁻¹ | 1.92×10 ⁻¹ | 3.59×10 ⁻³ |
| Preprocessing Facility deactivation | 2163 | 2163 | a | a | a | a | a | a | a | a | a |
| Total | | | 2.24×10 ⁴ | 3.79×10 ³ | 1.49×10 ¹ | 3.65×10³ | 3.87×10 ¹ | 4.16×10 ¹ | 1.76×10 ¹ | 3.15 | 7.60×10 ⁻² |

^a This activity would not contribute to the concentration during the peak year(s) for this pollutant and averaging period.

^b Emissions for this activity and pollutant were not calculated because they would be small compared with those for other activities under this alternative, as explained in Section G.2.

Note: Total concentrations exceeding applicable standards are presented in **bold**.

Key: HLW=high-level radioactive waste; IHLW=immobilized high-level radioactive waste; PM₁₀=particulate matter with an aerodynamic diameter less than or equal to 10 micrometers.

Source: SAIC 2007a, 2008.

Table G-132. Tank Closure Alternative 6A, Option Case, Maximum Toxic Pollutant Concentrations of Peak Activity Periods

| Facility/System | Start Year | End Year | Concentration (micrograms per cubic meter) | | | | | | |
|--|------------|----------|--|-----------------------|-----------------------|-----------------------|-----------|-----------|-----------------------|
| | | | Ammonia | Benzene | 1,3-Butadiene | Formaldehyde | Mercury | Toluene | Xylene |
| | | | 24-hour | Annual | Annual | Annual | 24-hour | 24-hour | 24-hour |
| | | | 2015-2016 | 2041 | 2054-2055 | 2054-2055 | 2079-2141 | 2158-2161 | 2158-2161 |
| Construction | | | | | | | | | |
| Canister Storage Building | 2006 | 2016 | b | a | a | a | a | a | a |
| IHLW Shipping/Transfer Facility | 2011 | 2013 | a | a | a | a | a | a | a |
| IHLW Interim Storage Modules | 2014 | 2157 | b | b | b | b | b | a | a |
| Other infrastructure upgrades | 2006 | 2034 | b | a | a | a | a | a | a |
| Tank upgrades | 2006 | 2025 | 8.81×10 ⁻² | a | a | a | a | a | a |
| Waste Treatment Plant original | 2006 | 2017 | 5.01×10 ⁻¹ | a | a | a | a | a | a |
| Cesium and Strontium Capsule Processing Facility | 2158 | 2161 | a | a | a | a | a | 2.10 | 5.97×10 ⁻¹ |
| Tank risers | 2013 | 2016 | 2.68 | a | a | a | a | a | a |
| Double-shell tank replacement 1 | 2029 | 2034 | a | a | a | a | a | a | a |
| Double-shell tank replacement 2 | 2069 | 2074 | a | a | a | a | a | a | a |
| Double-shell tank replacement 3 | 2109 | 2114 | a | a | a | a | a | a | a |
| Mobile retrieval system | 2013 | 2162 | 1.23×10 ⁻¹ | b | b | b | b | b | b |
| Vacuum-based retrieval system | 2013 | 2162 | 3.85×10 ⁻² | b | b | b | b | b | b |
| Chemical wash system | 2013 | 2162 | 1.61×10 ⁻³ | b | b | b | b | b | b |
| HLW Melter Interim Storage Facility 1 | 2017 | 2018 | a | a | a | a | a | a | a |
| HLW Melter Interim Storage Facility 2 | 2037 | 2038 | a | a | a | a | a | a | a |
| HLW Melter Interim Storage Facility 3 | 2057 | 2058 | a | a | a | a | a | a | a |
| HLW Melter Interim Storage Facility 4 | 2077 | 2078 | a | a | a | a | a | a | a |
| HLW Melter Interim Storage Facility 5 | 2097 | 2098 | a | a | a | a | a | a | a |
| HLW Melter Interim Storage Facility 6 | 2117 | 2118 | a | a | a | a | a | a | a |
| HLW Melter Interim Storage Facility 7 | 2137 | 2138 | a | a | a | a | a | a | a |
| Underground transfer line replacement | 2064 | 2064 | a | a | a | a | a | a | a |
| Waste Treatment Plant replacement 1 | 2067 | 2078 | a | a | a | a | a | a | a |
| Waste Treatment Plant replacement 2 | 2127 | 2138 | a | a | a | a | a | a | a |
| IHLW Shipping/Transfer Facility 1 | 2076 | 2078 | a | a | a | a | a | a | a |
| IHLW Shipping/Transfer Facility 2 | 2136 | 2138 | a | a | a | a | a | a | a |
| IHLW Shipping/Transfer Facility 3 | 2196 | 2198 | a | a | a | a | a | a | a |
| IHLW Interim Storage Modules, additional | 2078 | 2197 | a | a | a | a | b | b | b |
| HLW Debris Storage Facility | 2041 | 2110 | a | 2.75×10 ⁻⁶ | 1.15×10 ⁻⁷ | 3.48×10 ⁻⁶ | b | a | a |
| Effluent Treatment Facility replacement 1 | 2023 | 2025 | a | a | a | a | a | a | a |
| Effluent Treatment Facility replacement 2 | 2053 | 2055 | a | a | 1.28×10 ⁻⁵ | 5.39×10 ⁻⁴ | a | a | a |
| Effluent Treatment Facility replacement 3 | 2083 | 2085 | a | a | a | a | a | a | a |
| Effluent Treatment Facility replacement 4 | 2113 | 2115 | a | a | a | a | a | a | a |

G-286

Table G-132. Tank Closure Alternative 6A, Option Case, Maximum Toxic Pollutant Concentrations of Peak Activity Periods (continued)

| Facility/System | Start Year | End Year | Concentration (micrograms per cubic meter) | | | | | | |
|--|------------|----------|--|-----------------------|-----------------------|-----------------------|-----------------------|-----------------------|-----------------------|
| | | | Ammonia | Benzene | 1,3-Butadiene | Formaldehyde | Mercury | Toluene | Xylene |
| | | | 24-hour 2015-2016 | Annual 2041 | Annual 2054-2055 | Annual 2054-2055 | 24-hour 2079-2141 | 24-hour 2158-2161 | 24-hour 2158-2161 |
| Construction (continued) | | | | | | | | | |
| Effluent Treatment Facility replacement 5 | 2143 | 2145 | a | a | a | a | a | a | a |
| Evaporator replacement 1 | 2015 | 2017 | 6.32×10 ⁻² | a | a | a | a | a | a |
| Evaporator replacement 2 | 2040 | 2042 | a | 3.41×10 ⁻⁴ | a | a | a | a | a |
| Evaporator replacement 3 | 2065 | 2067 | a | a | a | a | a | a | a |
| Evaporator replacement 4 | 2090 | 2092 | a | a | a | a | a | a | a |
| Evaporator replacement 5 | 2115 | 2117 | a | a | a | a | a | a | a |
| Evaporator replacement 6 | 2140 | 2142 | a | a | a | a | a | a | a |
| Underground transfer line 1,000-foot sections | 2009 | 2009 | a | a | a | a | a | a | a |
| Operations | | | | | | | | | |
| IHLW Interim Storage Facility | 2018 | 2262 | a | b | b | b | b | b | b |
| Other infrastructure upgrades | 2006 | 2162 | b | b | b | b | b | b | b |
| Routine operations | 2006 | 2162 | 5.59 | b | b | b | b | b | b |
| Retrieval operations | 2006 | 2162 | 4.60×10 ⁻² | b | b | b | b | b | b |
| Double-shell tank interim stabilization | 2006 | 2162 | 3.02×10 ⁻¹ | b | b | b | b | b | b |
| Waste Treatment Plant | 2018 | 2162 | a | 1.38×10 ⁻⁴ | 4.98×10 ⁻⁸ | 1.54×10 ⁻⁶ | 1.45×10 ⁻³ | 8.37×10 ⁻⁵ | 2.82×10 ⁻⁴ |
| Waste Treatment Plant, cesium and strontium capsules | 2163 | 2163 | a | a | a | a | a | a | a |
| Cesium and Strontium Capsule Processing Facility | 2162 | 2163 | a | a | a | a | a | a | a |
| Mobile retrieval system | 2013 | 2162 | 1.23×10 ⁻¹ | b | b | b | b | b | b |
| Vacuum-based retrieval system | 2013 | 2162 | 3.85×10 ⁻² | b | b | b | b | b | b |
| Chemical wash system | 2013 | 2162 | 1.61×10 ⁻³ | b | b | b | b | b | b |
| HLW Melter Interim Storage Facility | 2018 | 2262 | a | b | b | b | b | b | b |
| HLW Debris Storage Facility | 2042 | 2262 | a | a | b | b | b | b | b |
| Effluent Treatment Facility | 2006 | 2166 | 3.72×10 ⁻⁴ | 6.54×10 ⁻⁶ | 1.08×10 ⁻⁷ | 4.03×10 ⁻⁶ | b | 1.53×10 ⁻³ | 4.39×10 ⁻⁴ |
| Evaporator | 2018 | 2163 | a | 1.24×10 ⁻⁴ | 5.22×10 ⁻⁶ | 1.57×10 ⁻⁴ | b | 5.79×10 ⁻³ | 4.04×10 ⁻³ |
| Borrow Area C | 2006 | 2167 | 3.08×10 ⁻¹ | 1.24×10 ⁻⁴ | 4.04×10 ⁻⁶ | 1.27×10 ⁻⁴ | b | 2.28×10 ⁻¹ | 7.18×10 ⁻² |
| Deactivation | | | | | | | | | |
| Mobile retrieval system | 2013 | 2162 | b | b | b | b | b | b | b |
| Vacuum-based retrieval system | 2013 | 2162 | b | b | b | b | b | b | b |
| Chemical wash system | 2013 | 2162 | b | b | b | b | b | b | b |
| IHLW Interim Storage Facility | 2078 | 2197 | a | a | a | a | b | b | b |
| Waste Treatment Plant original | 2079 | 2081 | a | a | a | a | 9.11×10 ⁻⁴ | a | a |
| Waste Treatment Plant replacement 1 | 2139 | 2141 | a | a | a | a | a | a | a |
| Waste Treatment Plant replacement 2 | 2164 | 2166 | a | a | a | a | a | a | a |

Table G-132. Tank Closure Alternative 6A, Option Case, Maximum Toxic Pollutant Concentrations of Peak Activity Periods (continued)

| Facility/System | Start Year | End Year | Concentration (micrograms per cubic meter) | | | | | | |
|---|------------|----------|--|----------------|---------------------|---------------------|----------------------|----------------------|----------------------|
| | | | Ammonia | Benzene | 1,3-Butadiene | Formaldehyde | Mercury | Toluene | Xylene |
| | | | 24-hour 2015-2016 | Annual 2041 | Annual 2054-2055 | Annual 2054-2055 | 24-hour 2079-2141 | 24-hour 2158-2161 | 24-hour 2158-2161 |
| Deactivation (continued) | | | | | | | | | |
| Cesium and Strontium Capsule Processing Facility | 2164 | 2164 | a | a | a | a | a | a | a |
| Effluent Treatment Facility original | 2026 | 2026 | a | a | a | a | a | a | a |
| Effluent Treatment Facility replacement 1 | 2056 | 2056 | a | a | a | a | a | a | a |
| Effluent Treatment Facility replacement 2 | 2086 | 2086 | a | a | a | a | a | a | a |
| Effluent Treatment Facility replacement 3 | 2116 | 2116 | a | a | a | a | a | a | a |
| Effluent Treatment Facility replacement 4 | 2146 | 2146 | a | a | a | a | a | a | a |
| Effluent Treatment Facility replacement 5 | 2167 | 2167 | a | a | a | a | a | a | a |
| Evaporator original | 2018 | 2018 | a | a | a | a | a | a | a |
| Evaporator replacement 1 | 2043 | 2043 | a | a | a | a | a | a | a |
| Evaporator replacement 2 | 2068 | 2068 | a | a | a | a | a | a | a |
| Evaporator replacement 3 | 2093 | 2093 | a | a | a | a | a | a | a |
| Evaporator replacement 4 | 2118 | 2118 | a | a | a | a | a | a | a |
| Evaporator replacement 5 | 2143 | 2143 | a | a | a | a | a | a | a |
| Evaporator replacement 6 | 2168 | 2168 | a | a | a | a | a | a | a |
| Closure | | | | | | | | | |
| Containment structure construction 1 | 2038 | 2041 | a | b | a | a | a | a | a |
| Containment structure construction 2 | 2061 | 2064 | a | a | a | a | a | a | a |
| Containment structure construction 3 | 2084 | 2087 | a | a | a | a | a | a | a |
| Containment structure construction 4 | 2107 | 2110 | a | a | a | a | a | a | a |
| Containment structure construction 5 | 2122 | 2125 | a | a | a | a | a | a | a |
| Containment structure construction 6 | 2138 | 2141 | a | a | a | a | a | a | a |
| Containment structure deactivation 1 | 2062 | 2064 | a | a | a | a | a | a | a |
| Containment structure deactivation 2 | 2085 | 2087 | a | a | a | a | a | a | a |
| Containment structure deactivation 3 | 2108 | 2110 | a | a | a | a | a | a | a |
| Containment structure deactivation 4 | 2123 | 2125 | a | a | a | a | a | a | a |
| Containment structure deactivation 5 | 2146 | 2148 | a | a | a | a | a | a | a |
| Containment structure deactivation 6 | 2138 | 2140 | a | a | a | a | a | a | a |
| Containment structure deactivation 7 | 2162 | 2164 | a | a | a | a | a | a | a |
| Decontamination and decommissioning of 10 selected facilities | 2018 | 2028 | a | a | a | a | a | a | a |
| B tank farm removal | 2065 | 2076 | a | a | a | a | a | a | a |
| T tank farm removal | 2126 | 2137 | a | a | a | a | a | a | a |
| BY tank farm removal | 2111 | 2122 | a | a | a | a | a | a | a |
| BX tank farm removal | 2042 | 2053 | a | a | a | a | a | a | a |

Table G-132. Tank Closure Alternative 6A, Option Case, Maximum Toxic Pollutant Concentrations of Peak Activity Periods (continued)

| Facility/System | Start Year | End Year | Concentration (micrograms per cubic meter) | | | | | | |
|--|------------|----------|--|-----------------------|------------------------|------------------------|-----------------------|-----------------------|-----------------------|
| | | | Ammonia | Benzene | 1,3-Butadiene | Formaldehyde | Mercury | Toluene | Xylene |
| | | | 24-hour 2015–2016 | Annual 2041 | Annual 2054–2055 | Annual 2054–2055 | 24-hour 2079–2141 | 24-hour 2158–2161 | 24-hour 2158–2161 |
| Closure (continued) | | | | | | | | | |
| C tank farm removal | 2088 | 2099 | a | a | a | a | a | a | a |
| A tank farm removal | 2142 | 2153 | a | a | a | a | a | a | a |
| AX tank farm removal | 2142 | 2153 | a | a | a | a | a | a | a |
| S tank farm removal | 2126 | 2137 | a | a | a | a | a | a | a |
| TY tank farm removal | 2111 | 2122 | a | a | a | a | a | a | a |
| TX tank farm removal | 2088 | 2099 | a | a | a | a | a | a | a |
| U tank farm removal | 2065 | 2076 | a | a | a | a | a | a | a |
| SX tank farm removal | 2042 | 2053 | a | a | a | a | a | a | a |
| B tank farm deep soil removal | 2077 | 2084 | a | a | a | a | b | a | a |
| T tank farm deep soil removal | 2138 | 2145 | a | a | a | a | a | a | a |
| BX tank farm deep soil removal | 2054 | 2061 | a | a | 2.53×10 ⁻⁵ | 7.65×10 ⁻⁴ | a | a | a |
| C tank farm deep soil removal | 2100 | 2107 | a | a | a | a | a | a | a |
| A tank farm deep soil removal | 2154 | 2161 | a | a | a | a | a | 1.60×10 ⁻⁴ | 1.12×10 ⁻⁴ |
| AX tank farm deep soil removal | 2154 | 2161 | a | a | a | a | a | 2.67×10 ⁻³ | 1.86×10 ⁻³ |
| TX tank farm deep soil removal | 2100 | 2107 | a | a | a | a | a | a | a |
| U tank farm deep soil removal | 2077 | 2084 | a | a | a | a | b | a | a |
| SX tank farm deep soil removal | 2054 | 2061 | a | a | 9.67×10 ⁻⁶ | 2.92×10 ⁻⁴ | a | a | a |
| B Area cribs and trenches (ditches) removal | 2054 | 2084 | a | a | 1.85×10 ⁻⁵ | 5.59×10 ⁻⁴ | b | a | a |
| T Area cribs and trenches (ditches) removal | 2100 | 2145 | a | a | a | a | a | a | a |
| B & T Area cribs and trenches (ditches) construction 1 | 2050 | 2053 | a | a | a | a | a | a | a |
| B & T Area cribs and trenches (ditches) construction 2 | 2096 | 2099 | a | a | a | a | a | a | a |
| B & T Area cribs and trenches (ditches) deactivation 1 | 2085 | 2087 | a | a | a | a | a | a | a |
| B & T Area cribs and trenches (ditches) deactivation 2 | 2146 | 2148 | a | a | a | a | a | a | a |
| Preprocessing Facility construction | 2039 | 2041 | a | 2.04×10 ⁻³ | a | a | a | a | a |
| Preprocessing Facility operations | 2042 | 2162 | a | a | 8.86×10 ⁻¹² | 5.06×10 ⁻¹⁰ | b | 1.17×10 ⁻⁶ | 3.30×10 ⁻⁶ |
| Preprocessing Facility deactivation | 2163 | 2163 | a | a | a | a | a | a | a |
| Total | | | 9.91 | 2.78×10 ⁻³ | 7.59×10 ⁻⁵ | 2.45×10 ⁻³ | 2.36×10 ⁻³ | 2.34 | 6.76×10 ⁻¹ |

^a This activity would not contribute to the concentration during the peak year(s) for this pollutant and averaging period.

^b Emissions for this activity and pollutant were not calculated because they would be small compared with those for other activities under this alternative, as explained in Section G.2.

Key: HLW=high-level radioactive waste; IHLW=immobilized high-level radioactive waste.

Source: SAIC 2007a, 2008.

Table G-133. Tank Closure Alternative 6B, Base Case, Maximum Criteria Pollutant Concentrations of Peak Activity Periods

| Facility/System | Start Year | End Year | Concentration (micrograms per cubic meter) | | | | | | | | |
|---|------------|----------|--|-----------------------|------------------|------------------|--------|-----------------------|-----------------------|-----------------------|-----------------------|
| | | | Carbon Monoxide | | Nitrogen Dioxide | PM ₁₀ | | Sulfur Dioxide | | | |
| | | | 1-hour | 8-hour | Annual | 24-hour | Annual | 1-hour | 3-hour | 24-hour | Annual |
| | | | 2016 | 2016 | 2101 | 2101 | 2101 | 2040 | 2040 | 2040 | 2040 |
| Construction | | | | | | | | | | | |
| Canister Storage Building | 2006 | 2016 | 4.37×10 ¹ | 6.76 | a | a | a | a | a | a | a |
| IHLW Shipping/Transfer Facility and one IHLW Interim Storage Module | 2011 | 2013 | a | a | a | a | a | a | a | a | a |
| IHLW Interim Storage Modules, three additional | 2014 | 2022 | 3.15×10 ² | 4.88×10 ¹ | a | a | a | a | a | a | a |
| Other infrastructure upgrades | 2006 | 2034 | 1.80×10 ¹ | 2.88 | a | a | a | a | a | a | a |
| Tank upgrades | 2006 | 2025 | 5.67×10 ³ | 9.09×10 ² | a | a | a | a | a | a | a |
| Waste Treatment Plant | 2006 | 2017 | 1.72×10 ⁴ | 2.42×10 ³ | a | a | a | a | a | a | a |
| Low-Activity Waste Vitrification Facility expansion | 2008 | 2017 | 1.46×10 ³ | 2.26×10 ² | a | a | a | a | a | a | a |
| Cesium and Strontium Capsule Processing Facility | 2035 | 2038 | a | a | a | a | a | a | a | a | a |
| Waste receiver facilities | 2013 | 2017 | 1.87×10 ³ | 2.99×10 ² | a | a | a | a | a | a | a |
| Tank risers | 2013 | 2016 | 3.26×10 ² | 5.23×10 ¹ | a | a | a | a | a | a | a |
| Mobile retrieval system | 2013 | 2043 | 1.41×10 ³ | 2.26×10 ² | a | a | a | 1.96×10 ⁻¹ | 6.67×10 ⁻² | 1.36×10 ⁻² | 1.01×10 ⁻⁴ |
| Vacuum-based retrieval system | 2013 | 2043 | 5.26×10 ² | 8.43×10 ¹ | a | a | a | 7.57×10 ⁻² | 2.57×10 ⁻² | 5.25×10 ⁻³ | 3.88×10 ⁻⁵ |
| Chemical wash system | 2013 | 2043 | 3.56 | 5.71×10 ⁻¹ | a | a | a | 5.94×10 ⁻³ | 2.02×10 ⁻³ | 4.12×10 ⁻⁴ | 3.04×10 ⁻⁶ |
| HLW Melter Interim Storage Facility 1 | 2015 | 2016 | 1.39×10 ¹ | 1.96 | a | a | a | a | a | a | a |
| HLW Melter Interim Storage Facility 2 | 2029 | 2030 | a | a | a | a | a | a | a | a | a |
| Effluent Treatment Facility replacement 1 | 2023 | 2025 | a | a | a | a | a | a | a | a | a |
| Effluent Treatment Facility replacement 2 | 2053 | 2055 | a | a | a | a | a | a | a | a | a |
| Effluent Treatment Facility replacement 3 | 2083 | 2085 | a | a | a | a | a | a | a | a | a |
| Evaporator replacement 1 | 2015 | 2017 | 3.56×10 ³ | 5.50×10 ² | a | a | a | a | a | a | a |
| Immobilized Low-Activity Waste Interim Storage Facilities | 2016 | 2043 | 2.29×10 ¹ | 3.22 | a | a | a | 3.49×10 ⁻² | 1.16×10 ⁻² | 2.00×10 ⁻³ | 1.95×10 ⁻⁵ |
| HLW Debris Storage Facilities | 2021 | 2090 | a | a | a | a | a | 8.63×10 ⁻³ | 2.93×10 ⁻³ | 5.98×10 ⁻⁴ | 4.42×10 ⁻⁶ |
| Underground transfer line 1,000-foot sections | 2009 | 2009 | a | a | a | a | a | a | a | a | a |
| Operations | | | | | | | | | | | |
| IHLW Interim Storage Facility | 2018 | 2066 | a | a | a | a | a | b | b | b | b |
| Other infrastructure upgrades | 2006 | 2043 | b | b | a | a | a | b | b | b | b |
| Routine operations | 2006 | 2043 | 5.72×10 ¹ | 1.50×10 ¹ | a | a | a | b | b | b | b |
| Retrieval operations | 2006 | 2043 | 7.66×10 ⁻¹ | 1.23×10 ⁻¹ | a | a | a | b | b | b | b |
| Double-shell tank interim stabilization | 2006 | 2043 | 5.02 | 8.05×10 ⁻¹ | a | a | a | b | b | b | b |
| Waste Treatment Plant | 2018 | 2043 | a | a | a | a | a | 3.01×10 ¹ | 1.85×10 ¹ | 3.09 | 1.44×10 ⁻¹ |
| Waste Treatment Plant, cesium and strontium capsules | 2040 | 2040 | a | a | a | a | a | 3.01×10 ¹ | 1.85×10 ¹ | 3.09 | 1.44×10 ⁻¹ |

G-290

Table G-133. Tank Closure Alternative 6B, Base Case, Maximum Criteria Pollutant Concentrations of Peak Activity Periods (continued)

| Facility/System | Start Year | End Year | Concentration (micrograms per cubic meter) | | | | | | | | | |
|---|------------|----------|--|-----------------------|-----------------------|----------------------|-----------------------|-----------------------|-----------------------|-----------------------|-----------------------|-----------------------|
| | | | Carbon Monoxide | | Nitrogen Dioxide | PM ₁₀ | | | Sulfur Dioxide | | | |
| | | | 1-hour | 8-hour | Annual | 24-hour | Annual | 1-hour | 3-hour | 24-hour | Annual | |
| | | | 2016 | 2016 | 2101 | 2101 | 2101 | 2040 | 2040 | 2040 | 2040 | |
| Operations (continued) | | | | | | | | | | | | |
| Cesium and Strontium Capsule Processing Facility | 2039 | 2040 | a | a | a | a | a | a | 5.14×10 ⁻¹ | 1.76×10 ⁻¹ | 4.70×10 ⁻² | 7.71×10 ⁻⁴ |
| Mobile retrieval system | 2013 | 2043 | 6.48 | 1.04 | a | a | a | a | b | b | b | b |
| Vacuum-based retrieval system | 2013 | 2043 | 3.58 | 5.74×10 ⁻¹ | a | a | a | a | b | b | b | b |
| Chemical wash system | 2013 | 2043 | 2.38 | 3.81×10 ⁻¹ | a | a | a | a | 2.36×10 ⁻³ | 8.02×10 ⁻⁴ | 1.64×10 ⁻⁴ | 1.21×10 ⁻⁶ |
| HLW Melter Interim Storage Facility | 2018 | 2199 | a | a | b | b | b | b | b | b | b | b |
| Effluent Treatment Facility | 2006 | 2100 | 7.85 | 2.41 | a | a | a | a | 1.06×10 ⁻² | 6.52×10 ⁻³ | 1.09×10 ⁻³ | 5.08×10 ⁻⁵ |
| Evaporator | 2006 | 2043 | 2.00×10 ² | 3.09×10 ¹ | a | a | a | a | 3.15×10 ⁻¹ | 1.13×10 ⁻¹ | 2.13×10 ⁻² | 2.00×10 ⁻⁴ |
| Borrow Area C | 2006 | 2102 | 6.91×10 ² | 2.83×10 ² | 4.42×10 ⁻¹ | 3.98×10 ² | 9.10×10 ⁻¹ | 9.72×10 ⁻¹ | 9.72×10 ⁻¹ | 6.58×10 ⁻¹ | 2.07×10 ⁻¹ | 4.75×10 ⁻⁴ |
| Immobilized Low-Activity Waste Interim Storage Facilities | 2018 | 2199 | a | a | b | b | b | b | b | b | b | b |
| HLW Debris Storage Facilities | 2023 | 2199 | a | a | b | b | b | b | b | b | b | b |
| Deactivation | | | | | | | | | | | | |
| Mobile retrieval system | 2013 | 2043 | 7.04×10 ² | 1.13×10 ² | a | a | a | a | 1.69×10 ⁻² | 5.73×10 ⁻³ | 1.17×10 ⁻³ | 8.64×10 ⁻⁶ |
| Vacuum-based retrieval system | 2013 | 2043 | 1.15×10 ¹ | 1.84 | a | a | a | a | 2.74×10 ⁻⁴ | 9.32×10 ⁻⁵ | 1.90×10 ⁻⁵ | 1.41×10 ⁻⁷ |
| Chemical wash system | 2013 | 2043 | 3.29×10 ¹ | 5.27 | a | a | a | a | 1.85×10 ⁻³ | 6.28×10 ⁻⁴ | 1.28×10 ⁻⁴ | 9.47×10 ⁻⁷ |
| IHLW Interim Storage Facility | 2067 | 2067 | a | a | a | a | a | a | a | a | a | a |
| Waste Treatment Plant | 2044 | 2045 | a | a | a | a | a | a | a | a | a | a |
| Cesium and Strontium Capsule Processing Facility | 2041 | 2041 | a | a | a | a | a | a | a | a | a | a |
| Effluent Treatment Facility original | 2026 | 2026 | a | a | a | a | a | a | a | a | a | a |
| Effluent Treatment Facility replacement 1 | 2056 | 2056 | a | a | a | a | a | a | a | a | a | a |
| Effluent Treatment Facility replacement 2 | 2086 | 2086 | a | a | a | a | a | a | a | a | a | a |
| Effluent Treatment Facility replacement 3 | 2101 | 2101 | a | a | 6.02×10 ⁻¹ | 6.06×10 ² | 5.92 | a | a | a | a | a |
| Evaporator original | 2018 | 2018 | a | a | a | a | a | a | a | a | a | a |
| Evaporator replacement | 2044 | 2044 | a | a | a | a | a | a | a | a | a | a |
| Closure | | | | | | | | | | | | |
| Containment structure construction 1 | 2019 | 2022 | a | a | a | a | a | a | a | a | a | a |
| Containment structure construction 2 | 2019 | 2022 | a | a | a | a | a | a | a | a | a | a |
| Containment structure construction 3 | 2046 | 2049 | a | a | a | a | a | a | a | a | a | a |
| Containment structure construction 4 | 2046 | 2049 | a | a | a | a | a | a | a | a | a | a |
| Containment structure construction 5 | 2073 | 2076 | a | a | a | a | a | a | a | a | a | a |
| Containment structure construction 6 | 2073 | 2076 | a | a | a | a | a | a | a | a | a | a |
| Containment structure deactivation 1 | 2043 | 2045 | a | a | a | a | a | a | a | a | a | a |

Table G-133. Tank Closure Alternative 6B, Base Case, Maximum Criteria Pollutant Concentrations of Peak Activity Periods (continued)

| Facility/System | Start Year | End Year | Concentration (micrograms per cubic meter) | | | | | | | | |
|---|------------|----------|--|--------|----------------------|----------------------|----------------------|-----------------------|-----------------------|-----------------------|-----------------------|
| | | | Carbon Monoxide | | Nitrogen Dioxide | PM ₁₀ | | Sulfur Dioxide | | | |
| | | | 1-hour | 8-hour | Annual | 24-hour | Annual | 1-hour | 3-hour | 24-hour | Annual |
| | | | 2016 | 2016 | 2101 | 2101 | 2101 | 2040 | 2040 | 2040 | 2040 |
| Closure (continued) | | | | | | | | | | | |
| Containment structure deactivation 2 | 2043 | 2045 | a | a | a | a | a | a | a | a | a |
| Containment structure deactivation 3 | 2070 | 2072 | a | a | a | a | a | a | a | a | a |
| Containment structure deactivation 4 | 2062 | 2064 | a | a | a | a | a | a | a | a | a |
| Containment structure deactivation 5 | 2089 | 2091 | a | a | a | a | a | a | a | a | a |
| Containment structure deactivation 6 | 2097 | 2099 | a | a | a | a | a | a | a | a | a |
| Containment structure deactivation 7 | 2097 | 2099 | a | a | a | a | a | a | a | a | a |
| Modified Resource Conservation and Recovery Act Subtitle C barrier construction | 2100 | 2101 | a | a | 1.31×10 ¹ | 4.11×10 ³ | 3.04×10 ¹ | a | a | a | a |
| Decontamination and decommissioning of 10 selected facilities | 2018 | 2028 | a | a | a | a | a | a | a | a | a |
| B tank farm removal | 2023 | 2034 | a | a | a | a | a | a | a | a | a |
| T tank farm removal | 2077 | 2088 | a | a | a | a | a | a | a | a | a |
| BY tank farm removal | 2050 | 2061 | a | a | a | a | a | a | a | a | a |
| BX tank farm removal | 2023 | 2034 | a | a | a | a | a | a | a | a | a |
| C tank farm removal | 2050 | 2061 | a | a | a | a | a | a | a | a | a |
| A tank farm removal | 2077 | 2088 | a | a | a | a | a | a | a | a | a |
| AX tank farm removal | 2077 | 2088 | a | a | a | a | a | a | a | a | a |
| S tank farm removal | 2077 | 2088 | a | a | a | a | a | a | a | a | a |
| TY tank farm removal | 2050 | 2061 | a | a | a | a | a | a | a | a | a |
| TX tank farm removal | 2050 | 2061 | a | a | a | a | a | a | a | a | a |
| U tank farm removal | 2023 | 2034 | a | a | a | a | a | a | a | a | a |
| SX tank farm removal | 2023 | 2034 | a | a | a | a | a | a | a | a | a |
| B tank farm deep soil removal | 2035 | 2042 | a | a | a | a | a | 4.78×10 ⁻² | 1.71×10 ⁻² | 3.23×10 ⁻³ | 3.04×10 ⁻⁵ |
| T tank farm deep soil removal | 2089 | 2096 | a | a | a | a | a | a | a | a | a |
| BX tank farm deep soil removal | 2035 | 2042 | a | a | a | a | a | 1.53 | 5.48×10 ⁻¹ | 1.03×10 ⁻¹ | 9.72×10 ⁻⁴ |
| C tank farm deep soil removal | 2062 | 2069 | a | a | a | a | a | a | a | a | a |
| A tank farm deep soil removal | 2089 | 2096 | a | a | a | a | a | a | a | a | a |
| AX tank farm deep soil removal | 2089 | 2096 | a | a | a | a | a | a | a | a | a |
| TX tank farm deep soil removal | 2062 | 2069 | a | a | a | a | a | a | a | a | a |
| U tank farm deep soil removal | 2035 | 2042 | a | a | a | a | a | 4.92×10 ⁻¹ | 1.67×10 ⁻¹ | 3.42×10 ⁻² | 2.53×10 ⁻⁴ |
| SX tank farm deep soil removal | 2035 | 2042 | a | a | a | a | a | 8.92×10 ⁻¹ | 3.43×10 ⁻¹ | 6.98×10 ⁻² | 4.46×10 ⁻⁴ |
| Preprocessing Facility construction | 2020 | 2022 | a | a | a | a | a | a | a | a | a |

Table G-133. Tank Closure Alternative 6B, Base Case, Maximum Criteria Pollutant Concentrations of Peak Activity Periods (continued)

| Facility/System | Start Year | End Year | Concentration (micrograms per cubic meter) | | | | | | | | |
|-------------------------------------|------------|----------|--|----------------------|----------------------|----------------------------|----------------------|-----------------------|-----------------------|-----------------------|-----------------------|
| | | | Carbon Monoxide | | Nitrogen Dioxide | PM ₁₀ | | Sulfur Dioxide | | | |
| | | | 1-hour | 8-hour | Annual | 24-hour | Annual | 1-hour | 3-hour | 24-hour | Annual |
| | | | 2016 | 2016 | 2101 | 2101 | 2101 | 2040 | 2040 | 2040 | 2040 |
| Closure (continued) | | | | | | | | | | | |
| Preprocessing Facility operations | 2023 | 2099 | a | a | a | a | a | 9.95×10 ⁻² | 3.47×10 ⁻² | 8.66×10 ⁻³ | 1.62×10 ⁻⁴ |
| Preprocessing Facility deactivation | 2100 | 2100 | a | a | a | a | a | a | a | a | a |
| Postclosure care | 2102 | 2201 | a | a | a | a | a | a | a | a | a |
| Total | | | 3.42×10 ⁴ | 5.29×10 ³ | 1.41×10 ¹ | 5.11×10³ | 3.72×10 ¹ | 6.53×10 ¹ | 3.91×10 ¹ | 6.69 | 2.91×10 ⁻¹ |

^a This activity would not contribute to the concentration during the peak year(s) for this pollutant and averaging period.

^b Emissions for this activity and pollutant were not calculated because they would be small compared with those for other activities under this alternative, as explained in Section G.2.

Key: HLW=high-level radioactive waste; IHLW=immobilized high-level radioactive waste; PM₁₀=particulate matter with an aerodynamic diameter less than or equal to 10 micrometers.

Source: SAIC 2007a, 2008.

Table G-134. Tank Closure Alternative 6B, Base Case, Maximum Toxic Pollutant Concentrations of Peak Activity Periods

| Facility/System | Start Year | End Year | Concentration (micrograms per cubic meter) | | | | | | |
|---|------------|----------|--|----------------|----------------|----------------|----------------------|-----------------|-----------------|
| | | | Ammonia | Benzene | 1,3-Butadiene | Formaldehyde | Mercury | Toluene | Xylene |
| | | | 24-hour 2016 | Annual 2101 | Annual 2101 | Annual 2101 | 24-hour 2044-2045 | 24-hour 2101 | 24-hour 2101 |
| Construction | | | | | | | | | |
| Canister Storage Building | 2006 | 2016 | b | a | a | a | a | a | a |
| IHLW Shipping/Transfer Facility and one IHLW Interim Storage Module | 2011 | 2013 | a | a | a | a | a | a | a |
| IHLW Interim Storage Modules, three additional | 2014 | 2022 | b | a | a | a | a | a | a |
| Other infrastructure upgrades | 2006 | 2034 | b | a | a | a | a | a | a |
| Tank upgrades | 2006 | 2025 | 8.81×10 ⁻² | a | a | a | a | a | a |
| Waste Treatment Plant | 2006 | 2017 | 1.29 | a | a | a | a | a | a |
| Low-Activity Waste Vitrification Facility | 2008 | 2017 | 3.76×10 ⁻² | a | a | a | a | a | a |
| Cesium and Strontium Capsule Processing Facility | 2035 | 2038 | a | a | a | a | a | a | a |
| Waste receiver facilities | 2013 | 2017 | b | a | a | a | a | a | a |
| Tank risers | 2013 | 2016 | 2.68 | a | a | a | a | a | a |
| Mobile retrieval system | 2013 | 2043 | 3.90×10 ⁻¹ | a | a | a | a | a | a |
| Vacuum-based retrieval system | 2013 | 2043 | 2.15×10 ⁻¹ | a | a | a | a | a | a |
| Chemical wash system | 2013 | 2043 | 6.05×10 ⁻³ | a | a | a | a | a | a |
| HLW Melter Interim Storage Facility 1 | 2015 | 2016 | b | a | a | a | a | a | a |
| HLW Melter Interim Storage Facility 2 | 2029 | 2030 | a | a | a | a | a | a | a |
| Effluent Treatment Facility replacement 1 | 2023 | 2025 | a | a | a | a | a | a | a |
| Effluent Treatment Facility replacement 2 | 2053 | 2055 | a | a | a | a | a | a | a |
| Effluent Treatment Facility replacement 3 | 2083 | 2085 | a | a | a | a | a | a | a |
| Evaporator replacement 1 | 2015 | 2017 | 6.32×10 ⁻² | a | a | a | a | a | a |
| Immobilized Low-Activity Waste Interim Storage Facilities | 2016 | 2043 | 9.56×10 ⁻³ | a | a | a | a | a | a |
| HLW Debris Storage Facilities | 2021 | 2090 | a | a | a | a | b | a | a |
| Underground transfer line 1,000-foot sections | 2009 | 2009 | a | a | a | a | a | a | a |
| Operations | | | | | | | | | |
| IHLW Interim Storage Facility | 2018 | 2066 | a | a | a | a | b | a | a |
| Other infrastructure upgrades | 2006 | 2043 | b | a | a | a | a | a | a |
| Routine operations | 2006 | 2043 | 5.59 | a | a | a | a | a | a |
| Retrieval operations | 2006 | 2043 | 4.60×10 ⁻² | a | a | a | a | a | a |
| Double-shell tank interim stabilization | 2006 | 2043 | 3.02×10 ⁻¹ | a | a | a | a | a | a |
| Waste Treatment Plant | 2018 | 2043 | a | a | a | a | a | a | a |
| Waste Treatment Plant, cesium and strontium capsules | 2040 | 2040 | a | a | a | a | a | a | a |
| Cesium and Strontium Capsule Processing Facility | 2039 | 2040 | a | a | a | a | a | a | a |
| Mobile retrieval system | 2013 | 2043 | 3.90×10 ⁻¹ | a | a | a | a | a | a |

Table G-134. Tank Closure Alternative 6B, Base Case, Maximum Toxic Pollutant Concentrations of Peak Activity Periods (continued)

| Facility/System | Start Year | End Year | Concentration (micrograms per cubic meter) | | | | | | |
|---|------------|----------|--|-----------------------|-----------------------|-----------------------|-----------------------|-----------------------|-----------------------|
| | | | Ammonia | Benzene | 1,3-Butadiene | Formaldehyde | Mercury | Toluene | Xylene |
| | | | 24-hour 2016 | Annual 2101 | Annual 2101 | Annual 2101 | 24-hour 2044-2045 | 24-hour 2101 | 24-hour 2101 |
| Operations (continued) | | | | | | | | | |
| Vacuum-based retrieval system | 2013 | 2043 | 2.15×10 ⁻¹ | a | a | a | a | a | a |
| Chemical wash system | 2013 | 2043 | 6.05×10 ⁻³ | a | a | a | a | a | a |
| HLW Melter Interim Storage Facility | 2018 | 2199 | a | b | b | b | b | b | b |
| Effluent Treatment Facility | 2006 | 2100 | 1.18×10 ⁻¹ | a | a | a | b | a | a |
| Evaporator | 2006 | 2043 | 9.82×10 ⁻² | a | a | a | a | a | a |
| Borrow Area C | 2006 | 2102 | 3.08×10 ⁻¹ | 1.24×10 ⁻⁴ | 4.04×10 ⁻⁶ | 1.27×10 ⁻⁴ | b | 2.28×10 ⁻¹ | 7.18×10 ⁻² |
| Immobilized Low-Activity Waste Interim Storage Facilities | 2018 | 2199 | a | b | b | b | b | b | b |
| HLW Debris Storage Facilities | 2023 | 2199 | a | b | b | b | b | b | b |
| Deactivation | | | | | | | | | |
| Mobile retrieval system | 2013 | 2043 | b | a | a | a | a | a | a |
| Vacuum-based retrieval system | 2013 | 2043 | b | a | a | a | a | a | a |
| Chemical wash system | 2013 | 2043 | b | a | a | a | a | a | a |
| IHLW Interim Storage Facility | 2067 | 2067 | a | a | a | a | a | a | a |
| Waste Treatment Plant | 2044 | 2045 | a | a | a | a | 1.17×10 ⁻¹ | a | a |
| Cesium and Strontium Capsule Processing Facility | 2041 | 2041 | a | a | a | a | a | a | a |
| Effluent Treatment Facility original | 2026 | 2026 | a | a | a | a | a | a | a |
| Effluent Treatment Facility replacement 1 | 2056 | 2056 | a | a | a | a | a | a | a |
| Effluent Treatment Facility replacement 2 | 2086 | 2086 | a | a | a | a | a | a | a |
| Effluent Treatment Facility replacement 3 | 2101 | 2101 | a | 2.81×10 ⁻⁴ | 5.95×10 ⁻⁶ | 2.06×10 ⁻⁴ | a | 2.57×10 ⁻¹ | 7.49×10 ⁻² |
| Evaporator original | 2018 | 2018 | a | a | a | a | a | a | a |
| Evaporator replacement 1 | 2044 | 2044 | a | a | a | a | b | a | a |
| Closure | | | | | | | | | |
| Containment structure construction 1 | 2019 | 2022 | a | a | a | a | a | a | a |
| Containment structure construction 2 | 2019 | 2022 | a | a | a | a | a | a | a |
| Containment structure construction 3 | 2046 | 2049 | a | a | a | a | a | a | a |
| Containment structure construction 4 | 2046 | 2049 | a | a | a | a | a | a | a |
| Containment structure construction 5 | 2073 | 2076 | a | a | a | a | a | a | a |
| Containment structure construction 6 | 2073 | 2076 | a | a | a | a | a | a | a |
| Containment structure deactivation 1 | 2043 | 2045 | a | a | a | a | b | a | a |
| Containment structure deactivation 2 | 2043 | 2045 | a | a | a | a | b | a | a |
| Containment structure deactivation 3 | 2070 | 2072 | a | a | a | a | a | a | a |
| Containment structure deactivation 4 | 2062 | 2064 | a | a | a | a | a | a | a |

Table G-134. Tank Closure Alternative 6B, Base Case, Maximum Toxic Pollutant Concentrations of Peak Activity Periods (continued)

| Facility/System | Start Year | End Year | Concentration (micrograms per cubic meter) | | | | | | |
|---|------------|----------|--|-----------------------|-----------------------|-----------------------|----------------------|-----------------|-----------------------|
| | | | Ammonia | Benzene | 1,3-Butadiene | Formaldehyde | Mercury | Toluene | Xylene |
| | | | 24-hour 2016 | Annual 2101 | Annual 2101 | Annual 2101 | 24-hour 2044-2045 | 24-hour 2101 | 24-hour 2101 |
| Closure (continued) | | | | | | | | | |
| Containment structure deactivation 5 | 2089 | 2091 | a | a | a | a | a | a | a |
| Containment structure deactivation 6 | 2097 | 2099 | a | a | a | a | a | a | a |
| Containment structure deactivation 7 | 2097 | 2099 | a | a | a | a | a | a | a |
| Modified Resource Conservation and Recovery Act Subtitle C barrier construction | 2100 | 2101 | a | 4.20×10 ⁻³ | 1.22×10 ⁻⁴ | 3.93×10 ⁻³ | a | 3.25 | 9.84×10 ⁻¹ |
| Decontamination and decommissioning of 10 selected facilities | 2018 | 2028 | a | a | a | a | a | a | a |
| B tank farm removal | 2023 | 2034 | a | a | a | a | a | a | a |
| T tank farm removal | 2077 | 2088 | a | a | a | a | a | a | a |
| BY tank farm removal | 2050 | 2061 | a | a | a | a | a | a | a |
| BX tank farm removal | 2023 | 2034 | a | a | a | a | a | a | a |
| C tank farm removal | 2050 | 2061 | a | a | a | a | a | a | a |
| A tank farm removal | 2077 | 2088 | a | a | a | a | a | a | a |
| AX tank farm removal | 2077 | 2088 | a | a | a | a | a | a | a |
| S tank farm removal | 2077 | 2088 | a | a | a | a | a | a | a |
| TY tank farm removal | 2050 | 2061 | a | a | a | a | a | a | a |
| TX tank farm removal | 2050 | 2061 | a | a | a | a | a | a | a |
| U tank farm removal | 2023 | 2034 | a | a | a | a | a | a | a |
| SX tank farm removal | 2023 | 2034 | a | a | a | a | a | a | a |
| B tank farm deep soil removal | 2035 | 2042 | a | a | a | a | a | a | a |
| T tank farm deep soil removal | 2089 | 2096 | a | a | a | a | a | a | a |
| BX tank farm deep soil removal | 2035 | 2042 | a | a | a | a | a | a | a |
| C tank farm deep soil removal | 2062 | 2069 | a | a | a | a | a | a | a |
| A tank farm deep soil removal | 2089 | 2096 | a | a | a | a | a | a | a |
| AX tank farm deep soil removal | 2089 | 2096 | a | a | a | a | a | a | a |
| TX tank farm deep soil removal | 2062 | 2069 | a | a | a | a | a | a | a |
| U tank farm deep soil removal | 2035 | 2042 | a | a | a | a | a | a | a |
| SX tank farm deep soil removal | 2035 | 2042 | a | a | a | a | a | a | a |
| Preprocessing Facility construction | 2020 | 2022 | a | a | a | a | a | a | a |

Table G-134. Tank Closure Alternative 6B, Base Case, Maximum Toxic Pollutant Concentrations of Peak Activity Periods (continued)

| Facility/System | Start Year | End Year | Concentration (micrograms per cubic meter) | | | | | | |
|-------------------------------------|------------|----------|--|-----------------------|-----------------------|-----------------------|-----------------------|---------|---------|
| | | | Ammonia | Benzene | 1,3-Butadiene | Formaldehyde | Mercury | Toluene | Xylene |
| | | | 24-hour | Annual | Annual | Annual | 24-hour | 24-hour | 24-hour |
| | | | 2016 | 2101 | 2101 | 2101 | 2044-2045 | 2101 | 2101 |
| Closure (continued) | | | | | | | | | |
| Preprocessing Facility operations | 2023 | 2099 | a | a | a | a | b | a | a |
| Preprocessing Facility deactivation | 2100 | 2100 | a | a | a | a | a | a | a |
| Postclosure care | 2102 | 2201 | a | a | a | a | a | a | a |
| Total | | | 1.19×10^1 | 4.60×10^{-3} | 1.32×10^{-4} | 4.26×10^{-3} | 1.17×10^{-1} | 3.73 | 1.13 |

^a This activity would not contribute to the concentration during the peak year(s) for this pollutant and averaging period.

^b Emissions for this activity and pollutant were not calculated because they would be small compared with those for other activities under this alternative, as explained in Section G.2.

Key: HLW=high-level radioactive waste; IHLW=immobilized high-level radioactive waste.

Source: SAIC 2007a, 2008.

Table G-135. Tank Closure Alternative 6B, Option Case, Maximum Criteria Pollutant Concentrations of Peak Activity Periods

| Facility/System | Start Year | End Year | Concentration (micrograms per cubic meter) | | | | | | | | |
|---|------------|----------|--|-----------------------|-----------------------|-----------------------|-----------------------|-----------------------|-----------------------|-----------------------|-----------------------|
| | | | Carbon Monoxide | | Nitrogen Dioxide | PM ₁₀ | | Sulfur Dioxide | | | |
| | | | 1-hour | 8-hour | Annual | 24-hour | Annual | 1-hour | 3-hour | 24-hour | Annual |
| | | | 2016 | 2016 | 2040 | 2016 | 2016 | 2040 | 2040 | 2040 | 2040 |
| Construction | | | | | | | | | | | |
| Canister Storage Building | 2006 | 2016 | 4.37×10 ¹ | 6.76 | a | 4.82×10 ¹ | 4.54×10 ⁻³ | a | a | a | a |
| IHLW Shipping/Transfer Facility and one IHLW Interim Storage Module | 2011 | 2013 | a | a | a | a | a | a | a | a | a |
| IHLW Interim Storage Modules, three additional | 2014 | 2022 | 3.15×10 ² | 4.88×10 ¹ | a | 8.40×10 ¹ | 7.91×10 ⁻¹ | a | a | a | a |
| Other infrastructure upgrades | 2006 | 2034 | 1.80×10 ¹ | 2.88 | a | 1.27 | 9.42×10 ⁻³ | a | a | a | a |
| Tank upgrades | 2006 | 2025 | 5.67×10 ³ | 9.09×10 ² | a | 9.09 | 6.72×10 ⁻² | a | a | a | a |
| Waste Treatment Plant | 2006 | 2017 | 1.72×10 ⁴ | 2.42×10 ³ | a | 5.36×10 ² | 5.23 | a | a | a | a |
| Low-Activity Waste Vitrification Facility | 2008 | 2017 | 1.46×10 ³ | 2.26×10 ² | a | 8.77×10 ¹ | 8.26×10 ⁻¹ | a | a | a | a |
| Cesium and Strontium Capsule Processing Facility | 2035 | 2038 | a | a | a | a | a | a | a | a | a |
| Waste receiver facilities | 2013 | 2017 | 1.87×10 ³ | 2.99×10 ² | a | 3.73×10 ² | 2.75 | a | a | a | a |
| Tank risers | 2013 | 2016 | 3.26×10 ² | 5.23×10 ¹ | a | 9.12×10 ¹ | 6.75×10 ⁻³ | a | a | a | a |
| Mobile retrieval system | 2013 | 2043 | 1.41×10 ³ | 2.26×10 ² | 3.14×10 ⁻¹ | 8.16 | 6.04×10 ⁻² | 1.96×10 ⁻¹ | 6.67×10 ⁻² | 1.36×10 ⁻² | 1.01×10 ⁻⁴ |
| Vacuum-based retrieval system | 2013 | 2043 | 5.26×10 ² | 8.43×10 ¹ | 1.22×10 ⁻¹ | 3.31 | 2.45×10 ⁻² | 7.57×10 ⁻² | 2.57×10 ⁻² | 5.25×10 ⁻³ | 3.88×10 ⁻³ |
| Chemical wash system | 2013 | 2043 | 3.56 | 5.71×10 ⁻¹ | 9.74×10 ⁻³ | 1.65×10 ⁻¹ | 1.22×10 ⁻³ | 5.94×10 ⁻³ | 2.02×10 ⁻³ | 4.12×10 ⁻⁴ | 3.04×10 ⁻⁶ |
| HLW Melter Interim Storage Facility 1 | 2015 | 2016 | 1.39×10 ¹ | 1.96 | a | 2.22×10 ¹ | 2.17×10 ⁻¹ | a | a | a | a |
| HLW Melter Interim Storage Facility 2 | 2029 | 2030 | a | a | a | a | a | a | a | a | a |
| Effluent Treatment Facility replacement 1 | 2023 | 2025 | a | a | a | a | a | a | a | a | a |
| Effluent Treatment Facility replacement 2 | 2053 | 2055 | a | a | a | a | a | a | a | a | a |
| Effluent Treatment Facility replacement 3 | 2083 | 2085 | a | a | a | a | a | a | a | a | a |
| Evaporator replacement 1 | 2015 | 2017 | 3.56×10 ³ | 5.50×10 ² | a | 9.34 | 8.79×10 ⁻² | a | a | a | a |
| Immobilized Low-Activity Waste Interim Storage Facilities | 2016 | 2043 | 2.29×10 ¹ | 3.22 | 5.95×10 ⁻² | 5.57×10 ¹ | 5.44×10 ⁻¹ | 3.49×10 ⁻² | 1.16×10 ⁻² | 2.00×10 ⁻³ | 1.95×10 ⁻⁵ |
| HLW Debris Storage Facilities | 2021 | 2090 | a | a | 1.30×10 ⁻² | a | a | 8.63×10 ⁻³ | 2.93×10 ⁻³ | 5.98×10 ⁻⁴ | 4.42×10 ⁻⁶ |
| Underground transfer line 1,000-foot sections | 2009 | 2009 | a | a | a | a | a | a | a | a | a |
| Operations | | | | | | | | | | | |
| IHLW Interim Storage Facility | 2018 | 2066 | a | a | b | a | a | b | b | b | b |
| Other infrastructure upgrades | 2006 | 2043 | b | b | b | b | b | b | b | b | b |
| Routine operations | 2006 | 2043 | 5.72×10 ¹ | 1.50×10 ¹ | 8.27×10 ⁻² | b | b | b | b | b | b |
| Retrieval operations | 2006 | 2043 | 7.66×10 ⁻¹ | 1.23×10 ⁻¹ | 4.45×10 ⁻⁴ | b | b | b | b | b | b |
| Double-shell tank interim stabilization | 2006 | 2043 | 5.02 | 8.05×10 ⁻¹ | 2.92×10 ⁻³ | b | b | b | b | b | b |
| Waste Treatment Plant | 2018 | 2043 | a | a | 2.80 | a | a | 3.01×10 ¹ | 1.85×10 ¹ | 3.09 | 1.44×10 ⁻¹ |
| Waste Treatment Plant, cesium and strontium capsules | 2040 | 2040 | a | a | 2.80 | a | a | 3.01×10 ¹ | 1.85×10 ¹ | 3.09 | 1.44×10 ⁻¹ |
| Cesium and Strontium Capsule Processing Facility | 2039 | 2040 | a | a | 1.53×10 ⁻² | a | a | 5.14×10 ⁻¹ | 1.76×10 ⁻¹ | 4.70×10 ⁻² | 7.71×10 ⁻⁴ |
| Mobile retrieval system | 2013 | 2043 | 6.48 | 1.04 | 3.77×10 ⁻³ | b | b | b | b | b | b |

G-298

Table G-135. Tank Closure Alternative 6B, Option Case, Maximum Criteria Pollutant Concentrations of Peak Activity Periods (continued)

| Facility/System | Start Year | End Year | Concentration (micrograms per cubic meter) | | | | | | | | |
|---|------------|----------|--|-----------------------|-----------------------|-----------------------|-----------------------|-----------------------|-----------------------|-----------------------|-----------------------|
| | | | Carbon Monoxide | | Nitrogen Dioxide | PM ₁₀ | | Sulfur Dioxide | | | |
| | | | 1-hour | 8-hour | Annual | 24-hour | Annual | 1-hour | 3-hour | 24-hour | Annual |
| | | | 2016 | 2016 | 2040 | 2016 | 2016 | 2040 | 2040 | 2040 | 2040 |
| Operations (continued) | | | | | | | | | | | |
| Vacuum-based retrieval system | 2013 | 2043 | 3.58 | 5.74×10 ⁻¹ | 2.08×10 ⁻³ | b | b | b | b | b | b |
| Chemical wash system | 2013 | 2043 | 2.38 | 3.81×10 ⁻¹ | 4.26×10 ⁻³ | 1.73 | 1.28×10 ⁻² | 2.36×10 ⁻³ | 8.02×10 ⁻⁴ | 1.64×10 ⁻⁴ | 1.21×10 ⁻⁶ |
| HLW Melter Interim Storage Facility | 2018 | 2199 | a | a | b | a | a | b | b | b | b |
| Effluent Treatment Facility | 2006 | 2100 | 7.85 | 2.41 | 1.02×10 ⁻² | 7.66×10 ¹ | 3.57 | 1.06×10 ⁻² | 6.52×10 ⁻³ | 1.09×10 ⁻³ | 5.08×10 ⁻⁵ |
| Evaporator | 2006 | 2043 | 1.96×10 ⁻³ | 3.03×10 ¹ | 5.77×10 ⁻¹ | 1.86×10 ¹ | 1.75×10 ⁻¹ | 3.09×10 ⁻¹ | 1.11×10 ⁻¹ | 2.09×10 ⁻² | 1.96×10 ⁻⁴ |
| Borrow Area C | 2006 | 2102 | 6.91×10 ⁻² | 2.83×10 ² | 4.42×10 ⁻¹ | 3.98×10 ² | 9.10×10 ⁻¹ | 9.72×10 ⁻¹ | 6.58×10 ⁻¹ | 2.07×10 ⁻¹ | 4.75×10 ⁻⁴ |
| Immobilized Low-Activity Waste Interim Storage Facilities | 2018 | 2199 | a | a | b | a | a | b | b | b | b |
| HLW Debris Storage Facilities | 2023 | 2199 | a | a | b | a | a | b | b | b | b |
| Deactivation | | | | | | | | | | | |
| Mobile retrieval system | 2013 | 2043 | 7.04×10 ⁻² | 1.13×10 ² | 2.83×10 ⁻² | 3.18×10 ⁻¹ | 2.35×10 ⁻³ | 1.69×10 ⁻² | 5.73×10 ⁻³ | 1.17×10 ⁻³ | 8.64×10 ⁻⁶ |
| Vacuum-based retrieval system | 2013 | 2043 | 1.15×10 ¹ | 1.84 | 4.60×10 ⁻⁴ | 5.66×10 ⁻³ | 4.18×10 ⁻⁵ | 2.74×10 ⁻⁴ | 9.32×10 ⁻⁵ | 1.90×10 ⁻⁵ | 1.41×10 ⁻⁷ |
| Chemical wash system | 2013 | 2043 | 3.29×10 ¹ | 5.27 | 2.97×10 ⁻³ | 3.39×10 ⁻² | 2.51×10 ⁻⁴ | 1.85×10 ⁻³ | 6.28×10 ⁻⁴ | 1.28×10 ⁻⁴ | 9.47×10 ⁻⁷ |
| IHLW Interim Storage Facility | 2067 | 2067 | a | a | a | a | a | a | a | a | a |
| Waste Treatment Plant | 2044 | 2045 | a | a | a | a | a | a | a | a | a |
| Cesium and Strontium Capsule Processing Facility | 2041 | 2041 | a | a | a | a | a | a | a | a | a |
| Effluent Treatment Facility original | 2026 | 2026 | a | a | a | a | a | a | a | a | a |
| Effluent Treatment Facility replacement 1 | 2056 | 2056 | a | a | a | a | a | a | a | a | a |
| Effluent Treatment Facility replacement 2 | 2086 | 2086 | a | a | a | a | a | a | a | a | a |
| Effluent Treatment Facility replacement 3 | 2101 | 2101 | a | a | a | a | a | a | a | a | a |
| Evaporator original | 2018 | 2018 | a | a | a | a | a | a | a | a | a |
| Evaporator replacement 1 | 2044 | 2044 | a | a | a | a | a | a | a | a | a |
| Closure | | | | | | | | | | | |
| Containment structure construction 1 | 2019 | 2022 | a | a | a | a | a | a | a | a | a |
| Containment structure construction 2 | 2046 | 2049 | a | a | a | a | a | a | a | a | a |
| Containment structure construction 3 | 2073 | 2076 | a | a | a | a | a | a | a | a | a |
| Containment structure deactivation 1 | 2043 | 2045 | a | a | a | a | a | a | a | a | a |
| Containment structure deactivation 2 | 2070 | 2072 | a | a | a | a | a | a | a | a | a |
| Containment structure deactivation 3 | 2062 | 2064 | a | a | a | a | a | a | a | a | a |
| Containment structure deactivation 4 | 2089 | 2091 | a | a | a | a | a | a | a | a | a |
| Containment structure deactivation 5 | 2097 | 2099 | a | a | a | a | a | a | a | a | a |
| Decontamination and decommissioning of 10 selected facilities | 2018 | 2028 | a | a | a | a | a | a | a | a | a |
| B tank farm removal | 2023 | 2034 | a | a | a | a | a | a | a | a | a |
| T tank farm removal | 2077 | 2088 | a | a | a | a | a | a | a | a | a |

**Table G-135. Tank Closure Alternative 6B, Option Case, Maximum Criteria Pollutant Concentrations
of Peak Activity Periods (continued)**

| Facility/System | Start Year | End Year | Concentration (micrograms per cubic meter) | | | | | | | | |
|---|------------|----------|--|----------------------|-----------------------|----------------------------|----------------------|-----------------------|-----------------------|-----------------------|-----------------------|
| | | | Carbon Monoxide | | Nitrogen Dioxide | PM ₁₀ | | Sulfur Dioxide | | | |
| | | | 1-hour | 8-hour | Annual | 24-hour | Annual | 1-hour | 3-hour | 24-hour | Annual |
| | | | 2016 | 2016 | 2040 | 2016 | 2016 | 2040 | 2040 | 2040 | 2040 |
| Closure (continued) | | | | | | | | | | | |
| BY tank farm removal | 2050 | 2061 | a | a | a | a | a | a | a | a | a |
| BX tank farm removal | 2023 | 2034 | a | a | a | a | a | a | a | a | a |
| C tank farm removal | 2050 | 2061 | a | a | a | a | a | a | a | a | a |
| A tank farm removal | 2077 | 2088 | a | a | a | a | a | a | a | a | a |
| AX tank farm removal | 2077 | 2088 | a | a | a | a | a | a | a | a | a |
| S tank farm removal | 2077 | 2088 | a | a | a | a | a | a | a | a | a |
| TY tank farm removal | 2050 | 2061 | a | a | a | a | a | a | a | a | a |
| TX tank farm removal | 2050 | 2061 | a | a | a | a | a | a | a | a | a |
| U tank farm removal | 2023 | 2034 | a | a | a | a | a | a | a | a | a |
| SX tank farm removal | 2023 | 2034 | a | a | a | a | a | a | a | a | a |
| B tank farm deep soil removal | 2035 | 2042 | a | a | 8.93×10 ⁻² | a | a | 4.78×10 ⁻² | 1.71×10 ⁻² | 3.23×10 ⁻³ | 3.04×10 ⁻⁵ |
| T tank farm deep soil removal | 2089 | 2096 | a | a | a | a | a | a | a | a | a |
| BX tank farm deep soil removal | 2035 | 2042 | a | a | 2.86 | a | a | 1.53 | 5.48×10 ⁻¹ | 1.03×10 ⁻¹ | 9.72×10 ⁻⁴ |
| C tank farm deep soil removal | 2062 | 2069 | a | a | a | a | a | a | a | a | a |
| A tank farm deep soil removal | 2089 | 2096 | a | a | a | a | a | a | a | a | a |
| AX tank farm deep soil removal | 2089 | 2096 | a | a | a | a | a | a | a | a | a |
| TX tank farm deep soil removal | 2062 | 2069 | a | a | a | a | a | a | a | a | a |
| U tank farm deep soil removal | 2035 | 2042 | a | a | 7.42×10 ⁻¹ | a | a | 4.92×10 ⁻¹ | 1.67×10 ⁻¹ | 3.42×10 ⁻² | 2.53×10 ⁻⁴ |
| SX tank farm deep soil removal | 2035 | 2042 | a | a | 1.31 | a | a | 8.92×10 ⁻¹ | 3.43×10 ⁻¹ | 6.98×10 ⁻² | 4.46×10 ⁻⁴ |
| B Area cribs and trenches (ditches) removal | 2035 | 2061 | a | a | 2.40 | a | a | 1.59 | 5.41×10 ⁻¹ | 1.10×10 ⁻¹ | 8.16×10 ⁻⁴ |
| T Area cribs and trenches (ditches) removal | 2062 | 2096 | a | a | a | a | a | a | a | a | a |
| Containment structure construction 1 | 2029 | 2032 | a | a | a | a | a | a | a | a | a |
| Containment structure construction 2 | 2056 | 2059 | a | a | a | a | a | a | a | a | a |
| Containment structure deactivation 1 | 2062 | 2064 | a | a | a | a | a | a | a | a | a |
| Containment structure deactivation 2 | 2097 | 2099 | a | a | a | a | a | a | a | a | a |
| Preprocessing Facility construction | 2020 | 2022 | a | a | a | a | a | a | a | a | a |
| Preprocessing Facility operations | 2023 | 2099 | a | a | 2.50×10 ⁻² | a | a | 3.47 | 1.21 | 3.02×10 ⁻¹ | 5.65×10 ⁻³ |
| Preprocessing Facility deactivation | 2100 | 2100 | a | a | a | a | a | a | a | a | a |
| Total | | | 3.42×10 ⁴ | 5.29×10 ³ | 1.47×10 ¹ | 1.69×10³ | 1.53×10 ¹ | 7.03×10 ¹ | 4.08×10 ¹ | 7.10 | 2.97×10 ⁻¹ |

^a This activity would not contribute to the concentration during the peak year(s) for this pollutant and averaging period.

^b Emissions for this activity and pollutant were not calculated because they would be small compared with those for other activities under this alternative, as explained in Section G.2.

Note: Total concentrations exceeding applicable standards are presented in **bold**.

Key: HLW=high-level radioactive waste; IHLW=immobilized high-level radioactive waste; PM₁₀=particulate matter with an aerodynamic diameter less than or equal to 10 micrometers.

Source: SAIC 2007a, 2008.

Table G-136. Tank Closure Alternative 6B, Option Case, Maximum Toxic Pollutant Concentrations of Peak Activity Periods

| Facility/System | Start Year | End Year | Concentration (micrograms per cubic meter) | | | | | | |
|---|------------|----------|--|-----------------------|-----------------------|-----------------------|----------------------|-----------------------|-----------------------|
| | | | Ammonia | Benzene | 1,3-Butadiene | Formaldehyde | Mercury | Toluene | Xylene |
| | | | 24-hour 2016 | Annual 2035-2038 | Annual 2035-2038 | Annual 2035-2038 | 24-hour 2044-2045 | 24-hour 2016-2017 | 24-hour 2016-2017 |
| Construction | | | | | | | | | |
| Canister Storage Building | 2006 | 2016 | b | a | a | a | a | b | b |
| IHLW Shipping/Transfer Facility and one IHLW Interim Storage Module | 2011 | 2013 | a | a | a | a | a | a | a |
| IHLW Interim Storage Modules, three additional | 2014 | 2022 | b | a | a | a | a | b | b |
| Other infrastructure upgrades | 2006 | 2034 | b | a | a | a | a | b | b |
| Tank upgrades | 2006 | 2025 | 8.81×10 ⁻² | a | a | a | a | b | b |
| Waste Treatment Plant | 2006 | 2017 | 1.29 | a | a | a | a | 1.69 | 5.06×10 ⁻¹ |
| Low-Activity Waste Vitrification Facility | 2008 | 2017 | 3.76×10 ⁻² | a | a | a | a | 1.88×10 ⁻¹ | 5.39×10 ⁻² |
| Cesium and Strontium Capsule Processing Facility | 2035 | 2038 | a | 1.60×10 ⁻³ | 1.87×10 ⁻⁵ | 7.88×10 ⁻⁴ | a | a | a |
| Waste receiver facilities | 2013 | 2017 | b | a | a | a | a | b | b |
| Tank risers | 2013 | 2016 | 2.68 | a | a | a | a | b | b |
| Mobile retrieval system | 2013 | 2043 | 3.90×10 ⁻¹ | b | b | b | a | b | b |
| Vacuum-based retrieval system | 2013 | 2043 | 2.15×10 ⁻¹ | b | b | b | a | b | b |
| Chemical wash system | 2013 | 2043 | 6.05×10 ⁻³ | b | b | b | a | b | b |
| HLW Melter Interim Storage Facility 1 | 2015 | 2016 | b | a | a | a | a | b | b |
| HLW Melter Interim Storage Facility 2 | 2029 | 2030 | a | a | a | a | a | a | a |
| Effluent Treatment Facility replacement 1 | 2023 | 2025 | a | a | a | a | a | a | a |
| Effluent Treatment Facility replacement 2 | 2053 | 2055 | a | a | a | a | a | a | a |
| Effluent Treatment Facility replacement 3 | 2083 | 2085 | a | a | a | a | a | a | a |
| Evaporator replacement 1 | 2015 | 2017 | 6.32×10 ⁻² | a | a | a | a | 4.65×10 ⁻¹ | 1.32×10 ⁻¹ |
| Immobilized Low-Activity Waste Interim Storage Facilities | 2016 | 2043 | 9.56×10 ⁻³ | 1.26×10 ⁻⁵ | b | b | a | 5.64×10 ⁻⁴ | 3.94×10 ⁻⁴ |
| HLW Debris Storage Facilities | 2021 | 2090 | a | 2.75×10 ⁻⁶ | 1.15×10 ⁻⁷ | 3.48×10 ⁻⁶ | b | a | a |
| Underground transfer line 1,000-foot sections | 2009 | 2009 | a | a | a | a | a | a | a |
| Operations | | | | | | | | | |
| IHLW Interim Storage Facility | 2018 | 2066 | a | b | b | b | b | a | a |
| Other infrastructure upgrades | 2006 | 2043 | b | b | b | b | a | b | b |
| Routine operations | 2006 | 2043 | 5.59 | b | b | b | a | b | b |
| Retrieval operations | 2006 | 2043 | 4.60×10 ⁻² | b | b | b | a | b | b |
| Double-shell tank interim stabilization | 2006 | 2043 | 3.02×10 ⁻¹ | b | b | b | a | b | b |
| Waste Treatment Plant | 2018 | 2043 | a | 1.19×10 ⁻⁴ | 4.31×10 ⁻⁸ | 1.33×10 ⁻⁶ | a | a | a |
| Waste Treatment Plant, cesium and strontium capsules | 2040 | 2040 | a | a | a | a | a | a | a |
| Cesium and Strontium Capsule Processing Facility | 2039 | 2040 | a | a | a | a | a | a | a |
| Mobile retrieval system | 2013 | 2043 | 3.90×10 ⁻¹ | b | b | b | a | b | b |
| Vacuum-based retrieval system | 2013 | 2043 | 2.15×10 ⁻¹ | b | b | b | a | b | b |

Table G-136. Tank Closure Alternative 6B, Option Case, Maximum Toxic Pollutant Concentrations of Peak Activity Periods (continued)

| Facility/System | Start Year | End Year | Concentration (micrograms per cubic meter) | | | | | | |
|---|------------|----------|--|-----------------------|-----------------------|-----------------------|-----------------------|-----------------------|-----------------------|
| | | | Ammonia | Benzene | 1,3-Butadiene | Formaldehyde | Mercury | Toluene | Xylene |
| | | | 24-hour 2016 | Annual 2035-2038 | Annual 2035-2038 | Annual 2035-2038 | 24-hour 2044-2045 | 24-hour 2016-2017 | 24-hour 2016-2017 |
| Operations (continued) | | | | | | | | | |
| Chemical wash system | 2013 | 2043 | 6.05×10 ⁻³ | b | b | b | a | b | b |
| HLW Melter Interim Storage Facility | 2018 | 2199 | a | b | b | b | b | a | a |
| Effluent Treatment Facility | 2006 | 2100 | 1.18×10 ⁻¹ | 6.54×10 ⁻⁶ | 1.08×10 ⁻⁷ | 4.03×10 ⁻⁶ | b | 1.53×10 ⁻³ | 4.39×10 ⁻⁴ |
| Evaporator | 2006 | 2043 | 9.64×10 ⁻² | 1.22×10 ⁻⁴ | 5.12×10 ⁻⁶ | 1.54×10 ⁻⁴ | a | 5.69×10 ⁻³ | 3.96×10 ⁻³ |
| Borrow Area C | 2006 | 2102 | 3.08×10 ⁻¹ | 1.24×10 ⁻⁴ | 4.04×10 ⁻⁶ | 1.27×10 ⁻⁴ | b | 2.28×10 ⁻¹ | 7.18×10 ⁻² |
| Immobilized Low-Activity Waste Interim Storage Facilities | 2018 | 2199 | a | b | b | b | b | a | a |
| HLW Debris Storage Facilities | 2023 | 2199 | a | b | b | b | b | a | a |
| Deactivation | | | | | | | | | |
| Mobile retrieval system | 2013 | 2043 | b | b | b | b | a | b | b |
| Vacuum-based retrieval system | 2013 | 2043 | b | b | b | b | a | b | b |
| Chemical wash system | 2013 | 2043 | b | b | b | b | a | b | b |
| IHLW Interim Storage Facility | 2067 | 2067 | a | a | a | a | a | a | a |
| Waste Treatment Plant | 2044 | 2045 | a | a | a | a | 1.17×10 ⁻¹ | a | a |
| Cesium and Strontium Capsule Processing Facility | 2041 | 2041 | a | a | a | a | a | a | a |
| Effluent Treatment Facility original | 2026 | 2026 | a | a | a | a | a | a | a |
| Effluent Treatment Facility replacement 1 | 2056 | 2056 | a | a | a | a | a | a | a |
| Effluent Treatment Facility replacement 2 | 2086 | 2086 | a | a | a | a | a | a | a |
| Effluent Treatment Facility replacement 3 | 2101 | 2101 | a | a | a | a | a | a | a |
| Evaporator original | 2018 | 2018 | a | a | a | a | a | a | a |
| Evaporator replacement | 2044 | 2044 | a | a | a | a | b | a | a |
| Closure | | | | | | | | | |
| Containment structure construction 1 | 2019 | 2022 | a | a | a | a | a | a | a |
| Containment structure construction 2 | 2046 | 2049 | a | a | a | a | a | a | a |
| Containment structure construction 3 | 2073 | 2076 | a | a | a | a | a | a | a |
| Containment structure deactivation 1 | 2043 | 2045 | a | a | a | a | b | a | a |
| Containment structure deactivation 2 | 2070 | 2072 | a | a | a | a | a | a | a |
| Containment structure deactivation 3 | 2062 | 2064 | a | a | a | a | a | a | a |
| Containment structure deactivation 4 | 2089 | 2091 | a | a | a | a | a | a | a |
| Containment structure deactivation 5 | 2097 | 2099 | a | a | a | a | a | a | a |
| Decontamination and decommissioning of 10 selected facilities | 2018 | 2028 | a | a | a | a | a | a | a |
| B tank farm removal | 2023 | 2034 | a | a | a | a | a | a | a |
| T tank farm removal | 2077 | 2088 | a | a | a | a | a | a | a |

G-302

Table G-136. Tank Closure Alternative 6B, Option Case, Maximum Toxic Pollutant Concentrations of Peak Activity Periods (continued)

| Facility/System | Start Year | End Year | Concentration (micrograms per cubic meter) | | | | | | | |
|---|------------|----------|--|-----------------------|------------------------|------------------------|-----------------------|-----------------------|-----------|-----------------------|
| | | | Ammonia | Benzene | 1,3-Butadiene | Formaldehyde | Mercury | Toluene | Xylene | |
| | | | 24-hour | Annual | Annual | Annual | 24-hour | 24-hour | 24-hour | |
| | | | 2016 | 2035-2038 | 2035-2038 | 2035-2038 | 2044-2045 | 2016-2017 | 2016-2017 | |
| Closure (continued) | | | | | | | | | | |
| BY tank farm removal | 2050 | 2061 | a | a | a | a | a | a | a | |
| BX tank farm removal | 2023 | 2034 | a | a | a | a | a | a | a | |
| C tank farm removal | 2050 | 2061 | a | a | a | a | a | a | a | |
| A tank farm removal | 2077 | 2088 | a | a | a | a | a | a | a | |
| AX tank farm removal | 2077 | 2088 | a | a | a | a | a | a | a | |
| S tank farm removal | 2077 | 2088 | a | a | a | a | a | a | a | |
| TY tank farm removal | 2050 | 2061 | a | a | a | a | a | a | a | |
| TX tank farm removal | 2050 | 2061 | a | a | a | a | a | a | a | |
| U tank farm removal | 2023 | 2034 | a | a | a | a | a | a | a | |
| SX tank farm removal | 2023 | 2034 | a | a | a | a | a | a | a | |
| B tank farm deep soil removal | 2035 | 2042 | a | 1.89×10 ⁻⁵ | 7.92×10 ⁻⁷ | 2.39×10 ⁻⁵ | a | a | a | |
| T tank farm deep soil removal | 2089 | 2096 | a | a | a | a | a | a | a | |
| BX tank farm deep soil removal | 2035 | 2042 | a | 6.05×10 ⁻⁴ | 2.53×10 ⁻⁵ | 7.65×10 ⁻⁴ | a | a | a | |
| C tank farm deep soil removal | 2062 | 2069 | a | a | a | a | a | a | a | |
| A tank farm deep soil removal | 2089 | 2096 | a | a | a | a | a | a | a | |
| AX tank farm deep soil removal | 2089 | 2096 | a | a | a | a | a | a | a | |
| TX tank farm deep soil removal | 2062 | 2069 | a | a | a | a | a | a | a | |
| U tank farm deep soil removal | 2035 | 2042 | a | 1.57×10 ⁻⁴ | 6.58×10 ⁻⁶ | 1.99×10 ⁻⁴ | a | a | a | |
| SX tank farm deep soil removal | 2035 | 2042 | a | 2.78×10 ⁻⁴ | 1.16×10 ⁻⁵ | 3.51×10 ⁻⁴ | a | a | a | |
| B Area cribs and trenches (ditches) removal | 2035 | 2061 | a | 5.08×10 ⁻⁴ | 2.13×10 ⁻⁵ | 6.42×10 ⁻⁴ | b | a | a | |
| T Area cribs and trenches (ditches) removal | 2062 | 2096 | a | a | a | a | a | a | a | |
| Containment structure construction 1 | 2029 | 2032 | a | a | a | a | a | a | a | |
| Containment structure construction 2 | 2056 | 2059 | a | a | a | a | a | a | a | |
| Containment structure deactivation 1 | 2062 | 2064 | a | a | a | a | a | a | a | |
| Containment structure deactivation 2 | 2097 | 2099 | a | a | a | a | a | a | a | |
| Preprocessing Facility construction | 2020 | 2022 | a | a | a | a | a | a | a | |
| Preprocessing Facility operations | 2023 | 2099 | a | 2.27×10 ⁻⁷ | 1.39×10 ⁻¹¹ | 7.96×10 ⁻¹⁰ | b | a | a | |
| Preprocessing Facility deactivation | 2100 | 2100 | a | a | a | a | a | a | a | |
| Total | | | | 1.18×10 ¹ | 3.55×10 ⁻³ | 9.38×10 ⁻⁵ | 3.06×10 ⁻³ | 1.17×10 ⁻¹ | 2.58 | 7.69×10 ⁻¹ |

^a This activity would not contribute to the concentration during the peak year(s) for this pollutant and averaging period.

^b Emissions for this activity and pollutant were not calculated because they would be small compared with those for other activities under this alternative, as explained in Section G.2.

Key: HLW=high-level radioactive waste; IHLW=immobilized high-level radioactive waste.

Source: SAIC 2007a, 2008.

**Table G-137. Tank Closure Alternative 6C Maximum Criteria Pollutant Concentrations
of Peak Activity Periods**

| Facility/System | Start Year | End Year | Concentration (micrograms per cubic meter) | | | | | | | | | |
|---|---------------|-------------|--|-----------------------|-----------------------|----------------------|-----------------------|-----------------------|-----------------------|-----------------------|-----------------------|---|
| | | | Carbon Monoxide | | Nitrogen Dioxide | PM ₁₀ | | Sulfur Dioxide | | | | |
| | | | 1-hour | 8-hour | Annual | 24-hour | Annual | 1-hour | 3-hour | 24-hour | Annual | |
| | | | 2040 | 2040 | 2040 | 2040 | 2040 | 2040 | 2040 | 2040 | 2040 | |
| Construction | | | | | | | | | | | | |
| Canister Storage Building | 2006 | 2016 | a | a | a | a | a | a | a | a | a | a |
| IHLW Shipping/Transfer Facility | 2011 | 2013 | a | a | a | a | a | a | a | a | a | a |
| IHLW Interim Storage Modules | 2014 | 2022 | a | a | a | a | a | a | a | a | a | a |
| Other infrastructure upgrades | 2006 | 2034 | a | a | a | a | a | a | a | a | a | a |
| Tank upgrades | 2006 | 2025 | a | a | a | a | a | a | a | a | a | a |
| Waste Treatment Plant | 2006 | 2017 | a | a | a | a | a | a | a | a | a | a |
| Underground transfer line 1,000-foot sections | 2009 | 2009 | a | a | a | a | a | a | a | a | a | a |
| Low-Activity Waste Vitrification Facility | 2008 | 2017 | a | a | a | a | a | a | a | a | a | a |
| Cesium and Strontium Capsule Processing Facility | 2035 | 2038 | a | a | a | a | a | a | a | a | a | a |
| Waste receiver facilities | 2013 | 2017 | a | a | a | a | a | a | a | a | a | a |
| Tank risers | 2013 | 2016 | a | a | a | a | a | a | a | a | a | a |
| Modified sluicing retrieval system | 2013 | 2043 | 1.09×10 ³ | 1.74×10 ² | 2.15×10 ⁻² | 1.61 | 1.19×10 ⁻² | 1.00×10 ⁻² | 3.42×10 ⁻³ | 6.97×10 ⁻⁴ | 5.15×10 ⁻⁶ | |
| Mobile retrieval system | 2013 | 2028 | a | a | a | a | a | a | a | a | a | a |
| Vacuum-based retrieval system | 2029 | 2043 | 1.09×10 ³ | 1.74×10 ² | 2.52×10 ⁻¹ | 6.85 | 5.06×10 ⁻² | 1.56×10 ⁻¹ | 5.32×10 ⁻² | 1.08×10 ⁻² | 8.02×10 ⁻⁵ | |
| HLW Melter Interim Storage Facility 1 | 2015 | 2016 | a | a | a | a | a | a | a | a | a | a |
| HLW Melter Interim Storage Facility 2 | 2029 | 2030 | a | a | a | a | a | a | a | a | a | a |
| Effluent Treatment Facility replacement 1 | 2023 | 2025 | a | a | a | a | a | a | a | a | a | a |
| Evaporator replacement 1 | 2015 | 2017 | a | a | a | a | a | a | a | a | a | a |
| Immobilized Low-Activity Waste Interim Storage Facilities | 2016 | 2043 | 2.29×10 ¹ | 3.22 | 5.95×10 ⁻² | 5.57×10 ¹ | 5.44×10 ⁻¹ | 3.49×10 ⁻² | 1.16×10 ⁻² | 2.00×10 ⁻³ | 1.95×10 ⁻⁵ | |
| Operations | | | | | | | | | | | | |
| IHLW Interim Storage Facility | 2018 | 2066 | b | b | b | b | b | b | b | b | b | b |
| Other infrastructure upgrades | 2006 | 2043 | b | b | b | b | b | b | b | b | b | b |
| Routine operations | 2006 | 2043 | 5.72×10 ¹ | 1.50×10 ¹ | 8.27×10 ⁻² | b | b | b | b | b | b | b |
| Retrieval operations | 2006 | 2043 | 7.66×10 ⁻¹ | 1.23×10 ⁻¹ | 4.45×10 ⁻⁴ | b | b | b | b | b | b | b |
| Double-shell tank interim stabilization | 2006 | 2043 | 5.02 | 8.05×10 ⁻¹ | 2.92×10 ⁻³ | b | b | b | b | b | b | b |
| Waste Treatment Plant | 2018 | 2043 | 2.64×10 ² | 8.11×10 ¹ | 2.80 | 1.04 | 4.86×10 ⁻² | 3.01×10 ¹ | 1.85×10 ¹ | 3.09 | 1.44×10 ⁻¹ | |

G-304

**Table G–137. Tank Closure Alternative 6C Maximum Criteria Pollutant Concentrations
of Peak Activity Periods (continued)**

| Facility/System | Start Year | End Year | Concentration (micrograms per cubic meter) | | | | | | | | |
|--|---------------|-------------|--|----------------------|-----------------------|-----------------------|-----------------------|-----------------------|-----------------------|-----------------------|-----------------------|
| | | | Carbon Monoxide | | Nitrogen Dioxide | PM ₁₀ | | Sulfur Dioxide | | | |
| | | | 1-hour | 8-hour | Annual | 24-hour | Annual | 1-hour | 3-hour | 24-hour | Annual |
| | | | 2040 | 2040 | 2040 | 2040 | 2040 | 2040 | 2040 | 2040 | 2040 |
| Operations (continued) | | | | | | | | | | | |
| Waste Treatment Plant, cesium and strontium capsules | 2040 | 2040 | 2.64×10 ² | 8.11×10 ¹ | 2.80 | 1.04 | 4.86×10 ⁻² | 3.01×10 ¹ | 1.85×10 ¹ | 3.09 | 1.44×10 ⁻¹ |
| Cesium and Strontium Capsule Processing Facility | 2039 | 2040 | 3.84×10 ² | 6.26×10 ¹ | 1.53×10 ⁻² | 4.00×10 ¹ | 6.56×10 ⁻¹ | 5.14×10 ⁻¹ | 1.76×10 ⁻¹ | 4.70×10 ⁻² | 7.71×10 ⁻⁴ |
| Modified sluicing retrieval system | 2013 | 2043 | 3.01×10 ² | 4.83×10 ¹ | 9.60×10 ⁻³ | 9.98×10 ⁻² | 7.38×10 ⁻⁴ | 4.80×10 ⁻³ | 1.63×10 ⁻³ | 3.33×10 ⁻⁴ | 2.46×10 ⁻⁶ |
| Mobile retrieval system | 2013 | 2028 | a | a | a | a | a | a | a | a | a |
| Vacuum-based retrieval system | 2029 | 2043 | 7.41 | 1.19 | 4.30×10 ⁻³ | b | b | b | b | b | b |
| HLW Melter Interim Storage Facility | 2018 | 2145 | b | b | b | b | b | b | b | b | b |
| Effluent Treatment Facility | 2006 | 2045 | 7.85 | 2.41 | 1.02×10 ⁻² | 7.66×10 ¹ | 3.57 | 1.06×10 ⁻² | 6.52×10 ⁻³ | 1.09×10 ⁻³ | 5.08×10 ⁻⁵ |
| Evaporator | 2006 | 2043 | 2.00×10 ² | 3.09×10 ¹ | 5.88×10 ⁻¹ | 1.87×10 ¹ | 1.76×10 ⁻¹ | 3.15×10 ⁻¹ | 1.13×10 ⁻¹ | 2.13×10 ⁻² | 2.00×10 ⁻⁴ |
| Borrow Area C | 2006 | 2052 | 6.91×10 ² | 2.83×10 ² | 4.42×10 ⁻¹ | 3.98×10 ² | 9.10×10 ⁻¹ | 9.72×10 ⁻¹ | 6.58×10 ⁻¹ | 2.07×10 ⁻¹ | 4.75×10 ⁻⁴ |
| Immobilized Low-Activity Waste Interim Storage Facilities | 2018 | 2145 | b | b | b | b | b | b | b | b | b |
| Deactivation | | | | | | | | | | | |
| IHLW Interim Storage Facility | 2067 | 2067 | a | a | a | a | a | a | a | a | a |
| Waste Treatment Plant | 2044 | 2045 | a | a | a | a | a | a | a | a | a |
| Cesium and Strontium Capsule Processing Facility | 2041 | 2041 | a | a | a | a | a | a | a | a | a |
| Effluent Treatment Facility original | 2026 | 2026 | a | a | a | a | a | a | a | a | a |
| Effluent Treatment Facility replacement 1 | 2046 | 2046 | a | a | a | a | a | a | a | a | a |
| Evaporator original | 2018 | 2018 | a | a | a | a | a | a | a | a | a |
| Evaporator replacement 1 | 2044 | 2044 | a | a | a | a | a | a | a | a | a |
| Modified sluicing retrieval system | 2013 | 2043 | 7.73×10 ² | 1.24×10 ² | 1.67×10 ⁻² | 2.00×10 ⁻¹ | 1.48×10 ⁻³ | 9.60×10 ⁻³ | 3.26×10 ⁻³ | 6.66×10 ⁻⁴ | 4.92×10 ⁻⁶ |
| Mobile retrieval system | 2013 | 2028 | a | a | a | a | a | a | a | a | a |
| Vacuum-based retrieval system | 2029 | 2043 | 2.37×10 ¹ | 3.79 | 9.51×10 ⁻⁴ | 1.17×10 ⁻² | 8.65×10 ⁻⁵ | 5.66×10 ⁻⁴ | 1.93×10 ⁻⁴ | 3.93×10 ⁻⁵ | 2.90×10 ⁻⁷ |
| Closure | | | | | | | | | | | |
| Ancillary equipment grouting | 2013 | 2037 | a | a | a | a | a | a | a | a | a |
| Ancillary equipment removal | 2032 | 2037 | a | a | a | a | a | a | a | a | a |
| Decontamination and decommissioning of 10 selected facilities | 2018 | 2028 | a | a | a | a | a | a | a | a | a |

Table G-137. Tank Closure Alternative 6C Maximum Criteria Pollutant Concentrations of Peak Activity Periods (continued)

| Facility/System | Start Year | End Year | Concentration (micrograms per cubic meter) | | | | | | | | |
|---|------------|----------|--|----------------------|-----------------------|----------------------------|-----------------------|-----------------------|-----------------------|-----------------------|-----------------------|
| | | | Carbon Monoxide | | Nitrogen Dioxide | PM ₁₀ | | Sulfur Dioxide | | | |
| | | | 1-hour | 8-hour | Annual | 24-hour | Annual | 1-hour | 3-hour | 24-hour | Annual |
| | | | 2040 | 2040 | 2040 | 2040 | 2040 | 2040 | 2040 | 2040 | 2040 |
| Closure (continued) | | | | | | | | | | | |
| Tank-filling grout facility construction | 2032 | 2033 | a | a | a | a | a | a | a | a | a |
| Tank-filling grout facility operations | 2034 | 2043 | 3.66×10 ² | 5.86×10 ¹ | 6.92×10 ⁻¹ | 5.08×10 ¹ | 3.76×10 ⁻¹ | 4.39×10 ⁻¹ | 1.49×10 ⁻¹ | 3.04×10 ⁻² | 2.25×10 ⁻⁴ |
| Tank-filling grout facility deactivation | 2044 | 2044 | a | a | a | a | a | a | a | a | a |
| Containment structure construction | 2028 | 2031 | a | a | a | a | a | a | a | a | a |
| BX and SX tank farm soil removal | 2032 | 2037 | a | a | a | a | a | a | a | a | a |
| Containment structure deactivation | 2038 | 2040 | 1.47×10 ³ | 2.35×10 ² | 7.82×10 ⁻² | 3.48 | 2.58×10 ⁻² | 4.74×10 ⁻² | 1.61×10 ⁻² | 3.29×10 ⁻³ | 2.43×10 ⁻⁵ |
| Modified Resource Conservation and Recovery Act Subtitle C barrier construction | 2039 | 2045 | 2.66×10 ⁴ | 4.26×10 ³ | 1.25×10 ¹ | 3.91×10 ³ | 2.89×10 ¹ | 3.68×10 ¹ | 1.25×10 ¹ | 2.55 | 1.89×10 ⁻² |
| Postclosure care | 2046 | 2145 | a | a | a | a | a | a | a | a | a |
| Total | | | 3.36×10 ⁴ | 5.64×10 ³ | 2.04×10 ¹ | 4.57×10³ | 3.53×10 ¹ | 9.95×10 ¹ | 5.06×10 ¹ | 9.05 | 3.08×10 ⁻¹ |

^a This activity would not contribute to the concentration during the peak year(s) for this pollutant and averaging period.

^b Emissions for this activity and pollutant were not calculated because they would be small compared with those for other activities under this alternative, as explained in Section G.2.

Note: Total concentrations exceeding applicable standards are presented in **bold**.

Key: HLW=high-level radioactive waste; IHLW=immobilized high-level radioactive waste; PM₁₀=particulate matter with an aerodynamic diameter less than or equal to 10 micrometers.

Source: SAIC 2007a, 2008.

**Table G-138. Tank Closure Alternative 6C Maximum Toxic Pollutant Concentrations
of Peak Activity Periods**

| Facility/System | Start Year | End Year | Concentration (micrograms per cubic meter) | | | | | | |
|---|---------------|-------------|--|-----------------------|-----------------------|-----------------------|-----------|-----------------------|-----------------------|
| | | | Ammonia | Benzene | 1,3-Butadiene | Formaldehyde | Mercury | Toluene | Xylene |
| | | | 24-hour | Annual | Annual | Annual | 24-hour | 24-hour | 24-hour |
| | | | 2016 | 2040 | 2040 | 2040 | 2044-2045 | 2040 | 2040 |
| Construction | | | | | | | | | |
| Canister Storage Building | 2006 | 2016 | b | a | a | a | a | a | a |
| IHLW Shipping/Transfer Facility | 2011 | 2013 | a | a | a | a | a | a | a |
| IHLW Interim Storage Modules | 2014 | 2022 | b | a | a | a | a | a | a |
| Other infrastructure upgrades | 2006 | 2034 | b | a | a | a | a | a | a |
| Tank upgrades | 2006 | 2025 | 8.81×10 ⁻² | a | a | a | a | a | a |
| Waste Treatment Plant | 2006 | 2017 | 1.29 | a | a | a | a | a | a |
| Underground transfer line 1,000-foot sections | 2009 | 2009 | a | a | a | a | a | a | a |
| Low-Activity Waste Vitrification Facility | 2008 | 2017 | 3.76×10 ⁻² | a | a | a | a | a | a |
| Cesium and Strontium Capsule Processing Facility | 2035 | 2038 | a | a | a | a | a | a | a |
| Waste receiver facilities | 2013 | 2017 | b | a | a | a | a | a | a |
| Tank risers | 2013 | 2016 | 2.46 | a | a | a | a | a | a |
| Modified sluicing retrieval system | 2013 | 2043 | 2.44×10 ⁻¹ | b | b | b | a | b | b |
| Mobile retrieval system | 2013 | 2028 | 2.81×10 ⁻¹ | a | a | a | a | a | a |
| Vacuum-based retrieval system | 2029 | 2043 | a | b | b | b | a | b | b |
| HLW Melter Interim Storage Facility 1 | 2015 | 2016 | b | a | a | a | a | a | a |
| HLW Melter Interim Storage Facility 2 | 2029 | 2030 | a | a | a | a | a | a | a |
| Effluent Treatment Facility replacement 1 | 2023 | 2025 | a | a | a | a | a | a | a |
| Evaporator replacement 1 | 2015 | 2017 | 1.49×10 ⁻² | a | a | a | a | a | a |
| Immobilized Low-Activity Waste Interim Storage Facilities | 2016 | 2043 | 9.56×10 ⁻³ | 1.26×10 ⁻⁵ | b | b | a | 5.64×10 ⁻⁴ | 3.94×10 ⁻⁴ |
| Operations | | | | | | | | | |
| IHLW Interim Storage Facility | 2018 | 2066 | a | b | b | b | b | b | b |
| Other infrastructure upgrades | 2006 | 2043 | b | b | b | b | a | b | b |
| Routine operations | 2006 | 2043 | 5.59 | b | b | b | a | b | b |
| Retrieval operations | 2006 | 2043 | 4.60×10 ⁻² | b | b | b | a | b | b |
| Double-shell tank interim stabilization | 2006 | 2043 | 3.02×10 ⁻¹ | b | b | b | a | b | b |
| Waste Treatment Plant | 2018 | 2043 | a | 1.19×10 ⁻⁴ | 4.31×10 ⁻⁸ | 1.33×10 ⁻⁶ | a | 7.21×10 ⁻⁵ | 2.43×10 ⁻⁴ |

**Table G-138. Tank Closure Alternative 6C Maximum Toxic Pollutant Concentrations
of Peak Activity Periods (continued)**

| Facility/System | Start Year | End Year | Concentration (micrograms per cubic meter) | | | | | | |
|---|------------|----------|--|-----------------------|-----------------------|-----------------------|-----------------------|-----------------------|-----------------------|
| | | | Ammonia | Benzene | 1,3-Butadiene | Formaldehyde | Mercury | Toluene | Xylene |
| | | | 24-hour | Annual | Annual | Annual | 24-hour | 24-hour | 24-hour |
| | | | 2016 | 2040 | 2040 | 2040 | 2044-2045 | 2040 | 2040 |
| Operations (continued) | | | | | | | | | |
| Waste Treatment Plant, cesium and strontium capsules | 2040 | 2040 | a | 1.19×10 ⁻⁴ | 4.31×10 ⁻⁸ | 1.33×10 ⁻⁶ | a | 7.21×10 ⁻⁵ | 2.43×10 ⁻⁴ |
| Cesium and Strontium Capsule Processing Facility | 2039 | 2040 | a | 7.41×10 ⁻⁵ | 4.19×10 ⁻⁷ | 2.51×10 ⁻⁵ | a | 6.94×10 ⁻² | 1.96×10 ⁻² |
| Modified sluicing retrieval system | 2013 | 2043 | 2.44×10 ⁻¹ | b | b | b | a | b | b |
| Mobile retrieval system | 2013 | 2028 | 2.81×10 ⁻¹ | a | a | a | a | a | a |
| Vacuum-based retrieval system | 2029 | 2043 | a | b | b | b | a | b | b |
| HLW Melter Interim Storage Facility | 2018 | 2145 | a | b | b | b | b | b | b |
| Effluent Treatment Facility | 2006 | 2045 | 1.18×10 ⁻¹ | 6.54×10 ⁻⁶ | 1.08×10 ⁻⁷ | 4.03×10 ⁻⁶ | b | 1.53×10 ⁻³ | 4.39×10 ⁻⁴ |
| Evaporator | 2006 | 2043 | 9.82×10 ⁻² | 1.24×10 ⁻⁴ | 5.22×10 ⁻⁶ | 1.57×10 ⁻⁴ | a | 5.79×10 ⁻³ | 4.04×10 ⁻³ |
| Borrow Area C | 2006 | 2052 | 3.08×10 ⁻¹ | 1.24×10 ⁻⁴ | 4.04×10 ⁻⁶ | 1.27×10 ⁻⁴ | b | 2.28×10 ⁻¹ | 7.18×10 ⁻² |
| Immobilized Low-Activity Waste Interim Storage Facilities | 2018 | 2145 | a | b | b | b | b | b | b |
| Deactivation | | | | | | | | | |
| IHLW Interim Storage Facility | 2067 | 2067 | a | a | a | a | a | a | a |
| Waste Treatment Plant | 2044 | 2045 | a | a | a | a | 1.17×10 ⁻¹ | a | a |
| Cesium and Strontium Capsule Processing Facility | 2041 | 2041 | a | a | a | a | a | a | a |
| Effluent Treatment Facility original | 2026 | 2026 | a | a | a | a | a | a | a |
| Effluent Treatment Facility replacement 1 | 2046 | 2046 | a | a | a | a | a | a | a |
| Evaporator original | 2018 | 2018 | a | a | a | a | a | a | a |
| Evaporator replacement 1 | 2044 | 2044 | a | a | a | a | b | a | a |
| Modified sluicing retrieval system | 2013 | 2043 | b | b | b | b | a | b | b |
| Mobile retrieval system | 2013 | 2028 | b | a | a | a | a | a | a |
| Vacuum-based retrieval system | 2029 | 2043 | a | b | b | b | a | b | b |
| Closure | | | | | | | | | |
| Ancillary equipment grouting | 2013 | 2037 | 3.03×10 ⁻⁵ | a | a | a | a | a | a |
| Ancillary equipment removal | 2032 | 2037 | a | a | a | a | a | a | a |
| Decontamination and decommissioning of 10 selected facilities | 2018 | 2028 | a | a | a | a | a | a | a |

**Table G-138. Tank Closure Alternative 6C Maximum Toxic Pollutant Concentrations
of Peak Activity Periods (continued)**

| Facility/System | Start Year | End Year | Concentration (micrograms per cubic meter) | | | | | | |
|--|---------------|-------------|--|-----------------------|-----------------------|-----------------------|-----------------------|---------|-----------------------|
| | | | Ammonia | Benzene | 1,3-Butadiene | Formaldehyde | Mercury | Toluene | Xylene |
| | | | 24-hour | Annual | Annual | Annual | 24-hour | 24-hour | 24-hour |
| | | | 2016 | 2040 | 2040 | 2040 | 2044-2045 | 2040 | 2040 |
| Closure (continued) | | | | | | | | | |
| Tank-filling grout facility construction | 2032 | 2033 | a | a | a | a | a | a | a |
| Tank-filling grout facility operations | 2034 | 2043 | a | b | b | b | a | b | b |
| Tank-filling grout facility deactivation | 2044 | 2044 | a | a | a | a | b | a | a |
| Containment structure construction | 2028 | 2031 | a | a | a | a | a | a | a |
| BX and SX tank farm soil removal | 2032 | 2037 | a | a | a | a | a | a | a |
| Containment structure deactivation | 2038 | 2040 | a | b | b | b | a | b | b |
| Modified Resource Conservation and Recovery Act Subtitle C barrier construction | 2039 | 2045 | a | 4.00×10 ⁻³ | 1.16×10 ⁻⁴ | 3.74×10 ⁻³ | b | 3.09 | 9.37×10 ⁻¹ |
| Postclosure care | 2046 | 2145 | a | a | a | a | a | a | a |
| Total | | | 1.14×10 ¹ | 4.58×10 ⁻³ | 1.26×10 ⁻⁴ | 4.06×10 ⁻³ | 1.17×10 ⁻¹ | 3.40 | 1.03 |

^a This activity would not contribute to the concentration during the peak year(s) for this pollutant and averaging period.

^b Emissions for this activity and pollutant were not calculated because they would be small compared with those for other activities under this alternative, as explained in Section G.2.

Key: HLW=high-level radioactive waste; IHLW=immobilized high-level radioactive waste.

Source: SAIC 2007a, 2008.

Table G-139. FFTF Decommissioning Alternative 1 Maximum Criteria Pollutant Concentrations of Peak Activity Periods

| Facility/System | Start Year | End Year | Concentration (micrograms per cubic meter) | | | | | | | | |
|-------------------------|------------|----------|--|-----------|-----------------------|-----------------------|-----------------------|-----------------------|-----------------------|-----------------------|-----------------------|
| | | | Carbon Monoxide | | Nitrogen Dioxide | PM ₁₀ | | Sulfur Dioxide | | | |
| | | | 1-hour | 8-hour | Annual | 24-hour | Annual | 1-hour | 3-hour | 24-hour | Annual |
| | | | 2008-2107 | 2008-2107 | 2008-2107 | 2008-2107 | 2008-2107 | 2008-2107 | 2008-2107 | 2008-2107 | 2008-2107 |
| Deactivation | | | | | | | | | | | |
| Administrative controls | 2008 | 2107 | 3.13×10 ¹ | 4.35 | 6.44×10 ⁻⁴ | 2.72×10 ⁻³ | 3.95×10 ⁻⁵ | 4.19×10 ⁻² | 1.40×10 ⁻² | 2.29×10 ⁻³ | 3.32×10 ⁻⁵ |
| Total | | | 3.13×10 ¹ | 4.35 | 6.44×10 ⁻⁴ | 2.72×10 ⁻³ | 3.95×10 ⁻⁵ | 4.19×10 ⁻² | 1.40×10 ⁻² | 2.29×10 ⁻³ | 3.32×10 ⁻⁵ |

Key: FFTF=Fast Flux Test Facility; PM₁₀=particulate matter with an aerodynamic diameter less than or equal to 10 micrometers.

Source: SAIC 2007b.

Table G-140. FFTF Decommissioning Alternative 1 Maximum Toxic Pollutant Concentrations of Peak Activity Periods

| Facility/System | Start Year | End Year | Concentration (micrograms per cubic meter) | | | | | | |
|-------------------------|------------|----------|--|-----------------------|-----------------------|-----------------------|---------|-----------------------|-----------------------|
| | | | Ammonia | Benzene | 1,3-Butadiene | Formaldehyde | Mercury | Toluene | Xylene |
| | | | 24-hour | Annual | Annual | Annual | 24-hour | 24-hour | 24-hour |
| | | | 2008-2107 | 2008-2107 | 2008-2107 | 2008-2107 | c | 2008-2107 | 2008-2107 |
| Deactivation | | | | | | | | | |
| Administrative controls | 2008 | 2107 | 1.32×10 ⁻⁴ | 3.19×10 ⁻⁶ | 1.79×10 ⁻⁸ | 1.07×10 ⁻⁶ | b | 3.38×10 ⁻³ | 9.54×10 ⁻⁴ |
| Total | | | 1.32×10 ⁻⁴ | 3.19×10 ⁻⁶ | 1.79×10 ⁻⁸ | 1.07×10 ⁻⁶ | 0 | 3.38×10 ⁻³ | 9.54×10 ⁻⁴ |

^a This activity would not contribute to the concentration during the peak year(s) for this pollutant and averaging period.

^b Emissions for this activity and pollutant were not calculated because they would be small compared with those for other activities under this alternative, as explained in Section G.2.

^c There is no peak year because no emissions were calculated.

Key: FFTF=Fast Flux Test Facility.

Source: SAIC 2007b.

Table G-141. FFTF Decommissioning Alternative 2 Maximum Criteria Pollutant Concentrations of Peak Hanford Site Activity Periods

| Facility/System | Start Year | End Year | Concentration (micrograms per cubic meter) | | | | | | | | | |
|---|------------|----------|--|-----------------------|-----------------------|-----------------------|-----------------------|-----------------------|-----------------------|-----------------------|-----------------------|--|
| | | | Carbon Monoxide | | Nitrogen Dioxide | PM ₁₀ | | Sulfur Dioxide | | | | |
| | | | 1-hour | 8-hour | Annual | 24-hour | Annual | 1-hour | 3-hour | 24-hour | Annual | |
| | | | 2016 | 2016 | 2021 | 2016 | 2016 | 2016 | 2016 | 2016 | 2016 | |
| Decommissioning | | | | | | | | | | | | |
| Above-grade structure and equipment removal | 2013 | 2020 | 3.13×10 ² | 4.36×10 ¹ | a | 1.85×10 ¹ | 2.68×10 ⁻¹ | 4.35×10 ⁻¹ | 1.45×10 ⁻¹ | 2.38×10 ⁻² | 3.45×10 ⁻⁴ | |
| Backfill of Reactor Containment Building with grout | 2017 | 2017 | a | a | a | a | a | a | a | a | a | |
| Backfill of Buildings 491 East and West with grout | 2017 | 2017 | a | a | a | a | a | a | a | a | a | |
| Grout facility construction | 2016 | 2016 | 1.22×10 ² | 1.69×10 ¹ | a | 1.28×10 ¹ | 1.86×10 ⁻¹ | 3.02×10 ¹ | 1.01×10 ¹ | 1.65 | 2.39×10 ⁻² | |
| Grout facility operations | 2017 | 2017 | a | a | a | a | a | a | a | a | a | |
| Grout facility deactivation | 2018 | 2018 | a | a | a | a | a | a | a | a | a | |
| Nonhazardous waste transportation | 2013 | 2020 | 1.22×10 ⁻¹ | 1.70×10 ⁻² | a | 2.18×10 ⁻³ | 3.16×10 ⁻⁵ | 1.93×10 ⁻⁴ | 6.43×10 ⁻⁵ | 1.05×10 ⁻⁵ | 1.53×10 ⁻⁷ | |
| Construction | | | | | | | | | | | | |
| Sodium Reactor Facility | 2015 | 2016 | 5.16×10 ³ | 7.19×10 ² | a | 2.25×10 ¹ | 3.26×10 ⁻¹ | 6.97 | 2.32 | 3.81×10 ⁻¹ | 5.52×10 ⁻³ | |
| Remote Treatment Project | 2015 | 2016 | 3.93×10 ¹ | 5.47 | a | 4.19×10 ¹ | 6.08×10 ⁻¹ | 6.20×10 ⁻² | 2.07×10 ⁻² | 3.39×10 ⁻³ | 4.91×10 ⁻⁵ | |
| Operations | | | | | | | | | | | | |
| Sodium preparation | 2017 | 2017 | a | a | a | a | a | a | a | a | a | |
| Sodium Reactor Facility | 2017 | 2018 | a | a | a | a | a | a | a | a | a | |
| Remote Treatment Project | 2017 | 2017 | a | a | a | a | a | a | a | a | a | |
| Deactivation | | | | | | | | | | | | |
| Sodium Reactor Facility | 2019 | 2019 | a | a | a | a | a | a | a | a | a | |
| Remote Treatment Project | 2018 | 2018 | a | a | a | a | a | a | a | a | a | |
| Closure | | | | | | | | | | | | |
| Site regrading | 2021 | 2021 | a | a | 1.33 | a | a | a | a | a | a | |
| Site revegetation | 2021 | 2021 | a | a | 2.00×10 ⁻² | a | a | a | a | a | a | |
| Modified Resource Conservation and Recovery Act Subtitle C barrier construction | 2021 | 2021 | a | a | 1.49 | a | a | a | a | a | a | |
| Postclosure care | 2022 | 2121 | a | a | a | a | a | a | a | a | a | |
| Total | | | 5.64×10 ³ | 7.85×10 ² | 2.84 | 9.58×10 ¹ | 1.39 | 3.76×10 ¹ | 1.25×10 ¹ | 2.06 | 2.98×10 ⁻² | |

^a This activity would not contribute to the concentration during the peak year(s) for this pollutant and averaging period.

Key: FFTF=Fast Flux Test Facility; PM₁₀=particulate matter with an aerodynamic diameter less than or equal to 10 micrometers.

Source: SAIC 2007b.

Table G-142. FFTF Decommissioning Alternative 2 Maximum Toxic Pollutant Concentrations of Peak Hanford Site Activity Periods

| Facility/System | Start Year | End Year | Concentration (micrograms per cubic meter) | | | | | | | |
|---|------------|----------|--|-----------------------|-----------------------|-----------------------|---------|----------------------|-----------|------|
| | | | Ammonia | Benzene | 1,3-Butadiene | Formaldehyde | Mercury | Toluene | Xylene | |
| | | | 24-hour | Annual | Annual | Annual | 24-hour | 24-hour | 24-hour | |
| | | | 2016 | 2022-2121 | 2017 | 2022-2121 | c | 2022-2121 | 2022-2121 | |
| Decommissioning | | | | | | | | | | |
| Above-grade structure and equipment removal | 2013 | 2020 | 2.63×10 ⁻² | a | 2.21×10 ⁻⁶ | a | a | a | a | a |
| Backfill of Reactor Containment Building with grout | 2017 | 2017 | a | a | 1.19×10 ⁻⁶ | a | a | a | a | a |
| Backfill of Buildings 491 East and West with grout | 2017 | 2017 | a | a | 7.72×10 ⁻⁷ | a | a | a | a | a |
| Grout facility construction | 2016 | 2016 | 1.70×10 ⁻¹ | a | a | a | a | a | a | a |
| Grout facility operations | 2017 | 2017 | a | a | 2.19×10 ⁻⁴ | a | a | a | a | a |
| Grout facility deactivation | 2018 | 2018 | a | a | a | a | a | a | a | a |
| Nonhazardous waste transportation | 2013 | 2020 | 4.87×10 ⁻⁵ | a | 3.98×10 ⁻⁹ | a | a | a | a | a |
| Construction | | | | | | | | | | |
| Sodium Reactor Facility | 2015 | 2016 | 1.40×10 ¹ | a | a | a | a | a | a | a |
| Remote Treatment Project | 2015 | 2016 | 1.57×10 ⁻² | a | a | a | a | a | a | a |
| Operations | | | | | | | | | | |
| Sodium preparation | 2017 | 2017 | a | a | b | a | a | a | a | a |
| Sodium Reactor Facility | 2017 | 2018 | a | a | b | a | a | a | a | a |
| Remote Treatment Project | 2017 | 2017 | a | a | b | a | a | a | a | a |
| Deactivation | | | | | | | | | | |
| Sodium Reactor Facility | 2019 | 2019 | a | a | a | a | a | a | a | a |
| Remote Treatment Project | 2018 | 2018 | a | a | a | a | a | a | a | a |
| Closure | | | | | | | | | | |
| Site regrading | 2021 | 2021 | a | a | a | a | a | a | a | a |
| Site revegetation | 2021 | 2021 | a | a | a | a | a | a | a | a |
| Modified Resource Conservation and Recovery Act Subtitle C barrier construction | 2021 | 2021 | a | a | a | a | a | a | a | a |
| Postclosure care | 2022 | 2121 | a | 1.06×10 ⁻² | a | 3.58×10 ⁻³ | a | 1.13×10 ¹ | 3.18 | 3.18 |
| Total | | | 1.42×10 ¹ | 1.06×10 ⁻² | 2.23×10 ⁻⁴ | 3.58×10 ⁻³ | 0 | 1.13×10 ¹ | 3.18 | 3.18 |

^a This activity would not contribute to the concentration during the peak year(s) for this pollutant and averaging period.

^b Emissions for this activity and pollutant were not calculated because they would be small compared with those for other activities under this alternative, as explained in Section G.2.

^c There is no peak year because no emissions were calculated.

Key: FFTF=Fast Flux Test Facility.

Source: SAIC 2007b.

Table G-143. FFTF Decommissioning Alternative 3 Maximum Criteria Pollutant Concentrations of Peak Hanford Site Activity Periods

| Facility/System | Start Year | End Year | Concentration (micrograms per cubic meter) | | | | | | | | |
|---|------------|----------|--|-----------------------|-----------------------|-----------------------|-----------------------|----------------------|----------------------|-----------------|-----------------------|
| | | | Carbon Monoxide | | Nitrogen Dioxide | PM ₁₀ | | Sulfur Dioxide | | | |
| | | | 1-hour 2015 | 8-hour 2015 | Annual 2018 | 24-hour 2015 | Annual 2015 | 1-hour 2012 | 3-hour 2012 | 24-hour 2012 | Annual 2012 |
| Decommissioning | | | | | | | | | | | |
| Above-grade structure and equipment removal | 2013 | 2020 | 3.13×10 ² | 4.36×10 ¹ | 2.38×10 ⁻¹ | 1.85×10 ¹ | 2.68×10 ⁻¹ | a | a | a | a |
| Removal of Reactor Containment Building below-grade vessels, piping, and components | 2013 | 2014 | a | a | a | a | a | a | a | a | a |
| Grout facility construction | 2012 | 2012 | a | a | a | a | a | 5.04×10 ¹ | 1.68×10 ¹ | 2.75 | 3.99×10 ⁻² |
| Grout facility operations | 2013 | 2014 | a | a | a | a | a | a | a | a | a |
| Grout facility deactivation | 2015 | 2015 | 6.78×10 ¹ | 9.43 | a | 5.35×10 ¹ | 7.75×10 ⁻¹ | a | a | a | a |
| Nonhazardous waste transportation | 2013 | 2020 | 1.22×10 ⁻¹ | 1.70×10 ⁻² | 4.49×10 ⁻⁴ | 2.18×10 ⁻³ | 3.16×10 ⁻⁵ | a | a | a | a |
| Construction | | | | | | | | | | | |
| Sodium Reactor Facility | 2015 | 2016 | 5.16×10 ³ | 7.19×10 ² | a | 2.25×10 ¹ | 3.26×10 ⁻¹ | a | a | a | a |
| Remote Treatment Project | 2015 | 2016 | 3.93×10 ¹ | 5.47 | a | 4.19×10 ¹ | 6.08×10 ⁻¹ | a | a | a | a |
| Operations | | | | | | | | | | | |
| Sodium preparation | 2017 | 2017 | a | a | a | a | a | a | a | a | a |
| Sodium Reactor Facility | 2017 | 2018 | a | a | b | a | a | a | a | a | a |
| Remote Treatment Project | 2017 | 2017 | a | a | a | a | a | a | a | a | a |
| Deactivation | | | | | | | | | | | |
| Sodium Reactor Facility | 2019 | 2019 | a | a | a | a | a | a | a | a | a |
| Remote Treatment Project | 2018 | 2018 | a | a | b | a | a | a | a | a | a |
| Closure | | | | | | | | | | | |
| Site regrading | 2018 | 2018 | a | a | 1.77 | a | a | a | a | a | a |
| Site revegetation | 2018 | 2018 | a | a | 2.26×10 ⁻² | a | a | a | a | a | a |
| Postclosure care | 2022 | 2121 | a | a | a | a | a | a | a | a | a |
| Total | | | 5.58×10 ³ | 7.77×10 ² | 2.04 | 1.36×10 ² | 1.98 | 5.04×10 ¹ | 1.68×10 ¹ | 2.75 | 3.99×10 ⁻² |

^a This activity would not contribute to the concentration during the peak year(s) for this pollutant and averaging period.

^b Emissions for this activity and pollutant were not calculated because they would be small compared with those for other activities under this alternative, as explained in Section G.2.

Key: FFTF=Fast Flux Test Facility; PM₁₀=particulate matter with an aerodynamic diameter less than or equal to 10 micrometers.

Source: SAIC 2007b.

**Table G-144. FFTF Decommissioning Alternative 3 Maximum Toxic Pollutant Concentrations
of Peak Hanford Site Activity Periods**

| Facility/System | Start Year | End Year | Concentration (micrograms per cubic meter) | | | | | | |
|---|---------------|-------------|--|-----------------------|-----------------------|-----------------------|--------------|----------------------|----------------------|
| | | | Ammonia | Benzene | 1,3-Butadiene | Formaldehyde | Mercury | Toluene | Xylene |
| | | | 24-hour 2015–2016 | Annual 2022–2121 | Annual 2013–2014 | Annual 2022–2121 | 24-hour c | 24-hour 2022–2121 | 24-hour 2022–2121 |
| Decommissioning | | | | | | | | | |
| Above-grade structure and equipment removal | 2013 | 2020 | 2.63×10^{-2} | a | 2.21×10^{-6} | a | a | a | a |
| Removal of Reactor Containment Building below-grade vessels, piping, and components | 2013 | 2014 | a | a | 3.79×10^{-6} | a | a | a | a |
| Grout facility construction | 2012 | 2012 | a | a | a | a | a | a | a |
| Grout facility operations | 2013 | 2014 | a | a | 1.10×10^{-4} | a | a | a | a |
| Grout facility deactivation | 2015 | 2015 | b | a | a | a | a | a | a |
| Nonhazardous waste transportation | 2013 | 2020 | 4.87×10^{-5} | a | 3.98×10^{-9} | a | a | a | a |
| Construction | | | | | | | | | |
| Sodium Reactor Facility | 2015 | 2016 | 1.40×10^1 | a | a | a | a | a | a |
| Remote Treatment Project | 2015 | 2016 | 1.57×10^{-2} | a | a | a | a | a | a |
| Operations | | | | | | | | | |
| Sodium preparation | 2017 | 2017 | a | a | a | a | a | a | a |
| Sodium Reactor Facility | 2017 | 2018 | a | a | a | a | a | a | a |
| Remote Treatment Project | 2017 | 2017 | a | a | a | a | a | a | a |
| Deactivation | | | | | | | | | |
| Sodium Reactor Facility | 2019 | 2019 | a | a | a | a | a | a | a |
| Remote Treatment Project | 2018 | 2018 | a | a | a | a | a | a | a |
| Closure | | | | | | | | | |
| Site regrading | 2018 | 2018 | a | a | a | a | a | a | a |
| Site revegetation | 2018 | 2018 | a | a | a | a | a | a | a |
| Postclosure care | 2022 | 2121 | a | 1.06×10^{-2} | a | 3.58×10^{-3} | a | 1.13×10^1 | 3.18 |
| Total | | | 1.40×10^1 | 1.06×10^{-2} | 1.16×10^{-4} | 3.58×10^{-3} | 0 | 1.13×10^1 | 3.18 |

^a This activity would not contribute to the concentration during the peak year(s) for this pollutant and averaging period.

^b Emissions for this activity and pollutant were not calculated because they would be small compared with those for other activities under this alternative, as explained in Section G.2.

^c There is no peak year because no emissions were calculated.

Key: FFTF=Fast Flux Test Facility.

Source: SAIC 2007b.

**Table G-145. FFTF Decommissioning Alternative 2 Maximum Criteria Pollutant Concentrations
of Peak Idaho National Laboratory Activity Periods**

| Facility/System | Start Year | End Year | Concentration (micrograms per cubic meter) | | | | | | | | | |
|----------------------------|---------------|-------------|--|--------|---------------------|----------------------|----------------------|-----------------------|-----------------------|-----------------------|-----------------------|--|
| | | | Carbon Monoxide | | Nitrogen Dioxide | PM ₁₀ | | | Sulfur Dioxide | | | |
| | | | 1-hour | 8-hour | Annual | 24-hour | Annual | 1-hour | 3-hour | 24-hour | Annual | |
| | | | 2014 | 2014 | 2015-2016 | 2015-2016 | 2015-2016 | 2014 | 2014 | 2014 | 2014 | |
| Construction | | | | | | | | | | | | |
| Sodium Processing Facility | 2014 | 2014 | 66.6 | 46.6 | a | a | a | 8.96×10 ⁻² | 8.07×10 ⁻² | 3.58×10 ⁻³ | 7.17×10 ⁻³ | |
| Remote Treatment Project | 2015 | 2016 | a | a | 4.00 | 8.63×10 ¹ | 1.73×10 ¹ | a | a | a | a | |
| Operations | | | | | | | | | | | | |
| Sodium production | 2015 | 2015 | b | b | b | b | b | b | b | b | b | |
| Sodium Processing Facility | 2015 | 2016 | b | b | b | b | b | b | b | b | b | |
| Remote Treatment Project | 2017 | 2017 | b | b | b | b | b | b | b | b | b | |
| Deactivation | | | | | | | | | | | | |
| Sodium Processing Facility | 2016 | 2016 | b | b | b | b | b | b | b | b | b | |
| Remote Treatment Project | 2018 | 2018 | b | b | b | b | b | b | b | b | b | |
| Total | | | 66.6 | 46.6 | 4.00 | 8.63×10 ¹ | 1.73×10 ¹ | 8.96×10 ⁻² | 8.07×10 ⁻² | 3.58×10 ⁻³ | 7.17×10 ⁻³ | |

^a This activity would not contribute to the concentration during the peak year(s) for this pollutant and averaging period.

^b Emissions for this activity and pollutant were not calculated because they would be small compared with those for other activities under this alternative, as explained in Section G.2.

Key: FFTF=Fast Flux Test Facility; PM₁₀=particulate matter with an aerodynamic diameter less than or equal to 10 micrometers.

Source: SAIC 2007b.

Table G-146. FFTF Decommissioning Alternative 2 Maximum Toxic Pollutant Concentrations of Peak Idaho National Laboratory Activity Periods

| Facility/System | Start Year | End Year | Concentration (micrograms per cubic meter) | | | | | | |
|----------------------------|------------|----------|--|-----------------------|-----------------------|-----------------------|---------|-----------------------|-----------------------|
| | | | Ammonia | Benzene | 1,3-Butadiene | Formaldehyde | Mercury | Toluene | Xylene |
| | | | 24-hour | Annual | Annual | Annual | 24-hour | 24-hour | 24-hour |
| | | | 2015-2016 | 2015-2016 | 2015-2016 | 2015-2016 | c | 2014 | 2014 |
| Construction | | | | | | | | | |
| Sodium Processing Facility | 2014 | 2014 | a | a | a | a | b | 5.17×10^{-2} | 1.47×10^{-2} |
| Remote Treatment Project | 2015 | 2016 | 3.15×10^{-2} | 8.48×10^{-4} | 3.53×10^{-5} | 1.07×10^{-3} | b | a | a |
| Operations | | | | | | | | | |
| Sodium production | 2015 | 2015 | b | b | b | b | b | b | b |
| Sodium Processing Facility | 2015 | 2016 | b | b | b | b | b | b | b |
| Remote Treatment Project | 2017 | 2017 | b | b | b | b | b | b | b |
| Deactivation | | | | | | | | | |
| Sodium Processing Facility | 2016 | 2016 | b | b | b | b | b | b | b |
| Remote Treatment Project | 2018 | 2018 | b | b | b | b | b | b | b |
| Total | | | 3.15×10^{-2} | 8.48×10^{-4} | 3.53×10^{-5} | 1.07×10^{-3} | 0 | 5.17×10^{-2} | 1.47×10^{-2} |

^a This activity would not contribute to the concentration during the peak year(s) for this pollutant and averaging period.

^b Emissions for this activity and pollutant were not calculated because they would be small compared with those for other activities under this alternative, as explained in Section G.2.

^c There is no peak year because no emissions were calculated.

Key: FFTF=Fast Flux Test Facility.

Source: SAIC 2007b.

**Table G-147. FFTF Decommissioning Alternative 3 Maximum Criteria Pollutant Concentrations
of Peak Idaho National Laboratory Activity Periods**

| Facility/System | Start Year | End Year | Concentration (micrograms per cubic meter) | | | | | | | | | |
|----------------------------|---------------|-------------|--|--------|---------------------|--------------------|--------------------|-----------------------|-----------------------|-----------------------|-----------------------|--|
| | | | Carbon Monoxide | | Nitrogen Dioxide | PM ₁₀ | | | Sulfur Dioxide | | | |
| | | | 1-hour | 8-hour | Annual | 24-hour | Annual | 1-hour | 3-hour | 24-hour | Annual | |
| | | | 2014 | 2014 | 2015–2016 | 2015–2016 | 2015–2016 | 2014 | 2014 | 2014 | 2014 | |
| Construction | | | | | | | | | | | | |
| Sodium Processing Facility | 2014 | 2014 | 66.6 | 46.6 | a | a | a | 8.96×10^{-2} | 8.07×10^{-2} | 3.58×10^{-3} | 7.17×10^{-3} | |
| Remote Treatment Project | 2015 | 2016 | a | a | 4.00 | 8.63×10^1 | 1.73×10^1 | a | a | a | a | |
| Operations | | | | | | | | | | | | |
| Sodium production | 2015 | 2015 | b | b | b | b | b | b | b | b | b | |
| Sodium Processing Facility | 2015 | 2016 | b | b | b | b | b | b | b | b | b | |
| Remote Treatment Project | 2017 | 2017 | b | b | b | b | b | b | b | b | b | |
| Deactivation | | | | | | | | | | | | |
| Sodium Processing Facility | 2016 | 2016 | b | b | b | b | b | b | b | b | b | |
| Remote Treatment Project | 2018 | 2018 | b | b | b | b | b | b | b | b | b | |
| Total | | | 66.6 | 46.6 | 4.00 | 8.63×10^1 | 1.73×10^1 | 8.96×10^{-2} | 8.07×10^{-2} | 3.58×10^{-3} | 7.17×10^{-3} | |

^a This activity would not contribute to the concentration during the peak year(s) for this pollutant and averaging period.

^b Emissions for this activity and pollutant were not calculated because they would be small compared with those for other activities under this alternative, as explained in Section G.2.

Key: FFTF=Fast Flux Test Facility; PM₁₀=particulate matter with an aerodynamic diameter less than or equal to 10 micrometers.

Source: SAIC 2007b.

Table G-148. FFTF Decommissioning Alternative 3 Maximum Toxic Pollutant Concentrations of Peak Idaho National Laboratory Activity Periods

| Facility/System | Start Year | End Year | Concentration (micrograms per cubic meter) | | | | | | |
|----------------------------|------------|----------|--|-----------------------|-----------------------|-----------------------|---------|-----------------------|-----------------------|
| | | | Ammonia | Benzene | 1,3-Butadiene | Formaldehyde | Mercury | Toluene | Xylene |
| | | | 24-hour | Annual | Annual | Annual | 24-hour | 24-hour | 24-hour |
| | | | 2014 | 2014 | 2014 | 2014 | c | 2014 | 2014 |
| Construction | | | | | | | | | |
| Sodium Processing Facility | 2014 | 2014 | a | a | a | a | b | 5.17×10^{-2} | 1.47×10^{-2} |
| Remote Treatment Project | 2015 | 2016 | 3.15×10^{-2} | 8.48×10^{-4} | 3.53×10^{-5} | 1.07×10^{-3} | b | a | a |
| Operations | | | | | | | | | |
| Sodium production | 2015 | 2015 | b | b | b | b | b | b | b |
| Sodium Processing Facility | 2015 | 2016 | b | b | b | b | b | b | b |
| Remote Treatment Project | 2017 | 2017 | b | b | b | b | b | b | b |
| Deactivation | | | | | | | | | |
| Sodium Processing Facility | 2016 | 2016 | b | b | b | b | b | b | b |
| Remote Treatment Project | 2018 | 2018 | b | b | b | b | b | b | b |
| Total | | | 3.15×10^{-2} | 8.48×10^{-4} | 3.53×10^{-5} | 1.07×10^{-3} | 0 | 5.17×10^{-2} | 1.47×10^{-2} |

^a This activity would not contribute to the concentration during the peak year(s) for this pollutant and averaging period.

^b Emissions for this activity and pollutant were not calculated because they would be small compared with those for other activities under this alternative, as explained in Section G.2.

^c There is no peak year because no emissions were calculated.

Key: FFTF=Fast Flux Test Facility.

Source: SAIC 2007b.

Table G-149. Waste Management Alternative 1 Maximum Criteria Pollutant Concentrations of Peak Activity Periods

| Facility/System | Start Year | End Year | Concentration (micrograms per cubic meter) | | | | | | | | | |
|--|------------|----------|--|----------------------|-----------------------|----------------------------|-----------------------|-----------------------|-----------------------|-----------------------|-----------------------|--|
| | | | Carbon Monoxide | | Nitrogen Dioxide | PM ₁₀ | | Sulfur Dioxide | | | | |
| | | | 1-hour | 8-hour | Annual | 24-hour | Annual | 1-hour | 3-hour | 24-hour | Annual | |
| | | | 2009 | 2009 | 2009 | 2009 | 2009 | 2009 | 2009 | 2009 | 2009 | |
| Operations | | | | | | | | | | | | |
| Low-level radioactive waste burial grounds | 2007 | 2035 | 3.05×10 ¹ | 5.59 | 3.79×10 ⁻² | 7.67×10 ¹ | 4.91×10 ⁻¹ | 4.48×10 ⁻² | 1.73×10 ⁻² | 3.51×10 ⁻³ | 2.24×10 ⁻⁵ | |
| Deactivation | | | | | | | | | | | | |
| Integrated Disposal Facility | 2009 | 2009 | 4.20×10 ² | 6.50×10 ¹ | 1.20 | 4.30×10 ² | 4.05 | 6.60×10 ⁻¹ | 2.36×10 ⁻¹ | 4.45×10 ⁻² | 4.19×10 ⁻⁴ | |
| Postclosure care | 2036 | 2135 | a | a | a | a | a | a | a | a | a | |
| Total | | | 4.51×10 ² | 7.06×10 ¹ | 1.24 | 5.07×10² | 4.54 | 7.05×10 ⁻¹ | 2.54×10 ⁻¹ | 4.80×10 ⁻² | 4.42×10 ⁻⁴ | |

^a This activity would not contribute to the concentration during the peak year(s) for this pollutant and averaging period.

Key: PM₁₀=particulate matter with an aerodynamic diameter less than or equal to 10 micrometers.

Source: SAIC 2007c.

Table G-150. Waste Management Alternative 1 Maximum Toxic Pollutant Concentrations of Peak Activity Periods

| Facility/System | Start Year | End Year | Concentration (micrograms per cubic meter) | | | | | | | |
|--|------------|----------|--|-----------------------|-----------------------|-----------------------|---------|-----------------------|-----------------------|--|
| | | | Ammonia | Benzene | 1,3-Butadiene | Formaldehyde | Mercury | Toluene | Xylene | |
| | | | 24-hour | Annual | Annual | Annual | 24-hour | 24-hour | 24-hour | |
| | | | 2009 | 2009 | 2009 | 2009 | b | 2036 - 2135 | 2009 | |
| Operations | | | | | | | | | | |
| Low-level radioactive waste burial grounds | 2007 | 2035 | 9.36×10 ⁻³ | 8.90×10 ⁻⁶ | 3.40×10 ⁻⁷ | 1.04×10 ⁻⁵ | a | a | 1.01×10 ⁻³ | |
| Deactivation | | | | | | | | | | |
| Integrated Disposal Facility | 2009 | 2009 | 2.01×10 ⁻¹ | 2.55×10 ⁻⁴ | 1.07×10 ⁻⁵ | 3.22×10 ⁻⁴ | a | a | 8.72×10 ⁻³ | |
| Postclosure care | 2036 | 2135 | a | a | a | a | a | 2.65×10 ⁻² | a | |
| Total | | | 2.10×10 ⁻¹ | 2.64×10 ⁻⁴ | 1.10×10 ⁻⁵ | 3.32×10 ⁻⁴ | 0 | 2.65×10 ⁻² | 9.73×10 ⁻³ | |

^a This activity would not contribute to the concentration during the peak year(s) for this pollutant and averaging period.

^b There is no peak year because no emissions were calculated.

Source: SAIC 2007c.

Table G–151. Waste Management Alternative 2 (Treatment and Storage) Maximum Criteria Pollutant Concentrations of Peak Activity Periods

| Facility/System | Start Year | End Year | Concentration (micrograms per cubic meter) | | | | | | | | |
|---|------------|----------|--|----------------------|-----------------------|----------------------------|-----------------------|----------------------|-----------------------|-----------------------|-----------------------|
| | | | Carbon Monoxide | | Nitrogen Dioxide | PM ₁₀ | | Sulfur Dioxide | | | |
| | | | 1-hour | 8-hour | Annual | 24-hour | Annual | 1-hour | 3-hour | 24-hour | Annual |
| | | | 2011–2012 | 2011–2012 | 2013–2018 | 2019–2050 | 2019–2050 | 2011–2012 | 2011–2012 | 2011–2012 | 2011–2012 |
| Construction | | | | | | | | | | | |
| T Plant complex expansion | 2011 | 2012 | 7.55×10 ² | 1.38×10 ² | a | a | a | 1.02 | 3.92×10 ⁻¹ | 7.97×10 ⁻² | 5.10×10 ⁻⁴ |
| Contact-Handled Mixed TRU/TRU waste facility (WRAP expansion) | 2011 | 2012 | 8.61×10 ³ | 1.58×10 ³ | a | a | a | 1.16×10 ¹ | 4.47 | 9.09×10 ⁻¹ | 5.81×10 ⁻³ |
| Remote-Handled Mixed TRU/TRU waste facility (WRAP expansion) | 2013 | 2018 | a | a | 4.59×10 ⁻¹ | a | a | a | a | a | a |
| Central Waste Complex expansion | 2011 | 2012 | 2.87×10 ³ | 5.26×10 ² | a | a | a | 3.87 | 1.49 | 3.03×10 ⁻¹ | 1.94×10 ⁻³ |
| Operations | | | | | | | | | | | |
| T Plant complex expansion | 2013 | 2050 | a | a | 2.94 | 4.05×10 ¹ | 2.59×10 ⁻¹ | a | a | a | a |
| Contact-Handled Mixed TRU/TRU waste facility (WRAP expansion) | 2013 | 2050 | a | a | 7.91×10 ⁻³ | 1.07×10 ² | 6.86×10 ⁻¹ | a | a | a | a |
| Remote-Handled Mixed TRU/TRU waste facility (WRAP expansion) | 2019 | 2050 | a | a | a | 1.07×10 ² | 2.96 | a | a | a | a |
| Central Waste Complex expansion | 2013 | 2050 | a | a | 6.93×10 ⁻² | 4.63×10 ² | 3.04×10 ⁻² | a | a | a | a |
| Deactivation | | | | | | | | | | | |
| T Plant complex expansion | 2051 | 2051 | a | a | a | a | a | a | a | a | a |
| Contact-Handled Mixed TRU/TRU waste facility (WRAP expansion) | 2051 | 2051 | a | a | a | a | a | a | a | a | a |
| Remote-Handled Mixed TRU/TRU waste facility (WRAP expansion) | 2051 | 2051 | a | a | a | a | a | a | a | a | a |
| Central Waste Complex expansion | 2051 | 2051 | a | a | a | a | a | a | a | a | a |
| Total | | | 1.22×10 ⁴ | 2.24×10 ³ | 3.47 | 7.17×10² | 3.93 | 1.65×10 ¹ | 6.36 | 1.29 | 8.26×10 ⁻³ |

^a This activity would not contribute to the concentration during the peak year(s) for this pollutant and averaging period.

Note: Total concentrations exceeding applicable standards are presented in **bold**.

Key: PM₁₀=particulate matter with an aerodynamic diameter less than or equal to 10 micrometers; TRU=transuranic; WRAP=Waste Receiving and Processing Facility.

Source: SAIC 2007c.

Table G-152. Waste Management Alternative 2 (Treatment and Storage) Maximum Toxic Pollutant Concentrations of Peak Activity Periods

| Facility/System | Start Year | End Year | Concentration (micrograms per cubic meter) | | | | | | | |
|---|------------|----------|--|--------------------------|--------------------------------|-------------------------------|-------------------|---------------------------|--------------------------|-----------------------|
| | | | Ammonia 24-hour 2013-2018 | Benzene Annual 2013-2018 | 1,3-Butadiene Annual 2013-2018 | Formaldehyde Annual 2013-2018 | Mercury 24-hour b | Toluene 24-hour 2011-2012 | Xylene 24-hour 2011-2012 | |
| | | | | | | | | | | |
| Construction | | | | | | | | | | |
| T Plant complex expansion | 2011 | 2012 | a | a | a | a | a | a | 1.14×10 ⁻¹ | 3.25×10 ⁻² |
| Contact-Handled Mixed TRU/TRU waste facility (WRAP expansion) | 2011 | 2012 | a | a | a | a | a | a | 1.30 | 3.70×10 ⁻¹ |
| Remote-Handled Mixed TRU/TRU waste facility (WRAP expansion) | 2013 | 2018 | 1.31×10 ⁻¹ | 4.78×10 ⁻⁴ | 3.36×10 ⁻⁵ | 1.41×10 ⁻³ | a | a | a | a |
| Central Waste Complex expansion | 2011 | 2012 | a | a | a | a | a | a | 4.33×10 ⁻¹ | 1.23×10 ⁻¹ |
| Operations | | | | | | | | | | |
| T Plant complex expansion | 2013 | 2050 | 7.22×10 ⁻¹ | 6.22×10 ⁻⁴ | 2.60×10 ⁻⁵ | 7.86×10 ⁻⁴ | a | a | a | a |
| Contact-Handled Mixed TRU/TRU waste facility (WRAP expansion) | 2013 | 2050 | 1.95×10 ⁻³ | 1.67×10 ⁻⁶ | 7.02×10 ⁻⁸ | 2.12×10 ⁻⁶ | a | a | a | a |
| Remote-Handled Mixed TRU/TRU waste facility (WRAP expansion) | 2019 | 2050 | a | a | a | a | a | a | a | a |
| Central Waste Complex expansion | 2013 | 2050 | 1.90×10 ⁻² | 5.80×10 ⁻⁵ | 7.87×10 ⁻⁷ | 3.13×10 ⁻⁵ | a | a | a | a |
| Deactivation | | | | | | | | | | |
| T Plant complex expansion | 2051 | 2051 | a | a | a | a | a | a | a | a |
| Contact-Handled Mixed TRU/TRU waste facility (WRAP expansion) | 2051 | 2051 | a | a | a | a | a | a | a | a |
| Remote-Handled Mixed TRU/TRU waste facility (WRAP expansion) | 2051 | 2051 | a | a | a | a | a | a | a | a |
| Central Waste Complex expansion | 2051 | 2051 | 8.74×10 ⁻¹ | 1.16×10 ⁻³ | 6.05×10 ⁻⁵ | 2.23×10 ⁻³ | a | a | 1.84 | 5.26×10 ⁻¹ |
| Total | | | | | | | | | | |

a This activity would not contribute to the concentration during the peak year(s) for this pollutant and averaging period.

b There is no peak year because no emissions were calculated.

Key: TRU=transuranic; WRAP=Waste Receiving and Processing Facility.

Source: SAIC 2007c.

Table G-153. Waste Management Alternative 2, Disposal Group 1, Maximum Criteria Pollutant Concentrations of Peak Activity Periods

| Facility/System | Start Year | End Year | Concentration (micrograms per cubic meter) | | | | | | | | | | |
|--|------------|----------|--|----------------------|----------------------|----------------------------|-----------------------|----------------------|----------------------|---------------------|-----------------------|---------------------|---|
| | | | Carbon Monoxide | | Nitrogen Dioxide | | PM ₁₀ | | | Sulfur Dioxide | | | |
| | | | 1-hour 2051-2052 | 8-hour 2051-2052 | Annual 2051-2052 | Annual 2019-2021 | 24-hour 2019-2021 | Annual 2019-2021 | 1-hour 2051-2052 | 3-hour 2051-2052 | 24-hour 2051-2052 | Annual 2051-2052 | |
| Construction | | | | | | | | | | | | | |
| Integrated Disposal Facility | 2006 | 2008 | a | a | a | a | a | a | a | a | a | a | a |
| River Protection Project Disposal Facility | 2019 | 2021 | a | a | a | 2.16×10 ³ | 1.60×10 ¹ | a | a | a | a | a | a |
| Operations | | | | | | | | | | | | | |
| Low-level radioactive waste burial grounds | 2007 | 2050 | a | a | a | 7.67×10 ¹ | 4.91×10 ⁻¹ | a | a | a | a | a | a |
| Integrated Disposal Facility | 2009 | 2050 | a | a | a | 1.12×10 ³ | 1.06×10 ¹ | a | a | a | a | a | a |
| River Protection Project Disposal Facility | 2022 | 2050 | a | a | a | a | a | a | a | a | a | a | a |
| Closure | | | | | | | | | | | | | |
| Integrated Disposal Facility | 2051 | 2052 | 1.74×10 ⁴ | 2.70×10 ³ | 7.69 | a | a | 2.40×10 ¹ | 8.57 | 1.62 | 1.52×10 ⁻² | a | a |
| Postclosure care, Integrated Disposal Facility | 2053 | 2152 | a | a | a | a | a | a | a | a | a | a | a |
| River Protection Project Disposal Facility | 2051 | 2052 | 3.24×10 ⁴ | 5.19×10 ³ | 1.15×10 ¹ | a | a | 4.45×10 ¹ | 1.51×10 ¹ | 3.08 | 2.28×10 ⁻² | a | a |
| Postclosure care, River Protection Project Disposal Facility | 2053 | 2152 | a | a | a | a | a | a | a | a | a | a | a |
| Total | | | 4.98×10⁴ | 7.88×10 ³ | 1.92×10 ¹ | 3.36×10³ | 2.71×10 ¹ | 6.84×10 ¹ | 2.37×10 ¹ | 4.70 | 3.80×10 ⁻² | | |

a This activity would not contribute to the concentration during the peak year(s) for this pollutant and averaging period.

Note: Total concentrations exceeding applicable standards are presented in **bold**.

Key: PM₁₀=particulate matter with an aerodynamic diameter less than or equal to 10 micrometers.

Source: SAIC 2007c.

Table G-154. Waste Management Alternative 2, Disposal Group 1, Maximum Toxic Pollutant Concentrations of Peak Activity Periods

| Facility/System | Start Year | End Year | Concentration (micrograms per cubic meter) | | | | | | | |
|--|------------|----------|--|-----------------------|-----------------------|-----------------------|-----------------|-----------------|-----------------------|---|
| | | | Ammonia 24-hour | Benzene Annual | 1,3-Butadiene Annual | Formaldehyde Annual | Mercury 24-hour | Toluene 24-hour | Xylene 24-hour | |
| | | | 2051-2052 | 2051-2052 | 2051-2052 | 2051-2052 | c | 2051-2052 | 2051-2052 | |
| Construction | | | | | | | | | | |
| Integrated Disposal Facility | 2006 | 2008 | a | a | a | a | b | a | a | a |
| River Protection Project Disposal Facility | 2019 | 2021 | a | a | a | a | a | a | a | a |
| Operations | | | | | | | | | | |
| Low-level radioactive waste burial grounds | 2007 | 2050 | a | a | a | a | a | a | a | a |
| Integrated Disposal Facility | 2009 | 2050 | a | a | a | a | a | a | a | a |
| River Protection Project Disposal Facility | 2022 | 2050 | a | a | a | a | a | a | a | a |
| Closure | | | | | | | | | | |
| Integrated Disposal Facility | 2051 | 2052 | 1.32 | 2.79×10^{-3} | 7.29×10^{-5} | 2.40×10^{-3} | a | 2.06 | 6.12×10^{-1} | a |
| Postclosure care, Integrated Disposal Facility | 2053 | 2152 | a | a | a | a | a | a | a | a |
| River Protection Project Disposal Facility | 2051 | 2052 | 2.52 | 4.19×10^{-3} | 1.09×10^{-4} | 3.60×10^{-3} | a | 3.94 | 1.17 | a |
| Postclosure care, River Protection Project Disposal Facility | 2053 | 2152 | a | a | a | a | a | a | a | a |
| Total | | | 3.84 | 6.98×10^{-3} | 1.82×10^{-4} | 6.00×10^{-3} | 0 | 6.00 | 1.78 | a |

a This activity would not contribute to the concentration during the peak year(s) for this pollutant and averaging period.

b Emissions for this activity and pollutant were not calculated because they would be small compared with those for other activities under this alternative, as explained in Section G.2.

c There is no peak year because no emissions were calculated.

Source: SAIC 2007c.

Table G-155. Waste Management Alternative 2, Disposal Group 2, Maximum Criteria Pollutant Concentrations of Peak Activity Periods

| Facility/System | Start Year | End Year | Concentration (micrograms per cubic meter) | | | | | | | | | |
|--|------------|----------|--|----------------------------|----------------------------|----------------------------|----------------------------|----------------------------|----------------------------|----------------------------|----------------------------|-----------------------------|
| | | | Carbon Monoxide | | Nitrogen Dioxide | | PM ₁₀ | | Sulfur Dioxide | | | |
| | | | 1-hour 2101-2102 | 8-hour 2101-2102 | Annual 2101-2102 | 24-hour 2019-2021 | Annual 2019-2021 | 1-hour 2101-2102 | 3-hour 2101-2102 | 24-hour 2101-2102 | Annual 2101-2102 | |
| Construction | | | | | | | | | | | | |
| Integrated Disposal Facility | 2006 | 2008 | a | a | a | a | a | a | a | a | a | a |
| River Protection Project Disposal Facility | 2019 | 2021 | a | a | a | 1.68×10 ⁴ | 1.24×10 ² | a | a | a | a | a |
| Operations | | | | | | | | | | | | |
| Low-level radioactive waste burial grounds | 2007 | 2050 | a | a | a | 7.67×10 ¹ | 4.91×10 ⁻¹ | a | a | a | a | a |
| Integrated Disposal Facility | 2009 | 2100 | a | a | a | 3.97×10 ² | 3.74 | a | a | a | a | a |
| River Protection Project Disposal Facility | 2022 | 2100 | a | a | a | a | a | a | a | a | a | a |
| Closure | | | | | | | | | | | | |
| Integrated Disposal Facility | 2101 | 2102 | 6.16×10 ³ | 9.53×10 ² | 2.72 | a | a | a | 8.46 | 3.03 | 5.71×10 ⁻¹ | 5.38×10 ⁻³ |
| Postclosure care, Integrated Disposal Facility | 2103 | 2202 | a | a | a | a | a | a | a | a | a | a |
| River Protection Project Disposal Facility | 2101 | 2102 | 2.51×10 ⁵ | 4.02×10 ⁴ | 8.93×10 ¹ | a | a | a | 3.45×10 ² | 1.17×10 ² | 2.39×10 ¹ | 1.77×10 ⁻¹ |
| Postclosure care, River Protection Project Disposal Facility | 2103 | 2202 | a | a | a | a | a | a | a | a | a | a |
| Total | | | 2.57×10⁵ | 4.12×10⁴ | 9.21×10¹ | 1.72×10⁴ | 1.28×10² | 1.20×10² | 3.53×10² | 1.20×10² | 2.45×10¹ | 1.82×10⁻¹ |

a This activity would not contribute to the concentration during the peak year(s) for this pollutant and averaging period.

Note: Total concentrations exceeding applicable standards are presented in bold.

Key: PM₁₀=particulate matter with an aerodynamic diameter less than or equal to 10 micrometers.

Source: SAIC 2007c.

Table G-156. Waste Management Alternative 2, Disposal Group 2, Maximum Toxic Pollutant Concentrations of Peak Activity Periods

| Facility/System | Start Year | End Year | Concentration (micrograms per cubic meter) | | | | | | | | | | | | | |
|--|------------|----------|--|-----------------------|-----------------------|-----------------------|---------------|-----------------------|-----------------------|-----------|-----------------------|-----------------------|-----------|----------------------|-----------|--------|
| | | | Ammonia | | Benzene | | 1,3-Butadiene | | Formaldehyde | | Mercury | | Toluene | | Xylene | |
| | | | 24-hour | Annual | 24-hour | Annual | 24-hour | Annual | 24-hour | Annual | 24-hour | Annual | 24-hour | Annual | 24-hour | Annual |
| | | | 2101-2102 | 2101-2102 | 2101-2102 | 2101-2102 | 2101-2102 | 2101-2102 | 2101-2102 | 2101-2102 | 2101-2102 | 2101-2102 | 2101-2102 | 2101-2102 | 2101-2102 | |
| Construction | | | | | | | | | | | | | | | | |
| Integrated Disposal Facility | 2006 | 2008 | a | a | a | a | a | a | a | a | a | a | a | a | a | |
| River Protection Project Disposal Facility | 2019 | 2021 | a | a | a | a | a | a | a | a | a | a | a | a | a | |
| Operations | | | | | | | | | | | | | | | | |
| Low-level radioactive waste burial grounds | 2007 | 2050 | a | a | a | a | a | a | a | a | a | a | a | a | a | |
| Integrated Disposal Facility | 2009 | 2100 | a | a | a | a | a | a | a | a | a | a | a | a | a | |
| River Protection Project Disposal Facility | 2022 | 2100 | a | a | a | a | a | a | a | a | a | a | a | a | a | |
| Closure | | | | | | | | | | | | | | | | |
| Integrated Disposal Facility | 2101 | 2102 | 4.67×10 ⁻¹ | 9.87×10 ⁻⁴ | 2.57×10 ⁻⁵ | 8.49×10 ⁻⁴ | a | 7.28×10 ⁻¹ | 2.16×10 ⁻¹ | a | 7.28×10 ⁻¹ | 2.16×10 ⁻¹ | a | a | a | |
| Postclosure care, Integrated Disposal Facility | 2103 | 2202 | a | a | a | a | a | a | a | a | a | a | a | a | a | |
| River Protection Project Disposal Facility | 2101 | 2102 | 1.95×10 ¹ | 3.25×10 ⁻² | 8.46×10 ⁻⁴ | 2.79×10 ⁻² | a | 3.05×10 ¹ | 9.06 | a | 3.05×10 ¹ | 9.06 | a | a | a | |
| Postclosure care, River Protection Project Disposal Facility | 2103 | 2202 | a | a | a | a | a | a | a | a | a | a | a | a | a | |
| Total | | | 2.00×10 ¹ | 3.34×10 ⁻² | 8.72×10 ⁻⁴ | 2.88×10 ⁻² | 0 | 3.12×10 ¹ | 9.27 | 0 | 3.12×10 ¹ | 9.27 | 0 | 3.12×10 ¹ | 9.27 | |

a This activity would not contribute to the concentration during the peak year(s) for this pollutant and averaging period.

b Emissions for this activity and pollutant were not calculated because they would be small compared with those for other activities under this alternative, as explained in Section G.2.

c There is no peak year because no emissions were calculated.

Source: SAIC 2007c.

Table G-157. Waste Management Alternative 2, Disposal Group 3, Maximum Criteria Pollutant Concentrations of Peak Activity Periods

| Facility/System | Start Year | End Year | Concentration (micrograms per cubic meter) | | | | | | | | | | |
|--|------------|----------|--|----------------------------|----------------------------|----------------------------|----------------------------|----------------------------|----------------------------|----------------------------|-----------------------------|---------------------|---|
| | | | Carbon Monoxide | | Nitrogen Dioxide | | PM ₁₀ | | Sulfur Dioxide | | | | |
| | | | 1-hour 2166-2167 | 8-hour 2166-2167 | Annual 2166-2167 | Annual 2166-2167 | 24-hour 2019-2021 | Annual 2019-2021 | 1-hour 2166-2167 | 3-hour 2166-2167 | 24-hour 2166-2167 | Annual 2166-2167 | |
| Construction | | | | | | | | | | | | | |
| Integrated Disposal Facility | 2006 | 2008 | a | a | a | a | a | a | a | a | a | a | a |
| River Protection Project Disposal Facility | 2019 | 2021 | a | a | a | 1.24×10 ² | a | a | a | a | a | a | a |
| Operations | | | | | | | | | | | | | |
| Low-level radioactive waste burial grounds | 2007 | 2050 | a | a | a | 7.67×10 ¹ | 4.91×10 ⁻¹ | a | a | a | a | a | a |
| Integrated Disposal Facility | 2009 | 2165 | a | a | a | 3.97×10 ² | 3.74 | a | a | a | a | a | a |
| River Protection Project Disposal Facility | 2022 | 2165 | a | a | a | a | a | a | a | a | a | a | a |
| Closure | | | | | | | | | | | | | |
| Integrated Disposal Facility | 2166 | 2167 | 6.16×10 ³ | 9.53×10 ² | 2.72 | a | a | 8.46 | 3.03 | 5.71×10 ⁻¹ | 5.38×10 ⁻³ | a | a |
| Postclosure care, Integrated Disposal Facility | 2168 | 2267 | a | a | a | a | a | a | a | a | a | a | a |
| River Protection Project Disposal Facility | 2166 | 2167 | 2.51×10 ⁵ | 4.02×10 ⁴ | 8.93×10 ¹ | a | a | 3.45×10 ² | 1.17×10 ² | 2.39×10 ¹ | 1.77×10 ⁻¹ | a | a |
| Postclosure care, River Protection Project Disposal Facility | 2168 | 2267 | a | a | a | a | a | a | a | a | a | a | a |
| Total | | | 2.57×10⁵ | 4.12×10⁴ | 9.21×10¹ | 1.72×10⁴ | 1.28×10² | 3.53×10² | 1.20×10² | 2.45×10¹ | 1.82×10⁻¹ | | |

a This activity would not contribute to the concentration during the peak year(s) for this pollutant and averaging period.

Note: Total concentrations exceeding applicable standards are presented in bold.

Key: PM₁₀=particulate matter with an aerodynamic diameter less than or equal to 10 micrometers.

Source: SAIC 2007c.

Table G-158. Waste Management Alternative 2, Disposal Group 3, Maximum Toxic Pollutant Concentrations of Peak Activity Periods

| Facility/System | Start Year | End Year | Concentration (micrograms per cubic meter) | | | | | | | |
|--|------------|----------|--|-----------------------|-----------------------|-----------------------|---------|-----------------------|-----------------------|-----------|
| | | | Ammonia | Benzene | 1,3-Butadiene | Formaldehyde | Mercury | Toluene | Xylene | |
| | | | 24-hour | Annual | Annual | Annual | 24-hour | 24-hour | 24-hour | |
| | | | 2166-2167 | 2166-2167 | 2166-2167 | 2166-2167 | c | 2166-2167 | 2166-2167 | 2166-2167 |
| Construction | | | | | | | | | | |
| Integrated Disposal Facility | 2006 | 2008 | a | a | a | a | b | a | a | a |
| River Protection Project Disposal Facility | 2019 | 2021 | a | a | a | a | a | a | a | a |
| Operations | | | | | | | | | | |
| Low-level radioactive waste burial grounds | 2007 | 2050 | a | a | a | a | a | a | a | a |
| Integrated Disposal Facility | 2009 | 2165 | a | a | a | a | a | a | a | a |
| River Protection Project Disposal Facility | 2022 | 2165 | a | a | a | a | a | a | a | a |
| Closure | | | | | | | | | | |
| Integrated Disposal Facility | 2166 | 2167 | 4.67×10^{-1} | 9.87×10^{-4} | 2.57×10^{-5} | 8.49×10^{-4} | a | 7.28×10^{-1} | 2.16×10^{-1} | |
| Postclosure care, Integrated Disposal Facility | 2168 | 2267 | a | a | a | a | a | a | a | a |
| River Protection Project Disposal Facility | 2166 | 2167 | 1.95×10^1 | 3.25×10^{-2} | 8.46×10^{-4} | 2.79×10^{-2} | a | 3.05×10^1 | 9.06 | |
| Postclosure care, River Protection Project Disposal Facility | 2168 | 2267 | a | a | a | a | a | a | a | a |
| Total | | | 2.00×10^1 | 3.34×10^{-2} | 8.72×10^{-4} | 2.88×10^{-2} | 0 | 3.12×10^1 | 9.27 | |

a This activity would not contribute to the concentration during the peak year(s) for this pollutant and averaging period.

b Emissions for this activity and pollutant were not calculated because they would be small compared with those for other activities under this alternative, as explained in Section G.2.

c There is no peak year because no emissions were calculated.

Source: SAIC 2007c.

Table G-159. Waste Management Alternative 3 (Treatment and Storage) Maximum Criteria Pollutant Concentrations of Peak Activity Periods

| Facility/System | Start Year | End Year | Concentration (micrograms per cubic meter) | | | | | | | | | | | |
|---|------------|----------|--|----------------------|-----------------------|----------------------------|-----------------------|----------------------|-----------------------|-----------------------|-----------------------|---------------------|---------------------|--|
| | | | Carbon Monoxide | | | Nitrogen Dioxide | | PM ₁₀ | | | Sulfur Dioxide | | | |
| | | | 1-hour 2011-2012 | 8-hour 2011-2012 | Annual 2013-2018 | 24-hour 2019-2050 | Annual 2019-2050 | 1-hour 2011-2012 | 3-hour 2011-2012 | 24-hour 2011-2012 | Annual 2011-2012 | Annual 2011-2012 | Annual 2011-2012 | |
| Construction | | | | | | | | | | | | | | |
| T Plant complex expansion | 2011 | 2012 | 7.55×10 ² | 1.38×10 ² | a | a | a | 1.02 | 3.92×10 ⁻¹ | 7.97×10 ⁻² | 5.10×10 ⁻⁴ | | | |
| Contact-Handled Mixed TRU/TRU waste facility (WRAP expansion) | 2011 | 2012 | 8.61×10 ³ | 1.58×10 ³ | a | a | a | 1.16×10 ¹ | 4.47 | 9.09×10 ⁻¹ | 5.81×10 ⁻³ | | | |
| Remote-Handled Mixed TRU/TRU waste facility (WRAP expansion) | 2013 | 2018 | a | a | 4.59×10 ⁻¹ | a | a | a | a | a | a | | | |
| Central Waste Complex expansion | 2011 | 2012 | 2.87×10 ³ | 5.26×10 ² | a | a | a | 3.87 | 1.49 | 3.03×10 ⁻¹ | 1.94×10 ⁻³ | | | |
| Operations | | | | | | | | | | | | | | |
| T Plant complex expansion | 2013 | 2050 | a | a | 2.94 | 4.05×10 ¹ | 2.59×10 ⁻¹ | a | a | a | a | | | |
| Contact-Handled Mixed TRU/TRU waste facility (WRAP expansion) | 2013 | 2050 | a | a | 7.91×10 ⁻³ | 1.07×10 ² | 6.86×10 ⁻¹ | a | a | a | a | | | |
| Remote-Handled Mixed TRU/TRU waste facility (WRAP expansion) | 2019 | 2050 | a | a | a | 1.07×10 ² | 6.85×10 ⁻¹ | a | a | a | a | | | |
| Central Waste Complex expansion | 2013 | 2050 | a | a | 6.93×10 ⁻² | 4.63×10 ² | 2.96 | a | a | a | a | | | |
| Deactivation | | | | | | | | | | | | | | |
| T Plant complex expansion | 2051 | 2051 | a | a | a | a | a | a | a | a | a | | | |
| Contact-Handled Mixed TRU/TRU waste facility (WRAP expansion) | 2051 | 2051 | a | a | a | a | a | a | a | a | a | | | |
| Remote-Handled Mixed TRU/TRU waste facility (WRAP expansion) | 2051 | 2051 | a | a | a | a | a | a | a | a | a | | | |
| Central Waste Complex expansion | 2051 | 2051 | 1.22×10 ⁴ | 2.24×10 ³ | 3.47 | 7.17×10² | 4.59 | 1.65×10 ¹ | 6.36 | 1.29 | 8.26×10 ⁻³ | | | |

a This activity would not contribute to the concentration during the peak year(s) for this pollutant and averaging period.

Note: Total concentrations exceeding applicable standards are presented in **bold**.

Key: PM₁₀=particulate matter with an aerodynamic diameter less than or equal to 10 micrometers; TRU=transuranic; WRAP=Waste Receiving and Processing Facility.

Source: SAIC 2007c.

Table G-160. Waste Management Alternative 3 (Treatment and Storage) Maximum Toxic Pollutant Concentrations of Peak Activity Periods

| Facility/System | Start Year | End Year | Concentration (micrograms per cubic meter) | | | | | | |
|---|------------|----------|--|--------------------------|--------------------------------|-------------------------------|-------------------|---------------------------|--------------------------|
| | | | Ammonia 24-hour 2013-2018 | Benzene Annual 2013-2018 | 1,3-Butadiene Annual 2013-2018 | Formaldehyde Annual 2013-2018 | Mercury 24-hour b | Toluene 24-hour 2011-2012 | Xylene 24-hour 2011-2012 |
| | | | | | | | | | |
| Construction | | | | | | | | | |
| T Plant complex expansion | 2011 | 2012 | a | a | a | a | a | 1.14×10 ⁻¹ | 3.25×10 ⁻² |
| Contact-Handled Mixed TRU/TRU waste facility (WRAP expansion) | 2011 | 2012 | a | a | a | a | a | 1.30 | 3.70×10 ⁻¹ |
| Remote-Handled Mixed TRU/TRU waste facility (WRAP expansion) | 2013 | 2018 | 1.31×10 ⁻¹ | 4.78×10 ⁻⁴ | 3.36×10 ⁻⁵ | 1.41×10 ⁻³ | a | a | a |
| Central Waste Complex expansion | 2011 | 2012 | a | a | a | a | a | 4.33×10 ⁻¹ | 1.23×10 ⁻¹ |
| Operations | | | | | | | | | |
| T Plant complex expansion | 2013 | 2050 | 7.22×10 ⁻¹ | 6.22×10 ⁻⁴ | 2.60×10 ⁻⁵ | 7.86×10 ⁻⁴ | a | a | a |
| Contact-Handled Mixed TRU/TRU waste facility (WRAP expansion) | 2013 | 2050 | 1.95×10 ⁻³ | 1.67×10 ⁻⁶ | 7.02×10 ⁻⁸ | 2.12×10 ⁻⁶ | a | a | a |
| Remote-Handled Mixed TRU/TRU waste facility (WRAP expansion) | 2019 | 2050 | a | a | a | a | a | a | a |
| Central Waste Complex expansion | 2013 | 2050 | 1.90×10 ⁻² | 5.80×10 ⁻⁵ | 7.87×10 ⁻⁷ | 3.13×10 ⁻⁵ | a | a | a |
| Closure | | | | | | | | | |
| T Plant complex expansion | 2051 | 2051 | a | a | a | a | a | a | a |
| Contact-Handled Mixed TRU/TRU waste facility (WRAP expansion) | 2051 | 2051 | a | a | a | a | a | a | a |
| Remote-Handled Mixed TRU/TRU waste facility (WRAP expansion) | 2051 | 2051 | a | a | a | a | a | a | a |
| Central Waste Complex expansion | 2051 | 2051 | a | a | a | a | a | a | a |
| Total | | | 8.74×10 ⁻¹ | 1.16×10 ⁻³ | 6.05×10 ⁻⁵ | 2.23×10 ⁻³ | 0 | 1.84 | 5.26×10 ⁻¹ |

a This activity would not contribute to the concentration during the peak year(s) for this pollutant and averaging period.

b There is no peak year because no emissions were calculated.

Key: TRU=transuranic; WRAP=Waste Receiving and Processing Facility.

Source: SAIC 2007c.

Table G-161. Waste Management Alternative 3, Disposal Group 1, Maximum Criteria Pollutant Concentrations of Peak Activity Periods

| Facility/System | Start Year | End Year | Concentration (micrograms per cubic meter) | | | | | | | | | | | |
|---|------------|----------|--|----------------------------|----------------------------|----------------------------|----------------------------|-----------|----------------------------|----------------------------|-----------------------|-----------------------------|-----------|-----------|
| | | | Carbon Monoxide | | | Nitrogen Dioxide | | | PM ₁₀ | | | Sulfur Dioxide | | |
| | | | 1-hour | 8-hour | Annual | Annual | 24-hour | 2019-2021 | 2019-2021 | 2019-2021 | 1-hour | 3-hour | 24-hour | Annual |
| | | | 2051-2052 | 2051-2052 | 2051-2052 | 2051-2052 | 2019-2021 | 2019-2021 | 2019-2021 | 2051-2052 | 2051-2052 | 2051-2052 | 2051-2052 | 2051-2052 |
| Construction | | | | | | | | | | | | | | |
| Integrated Disposal Facility, 200-East Area | 2006 | 2008 | a | a | a | a | a | a | a | a | a | a | a | |
| Integrated Disposal Facility, 200-West Area | 2006 | 2008 | a | a | a | a | a | a | a | a | a | a | a | |
| River Protection Project Disposal Facility | 2019 | 2021 | a | a | a | 2.16×10 ³ | 1.60×10 ¹ | | a | a | a | a | a | |
| Operations | | | | | | | | | | | | | | |
| Low-level radioactive waste burial grounds | 2007 | 2050 | a | a | a | 7.67×10 ¹ | 4.91×10 ⁻¹ | | a | a | a | a | a | |
| Integrated Disposal Facility, 200-East Area | 2009 | 2050 | a | a | a | 1.03×10 ³ | 9.70 | | a | a | a | a | a | |
| Integrated Disposal Facility, 200-West Area | 2009 | 2050 | a | a | a | 1.52×10 ² | 9.70×10 ⁻¹ | | a | a | a | a | a | |
| River Protection Project Disposal Facility | 2022 | 2050 | a | a | a | a | a | | a | a | a | a | a | |
| Closure | | | | | | | | | | | | | | |
| Integrated Disposal Facility, 200-East Area | 2051 | 2052 | 1.62×10 ⁴ | 2.50×10 ³ | 7.26 | a | a | | 2.22×10 ¹ | 7.96 | 1.50 | 1.41×10 ⁻² | | |
| Integrated Disposal Facility, 200-West Area | 2051 | 2052 | 2.71×10 ³ | 4.97×10 ² | 1.29 | a | a | | 3.76 | 1.45 | 2.95×10 ⁻¹ | 1.88×10 ⁻³ | | |
| Postclosure care, Integrated Disposal Facility, 200-East Area | 2053 | 2152 | a | a | a | a | a | | a | a | a | a | | |
| Postclosure care, Integrated Disposal Facility, 200-West Area | 2053 | 2152 | a | a | a | a | a | | a | a | a | a | | |
| River Protection Project Disposal Facility | 2051 | 2052 | 3.24×10 ⁴ | 5.19×10 ³ | 1.15×10 ¹ | a | a | | 4.45×10 ¹ | 1.51×10 ¹ | 3.08 | 2.28×10 ⁻² | | |
| Postclosure care, River Protection Project Disposal Facility | 2053 | 2152 | a | a | a | a | a | | a | a | a | a | | |
| Total | | | 5.12×10⁴ | 8.19×10³ | 2.01×10¹ | 3.42×10³ | 2.72×10¹ | | 7.05×10¹ | 2.45×10¹ | 4.88 | 3.88×10⁻² | | |

a This activity would not contribute to the concentration during the peak year(s) for this pollutant and averaging period.

Note: Total concentrations exceeding applicable standards are presented in bold.

Key: PM₁₀=particulate matter with an aerodynamic diameter less than or equal to 10 micrometers.

Source: SAIC 2007c.

Table G-162. Waste Management Alternative 3, Disposal Group 1, Maximum Toxic Pollutant Concentrations of Peak Activity Periods

| Facility/System | Start Year | End Year | Concentration (micrograms per cubic meter) | | | | | | | |
|---|------------|----------|--|-----------------------|-----------------------|-----------------------|-----------------|-----------------------|-----------------------|---|
| | | | Ammonia 24-hour | Benzene Annual | 1,3-Butadiene Annual | Formaldehyde Annual | Mercury 24-hour | Toluene 24-hour | Xylene 24-hour | |
| | | | 2051-2052 | 2051-2052 | 2051-2052 | 2051-2052 | c | 2051-2052 | 2051-2052 | |
| Construction | | | | | | | | | | |
| Integrated Disposal Facility, 200-East Area | 2006 | 2008 | a | a | a | a | b | a | a | a |
| Integrated Disposal Facility, 200-West Area | 2006 | 2008 | a | a | a | a | b | a | a | a |
| River Protection Project Disposal Facility | 2019 | 2021 | a | a | a | a | a | a | a | a |
| Operations | | | | | | | | | | |
| Low-level radioactive waste burial grounds | 2007 | 2050 | a | a | a | a | a | a | a | a |
| Integrated Disposal Facility, 200-East Area | 2009 | 2050 | a | a | a | a | a | a | a | a |
| Integrated Disposal Facility, 200-West Area | 2009 | 2050 | a | a | a | a | a | a | a | a |
| River Protection Project Disposal Facility | 2022 | 2050 | a | a | a | a | a | a | a | a |
| Closure | | | | | | | | | | |
| Integrated Disposal Facility, 200-East Area | 2051 | 2052 | 1.25 | 2.61×10^{-3} | 6.87×10^{-5} | 2.26×10^{-3} | a | 1.91 | 5.68×10^{-1} | |
| Integrated Disposal Facility, 200-West Area | 2051 | 2052 | 3.23×10^{-1} | 4.06×10^{-4} | 1.20×10^{-5} | 3.84×10^{-4} | a | 3.54×10^{-1} | 1.08×10^{-1} | |
| Postclosure care, Integrated Disposal Facility, 200-East Area | 2053 | 2152 | a | a | a | a | a | a | a | a |
| Postclosure care, Integrated Disposal Facility, 200-West Area | 2053 | 2152 | a | a | a | a | a | a | a | a |
| River Protection Project Disposal Facility | 2051 | 2052 | 2.52 | 4.19×10^{-3} | 1.09×10^{-4} | 3.60×10^{-3} | a | 3.94 | 1.17 | |
| Postclosure care, River Protection Project Disposal Facility | 2053 | 2152 | a | a | a | a | a | a | a | a |
| Total | | | 4.09 | 7.21×10^{-3} | 1.90×10^{-4} | 6.25×10^{-3} | 0 | 6.20 | 1.84 | |

a This activity would not contribute to the concentration during the peak year(s) for this pollutant and averaging period.
 b Emissions for this activity and pollutant were not calculated because they would be small compared with those for other activities under this alternative, as explained in Section G.2.
 c There is no peak year because no emissions were calculated.
Source: SAIC 2007c.

Table G-163. Waste Management Alternative 3, Disposal Group 2, Maximum Criteria Pollutant Concentrations of Peak Activity Periods

| Facility/System | Start Year | End Year | Concentration (micrograms per cubic meter) | | | | | | | | | | |
|---|------------|----------|--|----------------------------|-----------------------|----------------------------|----------------------------|----------------------|-----------------------|-----------------------|-----------------------|-----------|-----------|
| | | | Carbon Monoxide | | Nitrogen Dioxide | | PM ₁₀ | | Sulfur Dioxide | | Annual | 2101-2102 | |
| | | | 1-hour | 8-hour | Annual | 24-hour | 2019-2021 | 2019-2021 | 2019-2021 | 2019-2021 | | | 2019-2021 |
| Construction | | | | | | | | | | | | | |
| Integrated Disposal Facility, 200-East Area | 2006 | 2008 | a | a | a | a | a | a | a | a | a | a | a |
| Integrated Disposal Facility, 200-West Area | 2006 | 2008 | a | a | a | a | a | a | a | a | a | a | a |
| River Protection Project Disposal Facility | 2019 | 2021 | a | a | a | 1.68×10 ⁴ | 1.24×10 ² | a | a | a | a | a | a |
| Operations | | | | | | | | | | | | | |
| Low-level radioactive waste burial grounds | 2007 | 2050 | a | a | a | 7.67×10 ¹ | 4.91×10 ⁻¹ | a | a | a | a | a | a |
| Integrated Disposal Facility, 200-East Area | 2009 | 2100 | a | a | a | 3.21×10 ² | 3.02 | a | a | a | a | a | a |
| Integrated Disposal Facility, 200-West Area | 2009 | 2050 | a | a | a | 1.52×10 ² | 9.70×10 ⁻¹ | a | a | a | a | a | a |
| River Protection Project Disposal Facility | 2022 | 2100 | a | a | a | a | a | a | a | a | a | a | a |
| Closure | | | | | | | | | | | | | |
| Integrated Disposal Facility, 200-East Area | 2101 | 2102 | 5.38×10 ³ | 8.32×10 ² | 2.62 | a | a | 7.41 | 2.65 | 5.00×10 ⁻¹ | 4.71×10 ⁻³ | a | a |
| Integrated Disposal Facility, 200-West Area | 2051 | 2052 | a | a | a | a | a | a | a | a | a | a | a |
| Postclosure care, Integrated Disposal Facility, 200-East Area | 2103 | 2202 | a | a | a | a | a | a | a | a | a | a | a |
| Postclosure care, Integrated Disposal Facility, 200-West Area | 2053 | 2152 | 1.85×10 ¹ | 3.38 | 3.57×10 ⁻³ | a | a | 2.51×10 ² | 9.67×10 ⁻³ | 1.97×10 ⁻³ | 1.26×10 ⁻⁵ | a | a |
| River Protection Project Disposal Facility | 2101 | 2102 | 2.51×10 ⁵ | 4.02×10 ⁴ | 8.93×10 ⁻¹ | a | a | 3.45×10 ² | 1.17×10 ² | 2.39×10 ¹ | 1.77×10 ⁻¹ | a | a |
| Postclosure care, River Protection Project Disposal Facility | 2103 | 2202 | a | a | a | a | a | a | a | a | a | a | a |
| Total | | | 2.56×10⁵ | 4.10×10⁴ | 9.20×10 ¹ | 1.73×10⁴ | 1.28×10² | 3.52×10 ² | 1.20×10 ² | 2.44×10 ¹ | 1.81×10 ⁻¹ | | |

a This activity would not contribute to the concentration during the peak year(s) for this pollutant and averaging period.

Note: Total concentrations exceeding applicable standards are presented in bold.

Key: PM₁₀=particulate matter with an aerodynamic diameter less than or equal to 10 micrometers.

Source: SAIC 2007c.

Table G-164. Waste Management Alternative 3, Disposal Group 2, Maximum Toxic Pollutant Concentrations of Peak Activity Periods

| Facility/System | Start Year | End Year | Concentration (micrograms per cubic meter) | | | | | | | | | | | | | |
|---|------------|----------|--|-----------------------|-----------------------|-----------------------|-----------------------|-----------------------|--------------|-----------|-----------|-----------|-----------|-----------|-----------|--------|
| | | | Ammonia | | Benzene | | 1,3-Butadiene | | Formaldehyde | | Mercury | | Toluene | | Xylene | |
| | | | 24-hour | Annual | 24-hour | Annual | Annual | Annual | Annual | Annual | 24-hour | Annual | 24-hour | Annual | 24-hour | Annual |
| | | | 2101-2102 | 2101-2102 | 2101-2102 | 2101-2102 | 2101-2102 | 2101-2102 | 2101-2102 | 2101-2102 | 2101-2102 | 2101-2102 | 2101-2102 | 2101-2102 | 2101-2102 | |
| Construction | | | | | | | | | | | | | | | | |
| Integrated Disposal Facility, 200-East Area | 2006 | 2008 | a | a | a | a | a | a | a | a | a | a | a | a | a | a |
| Integrated Disposal Facility, 200-West Area | 2006 | 2008 | a | a | a | a | a | a | a | a | a | a | a | a | a | a |
| River Protection Project Disposal Facility | 2019 | 2021 | a | a | a | a | a | a | a | a | a | a | a | a | a | a |
| Operations | | | | | | | | | | | | | | | | |
| Low-level radioactive waste burial grounds | 2007 | 2050 | a | a | a | a | a | a | a | a | a | a | a | a | a | a |
| Integrated Disposal Facility, 200-East Area | 2009 | 2100 | a | a | a | a | a | a | a | a | a | a | a | a | a | a |
| Integrated Disposal Facility, 200-West Area | 2009 | 2050 | a | a | a | a | a | a | a | a | a | a | a | a | a | a |
| River Protection Project Disposal Facility | 2022 | 2100 | a | a | a | a | a | a | a | a | a | a | a | a | a | a |
| Closure | | | | | | | | | | | | | | | | |
| Integrated Disposal Facility, 200-East Area | 2101 | 2102 | 4.48×10 ⁻¹ | 9.07×10 ⁻⁴ | 2.46×10 ⁻⁵ | 8.05×10 ⁻⁴ | 6.27×10 ⁻¹ | 1.87×10 ⁻¹ | | | | | | | | |
| Integrated Disposal Facility, 200-West Area | 2051 | 2052 | a | a | a | a | a | a | a | a | a | a | a | a | a | a |
| Postclosure care, Integrated Disposal Facility, 200-East Area | 2103 | 2202 | a | a | a | a | a | a | a | a | a | a | a | a | a | a |
| Postclosure care, Integrated Disposal Facility, 200-West Area | 2053 | 2152 | 9.27×10 ⁻⁴ | 1.81×10 ⁻⁶ | 3.59×10 ⁻⁸ | 1.27×10 ⁻⁶ | 2.69×10 ⁻³ | 7.79×10 ⁻⁴ | | | | | | | | |
| River Protection Project Disposal Facility | 2101 | 2102 | 1.95×10 ¹ | 3.25×10 ⁻² | 8.46×10 ⁻⁴ | 2.79×10 ⁻² | 3.05×10 ¹ | 9.06 | | | | | | | | |
| Postclosure care, River Protection Project Disposal Facility | 2103 | 2202 | a | a | a | a | a | a | a | a | a | a | a | a | a | a |
| Total | | | 2.00×10 ¹ | 3.34×10 ⁻² | 8.71×10 ⁻⁴ | 2.87×10 ⁻² | 3.11×10 ¹ | 9.25 | | | | | | | | |

a This activity would not contribute to the concentration during the peak year(s) for this pollutant and averaging period.

b Emissions for this activity and pollutant were not calculated because they would be small compared with those for other activities under this alternative, as explained in Section G.2.

c There is no peak year because no emissions were calculated.

Source: SAIC 2007c.

Table G-165. Waste Management Alternative 3, Disposal Group 3, Maximum Criteria Pollutant Concentrations of Peak Activity Periods

| Facility/System | Start Year | End Year | Concentration (micrograms per cubic meter) | | | | | | | | | | |
|---|------------|----------|--|----------------------------|----------------------------|----------------------------|----------------------------|----------------------------|----------------------------|----------------------------|-----------------------------|---------------------|---|
| | | | Carbon Monoxide | | Nitrogen Dioxide | | PM ₁₀ | | Sulfur Dioxide | | | | |
| | | | 1-hour 2166-2167 | 8-hour 2166-2167 | Annual 2166-2167 | Annual 2166-2167 | 24-hour 2019-2021 | Annual 2019-2021 | 1-hour 2166-2167 | 3-hour 2166-2167 | 24-hour 2166-2167 | Annual 2166-2167 | |
| Construction | | | | | | | | | | | | | |
| Integrated Disposal Facility, 200-East Area | 2006 | 2008 | a | a | a | a | a | a | a | a | a | a | a |
| Integrated Disposal Facility, 200-West Area | 2006 | 2008 | a | a | a | a | a | a | a | a | a | a | a |
| River Protection Project Disposal Facility | 2019 | 2021 | a | a | a | 1.68×10 ⁴ | 1.24×10 ² | a | a | a | a | a | a |
| Operations | | | | | | | | | | | | | |
| Low-level radioactive waste burial grounds | 2007 | 2050 | a | a | a | 7.67×10 ¹ | 4.91×10 ⁻¹ | a | a | a | a | a | a |
| Integrated Disposal Facility, 200-East Area | 2009 | 2165 | a | a | a | 3.21×10 ² | 3.02 | a | a | a | a | a | a |
| Integrated Disposal Facility, 200-West Area | 2009 | 2050 | a | a | a | 1.52×10 ² | 9.70×10 ⁻¹ | a | a | a | a | a | a |
| River Protection Project Disposal Facility | 2022 | 2165 | a | a | a | a | a | a | a | a | a | a | a |
| Closure | | | | | | | | | | | | | |
| Integrated Disposal Facility, 200-East Area | 2166 | 2167 | 5.38×10 ³ | 8.32×10 ² | 2.62 | a | a | 7.41 | 2.65 | 5.00×10 ⁻¹ | 4.71×10 ⁻³ | a | a |
| Integrated Disposal Facility, 200-West Area | 2051 | 2052 | a | a | a | a | a | a | a | a | a | a | a |
| Postclosure care, Integrated Disposal Facility, 200-East Area | 2168 | 2267 | a | a | a | a | a | a | a | a | a | a | a |
| Postclosure care, Integrated Disposal Facility, 200-West Area | 2053 | 2152 | a | a | a | a | a | a | a | a | a | a | a |
| River Protection Project Disposal Facility | 2166 | 2167 | 2.51×10 ⁵ | 4.02×10 ⁴ | 8.93×10 ¹ | a | a | 3.45×10 ² | 1.17×10 ² | 2.39×10 ¹ | 1.77×10 ⁻¹ | a | a |
| Postclosure care, River Protection Project Disposal Facility | 2168 | 2267 | a | a | a | a | a | a | a | a | a | a | a |
| Total | | | 2.56×10⁵ | 4.10×10⁴ | 9.20×10¹ | 1.73×10⁴ | 1.28×10² | 3.52×10² | 1.20×10² | 2.44×10¹ | 1.81×10⁻¹ | | |

a This activity would not contribute to the concentration during the peak year(s) for this pollutant and averaging period.

Note: Total concentrations exceeding applicable standards are presented in bold.

Key: PM₁₀=particulate matter with an aerodynamic diameter less than or equal to 10 micrometers.

Source: SAIC 2007c.

Table G-166. Waste Management Alternative 3, Disposal Group 3, Maximum Toxic Pollutant Concentrations of Peak Activity Periods

| Facility/System | Start Year | End Year | Concentration (micrograms per cubic meter) | | | | | | | |
|---|------------|----------|--|-----------------------|-----------------------|-----------------------|-----------------|-----------------|-----------------------|-----------------------|
| | | | Ammonia 24-hour | Benzene Annual | 1,3-Butadiene Annual | Formaldehyde Annual | Mercury 24-hour | Toluene 24-hour | Xylene 24-hour | |
| | | | 2166-2167 | 2166-2167 | 2166-2167 | 2166-2167 | c | 2166-2167 | 2166-2167 | |
| Construction | | | | | | | | | | |
| Integrated Disposal Facility, 200-East Area | 2006 | 2008 | a | a | a | a | a | b | a | a |
| Integrated Disposal Facility, 200-West Area | 2006 | 2008 | a | a | a | a | a | b | a | a |
| River Protection Project Disposal Facility | 2019 | 2021 | a | a | a | a | a | a | a | a |
| Operations | | | | | | | | | | |
| Low-level radioactive waste burial grounds | 2007 | 2050 | a | a | a | a | a | a | a | a |
| Integrated Disposal Facility, 200-East Area | 2009 | 2165 | a | a | a | a | a | a | a | a |
| Integrated Disposal Facility, 200-West Area | 2009 | 2050 | a | a | a | a | a | a | a | a |
| River Protection Project Disposal Facility | 2022 | 2165 | a | a | a | a | a | a | a | a |
| Closure | | | | | | | | | | |
| Integrated Disposal Facility, 200-East Area | 2166 | 2167 | 4.48×10^{-1} | 9.07×10^{-4} | 2.46×10^{-5} | 8.05×10^{-4} | a | a | 6.27×10^{-1} | 1.87×10^{-1} |
| Integrated Disposal Facility, 200-West Area | 2051 | 2052 | a | a | a | a | a | a | a | a |
| Postclosure care, Integrated Disposal Facility, 200-East Area | 2168 | 2267 | a | a | a | a | a | a | a | a |
| Postclosure care, Integrated Disposal Facility, 200-West Area | 2053 | 2152 | a | a | a | a | a | a | a | a |
| River Protection Project Disposal Facility | 2166 | 2167 | 1.95×10^1 | 3.25×10^{-2} | 8.46×10^{-4} | 2.79×10^{-2} | a | a | 3.05×10^1 | 9.06 |
| Postclosure care, River Protection Project Disposal Facility | 2168 | 2267 | a | a | a | a | a | a | a | a |
| Total | | | 2.00×10^1 | 3.34×10^{-2} | 8.71×10^{-4} | 2.87×10^{-2} | 0 | 0 | 3.11×10^1 | 9.25 |

a This activity would not contribute to the concentration during the peak year(s) for this pollutant and averaging period.
 b Emissions for this activity and pollutant were not calculated because they would be small compared with those for other activities under this alternative, as explained in Section G.2.
 c There is no peak year because no emissions were calculated.

Source: SAIC 2007c.

G.4 GENERAL CONFORMITY REVIEW

The Clean Air Act, as amended, requires that Federal actions conform to the host state’s “state implementation plan.” A state implementation plan provides for the implementation, maintenance, and enforcement of NAAQS for the six criteria pollutants: sulfur dioxide, PM₁₀, carbon monoxide, ozone, nitrogen dioxide, and lead. Its purpose is to eliminate or reduce the severity and number of NAAQS violations and to expedite the attainment of these standards. “No department, agency, or instrumentality of the Federal Government shall engage in or support in any way or provide financial assistance for, license or permit, or approve any activity that does not conform to an applicable implementation plan.” The final rule for “Determining Conformity of General Federal Actions to State or Federal Implementation Plans” (40 CFR 51.850–51.860) took effect on January 31, 1994. Hanford and INL are within areas currently designated as attainment for criteria air pollutants (40 CFR 81.348 and 81.313, respectively). Therefore, the alternatives being considered in this *TC & WM EIS* do not require a conformity determination under the provisions of this rule.

G.5 GREENHOUSE GASES

The “natural greenhouse effect” is the process by which part of the terrestrial radiation is absorbed by gases in the atmosphere, thereby warming the Earth’s surface and atmosphere. This greenhouse effect and the Earth’s radiation balance are affected largely by water vapor, carbon dioxide, and trace gases, all absorbers of infrared radiation and commonly referred to as “greenhouse gases.” Other trace gases include nitrous oxide, chlorofluorocarbons, and methane.

Judging from fiscal year 2006 fuel use (see Chapter 3, Section 3.2), Hanford emissions of carbon dioxide are estimated to be 1.42×10^4 metric tons per year, which is less than 0.0002 percent of the total U.S. emissions of 6.09 billion metric tons per year (EPA 2007b). Carbon dioxide equivalents of other greenhouse gases that may be emitted from activities at Hanford are not included in this estimate. Based on the fuel consumption averages for INL (see Chapter 3, Section 3.3), INL emissions of carbon dioxide are estimated to be 3.52×10^4 metric tons per year, which is less than 0.0006 percent of the total U.S. emissions per year.

Emissions of carbon dioxide by alternative are provided in Table G–167. Additional discussion of greenhouse gases is provided in Chapter 6, Section 6.5.

**Table G–167. Estimated Annual Average Carbon Dioxide
Emissions by Alternative**

| Alternative | Emissions (metric tons per year) |
|--------------------------------|-------------------------------------|
| Tank Closure (TC) | |
| TC Alternative 1 | 1.07×10^4 |
| TC Alternative 2A | 7.03×10^4 |
| TC Alternative 2B | 7.59×10^4 |
| TC Alternative 3A | 3.53×10^4 |
| TC Alternative 3B | 3.6×10^4 |
| TC Alternative 3C | 5.39×10^4 |
| TC Alternative 4 | 3.92×10^4 |
| TC Alternative 5 | 8.29×10^4 |
| TC Alternative 6A, Base Case | 2.39×10^5 |
| TC Alternative 6A, Option Case | 2.46×10^5 |
| TC Alternative 6B, Base Case | 5.81×10^4 |

Table G–167. Estimated Annual Average Carbon Dioxide Emissions by Alternative (continued)

| Alternative | Emissions (metric tons per year) |
|---|-------------------------------------|
| Tank Closure (TC) (continued) | |
| TC Alternative 6B, Option Case | 6.85×10^4 |
| TC Alternative 6C | 7.61×10^4 |
| FFTF Decommissioning | |
| FFTF Decommissioning Alternative 1 | 2.75 |
| FFTF Decommissioning Alternative 2 ^a | 1.98×10^3 |
| FFTF Decommissioning Alternative 3 ^a | 1.54×10^2 |
| Waste Management (WM) | |
| WM Alternative 1 | 1.23×10^3 |
| WM Alternative 2 | 4.1×10^4 |
| WM Alternative 2, Disposal Group 1 | 4.11×10^3 |
| WM Alternative 2, Disposal Group 2 | 2.02×10^4 |
| WM Alternative 2, Disposal Group 3 | 2.33×10^4 |
| WM Alternative 3 | 4.1×10^4 |
| WM Alternative 3, Disposal Group 1 | 5.03×10^3 |
| WM Alternative 3, Disposal Group 2 | 2.11×10^4 |
| WM Alternative 3, Disposal Group 3 | 2.38×10^4 |

^a Including emissions for options at Idaho National Laboratory.

Key: FFTF=Fast Flux Test Facility.

G.6 REFERENCES

Burk, K.W., 2007, Battelle, Pacific Northwest National Laboratory, Richland, Washington, personal communication (email) to K.W. Owens, Science Applications International Corporation, Germantown, Maryland, “JFDs,” May 15.

CEES (Columbia Energy & Environmental Services, Inc.), 2006a, *Steam Reforming Air Emissions Calculations*, WT-ST-048, Rev. 2, Richland, Washington, October 16.

CEES (Columbia Energy & Environmental Services, Inc.), 2006b, *Air Emissions for Deploying 3 LAW Melters in the WTP*, WT-ST-031, Rev. 6, Richland, Washington, October 18.

CEES (Columbia Energy & Environmental Services, Inc.), 2006c, *Air Emission Calculations for WTP 2×6 Melter Configuration*, WT-ST-060, Rev. 1, Richland, Washington, October 18.

CEES (Columbia Energy & Environmental Services, Inc.), 2007, *Revision to Air Emissions for WTP 2×2 Melter Configuration*, WT-ST-033, Rev. 4, Richland, Washington, January 18.

DOE (U.S. Department of Energy), 2003, *Environmental Impact Statement for Retrieval, Treatment, and Disposal of Tank Wastes and Closure of Single-Shell Tanks at the Hanford Site, Richland, WA: Inventory and Source Term Data Package*, DOE/ORP-2003-02, Rev. 0, Office of River Protection, Richland, Washington, April 17.

EPA (U.S. Environmental Protection Agency), 1992, *Screening Procedures for Estimating the Air Quality Impact of Stationary Sources, Revised*, EPA-454/R-92-019, Office of Air and Radiation, Research Triangle Park, North Carolina, October.

EPA (U.S. Environmental Protection Agency), 1996, *Compilation of Air Pollutant Emission Factors*, Vol. 1, *Stationary Point and Area Sources*, 5th ed., AP-42, Office of Air and Radiation, Office of Air Quality Planning and Standards, Research Triangle Park, North Carolina, January.

EPA (U.S. Environmental Protection Agency), 2003a, *Factors Information Retrieval System*, Version 6.23, accessed through <http://www.epa.gov/ttn/chief/software/fire.index.html>.

EPA (U.S. Environmental Protection Agency), 2003b, *User's Guide to MOBILE6.1 and MOBILE6.2: Mobile Source Emission Factor Model*, EPA420-R-03-010, Office of Transportation and Air Quality, Assessment and Standards Division, August.

EPA (U.S. Environmental Protection Agency), 2004, *User's Guide for the AMS/EPA Regulatory Model – AERMOD*, EPA-454/B-03-001, Office of Air Quality Planning and Standards, Emissions Monitoring and Analysis Division, Research Triangle Park, North Carolina, September.

EPA (U.S. Environmental Protection Agency), 2007a, *2002 National Emissions Inventory Database: On-road Vehicle Data for Adams, Benton, Franklin, and Grant Counties*, Onroad_CAP2002v3_071010), accessed through <http://www.epa.gov/ttn/chief/net/2002inventory.html>, October 15.

EPA (U.S. Environmental Protection Agency), 2007b, *Inventory of U.S. Greenhouse Gas Emissions and Sinks: 1990–2005*, EPA 430-R-07-002, Washington, D.C., April 15.

Fluor Hanford (Fluor Hanford, Inc.), 2002, *Environmental Releases for Calendar Year 2001*, HNF-EP-0527, Rev. 11, Richland, Washington, August.

Fluor Hanford (Fluor Hanford, Inc.), 2003, *Environmental Releases for Calendar Year 2002*, HNF-EP-0527, Rev. 12, Richland, Washington, August.

Sagendorf, J.F., J.T. Goll, and W.F. Sandusky, 1982, *XOQDOQ: Computer Program for the Meteorological Evaluation of Routine Effluent Releases at Nuclear Power Stations*, NUREG/CR-2919, U.S. Nuclear Regulatory Commission, Office of Nuclear Reactor Regulation, Division of Systems Integration, September.

SAIC (Science Applications International Corporation), 2007a, *Tank Closure Alternatives, Scaled Data Sets to Support the “Tank Closure and Waste Management Environmental Impact Statement for the Hanford Site, Richland, Washington,”* Germantown, Maryland, July 12.

SAIC (Science Applications International Corporation), 2007b, *Fast Flux Test Facility Alternatives, Scaled Data Sets to Support the “Tank Closure and Waste Management Environmental Impact Statement for the Hanford Site, Richland, Washington,”* Germantown, Maryland, July 12.

SAIC (Science Applications International Corporation), 2007c, *Waste Management Alternatives, Scaled Data Sets to Support the “Tank Closure and Waste Management Environmental Impact Statement for the Hanford Site, Richland, Washington,”* Germantown, Maryland, July 12.

SAIC (Science Applications International Corporation), 2008, *Revised Scaled Data Sets to Support the “Tank Closure and Waste Management Environmental Impact Statement for the Hanford Site, Richland, Washington,”* Germantown, Maryland, October 9.

Slaathaug, E.J., 1995, *Tri-Party Agreement Alternative Engineering Data Package for the “Tank Waste Remediation System Environmental Impact Statement,”* WHC-SD-WM-EV-104, Rev. 0, Westinghouse Hanford Company, Richland, Washington, July.

Code of Federal Regulations

40 CFR 50, U.S. Environmental Protection Agency, “National Primary and Secondary Ambient Air Quality Standards.”

40 CFR 51.850–51.860, U.S. Environmental Protection Agency, “Requirements for Preparation, Adoption, and Submittal of Implementation Plans,” Subpart W, “Determining Conformity of General Federal Actions to State or Federal Implementation Plans.”

40 CFR 81.313, U.S. Environmental Protection Agency, “Designation of Areas for Air Quality Planning Purposes,” Subpart C, Section 107, “Attainment Status Designations: Idaho.”

40 CFR 81.348, U.S. Environmental Protection Agency, “Designation of Areas for Air Quality Planning Purposes,” Subpart C, Section 107, “Attainment Status Designations: Washington.”

Washington Administrative Code

WAC 173-460, Washington State Department of Ecology, “Control of New Sources of Toxic Air Pollutants,” Olympia, Washington, July 1998.

WAC 173-470, Washington State Department of Ecology, “Ambient Air Quality Standards for Particulate Matter,” Olympia, Washington, January 1989.

WAC 173-474, Washington State Department of Ecology, “Ambient Air Quality Standards for Sulfur Oxides,” Olympia, Washington, September 1987.

WAC 173-475, Washington State Department of Ecology, “Ambient Air Quality Standards for Carbon Monoxide, Ozone, and Nitrogen Dioxide,” Olympia, Washington, February 1980.

WAC 173-481, Washington State Department of Ecology, “Ambient Air Quality and Environmental Standards for Fluorides,” Olympia, Washington, August 2005.

WAC 173-490, Washington State Department of Ecology, “Emissions Standards and Controls for Sources Emitting Volatile Organic Compounds (VOC),” Olympia, Washington, February 1998.

APPENDIX H TRANSPORTATION

This appendix provides an overview of the approach used to assess the potential human health risks from transportation activities. Topics include the scope of the assessment; packaging and transportation regulations; determination of potential transportation routes; analytical methods used for the risk assessment (e.g., computer models); and important assessment assumptions. The results of this assessment are expressed in terms of doses and risks to transportation workers and the exposed population from both incident-free operations and accident conditions. In addition, to aid in understanding and interpreting the results, specific areas of uncertainty are described with an emphasis on how these uncertainties may affect comparisons among alternatives.

H.1 INTRODUCTION

Transportation of any commodity involves a risk to both transportation crewmembers and members of the public. This risk results directly from transportation-related accidents and indirectly from increased levels of pollution from vehicle emissions, regardless of the cargo. Transportation of certain materials, such as hazardous or radioactive waste, can pose an additional risk due to the unique nature of the materials themselves. To permit a complete appraisal of the environmental impacts of the proposed actions and alternatives analyzed in this **Tank Closure and Waste Management Environmental Impact Statement for the Hanford Site, Richland, Washington (TC & WM EIS)**, the human health risks associated with the transportation of radioactive materials on public highways and railroads were assessed. The anticipated impacts of each alternative are presented, including projected doses and health effects.

Risk assessment results are presented in this appendix in terms of “per-shipment” risk factors, as well as the total risks under a given alternative. Per-shipment risk factors are used to estimate the risk from a single shipment. The total risks under a given alternative are estimated by multiplying the expected number of shipments by the appropriate per-shipment risk factors.

H.2 ASSESSMENT SCOPE

This section describes the scope of the transportation human health risk assessment, including the alternatives and options, transportation activities, potential radiological and nonradiological impacts, transportation modes, and receptors considered. Several shipping arrangements for various radioactive wastes, involving both onsite and offsite public highways and rail systems, are being considered to cover all of the alternatives evaluated. Additional assessment details are provided in the remaining sections of this appendix.

H.2.1 Transportation-Related Activities

The transportation risk assessment is limited to estimating the human health risks related to transportation under each alternative. The risks to workers and the public during loading, unloading, and handling prior to a shipment under each alternative are provided in the “Public and Occupational Health and Safety—Facility Accidents” and “Public and Occupational Health and Safety—Normal Operations” sections in Chapter 4 of this environmental impact statement (EIS). The impacts of increased transportation levels on local traffic flow or infrastructure under each alternative are addressed in the “Local Transportation” subsections in the “Socioeconomics” sections of Chapter 4.

H.2.2 Radiological Impacts

The risk to the affected population is a measure of the radiological risk posed to society as a whole by the alternative being considered. As such, the impact on the affected population is used as the primary means of comparing various alternatives. For each alternative, radiological risks (risks that result from the radioactive nature of the materials) of transportation were assessed for both incident-free (normal) and accident conditions. The radiological risk associated with incident-free transportation conditions would result from the potential exposure of people to external radiation in the vicinity of a shipment. The radiological risk from transportation accidents would come from the potential release and dispersal of radioactive material into the environment during an accident and the subsequent exposure of members of the public.

All radiological impacts are calculated in terms of the committed dose received by the exposed populations and its associated health effects. The calculated radiation dose is the total effective dose equivalent (10 CFR 20), the sum of the effective dose equivalent from external radiation exposure and the 50-year committed effective dose equivalent from internal radiation exposure. Radiation doses are presented in units of roentgen equivalent man (rem) for individuals and person-rem for collective populations. The impacts are further expressed as health risks in terms of latent cancer fatalities (LCFs) in exposed populations using the dose-to-risk conversion factors recommended by the U.S. Department of Energy's (DOE's) Office of National Environmental Policy Act Policy and Compliance, which are based on Interagency Steering Committee on Radiation Safety guidance (DOE 2003).

H.2.3 Nonradiological Impacts

In addition to the radiological risks posed by transportation activities, nonradiological, vehicle-related risks (risks unrelated to radioactive cargo) are assessed for the same transportation routes. Nonradiological transportation risks, which would be incurred for similar shipments of any commodity, are assessed for both incident-free and accident conditions. The nonradiological accident risk refers to the potential occurrence of transportation accidents resulting in fatalities unrelated to the shipment of cargo. Nonradiological risks are presented in terms of estimated fatalities.

Nonradiological risks during incident-free transportation conditions could be caused by potential exposure to increased vehicle exhaust emissions. As explained in Section H.5.2, these emission impacts were not considered.

H.2.4 Transportation Modes

All shipments were assumed to use either dedicated truck or rail transportation modes.

H.2.5 Receptors

Transportation-related risks were calculated and presented separately for workers and members of the general public. The workers considered were truck and rail crewmembers involved in transportation and inspection of the packages. The general public included all persons who could be exposed to a shipment while it is either moving or stopped during transit. Potential risks were estimated for the affected populations and for a hypothetical maximally exposed individual (MEI). For incident-free operation, the affected population included individuals living within 800 meters (0.5 miles) of each side of the road or rail, and the MEI was a resident living near the highway or railroad, who would be exposed to all shipments transported by road or rail. For accident conditions, the affected population included individuals residing within 80 kilometers (50 miles) of the accident, and the MEI was an individual located 100 meters (330 feet) directly downwind from the accident.

H.3 PACKAGING AND TRANSPORTATION REGULATIONS

H.3.1 Packaging Regulations

The primary regulatory approach to promoting safety from radiological exposure is specification of standards for the packaging of radioactive materials. Packaging represents the primary barrier between the radioactive material being transported and the public, workers, and environment. Transportation packaging for radioactive materials must be designed, constructed, and maintained to contain and shield its contents during normal transport conditions. For highly radioactive material, such as high-level radioactive waste (HLW) or spent nuclear fuel (SNF), packaging must contain and shield its contents in the event of severe accident conditions. The type of packaging used is determined by the total radioactive hazard presented by the material to be packaged. Four basic types of packaging are used: Excepted, Industrial, Type A, and Type B.

Excepted packages are limited to transporting materials with extremely low levels of radioactivity. Industrial packages are used to transport materials that, because of their low concentration of radioactive materials, present a limited hazard to the public and the environment. Type A containers and packages are designed to protect and retain their contents under normal transportation conditions and to provide sufficient shielding to limit radiation exposure to handling personnel. Type B containers and packages are used to transport material with the highest radioactivity levels and are designed to protect and retain their contents under transportation accident conditions (for more detail, see the following sections).

Radioactive materials shipped in Type A containers or packages are subject to specific radioactivity limits, identified as A1 and A2 values in Title 49 of the **Code of Federal Regulations (CFR)**, Section 173.435 (49 CFR 173.435). In addition, external radiation limits, as prescribed in Title 49 of the CFR, Section 173.441 (49 CFR 173.441), must be met. If the A1 or A2 limits are exceeded and material does not meet the low-specific-activity definition and requirements, the material must be shipped in a Type B container. If the material qualifies as having a low specific activity (number of decays per second per amount of substance), as defined in Title 10 of the **CFR**, Part 71 (10 CFR 71) and Title 49 of the CFR, Part 173 (49 CFR 173), it may be shipped in an approved low-specific-activity shipping container that meets the requirements of Title 49 of the CFR, Section 173.427(b)(4), such as Industrial or Type A packaging. Type B containers or casks are subject to the radiation limits in 49 CFR 173.441, but no quantity limits are imposed except in the case of fissile materials and plutonium.

Type A packages are designed to retain their radioactive contents in normal transport. Under normal conditions, a Type A package must withstand the following conditions:

- Operating temperatures ranging from –40 degrees Celsius (°C) to 70 °C (–40 degrees Fahrenheit [°F] to 158 °F)
- A reduction of ambient pressure to 25 kilopascals (3.6 pounds per square inch), such that the containment system will retain its radioactive contents
- Normal vibration experienced during transportation
- Simulated rainfall of 5 centimeters (2 inches) per hour for 1 hour
- Free fall from 0.3 to 1.2 meters (1 to 4 feet), depending on the package weight
- Water immersion-compression tests

- Impact of a 6-kilogram (13.2-pound) steel cylinder with rounded ends dropped from 1 meter (40 inches) onto the most vulnerable surface
- Five times the mass of the gross weight of the package for 24 hours

Type B packages are designed to retain their radioactive contents under both normal and accident conditions. In addition to the testing for normal transportation conditions outlined above, a Type B package must withstand:

- Free drop from 9.1 meters (30 feet) onto an unyielding surface in a way most likely to cause damage
- Free drop from 1 meter (3.3 feet) onto the end of a 15-centimeter-diameter (6-inch-diameter) vertical steel bar
- Exposure to temperatures of 800 °C (1,475 °F) for at least 30 minutes
- Immersion in at least 15 meters (50 feet) of water for 8 hours
- For some packages, immersion in at least 0.9 meters (3 feet) of water for 8 hours in an orientation most likely to result in leakage

Compliance with these requirements is demonstrated by using a combination of simple calculating methods, computer modeling techniques, and scale-model or full-scale testing of packages.

H.3.2 Transportation Regulations

The regulatory standards for packaging and transporting radioactive materials are designed to achieve four primary objectives:

- Protect persons and property from radiation emitted from packages during transportation by specific limitations on the allowable radiation levels.
- Contain radioactive material in the package (achieved by packaging design requirements based on performance-oriented packaging integrity tests and environmental criteria).
- Prevent nuclear criticality (an unplanned nuclear chain reaction that may occur as a result of concentrating too much fissile material in one place).
- Provide physical protection against theft and sabotage during transit.

The U.S. Department of Transportation (DOT) regulates the transportation of hazardous materials for interstate commerce by land, air, and water. DOT specifically regulates the carriers of radioactive materials and the conditions of transport, such as routing, handling and storage, and commercial motor vehicle and driver requirements. DOT also regulates the shipping papers, labeling, classification, and marking of radioactive material packages. Transportation of hazardous materials within the Washington State is regulated according to **Washington Administrative Code** Sections 173-303-240 through 173-303-270 and Chapters 246-231 and 446-50.

The U.S. Nuclear Regulatory Commission (NRC) regulates the packaging and transportation of radioactive material for its licensees, including commercial shippers of radioactive materials. In addition, under an agreement with DOT, NRC sets the standards for packages containing fissile materials and Type B packages.

DOE, through its management directives, orders, and contractual agreements, ensures the protection of public health and safety by imposing standards equivalent to those of DOT and NRC on its transportation activities. In accordance with Title 49 of the CFR, Section 173.7(d) (49 CFR 173.7[d]), packages made by or under the direction of DOE may be used to transport Class 7 materials (radioactive materials) when the packages have been evaluated, approved, and certified by DOE against packaging standards equivalent to those specified in 10 CFR 71.

DOT also has requirements that help reduce transportation impacts. Some requirements affect drivers, packaging, labeling, marking, and placarding. Others specify the maximum dose rate from radioactive material shipments to help reduce incident-free transportation doses.

The U.S. Department of Homeland Security (DHS) is responsible for establishing policies for, and coordinating civil emergency management, planning, and interaction with, Federal Executive agencies that have emergency response functions in the event of a transportation incident. Guidelines for response actions have been outlined in the **National Response Framework (NRF)** (FEMA 2008a) in the event a transportation incident involving nuclear material occurs.

DHS would use the Federal Emergency Management Agency, an organization within DHS, to coordinate Federal and state participation in developing emergency response plans and to be responsible for the development and maintenance of the **Nuclear/Radiological Incident Annex (NRIA)** (FEMA 2008b) to the NRF. NRIA/NRF describes the policies, situations, concepts of operations, and responsibilities of the Federal departments and agencies governing the immediate response and short-term recovery activities for incidents involving release of radioactive materials to address the consequences of the event.

The Interstate Commerce Commission is responsible for regulation of the economic aspects of overland shipments of radioactive materials. The Commission issues operating authorities to carriers and monitors and approves freight rates.

H.4 TRANSPORTATION ANALYSIS IMPACT METHODOLOGY

The transportation risk assessment was based on the alternatives described in Chapter 2 of this **TC & WM EIS**. Figure H-1 summarizes the transportation risk assessment methodology. After the EIS alternatives were identified and the requirements of the shipping campaign were understood, data were collected on the material characteristics and accident parameters.

The transportation impacts calculated and analyzed in this **TC & WM EIS** are presented in two parts: impacts of incident-free or routine transportation and impacts of transportation accidents. The impacts of incident-free transportation and transportation accidents are further divided into nonradiological and radiological impacts. Nonradiological impacts of incident-free transportation and transportation accidents could result from vehicular emissions and traffic fatalities, respectively. Radiological impacts of incident-free transportation include impacts on members of the public and the workers (crew) from radiation emanating from materials within the package. Only under severe accident conditions, which have a low probability of occurrence, could a transportation package of the type used to transport radioactive material be damaged to the point that radioactivity could be released to the environment.

The impacts of transportation accidents are expressed in terms of probabilistic risk, which is the probability of an accident multiplied by the consequences of that accident and summed over all reasonable accident conditions. Hypothetical transportation accident conditions ranging from low-speed “fender bender” collisions to high-speed collisions with or without fires were analyzed. The frequencies

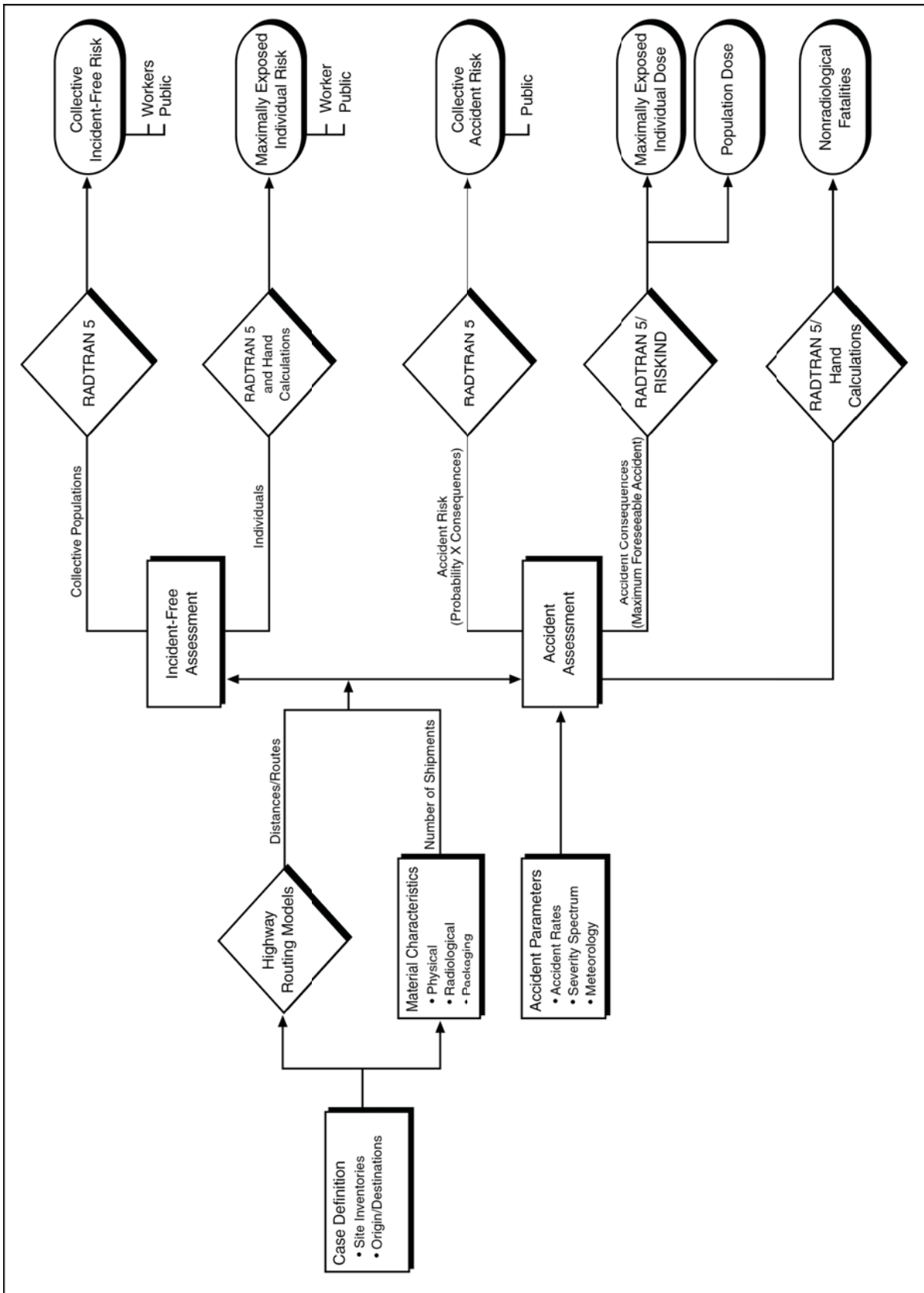

Figure H-1. Transportation Risk Assessment

of accidents and consequences were evaluated using a method developed by NRC and originally published in NUREG-0170, **Final Environmental Impact Statement on the Transportation of Radioactive Material by Air and Other Modes (Radioactive Material Transport Study)** (NRC 1977); NUREG/CR-4829, **Shipping Container Response to Severe Highway and Railway Accident Conditions (Modal Study)** (Fischer et al. 1987); and NUREG/CR-6672, **Reexamination of Spent Fuel Shipment Risk Estimates (Reexamination Study)** (Sprung et al. 2000). Radiological accident risk is expressed as additional LCFs. Nonradiological accident risk is expressed as additional traffic fatalities. Incident-free radiological risk is expressed as additional LCFs.

Transportation-related risks were calculated and are presented separately for workers and members of the general public. The workers considered were truck/rail crewmembers involved in the act of transporting radioactive materials. The general public included all persons who could be exposed to a shipment while it is moving or stopped during transit.

The first step in the ground transportation analysis is to determine the distances and populations along the routes. The TRAGIS [Transportation Routing Analysis Geographic Information System] computer program (Johnson and Michelhaugh 2003) was used to choose representative routes and associated distances and populations. This information, along with the properties of the material being shipped and route-specific accident frequencies, was entered into the RADTRAN 5 [Radioactive Material Transportation] computer code (Neuhauser and Kanipe 2003), which calculated incident and accident risks on a per-shipment basis. The risks under each alternative were determined by summing the products of per-shipment risks for each waste by the number of shipments.

The RADTRAN 5 computer code (Neuhauser and Kanipe 2003) was used for both incident-free and accident risk assessments to estimate the impacts on populations. RADTRAN 5 was developed by Sandia National Laboratories to calculate population risks associated with transportation of radioactive materials by a variety of modes, including truck, rail, air, ship, and barge. RADTRAN 5 was used to calculate the doses to MEIs during incident-free operations.

The RADTRAN 5 population risk calculations include both the consequences and probabilities of potential exposure events. The RADTRAN 5 code consequence analyses include cloud shine, ground shine, inhalation, and resuspension exposures. The collective population risk is a measure of the total radiological risk posed to society as a whole by the alternative being considered. As such, the collective population risk was used as the primary means of comparing the various alternatives.

The RISKIND [Risks and Consequences of Radiological Material Transport] computer code (Yuan et al. 1995) was used to estimate the doses to MEIs and populations from the maximum reasonably foreseeable transportation accident. The RISKIND computer code was developed for DOE's Office of Civilian Radioactive Waste Management to analyze the exposure of individuals during incident-free transportation. In addition, the RISKIND code was designed to allow detailed assessment of the consequences to individuals and population subgroups from severe transportation accidents under various environmental settings.

The RISKIND calculations were conducted to supplement the collective risk results calculated with RADTRAN 5. Whereas the collective risk results provide a measure of the overall risks under each alternative, the RISKIND calculations are meant to address areas of specific concern to individuals and population subgroups. Essentially, the RISKIND analyses are meant to address "what if" questions, such as "What if I live next to a site access road?" or "What if an accident happens near my town?"

H.4.1 Transportation Routes

To assess incident-free and transportation accident impacts, route characteristics were determined for offsite shipments from the Hanford Site (Hanford) in Richland, Washington, and for offsite shipments from other DOE facilities to Hanford, as well as for onsite shipments between the various waste processing plants and burial locations in the 200-East and 200-West Areas. For offsite transports, highway and rail routes were determined using the TRAGIS computer program (Johnson and Michelhaugh 2003). For almost all transports, direct rail routes between origin and destination were generated by TRAGIS; therefore, limited intermodal transports were needed. Rail transports to the Nevada Test Site (NTS) and the INL Materials and Fuels Complex would require intermodal transfers. Since there were only two rail shipments requiring intermodal transfers followed by short (less than 50-kilometer [31-mile]) truck transports, no specific intermodal activities were evaluated.

The TRAGIS computer program is a geographic information system-based transportation analysis computer program used to identify and select highway, rail, and waterway routes for transporting radioactive materials within the United States. Both the road and rail network are 1:100,000-scale databases that were developed from the U.S. Geological Survey digital line graphs and the U.S. Census Bureau Topological Integrated Geographic Encoding and Referencing System. The population densities along each route were derived from 2000 census data. The features in TRAGIS allow users to determine routes for shipment of radioactive materials that conform to DOT regulations, as specified in Title 49 of the CFR, Part 397 (49 CFR 397).

H.4.1.1 Offsite Route Characteristics

Route characteristics important to radiological risk assessment include the total shipment distance and the population distribution along the route. The specific route selected determines both the total potentially exposed population and the expected frequency of transportation-related accidents. The population densities along each route were derived from 2000 census data (Johnson and Michelhaugh 2003). Rural, suburban, and urban areas were characterized according to the following breakdown.

- Rural population densities range from 0 to 54 persons per square kilometer (0 to 139 persons per square mile).
- Suburban population densities range from 55 to 1,284 persons per square kilometer (140 to 3,326 persons per square mile).
- Urban population densities include all population densities greater than 1,284 persons per square kilometer (3,326 persons per square mile).

The affected population (for route characterization and incident-free dose calculation) includes all persons living within 800 meters (0.5 miles) of each side of the road.

H.4.1.1.1 Tank Closure Alternatives

Except for transuranic (TRU) waste, all radioactive waste generated during tank closure would be disposed of (i.e., ILAW) or stored (i.e., IHLW) on site. The TRU waste would be transported to the Waste Isolation Pilot Project (WIPP). Route characteristics for WIPP transports are summarized in Table H-1.

Table H-1. Tank Closure Alternatives – Offsite Transport Truck and Rail Route Characteristics

| From | To | Nominal Distance (kilometers) | Distance Traveled in Zone (kilometers) | | | Population Density in Zone (number per square kilometer) | | | Number of Affected Persons |
|---------------------|------|-------------------------------|--|----------|-------|--|----------|---------|----------------------------|
| | | | Rural | Suburban | Urban | Rural | Suburban | Urban | |
| Truck Routes | | | | | | | | | |
| Hanford | WIPP | 3,080 | 2,615 | 398 | 67 | 7.3 | 338.7 | 2,305.2 | 492,812 |
| Rail Routes | | | | | | | | | |
| Hanford | WIPP | 3,531 | 3,117 | 345 | 69 | 5.5 | 409.9 | 2,252.3 | 501,625 |

Note: To convert kilometers to miles, multiply by 0.6214; number per square kilometer to number per square mile, by 2.59.

Key: Hanford=Hanford Site; WIPP=Waste Isolation Pilot Plant.

The truck and rail routes that were analyzed for shipments of radioactive waste materials to WIPP are shown in Figure H-2. The truck transportation routes that were analyzed were similar to those evaluated in the **Waste Isolation Pilot Plant Disposal Phase Final Supplemental Environmental Impact Statement (WIPP SEIS-II)** (DOE 1997). The rail route that was analyzed for transport of TRU waste to WIPP is consistent with the assumptions made in the **WIPP SEIS-II**.

H.4.1.1.2 FFTF Decommissioning Alternatives

The main offsite transports used for Fast Flux Test Facility (FFTF) decommissioning could include transportation of remote-handled special components (RH-SCs) and radioactively contaminated bulk sodium to Idaho National Laboratory (INL) for treatment and recovery of sodium. The treated sodium residuals from the RH-SCs and treated bulk sodium would be sent back to Hanford for reuse by the Office of River Protection for the Waste Treatment Plant (WTP) or Hanford tanks corrosion control. The treated RH-SCs could be shipped back to Hanford or sent to the NTS for disposal. Route characteristics for INL and NTS are summarized in Table H-2.

Table H-2. FFTF Decommissioning Alternatives – Offsite Transport Truck and Rail Route Characteristics

| From | To | Nominal Distance (kilometers) | Distance Traveled in Zone (kilometers) | | | Population Density in Zone (number per square kilometer) | | | Number of Affected Persons |
|---------------------|-----|-------------------------------|--|----------|-------|--|----------|---------|----------------------------|
| | | | Rural | Suburban | Urban | Rural | Suburban | Urban | |
| Truck Routes | | | | | | | | | |
| FFTF | INL | 968 | 813 | 140 | 15 | 9.5 | 300.9 | 2,184.1 | 132,665 |
| INL | NTS | 1,180 | 935 | 197 | 48 | 8.8 | 361.3 | 2,457.8 | 315,742 |
| Rail Routes | | | | | | | | | |
| FFTF | INL | 1,062 | 936 | 106 | 20 | 6.9 | 400.9 | 2,235.0 | 150,304 |
| INL | NTS | 1,460 | 1,282 | 143 | 35 | 4.4 | 395.2 | 2,410.8 | 233,489 |

Note: To convert kilometers to miles, multiply by 0.6214; number per square kilometer to number per square mile, by 2.59.

Key: FFTF=Fast Flux Test Facility; INL=Idaho National Laboratory; NTS=Nevada Test Site.

The truck and rail routes that were analyzed for shipments of radioactive waste materials are shown in Figure H-3. Rail transports for disposal at NTS would require intermodal transfers. Because only two shipments were assumed to be disposed of at NTS, no specific intermodal analysis was performed.



Figure H-2. Tank Closure Alternatives – Analyzed Truck and Rail Routes

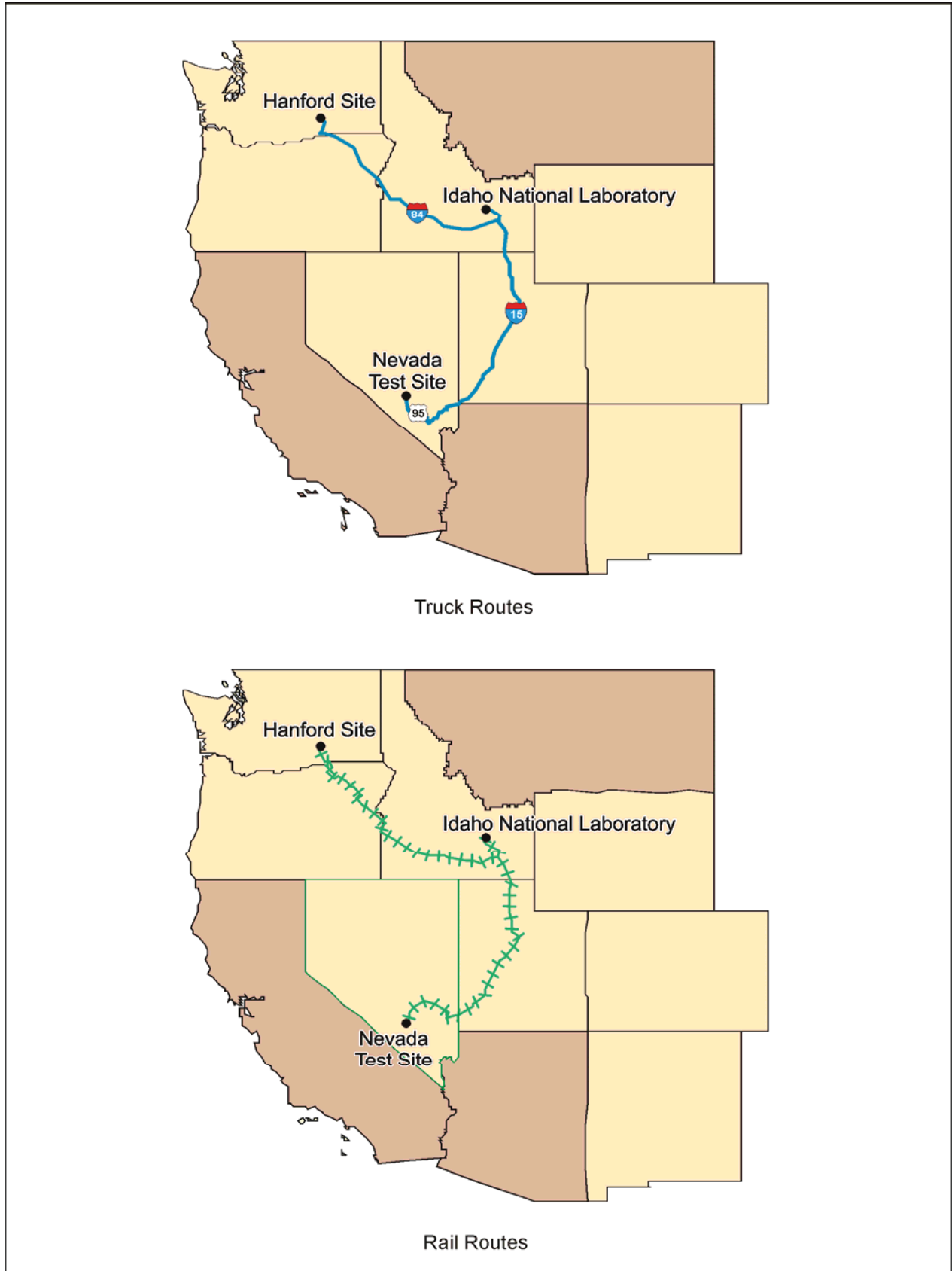

Figure H-3. FFTF Decommissioning Alternatives – Analyzed Truck and Rail Routes

H.4.1.1.3 Waste Management Alternatives

Hanford is one of two regional disposal facilities for DOE’s low-level radioactive waste (LLW) and mixed low-level radioactive waste (MLLW), based on the February 2000 Record of Decision regarding the **Final Waste Management Programmatic Environmental Impact Statement for Managing Treatment, Storage, and Disposal of Radioactive and Hazardous Waste** (65 FR 10061). Accordingly, Hanford is expected to receive both LLW and MLLW from other DOE sites. Route characteristics for offsite radioactive transports from DOE sites to Hanford are summarized in Table H-3.

Table H-3. Waste Management Alternatives – Offsite Transport Truck and Rail Route Characteristics

| From | To | Nominal Distance (kilometers) | Distance Traveled in Zone (kilometers) | | | Population Density in Zone (number per square kilometer) | | | Number of Affected Persons |
|---------------------|---------|-------------------------------|--|----------|-------|--|----------|---------|----------------------------|
| | | | Rural | Suburban | Urban | Rural | Suburban | Urban | |
| Truck Routes | | | | | | | | | |
| ANL-E | Hanford | 3,238 | 2,766 | 434 | 38 | 9.7 | 292.9 | 2,220.2 | 381,879 |
| BNL | | 4,747 | 3,576 | 1,032 | 139 | 11.6 | 319.3 | 2,485.4 | 1,147,541 |
| INL/NR | | 1,023 | 857 | 149 | 17 | 9.5 | 306.4 | 2,174.4 | 144,960 |
| LANL | | 2,558 | 2,138 | 363 | 57 | 8.0 | 334.1 | 2,320.4 | 433,663 |
| ORNL | | 4,023 | 3,227 | 721 | 75 | 10.2 | 306.7 | 2,215.8 | 671,349 |
| Paducah | | 3,541 | 2,917 | 558 | 66 | 9.2 | 318.3 | 2,200.2 | 557,889 |
| Portsmouth | | 4,064 | 3,281 | 722 | 61 | 11.3 | 292.4 | 2,214.8 | 614,096 |
| SRS | | 4,443 | 3,410 | 919 | 114 | 10.4 | 327.7 | 2,248.5 | 947,736 |
| West Valley | | 4,225 | 3,293 | 856 | 76 | 11.3 | 292.5 | 2,261.0 | 733,044 |
| Rail Routes | | | | | | | | | |
| ANL-E | Hanford | 3,276 | 2,751 | 425 | 100 | 5.7 | 361.3 | 2,540.6 | 677,558 |
| BNL | | 4,876 | 3,693 | 908 | 275 | 8.1 | 389.8 | 2,694.6 | 1,798,614 |
| INL/NR | | 1,062 | 936 | 106 | 20 | 6.9 | 400.0 | 2,235.0 | 150,305 |
| LANL ^a | | NA | NA | NA | NA | NA | NA | NA | NA |
| ORNL | | 4,271 | 3,420 | 703 | 148 | 7.8 | 365.1 | 2,357.8 | 1,009,844 |
| Paducah | | 3,723 | 3,206 | 450 | 67 | 6.1 | 356.9 | 2,203.4 | 525,575 |
| Portsmouth | | 3,891 | 3,204 | 559 | 128 | 7.0 | 373.7 | 2,355.7 | 850,824 |
| SRS | | 4,766 | 3,699 | 878 | 189 | 7.8 | 396.3 | 2,299.9 | 1,299,605 |
| West Valley | | 4,169 | 3,322 | 680 | 167 | 7.3 | 388.9 | 2,420.0 | 1,106,548 |

^a No direct rail connection to Los Alamos National Laboratory.

Note: To convert kilometers to miles, multiply by 0.6214; number per square kilometers to number per square mile, by 2.59.

Key: ANL-E=Argonne National Laboratory-East; BNL=Brookhaven National Laboratory; Hanford=Hanford Site; INL/NR=Idaho National Laboratory/Naval Reactor Facility; LANL=Los Alamos National Laboratory; NA=not analyzed; ORNL=Oak Ridge National Laboratory; SRS=Savannah River Site; West Valley=West Valley Demonstration Project.

Truck and rail routes that were analyzed for shipments of radioactive waste materials are shown in Figure H-4.

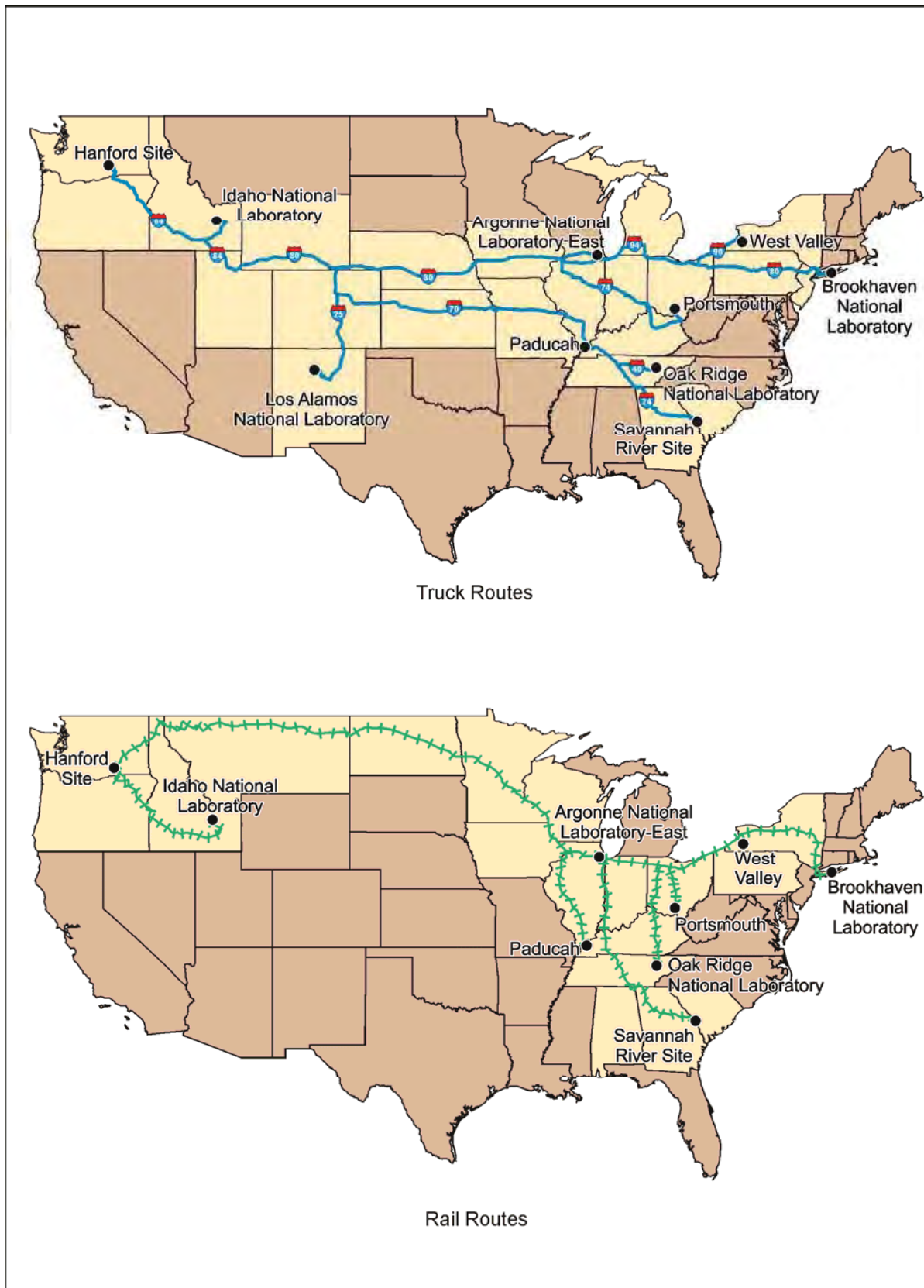

Figure H-4. Waste Management Alternatives – Analyzed Truck and Rail Routes

H.4.1.2 Onsite Route Characteristics

Onsite transport of waste materials would occur within either the 200-East or 200-West Area (under the Tank Closure alternatives), between FFTF and the 200 Areas (under the FFTF Decommissioning alternatives), and between the various facilities and the disposal locations within the 200 Areas (under the Waste Management alternatives). For transports within the 200-East and 200-West Areas (under the Tank Closure and Waste Management alternatives), waste was conservatively assumed to be generated at one site and transported to another. The distance traveled between the sites would be about 16 kilometers (10 miles), half of which would occur within the two areas. The population density on the road between the sites is 1 person per 2 square kilometers (about 4 persons per 3 square miles) (Johnson and Michelhaugh 2003). The population density while the transport is within any one of the areas was assumed to be the same as the population density of the 200-East Area, or 185 persons per square kilometer (479 persons per square mile).¹ This assumption is conservative, as both the road and the site are closed to the public and the individuals working within these areas are considered facility workers who would likely be exposed to more radiation than that emanating from waste packages during transport. For accident conditions, the population density up to an 80-kilometer (50-mile) radius was based on the average population densities for the 200-East and 200-West Areas. The total population within 80 kilometers (50 miles) of these two sites ranges from about 451,600 to 489,000. The 80-kilometer (50-mile) average population density would be about 24 persons per square kilometer (62 persons per square mile). This assumption would result in a conservative population dose because no member of the public resides within the first 10 kilometers (6 miles) of the road.

For transports under the FFTF Decommissioning alternatives, the onsite distance traveled between FFTF and various facilities in the 200 Areas ranges from 24 to 37 kilometers (15 to 23 miles).² The population density on the road between the sites is 1 per 10 square kilometers (Johnson and Michelhaugh 2003). The population density while the transport is within the 200 Areas was assumed to be the same as the population density of the 200-East Area (185 persons per square kilometer [479 persons per square mile]).

H.4.2 Radioactive Material Shipments

All waste types were assumed to be in certified or certified-equivalent packagings and containers and to be transported using exclusive-use vehicles. Legal-weight heavy-haul combination trucks would be used for highway transportation. Type A packages would be transported on common flatbed or covered trailers; Type B packages generally would be shipped on trailers designed specifically for the packaging used. For truck transportation, the maximum payload weight was considered to be about 20,000 kilograms (about 44,000 pounds), based on the Federal gross vehicle weight limit of 36,288 kilograms (80,000 pounds). However, large numbers of multitrailer combinations (known as longer-combination vehicles), with gross weights exceeding the Federal limit, are currently operating on rural roads and turnpikes in some states (FHWA 2003). For evaluation purposes, the load limit for the legal truck was based on the Federal gross vehicle weight.

Rail transport can be done with dedicated and/or general freight trains. For analysis purposes, use of a dedicated train was assumed. The payload weights for railcars range from 45,359 to 68,039 kilograms (100,000 to 150,000 pounds). A median payload weight of 54,431 kilograms (120,000 pounds) was used in this analysis.

¹ Based on the number of workers in the 200-East Area as of May 2007.

² The path is assumed to follow Route 45 within Hanford toward the 200 Areas.

The following types of waste and disposal destinations were evaluated for this TC & WM EIS.

Tank Closure

1. IHLW glass would be stored on site until disposition decisions are made and implemented.
2. ILAW glass would be disposed of on site.
3. TRU waste would be disposed of off site (at WIPP).
4. Supplemental technology (bulk vitrification, cast stone, or steam reforming) waste would be disposed of on site.
5. LLW, MLLW, and miscellaneous waste would be disposed of on site.

FFTF Decommissioning

1. Sodium metal would be neutralized (oxidized) either at Hanford or INL. If treatment is carried out at INL, the treated sodium hydroxide would be transported back to Hanford for use at the WTP.
2. RH-SCs and their sodium residuals would be treated either at Hanford or INL. If treatment is carried out at INL, the final waste would either be transported back to Hanford or sent to NTS for disposal. If treatment occurs at Hanford, the final waste would be disposed of on site.
3. LLW, MLLW, and miscellaneous waste would be disposed of on site.

Waste Management

1. Offsite LLW and MLLW from various DOE sources would be transported for disposal at Hanford.
2. Onsite LLW, MLLW, and miscellaneous waste would be disposed of on site.

The number of shipping containers per shipment was estimated based on the dimensions and weight of the shipping containers, the Transport Index,³ and the transport vehicle dimensions and weight limits. The number of offsite shipments was estimated based on the following assumptions.

1. For transport of IHLW glass to onsite storage, each truck would transport one IHLW canister in a Type B SNF cask.
2. For transport to WIPP, contact-handled (CH)-TRU waste would be packaged in TRU Waste Package Transporter II (TRUPACT-II) containers, each holding fourteen 208-liter (55-gallon) drums, with three or six TRUPACT-II containers per truck or rail shipment. The RH-TRU waste would be packaged in a Type B cask (e.g., an RH-72B cask or CNS 10-160B), which can contain three 208-liter (55-gallon) drums, and transported—one cask per truck or two casks per rail.

³ The Transport Index is a dimensionless number (rounded up to the next tenth) placed on the label of a package to designate the degree of control to be exercised by the carrier. Its value is equivalent to the maximum radiation level in millirem per hour at 1 meter (3.3 feet) from the package (10 CFR 71.4; 49 CFR 173.403).

**Draft Tank Closure and Waste Management Environmental Impact Statement for the
Hanford Site, Richland, Washington**

3. For transport of sodium metal to INL, sodium metal would be shipped in sodium International Organization for Standardization (ISO) container tanks, each with a volume of about 15.1 cubic meters (4,000 gallons). Each truck would transport one ISO container. Sodium metal stored in a drum overpack would be transported in intermodal containers with 45 drums per truck transport. Two sodium ISO containers or two intermodal containers would be transported per railcar.
4. For transport of RH-SCs, each truck would transport one component in a specially designed Type B cask. Each railcar would transport two RH-SC casks. The same cask would be used to transport the treated RH-SCs back to Hanford, or to send them to NTS for disposal.
5. For transport of offsite LLW/MLLW to Hanford, each truck would transport eighty 208-liter (55-gallon) drums of CH-waste and between 10 and 14 drums of RH-waste in shielded Type A or Type B truck casks. Each railcar would transport two truck casks, or 160 drums.

The capacities of various onsite shipments per transport are as follows:

- One container of bulk vitrification waste on a heavy-haul truck
- Forty 208-liter (55-gallon) drums of LLW/MLLW or CH-TRU waste
- One ILAW glass canister
- Fourteen 208-liter (55-gallon) drums of RH-TRU waste
- One container of cast stone waste or two containers of sulfate grout
- Two shielded boxes or one roll-on/roll-off box of radioactive contaminated soils and/or equipment

Table H-4 summarizes the types of containers and their volumes and the number of containers in a shipment.

Table H-4. Waste Type and Container Characteristics

| Waste Type ^a | Container | Volume per Container (cubic meters) | Number of Containers per Transport |
|--|--|-------------------------------------|---|
| IHLW glass | 0.6-meter-diameter by 4.5-meter-long cylinder | 1.19 | 1 per truck cask; 5 per rail cask |
| ILAW glass | 1.22-meter-diameter by 2.3-meter-long cylinder | 2.31 | 1 per truck shipment |
| Bulk vitrification glass | 7.3- by 3.1- by 2.4-meter box | 54.3 | 1 per truck shipment |
| Cast stone waste | 2.7- by 2.7- by 1.5-meter box | 10 | 1 per truck shipment |
| Steam reforming waste | 1.5- by 1.5 -by 1.5-meter box | 2.25 | 2 per truck shipment |
| TRU waste ^b (remote-handled) | 208-liter drum | 0.20 | 3 per cask: 1 cask per truck shipment; 2 casks per rail shipment ^c |
| TRU waste ^b (contact-handled) | 208-liter drum | 0.20 | 14 per TRUPACT-II: 3 TRUPACT-IIs per truck shipment; 6 TRUPACT-IIs per rail shipment ^c |
| TRU waste (contact- and remote-handled) | 208-liter drum | 0.20 | 40 per truck shipment (contact-handled), 14 per truck shipment in a shielded Type A or Type B cask (remote-handled) |
| LLW/MLLW ^{b, d} | 208-liter drum | 0.20 | 80, or 10 to 14 in a shielded Type B or Type A cask, respectively, per truck shipment; 160, or 2 casks per rail shipment ^c |
| Bulk sodium ^b | Sodium ISO container tank | 15.1 | 1 per truck shipment; 2 per rail shipment ^c |
| Drummed sodium ^e | 322-liter drum | 0.32 | 45 per truck shipment; 90 per rail shipment ^c |
| Sodium hydroxide ^f | Caustic ISO container tank | 14.1 | 1 per truck shipment; 2 per rail shipment ^c |
| Remote-handled special components ^g | Special cask | NA | 1 per truck shipment; 2 per rail shipment ^c |
| Miscellaneous waste ^h | 4.0- by 1.6- by 1.3-meter shielded box to 6.1- by 2.4- by 1.7-meter roll-on/roll-off box | 4.6 to 20.0 | 2 shielded boxes, or 1 roll-on/roll-off box per truck shipment |

^a Transported on site unless specified otherwise.

^b Transported off site after interim storage on site or brought to Hanford from offsite sources.

^c Rail transports are for offsite shipments.

^d Offsite waste transported to Hanford for disposal, including both contact-handled and remote-handled waste. Transport of remote-handled waste would involve use of shielded casks.

^e This sodium is from the Sodium Reactor Experiment and is stored in 208-liter (55-gallon) drums overpacked in 322-liter (85-gallon) drums.

^f Sodium hydroxide is a 50-percent caustic solution. Because it has a higher density than that of sodium metal, only about 13.2 cubic meters (3,500 gallons) of sodium hydroxide would be transported per ISO-container tank.

^g Transport would occur in specially designed Type B casks.

^h Includes radioactively contaminated equipment and soils that are generated during tank farm dismantling, cleanup, and closure.

Note: To convert cubic meters to cubic feet, multiply by 35.315; cubic meters to gallons, by 264.2; liters to gallons, by 0.26417; meters to feet, by 3.281.

Key: Hanford=Hanford Site; IHLW=immobilized high-level radioactive waste; ILAW=immobilized low-activity waste; ISO=International Organization for Standardization; LLW=low-level radioactive waste; MLLW=mixed low-level radioactive waste; NA=not available; TRU=transuranic; TRUPACT-II=Transuranic Waste Package Transporter II; WTP=Waste Treatment Plant.

H.5 INCIDENT-FREE TRANSPORTATION RISKS

H.5.1 Radiological Risk

During incident-free transportation of radioactive materials, a radiological dose results from exposure to the external radiation field that surrounds the shipping containers. The population dose is a function of the number of people exposed, their proximity to the containers and length of time of exposure, and the intensity of the radiation field surrounding the containers.

Radiological impacts were determined for crewmembers and the general population during incident-free transportation. For truck shipments, the drivers of the shipment vehicles are the crew. For rail shipments, the crew includes workers in close proximity to the shipping containers during inspection or classification of the railcars. The general population includes persons residing within 800 meters (0.5 miles) of the road or railway (off-link), persons sharing the road or railway (on-link), and persons at stops. Exposures to workers loading and unloading the shipments are not included in this analysis but are included in the occupational estimates for plant workers. Exposures to the inspectors and escorts (persons in a vehicle that follows or leads the shipment) are evaluated and presented separately.

Collective doses for the crew and general population were calculated using the RADTRAN 5 computer code (Neuhauser and Kanipe 2003). The radioactive material shipments were assigned an external dose rate based on their radiological characteristics. Offsite transportation of radioactive material in Type B casks has a defined dose limit of 10 millirem per hour at 2 meters (about 6.6 feet) from the cask (10 CFR 71.47), or about 14 millirem per hour at 1 meter (about 3.3 feet) from the cask. The RH- and CH-TRU waste package dose rates at 1 meter (about 3.3 feet) were assigned at 10 millirem per hour and 4 millirem per hour, respectively (DOE 1997). Dose rates for onsite transportation packages could be more than 10 millirem per hour at 2 meters (about 6.6 feet), provided that the roads are closed to the public. Dose rates at 1 meter (about 3.3 feet) for the ILAW glass and the cast stone, steam-reformed, and bulk-vitrified glass waste containers were estimated based on the cesium-137, cobalt-60, and europium-154 inventory per container. It was assumed that sufficient shielding would be used for each container to meet the Hanford disposal dose rate requirement (surface dose rate less than 200 millirem per hour). Based on the maximum potential inventories of the three isotopes listed above in each container, a dose rate of 14, 80, 63, and 60 millirem per hour at 1 meter (about 3.3 feet) was assessed for the ILAW glass, cast stone waste, steam-reformed waste, and bulk-vitrified glass, respectively.

Dose rates at 1 meter (about 3.3 feet) for the sodium and sodium hydroxide tanks were estimated to be about 2 and 1 millirem per hour, respectively. The 1-meter dose rate for the RH-SCs in Type B casks was assumed to be 14 millirem per hour. Dose rates at 1 meter for the CH-offsite LLW and MLLW and RH-offsite LLW and MLLW were estimated to be 3 and 6 millirem per hour, respectively. Note that the RH-offsite waste would be transported in shielded Type A or Type B casks, as required.

To calculate the collective dose, a unit risk factor was developed to estimate the impact of transporting one shipment of radioactive material over a unit distance of travel in a given population density zone. Table H-5 provides examples of unit risk factors from transport of a generic radioactive waste package with a Transport Index of 1 (i.e., a dose rate of 1 millirem per hour at 1 meter [3.3 feet] from the surface of the shipping container or the conveyance) by truck and rail. This table provides a perspective to the public on risk values from the movement of radioactive materials in truck and rail packages over 1 kilometer (0.6214 miles). The values in Table H-5 reflect assumptions regarding public shielding afforded by the general housing structure within each population zone, which are major contributing factors in calculating the dose, time, and distance to an exposed individual.

Unit risk factors were developed using RADTRAN 5 and its default data on the basis of travel on interstate highways and freeways, as required by DOT regulations (49 CFR 171-177) for highway route

controlled quantities of radioactive material within rural, suburban, and urban population zones. In addition, the analysis assumed that 10 percent of the time, travel through suburban and urban zones would encounter rush-hour conditions, leading to lower average speed and higher traffic density. The unit risk factors were combined with routing information, such as the shipment distances in various population density zones, to determine the risk from a single shipment (shipment risk factor) between a given origin and destination.

The radiological risks from transporting the waste were estimated in terms of the number of LCFs among the crew and the exposed population. A health risk conversion factor of 0.0006 LCFs per person-rem of exposure was used for both the workers and the public (DOE 2003).

Table H-5. Incident-Free Unit Risk Factors for a Dose Rate of 1 Millirem per Hour at 1 Meter (3.3 Feet) from the Shipping Container for Truck and Rail Shipments

| Mode | Exposure Group | Unit Risk Factors ^a | | |
|-------|--|--------------------------------|------------------------|------------------------|
| | | Rural | Suburban ^b | Urban ^b |
| Truck | Occupational ^c (person-rem per kilometer) | 5.33×10 ⁻⁶ | 5.86×10 ⁻⁶ | 5.86×10 ⁻⁶ |
| | General population | | | |
| | Off-link ^d (person-rem per kilometer per person per square kilometer) | 2.62×10 ⁻⁹ | 2.50×10 ⁻⁹ | 5.18×10 ⁻¹¹ |
| | On-link ^e (person-rem per kilometer) | 7.21×10 ⁻⁷ | 1.79×10 ⁻⁶ | 5.66×10 ⁻⁶ |
| | Stops (person-rem per kilometer per person per square kilometer) | 2.30×10 ⁻¹⁰ | 2.30×10 ⁻¹⁰ | 2.30×10 ⁻¹⁰ |
| | Escorts ^f (person-rem per kilometer) | 2.42×10 ⁻⁷ | 2.55×10 ⁻⁷ | 2.55×10 ⁻⁷ |
| Rail | Occupational ^g (person-rem per kilometer) | 2.10×10 ⁻⁷ | 2.10×10 ⁻⁷ | 2.10×10 ⁻⁷ |
| | General population | | | |
| | Off-link ^d (person-rem per kilometer per person per square kilometer) | 3.52×10 ⁻⁹ | 4.90×10 ⁻⁹ | 1.69×10 ⁻¹⁰ |
| | On-link ^e (person-rem per kilometer) | 8.23×10 ⁻⁹ | 1.06×10 ⁻⁶ | 2.94×10 ⁻⁷ |
| | Stops (person-rem per kilometer per person per square kilometer) | 8.10×10 ⁻¹⁰ | 8.10×10 ⁻¹⁰ | 8.10×10 ⁻¹⁰ |
| | Escorts ^h (person-rem per kilometer) | 1.57×10 ⁻⁶ | 2.52×10 ⁻⁶ | 4.21×10 ⁻⁶ |

^a The methodology, equations, and data used to develop the unit risk factors are discussed in the **RADTRAN 5 User Guide** (Neuhauser and Kanipe 2003). The risk factors provided here are for truck and rail waste packages (i.e., casks) with the following characteristic lengths and diameters: 5.2 meters (~17.1 feet) in length by 1.0 meter (3.3 feet) in diameter for a truck cask and 5.06 meters (16.6 feet) in length by 2.0 meters (6.6 feet) in diameter for a rail cask. Because the characteristics of transuranic (TRU) waste shipments are different from those used here, the contact-handled TRU waste shipment risk factors would be higher than the values given here by factors of 1.39 and 1.76 for the population dose and crew dose, respectively.

^b Ten percent of vehicles traveling within these zones encounter rush-hour traffic with a lower speed and a higher traffic density.

^c The maximum dose in the truck cabin (crew dose) is 2 millirem per hour (10 CFR 71.47) unless the crew includes a trained radiation worker, which would administratively limit the annual dose to 2 rem per year (DOE Standard 1098-99).

^d Off-link general population refers to persons within 800 meters (0.5 miles) of the road or railway. The difference in doses between the rural, suburban, and urban populations is due to the assumptions on the shielding factors applicable in various zones.

^e On-link general population refers to persons sharing the road or railway.

^f Escorts are two persons in a vehicle that follows or leads the truck by 60 meters (about 200 feet). The dose to passengers in this vehicle is estimated to be 0.15 millirem per hour for a cask at the regulation dose limit (DOE 2002a).

^g The nonlinear component of the incident-free rail dose for crewmembers because of railcar inspections and classifications, 0.000233 person-rem per shipment, is not included in the unit risk factors. The **RADTRAN 5 Technical Manual**, Appendix B (Neuhauser, Kanipe, and Weiner 2000), contains an explanation of the rail exposure model.

^h These escorts (two persons) are at a distance of 30 meters (about 100 feet) from the end of the shipping cask. The dose to each escort is estimated to be 0.71 millirem per hour for a cask at the regulation dose limit (DOE 2002a).

Note: To convert kilometers to miles, multiply by 0.6214; square kilometers to square miles, by 0.3861.

H.5.2 Nonradiological Risk

Nonradiological risks (vehicle-related health risks) resulting from incident-free transport may be associated with the generation of air pollutants by transport vehicles during shipment and are independent of the radioactive nature of the shipment. The health endpoint assessed under incident-free transport conditions is the excess latent mortality due to inhalation of vehicle emissions.

Unit risk factors for pollutant inhalation in terms of mortality have been generated (Rao, Wilmot, and Luna 1982). These unit risk factors account for potential fatalities from emissions of particulates and sulfur dioxide, but they are applicable only to the urban population zone, which is a small fraction of the total transport distance. The emergence of considerable data regarding minimum threshold values for health risks from chemical constituents of vehicle exhaust has made linear extrapolation to estimate the risks from lower exposure levels to vehicle emissions untenable. Calculated risks should be compared with a standard or other comparable risks to put the risks in perspective, but this is not possible with emission risks. This calculation has been dropped from RADTRAN in its recent revision (Neuhauser, Kanipe, and Weiner 2000). Therefore, no risk factors were assigned to the vehicle emissions analyzed in this TC & WM EIS.

H.5.3 Maximally Exposed Individual Exposure Scenarios

The MEI doses for routine offsite transportation were estimated for both transportation workers and members of the general public.

For truck shipments, three hypothetical scenarios were evaluated to determine the MEI in the general population (DOE 2002a).

- A person caught in traffic and located 1.2 meters (4 feet) from the surface of the shipping container for 30 minutes
- A resident living 30 meters (98 feet) from the highway used to transport the shipping container
- A service station worker working at a distance of 16 meters (52 feet) from the shipping container for 50 minutes

The hypothetical MEI doses were accumulated over a single year for all transportation shipments. However, for the scenario involving an individual caught in traffic next to a shipping container, the radiological exposures were calculated for only one event because it was considered unlikely that the same individual would be caught in traffic next to all containers for all shipments. For truck shipments, the maximally exposed transportation worker would be the driver, who was assumed to have been trained as a radiation worker and to drive shipments for up to 2,000 hours per year, resulting in an accumulated exposure of 2 rem per year. The maximum exposure rate for a member of a truck crew who is not a radiation worker would be 2 millirem per hour (10 CFR 71.47).

Three hypothetical scenarios were also evaluated for railcar shipments.

- A rail yard worker working at a distance of 10 meters (33 feet) from the shipping container for 2 hours
- A resident living 30 meters (98 feet) from the rail line where the shipping container is being transported
- A resident living 200 meters (656 feet) from a rail stop during classification and inspection for 20 hours

For rail shipments, the maximally exposed transportation worker would be an individual inspecting the cargo at 1 meter (3.3 feet) from the shipping container for 1 hour.

H.6 TRANSPORTATION ACCIDENT RISKS AND MAXIMUM REASONABLY FORESEEABLE CONSEQUENCES

H.6.1 Methodology

Offsite transportation accident analysis considers the impacts of accidents during transportation of waste by truck or rail. Under accident conditions, impacts on human health and the environment could result from the release and dispersal of radioactive material. Transportation accident impacts were assessed using accident analysis methodology developed by NRC. This section provides an overview of the methodologies; detailed descriptions of various methodologies are found in NUREG-0170, **Radioactive Material Transport Study**; NUREG/CR-4829, **Modal Study**; and NUREG/CR-6672, **Reexamination Study** (NRC 1977; Fischer et al. 1987; Sprung et al. 2000). Accidents that could potentially breach the shipping container were represented by a spectrum of accident severities and radioactive release conditions. Historically, most transportation accidents involving radioactive materials resulted in little or no release of radioactive material from the shipping container. Consequently, the analysis of accident risks accounted for a spectrum of accidents ranging from high-probability accidents of low severity to hypothetical high-severity accidents that have a low probability. The accident analysis also calculated the probabilities and consequences of this spectrum of accidents.

Two types of analysis were performed to provide DOE and the public with a reasonable assessment of potential accident impacts of radioactive waste transportation. First, an accident risk assessment was performed to account for the probabilities and consequences of a spectrum of potential accident severities using a methodology developed by NRC (NRC 1977; Fischer et al. 1987; Sprung et al. 2000). For the spectrum of accidents considered in the analysis, accident consequences in terms of the collective “dose risk” to the population within 80 kilometers (50 miles) were determined using the RADTRAN 5 computer program (Neuhauser and Kanipe 2003). The RADTRAN 5 code sums the product of consequences and probability over all accident severity categories to obtain a probability-weighted risk value referred to in this appendix as the “dose risk,” which is expressed in units of person-rem. Second, to represent the maximum reasonably foreseeable impacts on individuals and populations should an accident occur, the maximum radiological consequences were calculated in an urban (or suburban) population zone for an accidental release with a likelihood of occurrence of greater than 1 in 10 million per year using the RISKIND computer program (Yuan et al. 1995).

For accidents in which the waste container or the cask shielding is not damaged, population and individual radiation exposure from the waste package was evaluated for the duration of time needed to recover and restart shipment. It was assumed that it would take 12 hours to recover from an accident. During this period, no individual would remain close to the cask. An individual (first responder) could stay at a location 2 to 10 meters (3.3 to 33 feet) from the package, at a position where the dose rate would be the highest, for 30 minutes in a loss-of-shielding accident and 1 hour for other accidents with no release (DOE 2002a). For accidents leading to loss of cask shielding, a method similar to that provided in NUREG/CR-6672, **Reexamination Study**, was used (DOE 2002a; Sprung et al. 2000). The collective dose over all segments of the transportation routes was evaluated for an affected population located up to a distance of 800 meters (0.5 miles) from the accident location. This dose would be an external dose, approximately inversely proportional to the square of the distance of the affected population from the accident. Any additional dose to those residing beyond 800 meters (0.5 miles) from the accident would be negligible.

H.6.2 Accident Rates

For the calculation of accident risks, vehicle accident and fatality rates were taken from data provided in **State-Level Accident Rates of Surface Freight Transportation: A Reexamination** (Saricks and Tompkins 1999). Accident rates are generically defined as the number of accident involvements (or fatalities) in a given year per unit of travel in that same year. Therefore, the rate is a fractional value, with the accident involvement count as the numerator of the fraction and vehicular activity (total travel distance in truck kilometers) as the denominator. Accident rates are generally determined for a multiyear period. For assessment purposes, the total number of expected accidents or fatalities was calculated by multiplying the total shipment distance for a specific case by the appropriate accident or fatality rate.

For truck transportation, the rates presented here are specifically for heavy-haul combination trucks involved in interstate commerce (Saricks and Tompkins 1999). Heavy-haul combination trucks are rigs composed of a separable tractor unit containing the engine and one to three freight trailers connected to each other. Heavy-haul combination trucks are typically used for radioactive material shipments. The truck accident rates were computed for each state based on statistics compiled by the DOT Federal Highway Administration, Office of Motor Carriers, from 1994 to 1996. A fatality caused by an accident is defined as the death of a member of the public who is killed instantly or dies within 30 days due to injuries sustained in the accident.

For offsite truck transportation, separate accident rates and accident fatality risks were used for rural, suburban, and urban population zones. The values selected are the mean accident and fatality rates under interstate, primary, and total categories for rural, suburban, and urban population zones, respectively (Saricks and Tompkins 1999). The accident rates are 3.15, 3.52, and 3.66 per 10 million truck kilometers, and the fatality rates are 0.88, 1.49, and 2.32 per 100 million truck kilometers for rural, suburban, and urban zones, respectively. For rail transportation, the accident and fatality rates are the mean value rates applicable to all population zones. The rates used in this analysis are 2.74 accidents per 10 million railcar kilometers and 7.82 fatalities per 100 million railcar kilometers. The national mean values for truck and rail accident and fatality rates were used because these values are less prone to the uncertainties associated with the state-level data that can be under-reported or have a small data set. In addition, the analyzed routes are considered representative and are not necessarily the ones that would be used in the future. Further, the use of national mean values would result in conservative estimates on the number of accidents and fatalities per trip.

For onsite and local/regional transport, Washington State accident and fatality rates were used—1.23 accidents per 10 million truck kilometers and 0.83 fatalities per 100 million truck kilometers (Saricks and Tompkins 1999).

H.6.3 Accident Severity Categories and Conditional Probabilities

Accident severity categories for potential radioactive waste transportation accidents are described in NUREG-0170, **Radioactive Material Transport Study** (NRC 1977), which addresses general radioactive waste transportation risks, as well as in NUREG/CR-4829, **Modal Study** (Fischer et al. 1987), and NUREG/CR-6672, **Reexamination Study** (Sprung et al. 2000), both of which address SNF transportation risks (the **Reexamination Study** is a refinement of the **Modal Study**). The method described in NUREG/CR-6672 is applicable to transportation of IHLW glass in a Type B SNF cask. The accident severity categories presented in NUREG-0170 are applicable to onsite waste transport. In addition to these reports, DOE's Richland Operations Office has developed the **Safety Evaluation Report, Hanford Transportation Safety Document**, a site-specific transportation safety document for determining onsite transportation risks (DOE 2002b). This document applied modeling from NUREG/CR-6672 to estimate site-specific severity probabilities.

NUREG-0170, **Radioactive Material Transport Study** (NRC 1977), originally was used to estimate the conditional probabilities associated with accidents involving transportation of radioactive materials. NUREG/CR-4829, **Modal Study**, and NUREG/CR-6672, **Reexamination Study** (Fischer et al. 1987; Sprung et al. 2000), were initiatives taken by NRC to refine more precisely the analysis presented in the NUREG-0170 for SNF shipping casks.

Whereas the analysis in NUREG-0170, **Radioactive Material Transport Study**, was primarily performed using the best engineering judgments and presumptions concerning cask response, later studies relied on sophisticated structural and thermal engineering analysis and a probabilistic assessment of the conditions that could be experienced in severe transportation accidents. These results were based on representative SNF casks that were assumed to be designed, manufactured, operated, and maintained according to national codes and standards. The design parameters of the representative casks were chosen to meet the minimum test criteria specified in 10 CFR 71. NUREG-0170 is believed to provide realistic, yet conservative, results for radiological releases under transport accident conditions.

In both NUREG/CR-4829, **Modal Study**, and NUREG/CR-6672, **Reexamination Study**, potential accident damage to a cask is categorized according to the magnitude of the mechanical forces (impact) and thermal forces (fire) to which a cask may be subjected during an accident. Because all accidents can be described in these terms, severity is independent of the specific accident sequence. In other words, any sequence of events that results in an accident in which a cask is subjected to forces within a certain range of values is assigned to the accident severity region associated with that range. The accident severity scheme is designed to take into account all potential foreseeable transportation accidents, including accidents with low probability but high consequences and those with high probability but low consequences.

As discussed earlier, the accident consequence assessment considers only the potential impacts of the most severe transportation accidents. In terms of risk, the severity of an accident must be viewed in terms of potential radiological consequences, which are directly proportional to the fraction of the radioactive material within a cask that is released to the environment during the accident. Although accident severity regions span the entire range of mechanical and thermal accident loads, they are grouped into accident categories that can be characterized by a single set of release fractions and, therefore, are considered together in the accident consequence assessment. The accident category severity fraction is the sum of all conditional probabilities in that accident category.

For the accident risk assessment, accident “dose risk” was generically defined as the product of the consequences of an accident and the probability of the occurrence of that accident, an approach consistent with the methodology used by the RADTRAN 5 computer code. The RADTRAN 5 code sums the product of consequences and probability over all accident severity categories to obtain a probability-weighted risk value referred to in this appendix as “dose risk,” which is expressed in units of person-rem.

H.6.4 Atmospheric Conditions

Because it is impossible to predict the specific location of an offsite transportation accident, generic atmospheric conditions were selected for the risk and consequence assessments. On the basis of observations from National Weather Service surface meteorological stations at over 177 locations in the United States, on an annual average, neutral conditions (Pasquill Stability Classes C and D) occur 58.5 percent of the time, and stable (Pasquill Stability Classes E, F, and G) and unstable (Pasquill Stability Classes A and B) conditions occur 33.5 percent and 8 percent of the time, respectively (DOE 2002a). Neutral weather conditions predominate in each season, but most frequently in winter (nearly 60 percent of the observations).

Neutral weather conditions (Pasquill Stability Class D) compose the most frequently occurring atmospheric stability condition in the United States, and are thus most likely to be present in the event of an accident involving a radioactive waste shipment. Neutral weather conditions are typified by moderate windspeeds, vertical mixing within the atmosphere, and good dispersion of atmospheric contaminants. Stable weather conditions are typified by low windspeeds, very little vertical mixing within the atmosphere, and poor dispersion of atmospheric contaminants. The atmospheric condition used in RADTRAN 5 is an average weather condition that corresponds to a stability class spread between Class D (for near distance) and Class E (for farther distance).

The accident consequences for the maximum reasonably foreseeable accident (an accident with a likelihood of occurrence of greater than 1 in 10 million per year) were assessed under both stable (Class F with a windspeed of 1 meter [3.3 feet] per second) and neutral (Class D with a windspeed of 4 meters [13 feet] per second) atmospheric conditions. These calculations estimate the potential doses to an individual and a population within a zone, respectively. The individual dose would represent the MEI in an accident under weather conditions that maximize the dose (stable condition, with minimum diffusion and dilution). The population dose would represent an average weather condition.

H.6.5 Radioactive Release Characteristics

Radiological consequences were calculated by assigning radionuclide release fractions on the basis of the type of waste, the type of shipping container, and the accident severity category. The release fraction is defined as the fraction of radioactivity in the container that could be released to the atmosphere due to an accident with a given severity. Release fractions vary according to the waste type and the physical or chemical properties of the radioisotopes. Most solid radionuclides are nonvolatile and, therefore, are relatively nondispersible.

Representative release fractions were developed for each waste and container type on the basis of DOE and NRC reports (DOE 2002c; DOE Handbook 3010-94; NRC 1977; Sprung et al. 2000). The severity categories and corresponding release fractions provided in these documents cover a range of accidents from no impact (zero speed) to impacts at a speed in excess of 193 kilometers (120 miles) per hour onto an unyielding surface. Accidents that could occur at Hanford would have lower impacts due to lower local speed limits and site-specific road and surface characteristics.

For the IHLW in a Type B SNF cask, the particulate release fractions for vitrified waste described in the **Final Environmental Impact Statement for a Geologic Repository for the Disposal of Spent Nuclear Fuel and High-Level Radioactive Waste at Yucca Mountain, Nye County, Nevada (Yucca Mountain FEIS)** (DOE 2002a) were used. For the ILAW glass (including bulk vitrification and cast stone), the particulate release fractions for the severity categories corresponding to the severity accidents listed in NUREG-0170, **Radioactive Material Transport Study**, were used (DOE 2002c; NRC 1977). The aerosolized fractions for these waste types were assumed to be in the respirable range. For waste transported in Type A containers (e.g., a 208-liter [55-gallon] drum), the fractions of radioactive material released from the shipping container were based on recommended values from NUREG-0170 (NRC 1977). The NUREG-0170 values were multiplied by an aerosolized fraction to estimate the amount of material dispersed into the atmosphere. For CH- and RH-TRU waste, the release fractions corresponding to the NUREG-0170 severity categories and adapted in the **WIPP SEIS-II** were used (DOE 1997, 2002c).

For transport of sodium metal and sodium hydroxide solution in ISO container tanks, the severity fractions and associated release fractions were based on accident statistics from the National Highway Traffic Safety Administration (DOT 2002, 2004–2006) and recommended values from NUREG-0170, **Radioactive Material Transport Study** (NRC 1977), and **Airborne Release Fractions/Rates and Respirable Fractions for Nonreactor Nuclear Facilities** (DOE Handbook 3010-94). Human health

impacts due to toxic chemical exposures from sodium fires are analyzed in Appendix K; two of the analyses involve quantities of sodium similar to those expected to be present in a transportation accident. The potential toxic impacts of a transportation accident that produces a sodium fire are therefore expected to be comparable to those presented in Appendix K.

H.6.6 Acts of Sabotage or Terrorism

In the aftermath of the tragic events of September 11, 2001, DOE is continuing to assess potential measures to minimize the risk or potential consequences of radiological sabotage. While it is not possible to determine terrorists' motives and targets with certainty, DOE considers the threat of terrorist attack to be real and makes all efforts to reduce any vulnerability to this threat. DOE considers, evaluates, and plans for potential terrorist attacks during transportation and storage of radioactive materials. The details of any postulated terrorist attack, as well as DOE's plans for the security of its facilities and its terrorist countermeasures, are classified.

Nevertheless, DOE has evaluated the impacts of acts of sabotage and terrorism for SNF and HLW shipments (DOE 1996, 2002a). The spectrum of acts considered range from direct attack on the cask from afar to hijacking and exploding the shipping cask in an urban area. Both of these actions would result in damaging the cask and its contents and releasing radioactive materials. The fraction of the materials released depends on the nature of the attack (type of explosive or weapons used). The analyses of sabotage events described in the **Yucca Mountain FEIS** (DOE 2002a) were considered enveloping analyses for this **TC & WM EIS**. The events were assumed to involve either a truck- or rail-sized cask containing light-water reactor SNF. The consequences of such acts were calculated to result in an MEI dose of 40 to 110 rem (at 140 meters [460 feet]) for events involving a truck- or rail-sized cask, respectively. These events would lead to a 2 to 7 percent increase in the risk of fatal latent cancer to an MEI (DOE 2002a). The quantity of radioactive materials transported under all **TC & WM EIS** alternatives would be less than those considered in the **Yucca Mountain FEIS** (DOE 2002a) and its supplemental EIS (DOE 2008). Therefore, estimates of risks provided in the **Yucca Mountain FEIS** envelope the risks from an act of sabotage or terrorism involving radioactive material transported under all alternatives analyzed in this **TC & WM EIS**.

H.7 RISK ANALYSIS RESULTS

Per-shipment risk factors were calculated for collective populations of exposed persons and the crew for all anticipated routes and shipment configurations. Radiological risks are presented in doses per shipment for each unique route, material, and container combination. Per-shipment radiological risk factors for incident-free transportation and accident conditions are presented in Table H-6. For incident-free transportation, both dose and LCF risk factors are provided for the crew and exposed population. The radiological risks would result from potential exposure to external radiation emanating from the packaged waste. The exposed population would include the off-link public (people living along the route), on-link public (pedestrian and car occupants along the route) and the public at rest and fuel stops. For onsite shipments, the populations at rest and fuel stops are set at zero because a truck is not expected to stop during shipments that take less than an hour.

For transportation accidents, both radiological (in terms of potential LCFs among the exposed population) and nonradiological (in terms of number of traffic fatalities) risk factors are given. The LCF represents the number of additional latent fatal cancers among the exposed population. In an accident condition, the population would receive a direct dose if the package is not breached. If the package is breached, the population would receive an additional dose from released radioactive materials. For accidents with no release, the analysis conservatively assumed that it would take about 12 hours to remove the package and/or vehicle from the accident area (DOE 2002a). Accidents leading to loss of cask shielding would only be applicable to those shipments that use lead shielded casks, such as shipments of IHLW glass and

**Draft Tank Closure and Waste Management Environmental Impact Statement for the
Hanford Site, Richland, Washington**

RH-waste. Onsite accidents would not lead to loss of shielding due to lower vehicle velocity and accident impacts.

As indicated in Table H-6, all risk factors are less than one, meaning that no LCF or traffic fatalities are expected to occur during each transport. For example, the risk factors for the truck crew and the population from transporting one truck shipment of RH-TRU waste to WIPP are 1.07×10^{-4} and 3.21×10^{-5} LCFs, respectively. These values mean that there is a chance of 1 in 9,350 that an individual from a truck crew would develop a latent fatal cancer from exposure to radiation during one shipment of RH-TRU waste to WIPP and a chance of 1 in 31,150 that the exposed population residing along the transport route would experience an additional latent fatal cancer.

Table H-6. Risk Factors per Shipment of Radioactive Waste

| Waste Material (mode of transport) | Transport Destination | Incident-Free | | | | Accident | |
|--|--------------------------|---------------------------|-----------------------|------------------------------------|------------------------------|------------------------|---|
| | | Crew Dose (person-rem) | Crew Risk (LCFs) | Population Dose (person-rem) | Population Risk (LCFs) | Rad. Risk (LCFs) | Nonrad. Risk (traffic fatalities) |
| Tank Closure | | | | | | | |
| RH-TRU waste (T) ^a | WIPP | 1.78×10^{-1} | 1.07×10^{-4} | 5.35×10^{-2} | 3.21×10^{-5} | 2.52×10^{-7} | 6.10×10^{-5} |
| CH-TRU waste (T) ^a | WIPP | 1.17×10^{-1} | 7.03×10^{-5} | 4.24×10^{-2} | 2.55×10^{-5} | 7.64×10^{-9} | 6.10×10^{-5} |
| ILAW glass (T) | Hanford (on site) | 2.7×10^{-3} | 1.62×10^{-6} | 7.51×10^{-4} | 4.51×10^{-7} | 1.12×10^{-16} | 2.82×10^{-7} |
| Bulk vitrification glass (T) | Hanford (on site) | 2.10×10^{-2} | 1.26×10^{-5} | 2.22×10^{-2} | 1.33×10^{-5} | 2.69×10^{-14} | 2.82×10^{-7} |
| Cast stone waste (T) | Hanford (on site) | 1.61×10^{-2} | 9.64×10^{-6} | 2.26×10^{-3} | 1.36×10^{-6} | 6.97×10^{-15} | 2.82×10^{-7} |
| Steam reforming waste (T) | Hanford (on site) | 8.78×10^{-3} | 5.27×10^{-6} | 2.14×10^{-3} | 1.28×10^{-6} | 1.79×10^{-15} | 2.82×10^{-7} |
| Sulfate grout (T) | Hanford (on site) | 6.15×10^{-4} | 3.69×10^{-7} | 1.36×10^{-4} | 8.16×10^{-8} | 1.26×10^{-16} | 2.82×10^{-7} |
| IHLW glass (T) ^b | Hanford (on site) | 8.81×10^{-4} | 5.28×10^{-7} | 2.59×10^{-4} | 1.56×10^{-7} | 1.48×10^{-16} | 1.41×10^{-7} |
| RH-TRU waste (R) ^c | WIPP | 1.20×10^{-2} | 7.20×10^{-6} | 2.51×10^{-2} | 1.50×10^{-5} | 3.23×10^{-8} | 5.52×10^{-4} |
| CH-TRU waste (R) ^c | WIPP | 6.73×10^{-3} | 4.04×10^{-6} | 1.97×10^{-2} | 1.18×10^{-5} | 2.35×10^{-9} | 5.52×10^{-4} |
| Miscellaneous waste (T) ^d | Hanford (on site) | 1.96×10^{-3} | 1.18×10^{-6} | 6.68×10^{-5} | 4.01×10^{-8} | 2.05×10^{-10} | 2.82×10^{-7} |
| RH-TRU waste (T) | Hanford (on site) | 4.58×10^{-3} | 2.75×10^{-6} | 1.60×10^{-4} | 9.57×10^{-8} | 6.54×10^{-10} | 2.82×10^{-7} |
| CH-TRU waste (T) | Hanford (on site) | 1.19×10^{-3} | 7.12×10^{-7} | 2.14×10^{-4} | 1.29×10^{-7} | 2.10×10^{-9} | 2.82×10^{-7} |
| Fast Flux Test Facility | | | | | | | |
| Sodium metal (T) | INL | 2.03×10^{-2} | 1.22×10^{-5} | 5.45×10^{-3} | 3.27×10^{-6} | 5.29×10^{-10} | 1.92×10^{-5} |
| Sodium metal (R) | INL | 1.81×10^{-3} | 1.09×10^{-6} | 3.57×10^{-3} | 2.14×10^{-6} | 9.02×10^{-10} | 1.66×10^{-4} |
| Caustic (T) | Hanford | 1.01×10^{-2} | 6.08×10^{-6} | 2.72×10^{-3} | 1.63×10^{-6} | 1.27×10^{-12} | 1.92×10^{-5} |
| Caustic (R) | Hanford | 9.04×10^{-4} | 5.42×10^{-7} | 1.78×10^{-3} | 1.07×10^{-6} | 2.16×10^{-12} | 1.66×10^{-4} |
| RH special components (T) | INL | 7.83×10^{-2} | 4.70×10^{-5} | 3.24×10^{-2} | 1.94×10^{-5} | 4.42×10^{-12} | 1.92×10^{-5} |
| RH special components (R) | INL | 6.37×10^{-3} | 3.82×10^{-6} | 1.79×10^{-2} | 1.08×10^{-5} | 3.77×10^{-12} | 1.66×10^{-4} |
| Treated special components (T) ^e | NTS | 9.58×10^{-2} | 5.75×10^{-5} | 4.06×10^{-2} | 2.44×10^{-5} | 9.79×10^{-12} | 2.45×10^{-5} |

Table H-6. Risk Factors per Shipment of Radioactive Waste (continued)

| Waste Material (mode of transport) | Transport Destination | Incident-Free | | | | Accident | |
|---|--------------------------|---------------------------|-----------------------|------------------------------------|------------------------------|------------------------|---|
| | | Crew Dose (person-rem) | Crew Risk (LCFs) | Population Dose (person-rem) | Population Risk (LCFs) | Rad. Risk (LCFs) | Nonrad. Risk (traffic fatalities) |
| Fast Flux Test Facility (continued) | | | | | | | |
| Treated special components (R) ^c | NTS | 7.52×10^{-3} | 4.51×10^{-6} | 2.01×10^{-2} | 1.21×10^{-5} | 5.62×10^{-12} | 2.28×10^{-4} |
| Caustic (T) ^f | Hanford | 1.42×10^{-1} | 8.52×10^{-5} | 3.81×10^{-2} | 2.29×10^{-5} | 4.47×10^{-8} | 1.92×10^{-5} |
| Sodium metal | Hanford (on site) | 1.60×10^{-3} | 9.60×10^{-7} | 1.72×10^{-4} | 1.03×10^{-7} | 2.70×10^{-13} | 6.14×10^{-7} |
| Caustic | Hanford (on site) | 4.93×10^{-4} | 2.96×10^{-7} | 4.70×10^{-5} | 2.82×10^{-8} | 3.59×10^{-15} | 3.98×10^{-7} |
| Special components | Hanford (on site) | 6.14×10^{-3} | 3.69×10^{-6} | 1.02×10^{-3} | 6.14×10^{-7} | 1.25×10^{-14} | 6.14×10^{-7} |
| Reactor vessel | Hanford (on site) | 1.95×10^{-3} | 1.17×10^{-6} | 1.67×10^{-3} | 1.00×10^{-6} | N/A | N/A |
| Waste Management | | | | | | | |
| LLW (T) ^g | Hanford | 2.21×10^{-1} | 1.33×10^{-4} | 6.55×10^{-2} | 3.93×10^{-5} | 1.29×10^{-8} | 1.0×10^{-4} |
| LLW (R) ^g | Hanford | 8.36×10^{-3} | 5.02×10^{-6} | 2.14×10^{-2} | 1.28×10^{-5} | 9.06×10^{-9} | 7.63×10^{-4} |
| MLLW (T) ^g | Hanford | 1.61×10^{-1} | 9.66×10^{-5} | 6.03×10^{-2} | 3.62×10^{-5} | 2.09×10^{-8} | 9.27×10^{-5} |
| MLLW (R) ^g | Hanford | 5.68×10^{-3} | 3.41×10^{-6} | 2.01×10^{-2} | 1.21×10^{-5} | 2.86×10^{-8} | 7.45×10^{-4} |
| LLW ^h | Hanford (on site) | 1.25×10^{-2} | 7.48×10^{-6} | 3.06×10^{-4} | 1.84×10^{-7} | 3.81×10^{-12} | 9.15×10^{-7} |
| MLLW ^h | Hanford (on site) | 8.08×10^{-4} | 4.85×10^{-7} | 1.03×10^{-4} | 6.17×10^{-8} | 1.12×10^{-11} | 9.15×10^{-7} |

^a Truck is the current mode of transporting TRU waste to WIPP.

^b IHLW transport to an onsite storage location occurs within the 200 Areas.

^c Rail is the future/reserved mode of transporting TRU waste to WIPP.

^d Includes radioactively contaminated equipment, dirt, and ancillary equipment placed in shielded boxes during tank closure.

^e Impacts of transport of treated components to Hanford would be similar to those of transport to INL.

^f Reflects the transport of caustics generated from treatment of remote-handled special components.

^g These values reflect the maximum impacts of transport of radioactive waste from offsite sources (i.e., Argonne National Laboratory-East, Brookhaven National Laboratory, INL, Los Alamos National Laboratory, Oak Ridge National Laboratory, Paducah, Portsmouth, Savannah River Site, and West Valley Demonstration Project) to Hanford.

^h These values reflect maximum impacts of transport of onsite waste.

Key: CH=contact-handled; Hanford=Hanford Site; IHLW=immobilized high-level radioactive waste; ILAW=immobilized low-activity waste; INL=Idaho National Laboratory; LCF=latent cancer fatality; LLW=low-level radioactive waste; MLLW=mixed low-level radioactive waste; N/A=not applicable, no accident was considered; Nonrad.=nonradiological; NTS=Nevada Test Site; R=rail; Rad.=radiological; RH=remote-handled; T=truck; TRU=transuranic; WIPP=Waste Isolation Pilot Plant.

Both the radiological dose risk factor and nonradiological risk factor for transportation accidents are also presented in Table H-6. The radiological and nonradiological accident risk factors are provided in terms of potential fatalities per shipment. The radiological risks are presented in terms of LCFs. For the population, the radiological risks were calculated by multiplying the accident dose risks by the health risk factor of 0.0006 LCFs per person-rem of exposure. As stated in Section H.6.3, the accident dose is called “dose risk” because the values incorporate the spectrum of accident severity probabilities and associated consequences (e.g., dose). The radiological accident doses are very low because accident severity probabilities (i.e., the likelihood of accidents leading to confinement breach of a shipping cask and release of its content) are very small and, although persons reside within in an 80-kilometer (50-mile) radius of the road, they are generally quite far from the road. Because RADTRAN 5 uses an assumption of homogeneous population from the road out to 80 kilometers (50 miles), it greatly overestimates the actual doses. The nonradiological risk factors are nonoccupational traffic fatalities resulting from transportation accidents.

H.7.1 Tank Closure Alternatives

Table H-7 provides the estimated number of shipments for various wastes under all Tank Closure alternatives. The numbers of shipments were calculated using the estimated waste volumes and packagings for each waste type given in Appendix D, Section D.1, as well as the waste container and shipment characteristics provided in Table H-2. The offsite shipment values were based on an assumption that RH-TRU waste would be transported by truck. This assumption is consistent with the modes of transportation analyzed for the Preferred Alternative in the WIPP SEIS-II (DOE 1997) and selected in the WIPP SEIS-II Record of Decision (63 FR 3624).

Table H-7. Tank Closure Alternatives – Estimates of Number of Radioactive Waste Shipments

| Alternative | Number of Shipments | | | | | | | | | |
|-----------------|---------------------------|---------------------------|-------------------|------------|-----------------|--------------------|-----------------------|--------------|--------------|---------------------------|
| | Offsite Shipments | | Onsite Shipments | | | | | | | |
| | CH-TRU Waste ^a | RH-TRU Waste ^a | IHLW ^b | ILAW Glass | Bulk Vit. Glass | Cast Stone Waste | Steam Reforming Waste | CH-TRU Waste | RH-TRU Waste | Other Wastes ^c |
| 2A | N/A | N/A | 12,340 | 92,250 | N/A | N/A | N/A | N/A | N/A | 30 |
| 2B | N/A | N/A | 12,340 | 92,250 | N/A | N/A | N/A | N/A | N/A | 23,581 |
| 3A | 170 | 3,397 | 9,040 | 28,510 | 6,030 | N/A | N/A | 178 | 728 | 23,558 |
| 3B | 170 | 3,397 | 9,040 | 28,510 | N/A | 23,270 | N/A | 178 | 728 | 23,558 |
| 3C | 170 | 3,397 | 9,040 | 28,510 | N/A | N/A | 57,980 | 178 | 728 | 23,558 |
| 4 | 172 | 3,427 | 11,140 | 28,730 | 2,380 | 14,380 | N/A | 180 | 735 | 85,573 |
| 5 | 155 | 3,090 | 8,140 | 31,100 | 2,150 | 8,060 ^d | N/A | 162 | 663 | 10 |
| 6A, Base Case | N/A | N/A | 171,670 | 670 | N/A | N/A | N/A | N/A | N/A | 254,559 |
| 6A, Option Case | N/A | N/A | 171,670 | 18,290 | N/A | N/A | N/A | N/A | N/A | 254,680 |
| 6B, Base Case | N/A | N/A | 12,340 | 93,670 | N/A | N/A | N/A | N/A | N/A | 254,581 |
| 6B, Option Case | N/A | N/A | 12,340 | 111,290 | N/A | N/A | N/A | N/A | N/A | 254,658 |
| 6C | N/A | N/A | 12,340 | 92,250 | N/A | N/A | N/A | N/A | N/A | 23,581 |

^a Values are for truck shipments. Rail shipments are one-half of the values given.

^b The IHLW canisters include 340 cesium and strontium high-level radioactive waste canisters.

^c Other wastes include high-activity waste (equipment and soils), contaminated dirt and grout from the Preprocessing Facility high-level mixed radioactive waste, and end-of-life WTP low-activity waste melters, as applicable.

^d This number includes 6,120 shipments of sulfate grout.

Key: CH=contact-handled; IHLW=immobilized high-level radioactive waste; ILAW=immobilized low-activity waste; N/A=not applicable (no offsite shipments); RH=remote-handled; TRU=transuranic; Vit.=vitrification; WTP=Waste Treatment Plant.

Source: SAIC 2007a, 2008.

Transportation risks were calculated assuming that all shipments would be transported by rail or truck. DOE could decide to use a combination of both truck and rail for transporting materials. Note that the accident and fatality rates are per truck-kilometer or railcar-kilometer, as indicated in Section H.6.2. If DOE decides to ship waste materials using multiple railcars per transport, both accident and fatality rates would increase proportionally. The incident-free population dose would also increase proportionally as the exposure time increases; exposure time would be a function of the rail speed and the length of the waste package in each railcar. Therefore, rail transport per-shipment risk factors would increase proportionally as well. Hence, the risk results presented here are applicable irrespective of future decisions on multiple railcars per transport.

Appendix H • Transportation

Table H–8 summarizes the risks of transportation under each Tank Closure alternative. These risks were calculated by multiplying the previously given per-shipment factors by the number of shipments over the duration of the program and, for the radiological doses, by the health risk conversion factors. The values presented in Table H–8 show that the total radiological accident risks (the product of the frequency and consequences) are very small under all alternatives. The nonradiological accidents (the potential for fatalities as a direct result of traffic accidents) present the greatest risks. Considering that the transportation activities analyzed under the Tank Closure alternatives would occur from about 20 to over 150 years and the average number of traffic fatalities in the United States is about 40,000 per year (DOT 2007), the traffic fatality risk under all alternatives would be very small.

Table H–8. Tank Closure Alternatives – Risks of Transporting Radioactive Waste

| Alt. | Transport | Number of Shipments ^a | Incident-Free | | | | Accident | | One-Way Offsite Travel (10 ⁶ km) |
|-----------------|-----------------------|----------------------------------|-------------------|-----------------------|-------------------|-----------------------|-----------------------|-----------------------------------|---|
| | | | Crew | | Population | | Rad. Risk (LCFs) | Nonrad. Risk (traffic fatalities) | |
| | | | Dose (person-rem) | Risk (LCFs) | Dose (person-rem) | Risk (LCFs) | | | |
| 2A | Off site ^b | N/A | N/A | N/A | N/A | N/A | N/A | N/A | N/A |
| | On site | 104,621 | 259.67 | 1.56×10 ⁻¹ | 72.50 | 4.4×10 ⁻² | 1.2×10 ⁻¹¹ | 2.8×10 ⁻² | N/A |
| 2B | Off site ^b | N/A | N/A | N/A | N/A | N/A | N/A | N/A | N/A |
| | On site | 128,171 | 261.69 | 1.57×10 ⁻¹ | 72.52 | 4.4×10 ⁻² | 5.5×10 ⁻⁸ | 3.4×10 ⁻² | N/A |
| 3A | Off site | 3,567 | 624.88 | 3.75×10 ⁻¹ | 189.02 | 1.13×10 ⁻¹ | 8.6×10 ⁻⁴ | 2.2×10 ⁻¹ | 11.0 |
| | On site | 68,044 | 217.29 | 1.30×10 ⁻¹ | 157.93 | 9.5×10 ⁻² | 9.1×10 ⁻⁷ | 1.8×10 ⁻² | N/A |
| 3B | Off site | 3,567 | 624.88 | 3.75×10 ⁻¹ | 189.02 | 1.13×10 ⁻¹ | 8.6×10 ⁻⁴ | 2.2×10 ⁻¹ | 11.0 |
| | On site | 85,284 | 464.23 | 2.79×10 ⁻¹ | 76.56 | 4.6×10 ⁻² | 9.1×10 ⁻⁷ | 2.3×10 ⁻² | N/A |
| 3C | Off site | 3,567 | 624.88 | 3.75×10 ⁻¹ | 189.02 | 1.13×10 ⁻¹ | 8.6×10 ⁻⁴ | 2.2×10 ⁻¹ | 11.0 |
| | On site | 119,994 | 599.61 | 3.60×10 ⁻¹ | 147.98 | 8.9×10 ⁻² | 9.1×10 ⁻⁷ | 3.3×10 ⁻² | N/A |
| 4 | Off site | 3,599 | 630.46 | 3.78×10 ⁻¹ | 190.71 | 1.14×10 ⁻¹ | 8.7×10 ⁻⁴ | 2.2×10 ⁻¹ | 11.1 |
| | On site | 143,118 | 455.78 | 2.73×10 ⁻¹ | 115.07 | 6.9×10 ⁻² | 1.4×10 ⁻⁶ | 3.9×10 ⁻² | N/A |
| 5 | Off site | 3,245 | 568.50 | 3.41×10 ⁻¹ | 171.95 | 1.03×10 ⁻¹ | 7.8×10 ⁻⁴ | 2.0×10 ⁻¹ | 10.0 |
| | On site | 50,285 | 221.71 | 1.33×10 ⁻¹ | 85.11 | 5.1×10 ⁻² | 7.7×10 ⁻⁷ | 1.3×10 ⁻² | N/A |
| 6A, Base Case | Off site ^b | N/A | N/A | N/A | N/A | N/A | N/A | N/A | N/A |
| | On site | 426,899 | 449.85 | 2.70×10 ⁻¹ | 60.38 | 3.6×10 ⁻² | 2.0×10 ⁻⁶ | 9.6×10 ⁻² | N/A |
| 6A, Option Case | Off site ^b | N/A | N/A | N/A | N/A | N/A | N/A | N/A | N/A |
| | On site | 444,640 | 497.61 | 2.99×10 ⁻¹ | 73.63 | 4.4×10 ⁻² | 2.0×10 ⁻⁶ | 1.01×10 ⁻¹ | N/A |
| 6B, Base Case | Off site ^b | N/A | N/A | N/A | N/A | N/A | N/A | N/A | N/A |
| | On site | 360,591 | 560.35 | 3.36×10 ⁻¹ | 88.93 | 5.3×10 ⁻² | 2.0×10 ⁻⁶ | 1.0×10 ⁻¹ | N/A |
| 6B, Option Case | Off site ^b | N/A | N/A | N/A | N/A | N/A | N/A | N/A | N/A |
| | On site | 378,288 | 608.02 | 3.65×10 ⁻¹ | 102.18 | 6.1×10 ⁻² | 2.0×10 ⁻⁶ | 1.05×10 ⁻¹ | N/A |
| 6C | Off site ^b | N/A | N/A | N/A | N/A | N/A | N/A | N/A | N/A |
| | On site | 128,171 | 261.69 | 1.57×10 ⁻¹ | 72.52 | 4.4×10 ⁻² | 5.5×10 ⁻⁸ | 3.4×10 ⁻² | N/A |

^a Offsite shipments are based on truck transport of transuranic waste (current practice for transport to Waste Isolation Pilot Plant).

^b Under this Tank Closure alternative, no transuranic waste would be generated from treatment of tank waste.

Note: To convert kilometers to miles, multiply by 0.6214.

Key: Alt.=Alternative; km=kilometers; LCF=latent cancer fatality; N/A=not applicable; Nonrad.=nonradiological; Rad.=radiological.

The risks to various MEIs under incident-free transportation conditions were estimated for the hypothetical exposure scenarios identified in Section H.5.3. The estimated doses to workers, escorts, and the public are presented in Table H-9. Doses are presented on a per-event basis (person-rem per event), as it is unlikely that the same person would be exposed to multiple events; for those that could have multiple exposures, the cumulative dose could be calculated. The maximum dose to a crewmember was based on the same individual driving every shipment for the duration of the campaign. Note that the potential exists for larger individual exposures if multiple exposure events occur. For example, the dose to a person stuck in traffic next to a shipment of RH-TRU waste for 30 minutes was calculated to be 12 millirem. This scenario was considered a one-time event for that individual. The dose to an escort was estimated per trip to WIPP. Note that the maximum annual dose to a transportation worker would be 100 millirem per year unless the individual is a trained radiation worker, which would administratively limit the annual dose to 2 rem (DOE Standard 1098-99). The exposure to each individual escort would be administratively limited to 2 rem per year (DOE Standard 1098-99).

**Table H-9. Tank Closure Alternatives – Estimated Dose to
Maximally Exposed Individuals During Incident-Free Transportation Conditions**

| Receptor | Dose to Maximally Exposed Individual |
|--|---|
| Workers | |
| Crewmember (truck/rail driver) | 2 rem per year ^a |
| Inspector | 2.8×10^{-2} rem per event per hour of inspection |
| Rail yard worker ^b | 8×10^{-3} rem per event |
| Escort (rail transport) ^b | 3×10^{-2} rem per trip |
| Escort (truck transport) | 3.8×10^{-3} rem per trip |
| First responder (accidents with no release) | 2.6×10^{-3} rem per event per one-half hour |
| Public | |
| Resident (along the rail route) ^b | 6.3×10^{-7} rem per event |
| Resident (along the truck route) | 3.0×10^{-7} rem per event |
| Person in traffic congestion | 1.2×10^{-2} rem per event per one-half-hour stop |
| Resident near the rail yard during classification ^b | 8.3×10^{-5} rem per event |
| Person at a rest stop/gas station | 2.5×10^{-4} rem per event per hour of stop |
| Gas station attendee | 2.6×10^{-4} rem per event |

^a Maximum administrative dose limit per year for a trained radiation worker (truck/rail crewmember).

^b If the offsite transport were to use rail, with escort.

A member of the public residing along the route would likely receive multiple exposures from passing shipments. The cumulative dose to this resident can be calculated, assuming all shipments passed his or her home. The cumulative doses can be calculated, assuming that the resident would be present for every shipment and would be unshielded at a distance of 30 meters (about 98 feet) from the route. Therefore, the cumulative dose would depend on the number of truck or rail shipments passing a particular point and would be independent of the actual route being considered. The maximum dose to this resident, if all the materials were shipped via this route, would be about 1 millirem. This dose corresponds to that for the truck shipments under Tank Closure Alternative 4, which would have an estimated 3,600 truck shipments of CH- and RH-TRU waste shipments in about 40 years.

The accident risk assessment and the impacts shown in Table H-8 take into account the entire spectrum of potential accidents, from “fender benders” to extremely severe collisions. To provide additional insight into the severity of accidents in terms of the potential dose to an MEI and the public, an accident consequences assessment was performed for a maximum reasonably foreseeable hypothetical

transportation accident with a likelihood of occurrence of greater than 1 in 10 million per year. The results, presented in Table H–8, include all accidents, irrespective of their likelihood.

The maximum reasonably foreseeable offsite transportation accident with the highest consequences is an accident involving a truck shipment of RH-TRU waste. This severe-impact, high-temperature fire accident has a likelihood of occurrence of 4.7×10^{-7} per shipment in the rural area. The per-shipment likelihood of such an accident in suburban and urban areas is 9.4×10^{-9} and 2.8×10^{-10} , respectively. The consequences of such an accident in terms of dose and risk of LCFs to an MEI, an individual standing 100 meters (330 feet) downwind from the accident, and the population residing within 80 kilometers (50 miles) in the rural, suburban, and urban zones are provided in Table H–10.

Table H–10. Tank Closure Alternatives – Estimated Dose to the Population and to Maximally Exposed Individuals During the Most Severe Potential Accident

| Material and Accident Location | | Population ^a | | Maximally Exposed Individual ^b | |
|----------------------------------|----------|-------------------------|----------------------|---|----------------------|
| | | Dose (person-rem) | Risk (LCFs) | Dose (rem) | Risk (LCFs) |
| Remote-handled transuranic waste | Rural | 0.382 | 2.3×10^{-4} | 0.027 | 1.6×10^{-5} |
| | Suburban | 16.2 | 9.7×10^{-3} | 0.027 | 1.6×10^{-5} |
| | Urban | 110 | 6.6×10^{-2} | 0.027 | 1.6×10^{-5} |

^a Population extends at a uniform density to a radius of 80 kilometers (50 miles). The weather condition was assumed to be Pasquill Stability Class D, with a windspeed of 4 meters per second (9 miles per hour).

^b The individual is assumed to be 100 meters (330 feet) downwind from the accident and exposed to the entire plume of the radioactive release from a 2-hour, high-temperature fire. The weather condition was assumed to be Pasquill Stability Class F, with a windspeed of 1 meter per second (2.2 miles per hour).

Key: LCF=latent cancer fatality.

H.7.2 FFTF Decommissioning Alternatives

Table H–11 provides the estimated number of shipments for various wastes under all FFTF Decommissioning alternatives. The numbers of shipments were calculated using the estimated volumes and packagings for each waste type given in Appendix D, Section D.2, as well as the waste container and shipment characteristics provided in Table H–2. The values presented for offsite shipments in Table H–11 are the estimated numbers of truck shipments for the Idaho options of treating sodium metals and RH-SCs at INL. If these options are selected, the treated sodium, in the form of 50 weight-percent caustic solution, would be transported back to Hanford, and the treated RH-SCs would be shipped to NTS or transported back to Hanford for disposal.

Table H–11. FFTF Decommissioning Alternatives – Estimates of Number of Shipments

| Alternative | Number of Shipments | | | | | | | |
|-------------|--------------------------------|------------------|--------|------------------|------------------|--------|----------------|---------------------------|
| | Offsite Shipments ^a | | | Onsite Shipments | | | | |
| | Sodium Metal | Caustic Solution | RH-SCs | Sodium Metal | Caustic Solution | RH-SCs | Reactor Vessel | Other Wastes ^b |
| 1 | 0 | 0 | 0 | 0 | 0 | 0 | 0 | NA |
| 2 | 78 | 191 | 9 | 13 | 191 | 5 | 0 | 6,310 |
| 3 | 78 | 191 | 9 | 13 | 191 | 5 | 1 | 6,329 |

^a These are estimates for truck transports. Rail transports would be one-half of the values given.

^b Other wastes include components and decommissioning waste transported to an Integrated Disposal Facility and sanitary and hazardous landfills.

Key: NA=not analyzed; RH-SC=remote-handled special component.

Source: SAIC 2007b.

**Draft Tank Closure and Waste Management Environmental Impact Statement for the
Hanford Site, Richland, Washington**

FFTF Decommissioning alternatives consist of three distinct activities: facility disposition, disposition of bulk sodium, and disposition of RH-SCs. Table H-12 summarizes the risks of transportation under each disposition activity. The risks were calculated by multiplying the previously given per-shipment factors by the number of shipments over the duration of the program and, for the radiological doses, by the health risk conversion factors. The values presented in Table H-12 show that the total radiological accident risks (the product of the frequency and consequences) are very small under all disposition activities. In contrast, the nonradiological accidents (the potential for fatalities as a direct result of traffic accidents) present the greatest risks.

Table H-12. FFTF Decommissioning Alternatives – Risks of Transporting Radioactive Waste

| Disposition Activity | Location (transport mode) | Number of Shipments | Incident-Free | | | | Accident | | |
|----------------------------|---------------------------|---------------------|-------------------|----------------------|-------------------|----------------------|------------------------|-----------------------------------|---|
| | | | Crew | | Population | | Rad. Risk (LCFs) | Nonrad. Risk (traffic fatalities) | One-Way Offsite Travel (10 ⁵ km) |
| | | | Dose (person-rem) | Risk (LCFs) | Dose (person-rem) | Risk (LCFs) | | | |
| Disposition of bulk sodium | INL (T) | 269 | 3.52 | 2.1×10 ⁻³ | 0.945 | 5.7×10 ⁻⁴ | 4.15×10 ⁻⁸ | 5.2×10 ⁻³ | 2.60 |
| | INL (R) | 135 | 0.157 | 9.4×10 ⁻⁵ | 0.171 | 1.0×10 ⁻⁴ | 3.54×10 ⁻⁸ | 2.2×10 ⁻² | 1.43 |
| | Hanford | 204 | 0.115 | 6.9×10 ⁻⁵ | 0.0112 | 6.7×10 ⁻⁶ | 4.19×10 ⁻¹² | 8.4×10 ⁻⁵ | N/A |
| Disposition of RH-SCs | INL (T) ^a | 9 | 0.839 | 5.0×10 ⁻⁴ | 0.330 | 2.0×10 ⁻⁴ | 4.48×10 ⁻⁸ | 1.9×10 ⁻⁴ | 0.096 |
| | INL (R) ^a | 5 | 0.170 | 1.0×10 ⁻⁴ | 0.074 | 4.4×10 ⁻⁵ | 4.47×10 ⁻⁸ | 3.5×10 ⁻⁴ | 0.060 |
| | Hanford ^a | 5 | 0.032 | 1.9×10 ⁻⁵ | 0.0048 | 2.9×10 ⁻⁶ | 1.26×10 ⁻¹⁰ | 2.86×10 ⁻⁶ | N/A |
| Facility disposition | Hanford (Alt. 2) | 6,310 | (b) | (b) | (b) | (b) | (b) | 4.17×10 ⁻³ | N/A |
| | Hanford (Alt. 3) | 6,330 | 0.033 | 2×10 ⁻⁵ | 0.0025 | 1.5×10 ⁻⁶ | 7.6×10 ⁻¹¹ | 4.18×10 ⁻³ | N/A |

^a This transport includes one shipment of caustics generated from treatment of sodium metal within the remote-handled special components.

^b Not analyzed because all waste is sanitary or hazardous (not radioactive).

Note: To convert kilometers to miles, multiply by 0.6214.

Key: Alt.=Alternative; Hanford=Hanford Site; INL=Idaho National Laboratory; km=kilometers; LCF=latent cancer fatality; N/A=not applicable; Nonrad.=nonradiological; R=rail; Rad.=radiological; RH-SC=remote-handled special component; T=truck.

The risks to various MEIs under incident-free transportation conditions were estimated for the hypothetical exposure scenarios identified in Section H.5.3. The estimated doses to workers, escorts, and the public are presented in Table H-13. Doses are presented on a per-event basis (person-rem per event), as it is unlikely that the same person would be exposed to multiple events; for those that could have multiple exposures, the cumulative dose could be calculated. The maximum dose to a crewmember was based on the same individual driving every shipment for the duration of the campaign. Note that the potential exists for larger individual exposures if multiple exposure events occur. For example, the dose to a person stuck in traffic next to a shipment of RH-SCs for 30 minutes was calculated to be 19 millirem. This scenario was considered a one-time event for that individual. The dose to an escort was estimated per trip (either to NTS or INL). Note that the maximum annual dose to a transportation worker would be 100 millirem per year unless the individual is a trained radiation worker, which would administratively limit the annual dose to 2 rem (DOE Standard 1098-99). The exposure to each individual escort (considered a trained radiation worker) would be administratively limited to 2 rem per year.

Table H–13. FFTF Decommissioning Alternatives – Estimated Dose to Maximally Exposed Individuals During Incident-Free Transportation Conditions

| Receptor | Dose to Maximally Exposed Individual |
|--|---|
| Workers | |
| Crewmember (truck/rail driver) | 2 rem per year ^a |
| Inspector | 4.6×10^{-2} rem per event per hour of inspection |
| Rail yard worker | 7×10^{-4} rem per event |
| Escort (rail transport) | 1.7×10^{-2} rem per trip (Nevada Test Site) |
| Escort (truck transport) | 2.0×10^{-3} rem per trip (Nevada Test Site) |
| First responder (accidents with no release) ^b | 2.6×10^{-3} rem per event per one-half hour |
| Public | |
| Resident (along the rail route) | 1.2×10^{-6} rem per event |
| Resident (along the truck route) | 5.8×10^{-7} rem per event |
| Person in traffic congestion | 1.9×10^{-2} rem per event per one-half hour stop |
| Resident near the rail yard during classification | 6.4×10^{-6} rem per event |
| Person at a rest stop/gas station | 5.3×10^{-3} rem per event per hour of stop |
| Gas station attendee | 4.9×10^{-4} rem per event |

^a Maximum administrative dose limit per year for a trained radiation worker (truck/rail crewmember).

^b This dose would result from use of Type B casks for remote-handled special component transport. The external dose was assumed to be similar to that for the immobilized high-level radioactive waste rail cask.

Key: FFTF=Fast Flux Test Facility.

A member of the public residing along the route would likely receive multiple exposures from passing shipments. The cumulative dose to this resident can be calculated, assuming all shipments passed his or her home. The cumulative dose can be calculated, assuming that the resident would be present for every shipment and would be unshielded at a distance of 30 meters (about 98 feet) from the route. Therefore, the cumulative dose would depend on the number of truck or rail shipments passing a particular point and would be independent of the actual route being considered. The maximum dose to this resident, if all the materials are shipped via this route, would be less than 0.2 millirem. This dose corresponds to that for the rail shipments under both alternatives if the Idaho options of treating sodium and RH-SCs at INL are selected, which would require an estimated number of about 140 rail shipments over 2 years.

The accident risk assessment and the impacts shown in Table H–12 account for the entire spectrum of potential accidents, from “fender benders” to extremely severe collisions, regardless of their likelihood. To provide additional insight into the severity of accidents in terms of the potential dose to an MEI and the public, an accident consequence assessment was performed for a maximum reasonably foreseeable hypothetical transportation accident with a likelihood of occurrence of greater than 1 in 10 million per year.

The maximum reasonably foreseeable offsite transportation accident with the highest consequences is an accident involving a truck shipment of sodium metal, which would be a severe-impact, high-temperature fire accident. This accident has a likelihood of occurrence of 1.3×10^{-6} per shipment in the rural area. The per-shipment likelihood of such an accident in suburban and urban areas is 2.5×10^{-7} and 2.8×10^{-8} , respectively. The consequences of such an accident in terms of dose and risk of LCFs to an MEI, an individual standing 100 meters (330 feet) downwind from the accident, and the population residing within 80 kilometers (50 miles) of the accident in rural, suburban, and urban zones are provided in Table H–14.

Table H–14. FFTF Decommissioning Alternatives – Estimated Dose to the Population and to Maximally Exposed Individuals During the Most Severe Potential Accident

| Material and Accident Location | | Population ^a | | Maximally Exposed Individual ^b | |
|--------------------------------|----------|-------------------------|----------------------|---|----------------------|
| | | Dose (person-rem) | Risk (LCFs) | Dose (rem) | Risk (LCFs) |
| Sodium metal | Rural | 0.22 | 1.3×10^{-4} | 0.0015 | 9.0×10^{-7} |
| | Suburban | 1.20 | 7.2×10^{-4} | 0.0015 | 9.0×10^{-7} |
| | Urban | 5.60 | 3.4×10^{-3} | 0.0015 | 9.0×10^{-7} |

^a Population extends at a uniform density to a radius of 80 kilometers (50 miles). The weather condition was assumed to be Pasquill Stability Class D, with a windspeed of 4 meters per second (9 miles per hour).

^b The individual was assumed to be located 100 meters (300 feet) downwind from the accident and to be exposed to the entire plume of the radioactive release from a 2-hour, high-temperature fire. The weather condition was assumed to be Pasquill Stability Class F, with a windspeed of 1 meter per second (2.2 miles per hour).

Key: FFTF=Fast Flux Test Facility; LCF=latent cancer fatality.

H.7.3 Waste Management Alternatives

Table H–15 provides the estimated number of shipments for various wastes under all Waste Management alternatives. The shipment numbers were calculated using the estimated waste volumes for each waste type given in Appendix D, Section D.3, and the waste container and shipment characteristics provided in Table H–2. The values presented for the offsite waste shipments in Table H–15 were estimated for truck transports. Rail transports were assumed to be one-half of the values given.

Table H–15. Waste Management Alternatives – Estimates of Number of Shipments

| Alternative | Number of Shipments | | | |
|-------------|--------------------------------|-------------------|------------------|-------------------|
| | Offsite Shipments ^a | | Onsite Shipments | |
| | LLW ^b | MLLW ^b | LLW ^b | MLLW ^b |
| 1 | 0 | 0 | 807 | 196 |
| 2 | 15,273 | 1,318 | 807 | 196 |
| 3 | 15,273 | 1,318 | 807 | 196 |

^a These are estimates for truck transports. Rail transports would be one-half of the values given.

^b These include both contact- and remote-handled wastes.

Key: LLW=low-level radioactive waste; MLLW=mixed low-level radioactive waste.

Source: SAIC 2007c.

Table H–16 shows the risks of transportation under each of the Waste Management alternatives. The risks were calculated by multiplying the previously given per-shipment factors by the number of shipments over the duration of the program and, for radiological doses, by the health risk conversion factors. The values presented in Table H–12 show that the total radiological accident risks (the product of the frequency and consequences) are very small under all alternatives. In contrast, the nonradiological accidents (the potential for fatalities as a direct result of traffic accidents) present the greatest risks.

Table H–16. Waste Management Alternatives – Risks of Transporting Radioactive Waste

| Alt. | Transport (Mode) | Number of Shipments | Incident-Free | | | | Accident | | One-Way Offsite Travel (10 ⁶ km) |
|------|------------------|---------------------|-------------------|-----------------------|-------------------|-----------------------|-----------------------|-----------------------------------|---|
| | | | Crew | | Population | | Rad. Risk (LCFs) | Nonrad. Risk (traffic fatalities) | |
| | | | Dose (person-rem) | Risk (LCFs) | Dose (person-rem) | Risk (LCFs) | | | |
| 1 | Off site | N/A | N/A | N/A | N/A | N/A | N/A | N/A | N/A |
| | On site | 1,003 | 2.62 | 1.6×10 ⁻³ | 0.0826 | 5×10 ⁻⁵ | 2.10×10 ⁻⁹ | 2.6×10 ⁻⁴ | N/A |
| 2 | Off site (T) | 16,591 | 2,617 | 1.57 | 351.8 | 2.11×10 ⁻¹ | 6.0×10 ⁻⁵ | 1.10 | 53.8 |
| | Off site (R) | 8,289 | 52.69 | 3.16×10 ⁻² | 134.57 | 8.1×10 ⁻² | 2.9×10 ⁻⁵ | 4.28 | 27.4 |
| | On site | 1,003 | 4.3 | 2.6×10 ⁻³ | 0.138 | 8×10 ⁻⁵ | 3.6×10 ⁻⁹ | 4.1×10 ⁻⁴ | N/A |
| 3 | Off site (T) | 16,591 | 2,617 | 1.57 | 351.8 | 2.11×10 ⁻¹ | 6.0×10 ⁻⁵ | 1.10 | 53.8 |
| | Off site (R) | 8,289 | 52.69 | 3.2×10 ⁻² | 134.57 | 8.1×10 ⁻² | 2.9×10 ⁻⁵ | 4.28 | 27.4 |
| | On site | 1,003 | 2.62 | 1.6×10 ⁻³ | 0.0826 | 5×10 ⁻⁵ | 2.10×10 ⁻⁹ | 2.6×10 ⁻⁴ | N/A |

Note: To convert kilometers to miles, multiply by 0.6214.

Key: Alt.=Alternative; km=kilometers; LCF=latent cancer fatality; N/A=not applicable (no offsite waste would be accepted at the Hanford Site); Nonrad.=nonradiological; R=rail; Rad.=radiological; T=truck.

The risks to various MEIs under incident-free transportation conditions were estimated for the hypothetical exposure scenarios identified in Section H.5.3. The estimated doses to workers, escorts, and the public are presented in Table H–17 on a per-event basis (person-rem per event), as it is unlikely that the same person would be exposed to multiple events; for those that could have multiple exposures, the cumulative dose could be calculated. The maximum dose to a crewmember is based on the same individual driving every shipment for the duration of the campaign. Note that the potential exists for larger individual exposures if multiple exposure events occur. For example, the dose to a person stuck in traffic next to a shipment of RH-waste in a Type B cask for 30 minutes was calculated to be 10 millirem. Note that the maximum annual dose to a transportation worker would be 100 millirem per year unless the individual is a trained radiation worker, which would administratively limit the annual dose to 2 rem (DOE Standard 1098-99).

Table H–17. Waste Management Alternatives – Estimated Dose to Maximally Exposed Individuals During Incident-Free Transportation Conditions

| Receptor | Dose to Maximally Exposed Individual |
|--|---|
| Workers | |
| Crewmember (truck/rail driver) | 2 rem per year ^a |
| Inspector | 2.3×10 ⁻² rem per event per hour of inspection |
| Rail yard worker | 8×10 ⁻³ rem per event |
| First responder (accidents with no release) ^b | 1.2×10 ⁻³ rem per event per one-half hour |
| Public | |
| Resident (along the rail route) | 6.3×10 ⁻⁷ rem per event |
| Resident (along the truck route) | 3.0×10 ⁻⁷ rem per event |
| Person in traffic congestion | 1.0×10 ⁻² rem per event per one-half hour stop |
| Resident near the rail yard during classification | 8.3×10 ⁻⁵ rem per event |
| Person at a rest stop/gas station | 9.7×10 ⁻⁵ rem per event per hour of stop |
| Gas station attendee | 7.9×10 ⁻⁴ rem per event |

^a Maximum administrative dose limit per year for a trained radiation worker (truck/rail crewmember).

^b This dose results from using a Type B cask for remote-handled waste.

A member of the public residing along the route would likely receive multiple exposures from passing shipments. The cumulative dose to this resident can be calculated assuming all shipments passed his or her home. The cumulative doses can be calculated assuming that the resident would be present for every shipment and would be unshielded at a distance of 30 meters (about 98 feet) from the route. Therefore, the cumulative dose would depend on the number of truck or rail shipments passing a particular point and

would be independent of the actual route being considered. The maximum dose to this resident, if all the materials are shipped via this route, would be less than 5 millirem. This dose corresponds to those for truck shipments under Waste Management Alternatives 2 and 3, which have an estimated number of truck shipments of about 16,600 over 20 years.

The accident risk assessment and the impacts shown in Table H–16 account for the entire spectrum of potential accidents, from “fender benders” to extremely severe collisions. To provide additional insight into the severity of accidents in terms of the potential dose to an MEI and the public, an accident consequence assessment was performed for a maximum reasonably foreseeable hypothetical transportation accident with a likelihood of occurrence of greater than 1 in 10 million per year. The results, presented in Table H–18, include all accidents, irrespective of their likelihood.

Table H–18. Waste Management Alternatives – Estimated Dose to the Population and the Maximally Exposed Individuals During the Most Severe Potential Accident

| Material and Accident Location | | Population ^a | | Maximally Exposed Individual ^b | |
|----------------------------------|----------|-------------------------|----------------------|---|----------------------|
| | | Dose (person-rem) | Risk (LCFs) | Dose (rem) | Risk (LCFs) |
| Idaho National Laboratory RH-LLW | Rural | 1.62 | 9.7×10^{-4} | 0.00031 | 1.9×10^{-7} |
| | Suburban | 25.24 | 1.5×10^{-2} | 0.00031 | 1.9×10^{-7} |
| | Urban | 120.88 | 7.3×10^{-2} | 0.00031 | 1.9×10^{-7} |

^a Population extends at a uniform density to a radius of 80 kilometers (50 miles). The weather condition was assumed to be Pasquill Stability Class D, with a windspeed of 4 meters per second (9 miles per hour).

^b The individual is assumed to be 100 meters (300 feet) downwind from the accident and to be exposed to the entire plume of the radioactive release from a 2-hour, high-temperature fire. The weather condition was assumed to be Pasquill Stability Class F, with a windspeed of 1 meter per second (2.2 miles per hour).

Key: LCF=latent cancer fatality; RH-LLW=remote-handled low-level radioactive waste.

The maximum reasonably foreseeable offsite transportation accident with the highest consequences is an accident involving a rail shipment of RH-LLW, which would be a severe-impact, high-temperature fire accident with a likelihood of occurrence of 2.5×10^{-7} per shipment in the rural area. The per-shipment likelihood of such an accident in suburban and urban areas is 2.8×10^{-8} and 5.3×10^{-9} , respectively. The consequences of such an accident in terms of dose and risk of LCFs to an MEI, an individual standing 100 meters (330 feet) downwind from the accident, and the population residing within 80 kilometers (50 miles) in the rural, suburban, and urban zones are provided in Table H–18.

H.8 IMPACT OF CONSTRUCTION AND OPERATIONAL MATERIAL TRANSPORT

This section evaluates the impacts of transporting the materials required to construct new facilities, as well as those required to immobilize, vitrify, or solidify the liquid waste and transport it to storage or burial locations. The construction materials considered are concrete, cement, sand/gravel/dirt, asphalt, steel, and piping. The materials required for waste solidification and transport include glass formers, fly ash, blast furnace slag, canisters, cylinders, and boxes. The impacts were evaluated based on the number of truck shipments required for each of the materials and the distances from their points of origin to Hanford. The origins of these materials are defined as on site, local, and regional, with an average distance of 8, 72, and 256 kilometers (5, 45, and 160 miles) each way, respectively. The truck kilometers for all material shipments under each alternative were calculated by summing the distances for all activities from construction through deactivation and closure (if applicable) under each alternative. The truck accident and fatality rates were assumed to be those provided earlier for onsite radioactive waste transport. Table H–19 summarizes the impacts in terms of the total number of kilometers, accidents, and fatalities for all alternatives. The results in Table H–19 indicate that for the Tank Closure alternatives, the potential for traffic fatalities is the largest under Alternative 6A, Option Case, with the potential for

six traffic fatalities, followed by Alternative 3C and Alternative 6A, Base Case, each potentially resulting in approximately three traffic fatalities. Considering that the duration of Alternative 6A is more than 150 years, the estimated annual fatality is very small.

Table H–19. Estimated Impacts of Construction and Operational Material Transport

| Alternative | Total Distance Traveled (million kilometers) | Number of Accidents | Number of Fatalities |
|---|---|------------------------|-------------------------|
| Tank Closure Alternatives | | | |
| 1 | 1.04 | 0.13 | 0.009 |
| 2A | 49.47 | 6.08 | 0.41 |
| 2B | 64.97 | 7.99 | 0.54 |
| 3A | 67.17 | 7.52 | 0.51 |
| 3B | 94.33 | 11.60 | 0.78 |
| 3C | 407.19 | 50.08 | 3.38 |
| 4 | 120.24 | 14.79 | 1.00 |
| 5 | 87.96 | 10.82 | 0.73 |
| 6A, Base Case | 385.42 | 47.41 | 3.20 |
| 6A, Option Case | 767.02 | 94.34 | 6.37 |
| 6B, Base Case | 140.35 | 17.26 | 1.16 |
| 6B, Option Case | 272.83 | 33.56 | 2.26 |
| 6C | 71.12 | 8.75 | 0.59 |
| FFTF Decommissioning Alternatives | | | |
| 1: No Action | 0.031 | 0.0038 | 0.0003 |
| 2: Entombment | | | |
| Facility Disposition | 1.83 | 0.225 | 0.015 |
| Options at Hanford ^a | 0.35 | 0.043 | 0.0029 |
| Disposition of Bulk Sodium | 0.039 | 0.005 | 0.0003 |
| Disposition of RH-SCs | 0.31 | 0.039 | 0.0026 |
| Options at INL ^a | 0.18 | 0.022 | 0.0015 |
| Disposition of Bulk Sodium | 0.018 | 0.002 | 0.0001 |
| Disposition of RH-SCs | 0.16 | 0.020 | 0.0013 |
| 3: Removal | | | |
| Facility Disposition | 2.06 | 0.254 | 0.017 |
| Options at Hanford ^a | 0.35 | 0.043 | 0.0029 |
| Options at INL ^a | 0.18 | 0.022 | 0.0015 |
| Waste Management Alternatives | | | |
| 1: No Action | 0.40 | 0.05 | 0.003 |
| 2: Disposal in IDF, 200-East Area Only | | | |
| Disposal Group 1 | 8.40 | 1.03 | 0.07 |
| Disposal Group 2 | 29.72 | 3.66 | 0.25 |
| Disposal Group 3 | 37.98 | 4.67 | 0.32 |
| 3: Disposal in IDF, 200-East and 200-West Areas | | | |
| Disposal Group 1 | 7.65 | 0.94 | 0.06 |
| Disposal Group 2 | 29.89 | 3.68 | 0.25 |
| Disposal Group 3 | 38.08 | 4.68 | 0.32 |

^a These are common activities under both Alternatives 2 and 3.

Note: To convert kilometers to miles, multiply by 0.6214. The baseline includes activities related to facility disposition; the options include treatment of bulk sodium and RH-SCs.

Key: FFTF=Fast Flux Test Facility; Hanford=Hanford Site; INL=Idaho National Laboratory; RH-SC=remote-handled special component.

H.9 CONCLUSIONS

Transportation of any commodity involves a risk to both transportation crewmembers and members of the public. This risk results directly from transportation-related accidents and indirectly from the increased levels of pollution from vehicle emissions, regardless of the cargo. The transportation of certain materials, such as hazardous or radioactive waste, can pose an additional risk due to the unique nature of the material itself.

H.9.1 Tank Closure Alternatives

Tank closure activities would generate various radioactive waste materials that would require transport for disposition to offsite locations such as New Mexico (WIPP) under Alternatives 3 through 5 as well as to onsite locations within Hanford. In addition, all alternatives would require transport of various nonradioactive materials for construction and operational support. Based on the results presented in the previous sections, the following conclusions were reached (see Tables H-7, H-8, and H-19):

- It is unlikely that transportation of radioactive waste would cause an additional fatality as a result of radiation from either incident-free operations or postulated transportation accidents.
- The highest risk to the public would be under Alternative 4, in which about 3,600 truck shipments of TRU waste would be transported to WIPP and 143,118 shipments of various radioactive waste materials would be transported to onsite waste burial and storage locations.
- The lowest risk to the public would be under Alternative 2A, in which only 104,621 shipments of various radioactive wastes would be transported to onsite waste burial and storage locations over a period of 75 years.
- Alternatives 3 through 5 and 6 have risk estimates between those of Alternatives 2A and 4.
- The nonradiological accidents (the potential for fatalities as a direct result of traffic accidents) present the greatest risks. Considering that the transportation activities analyzed would occur over about 20 to 150 years and the average number of traffic fatalities in the United States is about 40,000 per year, the traffic fatality risks under all alternatives are very small.

H.9.2 FFTF Decommissioning Alternatives

FFTF decommissioning activities would generate various radioactive materials that would require transport to both offsite and onsite locations for treatment and/or disposal. Radioactive materials would need to be transported off site if DOE decides to treat sodium or RH-SCs at INL. Based on the results presented in the previous section, the following conclusions were reached (see Tables H-11, H-12, and H-19):

- It is unlikely that transportation of radioactive waste would cause an additional fatality due to radiation resulting from either incident-free operations or postulated transportation accidents.
- The highest risk to the public would be under the Idaho options for treatment of bulk sodium and RH-SCs at INL. Alternative 3 adds additional risks for transport of radioactive materials for disposal at an Integrated Disposal Facility and transport of nonradioactive materials for disposal at a sanitary and hazardous landfill.

- The lowest risk to the public would be under the Hanford options for treatment of bulk sodium and RH-SCs at Hanford. Alternative 2 adds some risks for the transport of the nonradioactive materials for disposal at a sanitary and hazardous landfill.

H.9.3 Waste Management Alternatives

The various wastes generated at Hanford from tank closure and FFTF decommissioning activities, along with the waste transported from offsite DOE sources, would be managed and disposed of at an Integrated Disposal Facility. Offsite waste would be accepted at Hanford only under Alternatives 2 and 3. The onsite-generated LLW and MLLW, excluding waste from tank closure and FFTF decommissioning activities, would be common to all alternatives. Transport and disposition of all other waste considered under the Waste Management alternatives were already evaluated under the Tank Closure and FFTF Decommissioning alternatives. Based on the results presented earlier, the following conclusions were reached (see Tables H-15, H-16, and H-19):

- It is unlikely that transportation of radioactive waste would cause an additional fatality as a result of radiation from either incident-free operations or postulated transportation accidents. Note that the maximum annual dose to a transportation worker would be 100 millirem per year unless the individual is a trained radiation worker, which would administratively limit the annual dose to 2 rem (DOE Standard 1098-99). Exposure to a maximum annual dose of 2 rem per year would lead to an LCF risk of 0.0012. Assuming that an individual is exposed to the same annual exposure for 20 years, the cumulative LCF risk would be 0.024.
- The highest risk to the public would occur under Alternative 2 or 3, in which about 16,600 shipments of waste would be transported to Hanford from various DOE facilities.
- The lowest risk to the public would occur under Alternative 1, in which no shipments of waste would be transported to Hanford from various DOE facilities.

H.10 LONG-TERM IMPACTS OF TRANSPORTATION

The cumulative impacts of the transportation of radioactive material, consisting of the impacts of historic shipments of radioactive waste and SNF, reasonably foreseeable actions that include transportation of radioactive material, and general radioactive material transportation that is unrelated to a particular action, are detailed in Appendix T. The collective dose to the general population and workers was the measure used to quantify the cumulative transportation impacts. This measure of impact was chosen because it may be directly related to the LCFs using a cancer risk coefficient. Table H-20 summarizes the total worker and general population collective doses from various transportation activities. The table shows that the impacts of this program are quite small compared with the overall transportation impacts. The total collective worker dose from all types of shipments (historical or related to the alternatives, reasonably foreseeable actions, and general transportation) was estimated to range from 406,390 to 407,350 person-rem (about 244 LCFs) for the period from 1943 through 2073 (131 years). The total general population collective dose was estimated to range from 378,680 to 378,940 person-rem (about 227 LCFs). The majority of the collective doses to workers and the general population would be due to the general transportation of radioactive material and shipments of various SNF and reactor fuel materials under the activities related to the Global Nuclear Energy Partnership (see Appendix T, Table T-4). Examples of general transportation activities include shipments of radiopharmaceuticals to nuclear medicine laboratories and shipments of commercial LLW to commercial disposal facilities. The total number of LCFs estimated to result from radioactive material transportation over the period from 1943 through 2073 is about 470. Over this same period (131 years), approximately 72.4 million people would die from cancer, based on 554,000 cancer fatalities per year (CDC 2007). The transportation-related

LCFs would be about 0.0007 percent of the annual number of cancer deaths; therefore, any increase would be indistinguishable from the natural fluctuation in the total annual death rate from cancer.

Table H-20. Cumulative Transportation-Related Radiological Collective Doses and Latent Cancer Fatalities

| Category | Worker Dose (person-rem) | General Population Dose (person-rem) |
|--|-----------------------------|---|
| Tank Closure alternatives | 260–1,224 ^a | 73–337 ^b |
| FFTF Decommissioning alternatives | 0.95–4.4 ^a | 0.34–1.3 ^b |
| Waste Management alternatives | 2,620–2,621 ^a | 352 ^b |
| Transportation impacts in this TC & WM EIS | 2,881–3,849 ^a | 425–690 ^b |
| Other Nuclear Material Shipments (Appendix T) | | |
| Historical | 292 | 317 |
| Reasonably foreseeable | 29,214 | 39,936 |
| General transportation (1943–2073) | 374,000 | 338,000 |
| Total—other nuclear materials (up to 2073) ^c | 403,510 | 378,250 |
| Total Collective Dose (up to 2073)^c | 406,390–407,350 | 378,680–378,940 |
| Total Latent Cancer Fatalities | ~244 | ~227 |

^a Range of values among the alternatives for the worker dose.

^b Range of values among the alternatives for the population dose.

^c The sum values were rounded to the nearest 10.

Key: FFTF=Fast Flux Test Facility; TC & WM EIS=Tank Closure and Waste Management Environmental Impact Statement for the Hanford Site, Richland, Washington.

Source: Appendix T of this TC & WM EIS.

H.11 UNCERTAINTY AND CONSERVATISM IN ESTIMATED IMPACTS

The sequence of analyses performed to generate the estimates of radiological risk for transportation includes (1) determination of the inventory and characteristics, (2) estimation of shipment requirements, (3) determination of route characteristics, (4) calculation of radiation doses to exposed individuals (including estimation of environmental transport and uptake of radionuclides), and (5) estimation of health effects. Uncertainties are associated with each of these steps. Uncertainties exist in the way that the physical systems being analyzed are represented by the computational models; in the data required to exercise the models (due to measurement errors, sampling errors, natural variability, or unknowns caused simply by the future nature of the actions being analyzed); and in the calculations themselves (e.g., approximate algorithms used by the computers).

In principle, one can estimate the uncertainty associated with each input or computational source and predict the resultant uncertainty in each set of calculations. Thus, one can propagate the uncertainties from one set of calculations to the next and estimate the uncertainty in the final, or absolute, result; however, conducting such a full-scale quantitative uncertainty analysis is often impractical and sometimes impossible, especially for actions to be initiated at an unspecified time in the future. Instead, risk analysis is designed to ensure, through uniform and judicious selection of scenarios, models, and input parameters, that relative comparisons of risk among the various alternatives are meaningful. In the transportation risk assessment, this design was accomplished by uniformly applying common input parameters and assumptions to each alternative. Therefore, although considerable uncertainty is inherent in the absolute magnitude of the transportation risk for each alternative, much less uncertainty is associated with the relative differences among the alternatives in a given measure of risk.

In the following sections, areas of uncertainty are discussed for the assessment steps enumerated above. Special emphasis is placed on identifying whether the uncertainties affect relative or absolute measures of

risk. The reality and conservatism of the assumptions also are addressed. Where practical, the parameters that most significantly affect the risk assessment results are identified.

H.11.1 Uncertainties in Material Inventory and Characterization

Waste inventories and their physical and radiological characteristics are important input parameters to the transportation risk assessment. The potential number of shipments for all alternatives was primarily based on the projected dimensions of package contents, the strength of the radiation field, the heat that must be dissipated, and assumptions concerning shipment capacities. The physical and radiological characteristics are important in determining the material released during accidents and the subsequent doses to exposed individuals through multiple environmental exposure pathways.

Uncertainties in the inventory and characterization are reflected in the transportation risk results. If the inventory is overestimated or underestimated, the resulting transportation risk estimates would also be overestimated or underestimated by roughly the same factor. However, the same inventory estimates were used to analyze the transportation impacts of each of the TC & WM EIS alternatives. Therefore, for comparative purposes, the observed differences in transportation risks among the alternatives, as given in Table H-8, H-12, and H-16, are believed to represent unbiased, reasonably accurate estimates based on current information in terms of relative risk comparisons.

H.11.2 Uncertainties in Containers, Shipment Capacities, and Number of Shipments

Transportation activities required under each alternative were estimated based in part on assumptions concerning the packaging characteristics and shipment capacities for commercial trucks. Waste shipments would be made in federally and state-certified packages. If a waste type would require a special packaging for offsite transport, the analysis assumed that a specially designed package would be built and certified before the transportation could occur. Shipment capacities have been defined for assessment purposes based on probable future shipment capacities. In reality, the actual shipment capacities may differ from the predicted capacities such that the projected number of shipments and, consequently, the total transportation risk, would change. However, although the predicted transportation risks would increase or decrease accordingly, the relative differences in risks among the alternatives would remain about the same.

H.11.3 Uncertainties in Route Determination

Routes were determined between all origin and destination sites considered in this TC & WM EIS. These routes are consistent with current guidelines, regulations, and practices, but may not be the actual routes that would be used in the future. In reality, the actual routes could differ from the analyzed ones with regard to distances and total populations along the routes. Moreover, because materials could be transported over an extended period starting at some time in the future, the highway infrastructures and demographics along the routes could change. These effects were not accounted for in the transportation assessment; however, potential changes are not expected to significantly affect the relative comparisons of risk among the alternatives considered in this TC & WM EIS.

H.11.4 Uncertainties in the Calculation of Radiation Doses

The models used to calculate radiation doses from transportation activities introduce further uncertainty into the risk assessment process. Estimating the accuracy or absolute uncertainty of the risk assessment results is generally difficult. The accuracy of the calculated results is closely related to the limitations of the computational models and the uncertainties in each of the input parameters that the model requires. The single greatest limitation facing users of RADTRAN, or any computer code of this type, is the scarcity of data for certain input parameters. Populations (off-link and on-link) along the routes, shipment

surface dose rates, and individuals residing near the roads are the most uncertain data in dose calculations. In preparing these data, one makes assumptions that the off-link population is uniformly distributed; the on-link population is proportional to the traffic density, with an assumed occupancy of two persons per car; the shipment surface dose rate is the maximum allowed dose rate; and the potential exists for an individual to be residing at the edge of the road. It is clear that not all of these assumptions are accurate. For example, the off-link population is mostly heterogeneous, and the on-link traffic density varies widely from road to road within a geographic zone (i.e., urban, suburban, or rural). Finally, added to this complexity are assumptions regarding the expected distances between the public and a shipment at a traffic stop, rest stop, or traffic jam and the afforded shielding.

The uncertainties associated with the computational models were reduced by using state-of-the-art computer codes that have undergone extensive review. Because many uncertainties are recognized but difficult to quantify, assumptions were made at each step of the risk assessment process that were intended to produce conservative results (i.e., to overestimate the calculated dose and radiological risk). Because the parameters and assumptions were applied consistently to all of the alternatives, this model bias is not expected to affect the meaningfulness of the relative comparisons of risk; however, the results may not represent the risks in an absolute sense.

H.12 REFERENCES

CDC (Centers for Disease Control and Prevention), 2007, **Total Number of Deaths for 113 Selected Causes, 1999–2004**, National Center for Health Statistics, Hyattsville, Maryland, March 30.

DOE (U.S. Department of Energy), 1996, **Final Environmental Impact Statement on a Proposed Nuclear Weapons Nonproliferation Policy Concerning Foreign Research Reactor Spent Nuclear Fuel**, DOE/EIS-0218F, Office of Spent Nuclear Fuel Management, Washington, D.C., February.

DOE (U.S. Department of Energy), 1997, **Waste Isolation Pilot Plant Disposal Phase Final Supplemental Environmental Impact Statement**, DOE/EIS-0026-S-2, Carlsbad Area Office, Carlsbad, New Mexico, September.

DOE (U.S. Department of Energy), 2002a, **Final Environmental Impact Statement for a Geologic Repository for the Disposal of Spent Nuclear Fuel and High-Level Radioactive Waste at Yucca Mountain, Nye County, Nevada**, DOE/EIS-0250, Office of Civilian Radioactive Waste Management, Yucca Mountain Site Characterization Office, North Las Vegas, Nevada, February.

DOE (U.S. Department of Energy), 2002b, **Safety Evaluation Report, Hanford Transportation Safety Document**, DOE/RL-2001-0036, Rev. 0, Richland Operations Office, Richland, Washington, February.

DOE (U.S. Department of Energy), 2002c, **A Resource Handbook on DOE Transportation Risk Assessment**, DOE/EM/NTP/HB-01, Office of Environmental Management, National Transportation Program, Albuquerque, New Mexico, July.

DOE (U.S. Department of Energy), 2003, “Recommended Radiation Risk Factors Updated,” **National Environmental Policy Act Lessons Learned**, U.S. Department of Energy Quarterly Report, No. 34, First Quarter FY 2003, March 3.

DOE (U.S. Department of Energy), 2008, **Final Supplemental Environmental Impact Statement for a Geologic Repository for the Disposal of Spent Nuclear Fuel and High-Level Radioactive Waste at Yucca Mountain, Nye County, Nevada**, DOE/EIS-0250F-S1, June.

DOT (U.S. Department of Transportation), 2002, **Traffic Safety Facts 2001: A Compilation of Motor Vehicle Crash Data from the Fatality Analysis Reporting System and the General Estimates System**, DOT HS 809 484, National Highway Traffic Safety Administration, National Center for Statistics and Analysis, Washington, D.C., December.

DOT (U.S. Department of Transportation), 2004, **Traffic Safety Facts 2002: A Compilation of Motor Vehicle Crash Data from the Fatality Analysis Reporting System and the General Estimates System**, DOT HS 809 620, National Highway Traffic Safety Administration, National Center for Statistics and Analysis, Washington, D.C., January.

DOT (U.S. Department of Transportation), 2005, **Traffic Safety Facts 2003: A Compilation of Motor Vehicle Crash Data from the Fatality Analysis Reporting System and the General Estimates System**, DOT HS 809 775, National Highway Traffic Safety Administration, National Center for Statistics and Analysis, Washington, D.C., January.

DOT (U.S. Department of Transportation), 2006, **Traffic Safety Facts 2004: A Compilation of Motor Vehicle Crash Data from the Fatality Analysis Reporting System and the General Estimates System**, DOT HS 809 919, National Highway Traffic Safety Administration, National Center for Statistics and Analysis, Washington, D.C., January.

DOT (U.S. Department of Transportation), 2007, **Traffic Safety Facts 2005: A Compilation of Motor Vehicle Crash Data from the Fatality Analysis Reporting System and the General Estimates System**, DOT HS 810 631, National Highway Traffic Safety Administration, National Center for Statistics and Analysis, Washington, D.C., January.

FEMA (Federal Emergency Management Agency), 2008a, **National Response Framework**, U.S. Department of Homeland Security, accessed through <http://www.fema.gov/pdf/emergency/nrf/nrf-core.pdf>, January

FEMA (Federal Emergency Management Agency), 2008b, **Nuclear/Radiological Incident Annex**, U.S. Department of Homeland Security, accessed through http://www.fema.gov/pdf/emergency/nrf/nrf_nuclearradiologicalincidentannex.pdf, June.

FHWA (Federal Highway Administration), 2003, **Comprehensive Truck Size and Weight Study – Executive Summary**, accessed through <http://www.fhwa.dot.gov/reports/twstudy/EXECSUM4.htm>, May 19.

Fischer, L.E., C.K. Chou, M.A. Gerhard, C.Y. Kimura, R.W. Martin, R.W. Mensing, M.E. Mount, and M.C. Witte, 1987, **Shipping Container Response to Severe Highway and Railway Accident Conditions**, NUREG/CR-4829, U.S. Nuclear Regulatory Commission, Office of Nuclear Regulatory Research, Division of Reactor System Safety, Washington, D.C., February.

Johnson, P.E., and R.D. Michelhaugh, 2003, **Transportation Routing Analysis Geographic Information System (TRAGIS) User’s Manual**, ORNL/NTRC-006, Rev. 0, Oak Ridge National Laboratory, Oak Ridge, Tennessee, June.

Neuhauser, K.S., F.L. Kanipe, and R.F. Weiner, 2000, **RADTRAN 5 Technical Manual**, SAND2000-1256, Sandia National Laboratories, Albuquerque, New Mexico, May.

Neuhauser, K.S., and F.L. Kanipe, 2003, **RADTRAN 5 User Guide**, SAND2003-2354, Sandia National Laboratories, Albuquerque, New Mexico, July.

**Draft Tank Closure and Waste Management Environmental Impact Statement for the
Hanford Site, Richland, Washington**

NRC (U.S. Nuclear Regulatory Commission), 1977, **Final Environmental Impact Statement on the Transportation of Radioactive Material by Air and Other Modes**, NUREG-0170, Office of Standards Development, Washington, D.C., December.

Rao, R.K., E.L. Wilmot, and R.E. Luna, 1982, **Non-radiological Impacts of Transporting Radioactive Material**, SAND81-1703, Sandia National Laboratories, Albuquerque, New Mexico, February.

SAIC (Science Applications International Corporation), 2007a, **Tank Closure Alternatives, Scaled Data Sets to Support the “Tank Closure and Waste Management Environmental Impact Statement for the Hanford Site, Richland, Washington,”** Germantown, Maryland, July 12.

SAIC (Science Applications International Corporation), 2007b, **Fast Flux Test Facility Alternatives, Scaled Data Sets to Support the “Tank Closure and Waste Management Environmental Impact Statement for the Hanford Site, Richland, Washington,”** Germantown, Maryland, July 12.

SAIC (Science Applications International Corporation), 2007c, **Waste Management Alternatives, Scaled Data Sets to Support the “Tank Closure and Waste Management Environmental Impact Statement for the Hanford Site, Richland, Washington,”** Germantown, Maryland, July 12.

SAIC (Science Applications International Corporation), 2008, **Revised Scaled Data Sets to Support the “Tank Closure and Waste Management Environmental Impact Statement for the Hanford Site, Richland, Washington,”** Germantown, Maryland, October 9.

Saricks, C., and M.M. Tompkins, 1999, **State-Level Accident Rates of Surface Freight Transportation: A Reexamination**, ANL/ESD/TM-150, Argonne National Laboratory, Center for Transportation Research, Argonne, Illinois, April.

Sprung, J.L., D.J. Ammerman, M.L. Breivik, R.J. Dukart, F.L. Kanipe, J.A. Koski, G.S. Mills et al., 2000, **Reexamination of Spent Fuel Shipment Risk Estimates**, NUREG/CR-6672, U.S. Nuclear Regulatory Commission, Office of Nuclear Safety and Safeguards, Spent Fuel Project Office, Washington, D.C., March.

Yuan et al. (Yuan, Y.C., S.Y. Chen, B.M. Biwer, and D.J. LePoire), 1995, **RISKIND – A Computer Program for Calculating Radiological Consequences and Health Risks from Transportation of Spent Nuclear Fuel**, ANL/EAD-1, Argonne National Laboratory, Argonne, Illinois, November.

Code of Federal Regulations

10 CFR 20, U.S. Nuclear Regulatory Commission, “Standards for Protection Against Radiation.”

10 CFR 71, U.S. Nuclear Regulatory Commission, “Packaging and Transportation of Radioactive Material.”

10 CFR 71.4, U.S. Nuclear Regulatory Commission, “Packaging and Transportation of Radioactive Material: Definitions.”

10 CFR 71.47, U.S. Nuclear Regulatory Commission, “Packaging and Transportation of Radioactive Material: External Radiation Standards for All Packages.”

49 CFR 171, U.S. Department of Transportation, “General Information, Regulations, and Definitions.”

49 CFR 172, U.S. Department of Transportation, “Hazardous Materials Table, Special Provisions, Hazardous Materials Communications, Emergency Response Information, and Training Requirements.”

49 CFR 173, Pipeline and Hazardous Materials Safety Administration, U.S. Department of Transportation, “Shippers – General Requirements for Shipments and Packagings.”

49 CFR 173.7(d), Pipeline and Hazardous Materials Safety Administration, U.S. Department of Transportation, “Shippers – General Requirements for Shipments and Packagings: Government Operations and Materials.”

49 CFR 173.403, Pipeline and Hazardous Materials Safety Administration, U.S. Department of Transportation, “Shippers – General Requirements for Shipments and Packagings: Definitions.”

49 CFR 173.427, Pipeline and Hazardous Materials Safety Administration, U.S. Department of Transportation, “Shippers – General Requirements for Shipments and Packagings: Transport Requirements for Low Specific Activity (LSA) Class 7 (Radioactive) Materials and Surface Contaminated Objects (SCO).”

49 CFR 173.435, Pipeline and Hazardous Materials Safety Administration, U.S. Department of Transportation, “Shippers – General Requirements for Shipments and Packagings: Table of A1 and A2 Values for Radionuclides.”

49 CFR 173.441, Pipeline and Hazardous Materials Safety Administration, U.S. Department of Transportation, “Shippers – General Requirements for Shipments and Packagings: Radiation Level Limitations and Exclusive Use Provisions.”

49 CFR 174, U.S. Department of Transportation, “Carriage by Rail.”

49 CFR 175, U.S. Department of Transportation, “Carriage by Aircraft.”

49 CFR 176, U.S. Department of Transportation, “Carriage by Vessel.”

49 CFR 177, U.S. Department of Transportation, “Carriage by Public Highway.”

49 CFR 397, Federal Motor Carrier Safety Administration, U.S. Department of Transportation, “Transportation of Hazardous Materials; Driving and Parking Rules.”

Federal Register

63 FR 3624, U.S. Department of Energy, 1998, “Record of Decision for the Department of Energy’s Waste Isolation Pilot Plant Disposal Phase; Notice,” January 23.

65 FR 10061, U.S. Department of Energy, 2000, “Record of Decision for the Department of Energy’s Waste Management Program: Treatment and Disposal of Low-Level Waste and Mixed Low-Level Waste; Amendment of the Record of Decision for the Nevada Test Site,” February 25.

U.S. Department of Energy Handbook and Standard

DOE Handbook 3010-94, **Airborne Release Fractions/Rates and Respirable Fractions for Nonreactor Nuclear Facilities**, Vol. 1, “Analysis of Experimental Data,” December 1994.

DOE Standard 1098-99, **Radiological Control**, July 1999.

Washington Administrative Code

WAC 173-303, Washington State Department of Ecology, “Dangerous Waste Regulations,” Olympia, Washington, November 2004.

WAC 246-231, Washington State Department of Health, “Packaging and Transportation of Radioactive Material.”

WAC 446-50, Washington State Patrol, “Transportation of Hazardous Material.”

APPENDIX I

WORKFORCE ESTIMATES

This appendix presents the estimated number of workers required to perform construction, operations, deactivation, closure, and decommissioning tasks under each of the alternatives presented in this *Tank Closure and Waste Management Environmental Impact Statement for the Hanford Site, Richland, Washington*.

I.1 INTRODUCTION

Full-time equivalent (FTE) estimates were based on information provided in data reports prepared to support this environmental impact statement (SAIC 2007a, 2007b, 2007c, 2008). The total number of FTEs for each activity was calculated based on the estimated labor hours for onsite radiological, onsite nonradiological, and offsite nonradiological worker categories. The total number of hours was divided by the number of years for each activity. The hours per year were then divided by an assumed 2,080 hours worked per year (40 hours per week multiplied by 52 weeks) to get the number of FTEs per year. The estimated number of FTEs per year for each activity was then combined to get the total for each alternative. The total FTEs by alternatives are presented in Table I-1. Because the duration of each activity varies, the sum of the FTEs per year for each activity under an alternative does not necessarily represent the actual number of FTEs required to accomplish the work for that alternative in any given year. That information is provided in Chapter 4, Sections 4.1.9, 4.2.9, 4.3.9 and 4.4.9. However, the FTEs per year presented in this appendix are useful for comparing the magnitude and complexity of workforce commitments between the alternatives.

Table I-1. Total Full-Time Equivalents by Alternative

| Alternative | Total Hours | Hours per Year | Full-Time Equivalents per Year | Onsite Full-Time Equivalents | Offsite Full-Time Equivalents |
|--|---------------|----------------|--------------------------------|------------------------------|-------------------------------|
| Tank Closure 1 | 16,323,079 | 4,471,026 | 2,155 | 1,733 | 422 |
| Tank Closure 2A | 704,106,159 | 31,080,821 | 14,793 | 13,286 | 1,707 |
| Tank Closure 2B | 394,403,464 | 30,219,436 | 14,585 | 12,901 | 1,684 |
| Tank Closure 3A | 356,664,801 | 31,221,257 | 15,047 | 13,392 | 1,655 |
| Tank Closure 3B | 352,475,386 | 30,692,005 | 14,827 | 13,173 | 1,654 |
| Tank Closure 3C | 365,011,394 | 32,708,645 | 15,796 | 13,977 | 1,819 |
| Tank Closure 4 | 454,686,498 | 36,790,158 | 17,763 | 15,415 | 2,348 |
| Tank Closure 5 | 332,599,727 | 36,092,088 | 17,418 | 15,229 | 2,189 |
| Tank Closure 6A Base Case | 2,546,926,815 | 44,280,484 | 21,365 | 18,353 | 3,012 |
| Tank Closure 6A Option Case | 2,620,744,236 | 51,139,606 | 24,668 | 20,849 | 3,819 |
| Tank Closure 6B Base Case | 519,770,623 | 39,322,632 | 18,979 | 16,520 | 2,459 |
| Tank Closure 6B Option Case | 576,748,348 | 46,246,691 | 22,311 | 19,045 | 3,266 |
| Tank Closure 6C | 395,006,068 | 30,274,161 | 14,596 | 12,912 | 1,684 |
| FFTF Decommissioning 1 | 41,600 | 416 | 1 | 1 | 0 |
| FFTF Decommissioning 2 Facility Disposition | 809,855 | 235,309 | 122 | 112 | 10 |
| FFTF Decommissioning 3 Facility Disposition | 950,657 | 273,109 | 139 | 132 | 7 |
| FFTF Decommissioning 2 and 3 | | | | | |
| Disposition of RH-SCs | | | | | |
| Hanford Option | 468,340 | 296,573 | 144 | 113 | 31 |
| Idaho Option | 421,733 | 273,326 | 134 | 107 | 27 |

Draft Tank Closure and Waste Management Environmental Impact Statement for the
Hanford Site, Richland, Washington

Table I-1. Total Full-Time Equivalents by Alternative (continued)

| Alternative | Total Hours | Hours per Year | Full-Time Equivalents per Year | Onsite Full-Time Equivalents | Offsite Full-Time Equivalents |
|----------------------------|-------------|----------------|--------------------------------|------------------------------|-------------------------------|
| Disposition of Bulk Sodium | | | | | |
| Hanford Reuse Option | 579,641 | 320,184 | 157 | 126 | 31 |
| Idaho Reuse Option | 265,647 | 163,262 | 83 | 76 | 7 |
| Waste Management 1 | 1,004,078 | 262,212 | 129 | 125 | 4 |
| Waste Management 2 | 37,858,714 | 2,496,985 | 1,209 | 1,101 | 108 |
| Disposal Group 1 | 19,847,015 | 3,704,371 | 1,788 | 1,606 | 182 |
| Disposal Group 2 | 127,796,452 | 14,594,924 | 7,025 | 6,340 | 685 |
| Disposal Group 3 | 204,134,676 | 14,581,594 | 7,025 | 6,340 | 685 |
| Waste Management 3 | 37,858,714 | 2,496,985 | 1,209 | 1,101 | 108 |
| Disposal Group 1 | 21,402,185 | 4,232,487 | 2,045 | 1,862 | 128 |
| Disposal Group 2 | 128,983,129 | 15,148,881 | 7,294 | 6,607 | 687 |
| Disposal Group 3 | 205,238,633 | 15,148,881 | 7,294 | 6,607 | 687 |

Key: FTF=Fast Flux Test Facility; RH-SCs=remote-handled special components.

The following sections present the detailed FTE estimates for each activity, within each alternative.

I.2 ALTERNATIVES

Construction, operations, deactivation, closure, and decommissioning (where appropriate) workforce estimate tables are presented for each of the alternatives in the following sections. In addition, all radiological workers were assumed to work on site.

I.2.1 Tank Closure Alternative 1: No Action

Table I-2. Tank Closure Alternative 1 Construction Rollup Workforce Estimate

| Activity | Total Hours | Duration | | | Hours per Year | Full-Time Equivalents per Year | Onsite Full-Time Equivalents |
|--|-------------|----------|--------|-------|----------------|--------------------------------|------------------------------|
| | | Start | Finish | Years | | | |
| Canister Storage Building (CON_CSB) | | | | | | | |
| Radiological workers | 31,500 | 2006 | 2008 | 3 | 10,500 | 6 | 12 |
| Nonradiological workers | | | | | | | |
| On site | 37,071 | 2006 | 2008 | 3 | 12,357 | 6 | |
| Off site | 13,714 | 2006 | 2008 | 3 | 4,571 | 3 | |
| Other Infrastructure Upgrades (CON_OIU) | | | | | | | |
| Radiological workers | 80,906 | 2006 | 2008 | 3 | 26,969 | 13 | 45 |
| Nonradiological workers | | | | | | | |
| On site | 198,469 | 2006 | 2008 | 3 | 66,156 | 32 | |
| Off site | 76,875 | 2006 | 2008 | 3 | 25,625 | 13 | |
| Tank Upgrades (CON_TU) | | | | | | | |
| Radiological workers | 179,348 | 2006 | 2008 | 3 | 59,783 | 29 | 104 |
| Nonradiological workers | | | | | | | |
| On site | 466,826 | 2006 | 2008 | 3 | 155,609 | 75 | |
| Off site | 176,870 | 2006 | 2008 | 3 | 58,957 | 29 | |

Table I–2. Tank Closure Alternative 1 Construction Rollup Workforce Estimate (continued)

| Activity | Total Hours | Duration | | | Hours per Year | Full-Time Equivalents per Year | Onsite Full-Time Equivalents |
|--|------------------|----------|--------|-------|------------------|--------------------------------|------------------------------|
| | | Start | Finish | Years | | | |
| Waste Treatment Plant (CON_WTP) | | | | | | | |
| Radiological workers | N/A | | | | | | |
| Nonradiological workers | | | | | | | 906 |
| On site | 5,653,125 | 2006 | 2008 | 3 | 1,884,375 | 906 | |
| Off site | 1,884,375 | 2006 | 2008 | 3 | 628,125 | 302 | |
| Total | 8,799,079 | | | | 2,933,026 | 1,414 | 1,067 |

Notes and Assumptions:

Total number of offsite full-time equivalents = 347.

Hours worked per year = 2,080.

One full-time equivalent was assumed for activities estimated to require less than 2,080 hours per year.

Key: N/A=not applicable.

Source: Compiled from SAIC 2007a, 2008.

Table I–3. Tank Closure Alternative 1 Operations Rollup Workforce Estimate

| Activity | Total Hours | Duration | | | Hours per Year | Full-Time Equivalents per Year | Onsite Full-Time Equivalents |
|--------------------------------------|------------------|----------|--------|-------|------------------|--------------------------------|------------------------------|
| | | Start | Finish | Years | | | |
| Routine Operations (OPS_ROUT) | | | | | | | |
| Radiological workers | 780,000 | 2006 | 2008 | 3 | 260,000 | 125 | |
| Nonradiological workers | | | | | | | 651 |
| On site | 3,279,000 | 2006 | 2008 | 3 | 1,093,000 | 526 | |
| Off site | 465,000 | 2006 | 2008 | 3 | 155,000 | 75 | |
| Total | 4,524,000 | | | | 1,508,000 | 726 | 651 |

Notes and Assumptions:

Total number of offsite full-time equivalents = 75.

Hours worked per year = 2,080.

One full-time equivalent was assumed for activities estimated to require less than 2,080 hours per year.

Source: Compiled from SAIC 2007a, 2008.

Table I–4. Tank Closure Alternative 1 Deactivation Rollup Workforce Estimate

| Activity | Total Hours | Duration | | | Hours per Year | Full-Time Equivalents per Year | Onsite Full-Time Equivalents |
|--|------------------|----------|--------|-------|----------------|--------------------------------|------------------------------|
| | | Start | Finish | Years | | | |
| Administrative Controls (DEA_ADM) | | | | | | | |
| Radiological workers | 3,000,000 | 2008 | 2107 | 100 | 30,000 | 15 | 15 |
| Nonradiological workers | N/A | | | | | | |
| Total | 3,000,000 | | | | 30,000 | 15 | 15 |

Notes and Assumptions:

Hours worked per year = 2,080.

One full-time equivalent was assumed for activities estimated to require less than 2,080 hours per year.

Key: N/A=not applicable.

Source: Compiled from SAIC 2007a, 2008.

I.2.2 Tank Closure Alternative 2A: Existing WTP Vitrification; No Closure

Table I-5. Tank Closure Alternative 2A Construction Rollup Workforce Estimate

| Activity | Total Hours | Duration | | | Hours per Year | Full-Time Equivalents per Year | Onsite Full-Time Equivalents |
|--|-------------|----------|--------|-------|----------------|--------------------------------|------------------------------|
| | | Start | Finish | Years | | | |
| Canister Storage Building (CON_CSB) | | | | | | | |
| Radiological workers | 115,500 | 2006 | 2016 | 11 | 10,500 | 6 | 12 |
| Nonradiological workers | | | | | | | |
| On site | 135,929 | 2006 | 2016 | 11 | 12,357 | 6 | |
| Off site | 50,286 | 2006 | 2016 | 11 | 4,571 | 3 | |
| Immobilized High-Level Radioactive Waste Shipping/Transfer Facility (CON_STF) | | | | | | | |
| Radiological workers | N/A | | | | | | 380 |
| Nonradiological workers | | | | | | | |
| Onsite construction | 1,757,000 | 2011 | 2013 | 3 | 585,667 | 282 | |
| Onsite exempt | 610,000 | 2011 | 2013 | 3 | 203,333 | 98 | |
| Offsite design | 748,000 | 2011 | 2013 | 3 | 249,333 | 120 | |
| Immobilized High-Level Radioactive Waste Interim Storage Modules (CON_ISM) | | | | | | | |
| Radiological workers | N/A | | | | | | 232 |
| Nonradiological workers | | | | | | | |
| Onsite construction | 1,781,106 | 2014 | 2019 | 6 | 296,851 | 143 | |
| Onsite exempt | 1,100,000 | 2014 | 2019 | 6 | 183,333 | 89 | |
| Offsite design | 1,350,000 | 2014 | 2019 | 6 | 225,000 | 109 | |
| Other Infrastructure Upgrades (CON_OIU) | | | | | | | |
| Radiological workers | 782,094 | 2006 | 2034 | 29 | 26,969 | 13 | 45 |
| Nonradiological workers | | | | | | | |
| On site | 1,918,531 | 2006 | 2034 | 29 | 66,156 | 32 | |
| Off site | 743,125 | 2006 | 2034 | 29 | 25,625 | 13 | |
| Tank Upgrades (CON_TU) | | | | | | | |
| Radiological workers | 1,195,652 | 2006 | 2025 | 20 | 59,783 | 29 | 104 |
| Nonradiological workers | | | | | | | |
| On site | 3,112,174 | 2006 | 2025 | 20 | 155,609 | 75 | |
| Off site | 1,179,130 | 2006 | 2025 | 20 | 58,957 | 29 | |
| Underground Transfer Lines (CON_UTL) | | | | | | | |
| Radiological workers | N/A | | | | | | 61 |
| Nonradiological workers | | | | | | | |
| On site | 126,005 | 2009 | 2009 | 1 | 126,005 | 61 | |
| Off site | 17,400 | 2009 | 2009 | 1 | 17,400 | 9 | |
| Waste Treatment Plant (CON_WTP) | | | | | | | |
| Radiological workers | N/A | | | | | | 906 |
| Nonradiological workers | | | | | | | |
| On site | 22,612,500 | 2006 | 2017 | 12 | 1,884,375 | 906 | |
| Off site | 7,537,500 | 2006 | 2017 | 12 | 628,125 | 302 | |
| Cesium and Strontium Capsule Processing Facility (CON_CSC) | | | | | | | |
| Radiological workers | N/A | | | | | | 190 |
| Nonradiological workers | | | | | | | |
| On site | 1,578,029 | 2088 | 2091 | 4 | 394,507 | 190 | |
| Off site | 465,683 | 2088 | 2091 | 4 | 116,421 | 56 | |

Table I-5. Tank Closure Alternative 2A Construction Rollup Workforce Estimate (continued)

| Activity | Total Hours | Duration | | | Hours per Year | Full-Time Equivalents per Year | Onsite Full-Time Equivalents |
|---|-------------|----------|--------|-------|----------------|--------------------------------|------------------------------|
| | | Start | Finish | Years | | | |
| Tank Risers (CON_RIS) | | | | | | | |
| Radiological workers | 172,920 | 2013 | 2056 | 44 | 3,930 | 2 | 5 |
| Nonradiological workers | | | | | | | |
| On site | 233,180 | 2013 | 2056 | 44 | 5,300 | 3 | |
| Off site | N/A | | | | | | |
| Modified Sluicing Retrieval System (CON_MS) | | | | | | | |
| Radiological workers | 4,914,513 | 2013 | 2092 | 80 | 61,431 | 30 | 77 |
| Nonradiological workers | | | | | | | |
| On site | 7,761,221 | 2013 | 2092 | 80 | 97,015 | 47 | |
| Off site | 2,730,672 | 2013 | 2092 | 80 | 34,133 | 17 | |
| Mobile Retrieval System (CON_MRS) | | | | | | | |
| Radiological workers | 8,098,800 | 2013 | 2052 | 40 | 202,470 | 98 | 206 |
| Nonradiological workers | | | | | | | |
| On site | 8,940,660 | 2013 | 2052 | 40 | 223,517 | 108 | |
| Off site | 4,794,060 | 2013 | 2052 | 40 | 119,852 | 58 | |
| Vacuum-Based Retrieval System (CON_VBR) | | | | | | | |
| Radiological workers | 9,686,600 | 2053 | 2092 | 40 | 242,165 | 117 | 242 |
| Nonradiological workers | | | | | | | |
| On site | 10,344,950 | 2053 | 2092 | 40 | 258,624 | 125 | |
| Off site | 5,898,200 | 2053 | 2092 | 40 | 147,455 | 71 | |
| High-Level Radioactive Waste Melter Interim Storage Facilities (CON_PAD)^a | | | | | | | |
| Radiological workers | N/A | | | | | | 1 |
| Nonradiological workers | | | | | | | |
| On site | 8,424 | 2015 | 2066 | 6 | 1,404 | 1 | |
| Off site | N/A | | | | | | |
| Double-Shell Tank Replacements (CON_DST) | | | | | | | |
| Radiological workers | N/A | | | | | | 144 |
| Nonradiological workers | | | | | | | |
| On site | 12,530,000 | 2013 | 2054 | 42 | 298,333 | 144 | |
| Off site | 4,508,000 | 2013 | 2054 | 42 | 107,333 | 52 | |
| Waste Treatment Plant Replacement (CON_WTPU) | | | | | | | |
| Radiological workers | N/A | | | | | | 1,355 |
| Nonradiological workers | | | | | | | |
| On site | 33,800,000 | 2065 | 2076 | 12 | 2,816,667 | 1,355 | |
| Off site | 11,300,000 | 2065 | 2076 | 12 | 933,333 | 449 | |
| Underground Transfer Line Replacement (CON_UTLU) | | | | | | | |
| Radiological workers | N/A | | | | | | 61 |
| Nonradiological workers | | | | | | | |
| On site | 126,005 | 2044 | 2044 | 1 | 126,005 | 61 | |
| Off site | 17,400 | 2044 | 2044 | 1 | 17,400 | 9 | |
| Effluent Treatment Facility Replacement (CON ETF) | | | | | | | |
| Radiological workers | N/A | | | | | | 329 |
| Nonradiological workers | | | | | | | |
| On site | 2,047,400 | 2023 | 2025 | 3 | 682,467 | 329 | |
| Off site | 703,895 | 2023 | 2025 | 3 | 234,632 | 113 | |

Draft Tank Closure and Waste Management Environmental Impact Statement for the
Hanford Site, Richland, Washington

Table I-5. Tank Closure Alternative 2A Construction Rollup Workforce Estimate (continued)

| Activity | Total Hours | Duration | | | Hours per Year | Full-Time Equivalents per Year | Onsite Full-Time Equivalents |
|--|--------------------|----------|--------|-------|-------------------|--------------------------------|------------------------------|
| | | Start | Finish | Years | | | |
| Effluent Treatment Facility Replacement (CON ETFU) | | | | | | | |
| Radiological workers | N/A | | | | | | |
| Nonradiological workers | | | | | | | |
| On site | 2,047,400 | 2053 | 2055 | 3 | 682,467 | 329 | 329 |
| Off site | 703,895 | 2053 | 2055 | 3 | 234,632 | 113 | |
| 242-A Evaporator Replacement (CON EVA) | | | | | | | |
| Radiological workers | N/A | | | | | | |
| Nonradiological workers | | | | | | | |
| On site | 635,400 | 2015 | 2017 | 3 | 211,800 | 102 | 102 |
| Off site | 217,918 | 2015 | 2017 | 3 | 72,639 | 35 | |
| 242-A Evaporator Replacement (CON EVAU)^b | | | | | | | |
| Radiological workers | N/A | | | | | | |
| Nonradiological workers | | | | | | | |
| On site | 1,270,800 | 2040 | 2067 | 6 | 211,800 | 102 | 102 |
| Off site | 441,450 | 2040 | 2067 | 6 | 73,575 | 36 | |
| Total | 182,749,404 | | | | 13,431,255 | 6,477 | 4,883 |

^a CON_PAD activities are conducted over three 2-year periods.

 Period 1, 2015–2016

 Period 2, 2040–2041

 Period 3, 2065–2066

^b CON_EVAU activities are conducted over two 3-year periods.

 Period 1, 2040–2042

 Period 2, 2065–2067

Notes and Assumptions:

 Total number of offsite full-time equivalents = 1,700.

 Hours worked per year = 2,080.

 One full-time equivalent was assumed for activities estimated to require less than 2,080 hours per year.

Key: N/A=not applicable.

Source: Compiled from SAIC 2007a, 2008.

Table I-6. Tank Closure Alternative 2A Operations Rollup Workforce Estimate

| Activity | Total Hours | Duration | | | Hours per Year | Full-Time Equivalents per Year | Onsite Full-Time Equivalents |
|--|-------------|----------|--------|-------|----------------|--------------------------------|------------------------------|
| | | Start | Finish | Years | | | |
| Immobilized High-Level Radioactive Waste Interim Storage Facilities (OPS_ISF) | | | | | | | |
| Radiological workers | 11,907,300 | 2018 | 2092 | 75 | 158,764 | 77 | 120 |
| Nonradiological workers | | | | | | | |
| On site | 6,660,000 | 2018 | 2092 | 75 | 88,800 | 43 | |
| Other Infrastructure Upgrades (OPS_OIU) | | | | | | | |
| Radiological workers | 102,818 | 2006 | 2092 | 87 | 1,182 | 1 | 4 |
| Nonradiological workers | | | | | | | |
| On site | 377,000 | 2006 | 2092 | 87 | 4,333 | 3 | |
| Off site | 268,909 | 2006 | 2092 | 87 | 3,091 | 2 | |
| Routine Operations (OPS_ROUT) | | | | | | | |
| Radiological workers | 22,620,000 | 2006 | 2092 | 87 | 260,000 | 125 | 651 |
| Nonradiological workers | | | | | | | |
| On site | 95,091,000 | 2006 | 2092 | 87 | 1,093,000 | 526 | |
| Off site | 13,485,000 | 2006 | 2092 | 87 | 155,000 | 75 | |
| Retrieval Operations (OPS_RET) | | | | | | | |
| Radiological workers | 29,659 | 2006 | 2092 | 87 | 341 | 1 | 28 |
| Nonradiological workers | | | | | | | |
| On site | 4,834,432 | 2006 | 2092 | 87 | 55,568 | 27 | |
| Off site | 37,568 | 2006 | 2092 | 87 | 432 | 1 | |
| Interim Stabilization/Double-Shell Tanks (OPS_IST) | | | | | | | |
| Radiological workers | 3,193,295 | 2006 | 2092 | 87 | 36,705 | 18 | 44 |
| Nonradiological workers | | | | | | | |
| On site | 4,569,477 | 2006 | 2092 | 87 | 52,523 | 26 | |
| Off site | 5,046,000 | 2006 | 2092 | 87 | 58,000 | 28 | |
| Waste Treatment Plant (OPS_WTP) | | | | | | | |
| Radiological workers | 157,000,000 | 2018 | 2092 | 75 | 2,093,333 | 1,007 | 1,693 |
| Nonradiological workers | | | | | | | |
| On site | 107,000,000 | 2018 | 2092 | 75 | 1,426,667 | 686 | |
| Off site | 15,800 | 2018 | 2092 | 75 | 211 | 1 | |
| Waste Treatment Plant—Cesium and Strontium Capsules (OPS-WTPCSC) | | | | | | | |
| Radiological workers | 2,093,333 | 2093 | 2093 | 1 | 2,093,333 | 1,007 | 1,693 |
| Nonradiological workers | | | | | | | |
| On site | 1,426,667 | 2093 | 2093 | 1 | 1,426,667 | 686 | |
| Off site | 211 | 2093 | 2093 | 1 | 211 | 1 | |
| Cesium and Strontium Capsule Processing Facility (OPS_CSC) | | | | | | | |
| Radiological workers | 103,334 | 2092 | 2093 | 2 | 51,667 | 25 | 25 |
| Nonradiological workers | | | | | | | |
| On site | N/A | | | | | | |
| Off site | N/A | | | | | | |

Draft Tank Closure and Waste Management Environmental Impact Statement for the
Hanford Site, Richland, Washington

Table I-6. Tank Closure Alternative 2A Operations Rollup Workforce Estimate (continued)

| Activity | Total Hours | Duration | | | Hours per Year | Full-Time Equivalents per Year | Onsite Full-Time Equivalents |
|---|--------------------|----------|--------|-------|-------------------|--------------------------------|------------------------------|
| | | Start | Finish | Years | | | |
| Modified Sluicing Retrieval System (OPS_MS) | | | | | | | |
| Radiological workers | 7,379,961 | 2013 | 2092 | 80 | 92,250 | 45 | 74 |
| Nonradiological workers | | | | | | | |
| On site | 4,825,245 | 2013 | 2092 | 80 | 60,316 | 29 | |
| Off site | N/A | | | | | | |
| Mobile Retrieval System (OPS_MRS) | | | | | | | |
| Radiological workers | 5,169,360 | 2013 | 2052 | 40 | 129,234 | 63 | 120 |
| Nonradiological workers | | | | | | | |
| On site | 4,678,860 | 2013 | 2052 | 40 | 116,972 | 57 | |
| Off site | N/A | | | | | | |
| Vacuum-Based Retrieval System (OPS_VBR) | | | | | | | |
| Radiological workers | 6,634,012 | 2053 | 2092 | 40 | 165,850 | 80 | 153 |
| Nonradiological workers | | | | | | | |
| On site | 6,004,537 | 2053 | 2092 | 40 | 150,113 | 73 | |
| Off site | N/A | | | | | | |
| High-Level Radioactive Waste Melter Interim Storage Facilities (OPS_PAD) | | | | | | | |
| Radiological workers | N/A | 2018 | 2192 | | | | |
| Nonradiological workers | | | | | | | |
| On site | N/A | | | | | | |
| Off site | N/A | | | | | | |
| Effluent Treatment Facility Replacement (OPS ETF) | | | | | | | |
| Radiological workers | 13,910,400 | 2006 | 2095 | 90 | 154,560 | 75 | 94 |
| Nonradiological workers | | | | | | | |
| On site | 3,477,600 | 2006 | 2095 | 90 | 38,640 | 19 | |
| Off site | N/A | | | | | | |
| 242-A Evaporator Replacement (OPS_EVA) | | | | | | | |
| Radiological workers | 4,302,813 | 2006 | 2093 | 88 | 48,896 | 24 | 32 |
| Nonradiological workers | | | | | | | |
| On site | 1,315,908 | 2006 | 2093 | 88 | 14,954 | 8 | |
| Off site | N/A | | | | | | |
| Borrow Area C (OPS_CAREA) | | | | | | | |
| Radiological workers | N/A | | | | | | 43 |
| Nonradiological workers | | | | | | | |
| On site | 8,671,800 | 2006 | 2102 | 97 | 89,400 | 43 | |
| Off site | N/A | | | | | | |
| Total | 502,232,300 | | | | 10,281,910 | 4,884 | 4,775 |

Notes and Assumptions:

Total number of offsite full-time equivalents = 109.

Hours worked per year = 2,080.

One full-time equivalent was assumed for activities estimated to require less than 2,080 hours per year.

Key: N/A=not applicable.

Source: Compiled from SAIC 2007a, 2008.

Table I-7. Tank Closure Alternative 2A Deactivation Rollup Workforce Estimate

| Activity | Total Hours | Duration | | | Hours per Year | Full-Time Equivalents per Year | Onsite Full-Time Equivalents |
|--|-------------|----------|--------|-------|----------------|--------------------------------|------------------------------|
| | | Start | Finish | Years | | | |
| Immobilized High-Level Radioactive Waste Interim Storage Facilities (DEA_ISF) | | | | | | | |
| Radiological workers | N/A | | | | | | |
| Nonradiological workers | | | | | | | 1 |
| On site | 160 | 2093 | 2093 | 1 | 160 | 1 | |
| Off site | N/A | | | | | | |
| Administrative Controls (DEA_ADM) | | | | | | | |
| Radiological workers | 3,000,000 | 2094 | 2193 | 100 | 30,000 | 15 | |
| Nonradiological workers | | | | | | | 15 |
| On site | N/A | | | | | | |
| Off site | N/A | | | | | | |
| Waste Treatment Plant (DEA_WTP) | | | | | | | |
| Radiological workers | 4,193,166 | 2078 | 2079 | 2 | 2,096,583 | 1,008 | |
| Nonradiological workers | | | | | | | 1,700 |
| On site | 2,875,889 | 2078 | 2079 | 2 | 1,437,944 | 692 | |
| Off site | N/A | 2078 | 2079 | 2 | | | |
| Waste Treatment Plant Upgrades (DEA-WTPU) | | | | | | | |
| Radiological workers | 4,193,167 | 2094 | 2095 | 2 | 2,096,583 | 1,008 | |
| Nonradiological workers | | | | | | | 1,700 |
| On site | 2,875,889 | 2094 | 2095 | 2 | 1,437,944 | 692 | |
| Off site | N/A | 2094 | 2095 | 2 | N/A | | |
| Cesium and Strontium Capsule Processing Facility (DEA_CSC) | | | | | | | |
| Radiological workers | 23,920 | 2094 | 2094 | 1 | 23,920 | 12 | |
| Nonradiological workers | | | | | | | 12 |
| On site | N/A | | | | | | |
| Off site | N/A | | | | | | |
| Effluent Treatment Facility (Original) (DEA_ETFO) | | | | | | | |
| Radiological workers | 77,280 | 2026 | 2026 | 1 | 77,280 | 38 | |
| Nonradiological workers | | | | | | | 48 |
| On site | 19,320 | 2026 | 2026 | 1 | 19,320 | 10 | |
| Off site | N/A | | | | | | |
| Effluent Treatment Facility Replacement (DEA ETF) | | | | | | | |
| Radiological workers | 77,280 | 2056 | 2056 | 1 | 77,280 | 38 | |
| Nonradiological workers | | | | | | | 48 |
| On site | 19,320 | 2056 | 2056 | 1 | 19,320 | 10 | |
| Off site | N/A | | | | | | |
| Effluent Treatment Facility Replacement (DEA ETFU) | | | | | | | |
| Radiological workers | 77,280 | 2096 | 2096 | 1 | 77,280 | 38 | |
| Nonradiological workers | | | | | | | 48 |
| On site | 19,320 | 2096 | 2096 | 1 | 19,320 | 10 | |
| Off site | N/A | | | | | | |

Draft Tank Closure and Waste Management Environmental Impact Statement for the
Hanford Site, Richland, Washington

Table I-7. Tank Closure Alternative 2A Deactivation Rollup Workforce Estimate (continued)

| Activity | Total Hours | Duration | | | Hours per Year | Full-Time Equivalents per Year | Onsite Full-Time Equivalents |
|--|-------------------|----------|--------|-------|------------------|--------------------------------|------------------------------|
| | | Start | Finish | Years | | | |
| 242-A Evaporator (Original) (DEA_EVAO) | | | | | | | |
| Radiological workers | 24,448 | 2018 | 2018 | 1 | 24,448 | 12 | 16 |
| Nonradiological workers | | | | | | | |
| On site | 7,477 | 2018 | 2018 | 1 | 7,477 | 4 | |
| Off site | N/A | | | | | | |
| Modified Sluicing Retrieval System (DEA_MS) | | | | | | | |
| Radiological workers | 371,778 | 2013 | 2092 | 80 | 4,647 | 3 | 3 |
| Nonradiological workers | | | | | | | |
| On site | N/A | | | | | | |
| Off site | N/A | | | | | | |
| Mobile Retrieval System (DEA_MRS) | | | | | | | |
| Radiological workers | 679,620 | 2013 | 2052 | 40 | 16,991 | 9 | 9 |
| Nonradiological workers | | | | | | | |
| On site | N/A | | | | | | |
| Off site | N/A | | | | | | |
| Vacuum-Based Retrieval System (DEA_VBR) | | | | | | | |
| Radiological workers | 223,300 | 2053 | 2092 | 40 | 5,583 | 3 | 3 |
| Nonradiological workers | | | | | | | |
| On site | N/A | | | | | | |
| Off site | N/A | | | | | | |
| 242-A Evaporator Replacement (DEA_EVAU)^a | | | | | | | |
| Radiological workers | 73,343 | 2043 | 2094 | 3 | 24,448 | 12 | 16 |
| Nonradiological workers | | | | | | | |
| On site | 22,430 | 2043 | 2094 | 3 | 7,477 | 4 | |
| Total | 18,854,387 | | | | 7,504,005 | 3,619 | 3,619 |

^a DEA_EVAU activities are conducted in three 1-year periods.

Period 1, 2043–2043

Period 2, 2068–2068

Period 3, 2094–2094

Notes and Assumptions:

Total number of offsite full-time equivalents = 0.

Hours worked per year = 2,080.

One full-time equivalent was assumed for activities estimated to require less than 2,080 hours per year.

Key: N/A=not applicable.

Source: Compiled from SAIC 2007a, 2008.

Table I-8. Tank Closure Alternative 2A Closure Rollup Workforce Estimate

| Activity | Total Hours | Duration | | | Hours per Year | Full-Time Equivalents per Year | Onsite Full-Time Equivalents |
|---|----------------|----------|--------|-------|----------------|--------------------------------|------------------------------|
| | | Start | Finish | Years | | | |
| Decontamination and Decommissioning of 10 Selected Facilities (CLO_D&DTEN) | | | | | | | |
| Radiological workers | 44,418 | 2018 | 2028 | 11 | 4,038 | 2 | 9 |
| Nonradiological workers | | | | | | | |
| On site | 146,679 | 2018 | 2028 | 11 | 13,334 | 7 | |
| Off site | 78,970 | 2018 | 2028 | 11 | 7,179 | 4 | |
| Total | 270,067 | | | | 24,552 | 13 | 9 |

Notes and Assumptions:

Total number of offsite full-time equivalents = 4.

Hours worked per year = 2,080.

One full-time equivalent was assumed for activities estimated to require less than 2,080 hours per year.

Source: Compiled from SAIC 2007a, 2008.

I.2.3 Tank Closure Alternative 2B: Expanded WTP Vitrification; Landfill Closure

Table I-9. Tank Closure Alternative 2B Construction Rollup Workforce Estimate

| Activity | Total Hours | Duration | | | Hours per Year | Full-Time Equivalents per Year | Onsite Full-Time Equivalents |
|--|-------------|----------|--------|-------|----------------|--------------------------------|------------------------------|
| | | Start | Finish | Years | | | |
| Canister Storage Building (CON_CSB) | | | | | | | |
| Radiological workers | 115,500 | 2006 | 2016 | 11 | 10,500 | 6 | 12 |
| Nonradiological workers | | | | | | | |
| On site | 135,929 | 2006 | 2016 | 11 | 12,357 | 6 | |
| Off site | 50,286 | 2006 | 2016 | 11 | 4,571 | 3 | |
| Immobilized High-Level Radioactive Waste Shipping/Transfer Facility (CON_STF) | | | | | | | |
| Radiological workers | N/A | | | | | | 380 |
| Nonradiological workers | | | | | | | |
| Onsite construction | 1,757,000 | 2011 | 2013 | 3 | 585,667 | 282 | |
| Onsite exempt | 610,000 | 2011 | 2013 | 3 | 203,333 | 98 | |
| Offsite design | 748,000 | 2011 | 2013 | 3 | 249,333 | 120 | |
| Immobilized High-Level Radioactive Waste Interim Storage Modules (CON_ISM) | | | | | | | |
| Radiological workers | N/A | | | | | | 232 |
| Nonradiological workers | | | | | | | |
| Onsite construction | 2,671,659 | 2014 | 2022 | 9 | 296,851 | 143 | |
| Onsite exempt | 1,650,000 | 2014 | 2022 | 9 | 183,333 | 89 | |
| Offsite design | 2,025,000 | 2014 | 2022 | 9 | 225,000 | 109 | |
| Other Infrastructure Upgrades (CON_OIU) | | | | | | | |
| Radiological workers | 782,094 | 2006 | 2034 | 29 | 26,969 | 13 | 45 |
| Nonradiological workers | | | | | | | |
| On site | 1,918,531 | 2006 | 2034 | 29 | 66,156 | 32 | |
| Off site | 743,125 | 2006 | 2034 | 29 | 25,625 | 13 | |
| Tank Upgrades (CON_TU) | | | | | | | |
| Radiological workers | 1,195,652 | 2006 | 2025 | 20 | 59,783 | 29 | 104 |
| Nonradiological workers | | | | | | | |
| On site | 3,112,174 | 2006 | 2025 | 20 | 155,609 | 75 | |
| Off site | 1,179,130 | 2006 | 2025 | 20 | 58,957 | 29 | |
| Underground Transfer Lines (CON_UTL) | | | | | | | |
| Radiological workers | N/A | | | | | | 61 |
| Nonradiological workers | | | | | | | |
| On site | 126,005 | 2009 | 2009 | 1 | 126,005 | 61 | |
| Off site | 17,400 | 2009 | 2009 | 1 | 17,400 | 9 | |
| Waste Treatment Plant (CON_WTP) | | | | | | | |
| Radiological workers | N/A | | | | | | 1,189 |
| Nonradiological workers | | | | | | | |
| On site | 29,672,500 | 2006 | 2017 | 12 | 2,472,708 | 1,189 | |
| Off site | 9,927,500 | 2006 | 2017 | 12 | 827,292 | 398 | |
| Additional Low-Activity Waste Melters (CON_LAW) | | | | | | | |
| Radiological workers | N/A | | | | | | 340 |
| Nonradiological workers | | | | | | | |
| On site | 7,064,246 | 2008 | 2017 | 10 | 706,425 | 340 | |
| Off site | 2,386,570 | 2008 | 2017 | 10 | 238,657 | 115 | |

Draft Tank Closure and Waste Management Environmental Impact Statement for the
Hanford Site, Richland, Washington

Table I-9. Tank Closure Alternative 2B Construction Rollup Workforce Estimate (continued)

| Activity | Total Hours | Duration | | | Hours per Year | Full-Time Equivalents per Year | Onsite Full-Time Equivalents |
|---|-------------|----------|--------|-------|----------------|--------------------------------|------------------------------|
| | | Start | Finish | Years | | | |
| Cesium and Strontium Capsule Processing Facility (CON_CSC) | | | | | | | |
| Radiological workers | N/A | | | | | | |
| Nonradiological workers | | | | | | | 190 |
| On site | 1,578,028 | 2035 | 2038 | 4 | 394,507 | 190 | |
| Off site | 465,683 | 2035 | 2038 | 4 | 116,421 | 56 | |
| Waste Receiver Facilities (CON_WRF) | | | | | | | |
| Radiological workers | N/A | | | | | | |
| Nonradiological workers | | | | | | | 454 |
| On site | 4,716,000 | 2013 | 2017 | 5 | 943,200 | 454 | |
| Off site | 1,696,000 | 2013 | 2017 | 5 | 339,200 | 164 | |
| Tank Risers (CON_RIS) | | | | | | | |
| Radiological workers | 172,920 | 2013 | 2016 | 4 | 43,230 | 21 | |
| Nonradiological workers | | | | | | | 50 |
| On site | 233,180 | 2013 | 2016 | 4 | 58,295 | 29 | |
| Off site | N/A | | | | | | |
| Modified Sluicing Retrieval System (CON_MS) | | | | | | | |
| Radiological workers | 3,847,797 | 2013 | 2043 | 31 | 124,122 | 60 | |
| Nonradiological workers | | | | | | | 155 |
| On site | 6,076,615 | 2013 | 2043 | 31 | 196,020 | 95 | |
| Off site | 2,137,968 | 2013 | 2043 | 31 | 68,967 | 34 | |
| Mobile Retrieval System (CON_MRS) | | | | | | | |
| Radiological workers | 8,098,800 | 2013 | 2028 | 16 | 506,175 | 244 | |
| Nonradiological workers | | | | | | | 513 |
| On site | 8,940,660 | 2013 | 2028 | 16 | 558,791 | 269 | |
| Off site | 4,794,060 | 2013 | 2028 | 16 | 299,629 | 145 | |
| Vacuum-Based Retrieval System (CON_VBR) | | | | | | | |
| Radiological workers | 11,196,200 | 2029 | 2043 | 15 | 746,413 | 359 | |
| Nonradiological workers | | | | | | | 743 |
| On site | 11,957,150 | 2029 | 2043 | 15 | 797,143 | 384 | |
| Off site | 6,817,400 | 2029 | 2043 | 15 | 454,493 | 219 | |
| High-Level Radioactive Waste Melter Interim Storage Facilities (CON_PAD)^a | | | | | | | |
| Radiological workers | N/A | | | | | | |
| Nonradiological workers | | | | | | | 2 |
| On site | 5,616 | 2015 | 2030 | 2 | 2,808 | 2 | |
| Off site | N/A | | | | | | |
| Effluent Treatment Facility Replacement (CON ETF) | | | | | | | |
| Radiological workers | N/A | | | | | | |
| Nonradiological workers | | | | | | | 329 |
| On site | 2,047,400 | 2023 | 2025 | 3 | 682,467 | 329 | |
| Off site | 703,895 | 2023 | 2025 | 3 | 234,632 | 113 | |

Table I-9. Tank Closure Alternative 2B Construction Rollup Workforce Estimate (continued)

| Activity | Total Hours | Duration | | | Hours per Year | Full-Time Equivalents per Year | Onsite Full-Time Equivalents |
|---|--------------------|----------|--------|-------|-------------------|--------------------------------|------------------------------|
| | | Start | Finish | Years | | | |
| 242-A Evaporator Replacement (CON_EVA) | | | | | | | |
| Radiological workers | N/A | | | | | | |
| Nonradiological workers | | | | | | | 102 |
| On site | 635,400 | 2015 | 2017 | 3 | 211,800 | 102 | |
| Off site | 217,918 | 2015 | 2017 | 3 | 72,639 | 35 | |
| Total | 144,226,989 | | | | 13,402,079 | 6,462 | 4,900 |

^a CON_PAD activities are conducted in two 2-year periods.
 Period 1, 2015–2016
 Period 2, 2029–2030

Notes and Assumptions:

Total number of offsite full-time equivalents = 1,562.

Hours worked per year = 2,080.

One full-time equivalent was assumed for activities estimated to require less than 2,080 hours per year.

Key: N/A=not applicable.

Source: Compiled from SAIC 2007a, 2008.

Table I-10. Tank Closure Alternative 2B Operations Rollup Workforce Estimate

| Activity | Total Hours | Duration | | | Hours per Year | Full-Time Equivalents per Year | Onsite Full-Time Equivalents |
|--|-------------|----------|--------|-------|----------------|--------------------------------|------------------------------|
| | | Start | Finish | Years | | | |
| Immobilized High-Level Radioactive Waste Interim Storage Facilities (OPS_ISF) | | | | | | | |
| Radiological workers | 7,779,436 | 2018 | 2066 | 49 | 158,764 | 77 | |
| Nonradiological workers | | | | | | | 120 |
| On site | 4,351,200 | 2018 | 2066 | 49 | 88,800 | 43 | |
| Off site | N/A | | | | | | |
| Other Infrastructure Upgrades (OPS_OIU) | | | | | | | |
| Radiological workers | 44,909 | 2006 | 2043 | 38 | 1,182 | 1 | |
| Nonradiological workers | | | | | | | 4 |
| On site | 164,667 | 2006 | 2043 | 38 | 4,333 | 3 | |
| Off site | 117,455 | 2006 | 2043 | 38 | 3,091 | 2 | |
| Routine Operations (OPS_ROUT) | | | | | | | |
| Radiological workers | 9,880,000 | 2006 | 2043 | 38 | 260,000 | 125 | |
| Nonradiological workers | | | | | | | 651 |
| On site | 41,534,000 | 2006 | 2043 | 38 | 1,093,000 | 526 | |
| Off site | 5,890,000 | 2006 | 2043 | 38 | 155,000 | 75 | |
| Retrieval Operations (OPS_RET) | | | | | | | |
| Radiological workers | 12,955 | 2006 | 2043 | 38 | 341 | 1 | |
| Nonradiological workers | | | | | | | 28 |
| On site | 2,111,591 | 2006 | 2043 | 38 | 55,568 | 27 | |
| Off site | 16,409 | 2006 | 2043 | 38 | 432 | 1 | |
| Interim Stabilization/Double-Shell Tanks (OPS_IST) | | | | | | | |
| Radiological workers | 1,394,773 | 2006 | 2043 | 38 | 36,705 | 18 | |
| Nonradiological workers | | | | | | | 44 |
| On site | 1,995,864 | 2006 | 2043 | 38 | 52,523 | 26 | |
| Off site | 2,204,000 | 2006 | 2043 | 38 | 58,000 | 28 | |

Draft Tank Closure and Waste Management Environmental Impact Statement for the
Hanford Site, Richland, Washington

Table I-10. Tank Closure Alternative 2B Operations Rollup Workforce Estimate (continued)

| Activity | Total Hours | Duration | | | Hours per Year | Full-Time Equivalents per Year | Onsite Full-Time Equivalents |
|---|-------------|----------|--------|-------|----------------|--------------------------------|------------------------------|
| | | Start | Finish | Years | | | |
| Waste Treatment Plant (OPS_WTP) | | | | | | | |
| Radiological workers | 62,753,000 | 2018 | 2043 | 26 | 2,413,577 | 1,161 | 1,939 |
| Nonradiological workers | | | | | | | |
| On site | 42,074,000 | 2018 | 2043 | 26 | 1,618,231 | 778 | |
| Off site | 8,000 | 2018 | 2043 | 26 | 308 | 1 | |
| Waste Treatment Plant—Cesium and Strontium Capsules (OPS_WTPCSC) | | | | | | | |
| Radiological workers | 2,413,577 | 2040 | 2040 | 1 | 2,413,577 | 1,161 | 1,939 |
| Nonradiological workers | | | | | | | |
| On site | 1,618,231 | 2040 | 2040 | 1 | 1,618,231 | 778 | |
| Off site | 308 | 2040 | 2040 | 1 | 308 | 1 | |
| Cesium and Strontium Capsule Processing Facility (OPS_CSC) | | | | | | | |
| Radiological workers | 103,334 | 2039 | 2040 | 2 | 51,667 | 25 | 25 |
| Nonradiological workers | | | | | | | |
| On site | N/A | | | | | | |
| Off site | N/A | | | | | | |
| Modified Sluicing Retrieval System (OPS_MS) | | | | | | | |
| Radiological workers | 5,778,109 | 2013 | 2043 | 31 | 186,391 | 90 | 149 |
| Nonradiological workers | | | | | | | |
| On site | 3,777,905 | 2013 | 2043 | 31 | 121,868 | 59 | |
| Off site | N/A | | | | | | |
| Mobile Retrieval System (OPS_MRS) | | | | | | | |
| Radiological workers | 5,169,360 | 2013 | 2028 | 16 | 323,085 | 156 | 297 |
| Nonradiological workers | | | | | | | |
| On site | 4,678,860 | 2013 | 2028 | 16 | 292,429 | 141 | |
| Off site | N/A | | | | | | |
| Vacuum-Based Retrieval System (OPS_VBR) | | | | | | | |
| Radiological workers | 7,667,884 | 2029 | 2043 | 15 | 511,192 | 246 | 469 |
| Nonradiological workers | | | | | | | |
| On site | 6,940,309 | 2029 | 2043 | 15 | 462,687 | 223 | |
| Off site | N/A | | | | | | |
| High-Level Radioactive Waste Melter Interim Storage Facilities (OPS_PAD) | | | | | | | |
| Radiological workers | N/A | 2018 | 2145 | 28 | N/A | | |
| Nonradiological workers | | | | | | | |
| On site | N/A | | | | | | |
| Off site | N/A | | | | | | |
| Effluent Treatment Facility Replacement (OPS ETF) | | | | | | | |
| Radiological workers | 6,182,400 | 2006 | 2045 | 40 | 154,560 | 75 | 94 |
| Nonradiological workers | | | | | | | |
| On site | 1,545,600 | 2006 | 2045 | 40 | 38,640 | 19 | |
| Off site | N/A | 2006 | 2045 | 40 | N/A | | |
| 242-A Evaporator Replacement (OPS_EVA) | | | | | | | |
| Radiological workers | 1,858,033 | 2006 | 2043 | 38 | 48,896 | 24 | 32 |
| Nonradiological workers | | | | | | | |
| On site | 568,233 | 2006 | 2043 | 38 | 14,954 | 8 | |
| Off site | N/A | | | | N/A | | |

Table I-10. Tank Closure Alternative 2B Operations Rollup Workforce Estimate (continued)

| Activity | Total Hours | Duration | | | Hours per Year | Full-Time Equivalents per Year | Onsite Full-Time Equivalents |
|----------------------------------|--------------------|----------|--------|-------|-------------------|--------------------------------|------------------------------|
| | | Start | Finish | Years | | | |
| Borrow Area C (OPS_CAREA) | | | | | | | |
| Radiological workers | N/A | | | | | | |
| Nonradiological workers | | | | | | | |
| On site | 4,201,800 | 2006 | 2052 | 47 | 89,400 | 43 | 43 |
| Off site | N/A | | | | | | |
| Total | 234,836,200 | | | | 12,327,737 | 5,942 | 5,834 |

Notes and Assumptions:

Total number of offsite full-time equivalents = 108.

Hours worked per year = 2,080.

One full-time equivalent was assumed for activities estimated to require less than 2,080 hours per year.

Key: N/A=not applicable.

Source: Compiled from SAIC 2007a, 2008.

Table I-11. Tank Closure Alternative 2B Deactivation Rollup Workforce Estimate

| Activity | Total Hours | Duration | | | Hours per Year | Full-Time Equivalents per Year | Onsite Full-Time Equivalents |
|--|-------------|----------|--------|-------|----------------|--------------------------------|------------------------------|
| | | Start | Finish | Years | | | |
| Immobilized High-Level Radioactive Waste Interim Storage Facilities (DEA_ISF) | | | | | | | |
| Radiological workers | N/A | | | | | | |
| Nonradiological workers | | | | | | | |
| On site | 160 | 2067 | 2067 | 1 | 160 | 1 | 1 |
| Off site | N/A | | | | | | |
| Waste Treatment Plant (DEA_WTP) | | | | | | | |
| Radiological workers | 3,800,000 | 2044 | 2045 | 2 | 1,900,000 | 914 | |
| Nonradiological workers | | | | | | | 1,527 |
| On site | 2,550,000 | 2044 | 2045 | 2 | 1,275,000 | 613 | |
| Off site | 500 | 2044 | 2045 | 2 | 250 | 1 | |
| Modified Sluicing Retrieval System (DEA_MS) | | | | | | | |
| Radiological workers | 291,082 | 2013 | 2043 | 31 | 9,390 | 5 | |
| Nonradiological workers | | | | | | | 5 |
| On site | N/A | | | | | | |
| Off site | N/A | | | | | | |
| Mobile Retrieval System (DEA_MRS) | | | | | | | |
| Radiological workers | 679,620 | 2013 | 2028 | 16 | 42,476 | 21 | |
| Nonradiological workers | | | | | | | 21 |
| On site | N/A | | | | | | |
| Off site | N/A | | | | | | |
| Vacuum-Based Retrieval System (DEA_VBR) | | | | | | | |
| Radiological workers | 258,100 | 2029 | 2043 | 15 | 17,207 | 9 | |
| Nonradiological workers | | | | | | | 9 |
| On site | N/A | | | | | | |
| Off site | N/A | | | | | | |
| Cesium and Strontium Capsule Processing Facility (DEA_CSC) | | | | | | | |
| Radiological workers | 23,920 | 2041 | 2041 | 1 | 23,920 | 12 | |
| Nonradiological workers | | | | | | | 12 |
| On site | N/A | | | | | | |
| Off site | N/A | | | | | | |

Draft Tank Closure and Waste Management Environmental Impact Statement for the
Hanford Site, Richland, Washington

Table I–11. Tank Closure Alternative 2B Deactivation Rollup Workforce Estimate (continued)

| Activity | Total Hours | Duration | | | Hours per Year | Full-Time Equivalents per Year | Onsite Full-Time Equivalents |
|--|------------------|----------|--------|-------|------------------|--------------------------------|------------------------------|
| | | Start | Finish | Years | | | |
| Effluent Treatment Facility (Original) (DEA_ETFO) | | | | | | | |
| Radiological workers | 77,280 | 2026 | 2026 | 1 | 77,280 | 38 | 48 |
| Nonradiological workers | | | | | | | |
| On site | 19,320 | 2026 | 2026 | 1 | 19,320 | 10 | |
| Off site | N/A | | | | | | |
| Effluent Treatment Facility Replacement (DEA ETF) | | | | | | | |
| Radiological workers | 77,280 | 2046 | 2046 | 1 | 77,280 | 38 | 48 |
| Nonradiological workers | | | | | | | |
| On site | 19,320 | 2046 | 2046 | 1 | 19,320 | 10 | |
| Off site (original) | N/A | | | | | | |
| 242-A Evaporator (Original) (DEA_EVAO) | | | | | | | |
| Radiological workers | 24,448 | 2018 | 2018 | 1 | 24,448 | 12 | 16 |
| Nonradiological workers | | | | | | | |
| On site | 7,477 | 2018 | 2018 | 1 | 7,477 | 4 | |
| Off site | N/A | | | | | | |
| 242-A Evaporator Replacement (DEA EVA) | | | | | | | |
| Radiological workers | 24,448 | 2044 | 2044 | 1 | 24,448 | 12 | 16 |
| Nonradiological workers | | | | | | | |
| On site | 7,477 | 2044 | 2044 | 1 | 7,477 | 4 | |
| Off site | N/A | | | | | | |
| Total | 7,860,431 | | | | 3,525,452 | 1,704 | 1,703 |

Notes and Assumptions:

Total number of offsite full-time equivalents = 1.

Hours worked per year = 2,080.

One full-time equivalent was assumed for activities estimated to require less than 2,080 hours per year.

Key: N/A=not applicable.

Source: Compiled from SAIC 2007a, 2008.

Table I–12. Tank Closure Alternative 2B Closure Rollup Workforce Estimate

| Activity | Total Hours | Duration | | | Hours per Year | Full-Time Equivalents per Year | Onsite Full-Time Equivalents |
|--|-------------|----------|--------|-------|----------------|--------------------------------|------------------------------|
| | | Start | Finish | Years | | | |
| Tank-Filling Grout Facility Construction (CLO_CONGRO) | | | | | | | |
| Radiological workers | 480 | 2032 | 2033 | 2 | 240 | 1 | 5 |
| Nonradiological workers | | | | | | | |
| On site | 13,360 | 2032 | 2033 | 2 | 6,680 | 4 | |
| Off site | 4,160 | 2032 | 2033 | 2 | 2,080 | 1 | |
| Tank-Filling Grout Facility Operations (CLO_OPSGRO) | | | | | | | |
| Radiological workers | 68,000 | 2034 | 2043 | 10 | 6,800 | 4 | 13 |
| Nonradiological workers | | | | | | | |
| On site | 185,280 | 2034 | 2043 | 10 | 18,528 | 9 | |
| Off site | 130,000 | 2034 | 2043 | 10 | 13,000 | 7 | |
| Tank-Filling Grout Facility Deactivation (CLO_DEAGRO) | | | | | | | |
| Radiological workers | 480 | 2044 | 2044 | 1 | 480 | 1 | 4 |
| Nonradiological workers | | | | | | | |
| On site | 4,320 | 2044 | 2044 | 1 | 4,320 | 3 | |
| Off site | 1,040 | 2044 | 2044 | 1 | 1,040 | 1 | |

Table I-12. Tank Closure Alternative 2B Closure Rollup Workforce Estimate (continued)

| Activity | Total Hours | Duration | | | Hours per Year | Full-Time Equivalents per Year | Onsite Full-Time Equivalents |
|---|------------------|----------|--------|-------|----------------|--------------------------------|------------------------------|
| | | Start | Finish | Years | | | |
| Ancillary Equipment Grouting (CLO_ANCFIL) | | | | | | | |
| Radiological workers | 337,943 | 2013 | 2037 | 25 | 13,518 | 7 | 7 |
| Nonradiological workers | | | | | | | |
| On site | N/A | | | | | | |
| Off site | N/A | | | | | | |
| Ancillary Equipment Removal (CLO_ANCREM) | | | | | | | |
| Radiological workers | 166,452 | 2032 | 2037 | 6 | 27,742 | 14 | 14 |
| Nonradiological workers | | | | | | | |
| On site | N/A | | | | | | |
| Off site | N/A | | | | | | |
| BX and SX Tank Farm Soil Removal (CLO_SOIL) | | | | | | | |
| Radiological workers | 33,000 | 2032 | 2037 | 6 | 5,500 | 3 | 6 |
| Nonradiological workers | | | | | | | |
| On site | 30,000 | 2032 | 2037 | 6 | 5,000 | 3 | |
| Off site | N/A | | | | | | |
| Containment Structure Construction (CLO_CONCS) | | | | | | | |
| Radiological workers | 2,000 | 2028 | 2031 | 4 | 500 | 1 | 4 |
| Nonradiological workers | | | | | | | |
| On site | 20,000 | 2028 | 2031 | 4 | 5,000 | 3 | |
| Off site | N/A | | | | | | |
| Containment Structure Deactivation (CLO_DEACS) | | | | | | | |
| Radiological workers | 2,000 | 2038 | 2040 | 3 | 667 | 1 | 5 |
| Nonradiological workers | | | | | | | |
| On site | 20,000 | 2038 | 2040 | 3 | 6,667 | 4 | |
| Off site | N/A | | | | | | |
| Modified Resource Conservation and Recovery Act Subtitle C Barrier Construction (CLO_RCRA) | | | | | | | |
| Radiological workers | 1,430,000 | 2039 | 2045 | 7 | 204,286 | 99 | 394 |
| Nonradiological workers | | | | | | | |
| On site | 4,290,000 | 2039 | 2045 | 7 | 612,857 | 295 | |
| Off site | N/A | | | | | | |
| Decontamination and Decommissioning of 10 Selected Facilities (CLO_D&DTEN) | | | | | | | |
| Radiological workers | 44,418 | 2018 | 2028 | 11 | 4,038 | 2 | 9 |
| Nonradiological workers | | | | | | | |
| On site | 146,679 | 2018 | 2028 | 11 | 13,334 | 7 | |
| Off site | 78,970 | 2018 | 2028 | 11 | 7,179 | 4 | |
| Postclosure Care (CLO_POST) | | | | | | | |
| Radiological workers | N/A | | | | | | 3 |
| Nonradiological workers | | | | | | | |
| On site | 471,262 | 2046 | 2145 | 100 | 4,713 | 3 | |
| Off site | N/A | | | | | | |
| Total | 7,479,844 | | | | 964,168 | 477 | 464 |

Notes and Assumptions:

Total number of offsite full-time equivalents = 13.

Hours worked per year = 2,080.

One full-time equivalent was assumed for activities estimated to require less than 2,080 hours per year.

Key: N/A=not applicable.

Source: Compiled from SAIC 2007a, 2008.

I.2.4 Tank Closure Alternative 3A: Existing WTP Vitrification with Thermal Supplemental Treatment (Bulk Vitrification); Landfill Closure

Table I-13. Tank Closure Alternative 3A Construction Rollup Workforce Estimate

| Activity | Total Hours | Duration | | | Hours per Year | Full-Time Equivalents per Year | Onsite Full-Time Equivalents |
|--|-------------|----------|--------|-------|----------------|--------------------------------|------------------------------|
| | | Start | Finish | Years | | | |
| Canister Storage Building (CON_CSB) | | | | | | | |
| Radiological workers | 115,500 | 2006 | 2016 | 11 | 10,500 | 6 | 12 |
| Nonradiological workers | | | | | | | |
| On site | 135,929 | 2006 | 2016 | 11 | 12,357 | 6 | |
| Off site | 50,286 | 2006 | 2016 | 11 | 4,571 | 3 | |
| Immobilized High-Level Radioactive Waste Shipping/Transfer Facility (CON_STF) | | | | | | | |
| Radiological workers | N/A | | | | | | 380 |
| Nonradiological workers | | | | | | | |
| Onsite construction | 1,757,000 | 2011 | 2013 | 3 | 585,667 | 282 | |
| Onsite exempt | 610,000 | 2011 | 2013 | 3 | 203,333 | 98 | |
| Offsite design | 748,000 | 2011 | 2013 | 3 | 249,333 | 120 | |
| Immobilized High-Level Radioactive Waste Interim Storage Modules (CON_ISM) | | | | | | | |
| Radiological workers | N/A | | | | | | 232 |
| Nonradiological workers | | | | | | | |
| Onsite construction | 2,671,659 | 2014 | 2022 | 9 | 296,851 | 143 | |
| Onsite exempt | 1,650,000 | 2014 | 2022 | 9 | 183,333 | 89 | |
| Offsite design | 2,025,000 | 2014 | 2022 | 9 | 225,000 | 109 | |
| Other Infrastructure Upgrades (CON_OIU) | | | | | | | |
| Radiological workers | 782,094 | 2006 | 2034 | 29 | 26,969 | 13 | 45 |
| Nonradiological workers | | | | | | | |
| On site | 1,918,531 | 2006 | 2034 | 29 | 66,156 | 32 | |
| Off site | 743,125 | 2006 | 2034 | 29 | 25,625 | 13 | |
| Tank Upgrades (CON_TU) | | | | | | | |
| Radiological workers | 1,195,652 | 2006 | 2025 | 20 | 59,783 | 29 | 104 |
| Nonradiological workers | | | | | | | |
| On site | 3,112,174 | 2006 | 2025 | 20 | 155,609 | 75 | |
| Off site | 1,179,130 | 2006 | 2025 | 20 | 58,957 | 29 | |
| Underground Transfer Lines (CON_UTL) | | | | | | | |
| Radiological workers | N/A | | | | | | 61 |
| Nonradiological workers | | | | | | | |
| On site | 126,005 | 2009 | 2009 | 1 | 126,005 | 61 | |
| Off site | 17,400 | 2009 | 2009 | 1 | 17,400 | 9 | |
| Waste Treatment Plant (CON_WTP) | | | | | | | |
| Radiological workers | N/A | | | | | | 906 |
| Nonradiological workers | | | | | | | |
| On site | 22,612,500 | 2006 | 2017 | 12 | 1,884,375 | 906 | |
| Off site | 7,537,500 | 2006 | 2017 | 12 | 628,125 | 302 | |
| Cesium and Strontium Capsule Processing Facility (CON_CSC) | | | | | | | |
| Radiological workers | N/A | | | | | | 190 |
| Nonradiological workers | | | | | | | |
| On site | 1,578,029 | 2035 | 2038 | 4 | 394,507 | 190 | |
| Off site | 465,683 | 2035 | 2038 | 4 | 116,421 | 56 | |

Table I-13. Tank Closure Alternative 3A Construction Rollup Workforce Estimate (continued)

| Activity | Total Hours | Duration | | | Hours per Year | Full-Time Equivalents per Year | Onsite Full-Time Equivalents |
|---|-------------|----------|--------|-------|----------------|--------------------------------|------------------------------|
| | | Start | Finish | Years | | | |
| Waste Receiver Facilities (CON_WRF) | | | | | | | |
| Radiological workers | N/A | 2013 | 2017 | 5 | N/A | | 454 |
| Nonradiological workers | | | | | | | |
| On site | 4,716,000 | 2013 | 2017 | 5 | 943,200 | 454 | |
| Off site | 1,696,000 | 2013 | 2017 | 5 | 339,200 | 164 | |
| Tank Risers (CON_RIS) | | | | | | | |
| Radiological workers | 172,920 | 2013 | 2016 | 4 | 43,230 | 21 | 50 |
| Nonradiological workers | | | | | | | |
| On site | 233,180 | 2013 | 2016 | 4 | 58,295 | 29 | |
| Off site | N/A | 2013 | 2016 | 4 | N/A | | |
| Modified Sluicing Retrieval System (CON_MS) | | | | | | | |
| Radiological workers | 3,847,797 | 2013 | 2039 | 27 | 142,511 | 69 | 178 |
| Nonradiological workers | | | | | | | |
| On site | 6,076,615 | 2013 | 2039 | 27 | 225,060 | 109 | |
| Off site | 2,137,968 | 2013 | 2039 | 27 | 79,184 | 39 | |
| Mobile Retrieval System (CON_MRS) | | | | | | | |
| Radiological workers | 8,098,800 | 2013 | 2026 | 14 | 578,486 | 279 | 587 |
| Nonradiological workers | | | | | | | |
| On site | 8,940,660 | 2013 | 2026 | 14 | 638,619 | 308 | |
| Off site | 4,794,060 | 2013 | 2026 | 14 | 342,433 | 165 | |
| Vacuum-Based Retrieval System (CON_VBR) | | | | | | | |
| Radiological workers | 11,196,200 | 2027 | 2039 | 13 | 861,246 | 415 | 858 |
| Nonradiological workers | | | | | | | |
| On site | 11,957,150 | 2027 | 2039 | 13 | 919,781 | 443 | |
| Off site | 6,817,400 | 2027 | 2039 | 13 | 524,415 | 253 | |
| High-Level Radioactive Waste Melter Interim Storage Facilities (CON_PAD) | | | | | | | |
| Radiological workers | N/A | 2015 | 2016 | 2 | N/A | | 1 |
| Nonradiological workers | | | | | | | |
| On site | 2,808 | 2015 | 2016 | 2 | 1,404 | 1 | |
| Off site | N/A | 2015 | 2016 | 2 | N/A | | |
| Contact-Handled Mixed Transuranic Waste Facilities (CON_CH) | | | | | | | |
| Radiological workers | N/A | 2008 | 2008 | 1 | N/A | | 60 |
| Nonradiological workers | | | | | | | |
| On site | 124,754 | 2008 | 2008 | 1 | 124,754 | 60 | |
| Off site | 42,147 | 2008 | 2008 | 1 | 42,147 | 21 | |
| Remote-Handled Mixed Transuranic Waste Facility (CON_RH) | | | | | | | |
| Radiological workers | N/A | 2013 | 2014 | 2 | N/A | | 37 |
| Nonradiological workers | | | | | | | |
| On site | 153,506 | 2013 | 2014 | 2 | 76,753 | 37 | |
| Off site | 51,860 | 2013 | 2014 | 2 | 25,930 | 13 | |
| Transuranic Waste Interim Storage Facility (CON_TRU) | | | | | | | |
| Radiological workers | N/A | | | | | | 4 |
| Nonradiological workers | | | | | | | |
| On site | 16,400 | 2008 | 2009 | 2 | 8,200 | 4 | |
| Off site | N/A | | | | | | |

Draft Tank Closure and Waste Management Environmental Impact Statement for the
Hanford Site, Richland, Washington

Table I-13. Tank Closure Alternative 3A Construction Rollup Workforce Estimate (continued)

| Activity | Total Hours | Duration | | | Hours per Year | Full-Time Equivalents per Year | Onsite Full-Time Equivalents |
|---|--------------------|----------|--------|-------|-------------------|--------------------------------|------------------------------|
| | | Start | Finish | Years | | | |
| Bulk Vitrification Facility (200-West Area) (CON_BVW) | | | | | | | |
| Radiological workers | N/A | 2016 | 2017 | 2 | N/A | | 165 |
| Nonradiological workers | | | | | | | |
| On site | 684,068 | 2016 | 2017 | 2 | 342,034 | 165 | |
| Off site | 231,104 | 2016 | 2017 | 2 | 115,552 | 56 | |
| Solid-Liquid Separations Facility (200-West Area) (CON_SEPW) | | | | | | | |
| Radiological workers | N/A | 2016 | 2017 | 2 | N/A | | 38 |
| Nonradiological workers | | | | | | | |
| On site | 156,349 | 2016 | 2017 | 2 | 78,174 | 38 | |
| Off site | 52,821 | 2016 | 2017 | 2 | 26,410 | 13 | |
| Bulk Vitrification Facility (200-East Area) (CON_BVE) | | | | | | | |
| Radiological workers | N/A | 2016 | 2017 | 2 | N/A | | 165 |
| Nonradiological workers | | | | | | | |
| On site | 684,068 | 2016 | 2017 | 2 | 342,034 | 165 | |
| Off site | 231,104 | 2016 | 2017 | 2 | 115,552 | 56 | |
| Effluent Treatment Facility Replacement (CON ETF) | | | | | | | |
| Radiological workers | N/A | 2023 | 2025 | 3 | N/A | | 329 |
| Nonradiological workers | | | | | | | |
| On site | 2,047,400 | 2023 | 2025 | 3 | 682,467 | 329 | |
| Off site | 703,895 | 2023 | 2025 | 3 | 234,632 | 113 | |
| 242-A Evaporator Replacement (CON EVA) | | | | | | | |
| Radiological workers | N/A | 2015 | 2017 | 3 | N/A | | 102 |
| Nonradiological workers | | | | | | | |
| On site | 635,400 | 2015 | 2017 | 3 | 211,800 | 102 | |
| Off site | 217,918 | 2015 | 2017 | 3 | 72,639 | 35 | |
| Total | 127,751,548 | | | | 13,527,019 | 6,492 | 4,958 |

Notes and Assumptions:

Total number of offsite full-time equivalents = 1,568.

Hours worked per year = 2,080.

One full-time equivalent was assumed for activities estimated to require less than 2,080 hours per year.

Key: N/A=not applicable.

Source: Compiled from SAIC 2007a, 2008.

Table I-14. Tank Closure Alternative 3A Operations Rollup Workforce Estimate

| Activity | Total Hours | Duration | | | Hours per Year | Full-Time Equivalents per Year | Onsite Full-Time Equivalents |
|--|-------------|----------|--------|-------|----------------|--------------------------------|------------------------------|
| | | Start | Finish | Years | | | |
| Immobilized High-Level Radioactive Waste Interim Storage Facilities (OPS_ISF) | | | | | | | |
| Radiological workers | 7,779,436 | 2018 | 2066 | 49 | 158,764 | 77 | 120 |
| Nonradiological workers | | | | | | | |
| On site | 4,351,200 | 2018 | 2066 | 49 | 88,800 | 43 | |
| Off site | N/A | | | | | | |
| Other Infrastructure Upgrades (OPS_OIU) | | | | | | | |
| Radiological workers | 40,182 | 2006 | 2039 | 34 | 1,182 | 1 | 4 |
| Nonradiological workers | | | | | | | |
| On site | 147,333 | 2006 | 2039 | 34 | 4,333 | 3 | |
| Off site | 105,091 | 2006 | 2039 | 34 | 3,091 | 2 | |

Table I-14. Tank Closure Alternative 3A Operations Rollup Workforce Estimate (continued)

| Activity | Total Hours | Duration | | | Hours per Year | Full-Time Equivalents per Year | Onsite Full-Time Equivalents |
|---|-------------|----------|--------|-------|----------------|--------------------------------|------------------------------|
| | | Start | Finish | Years | | | |
| Routine Operations (OPS_ROUT) | | | | | | | |
| Radiological workers | 8,840,000 | 2006 | 2039 | 34 | 260,000 | 125 | 651 |
| Nonradiological workers | | | | | | | |
| On site | 37,162,000 | 2006 | 2039 | 34 | 1,093,000 | 526 | |
| Off site | 5,270,000 | 2006 | 2039 | 34 | 155,000 | 75 | |
| Retrieval Operations (OPS_RET) | | | | | | | |
| Radiological workers | 11,591 | 2006 | 2039 | 34 | 341 | 1 | 28 |
| Nonradiological workers | | | | | | | |
| On site | 1,889,318 | 2006 | 2039 | 34 | 55,568 | 27 | |
| Off site | 14,682 | 2006 | 2039 | 34 | 432 | 1 | |
| Interim Stabilization/Double-Shell Tanks (OPS_IST) | | | | | | | |
| Radiological workers | 1,247,995 | 2006 | 2039 | 34 | 36,705 | 18 | 44 |
| Nonradiological workers | | | | | | | |
| On site | 1,785,773 | 2006 | 2039 | 34 | 52,523 | 26 | |
| Off site | 1,972,000 | 2006 | 2039 | 34 | 58,000 | 28 | |
| Waste Treatment Plant (OPS_WTP) | | | | | | | |
| Radiological workers | 46,100,000 | 2018 | 2039 | 22 | 2,095,455 | 1,008 | 1,697 |
| Nonradiological workers | | | | | | | |
| On site | 31,500,000 | 2018 | 2039 | 22 | 1,431,818 | 689 | |
| Off site | 4,620 | 2018 | 2039 | 22 | 210 | 1 | |
| Waste Treatment Plant—Cesium and Strontium Capsules (OPS_WTPCSC) | | | | | | | |
| Radiological workers | 2,095,455 | 2040 | 2040 | 1 | 2,095,455 | 1,008 | 1,697 |
| Nonradiological workers | | | | | | | |
| On site | 1,431,818 | 2040 | 2040 | 1 | 1,431,818 | 689 | |
| Off site | 210 | 2040 | 2040 | 1 | 210 | 1 | |
| Cesium and Strontium Capsule Processing Facility (OPS_CSC) | | | | | | | |
| Radiological workers | 103,334 | 2039 | 2040 | 2 | 51,667 | 25 | 25 |
| Nonradiological workers | | | | | | | |
| On site | N/A | 2039 | 2040 | 2 | N/A | | |
| Off site | N/A | | | | | | |
| Modified Sluicing Retrieval System (OPS_MS) | | | | | | | |
| Radiological workers | 5,778,109 | 2013 | 2039 | 27 | 214,004 | 103 | 171 |
| Nonradiological workers | | | | | | | |
| On site | 3,777,905 | 2013 | 2039 | 27 | 139,922 | 68 | |
| Off site | N/A | | | | | | |
| Mobile Retrieval System (OPS_MRS) | | | | | | | |
| Radiological workers | 5,169,360 | 2013 | 2026 | 14 | 369,240 | 178 | 339 |
| Nonradiological workers | | | | | | | |
| On site | 4,678,860 | 2013 | 2026 | 14 | 334,204 | 161 | |
| Off site | N/A | | | | | | |

Draft Tank Closure and Waste Management Environmental Impact Statement for the
Hanford Site, Richland, Washington

Table I-14. Tank Closure Alternative 3A Operations Rollup Workforce Estimate (continued)

| Activity | Total Hours | Duration | | | Hours per Year | Full-Time Equivalents per Year | Onsite Full-Time Equivalents |
|---|-------------|----------|--------|-------|----------------|--------------------------------|------------------------------|
| | | Start | Finish | Years | | | |
| Vacuum-Based Retrieval System (OPS_VBR) | | | | | | | |
| Radiological workers | 7,667,884 | 2027 | 2039 | 13 | 589,837 | 284 | 541 |
| Nonradiological workers | | | | | | | |
| On site | 6,940,309 | 2027 | 2039 | 13 | 533,870 | 257 | |
| Off site | N/A | | | | | | |
| High-Level Radioactive Waste Melter Interim Storage Facilities (OPS_PAD) | | | | | | | |
| Radiological workers | N/A | 2018 | 2141 | 124 | N/A | | |
| Nonradiological workers | | | | | | | |
| On site | N/A | | | | | | |
| Off site | N/A | | | | | | |
| Contact-Handled Mixed Transuranic Waste Facilities (OPS_CH) | | | | | | | |
| Radiological workers | 200,000 | 2009 | 2010 | 2 | 100,000 | 49 | 49 |
| Nonradiological workers | | | | | | | |
| On site | N/A | | | | | | |
| Off site | N/A | | | | | | |
| Remote-Handled Mixed Transuranic Waste Facility (OPS_RH) | | | | | | | |
| Radiological workers | 1,000,000 | 2015 | 2019 | 5 | 200,000 | 97 | 97 |
| Nonradiological workers | | | | | | | |
| On site | N/A | | | | | | |
| Off site | N/A | | | | | | |
| Transuranic Waste Interim Storage Facility (OPS_TRU) | | | | | | | |
| Radiological workers | N/A | 2009 | 2034 | 26 | | | |
| Nonradiological workers | | | | | | | |
| On site | N/A | | | | | | |
| Off site | N/A | | | | | | |
| Bulk Vitrification Facility (200-West Area) (OPS_BVW) | | | | | | | |
| Radiological workers | 3,404,000 | 2018 | 2039 | 22 | 154,727 | 75 | 94 |
| Nonradiological workers | | | | | | | |
| On site | 828,000 | 2018 | 2039 | 22 | 37,636 | 19 | |
| Off site | N/A | | | | | | |
| Solid-Liquid Separations Facility (200-West Area) (OPS_SEPW) | | | | | | | |
| Radiological workers | 2,800,000 | 2018 | 2039 | 22 | 127,273 | 62 | 81 |
| Nonradiological workers | | | | | | | |
| On site | 850,000 | 2018 | 2039 | 22 | 38,636 | 19 | |
| Off site | N/A | | | | | | |
| Bulk Vitrification Facility (200-East Area) (OPS_BVE) | | | | | | | |
| Radiological workers | 2,812,000 | 2018 | 2039 | 22 | 127,818 | 62 | 77 |
| Nonradiological workers | | | | | | | |
| On site | 684,000 | 2018 | 2039 | 22 | 31,091 | 15 | |
| Off site | N/A | | | | | | |
| Effluent Treatment Facility Replacement (OPS ETF) | | | | | | | |
| Radiological workers | 5,718,720 | 2006 | 2042 | 37 | 154,560 | 75 | 94 |
| Nonradiological workers | | | | | | | |
| On site | 1,429,680 | 2006 | 2042 | 37 | 38,640 | 19 | |
| Off site | N/A | | | | | | |

Table I-14. Tank Closure Alternative 3A Operations Rollup Workforce Estimate (continued)

| Activity | Total Hours | Duration | | | Hours per Year | Full-Time Equivalents per Year | Onsite Full-Time Equivalents |
|---|--------------------|----------|--------|-------|-------------------|--------------------------------|------------------------------|
| | | Start | Finish | Years | | | |
| 242-A Evaporator Replacement (OPS_EVA) | | | | | | | |
| Radiological workers | 1,711,346 | 2006 | 2040 | 35 | 48,896 | 24 | 32 |
| Nonradiological workers | | | | | | | |
| On site | 523,372 | 2006 | 2040 | 35 | 14,953 | 8 | |
| Off site | N/A | | | | | | |
| Borrow Area C (OPS_CAREA) | | | | | | | |
| Radiological workers | N/A | | | | | | 43 |
| Nonradiological workers | | | | | | | |
| On site | 4,201,800 | 2006 | 2052 | 47 | 89,400 | 43 | |
| Off site | N/A | | | | | | |
| Total | 212,027,342 | | | | 12,419,080 | 5,992 | 5,884 |

Notes and Assumptions:

Total number of offsite full-time equivalents = 108.

Hours worked per year = 2,080.

One full-time equivalent was assumed for activities estimated to require less than 2,080 hours per year.

For OPS_WTP, no allowance was made for full-time equivalents in ramp-up years.

For OPS_BVW and BVE, no allowance was made for full-time equivalents in ramp up.

Key: N/A=not applicable.**Source:** Compiled from SAIC 2007a, 2008.**Table I-15. Tank Closure Alternative 3A Deactivation Rollup Workforce Estimate**

| Activity | Total Hours | Duration | | | Hours per Year | Full-Time Equivalents per Year | Onsite Full-Time Equivalents |
|--|-------------|----------|--------|-------|----------------|--------------------------------|------------------------------|
| | | Start | Finish | Years | | | |
| Immobilized High-Level Radioactive Waste Interim Storage Facilities (DEA_ISF) | | | | | | | |
| Radiological workers | N/A | | | | | | 1 |
| Nonradiological workers | | | | | | | |
| On site | 160 | 2067 | 2067 | 1 | 160 | 1 | |
| Off site | N/A | | | | | | |
| Waste Treatment Plant (DEA_WTP) | | | | | | | |
| Radiological workers | 4,193,167 | 2041 | 2042 | 2 | 2,096,583 | 1,008 | 1,700 |
| Nonradiological workers | | | | | | | |
| On site | 2,875,889 | 2041 | 2042 | 2 | 1,437,944 | 692 | |
| Off site | N/A | | | | | | |
| Modified Sluicing Retrieval System (DEA_MS) | | | | | | | |
| Radiological workers | 291,082 | 2013 | 2039 | 27 | 10,781 | 6 | 6 |
| Nonradiological workers | | | | | | | |
| On site | N/A | | | | | | |
| Off site | N/A | | | | | | |
| Mobile Retrieval System (DEA_MRS) | | | | | | | |
| Radiological workers | 679,620 | 2013 | 2026 | 14 | 48,544 | 24 | 24 |
| Nonradiological workers | | | | | | | |
| On site | N/A | | | | | | |
| Off site | N/A | | | | | | |
| Vacuum-Based Retrieval System (DEA_VBR) | | | | | | | |
| Radiological workers | 258,100 | 2027 | 2039 | 13 | 19,854 | 10 | 10 |
| Nonradiological workers | | | | | | | |
| On site | N/A | | | | | | |
| Off site | N/A | | | | | | |

Draft Tank Closure and Waste Management Environmental Impact Statement for the
Hanford Site, Richland, Washington

Table I-15. Tank Closure Alternative 3A Deactivation Rollup Workforce Estimate (continued)

| Activity | Total Hours | Duration | | | Hours per Year | Full-Time Equivalents per Year | Onsite Full-Time Equivalents |
|---|-------------|----------|--------|-------|----------------|--------------------------------|------------------------------|
| | | Start | Finish | Years | | | |
| Cesium and Strontium Capsule Processing Facility (DEA_CSC) | | | | | | | |
| Radiological workers | 23,920 | 2041 | 2041 | 1 | 23,920 | 12 | 12 |
| Nonradiological workers | | | | | | | |
| On site | N/A | | | | | | |
| Off site | N/A | | | | | | |
| Contact-Handled Mixed Transuranic Waste Facilities (DEA_CH) | | | | | | | |
| Radiological workers | 100,000 | 2011 | 2012 | 2 | 50,000 | 25 | 25 |
| Nonradiological workers | | | | | | | |
| On site | N/A | | | | | | |
| Off site | N/A | | | | | | |
| Remote-Handled Mixed Transuranic Waste Facility (DEA_RH) | | | | | | | |
| Radiological workers | 200,000 | 2020 | 2021 | 2 | 100,000 | 49 | 49 |
| Nonradiological workers | | | | | | | |
| On site | N/A | | | | | | |
| Off site | N/A | | | | | | |
| Transuranic Waste Interim Storage Facility (DEA_TRU) | | | | | | | |
| Radiological workers | N/A | | | | | | 1 |
| Nonradiological workers | | | | | | | |
| On site | 80 | 2035 | 2035 | 1 | 80 | 1 | |
| Off site | N/A | | | | | | |
| Bulk Vitrification Facility (200-West Area) (DEA_BVW) | | | | | | | |
| Radiological workers | 148,000 | 2040 | 2041 | 2 | 74,000 | 36 | 45 |
| Nonradiological workers | | | | | | | |
| On site | 36,000 | 2040 | 2041 | 2 | 18,000 | 9 | |
| Off site | N/A | | | | | | |
| Solid-Liquid Separations Facility (200-West Area) (DEA_SEPW) | | | | | | | |
| Radiological workers | 122,000 | 2040 | 2041 | 2 | 61,000 | 30 | 39 |
| Nonradiological workers | | | | | | | |
| On site | 37,000 | 2040 | 2041 | 2 | 18,500 | 9 | |
| Off site | N/A | | | | | | |
| Bulk Vitrification Facility (200-East Area) (DEA_BVE) | | | | | | | |
| Radiological workers | 148,000 | 2040 | 2041 | 2 | 74,000 | 36 | 45 |
| Nonradiological workers | | | | | | | |
| On site | 36,000 | 2040 | 2041 | 2 | 18,000 | 9 | |
| Off site | N/A | | | | | | |
| Effluent Treatment Facility (Original) (DEA_ETFO) | | | | | | | |
| Radiological workers | 77,280 | 2026 | 2026 | 1 | 77,280 | 38 | 48 |
| Nonradiological workers | | | | | | | |
| On site | 19,320 | 2026 | 2026 | 1 | 19,320 | 10 | |
| Off site | N/A | | | | | | |
| Effluent Treatment Facility Replacement (DEA ETF) | | | | | | | |
| Radiological workers | 77,280 | 2043 | 2043 | 1 | 77,280 | 38 | 48 |
| Nonradiological workers | | | | | | | |
| On site | 19,320 | 2043 | 2043 | 1 | 19,320 | 10 | |
| Off site | N/A | | | | | | |

Table I-15. Tank Closure Alternative 3A Deactivation Rollup Workforce Estimate (continued)

| Activity | Total Hours | Duration | | | Hours per Year | Full-Time Equivalents per Year | Onsite Full-Time Equivalents |
|---|------------------|----------|--------|-------|------------------|--------------------------------|------------------------------|
| | | Start | Finish | Years | | | |
| 242-A Evaporator (Original) (DEA_EVAO) | | | | | | | |
| Radiological workers | 24,448 | 2018 | 2018 | 1 | 24,448 | 12 | 16 |
| Nonradiological workers | | | | | | | |
| On site | 7,477 | 2018 | 2018 | 1 | 7,477 | 4 | |
| Off site | N/A | | | | | | |
| 242-A Evaporator Replacement (DEA_EVA) | | | | | | | |
| Radiological workers | 24,448 | 2041 | 2041 | 1 | 24,448 | 12 | 16 |
| Nonradiological workers | | | | | | | |
| On site | 7,477 | 2041 | 2041 | 1 | 7,477 | 4 | |
| Off site | N/A | | | | | | |
| Total | 9,406,067 | | | | 4,308,416 | 2,085 | 2,085 |

Notes and Assumptions:

Total number of offsite full-time equivalents = 0.

Hours worked per year = 2,080.

One full-time equivalent was assumed for activities estimated to require less than 2,080 hours per year.

Key: N/A=not applicable.

Source: Compiled from SAIC 2007a, 2008.

Table I-16. Tank Closure Alternative 3A Closure Rollup Workforce Estimate

| Activity | Total Hours | Duration | | | Hours per Year | Full-Time Equivalents per Year | Onsite Full-Time Equivalents |
|--|-------------|----------|--------|-------|----------------|--------------------------------|------------------------------|
| | | Start | Finish | Years | | | |
| Tank-Filling Grout Facility Construction (CLO_CONGRO) | | | | | | | |
| Radiological workers | 480 | 2028 | 2029 | 2 | 240 | 1 | 5 |
| Nonradiological workers | | | | | | | |
| On site | 13,360 | 2028 | 2029 | 2 | 6,680 | 4 | |
| Off site | 4,160 | 2028 | 2029 | 2 | 2,080 | 1 | |
| Tank-Filling Grout Facility Operations (CLO_OPSGRO) | | | | | | | |
| Radiological workers | 68,000 | 2030 | 2039 | 10 | 6,800 | 4 | 13 |
| Nonradiological workers | | | | | | | |
| On site | 185,280 | 2030 | 2039 | 10 | 18,528 | 9 | |
| Off site | 130,000 | 2030 | 2039 | 10 | 13,000 | 7 | |
| Tank-Filling Grout Facility Deactivation (CLO_DEAGRO) | | | | | | | |
| Radiological workers | 480 | 2040 | 2040 | 1 | 480 | 1 | 4 |
| Nonradiological workers | | | | | | | |
| On site | 4,320 | 2040 | 2040 | 1 | 4,320 | 3 | |
| Off site | 1,040 | 2040 | 2040 | 1 | 1,040 | 1 | |
| Ancillary Equipment Grouting (CLO_ANCFIL) | | | | | | | |
| Radiological workers | 337,943 | 2012 | 2032 | 21 | 16,093 | 8 | 8 |
| Nonradiological workers | | | | | | | |
| On site | N/A | | | | | | |
| Off site | N/A | | | | | | |
| Ancillary Equipment Removal (CLO_ANCREM) | | | | | | | |
| Radiological workers | 166,452 | 2028 | 2033 | 6 | 27,742 | 14 | 14 |
| Nonradiological workers | | | | | | | |
| On site | N/A | | | | | | |
| Off site | N/A | | | | | | |

Draft Tank Closure and Waste Management Environmental Impact Statement for the
Hanford Site, Richland, Washington

Table I-16. Tank Closure Alternative 3A Closure Rollup Workforce Estimate (continued)

| Activity | Total Hours | Duration | | | Hours per Year | Full-Time Equivalents per Year | Onsite Full-Time Equivalents |
|---|------------------|----------|--------|-------|----------------|--------------------------------|------------------------------|
| | | Start | Finish | Years | | | |
| BX and SX Tank Farm Soil Removal (CLO_SOIL) | | | | | | | |
| Radiological workers | 33,000 | 2028 | 2033 | 6 | 5,500 | 3 | 6 |
| Nonradiological workers | | | | | | | |
| On site | 30,000 | 2028 | 2033 | 6 | 5,000 | 3 | |
| Off site | N/A | | | | | | |
| Containment Structure Construction (CLO_CONCS) | | | | | | | |
| Radiological workers | 2,000 | 2024 | 2027 | 4 | 500 | 1 | 4 |
| Nonradiological workers | | | | | | | |
| On site | 20,000 | 2024 | 2027 | 4 | 5,000 | 3 | |
| Off site | N/A | | | | | | |
| Containment Structure Deactivation (CLO_DEACS) | | | | | | | |
| Radiological workers | 2,000 | 2034 | 2036 | 3 | 667 | 1 | 5 |
| Nonradiological workers | | | | | | | |
| On site | 20,000 | 2034 | 2036 | 3 | 6,667 | 4 | |
| Off site | N/A | | | | | | |
| Modified Resource Conservation and Recovery Act Subtitle C Barrier Construction (CLO_RCRA) | | | | | | | |
| Radiological workers | 1,430,000 | 2035 | 2041 | 7 | 204,286 | 99 | 394 |
| Nonradiological workers | | | | | | | |
| On site | 4,290,000 | 2035 | 2041 | 7 | 612,857 | 295 | |
| Off site | N/A | | | | | | |
| Decontamination and Decommissioning of 10 Selected Facilities (CLO_D&DTEN) | | | | | | | |
| Radiological workers | 44,418 | 2018 | 2028 | 11 | 4,038 | 2 | 9 |
| Nonradiological workers | | | | | | | |
| On site | 146,679 | 2018 | 2028 | 11 | 13,334 | 7 | |
| Off site | 78,970 | 2018 | 2028 | 11 | 7,179 | 4 | |
| Postclosure Care (CLO_POST) | | | | | | | |
| Radiological workers | N/A | | | | | | 3 |
| Nonradiological workers | | | | | | | |
| On site | 471,262 | 2042 | 2141 | 100 | 4,713 | 3 | |
| Off site | N/A | | | | | | |
| Total | 7,479,844 | | | | 966,743 | 478 | 465 |

Notes and Assumptions:

Total number of offsite full-time equivalents = 13.

Hours worked per year = 2,080.

One full-time equivalent was assumed for activities estimated to require less than 2,080 hours per year.

Key: N/A=not applicable.

Source: Compiled from SAIC 2007a, 2008.

I.2.5 Tank Closure Alternative 3B: Existing WTP Vitrification with Nonthermal Supplemental Treatment (Cast Stone); Landfill Closure

Table I-17. Tank Closure Alternative 3B Construction Rollup Workforce Estimate

| Activity | Total Hours | Duration | | | Hours per Year | Full-Time Equivalents per Year | Onsite Full-Time Equivalents |
|--|-------------|----------|--------|-------|----------------|--------------------------------|------------------------------|
| | | Start | Finish | Years | | | |
| Canister Storage Building (CON_CSB) | | | | | | | |
| Radiological workers | 115,500 | 2006 | 2016 | 11 | 10,500 | 6 | 12 |
| Nonradiological workers | | | | | | | |
| On site | 135,929 | 2006 | 2016 | 11 | 12,357 | 6 | |
| Off site | 50,286 | 2006 | 2016 | 11 | 4,571 | 3 | |
| Immobilized High-Level Radioactive Waste Shipping/Transfer Facility (CON_STF) | | | | | | | |
| Radiological workers | N/A | | | | | | 380 |
| Nonradiological workers | | | | | | | |
| Onsite construction | 1,757,000 | 2011 | 2013 | 3 | 585,667 | 282 | |
| Onsite exempt | 610,000 | 2011 | 2013 | 3 | 203,333 | 98 | |
| Offsite design | 748,000 | 2011 | 2013 | 3 | 249,333 | 120 | |
| Immobilized High-Level Radioactive Waste Interim Storage Modules (CON_ISM) | | | | | | | |
| Radiological workers | N/A | | | | | | 232 |
| Nonradiological workers | | | | | | | |
| Onsite construction | 2,671,659 | 2014 | 2022 | 9 | 296,851 | 143 | |
| Onsite exempt | 1,650,000 | 2014 | 2022 | 9 | 183,333 | 89 | |
| Offsite design | 2,025,000 | 2014 | 2022 | 9 | 225,000 | 109 | |
| Other Infrastructure Upgrades (CON_OIU) | | | | | | | |
| Radiological workers | 782,094 | 2006 | 2034 | 29 | 26,969 | 13 | 45 |
| Nonradiological workers | | | | | | | |
| On site | 1,918,531 | 2006 | 2034 | 29 | 66,156 | 32 | |
| Off site | 743,125 | 2006 | 2034 | 29 | 25,625 | 13 | |
| Tank Upgrades (CON_TU) | | | | | | | |
| Radiological workers | 1,195,652 | 2006 | 2025 | 20 | 59,783 | 29 | 104 |
| Nonradiological workers | | | | | | | |
| On site | 3,112,174 | 2006 | 2025 | 20 | 155,609 | 75 | |
| Off site | 1,179,130 | 2006 | 2025 | 20 | 58,957 | 29 | |
| Underground Transfer Lines (CON_UTL) | | | | | | | |
| Radiological workers | N/A | | | | | | 61 |
| Nonradiological workers | | | | | | | |
| On site | 126,005 | 2009 | 2009 | 1 | 126,005 | 61 | |
| Off site | 17,400 | 2009 | 2009 | 1 | 17,400 | 9 | |
| Waste Treatment Plant (CON_WTP) | | | | | | | |
| Radiological workers | N/A | | | | | | 906 |
| Nonradiological workers | | | | | | | |
| On site | 22,612,500 | 2006 | 2017 | 12 | 1,884,375 | 906 | |
| Off site | 7,537,500 | 2006 | 2017 | 12 | 628,125 | 302 | |
| Cesium and Strontium Capsule Processing Facility (CON_CSC) | | | | | | | |
| Radiological workers | N/A | | | | | | 190 |
| Nonradiological workers | | | | | | | |
| On site | 1,578,029 | 2035 | 2038 | 4 | 394,507 | 190 | |
| Off site | 465,683 | 2035 | 2038 | 4 | 116,421 | 56 | |

Draft Tank Closure and Waste Management Environmental Impact Statement for the
Hanford Site, Richland, Washington

Table I-17. Tank Closure Alternative 3B Construction Rollup Workforce Estimate (continued)

| Activity | Total Hours | Duration | | | Hours per Year | Full-Time Equivalents per Year | Onsite Full-Time Equivalents |
|---|-------------|----------|--------|-------|----------------|--------------------------------|------------------------------|
| | | Start | Finish | Years | | | |
| Waste Receiver Facilities (CON_WRF) | | | | | | | |
| Radiological workers | N/A | | | | | | |
| Nonradiological workers | | | | | | | 454 |
| On site | 4,716,000 | 2013 | 2017 | 5 | 943,200 | 454 | |
| Off site | 1,696,000 | 2013 | 2017 | 5 | 339,200 | 164 | |
| Tank Risers (CON_RIS) | | | | | | | |
| Radiological workers | 172,920 | 2013 | 2016 | 4 | 43,230 | 21 | |
| Nonradiological workers | | | | | | | 50 |
| On site | 233,180 | 2013 | 2016 | 4 | 58,295 | 29 | |
| Off site | N/A | | | | | | |
| Modified Sluicing Retrieval System (CON_MS) | | | | | | | |
| Radiological workers | 3,847,797 | 2013 | 2039 | 27 | 142,511 | 69 | |
| Nonradiological workers | | | | | | | 178 |
| On site | 6,076,615 | 2013 | 2039 | 27 | 225,060 | 109 | |
| Off site | 2,137,968 | 2013 | 2039 | 27 | 79,184 | 39 | |
| Mobile Retrieval System (CON_MRS) | | | | | | | |
| Radiological workers | 8,098,800 | 2013 | 2026 | 14 | 578,486 | 279 | |
| Nonradiological workers | | | | | | | 587 |
| On site | 8,940,660 | 2013 | 2026 | 14 | 638,619 | 308 | |
| Off site | 4,794,060 | 2013 | 2026 | 14 | 342,433 | 165 | |
| Vacuum-Based Retrieval System (CON_VBR) | | | | | | | |
| Radiological workers | 11,196,200 | 2027 | 2039 | 13 | 861,246 | 415 | |
| Nonradiological workers | | | | | | | 858 |
| On site | 11,957,150 | 2027 | 2039 | 13 | 919,781 | 443 | |
| Off site | 6,817,400 | 2027 | 2039 | 13 | 524,415 | 253 | |
| High-Level Radioactive Waste Melter Interim Storage Facilities (CON_PAD) | | | | | | | |
| Radiological workers | N/A | | | | | | |
| Nonradiological workers | | | | | | | 1 |
| On site | 2,808 | 2015 | 2016 | 2 | 1,404 | 1 | |
| Off site | N/A | | | | | | |
| Contact-Handled Mixed Transuranic Waste Facilities (CON_CH) | | | | | | | |
| Radiological workers | N/A | | | | | | |
| Nonradiological workers | | | | | | | 60 |
| On site | 124,754 | 2008 | 2008 | 1 | 124,754 | 60 | |
| Off site | 42,147 | 2008 | 2008 | 1 | 42,147 | 21 | |
| Remote-Handled Mixed Transuranic Waste Facility (CON_RH) | | | | | | | |
| Radiological workers | N/A | | | | | | |
| Nonradiological workers | | | | | | | 37 |
| On site | 153,506 | 2013 | 2014 | 2 | 76,753 | 37 | |
| Off site | 51,860 | 2013 | 2014 | 2 | 25,930 | 13 | |
| Transuranic Waste Interim Storage Facility (CON_TRU) | | | | | | | |
| Radiological workers | N/A | | | | | | |
| Nonradiological workers | | | | | | | 4 |
| On site | 16,400 | 2008 | 2009 | 2 | 8,200 | 4 | |
| Off site | N/A | | | | | | |

Table I-17. Tank Closure Alternative 3B Construction Rollup Workforce Estimate (continued)

| Activity | Total Hours | Duration | | | Hours per Year | Full-Time Equivalents per Year | Onsite Full-Time Equivalents |
|---|--------------------|----------|--------|-------|-------------------|--------------------------------|------------------------------|
| | | Start | Finish | Years | | | |
| Cast Stone Facility (200-West Area) (CON_CGW) | | | | | | | |
| Radiological workers | N/A | | | | | | |
| Nonradiological workers | | | | | | | 113 |
| On site | 466,772 | 2016 | 2017 | 2 | 233,386 | 113 | |
| Off site | 157,693 | 2016 | 2017 | 2 | 78,847 | 38 | |
| Solid-Liquid Separations Facility (200-West Area) (CON_SEPW) | | | | | | | |
| Radiological workers | N/A | | | | | | |
| Nonradiological workers | | | | | | | 38 |
| On site | 156,349 | 2016 | 2017 | 2 | 78,174 | 38 | |
| Off site | 52,821 | 2016 | 2017 | 2 | 26,410 | 13 | |
| Cast Stone Facility (200-East Area) (CON_CGE) | | | | | | | |
| Radiological workers | N/A | | | | | | |
| Nonradiological workers | | | | | | | 113 |
| On site | 466,772 | 2016 | 2017 | 2 | 233,386 | 113 | |
| Off site | 157,693 | 2015 | 2016 | 2 | 78,847 | 38 | |
| Effluent Treatment Facility Replacement (CON ETF) | | | | | | | |
| Radiological workers | N/A | | | | | | |
| Nonradiological workers | | | | | | | 329 |
| On site | 2,047,400 | 2023 | 2025 | 3 | 682,467 | 329 | |
| Off site | 703,895 | 2023 | 2025 | 3 | 234,632 | 113 | |
| 242-A Evaporator Replacement (CON_EVA) | | | | | | | |
| Radiological workers | N/A | | | | | | |
| Nonradiological workers | | | | | | | 102 |
| On site | 635,400 | 2015 | 2017 | 3 | 211,800 | 102 | |
| Off site | 217,918 | 2015 | 2017 | 3 | 72,639 | 35 | |
| Total | 127,170,133 | | | | 13,236,312 | 6,387 | 4,854 |

Notes and Assumptions:

Total number of offsite full-time equivalents = 1,533.

Hours worked per year = 2,080.

One full-time equivalent was assumed for activities estimated to require less than 2,080 hours per year.

Key: N/A=not applicable.

Source: Compiled from SAIC 2007a, 2008.

Table I-18. Tank Closure Alternative 3B Operations Rollup Workforce Estimate

| Activity | Total Hours | Duration | | | Hours per Year | Full-Time Equivalents per Year | Onsite Full-Time Equivalents |
|--|-------------|----------|--------|-------|----------------|--------------------------------|------------------------------|
| | | Start | Finish | Years | | | |
| Immobilized High-Level Radioactive Waste Interim Storage Facilities (OPS_ISF) | | | | | | | |
| Radiological workers | 7,779,436 | 2018 | 2066 | 49 | 158,764 | 77 | |
| Nonradiological workers | | | | | | | 120 |
| On site | 4,351,200 | 2018 | 2066 | 49 | 88,800 | 43 | |
| Off site | N/A | | | | | | |
| Other Infrastructure Upgrades (OPS_OIU) | | | | | | | |
| Radiological workers | 40,182 | 2006 | 2039 | 34 | 1,182 | 1 | |
| Nonradiological workers | | | | | | | 4 |
| On site | 147,333 | 2006 | 2039 | 34 | 4,333 | 3 | |
| Off site | 105,091 | 2006 | 2039 | 34 | 3,091 | 2 | |

Draft Tank Closure and Waste Management Environmental Impact Statement for the
Hanford Site, Richland, Washington

Table I-18. Tank Closure Alternative 3B Operations Rollup Workforce Estimate (continued)

| Activity | Total Hours | Duration | | | Hours per Year | Full-Time Equivalents per Year | Onsite Full-Time Equivalents |
|---|-------------|----------|--------|-------|----------------|--------------------------------|------------------------------|
| | | Start | Finish | Years | | | |
| Routine Operations (OPS_ROUT) | | | | | | | |
| Radiological workers | 8,840,000 | 2006 | 2039 | 34 | 260,000 | 125 | 651 |
| Nonradiological workers | | | | | | | |
| On site | 37,162,000 | 2006 | 2039 | 34 | 1,093,000 | 526 | |
| Off site | 5,270,000 | 2006 | 2039 | 34 | 155,000 | 75 | |
| Retrieval Operations (OPS_RET) | | | | | | | |
| Radiological workers | 11,591 | 2006 | 2039 | 34 | 341 | 1 | 28 |
| Nonradiological workers | | | | | | | |
| On site | 1,889,318 | 2006 | 2039 | 34 | 55,568 | 27 | |
| Off site | 14,682 | 2006 | 2039 | 34 | 432 | 1 | |
| Interim Stabilization/Double-Shell Tanks (OPS_IST) | | | | | | | |
| Radiological workers | 1,247,955 | 2006 | 2039 | 34 | 36,705 | 18 | 44 |
| Nonradiological workers | | | | | | | |
| On site | 1,785,773 | 2006 | 2039 | 34 | 52,523 | 26 | |
| Off site | 1,972,000 | 2006 | 2039 | 34 | 58,000 | 28 | |
| Waste Treatment Plant (OPS_WTP) | | | | | | | |
| Radiological workers | 46,100,000 | 2018 | 2039 | 22 | 2,095,455 | 1,008 | 1,697 |
| Nonradiological workers | | | | | | | |
| On site | 31,500,000 | 2018 | 2039 | 22 | 1,431,818 | 689 | |
| Off site | 4,620 | 2018 | 2039 | 22 | 210 | 1 | |
| Waste Treatment Plant—Cesium and Strontium Capsules (OPS_WTPCSC) | | | | | | | |
| Radiological workers | 2,095,455 | 2040 | 2040 | 1 | 2,095,455 | 1,008 | 1,697 |
| Nonradiological workers | | | | | | | |
| On site | 1,431,818 | 2040 | 2040 | 1 | 1,431,818 | 689 | |
| Off site | 210 | 2040 | 2040 | 1 | 210 | 1 | |
| Cesium and Strontium Capsule Processing Facility (OPS_CSC) | | | | | | | |
| Radiological workers | 103,334 | 2039 | 2040 | 2 | 51,667 | 25 | 25 |
| Nonradiological workers | | | | | | | |
| On site | N/A | | | | | | |
| Off site | N/A | | | | | | |
| Modified Sluicing Retrieval System (OPS_MS) | | | | | | | |
| Radiological workers | 5,778,109 | 2013 | 2039 | 27 | 214,004 | 103 | 171 |
| Nonradiological workers | | | | | | | |
| On site | 3,777,905 | 2013 | 2039 | 27 | 139,922 | 68 | |
| Off site | N/A | | | | | | |
| Mobile Retrieval System (OPS_MRS) | | | | | | | |
| Radiological workers | 5,169,360 | 2013 | 2026 | 14 | 369,240 | 178 | 339 |
| Nonradiological workers | | | | | | | |
| On site | 4,678,860 | 2013 | 2026 | 14 | 334,204 | 161 | |
| Off site | N/A | | | | | | |
| Vacuum-Based Retrieval System (OPS_VBR) | | | | | | | |
| Radiological workers | 7,667,884 | 2027 | 2039 | 13 | 589,837 | 284 | 541 |
| Nonradiological workers | | | | | | | |
| On site | 6,940,309 | 2027 | 2039 | 13 | 533,870 | 257 | |
| Off site | N/A | | | | | | |

Table I–18. Tank Closure Alternative 3B Operations Rollup Workforce Estimate (continued)

| Activity | Total Hours | Duration | | | Hours per Year | Full-Time Equivalents per Year | Onsite Full-Time Equivalents |
|---|-------------|----------|--------|-------|----------------|--------------------------------|------------------------------|
| | | Start | Finish | Years | | | |
| High-Level Radioactive Waste Melter Interim Storage Facilities (OPS_PAD) | | | | | | | |
| Radiological workers | N/A | 2018 | 2141 | 124 | N/A | | 0 |
| Nonradiological workers | | | | | | | |
| On site | N/A | | | | | | |
| Off site | N/A | | | | | | |
| Contact-Handled Mixed Transuranic Waste Facilities (OPS_CH) | | | | | | | |
| Radiological workers | 200,000 | 2009 | 2010 | 2 | 100,000 | 49 | 49 |
| Nonradiological workers | | | | | | | |
| On site | N/A | | | | | | |
| Off site | N/A | | | | | | |
| Remote-Handled Mixed Transuranic Waste Facility (OPS_RH) | | | | | | | |
| Radiological workers | 1,000,000 | 2015 | 2019 | 5 | 200,000 | 97 | 97 |
| Nonradiological workers | | | | | | | |
| On site | N/A | | | | | | |
| Off site | N/A | | | | | | |
| Transuranic Waste Interim Storage Facility (OPS_TRU) | | | | | | | |
| Radiological workers | N/A | 2009 | 2034 | 26 | N/A | | 0 |
| Nonradiological workers | | | | | | | |
| On site | N/A | | | | | | |
| Off site | N/A | | | | | | |
| Cast Stone Facility (200-West Area) (OPS_CGW) | | | | | | | |
| Radiological workers | 1,104,000 | 2018 | 2039 | 22 | 50,182 | 25 | 53 |
| Nonradiological workers | | | | | | | |
| On site | 1,242,000 | 2018 | 2039 | 22 | 56,455 | 28 | |
| Off site | N/A | | | | | | |
| Solid-Liquid Separations Facility (200-West Area) (OPS_SEPW) | | | | | | | |
| Radiological workers | 2,800,000 | 2018 | 2039 | 22 | 127,273 | 62 | 81 |
| Nonradiological workers | | | | | | | |
| On site | 850,000 | 2018 | 2039 | 22 | 38,636 | 19 | |
| Off site | N/A | | | | | | |
| Cast Stone Facility (200-East Area) (OPS_CGE) | | | | | | | |
| Radiological workers | 912,000 | 2018 | 2039 | 22 | 41,455 | 20 | 43 |
| Nonradiological workers | | | | | | | |
| On site | 1,026,000 | 2018 | 2039 | 22 | 46,636 | 23 | |
| Off site | N/A | | | | | | |
| Effluent Treatment Facility Replacement (OPS ETF) | | | | | | | |
| Radiological workers | 5,718,720 | 2006 | 2042 | 37 | 154,560 | 75 | 94 |
| Nonradiological workers | | | | | | | |
| On site | 1,429,680 | 2006 | 2042 | 37 | 38,640 | 19 | |
| Off site | N/A | | | | | | |
| 242-A Evaporator Replacement (OPS_EVA) | | | | | | | |
| Radiological workers | 1,711,346 | 2006 | 2040 | 35 | 48,896 | 24 | 32 |
| Nonradiological workers | | | | | | | |
| On site | 523,373 | 2006 | 2040 | 35 | 14,954 | 8 | |
| Off site | N/A | | | | | | |

Draft Tank Closure and Waste Management Environmental Impact Statement for the
Hanford Site, Richland, Washington

Table I-18. Tank Closure Alternative 3B Operations Rollup Workforce Estimate (continued)

| Activity | Total Hours | Duration | | | Hours per Year | Full-Time Equivalents per Year | Onsite Full-Time Equivalents |
|----------------------------------|--------------------|----------|--------|-------|-------------------|--------------------------------|------------------------------|
| | | Start | Finish | Years | | | |
| Borrow Area C (OPS_CAREA) | | | | | | | |
| Radiological workers | N/A | | | | | | |
| Nonradiological workers | | | | | | | |
| On site | 4,201,800 | 2006 | 2052 | 47 | 89,400 | 43 | 43 |
| Off site | N/A | | | | | | |
| Total | 208,583,343 | | | | 12,262,534 | 5,917 | 5,809 |

Notes and Assumptions:

Total number of offsite full-time equivalents = 108.

Hours worked per year = 2,080.

One full-time equivalent was assumed for activities estimated to require less than 2,080 hours per year.

For OPS_WTP, no allowance was made for full-time equivalents in ramp-up years.

For OPS_BVW and BVE, no allowance was made for full-time equivalents in ramp up.

Key: N/A=not applicable.

Source: Compiled from SAIC 2007a, 2008.

Table I-19. Tank Closure Alternative 3B Deactivation Rollup Workforce Estimate

| Activity | Total Hours | Duration | | | Hours per Year | Full-Time Equivalents per Year | Onsite Full-Time Equivalents |
|--|-------------|----------|--------|-------|----------------|--------------------------------|------------------------------|
| | | Start | Finish | Years | | | |
| Immobilized High-Level Radioactive Waste Interim Storage Facilities (DEA_ISF) | | | | | | | |
| Radiological workers | N/A | | | | | | |
| Nonradiological workers | | | | | | | |
| On site | 160 | 2067 | 2067 | 1 | 160 | 1 | 1 |
| Off site | N/A | | | | | | |
| Waste Treatment Plant (DEA_WTP) | | | | | | | |
| Radiological workers | 4,193,167 | 2041 | 2042 | 2 | 2,096,583 | 1,008 | |
| Nonradiological workers | | | | | | | 1,700 |
| On site | 2,875,889 | 2041 | 2042 | 2 | 1,437,944 | 692 | |
| Off site | N/A | | | | | | |
| Cesium and Strontium Capsule Processing Facility (DEA_CSC) | | | | | | | |
| Radiological workers | 23,920 | 2041 | 2041 | 1 | 23,920 | 12 | |
| Nonradiological workers | | | | | | | 12 |
| On site | N/A | | | | | | |
| Off site | N/A | | | | | | |
| Modified Sluicing Retrieval System (DEA_MS) | | | | | | | |
| Radiological workers | 291,082 | 2013 | 2039 | 27 | 10,781 | 6 | |
| Nonradiological workers | | | | | | | 6 |
| On site | N/A | | | | | | |
| Off site | N/A | | | | | | |
| Mobile Retrieval System (DEA_MRS) | | | | | | | |
| Radiological workers | 679,620 | 2013 | 2026 | 14 | 48,544 | 24 | |
| Nonradiological workers | | | | | | | 24 |
| On site | N/A | | | | | | |
| Off site | N/A | | | | | | |

Table I-19. Tank Closure Alternative 3B Deactivation Rollup Workforce Estimate (continued)

| Activity | Total Hours | Duration | | | Hours per Year | Full-Time Equivalents per Year | Onsite Full-Time Equivalents |
|---|-------------|----------|--------|-------|----------------|--------------------------------|------------------------------|
| | | Start | Finish | Years | | | |
| Vacuum-Based Retrieval System (DEA_VBR) | | | | | | | |
| Radiological workers | 258,100 | 2027 | 2039 | 13 | 19,854 | 10 | 10 |
| Nonradiological workers | | | | | | | |
| On site | N/A | | | | | | |
| Off site | N/A | | | | | | |
| Contact-Handled Mixed Transuranic Waste Facilities (DEA_CH) | | | | | | | |
| Radiological workers | 100,000 | 2011 | 2012 | 2 | 50,000 | 25 | 25 |
| Nonradiological workers | | | | | | | |
| On site | N/A | | | | | | |
| Off site | N/A | | | | | | |
| Remote-Handled Mixed Transuranic Waste Facility (DEA_RH) | | | | | | | |
| Radiological workers | 200,000 | 2020 | 2021 | 2 | 100,000 | 49 | 49 |
| Nonradiological workers | | | | | | | |
| On site | N/A | | | | | | |
| Off site | N/A | | | | | | |
| Transuranic Waste Interim Storage Facility (DEA_TRU) | | | | | | | |
| Radiological workers | N/A | | | | | | 1 |
| Nonradiological workers | | | | | | | |
| On site | 80 | 2035 | 2035 | 1 | 80 | 1 | |
| Off site | N/A | | | | | | |
| Cast Stone Facility (200-West Area) (DEA_CGW) | | | | | | | |
| Radiological workers | 48,000 | 2040 | 2041 | 2 | 24,000 | 12 | 25 |
| Nonradiological workers | | | | | | | |
| On site | 54,000 | 2040 | 2041 | 2 | 27,000 | 13 | |
| Off site | N/A | | | | | | |
| Solid-Liquid Separations Facility (200-West Area) (DEA_SEPW) | | | | | | | |
| Radiological workers | 122,000 | 2040 | 2041 | 2 | 61,000 | 30 | 39 |
| Nonradiological workers | | | | | | | |
| On site | 37,000 | 2040 | 2041 | 2 | 18,500 | 9 | |
| Off site | N/A | | | | | | |
| Cast Stone Facility (200-East Area) (DEA_CGE) | | | | | | | |
| Radiological workers | 48,000 | 2040 | 2041 | 2 | 24,000 | 12 | 25 |
| Nonradiological workers | | | | | | | |
| On site | 54,000 | 2040 | 2041 | 2 | 27,000 | 13 | |
| Off site | N/A | | | | | | |
| Effluent Treatment Facility (Original) (DEA_ETFO) | | | | | | | |
| Radiological workers | 77,280 | 2026 | 2026 | 1 | 77,280 | 38 | 48 |
| Nonradiological workers | | | | | | | |
| On site | 19,320 | 2026 | 2026 | 1 | 19,320 | 10 | |
| Off site | N/A | | | | | | |

Draft Tank Closure and Waste Management Environmental Impact Statement for the
Hanford Site, Richland, Washington

Table I-19. Tank Closure Alternative 3B Deactivation Rollup Workforce Estimate (continued)

| Activity | Total Hours | Duration | | | Hours per Year | Full-Time Equivalents per Year | Onsite Full-Time Equivalents |
|--|------------------|----------|--------|-------|------------------|--------------------------------|------------------------------|
| | | Start | Finish | Years | | | |
| Effluent Treatment Facility Replacement (DEA_ETF) | | | | | | | |
| Radiological workers | 77,280 | 2043 | 2043 | 1 | 77,280 | 38 | 48 |
| Nonradiological workers | | | | | | | |
| On site | 19,320 | 2043 | 2043 | 1 | 19,320 | 10 | |
| Off site | N/A | | | | | | |
| 242-A Evaporator (Original) (DEA_EVAO) | | | | | | | |
| Radiological workers | 24,448 | 2018 | 2018 | 1 | 24,448 | 12 | 16 |
| Nonradiological workers | | | | | | | |
| On site | 7,477 | 2018 | 2018 | 1 | 7,477 | 4 | |
| Off site | N/A | | | | | | |
| 242-A Evaporator Replacement (DEA_EVA) | | | | | | | |
| Radiological workers | 24,448 | 2041 | 2041 | 1 | 24,448 | 12 | 16 |
| Nonradiological workers | | | | | | | |
| On site | 7,477 | 2041 | 2041 | 1 | 7,477 | 4 | |
| Off site | N/A | | | | | | |
| Total | 9,242,067 | | | | 4,226,416 | 2,045 | 2,045 |

Notes and Assumptions:

Total number of offsite full-time equivalents = 0.

Hours worked per year = 2,080.

One full-time equivalent was assumed for activities estimated to require less than 2,080 hours per year.

Key: N/A=not applicable.

Source: Compiled from SAIC 2007a, 2008.

Table I-20. Tank Closure Alternative 3B Closure Rollup Workforce Estimate

| Activity | Total Hours | Duration | | | Hours per Year | Full-Time Equivalents per Year | Onsite Full-Time Equivalents |
|--|-------------|----------|--------|-------|----------------|--------------------------------|------------------------------|
| | | Start | Finish | Years | | | |
| Tank-Filling Grout Facility Construction (CLO_CONGRO) | | | | | | | |
| Radiological workers | 480 | 2028 | 2029 | 2 | 240 | 1 | 5 |
| Nonradiological workers | | | | | | | |
| On site | 13,360 | 2028 | 2029 | 2 | 6,680 | 4 | |
| Off site | 4,160 | 2028 | 2029 | 2 | 2,080 | 1 | |
| Tank-Filling Grout Facility Operations (CLO_OPSGRO) | | | | | | | |
| Radiological workers | 68,000 | 2030 | 2039 | 10 | 6,800 | 4 | 13 |
| Nonradiological workers | | | | | | | |
| On site | 185,280 | 2030 | 2039 | 10 | 18,528 | 9 | |
| Off site | 130,000 | 2030 | 2039 | 10 | 13,000 | 7 | |
| Tank-Filling Grout Facility Deactivation (CLO_DEAGRO) | | | | | | | |
| Radiological workers | 480 | 2040 | 2040 | 1 | 480 | 1 | 4 |
| Nonradiological workers | | | | | | | |
| On site | 4,320 | 2040 | 2040 | 1 | 4,320 | 3 | |
| Off site | 1,040 | 2040 | 2040 | 1 | 1,040 | 1 | |

Table I–20. Tank Closure Alternative 3B Closure Rollup Workforce Estimate (continued)

| Activity | Total Hours | Duration | | | Hours per Year | Full-Time Equivalents per Year | Onsite Full-Time Equivalents |
|---|------------------|----------|--------|-------|----------------|--------------------------------|------------------------------|
| | | Start | Finish | Years | | | |
| Ancillary Equipment Grouting (CLO_ANCFIL) | | | | | | | |
| Radiological workers | 337,943 | 2012 | 2032 | 21 | 16,093 | 8 | 8 |
| Nonradiological workers | | | | | | | |
| On site | N/A | | | | | | |
| Off site | N/A | | | | | | |
| Ancillary Equipment Removal (CLO_ANCREM) | | | | | | | |
| Radiological workers | 166,452 | 2028 | 2033 | 6 | 27,742 | 14 | 14 |
| Nonradiological workers | | | | | | | |
| On site | N/A | | | | | | |
| Off site | N/A | | | | | | |
| BX and SX Tank Farm Soil Removal (CLO_SOIL) | | | | | | | |
| Radiological workers | 33,000 | 2028 | 2033 | 6 | 5,500 | 3 | 6 |
| Nonradiological workers | | | | | | | |
| On site | 30,000 | 2028 | 2033 | 6 | 5,000 | 3 | |
| Off site | N/A | | | | | | |
| Containment Structure Construction (CLO_CONCS) | | | | | | | |
| Radiological workers | 2,000 | 2024 | 2027 | 4 | 500 | 1 | 4 |
| Nonradiological workers | | | | | | | |
| On site | 20,000 | 2024 | 2027 | 4 | 5,000 | 3 | |
| Off site | N/A | | | | | | |
| Containment Structure Deactivation (CLO_DEACS) | | | | | | | |
| Radiological workers | 2,000 | 2034 | 2036 | 3 | 667 | 1 | 5 |
| Nonradiological workers | | | | | | | |
| On site | 20,000 | 2034 | 2036 | 3 | 6,667 | 4 | |
| Off site | N/A | | | | | | |
| Modified Resource Conservation and Recovery Act Subtitle C Barrier Construction (CLO_RCRA) | | | | | | | |
| Radiological workers | 1,430,000 | 2035 | 2041 | 7 | 204,286 | 99 | 394 |
| Nonradiological workers | | | | | | | |
| On site | 4,290,000 | 2035 | 2041 | 7 | 612,857 | 295 | |
| Off site | N/A | | | | | | |
| Decontamination and Decommissioning of 10 Selected Facilities (CLO_D&DTEN) | | | | | | | |
| Radiological workers | 44,418 | 2018 | 2028 | 11 | 4,038 | 2 | 9 |
| Nonradiological workers | | | | | | | |
| On site | 146,679 | 2018 | 2028 | 11 | 13,334 | 7 | |
| Off site | 78,970 | 2018 | 2028 | 11 | 7,179 | 4 | |
| Postclosure Care (CLO_POST) | | | | | | | |
| Radiological workers | N/A | | | | | | 3 |
| Nonradiological workers | | | | | | | |
| On site | 471,262 | 2042 | 2141 | 100 | 4,713 | 3 | |
| Off site | N/A | | | | | | |
| Total | 7,479,844 | | | | 966,743 | 478 | 465 |

Notes and Assumptions:

Total number of offsite full-time equivalents = 13.

Hours worked per year = 2,080.

One full-time equivalent was assumed for activities estimated to require less than 2,080 hours per year.

Key: N/A=not applicable.

Source: Compiled from SAIC 2007a, 2008.

I.2.6 Tank Closure Alternative 3C: Existing WTP Vitrification with Thermal Supplemental Treatment (Steam Reforming); Landfill Closure

Table I-21. Tank Closure Alternative 3C Construction Rollup Workforce Estimate

| Activity | Total Hours | Duration | | | Hours per Year | Full-Time Equivalents per Year | Onsite Full-Time Equivalents |
|--|-------------|----------|--------|-------|----------------|--------------------------------|------------------------------|
| | | Start | Finish | Years | | | |
| Canister Storage Building (CON_CSB) | | | | | | | |
| Radiological workers | 115,500 | 2006 | 2016 | 11 | 10,500 | 6 | 12 |
| Nonradiological workers | | | | | | | |
| On site | 135,929 | 2006 | 2016 | 11 | 12,357 | 6 | |
| Off site | 50,286 | 2006 | 2016 | 11 | 4,571 | 3 | |
| Immobilized High-Level Radioactive Waste Shipping/Transfer Facility (CON_STF) | | | | | | | |
| Radiological workers | N/A | | | | | | 380 |
| Nonradiological workers | | | | | | | |
| Onsite construction | 1,757,000 | 2011 | 2013 | 3 | 585,667 | 282 | |
| Onsite exempt | 610,000 | 2011 | 2013 | 3 | 203,333 | 98 | |
| Offsite design | 748,000 | 2011 | 2013 | 3 | 249,333 | 120 | |
| Immobilized High-Level Radioactive Waste Interim Storage Modules (CON_ISM) | | | | | | | |
| Radiological workers | N/A | | | | | | 232 |
| Nonradiological workers | | | | | | | |
| Onsite construction | 2,671,659 | 2014 | 2022 | 9 | 296,851 | 143 | |
| Onsite exempt | 1,650,000 | 2014 | 2022 | 9 | 183,333 | 89 | |
| Offsite design | 2,025,000 | 2014 | 2022 | 9 | 225,000 | 109 | |
| Other Infrastructure Upgrades (CON_OIU) | | | | | | | |
| Radiological workers | 782,094 | 2006 | 2034 | 29 | 26,969 | 13 | 45 |
| Nonradiological workers | | | | | | | |
| On site | 1,918,531 | 2006 | 2034 | 29 | 66,156 | 32 | |
| Off site | 743,125 | 2006 | 2034 | 29 | 25,625 | 13 | |
| Tank Upgrades (CON_TU) | | | | | | | |
| Radiological workers | 1,195,652 | 2006 | 2025 | 20 | 59,783 | 29 | 104 |
| Nonradiological workers | | | | | | | |
| On site | 3,112,174 | 2006 | 2025 | 20 | 155,609 | 75 | |
| Off site | 1,179,130 | 2006 | 2025 | 20 | 58,957 | 29 | |
| Underground Transfer Lines (CON_UTL) | | | | | | | |
| Radiological workers | N/A | | | | | | 61 |
| Nonradiological workers | | | | | | | |
| On site | 126,005 | 2009 | 2009 | 1 | 126,005 | 61 | |
| Off site | 17,400 | 2009 | 2009 | 1 | 17,400 | 9 | |
| Waste Treatment Plant (CON_WTP) | | | | | | | |
| Radiological workers | N/A | | | | | | 906 |
| Nonradiological workers | | | | | | | |
| On site | 22,612,500 | 2006 | 2017 | 12 | 1,884,375 | 906 | |
| Off site | 7,537,500 | 2006 | 2017 | 12 | 628,125 | 302 | |
| Cesium and Strontium Capsule Processing Facility (CON_CSC) | | | | | | | |
| Radiological workers | N/A | | | | | | 190 |
| Nonradiological workers | | | | | | | |
| On site | 1,578,029 | 2035 | 2038 | 4 | 394,507 | 190 | |
| Off site | 465,683 | 2035 | 2038 | 4 | 116,421 | 56 | |

Table I-21. Tank Closure Alternative 3C Construction Rollup Workforce Estimate (continued)

| Activity | Total Hours | Duration | | | Hours per Year | Full-Time Equivalents per Year | Onsite Full-Time Equivalents |
|---|-------------|----------|--------|-------|----------------|--------------------------------|------------------------------|
| | | Start | Finish | Years | | | |
| Waste Receiver Facilities (CON_WRF) | | | | | | | |
| Radiological workers | N/A | | | | | | |
| Nonradiological workers | | | | | | | 454 |
| On site | 4,716,000 | 2013 | 2017 | 5 | 943,200 | 454 | |
| Off site | 1,696,000 | 2013 | 2017 | 5 | 339,200 | 164 | |
| Tank Risers (CON_RIS) | | | | | | | |
| Radiological workers | 172,920 | 2013 | 2016 | 4 | 43,230 | 21 | |
| Nonradiological workers | | | | | | | 50 |
| On site | 233,180 | 2013 | 2016 | 4 | 58,295 | 29 | |
| Off site | N/A | | | | | | |
| Modified Sluicing Retrieval System (CON_MS) | | | | | | | |
| Radiological workers | 3,847,797 | 2013 | 2039 | 27 | 142,511 | 69 | |
| Nonradiological workers | | | | | | | 178 |
| On site | 6,076,615 | 2013 | 2039 | 27 | 225,060 | 109 | |
| Off site | 2,137,968 | 2013 | 2039 | 27 | 79,184 | 39 | |
| Mobile Retrieval System (CON_MRS) | | | | | | | |
| Radiological workers | 8,098,800 | 2013 | 2026 | 14 | 578,486 | 279 | |
| Nonradiological workers | | | | | | | 587 |
| On site | 8,940,660 | 2013 | 2026 | 14 | 638,619 | 308 | |
| Off site | 4,794,060 | 2013 | 2026 | 14 | 342,433 | 165 | |
| Vacuum-Based Retrieval System (CON_VBR) | | | | | | | |
| Radiological workers | 11,196,200 | 2027 | 2039 | 13 | 861,246 | 415 | |
| Nonradiological workers | | | | | | | 858 |
| On site | 11,957,150 | 2027 | 2039 | 13 | 919,781 | 443 | |
| Off site | 6,817,400 | 2027 | 2039 | 13 | 524,415 | 253 | |
| High-Level Radioactive Waste Melter Interim Storage Facilities (CON_PAD) | | | | | | | |
| Radiological workers | N/A | | | | | | |
| Nonradiological workers | | | | | | | 1 |
| On site | 2,808 | 2015 | 2016 | 2 | 1,404 | 1 | |
| Off site | N/A | | | | | | |
| Contact-Handled Mixed Transuranic Waste Facilities (CON_CH) | | | | | | | |
| Radiological workers | N/A | | | | | | |
| Nonradiological workers | | | | | | | 60 |
| On site | 124,754 | 2008 | 2008 | 1 | 124,754 | 60 | |
| Off site | 42,147 | 2008 | 2008 | 1 | 42,147 | 21 | |
| Remote-Handled Mixed Transuranic Waste Facility (CON_RH) | | | | | | | |
| Radiological workers | N/A | | | | | | |
| Nonradiological workers | | | | | | | 37 |
| On site | 153,506 | 2013 | 2014 | 2 | 76,753 | 37 | |
| Off site | 51,860 | 2013 | 2014 | 2 | 25,930 | 13 | |
| Transuranic Waste Interim Storage Facility (CON_TRU) | | | | | | | |
| Radiological workers | N/A | | | | | | |
| Nonradiological workers | | | | | | | 4 |
| On site | 16,400 | 2008 | 2009 | 2 | 8,200 | 4 | |
| Off site | N/A | | | | | | |

Draft Tank Closure and Waste Management Environmental Impact Statement for the
Hanford Site, Richland, Washington

Table I-21. Tank Closure Alternative 3C Construction Rollup Workforce Estimate (continued)

| Activity | Total Hours | Duration | | | Hours per Year | Full-Time Equivalents per Year | Onsite Full-Time Equivalents |
|---|--------------------|----------|--------|-------|-------------------|--------------------------------|------------------------------|
| | | Start | Finish | Years | | | |
| Steam Reforming Facility (200-West Area) (CON_SRW) | | | | | | | |
| Radiological workers | N/A | | | | | | |
| Nonradiological workers | | | | | | | 284 |
| On site | 1,177,773 | 2016 | 2017 | 2 | 588,887 | 284 | |
| Off site | 397,896 | 2016 | 2017 | 2 | 198,948 | 96 | |
| Solid-Liquid Separations Facility (200-West Area) (CON_SEPW) | | | | | | | |
| Radiological workers | N/A | | | | | | |
| Nonradiological workers | | | | | | | 38 |
| On site | 156,349 | 2016 | 2017 | 2 | 78,174 | 38 | |
| Off site | 52,821 | 2016 | 2017 | 2 | 26,410 | 13 | |
| Steam Reforming Facility (200-East Area) (CON_SRE) | | | | | | | |
| Radiological workers | N/A | | | | | | |
| Nonradiological workers | | | | | | | 430 |
| On site | 1,785,170 | 2016 | 2017 | 2 | 892,585 | 430 | |
| Off site | 603,098 | 2016 | 2017 | 2 | 301,549 | 145 | |
| Effluent Treatment Facility Replacement (CON ETF) | | | | | | | |
| Radiological workers | N/A | | | | | | |
| Nonradiological workers | | | | | | | 329 |
| On site | 2,047,400 | 2023 | 2025 | 3 | 682,467 | 329 | |
| Off site | 703,895 | 2023 | 2025 | 3 | 234,632 | 113 | |
| 242-A Evaporator Replacement (CON_EVA) | | | | | | | |
| Radiological workers | N/A | | | | | | |
| Nonradiological workers | | | | | | | 102 |
| On site | 635,400 | 2015 | 2017 | 3 | 211,800 | 102 | |
| Off site | 217,918 | 2015 | 2017 | 3 | 72,639 | 35 | |
| Total | 129,885,141 | | | | 14,593,815 | 7,040 | 5,342 |

Notes and Assumptions:

Total number of offsite full-time equivalents = 1,698.

Hours worked per year = 2,080.

One full-time equivalent was assumed for activities estimated to require less than 2,080 hours per year.

Key: N/A=not applicable.

Source: Compiled from SAIC 2007a, 2008.

Table I-22. Tank Closure Alternative 3C Operations Rollup Workforce Estimate

| Activity | Total Hours | Duration | | | Hours per Year | Full-Time Equivalents per Year | Onsite Full-Time Equivalents |
|--|-------------|----------|--------|-------|----------------|--------------------------------|------------------------------|
| | | Start | Finish | Years | | | |
| Immobilized High-Level Radioactive Waste Interim Storage Facilities (OPS_ISF) | | | | | | | |
| Radiological workers | 7,779,436 | 2018 | 2066 | 49 | 158,764 | 77 | |
| Nonradiological workers | | | | | | | 120 |
| On site | 4,351,200 | 2018 | 2066 | 49 | 88,800 | 43 | |
| Off site | N/A | | | | | | |

Table I–22. Tank Closure Alternative 3C Operations Rollup Workforce Estimate (continued)

| Activity | Total Hours | Duration | | | Hours per Year | Full-Time Equivalents per Year | Onsite Full-Time Equivalents |
|---|-------------|----------|--------|-------|----------------|--------------------------------|------------------------------|
| | | Start | Finish | Years | | | |
| Other Infrastructure Upgrades (OPS_OIU) | | | | | | | |
| Radiological workers | 40,182 | 2006 | 2039 | 34 | 1,182 | 1 | 4 |
| Nonradiological workers | | | | | | | |
| On site | 147,333 | 2006 | 2039 | 34 | 4,333 | 3 | |
| Off site | 105,091 | 2006 | 2039 | 34 | 3,091 | 2 | |
| Routine Operations (OPS_ROUT) | | | | | | | |
| Radiological workers | 8,840,000 | 2006 | 2039 | 34 | 260,000 | 125 | 651 |
| Nonradiological workers | | | | | | | |
| On site | 37,162,000 | 2006 | 2039 | 34 | 1,093,000 | 526 | |
| Off site | 5,270,000 | 2006 | 2039 | 34 | 155,000 | 75 | |
| Retrieval Operations (OPS_RET) | | | | | | | |
| Radiological workers | 11,591 | 2006 | 2039 | 34 | 341 | 1 | 28 |
| Nonradiological workers | | | | | | | |
| On site | 1,889,318 | 2006 | 2039 | 34 | 55,568 | 27 | |
| Off site | 14,682 | 2006 | 2039 | 34 | 432 | 1 | |
| Interim Stabilization/Double-Shell Tanks (OPS_IST) | | | | | | | |
| Radiological workers | 1,247,955 | 2006 | 2039 | 34 | 36,705 | 18 | 44 |
| Nonradiological workers | | | | | | | |
| On site | 1,785,773 | 2006 | 2039 | 34 | 52,523 | 26 | |
| Off site | 1,972,000 | 2006 | 2039 | 34 | 58,000 | 28 | |
| Waste Treatment Plant (OPS_WTP) | | | | | | | |
| Radiological workers | 46,100,000 | 2018 | 2039 | 22 | 2,095,455 | 1,008 | 1,697 |
| Nonradiological workers | | | | | | | |
| On site | 31,500,000 | 2018 | 2039 | 22 | 1,431,818 | 689 | |
| Off site | 4,620 | 2018 | 2039 | 22 | 210 | 1 | |
| Waste Treatment Plant—Cesium and Strontium Capsules (OPS_WTPCSC) | | | | | | | |
| Radiological workers | 2,095,455 | 2040 | 2040 | 1 | 2,095,455 | 1,008 | 1,697 |
| Nonradiological workers | | | | | | | |
| On site | 1,431,818 | 2040 | 2040 | 1 | 1,431,818 | 689 | |
| Off site | 210 | 2040 | 2040 | 1 | 210 | 1 | |
| Cesium and Strontium Capsule Processing Facility (OPS_CSC) | | | | | | | |
| Radiological workers | 103,334 | 2039 | 2040 | 2 | 51,667 | 25 | 25 |
| Nonradiological workers | | | | | | | |
| On site | N/A | | | | | | |
| Off site | N/A | | | | | | |
| Modified Sluicing Retrieval System (OPS_MS) | | | | | | | |
| Radiological workers | 5,778,109 | 2013 | 2039 | 27 | 214,004 | 103 | 171 |
| Nonradiological workers | | | | | | | |
| On site | 3,777,905 | 2013 | 2039 | 27 | 139,922 | 68 | |
| Off site | N/A | | | | | | |

Draft Tank Closure and Waste Management Environmental Impact Statement for the
Hanford Site, Richland, Washington

Table I-22. Tank Closure Alternative 3C Operations Rollup Workforce Estimate (continued)

| Activity | Total Hours | Duration | | | Hours per Year | Full-Time Equivalents per Year | Onsite Full-Time Equivalents |
|---|-------------|----------|--------|-------|----------------|--------------------------------|------------------------------|
| | | Start | Finish | Years | | | |
| Mobile Retrieval System (OPS_MRS) | | | | | | | |
| Radiological workers | 5,169,360 | 2013 | 2026 | 14 | 369,240 | 178 | 339 |
| Nonradiological workers | | | | | | | |
| On site | 4,678,860 | 2013 | 2026 | 14 | 334,204 | 161 | |
| Vacuum-Based Retrieval System (OPS_VBR) | | | | | | | |
| Radiological workers | 7,667,884 | 2027 | 2039 | 13 | 589,837 | 284 | 541 |
| Nonradiological workers | | | | | | | |
| On site | 6,940,309 | 2027 | 2039 | 13 | 533,870 | 257 | |
| Off site | N/A | | | | | | |
| High-Level Radioactive Waste Melter Interim Storage Facilities (OPS_PAD) | | | | | | | |
| Radiological workers | N/A | 2018 | 2141 | 124 | N/A | | |
| Nonradiological workers | | | | | | | |
| On site | N/A | | | | | | |
| Off site | N/A | | | | | | |
| Contact-Handled Mixed Transuranic Waste Facilities (OPS_CH) | | | | | | | |
| Radiological workers | 200,000 | 2009 | 2010 | 2 | 100,000 | 49 | 49 |
| Nonradiological workers | | | | | | | |
| On site | N/A | | | | | | |
| Off site | N/A | | | | | | |
| Remote-Handled Mixed Transuranic Waste Facility (OPS_RH) | | | | | | | |
| Radiological workers | 1,000,000 | 2015 | 2019 | 5 | 200,000 | 97 | 97 |
| Nonradiological workers | | | | | | | |
| On site | N/A | | | | | | |
| Off site | N/A | | | | | | |
| Transuranic Waste Interim Storage Facility (OPS_TRU) | | | | | | | |
| Radiological workers | N/A | 2009 | 2034 | 26 | | | |
| Nonradiological workers | | | | | | | |
| On site | N/A | | | | | | |
| Off site | N/A | | | | | | |
| Steam Reforming Facility (200-West Area) (OPS_SRW) | | | | | | | |
| Radiological workers | 3,840,000 | 2018 | 2039 | 22 | 174,545 | 84 | 112 |
| Nonradiological workers | | | | | | | |
| On site | 1,280,000 | 2018 | 2039 | 22 | 58,182 | 28 | |
| Off site | N/A | | | | | | |
| Solid-Liquid Separations Facility (200-West Area) (OPS_SEPW) | | | | | | | |
| Radiological workers | 2,800,000 | 2018 | 2039 | 22 | 127,273 | 62 | 81 |
| Nonradiological workers | | | | | | | |
| On site | 850,000 | 2018 | 2039 | 22 | 38,636 | 19 | |
| Off site | N/A | | | | | | |
| Steam Reforming Facility (200-East Area) (OPS_SRE) | | | | | | | |
| Radiological workers | 6,388,000 | 2018 | 2039 | 22 | 290,364 | 140 | 187 |
| Nonradiological workers | | | | | | | |
| On site | 2,129,000 | 2018 | 2039 | 22 | 96,773 | 47 | |
| Off site | N/A | | | | | | |

Table I–22. Tank Closure Alternative 3C Operations Rollup Workforce Estimate (continued)

| Activity | Total Hours | Duration | | | Hours per Year | Full-Time Equivalents per Year | Onsite Full-Time Equivalents |
|--|--------------------|----------|--------|-------|-------------------|--------------------------------|------------------------------|
| | | Start | Finish | Years | | | |
| Effluent Treatment Facility Replacement (OPS ETF) | | | | | | | |
| Radiological workers | 5,718,720 | 2006 | 2042 | 37 | 154,560 | 75 | 94 |
| Nonradiological workers | | | | | | | |
| On site | 1,429,680 | 2006 | 2042 | 37 | 38,640 | 19 | |
| Off site | N/A | | | | | | |
| 242-A Evaporator Replacement (OPS EVA) | | | | | | | |
| Radiological workers | 1,711,346 | 2006 | 2040 | 35 | 48,896 | 24 | 32 |
| Nonradiological workers | | | | | | | |
| On site | 523,373 | 2006 | 2040 | 35 | 14,954 | 8 | |
| Off site | N/A | | | | | | |
| Borrow Area C (OPS CAREA) | | | | | | | |
| Radiological workers | N/A | | | | | | 43 |
| Nonradiological workers | | | | | | | |
| On site | 4,201,800 | 2006 | 2052 | 47 | 89,400 | 43 | |
| Off site | N/A | | | | | | |
| Total | 217,936,343 | | | | 12,687,671 | 6,120 | 6,012 |

Notes and Assumptions:

Total number of offsite full-time equivalents = 108.

Hours worked per year = 2,080.

One full-time equivalent was assumed for activities estimated to require less than 2,080 hours per year.

For OPS_WTP, no allowance was made for full-time equivalents in ramp-up years.

For OPS_BVW and BVE, no allowance was made for full-time equivalents in ramp up.

Key: N/A=not applicable.

Source: Compiled from SAIC 2007a, 2008.

Table I–23. Tank Closure Alternative 3C Deactivation Rollup Workforce Estimate

| Activity | Total Hours | Duration | | | Hours per Year | Full-Time Equivalents per Year | Onsite Full-Time Equivalents |
|--|-------------|----------|--------|-------|----------------|--------------------------------|------------------------------|
| | | Start | Finish | Years | | | |
| Immobilized High-Level Radioactive Waste Interim Storage Facilities (DEA_ISF) | | | | | | | |
| Radiological workers | N/A | | | | | | 1 |
| Nonradiological workers | | | | | | | |
| On site | 160 | 2067 | 2067 | 1 | 160 | 1 | |
| Off site | N/A | | | | | | |
| Waste Treatment Plant (DEA_WTP) | | | | | | | |
| Radiological workers | 4,193,167 | 2041 | 2042 | 2 | 2,096,583 | 1,008 | 1,700 |
| Nonradiological workers | | | | | | | |
| On site | 2,875,889 | 2041 | 2042 | 2 | 1,437,944 | 692 | |
| Off site | N/A | | | | | | |
| Cesium and Strontium Capsule Processing Facility (DEA_CSC) | | | | | | | |
| Radiological workers | 23,920 | 2041 | 2041 | 1 | 23,920 | 12 | 12 |
| Nonradiological workers | | | | | | | |
| On site | N/A | | | | | | |
| Off site | N/A | | | | | | |

Draft Tank Closure and Waste Management Environmental Impact Statement for the
Hanford Site, Richland, Washington

Table I-23. Tank Closure Alternative 3C Deactivation Rollup Workforce Estimate (continued)

| Activity | Total Hours | Duration | | | Hours per Year | Full-Time Equivalents per Year | Onsite Full-Time Equivalents |
|---|-------------|----------|--------|-------|----------------|--------------------------------|------------------------------|
| | | Start | Finish | Years | | | |
| Modified Sluicing Retrieval System (DEA_MS) | | | | | | | |
| Radiological workers | 291,082 | 2013 | 2039 | 27 | 10,781 | 6 | 6 |
| Nonradiological workers | | | | | | | |
| On site | N/A | | | | | | |
| Off site | N/A | | | | | | |
| Mobile Retrieval System (DEA_MRS) | | | | | | | |
| Radiological workers | 679,620 | 2013 | 2026 | 14 | 48,544 | 24 | 24 |
| Nonradiological workers | | | | | | | |
| On site | N/A | | | | | | |
| Off site | N/A | | | | | | |
| Vacuum-Based Retrieval System (DEA_VBR) | | | | | | | |
| Radiological workers | 258,100 | 2027 | 2039 | 13 | 19,854 | 10 | 10 |
| Nonradiological workers | | | | | | | |
| On site | N/A | | | | | | |
| Off site | N/A | | | | | | |
| Contact-Handled Mixed Transuranic Waste Facilities (DEA_CH) | | | | | | | |
| Radiological workers | 100,000 | 2011 | 2012 | 2 | 50,000 | 25 | 25 |
| Nonradiological workers | | | | | | | |
| On site | N/A | | | | | | |
| Off site | N/A | | | | | | |
| Remote-Handled Mixed Transuranic Waste Facility (DEA_RH) | | | | | | | |
| Radiological workers | 200,000 | 2020 | 2021 | 2 | 100,000 | 49 | 49 |
| Nonradiological workers | | | | | | | |
| On site | N/A | | | | | | |
| Off site | N/A | | | | | | |
| Transuranic Waste Interim Storage Facility (DEA_TRU) | | | | | | | |
| Radiological workers | N/A | | | | | | 1 |
| Nonradiological workers | | | | | | | |
| On site | 80 | 2035 | 2035 | 1 | 80 | 1 | |
| Off site | N/A | | | | | | |
| Steam Reforming Facility (200-West Area) (DEA_SRW) | | | | | | | |
| Radiological workers | 168,000 | 2040 | 2041 | 2 | 84,000 | 41 | 55 |
| Nonradiological workers | | | | | | | |
| On site | 56,000 | 2040 | 2041 | 2 | 28,000 | 14 | |
| Off site | N/A | | | | | | |
| Solid-Liquid Separations Facility (200-West Area) (DEA_SEPW) | | | | | | | |
| Radiological workers | 122,000 | 2040 | 2041 | 2 | 61,000 | 30 | 39 |
| Nonradiological workers | | | | | | | |
| On site | 37,000 | 2040 | 2041 | 2 | 18,500 | 9 | |
| Off site | N/A | | | | | | |
| Steam Reforming Facility (200-East Area) (DEA_SRE) | | | | | | | |
| Radiological workers | 336,000 | 2040 | 2041 | 2 | 168,000 | 81 | 108 |
| Nonradiological workers | | | | | | | |
| On site | 112,000 | 2040 | 2041 | 2 | 56,000 | 27 | |
| Off site | N/A | | | | | | |

Table I–23. Tank Closure Alternative 3C Deactivation Rollup Workforce Estimate (continued)

| Activity | Total Hours | Duration | | | Hours per Year | Full-Time Equivalents per Year | Onsite Full-Time Equivalents |
|--|------------------|----------|--------|-------|------------------|--------------------------------|------------------------------|
| | | Start | Finish | Years | | | |
| Effluent Treatment Facility (Original) (DEA_ETFO) | | | | | | | |
| Radiological workers | 77,280 | 2026 | 2026 | 1 | 77,280 | 38 | 48 |
| Nonradiological workers | | | | | | | |
| On site | 19,320 | 2026 | 2026 | 1 | 19,320 | 10 | |
| Off site | N/A | | | | | | |
| Effluent Treatment Facility Replacement (DEA ETF) | | | | | | | |
| Radiological workers | 77,280 | 2043 | 2043 | 1 | 77,280 | 38 | 48 |
| Nonradiological workers | | | | | | | |
| On site | 19,320 | 2043 | 2043 | 1 | 19,320 | 10 | |
| Off site | N/A | | | | | | |
| 242-A Evaporator (Original) (DEA_EVAO) | | | | | | | |
| Radiological workers | 24,448 | 2018 | 2018 | 1 | 24,448 | 12 | 16 |
| Nonradiological workers | | | | | | | |
| On site | 7,477 | 2018 | 2018 | 1 | 7,477 | 4 | |
| Off site | N/A | | | | | | |
| 242-A Evaporator Replacement (DEA_EVA) | | | | | | | |
| Radiological workers | 24,448 | 2041 | 2041 | 1 | 24,448 | 12 | 16 |
| Nonradiological workers | | | | | | | |
| On site | 7,477 | 2041 | 2041 | 1 | 7,477 | 4 | |
| Off site | N/A | | | | | | |
| Total | 9,710,067 | | | | 4,460,416 | 2,158 | 2,158 |

Notes and Assumptions:

Total number of offsite full-time equivalents = 0.

Hours worked per year = 2,080.

One full-time equivalent was assumed for activities estimated to require less than 2,080 hours per year.

Key: N/A=not applicable.

Source: Compiled from SAIC 2007a, 2008.

Table I–24. Tank Closure Alternative 3C Closure Rollup Workforce Estimate

| Activity | Total Hours | Duration | | | Hours per Year | Full-Time Equivalents per Year | Onsite Full-Time Equivalents |
|--|-------------|----------|--------|-------|----------------|--------------------------------|------------------------------|
| | | Start | Finish | Years | | | |
| Tank-Filling Grout Facility Construction (CLO_CONGRO) | | | | | | | |
| Radiological workers | 480 | 2028 | 2029 | 2 | 240 | 1 | 5 |
| Nonradiological workers | | | | | | | |
| On site | 13,360 | 2028 | 2029 | 2 | 6,680 | 4 | |
| Off site | 4,160 | 2028 | 2029 | 2 | 2,080 | 1 | |
| Tank-Filling Grout Facility Operations (CLO_OPSGRO) | | | | | | | |
| Radiological workers | 68,000 | 2030 | 2039 | 10 | 6,800 | 4 | 13 |
| Nonradiological workers | | | | | | | |
| On site | 185,280 | 2030 | 2039 | 10 | 18,528 | 9 | |
| Off site | 130,000 | 2030 | 2039 | 10 | 13,000 | 7 | |
| Tank-Filling Grout Facility Deactivation (CLO_DEAGRO) | | | | | | | |
| Radiological workers | 480 | 2040 | 2040 | 1 | 480 | 1 | 4 |
| Nonradiological workers | | | | | | | |
| On site | 4,320 | 2040 | 2040 | 1 | 4,320 | 3 | |
| Off site | 1,040 | 2040 | 2040 | 1 | 1,040 | 1 | |

Draft Tank Closure and Waste Management Environmental Impact Statement for the
Hanford Site, Richland, Washington

Table I-24. Tank Closure Alternative 3C Closure Rollup Workforce Estimate (continued)

| Activity | Total Hours | Duration | | | Hours per Year | Full-Time Equivalents per Year | Onsite Full-Time Equivalents |
|---|------------------|----------|--------|-------|----------------|--------------------------------|------------------------------|
| | | Start | Finish | Years | | | |
| Ancillary Equipment Grouting (CLO_ANCFIL) | | | | | | | |
| Radiological workers | 337,943 | 2012 | 2032 | 21 | 16,093 | 8 | 8 |
| Nonradiological workers | | | | | | | |
| On site | N/A | | | | | | |
| Off site | N/A | | | | | | |
| Ancillary Equipment Removal (CLO_ANCREM) | | | | | | | |
| Radiological workers | 166,452 | 2028 | 2033 | 6 | 27,742 | 14 | 14 |
| Nonradiological workers | | | | | | | |
| On site | N/A | | | | | | |
| Off site | N/A | | | | | | |
| BX and SX Tank Farm Soil Removal (CLO_SOIL) | | | | | | | |
| Radiological workers | 33,000 | 2028 | 2033 | 6 | 5,500 | 3 | 6 |
| Nonradiological workers | | | | | | | |
| On site | 30,000 | 2028 | 2033 | 6 | 5,000 | 3 | |
| Off site | N/A | | | | | | |
| Containment Structure Construction (CLO_CONCS) | | | | | | | |
| Radiological workers | 2,000 | 2024 | 2027 | 4 | 500 | 1 | 4 |
| Nonradiological workers | | | | | | | |
| On site | 20,000 | 2024 | 2027 | 4 | 5,000 | 3 | |
| Off site | N/A | | | | | | |
| Containment Structure Deactivation (CLO_DEACS) | | | | | | | |
| Radiological workers | 2,000 | 2034 | 2036 | 3 | 667 | 1 | 5 |
| Nonradiological workers | | | | | | | |
| On site | 20,000 | 2034 | 2036 | 3 | 6,667 | 4 | |
| Off site | N/A | | | | | | |
| Modified Resource Conservation and Recovery Act Subtitle C Barrier Construction (CLO_RCRA) | | | | | | | |
| Radiological workers | 1,430,000 | 2035 | 2041 | 7 | 204,286 | 99 | 394 |
| Nonradiological workers | | | | | | | |
| On site | 4,290,000 | 2035 | 2041 | 7 | 612,857 | 295 | |
| Off site | N/A | | | | | | |
| Decontamination and Decommissioning of 10 Selected Facilities (CLO_D&DTEN) | | | | | | | |
| Radiological workers | 44,418 | 2018 | 2028 | 11 | 4,038 | 2 | 9 |
| Nonradiological workers | | | | | | | |
| On site | 146,679 | 2018 | 2028 | 11 | 13,334 | 7 | |
| Off site | 78,970 | 2018 | 2028 | 11 | 7,179 | 4 | |
| Postclosure Care (CLO_POST) | | | | | | | |
| Radiological workers | N/A | | | | | | 3 |
| Nonradiological workers | | | | | | | |
| On site | 471,262 | 2042 | 2141 | 100 | 4,713 | 3 | |
| Off site | N/A | | | | | | |
| Total | 7,479,844 | | | | 966,743 | 478 | 465 |

Notes and Assumptions:

Total number of offsite full-time equivalents = 13.

Hours worked per year = 2,080.

One full-time equivalent was assumed for activities estimated to require less than 2,080 hours per year.

Key: N/A=not applicable.

Source: Compiled from SAIC 2007a, 2008.

I.2.7 Tank Closure Alternative 4: Existing WTP Vitrification with Supplemental Treatment Technologies; Selective Clean Closure/Landfill Closure

Table I-25. Tank Closure Alternative 4 Construction Rollup Workforce Estimate

| Activity | Total Hours | Duration | | | Hours per Year | Full-Time Equivalents per Year | Onsite Full-Time Equivalents |
|--|-------------|----------|--------|-------|----------------|--------------------------------|------------------------------|
| | | Start | Finish | Years | | | |
| Canister Storage Building (CON_CSB) | | | | | | | |
| Radiological workers | 115,500 | 2006 | 2016 | 11 | 10,500 | 6 | 12 |
| Nonradiological workers | | | | | | | |
| On site | 135,929 | 2006 | 2016 | 11 | 12,357 | 6 | |
| Off site | 50,286 | 2006 | 2016 | 11 | 4,571 | 3 | |
| Immobilized High-Level Radioactive Waste Shipping/Transfer Facility (CON_STF) | | | | | | | |
| Radiological workers | N/A | | | | | | 380 |
| Nonradiological workers | | | | | | | |
| Onsite construction | 1,757,000 | 2011 | 2013 | 3 | 585,667 | 282 | |
| Onsite exempt | 610,000 | 2011 | 2013 | 3 | 203,333 | 98 | |
| Offsite design | 748,000 | 2011 | 2013 | 3 | 249,333 | 120 | |
| Immobilized High-Level Radioactive Waste Interim Storage Modules (CON_ISM) | | | | | | | |
| Radiological workers | N/A | | | | | | 232 |
| Nonradiological workers | | | | | | | |
| Onsite construction | 2,671,659 | 2014 | 2022 | 9 | 296,851 | 143 | |
| Onsite exempt | 1,650,000 | 2014 | 2022 | 9 | 183,333 | 89 | |
| Offsite design | 2,025,000 | 2014 | 2022 | 9 | 225,000 | 109 | |
| Other Infrastructure Upgrades (CON_OIU) | | | | | | | |
| Radiological workers | 782,094 | 2006 | 2034 | 29 | 26,969 | 13 | 45 |
| Nonradiological workers | | | | | | | |
| On site | 1,918,531 | 2006 | 2034 | 29 | 66,156 | 32 | |
| Off site | 743,125 | 2006 | 2034 | 29 | 25,625 | 13 | |
| Tank Upgrades (CON_TU) | | | | | | | |
| Radiological workers | 1,195,652 | 2006 | 2025 | 20 | 59,783 | 29 | 104 |
| Nonradiological workers | | | | | | | |
| On site | 3,112,174 | 2006 | 2025 | 20 | 155,609 | 75 | |
| Off site | 1,179,130 | 2006 | 2025 | 20 | 58,957 | 29 | |
| Underground Transfer Lines (CON_UTL) | | | | | | | |
| Radiological workers | N/A | | | | | | 61 |
| Nonradiological workers | | | | | | | |
| On site | 126,005 | 2009 | 2009 | 1 | 126,005 | 61 | |
| Off site | 17,400 | 2009 | 2009 | 1 | 17,400 | 9 | |
| Waste Treatment Plant (CON_WTP) | | | | | | | |
| Radiological workers | N/A | | | | | | 906 |
| Nonradiological workers | | | | | | | |
| On site | 22,612,500 | 2006 | 2017 | 12 | 1,884,375 | 906 | |
| Off site | 7,537,500 | 2006 | 2017 | 12 | 628,125 | 302 | |
| Cesium and Strontium Capsule Processing Facility (CON_CSC) | | | | | | | |
| Radiological workers | N/A | | | | | | 190 |
| Nonradiological workers | | | | | | | |
| On site | 1,578,029 | 2038 | 2041 | 4 | 394,507 | 190 | |
| Off site | 465,683 | 2038 | 2041 | 4 | 116,421 | 56 | |

Draft Tank Closure and Waste Management Environmental Impact Statement for the
Hanford Site, Richland, Washington

Table I-25. Closure Alternative 4 Construction Rollup Workforce Estimate (continued)

| Activity | Total Hours | Duration | | | Hours per Year | Full-Time Equivalents per Year | Onsite Full-Time Equivalents |
|---|-------------|----------|--------|-------|----------------|--------------------------------|------------------------------|
| | | Start | Finish | Years | | | |
| Waste Receiver Facilities (CON_WRF) | | | | | | | |
| Radiological workers | N/A | | | | | | |
| Nonradiological workers | | | | | | | 454 |
| On site | 4,716,000 | 2013 | 2017 | 5 | 943,200 | 454 | |
| Off site | 1,696,000 | 2013 | 2017 | 5 | 339,200 | 164 | |
| Tank Risers (CON_RIS) | | | | | | | |
| Radiological workers | 188,760 | 2013 | 2016 | 4 | 47,190 | 23 | |
| Nonradiological workers | | | | | | | 54 |
| On site | 254,540 | 2013 | 2016 | 4 | 63,635 | 31 | |
| Off site | N/A | | | | | | |
| Mobile Retrieval System (CON_MRS) | | | | | | | |
| Radiological workers | 21,731,780 | 2013 | 2042 | 30 | 724,393 | 349 | |
| Nonradiological workers | | | | | | | 734 |
| On site | 23,990,771 | 2013 | 2042 | 30 | 799,692 | 385 | |
| Off site | 12,864,061 | 2013 | 2042 | 30 | 428,802 | 207 | |
| Vacuum-Based Retrieval System (CON_VBR) | | | | | | | |
| Radiological workers | 11,196,200 | 2013 | 2042 | 30 | 373,207 | 180 | |
| Nonradiological workers | | | | | | | 372 |
| On site | 11,957,150 | 2013 | 2042 | 30 | 398,572 | 192 | |
| Off site | 6,817,400 | 2013 | 2042 | 30 | 227,247 | 110 | |
| Chemical Wash System (CON_CHW) | | | | | | | |
| Radiological workers | 2,378,750 | 2013 | 2042 | 30 | 79,292 | 39 | |
| Nonradiological workers | | | | | | | 47 |
| On site | 471,625 | 2013 | 2042 | 30 | 15,721 | 8 | |
| Off site | 634,875 | 2013 | 2042 | 30 | 21,163 | 11 | |
| High-Level Radioactive Waste Melter Interim Storage Facilities (CON_PAD) | | | | | | | |
| Radiological workers | N/A | | | | | | |
| Nonradiological workers | | | | | | | 1 |
| On site | 2,808 | 2015 | 2016 | 2 | 1,404 | 1 | |
| Off site | N/A | | | | | | |
| Contact-Handled Mixed Transuranic Waste Facilities (CON_CH) | | | | | | | |
| Radiological workers | N/A | | | | | | |
| Nonradiological workers | | | | | | | 60 |
| On site | 124,754 | 2008 | 2008 | 1 | 124,754 | 60 | |
| Off site | 42,147 | 2008 | 2008 | 1 | 42,147 | 21 | |
| Remote-Handled Mixed Transuranic Waste Facility (CON_RH) | | | | | | | |
| Radiological workers | N/A | | | | | | |
| Nonradiological workers | | | | | | | 37 |
| On site | 153,506 | 2013 | 2014 | 2 | 76,753 | 37 | |
| Off site | 51,860 | 2013 | 2014 | 2 | 25,930 | 13 | |
| Transuranic Waste Interim Storage Facility (CON_TRU) | | | | | | | |
| Radiological workers | N/A | | | | | | |
| Nonradiological workers | | | | | | | 4 |
| On site | 16,400 | 2008 | 2009 | 2 | 8,200 | 4 | |
| Off site | N/A | | | | | | |

Table I–25. Closure Alternative 4 Construction Rollup Workforce Estimate (continued)

| Activity | Total Hours | Duration | | | Hours per Year | Full-Time Equivalents per Year | Onsite Full-Time Equivalents |
|---|--------------------|----------|--------|-------|-------------------|--------------------------------|------------------------------|
| | | Start | Finish | Years | | | |
| Bulk Vitrification Facility (200-West Area) (CON_BV) | | | | | | | |
| Radiological workers | N/A | | | | | | |
| Nonradiological workers | | | | | | | 165 |
| On site | 684,068 | 2016 | 2017 | 2 | 342,034 | 165 | |
| Off site | 231,104 | 2016 | 2017 | 2 | 115,552 | 56 | |
| Solid-Liquid Separations Facility (200-West Area) (CON_SEPW) | | | | | | | |
| Radiological workers | N/A | | | | | | |
| Nonradiological workers | | | | | | | 38 |
| On site | 156,349 | 2016 | 2017 | 2 | 78,174 | 38 | |
| Off site | 52,821 | 2016 | 2017 | 2 | 26,410 | 13 | |
| Cast Stone Facility (200-East Area) (CON_CG) | | | | | | | |
| Radiological workers | N/A | | | | | | |
| Nonradiological workers | | | | | | | 113 |
| On site | 466,772 | 2016 | 2017 | 2 | 233,386 | 113 | |
| Off site | 157,693 | 2016 | 2017 | 2 | 78,847 | 38 | |
| Effluent Treatment Facility Replacement (CON ETF) | | | | | | | |
| Radiological workers | N/A | | | | | | |
| Nonradiological workers | | | | | | | 329 |
| On site | 2,047,400 | 2023 | 2025 | 3 | 682,467 | 329 | |
| Off site | 703,895 | 2023 | 2025 | 3 | 234,632 | 113 | |
| 242-A Evaporator Replacement (CON EVA) | | | | | | | |
| Radiological workers | N/A | | | | | | |
| Nonradiological workers | | | | | | | 102 |
| On site | 635,400 | 2015 | 2017 | 3 | 211,800 | 102 | |
| Off site | 217,918 | 2015 | 2017 | 3 | 72,639 | 35 | |
| Total | 155,674,003 | | | | 12,147,318 | 5,862 | 4,440 |

Notes and Assumptions:

Total number of offsite full-time equivalents = 1,422.

Hours worked per year = 2,080.

One full-time equivalent was assumed for activities estimated to require less than 2,080 hours per year.

Key: N/A=not applicable.

Source: Compiled from SAIC 2007a, 2008.

Table I–26. Tank Closure Alternative 4 Operations Rollup Workforce Estimate

| Activity | Total Hours | Duration | | | Hours per Year | Full-Time Equivalents per Year | Onsite Full-Time Equivalents |
|--|-------------|----------|--------|-------|----------------|--------------------------------|------------------------------|
| | | Start | Finish | Years | | | |
| Immobilized High-Level Radioactive Waste Interim Storage Facilities (OPS_ISF) | | | | | | | |
| Radiological workers | 7,779,436 | 2018 | 2066 | 49 | 158,764 | 77 | |
| Nonradiological workers | | | | | | | 120 |
| On site | 4,351,200 | 2018 | 2066 | 49 | 88,800 | 43 | |
| Off site | N/A | | | | | | |
| Other Infrastructure Upgrades (OPS_OIU) | | | | | | | |
| Radiological workers | 43,727 | 2006 | 2042 | 37 | 1,182 | 1 | |
| Nonradiological workers | | | | | | | 4 |
| On site | 160,333 | 2006 | 2042 | 37 | 4,333 | 3 | |
| Off site | 114,364 | 2006 | 2042 | 37 | 3,091 | 2 | |

Draft Tank Closure and Waste Management Environmental Impact Statement for the
Hanford Site, Richland, Washington

Table I-26. Tank Closure Alternative 4 Operations Rollup Workforce Estimate (continued)

| Activity | Total Hours | Duration | | | Hours per Year | Full-Time Equivalents per Year | Onsite Full-Time Equivalents |
|---|-------------|----------|--------|-------|----------------|--------------------------------|------------------------------|
| | | Start | Finish | Years | | | |
| Routine Operations (OPS_ROUT) | | | | | | | |
| Radiological workers | 9,620,000 | 2006 | 2042 | 37 | 260,000 | 125 | 651 |
| Nonradiological workers | | | | | | | |
| On site | 40,441,000 | 2006 | 2042 | 37 | 1,093,000 | 526 | |
| Off site | 5,735,000 | 2006 | 2042 | 37 | 155,000 | 75 | |
| Retrieval Operations (OPS_RET) | | | | | | | |
| Radiological workers | 12,614 | 2006 | 2042 | 37 | 341 | 1 | 28 |
| Nonradiological workers | | | | | | | |
| On site | 2,056,023 | 2006 | 2042 | 37 | 55,568 | 27 | |
| Off site | 15,977 | 2006 | 2042 | 37 | 432 | 1 | |
| Interim Stabilization/Double-Shell Tanks (OPS_IST) | | | | | | | |
| Radiological workers | 1,358,068 | 2006 | 2042 | 37 | 36,705 | 18 | 44 |
| Nonradiological workers | | | | | | | |
| On site | 1,943,341 | 2006 | 2042 | 37 | 52,523 | 26 | |
| Off site | 2,146,000 | 2006 | 2042 | 37 | 58,000 | 28 | |
| Waste Treatment Plant (OPS_WTP) | | | | | | | |
| Radiological workers | 52,300,000 | 2018 | 2042 | 25 | 2,092,000 | 1,006 | 1,695 |
| Nonradiological workers | | | | | | | |
| On site | 35,800,000 | 2018 | 2042 | 25 | 1,432,000 | 689 | |
| Off site | 5,250 | 2018 | 2042 | 25 | 210 | 1 | |
| Waste Treatment Plant—Cesium and Strontium Capsules (OPS_WTPCSC) | | | | | | | |
| Radiological workers | 2,092,000 | 2043 | 2043 | 1 | 2,092,000 | 1,006 | 1,695 |
| Nonradiological workers | | | | | | | |
| On site | 1,432,000 | 2043 | 2043 | 1 | 1,432,000 | 689 | |
| Off site | 210 | 2043 | 2043 | 1 | 210 | 1 | |
| Cesium and Strontium Capsule Processing Facility (OPS_CSC) | | | | | | | |
| Radiological workers | 103,334 | 2042 | 2043 | 2 | 51,667 | 25 | 25 |
| Nonradiological workers | | | | | | | |
| On site | N/A | | | | | | |
| Off site | N/A | | | | | | |
| Mobile Retrieval System (OPS_MRS) | | | | | | | |
| Radiological workers | 13,871,116 | 2013 | 2042 | 30 | 462,371 | 223 | 425 |
| Nonradiological workers | | | | | | | |
| On site | 12,554,941 | 2013 | 2042 | 30 | 418,498 | 202 | |
| Off site | N/A | | | | | | |
| Vacuum-Based Retrieval System (OPS_VBR) | | | | | | | |
| Radiological workers | 7,667,884 | 2013 | 2042 | 30 | 255,596 | 123 | 235 |
| Nonradiological workers | | | | | | | |
| On site | 6,940,309 | 2013 | 2042 | 30 | 231,344 | 112 | |
| Off site | N/A | | | | | | |
| Chemical Wash System (OPS_CHW) | | | | | | | |
| Radiological workers | 10,769,500 | 2013 | 2042 | 30 | 358,983 | 173 | 330 |
| Nonradiological workers | | | | | | | |
| On site | 9,747,750 | 2013 | 2042 | 30 | 324,925 | 157 | |
| Off site | N/A | | | | | | |

Table I-26. Tank Closure Alternative 4 Operations Rollup Workforce Estimate (continued)

| Activity | Total Hours | Duration | | | Hours per Year | Full-Time Equivalents per Year | Onsite Full-Time Equivalents |
|---|-------------|----------|--------|-------|----------------|--------------------------------|------------------------------|
| | | Start | Finish | Years | | | |
| High-Level Radioactive Waste Melter Interim Storage Facilities (OPS_PAD) | | | | | | | |
| Radiological workers | N/A | 2018 | 2144 | 127 | | | |
| Nonradiological workers | | | | | | | |
| On site | N/A | | | | | | |
| Off site | N/A | | | | | | |
| Contact-Handled Mixed Transuranic Waste Facilities (OPS_CH) | | | | | | | |
| Radiological workers | 200,000 | 2009 | 2010 | 2 | 100,000 | 49 | |
| Nonradiological workers | | | | | | | 49 |
| On site | N/A | | | | | | |
| Off site | N/A | | | | | | |
| Remote-Handled Mixed Transuranic Waste Facility (OPS_RH) | | | | | | | |
| Radiological workers | 1,000,000 | 2015 | 2019 | 5 | 200,000 | 97 | |
| Nonradiological workers | | | | | | | 97 |
| On site | N/A | | | | | | |
| Off site | N/A | | | | | | |
| Transuranic Waste Interim Storage Facility (OPS_TRU) | | | | | | | |
| Radiological workers | N/A | 2009 | 2034 | 26 | | | |
| Nonradiological workers | | | | | | | |
| On site | N/A | | | | | | |
| Off site | N/A | | | | | | |
| Bulk Vitrification Facility (200-West Area) (OPS_BV) | | | | | | | |
| Radiological workers | 3,404,000 | 2018 | 2039 | 22 | 154,727 | 75 | |
| Nonradiological workers | | | | | | | 94 |
| On site | 828,000 | 2018 | 2039 | 22 | 37,636 | 19 | |
| Off site | N/A | | | | | | |
| Solid-Liquid Separations Facility (200-West Area) (OPS_SEPW) | | | | | | | |
| Radiological workers | 2,800,000 | 2018 | 2039 | 22 | 127,273 | 62 | |
| Nonradiological workers | | | | | | | 81 |
| On site | 850,000 | 2018 | 2039 | 22 | 38,636 | 19 | |
| Off site | N/A | | | | | | |
| Cast Stone Facility (200-East Area) (OPS_CG) | | | | | | | |
| Radiological workers | 912,000 | 2018 | 2039 | 22 | 41,455 | 20 | |
| Nonradiological workers | | | | | | | 43 |
| On site | 1,026,000 | 2018 | 2039 | 22 | 46,636 | 23 | |
| Off site | N/A | | | | | | |
| Effluent Treatment Facility Replacement (OPS ETF) | | | | | | | |
| Radiological workers | 6,182,400 | 2006 | 2045 | 40 | 154,560 | 75 | |
| Nonradiological workers | | | | | | | 94 |
| On site | 1,545,600 | 2006 | 2045 | 40 | 38,640 | 19 | |
| Off site | N/A | | | | | | |
| 242-A Evaporator Replacement (OPS_EVA) | | | | | | | |
| Radiological workers | 1,809,137 | 2006 | 2042 | 37 | 48,896 | 24 | |
| Nonradiological workers | | | | | | | 32 |
| On site | 553,280 | 2006 | 2042 | 37 | 14,954 | 8 | |
| Off site | N/A | | | | | | |

Draft Tank Closure and Waste Management Environmental Impact Statement for the
Hanford Site, Richland, Washington

Table I-26. Tank Closure Alternative 4 Operations Rollup Workforce Estimate (continued)

| Activity | Total Hours | Duration | | | Hours per Year | Full-Time Equivalents per Year | Onsite Full-Time Equivalents |
|----------------------------------|--------------------|----------|--------|-------|-------------------|--------------------------------|------------------------------|
| | | Start | Finish | Years | | | |
| Borrow Area C (OPS_CAREA) | | | | | | | |
| Radiological workers | N/A | | | | | | |
| Nonradiological workers | | | | | | | |
| On site | 4,201,800 | 2006 | 2052 | 47 | 89,400 | 43 | 43 |
| Off site | N/A | | | | | | |
| Total | 254,373,594 | | | | 12,212,355 | 5,893 | 5,785 |

Notes and Assumptions:

Total number of offsite full-time equivalents = 108.

Hours worked per year = 2,080.

One full-time equivalent was assumed for activities estimated to require less than 2,080 hours per year.

For OPS_WTP, no allowance was made for full-time equivalents in ramp-up years.

For OPS_BV and CG, no allowance was made for full-time equivalents in ramp up.

Key: N/A=not applicable.

Source: Compiled from SAIC 2007a, 2008.

Table I-27. Tank Closure Alternative 4 Deactivation Rollup Workforce Estimate

| Activity | Total Hours | Duration | | | Hours per Year | Full-Time Equivalents per Year | Onsite Full-Time Equivalents |
|--|-------------|----------|--------|-------|----------------|--------------------------------|------------------------------|
| | | Start | Finish | Years | | | |
| Immobilized High-Level Radioactive Waste Interim Storage Facilities (DEA_ISF) | | | | | | | |
| Radiological workers | N/A | | | | | | |
| Nonradiological workers | | | | | | | |
| On site | 160 | 2067 | 2067 | 1 | 160 | 1 | 1 |
| Off site | N/A | | | | | | |
| Waste Treatment Plant (DEA_WTP) | | | | | | | |
| Radiological workers | 4,193,167 | 2044 | 2045 | 2 | 2,096,583 | 1,008 | |
| Nonradiological workers | | | | | | | 1,700 |
| On site | 2,875,889 | 2044 | 2045 | 2 | 1,437,944 | 692 | |
| Off site | N/A | | | | | | |
| Cesium and Strontium Capsule Processing Facility (DEA_CSC) | | | | | | | |
| Radiological workers | 23,920 | 2044 | 2044 | 1 | 23,920 | 12 | |
| Nonradiological workers | | | | | | | 12 |
| On site | N/A | | | | | | |
| Off site | N/A | | | | | | |
| Mobile Retrieval System (DEA_MRS) | | | | | | | |
| Radiological workers | 1,823,647 | 2013 | 2042 | 30 | 60,788 | 30 | |
| Nonradiological workers | | | | | | | 30 |
| On site | N/A | | | | | | |
| Off site | N/A | | | | | | |
| Vacuum-Based Retrieval System (DEA_VBR) | | | | | | | |
| Radiological workers | 258,100 | 2013 | 2042 | 30 | 8,603 | 5 | |
| Nonradiological workers | | | | | | | 5 |
| On site | N/A | | | | | | |
| Off site | N/A | | | | | | |

Table I–27. Tank Closure Alternative 4 Deactivation Rollup Workforce Estimate (continued)

| Activity | Total Hours | Duration | | | Hours per Year | Full-Time Equivalents per Year | Onsite Full-Time Equivalents |
|---|-------------|----------|--------|-------|----------------|--------------------------------|------------------------------|
| | | Start | Finish | Years | | | |
| Chemical Wash System (DEA_CHW) | | | | | | | |
| Radiological workers | 144,000 | 2013 | 2042 | 30 | 4,800 | 3 | 3 |
| Nonradiological workers | | | | | | | |
| On site | N/A | | | | | | |
| Off site | N/A | | | | | | |
| Contact-Handled Mixed Transuranic Waste Facilities (DEA_CH) | | | | | | | |
| Radiological workers | 100,000 | 2011 | 2012 | 2 | 50,000 | 25 | 25 |
| Nonradiological workers | | | | | | | |
| On site | N/A | | | | | | |
| Off site | N/A | | | | | | |
| Remote-Handled Mixed Transuranic Waste Facility (DEA_RH) | | | | | | | |
| Radiological workers | 200,000 | 2020 | 2021 | 2 | 100,000 | 49 | 49 |
| Nonradiological workers | | | | | | | |
| On site | N/A | | | | | | |
| Off site | N/A | | | | | | |
| Transuranic Waste Interim Storage Facility (DEA_TRU) | | | | | | | |
| Radiological workers | N/A | | | | | | 1 |
| Nonradiological workers | | | | | | | |
| On site | 80 | 2035 | 2035 | 1 | 80 | 1 | |
| Off site | N/A | | | | | | |
| Bulk Vitrification Facility (200-West Area) (DEA_BV) | | | | | | | |
| Radiological workers | 148,000 | 2040 | 2041 | 2 | 74,000 | 36 | 45 |
| Nonradiological workers | | | | | | | |
| On site | 36,000 | 2040 | 2041 | 2 | 18,000 | 9 | |
| Off site | N/A | | | | | | |
| Solid-Liquid Separations Facility (200-West Area) (DEA_SEPW) | | | | | | | |
| Radiological workers | 122,000 | 2040 | 2041 | 2 | 61,000 | 30 | 39 |
| Nonradiological workers | | | | | | | |
| On site | 37,000 | 2040 | 2041 | 2 | 18,500 | 9 | |
| Off site | N/A | | | | | | |
| Cast Stone Facility (200-East Area) (DEA_CG) | | | | | | | |
| Radiological workers | 48,000 | 2040 | 2041 | 2 | 24,000 | 12 | 25 |
| Nonradiological workers | | | | | | | |
| On site | 54,000 | 2040 | 2041 | 2 | 27,000 | 13 | |
| Off site | N/A | | | | | | |
| Effluent Treatment Facility (Original) (DEA_ETFO) | | | | | | | |
| Radiological workers | 77,280 | 2026 | 2026 | 1 | 77,280 | 38 | 48 |
| Nonradiological workers | | | | | | | |
| On site | 19,320 | 2026 | 2026 | 1 | 19,320 | 10 | |
| Off site | N/A | | | | | | |
| Effluent Treatment Facility Replacement (DEA ETF) | | | | | | | |
| Radiological workers | 77,280 | 2046 | 2046 | 1 | 77,280 | 38 | 48 |
| Nonradiological workers | | | | | | | |
| On site | 19,320 | 2046 | 2046 | 1 | 19,320 | 10 | |
| Off site | N/A | | | | | | |

Draft Tank Closure and Waste Management Environmental Impact Statement for the
Hanford Site, Richland, Washington

Table I-27. Tank Closure Alternative 4 Deactivation Rollup Workforce Estimate (continued)

| Activity | Total Hours | Duration | | | Hours per Year | Full-Time Equivalents per Year | Onsite Full-Time Equivalents |
|---|-------------------|----------|--------|-------|------------------|--------------------------------|------------------------------|
| | | Start | Finish | Years | | | |
| 242-A Evaporator (Original) (DEA_EVAO) | | | | | | | |
| Radiological workers | 24,448 | 2018 | 2018 | 1 | 24,448 | 12 | 16 |
| Nonradiological workers | | | | | | | |
| On site | 7,477 | 2018 | 2018 | 1 | 7,477 | 4 | |
| Off site | N/A | | | | | | |
| 242-A Evaporator Replacement (DEA_EVA) | | | | | | | |
| Radiological workers | 24,448 | 2043 | 2043 | 1 | 24,448 | 12 | 16 |
| Nonradiological workers | | | | | | | |
| On site | 7,477 | 2043 | 2043 | 1 | 7,477 | 4 | |
| Off site | N/A | | | | | | |
| Total | 10,321,012 | | | | 4,262,428 | 2,063 | 2,063 |

Notes and Assumptions:

Total number of offsite full-time equivalents = 0.

Hours worked per year = 2,080.

One full-time equivalent was assumed for activities estimated to require less than 2,080 hours per year.

Key: N/A=not applicable.

Source: Compiled from SAIC 2007a, 2008.

Table I-28. Tank Closure Alternative 4 Closure Rollup Workforce Estimate

| Activity | Total Hours | Duration | | | Hours per Year | Full-Time Equivalents per Year | Onsite Full-Time Equivalents |
|--|-------------|----------|--------|-------|----------------|--------------------------------|------------------------------|
| | | Start | Finish | Years | | | |
| Tank-Filling Grout Facility Construction (CLO_CONGRO) | | | | | | | |
| Radiological workers | 480 | 2031 | 2032 | 2 | 240 | 1 | 5 |
| Nonradiological workers | | | | | | | |
| On site | 13,360 | 2031 | 2032 | 2 | 6,680 | 4 | |
| Off site | 4,160 | 2031 | 2032 | 2 | 2,080 | 1 | |
| Tank-Filling Grout Facility Operations (CLO_OPSGRO) | | | | | | | |
| Radiological workers | 54,400 | 2033 | 2042 | 10 | 5,440 | 3 | 11 |
| Nonradiological workers | | | | | | | |
| On site | 148,224 | 2033 | 2042 | 10 | 14,822 | 8 | |
| Off site | 104,000 | 2033 | 2042 | 10 | 10,400 | 5 | |
| Tank-Filling Grout Facility Deactivation (CLO_DEAGRO) | | | | | | | |
| Radiological workers | 480 | 2043 | 2043 | 1 | 480 | 1 | 4 |
| Nonradiological workers | | | | | | | |
| On site | 4,320 | 2043 | 2043 | 1 | 4,320 | 3 | |
| Off site | 1,040 | 2043 | 2043 | 1 | 1,040 | 1 | |
| Ancillary Equipment Grouting (CLO_ANCFIL) | | | | | | | |
| Radiological workers | 262,480 | 2012 | 2032 | 21 | 12,499 | 7 | 7 |
| Nonradiological workers | | | | | | | |
| On site | N/A | | | | | | |
| Off site | N/A | | | | | | |
| Containment Structure Construction (CLO_CONCS) | | | | | | | |
| Radiological workers | 2,000 | 2018 | 2021 | 4 | 500 | 1 | 4 |
| Nonradiological workers | | | | | | | |
| On site | 20,000 | 2018 | 2021 | 4 | 5,000 | 3 | |
| Off site | N/A | | | | | | |

Table I–28. Tank Closure Alternative 4 Closure Rollup Workforce Estimate (continued)

| Activity | Total Hours | Duration | | | Hours per Year | Full-Time Equivalents per Year | Onsite Full-Time Equivalents |
|---|-------------|----------|--------|-------|----------------|--------------------------------|------------------------------|
| | | Start | Finish | Years | | | |
| Containment Structure Deactivation (CLO_DEACS) | | | | | | | |
| Radiological workers | 2,000 | 2042 | 2044 | 3 | 667 | 1 | 5 |
| Nonradiological workers | | | | | | | |
| On site | 20,000 | 2042 | 2044 | 3 | 6,667 | 4 | |
| Off site | N/A | | | | | | |
| Modified Resource Conservation and Recovery Act Subtitle C Barrier Construction (CLO_RCRA) | | | | | | | |
| Radiological workers | 800,000 | 2038 | 2044 | 7 | 114,286 | 55 | 220 |
| Nonradiological workers | | | | | | | |
| On site | 2,400,000 | 2038 | 2044 | 7 | 342,857 | 165 | |
| Off site | N/A | | | | | | |
| Decontamination and Decommissioning of 10 Selected Facilities (CLO_D&DTEN) | | | | | | | |
| Radiological workers | 44,418 | 2018 | 2028 | 11 | 4,038 | 2 | 9 |
| Nonradiological workers | | | | | | | |
| On site | 146,679 | 2018 | 2028 | 11 | 13,334 | 7 | |
| Off site | 78,970 | 2018 | 2028 | 11 | 7,179 | 4 | |
| Postclosure Care (CLO_POST) | | | | | | | |
| Radiological workers | N/A | | | | | | 3 |
| Nonradiological workers | | | | | | | |
| On site | 471,262 | 2045 | 2144 | 100 | 4,713 | 3 | |
| Off site | N/A | | | | | | |
| Removal of BX Tank Farm Tanks, Ancillary Equipment, and Soils (CLO_REMTBX) | | | | | | | |
| Radiological workers | 519,550 | 2022 | 2033 | 12 | 43,296 | 21 | 55 |
| Nonradiological workers | | | | | | | |
| On site | 823,871 | 2022 | 2033 | 12 | 68,656 | 34 | |
| Off site | N/A | | | | | | |
| Removal of Deep Soil–BX Tank Farm (CLO_REMSBX) | | | | | | | |
| Radiological workers | 293,483 | 2034 | 2041 | 8 | 36,685 | 18 | 39 |
| Nonradiological workers | | | | | | | |
| On site | 339,410 | 2034 | 2041 | 8 | 42,426 | 21 | |
| Off site | N/A | | | | | | |
| Removal of SX Tank Farm Tanks, Ancillary Equipment, and Soils (CLO_REMTSX) | | | | | | | |
| Radiological workers | 649,437 | 2022 | 2033 | 12 | 54,120 | 27 | 69 |
| Nonradiological workers | | | | | | | |
| On site | 1,029,839 | 2022 | 2033 | 12 | 85,820 | 42 | |
| Off site | N/A | | | | | | |
| Removal of Deep Soil–SX Tank Farm (CLO_REMSXX) | | | | | | | |
| Radiological workers | 895,895 | 2034 | 2041 | 8 | 111,987 | 54 | 117 |
| Nonradiological workers | | | | | | | |
| On site | 1,036,093 | 2034 | 2041 | 8 | 129,512 | 63 | |
| Off site | N/A | | | | | | |
| Preprocessing Facility Construction (CLO_CONPPF) | | | | | | | |
| Radiological workers | N/A | | | | | | 2,389 |
| Nonradiological workers | | | | | | | |
| On site | 14,904,804 | 2019 | 2021 | 3 | 4,968,268 | 2,389 | |
| Off site | 5,035,407 | 2019 | 2021 | 3 | 1,678,469 | 807 | |

Draft Tank Closure and Waste Management Environmental Impact Statement for the
Hanford Site, Richland, Washington

Table I–28. Tank Closure Alternative 4 Closure Rollup Workforce Estimate (continued)

| Activity | Total Hours | Duration | | | Hours per Year | Full-Time Equivalents per Year | Onsite Full-Time Equivalents |
|---|-------------------|----------|--------|-------|------------------|--------------------------------|------------------------------|
| | | Start | Finish | Years | | | |
| Preprocessing Facility Operations (CLO_OPSPPF) | | | | | | | |
| Radiological workers | 3,891,525 | 2022 | 2042 | 21 | 185,311 | 90 | 93 |
| Nonradiological workers | | | | | | | |
| On site | 119,739 | 2022 | 2042 | 21 | 5,702 | 3 | |
| Off site | N/A | | | | | | |
| Preprocessing Facility Deactivation (CLO_DEAPPF) | | | | | | | |
| Radiological workers | 194,576 | 2043 | 2043 | 1 | 194,576 | 94 | 97 |
| Nonradiological workers | | | | | | | |
| On site | 5,987 | 2043 | 2043 | 1 | 5,987 | 3 | |
| Off site | N/A | | | | | | |
| Total | 34,317,889 | | | | 8,168,056 | 3,945 | 3,127 |

Notes and Assumptions:

Total number of offsite full-time equivalents = 818.

Hours worked per year = 2,080.

One full-time equivalent was assumed for activities estimated to require less than 2,080 hours per year.

Key: N/A=not applicable.

Source: Compiled from SAIC 2007a, 2008.

I.2.8 Tank Closure Alternative 5: Expanded WTP Vitrification with Supplemental Treatment Technologies; Landfill Closure

Table I–29. Tank Closure Alternative 5 Construction Rollup Workforce Estimate

| Activity | Total Hours | Duration | | | Hours per Year | Full-Time Equivalents per Year | Onsite Full-Time Equivalents |
|--|-------------|----------|--------|-------|----------------|--------------------------------|------------------------------|
| | | Start | Finish | Years | | | |
| Canister Storage Building (CON_CSB) | | | | | | | |
| Radiological workers | 115,500 | 2006 | 2016 | 11 | 10,500 | 6 | 12 |
| Nonradiological workers | | | | | | | |
| On site | 135,929 | 2006 | 2016 | 11 | 12,357 | 6 | |
| Off site | 50,286 | 2006 | 2016 | 11 | 4,571 | 3 | |
| Immobilized High-Level Radioactive Waste Shipping/Transfer Facility (CON_STF) | | | | | | | |
| Radiological workers | N/A | | | | | | 380 |
| Nonradiological workers | | | | | | | |
| Onsite construction | 1,757,000 | 2011 | 2013 | 3 | 585,667 | 282 | |
| Onsite exempt | 610,000 | 2011 | 2013 | 3 | 203,333 | 98 | |
| Offsite design | 748,000 | 2011 | 2013 | 3 | 249,333 | 120 | |
| Immobilized High-Level Radioactive Waste Interim Storage Module (CON_ISM) | | | | | | | |
| Radiological workers | N/A | | | | | | 232 |
| Nonradiological workers | | | | | | | |
| Onsite construction | 1,781,106 | 2014 | 2019 | 6 | 296,851 | 143 | |
| Onsite exempt | 1,100,000 | 2014 | 2019 | 6 | 183,333 | 89 | |
| Offsite design | 1,350,000 | 2014 | 2019 | 6 | 225,000 | 109 | |
| Other Infrastructure Upgrades (CON_OIU) | | | | | | | |
| Radiological workers | 782,094 | 2006 | 2034 | 29 | 26,969 | 13 | 45 |
| Nonradiological workers | | | | | | | |
| On site | 1,918,531 | 2006 | 2034 | 29 | 66,156 | 32 | |
| Off site | 743,125 | 2006 | 2034 | 29 | 25,625 | 13 | |

Table I-29. Tank Closure Alternative 5 Construction Rollup Workforce Estimate (continued)

| Activity | Total Hours | Duration | | | Hours per Year | Full-Time Equivalents per Year | Onsite Full-Time Equivalents |
|---|-------------|----------|--------|-------|----------------|--------------------------------|------------------------------|
| | | Start | Finish | Years | | | |
| Tank Upgrades (CON_TU) | | | | | | | |
| Radiological workers | 1,195,652 | 2006 | 2025 | 20 | 59,783 | 29 | 104 |
| Nonradiological workers | | | | | | | |
| On site | 3,112,174 | 2006 | 2025 | 20 | 155,609 | 75 | |
| Off site | 1,179,130 | 2006 | 2025 | 20 | 58,957 | 29 | |
| Underground Transfer Lines (CON_UTL) | | | | | | | |
| Radiological workers | N/A | | | | | | 61 |
| Nonradiological workers | | | | | | | |
| On site | 126,005 | 2009 | 2009 | 1 | 126,005 | 61 | |
| Off site | 17,400 | 2009 | 2009 | 1 | 17,400 | 9 | |
| Waste Treatment Plant (CON_WTP) | | | | | | | |
| Radiological workers | N/A | | | | | | 906 |
| Nonradiological workers | | | | | | | |
| On site | 22,612,500 | 2006 | 2017 | 12 | 1,884,375 | 906 | |
| Off site | 7,537,500 | 2006 | 2017 | 12 | 628,125 | 302 | |
| Cesium and Strontium Capsule Processing Facility (CON_CSC) | | | | | | | |
| Radiological workers | N/A | | | | | | 190 |
| Nonradiological workers | | | | | | | |
| On site | 1,578,029 | 2029 | 2032 | 4 | 394,507 | 190 | |
| Off site | 465,683 | 2029 | 2032 | 4 | 116,421 | 56 | |
| Waste Receiver Facilities (CON_WRF) | | | | | | | |
| Radiological workers | N/A | | | | | | 454 |
| Nonradiological workers | | | | | | | |
| On site | 4,716,000 | 2013 | 2017 | 5 | 943,200 | 454 | |
| Off site | 1,696,000 | 2013 | 2017 | 5 | 339,200 | 164 | |
| Tank Risers (CON_RIS) | | | | | | | |
| Radiological workers | 172,920 | 2013 | 2016 | 4 | 43,230 | 21 | 50 |
| Nonradiological workers | | | | | | | |
| On site | 233,180 | 2013 | 2016 | 4 | 58,295 | 29 | |
| Off site | N/A | | | | | | |
| Double-Shell Tank Replacement (CON_DST) | | | | | | | |
| Radiological workers | N/A | | | | | | 144 |
| Nonradiological workers | | | | | | | |
| On site | 1,790,000 | 2014 | 2019 | 6 | 298,333 | 144 | |
| Off site | 644,000 | 2014 | 2019 | 6 | 107,333 | 52 | |
| Sulfate Removal Facility (CON_SUL) | | | | | | | |
| Radiological workers | N/A | | | | | | 722 |
| Nonradiological workers | | | | | | | |
| On site | 3,001,782 | 2016 | 2017 | 2 | 1,500,891 | 722 | |
| Off site | 1,014,116 | 2016 | 2017 | 2 | 507,058 | 244 | |
| Modified Sluicing Retrieval System (CON_MS) | | | | | | | |
| Radiological workers | 2,781,081 | 2013 | 2033 | 21 | 132,432 | 64 | 165 |
| Nonradiological workers | | | | | | | |
| On site | 4,392,009 | 2013 | 2033 | 21 | 209,143 | 101 | |
| Off site | 1,545,264 | 2013 | 2033 | 21 | 73,584 | 36 | |

Draft Tank Closure and Waste Management Environmental Impact Statement for the
Hanford Site, Richland, Washington

Table I-29. Tank Closure Alternative 5 Construction Rollup Workforce Estimate (continued)

| Activity | Total Hours | Duration | | | Hours per Year | Full-Time Equivalents per Year | Onsite Full-Time Equivalents |
|---|-------------|----------|--------|-------|----------------|--------------------------------|------------------------------|
| | | Start | Finish | Years | | | |
| Mobile Retrieval System (CON_MRS) | | | | | | | |
| Radiological workers | 8,098,800 | 2013 | 2023 | 11 | 736,255 | 354 | 745 |
| Nonradiological workers | | | | | | | |
| On site | 8,940,660 | 2013 | 2023 | 11 | 812,787 | 391 | |
| Off site | 4,794,060 | 2013 | 2023 | 11 | 435,824 | 210 | |
| Vacuum-Based Retrieval System (CON_VBR) | | | | | | | |
| Radiological workers | 11,196,200 | 2024 | 2033 | 10 | 1,119,620 | 539 | 1,114 |
| Nonradiological workers | | | | | | | |
| On site | 11,957,150 | 2024 | 2033 | 10 | 1,195,715 | 575 | |
| Off site | 6,817,400 | 2024 | 2033 | 10 | 681,740 | 328 | |
| High-Level Radioactive Waste Melter Interim Storage Facilities (CON_PAD) | | | | | | | |
| Radiological workers | N/A | | | | | | 1 |
| Nonradiological workers | | | | | | | |
| On site | 2,808 | 2015 | 2016 | 2 | 1,404 | 1 | |
| Off site | N/A | | | | | | |
| Contact-Handled Mixed Transuranic Waste Facilities (CON_CH) | | | | | | | |
| Radiological workers | N/A | | | | | | 60 |
| Nonradiological workers | | | | | | | |
| On site | 124,754 | 2008 | 2008 | 1 | 124,754 | 60 | |
| Off site | 42,147 | 2008 | 2008 | 1 | 42,147 | 21 | |
| Remote-Handled Mixed Transuranic Waste Facility (CON_RH) | | | | | | | |
| Radiological workers | N/A | | | | | | 37 |
| Nonradiological workers | | | | | | | |
| On site | 153,506 | 2013 | 2014 | 2 | 76,753 | 37 | |
| Off site | 51,860 | 2013 | 2014 | 2 | 25,930 | 13 | |
| Transuranic Waste Interim Storage Facility (CON_TRU) | | | | | | | |
| Radiological workers | N/A | | | | | | 4 |
| Nonradiological workers | | | | | | | |
| On site | 16,400 | 2008 | 2009 | 2 | 8,200 | 4 | |
| Off site | N/A | | | | | | |
| Bulk Vitrification Facility (200-West Area) (CON_BV) | | | | | | | |
| Radiological workers | N/A | | | | | | 165 |
| Nonradiological workers | | | | | | | |
| On site | 684,068 | 2016 | 2017 | 2 | 342,034 | 165 | |
| Off site | 231,104 | 2016 | 2017 | 2 | 115,552 | 56 | |
| Solid-Liquid Separations Facility (200-West Area) (CON_SEPW) | | | | | | | |
| Radiological workers | N/A | | | | | | 38 |
| Nonradiological workers | | | | | | | |
| On site | 156,349 | 2016 | 2017 | 2 | 78,174 | 38 | |
| Off site | 52,821 | 2016 | 2017 | 2 | 26,410 | 13 | |
| Cast Stone Facility (200-East Area) (CON_CG) | | | | | | | |
| Radiological workers | N/A | | | | | | 113 |
| Nonradiological workers | | | | | | | |
| On site | 466,772 | 2016 | 2017 | 2 | 233,386 | 113 | |
| Off site | 157,693 | 2015 | 2016 | 2 | 78,847 | 38 | |

Table I-29. Tank Closure Alternative 5 Construction Rollup Workforce Estimate (continued)

| Activity | Total Hours | Duration | | | Hours per Year | Full-Time Equivalents per Year | Onsite Full-Time Equivalents |
|--|--------------------|----------|--------|-------|-------------------|--------------------------------|------------------------------|
| | | Start | Finish | Years | | | |
| Effluent Treatment Facility Replacement (CON ETF) | | | | | | | |
| Radiological workers | N/A | | | | | | |
| Nonradiological workers | | | | | | | |
| On site | 2,047,400 | 2023 | 2025 | 3 | 682,467 | 329 | 329 |
| Off site | 703,895 | 2023 | 2025 | 3 | 234,632 | 113 | |
| 242-A Evaporator Replacement (CON EVA) | | | | | | | |
| Radiological workers | N/A | | | | | | |
| Nonradiological workers | | | | | | | |
| On site | 635,400 | 2015 | 2017 | 3 | 211,800 | 102 | 102 |
| Off site | 217,918 | 2015 | 2017 | 3 | 72,639 | 35 | |
| Total | 128,451,160 | | | | 16,880,647 | 8,137 | 6,069 |

Notes and Assumptions:

Total number of offsite full-time equivalents = 2,088.

Hours worked per year = 2,080.

One full-time equivalent was assumed for activities estimated to require less than 2,080 hours per year.

Key: N/A=not applicable.

Source: Compiled from SAIC 2007a, 2008.

Table I-30. Tank Closure Alternative 5 Operations Rollup Workforce Estimate

| Activity | Total Hours | Duration | | | Hours per Year | Full-Time Equivalents per Year | Onsite Full-Time Equivalents |
|--|-------------|----------|--------|-------|----------------|--------------------------------|------------------------------|
| | | Start | Finish | Years | | | |
| Immobilized High-Level Radioactive Waste Interim Storage Facilities (OPS_ISF) | | | | | | | |
| Radiological workers | 7,779,436 | 2018 | 2066 | 49 | 158,764 | 77 | |
| Nonradiological workers | | | | | | | 120 |
| On site | 4,351,200 | 2018 | 2066 | 49 | 88,800 | 43 | |
| Off site | N/A | | | | | | |
| Other Infrastructure Upgrades (OPS_OIU) | | | | | | | |
| Radiological workers | 33,091 | 2006 | 2033 | 28 | 1,182 | 1 | |
| Nonradiological workers | | | | | | | 4 |
| On site | 121,333 | 2006 | 2033 | 28 | 4,333 | 3 | |
| Off site | 86,545 | 2006 | 2033 | 28 | 3,091 | 2 | |
| Routine Operations (OPS_ROUT) | | | | | | | |
| Radiological workers | 7,280,000 | 2006 | 2033 | 28 | 260,000 | 125 | |
| Nonradiological workers | | | | | | | 651 |
| On site | 30,604,000 | 2006 | 2033 | 28 | 1,093,000 | 526 | |
| Off site | 4,340,000 | 2006 | 2033 | 28 | 155,000 | 75 | |
| Retrieval Operations (OPS_RET) | | | | | | | |
| Radiological workers | 9,545 | 2006 | 2033 | 28 | 341 | 1 | |
| Nonradiological workers | | | | | | | 28 |
| On site | 1,555,909 | 2006 | 2033 | 28 | 55,568 | 27 | |
| Off site | 12,091 | 2006 | 2033 | 28 | 432 | 1 | |
| Interim Stabilization/Double-Shell Tanks (OPS_IST) | | | | | | | |
| Radiological workers | 1,027,727 | 2006 | 2033 | 28 | 36,705 | 18 | |
| Nonradiological workers | | | | | | | 44 |
| On site | 1,470,636 | 2006 | 2033 | 28 | 52,523 | 26 | |
| Off site | 1,624,000 | 2006 | 2033 | 28 | 58,000 | 28 | |

Draft Tank Closure and Waste Management Environmental Impact Statement for the
Hanford Site, Richland, Washington

Table I-30. Tank Closure Alternative 5 Operations Rollup Workforce Estimate (continued)

| Activity | Total Hours | Duration | | | Hours per Year | Full-Time Equivalents per Year | Onsite Full-Time Equivalents |
|---|-------------|----------|--------|-------|----------------|--------------------------------|------------------------------|
| | | Start | Finish | Years | | | |
| Waste Treatment Plant (OPS_WTP) | | | | | | | |
| Radiological workers | 33,545,000 | 2018 | 2033 | 16 | 2,096,563 | 1,008 | 1,700 |
| Nonradiological workers | | | | | | | |
| On site | 23,007,000 | 2018 | 2033 | 16 | 1,437,938 | 692 | |
| Off site | 3,000 | 2018 | 2033 | 16 | 188 | 1 | |
| Waste Treatment Plant—Cesium and Strontium Capsules (OPS_WTPCSC) | | | | | | | |
| Radiological workers | 2,097,000 | 2034 | 2034 | 1 | 2,097,000 | 1,009 | 1,701 |
| Nonradiological workers | | | | | | | |
| On site | 1,438,000 | 2034 | 2034 | 1 | 1,438,000 | 692 | |
| Off site | N/A | | | | | | |
| Cesium and Strontium Capsule Processing Facility (OPS_CSC) | | | | | | | |
| Radiological workers | 103,334 | 2033 | 2034 | 2 | 51,667 | 25 | 25 |
| Nonradiological workers | | | | | | | |
| On site | N/A | | | | | | |
| Off site | N/A | | | | | | |
| Double-Shell Tank Replacements (OPS_DST) | | | | | | | |
| Radiological workers | 2,143 | 2020 | 2033 | 14 | 153 | 1 | 13 |
| Nonradiological workers | | | | | | | |
| On site | 349,286 | 2020 | 2033 | 14 | 24,949 | 12 | |
| Off site | 2,714 | 2020 | 2033 | 14 | 194 | 1 | |
| Sulfate Removal Facility (OPS_SUL) | | | | | | | |
| Radiological workers | 6,283,000 | 2018 | 2033 | 16 | 392,688 | 189 | 236 |
| Nonradiological workers | | | | | | | |
| On site | 1,558,000 | 2018 | 2033 | 16 | 97,375 | 47 | |
| Off site | N/A | | | | | | |
| Modified Sluicing Retrieval System (OPS_MS) | | | | | | | |
| Radiological workers | 4,176,257 | 2013 | 2033 | 21 | 198,869 | 96 | 159 |
| Nonradiological workers | | | | | | | |
| On site | 2,730,565 | 2013 | 2033 | 21 | 130,027 | 63 | |
| Off site | N/A | | | | | | |
| Mobile Retrieval System (OPS_MRS) | | | | | | | |
| Radiological workers | 5,169,360 | 2013 | 2023 | 11 | 469,942 | 226 | 431 |
| Nonradiological workers | | | | | | | |
| On site | 4,678,860 | 2013 | 2023 | 11 | 425,351 | 205 | |
| Off site | N/A | | | | | | |
| Vacuum-Based Retrieval System (OPS_VBR) | | | | | | | |
| Radiological workers | 7,667,884 | 2024 | 2033 | 10 | 766,788 | 369 | 703 |
| Nonradiological workers | | | | | | | |
| On site | 6,940,309 | 2024 | 2033 | 10 | 694,031 | 334 | |
| Off site | N/A | | | | | | |
| High-Level Radioactive Waste Melter Interim Storage Facilities (OPS_PAD) | | | | | | | |
| Radiological workers | N/A | 2018 | 2139 | 122 | | | |
| Nonradiological workers | | | | | | | |
| On site | N/A | | | | | | |
| Off site | N/A | | | | | | |

Table I-30. Tank Closure Alternative 5 Operations Rollup Workforce Estimate (*continued*)

| Activity | Total Hours | Duration | | | Hours per Year | Full-Time Equivalents per Year | Onsite Full-Time Equivalents |
|---|-------------|----------|--------|-------|----------------|--------------------------------|------------------------------|
| | | Start | Finish | Years | | | |
| Contact-Handled Mixed Transuranic Waste Facilities (OPS_CH) | | | | | | | |
| Radiological workers | 200,000 | 2009 | 2010 | 2 | 100,000 | 49 | 49 |
| Nonradiological workers | | | | | | | |
| On site | N/A | | | | | | |
| Off site | N/A | | | | | | |
| Remote-Handled Mixed Transuranic Waste Facility (OPS_RH) | | | | | | | |
| Radiological workers | 1,000,000 | 2015 | 2019 | 5 | 200,000 | 97 | 97 |
| Nonradiological workers | | | | | | | |
| On site | N/A | | | | | | |
| Off site | N/A | | | | | | |
| Transuranic Waste Interim Storage Facility (OPS_TRU) | | | | | | | |
| Radiological workers | N/A | 2009 | 2034 | 26 | | | |
| Nonradiological workers | | | | | | | |
| On site | N/A | | | | | | |
| Off site | N/A | | | | | | |
| Bulk Vitrification Facility (200-West Area) (OPS_BV) | | | | | | | |
| Radiological workers | 3,404,000 | 2018 | 2033 | 16 | 212,750 | 103 | 128 |
| Nonradiological workers | | | | | | | |
| On site | 828,000 | 2018 | 2033 | 16 | 51,750 | 25 | |
| Off site | N/A | | | | | | |
| Solid-Liquid Separations Facility (200-West Area) (OPS_SEPW) | | | | | | | |
| Radiological workers | 2,800,000 | 2018 | 2033 | 16 | 175,000 | 85 | 111 |
| Nonradiological workers | | | | | | | |
| On site | 850,000 | 2018 | 2033 | 16 | 53,125 | 26 | |
| Off site | N/A | | | | | | |
| Cast Stone Facility (200-East Area) (OPS_CG) | | | | | | | |
| Radiological workers | 912,000 | 2018 | 2033 | 16 | 57,000 | 28 | 59 |
| Nonradiological workers | | | | | | | |
| On site | 1,026,000 | 2018 | 2033 | 16 | 64,125 | 31 | |
| Off site | N/A | | | | | | |
| Effluent Treatment Facility Replacement (OPS ETF) | | | | | | | |
| Radiological workers | 4,791,360 | 2006 | 2036 | 31 | 154,560 | 75 | 94 |
| Nonradiological workers | | | | | | | |
| On site | 1,197,840 | 2006 | 2036 | 31 | 38,640 | 19 | |
| Off site | N/A | | | | | | |
| 242-A Evaporator Replacement (OPS_EVA) | | | | | | | |
| Radiological workers | 1,417,972 | 2006 | 2034 | 29 | 48,896 | 24 | 32 |
| Nonradiological workers | | | | | | | |
| On site | 433,652 | 2006 | 2034 | 29 | 14,954 | 8 | |
| Off site | N/A | | | | | | |

Draft Tank Closure and Waste Management Environmental Impact Statement for the
Hanford Site, Richland, Washington

Table I-30. Tank Closure Alternative 5 Operations Rollup Workforce Estimate (continued)

| Activity | Total Hours | Duration | | | Hours per Year | Full-Time Equivalents per Year | Onsite Full-Time Equivalents |
|----------------------------------|--------------------|----------|--------|-------|-------------------|--------------------------------|------------------------------|
| | | Start | Finish | Years | | | |
| Borrow Area C (OPS_CAREA) | | | | | | | |
| Radiological workers | N/A | | | | | | |
| Nonradiological workers | | | | | | | |
| On site | 4,201,800 | 2006 | 2052 | 47 | 89,400 | 43 | 43 |
| Off site | N/A | | | | | | |
| Total | 183,109,851 | | | | 13,549,659 | 6,536 | 6,428 |

Notes and Assumptions:

Total number of offsite full-time equivalents = 108.

Hours worked per year = 2,080.

One full-time equivalent was assumed for activities estimated to require less than 2,080 hours per year.

For OPS_WTP, no allowance was made for full-time equivalents in ramp-up years.

For OPS_WTP, SUL, BV and CG, no allowance was made for full-time equivalents in ramp up.

Key: N/A=not applicable.

Source: Compiled from SAIC 2007a, 2008.

Table I-31. Tank Closure Alternative 5 Deactivation Rollup Workforce Estimate

| Activity | Total Hours | Duration | | | Hours per Year | Full-Time Equivalents per year | Onsite Full-Time Equivalents |
|--|-------------|----------|--------|-------|----------------|--------------------------------|------------------------------|
| | | Start | Finish | Years | | | |
| Immobilized High-Level Radioactive Waste Interim Storage Facilities (DEA_ISF) | | | | | | | |
| Radiological workers | N/A | | | | | | |
| Nonradiological workers | | | | | | | |
| On site | 160 | 2067 | 2067 | 1 | 160 | 1 | 1 |
| Off site | N/A | | | | | | |
| Waste Treatment Plant (DEA_WTP) | | | | | | | |
| Radiological workers | 4,190,000 | 2035 | 2036 | 2 | 2,095,000 | 1,008 | |
| Nonradiological workers | | | | | | | 1,701 |
| On site | 2,880,000 | 2035 | 2036 | 2 | 1,440,000 | 693 | |
| Off site | N/A | | | | | | |
| Cesium and Strontium Capsule Processing Facility (DEA_CSC) | | | | | | | |
| Radiological workers | 23,920 | 2035 | 2035 | 1 | 23,920 | 12 | |
| Nonradiological workers | | | | | | | 12 |
| On site | N/A | | | | | | |
| Off site | N/A | | | | | | |
| Modified Sluicing Retrieval System (DEA_MS) | | | | | | | |
| Radiological workers | 210,386 | 2013 | 2033 | 21 | 10,018 | 5 | |
| Nonradiological workers | | | | | | | 5 |
| On site | N/A | | | | | | |
| Off site | N/A | | | | | | |
| Mobile Retrieval System (DEA_MRS) | | | | | | | |
| Radiological workers | 679,620 | 2013 | 2023 | 11 | 61,784 | 30 | |
| Nonradiological workers | | | | | | | 30 |
| On site | N/A | | | | | | |
| Off site | N/A | | | | | | |

Table I–31. Tank Closure Alternative 5 Deactivation Rollup Workforce Estimate (continued)

| Activity | Total Hours | Duration | | | Hours per Year | Full-Time Equivalents per year | Onsite Full-Time Equivalents |
|---|-------------|----------|--------|-------|----------------|--------------------------------|------------------------------|
| | | Start | Finish | Years | | | |
| Vacuum-Based Retrieval System (DEA_VBR) | | | | | | | |
| Radiological workers | 258,100 | 2024 | 2033 | 10 | 25,810 | 13 | 13 |
| Nonradiological workers | | | | | | | |
| On site | N/A | | | | | | |
| Off site | N/A | | | | | | |
| Sulfate Removal Facility (DEA_SUL) | | | | | | | |
| Radiological workers | 661,368 | 2034 | 2035 | 2 | 330,684 | 159 | 199 |
| Nonradiological workers | | | | | | | |
| On site | 164,000 | 2034 | 2035 | 2 | 82,000 | 40 | |
| Off site | N/A | | | | | | |
| Contact-Handled Mixed Transuranic Waste Facilities (DEA_CH) | | | | | | | |
| Radiological workers | 100,000 | 2011 | 2012 | 2 | 50,000 | 25 | 25 |
| Nonradiological workers | | | | | | | |
| On site | N/A | | | | | | |
| Off site | N/A | | | | | | |
| Remote-Handled Mixed Transuranic Waste Facility (DEA_RH) | | | | | | | |
| Radiological workers | 200,000 | 2020 | 2021 | 2 | 100,000 | 49 | 49 |
| Nonradiological workers | | | | | | | |
| On site | N/A | | | | | | |
| Off site | N/A | | | | | | |
| Transuranic Waste Interim Storage Facility (DEA_TRU) | | | | | | | |
| Radiological workers | N/A | | | | | | 1 |
| Nonradiological workers | | | | | | | |
| On site | 80 | 2035 | 2035 | 1 | 80 | 1 | |
| Off site | N/A | | | | | | |
| Bulk Vitrification Facility (200-West Area) (DEA_BV) | | | | | | | |
| Radiological workers | 148,000 | 2034 | 2035 | 2 | 74,000 | 36 | 45 |
| Nonradiological workers | | | | | | | |
| On site | 36,000 | 2034 | 2035 | 2 | 18,000 | 9 | |
| Off site | N/A | | | | | | |
| Solid-Liquid Separations Facility (200-West Area) (DEA_SEPW) | | | | | | | |
| Radiological workers | 122,000 | 2034 | 2035 | 2 | 61,000 | 30 | 39 |
| Nonradiological workers | | | | | | | |
| On site | 37,000 | 2034 | 2035 | 2 | 18,500 | 9 | |
| Off site | N/A | | | | | | |
| Cast Stone Facility (200-East Area) (DEA_CG) | | | | | | | |
| Radiological workers | 48,000 | 2034 | 2035 | 2 | 24,000 | 12 | 25 |
| Nonradiological workers | | | | | | | |
| On site | 54,000 | 2034 | 2035 | 2 | 27,000 | 13 | |
| Off site | N/A | | | | | | |
| Effluent Treatment Facility (Original) (DEA_ETFO) | | | | | | | |
| Radiological workers | 77,280 | 2026 | 2026 | 1 | 77,280 | 38 | 48 |
| Nonradiological workers | | | | | | | |
| On site | 19,320 | 2026 | 2026 | 1 | 19,320 | 10 | |
| Off site | N/A | | | | | | |

Draft Tank Closure and Waste Management Environmental Impact Statement for the
Hanford Site, Richland, Washington

Table I-31. Tank Closure Alternative 5 Deactivation Rollup Workforce Estimate (continued)

| Activity | Total Hours | Duration | | | Hours per Year | Full-Time Equivalents per year | Onsite Full-Time Equivalents |
|--|-------------------|----------|--------|-------|------------------|--------------------------------|------------------------------|
| | | Start | Finish | Years | | | |
| Effluent Treatment Facility Replacement (DEA ETF) | | | | | | | |
| Radiological workers | 77,280 | 2037 | 2037 | 1 | 77,280 | 38 | 48 |
| Nonradiological workers | | | | | | | |
| On site | 19,320 | 2037 | 2037 | 1 | 19,320 | 10 | |
| Off site | N/A | | | | | | |
| 242-A Evaporator (Original) (DEA EVAO) | | | | | | | |
| Radiological workers | 24,448 | 2018 | 2018 | 1 | 24,448 | 12 | 16 |
| Nonradiological workers | | | | | | | |
| On site | 7,477 | 2018 | 2018 | 1 | 7,477 | 4 | |
| Off site | N/A | | | | | | |
| 242-A Evaporator Replacement (DEA EVA) | | | | | | | |
| Radiological workers | 24,448 | 2035 | 2035 | 1 | 24,448 | 12 | 16 |
| Nonradiological workers | | | | | | | |
| On site | 7,477 | 2035 | 2035 | 1 | 7,477 | 4 | |
| Off site | N/A | | | | | | |
| Total | 10,069,683 | | | | 4,699,055 | 2,273 | 2,273 |

Notes and Assumptions:

Total number of offsite full-time equivalents = 0.

Hours worked per year = 2,080.

One full-time equivalent was assumed for activities estimated to require less than 2,080 hours per year.

Key: N/A=not applicable.

Source: Compiled from SAIC 2007a, 2008.

Table I-32. Tank Closure Alternative 5 Closure Rollup Workforce Estimate

| Activity | Total Hours | Duration | | | Hours per Year | Full-Time Equivalents per Year | Onsite Full-Time Equivalents |
|--|-------------|----------|--------|-------|----------------|--------------------------------|------------------------------|
| | | Start | Finish | Years | | | |
| Tank-Filling Grout Facility Construction (CLO_CONGRO) | | | | | | | |
| Radiological workers | 480 | 2022 | 2023 | 2 | 240 | 1 | 5 |
| Nonradiological workers | | | | | | | |
| On site | 13,360 | 2022 | 2023 | 2 | 6,680 | 4 | |
| Off site | 4,160 | 2022 | 2023 | 2 | 2,080 | 1 | |
| Tank-Filling Grout Facility Operations (CLO_OPSGRO) | | | | | | | |
| Radiological workers | 68,000 | 2024 | 2033 | 10 | 6,800 | 4 | 13 |
| Nonradiological workers | | | | | | | |
| On site | 185,280 | 2024 | 2033 | 10 | 18,528 | 9 | |
| Off site | 130,000 | 2024 | 2033 | 10 | 13,000 | 7 | |
| Tank-Filling Grout Facility Deactivation (CLO_DEAGRO) | | | | | | | |
| Radiological workers | 480 | 2034 | 2034 | 1 | 480 | 1 | 4 |
| Nonradiological workers | | | | | | | |
| On site | 4,320 | 2034 | 2034 | 1 | 4,320 | 3 | |
| Off site | 1,040 | 2034 | 2034 | 1 | 1,040 | 1 | |
| Ancillary Equipment Grouting (CLO_ANCFIL) | | | | | | | |
| Radiological workers | 287,252 | 2013 | 2033 | 21 | 13,679 | 7 | 7 |
| Nonradiological workers | | | | | | | |
| On site | N/A | | | | | | |
| Off site | N/A | | | | | | |

Table I–32. Tank Closure Alternative 5 Closure Rollup Workforce Estimate (continued)

| Activity | Total Hours | Duration | | | Hours per Year | Full-Time Equivalents per Year | Onsite Full-Time Equivalents |
|---|-------------------|----------|--------|-------|----------------|--------------------------------|------------------------------|
| | | Start | Finish | Years | | | |
| Hanford Barrier Construction (CLO_HAN) | | | | | | | |
| Radiological workers | 2,383,333 | 2029 | 2039 | 11 | 216,667 | 105 | 418 |
| Nonradiological workers | | | | | | | |
| On site | 7,150,000 | 2029 | 2039 | 11 | 650,000 | 313 | |
| Off site | N/A | | | | | | |
| Decontamination and Decommissioning of 10 Selected Facilities (CLO_D&DTEN) | | | | | | | |
| Radiological workers | 44,418 | 2012 | 2022 | 11 | 4,038 | 2 | 9 |
| Nonradiological workers | | | | | | | |
| On site | 146,679 | 2012 | 2022 | 11 | 13,334 | 7 | |
| Off site | 78,970 | 2012 | 2022 | 11 | 7,179 | 4 | |
| Postclosure Care (CLO_POST) | | | | | | | |
| Radiological workers | N/A | | | | | | 3 |
| Nonradiological workers | | | | | | | |
| On site | 471,262 | 2040 | 2139 | 100 | 4,713 | 3 | |
| Off site | N/A | | | | | | |
| Total | 10,969,033 | | | | 962,777 | 472 | 459 |

Notes and Assumptions:

Total number of offsite full-time equivalents = 13.

Hours worked per year = 2,080.

One full-time equivalent was assumed for activities estimated to require less than 2,080 hours per year.

Key: N/A=not applicable.

Source: Compiled from SAIC 2007a, 2008.

I.2.9 Tank Closure Alternative 6A: All Vitrification/No Separations; Clean Closure–Base Case

Table I–33. Tank Closure Alternative 6A, Base Case, Construction Rollup Workforce Estimate

| Activity | Total Hours | Duration | | | Hours per Year | Full-Time Equivalents per Year | Onsite Full-Time Equivalents |
|--|-------------|----------|--------|-------|----------------|--------------------------------|------------------------------|
| | | Start | Finish | Years | | | |
| Canister Storage Building (CON_CSB) | | | | | | | |
| Radiological workers | 115,500 | 2006 | 2016 | 11 | 10,500 | 6 | 12 |
| Nonradiological workers | | | | | | | |
| On site | 135,929 | 2006 | 2016 | 11 | 12,357 | 6 | |
| Off site | 50,286 | 2006 | 2016 | 11 | 4,571 | 3 | |
| Immobilized High-Level Radioactive Waste Shipping/Transfer Facility (CON_STF) | | | | | | | |
| Radiological workers | N/A | | | | | | 380 |
| Nonradiological workers | | | | | | | |
| Onsite construction | 1,757,000 | 2011 | 2013 | 3 | 585,667 | 282 | |
| Onsite exempt | 610,000 | 2011 | 2013 | 3 | 203,333 | 98 | |
| Offsite design | 748,000 | 2011 | 2013 | 3 | 249,333 | 120 | |
| Immobilized High-Level Radioactive Waste Interim Storage Modules (CON_ISM) | | | | | | | |
| Radiological workers | N/A | | | | | | 309 |
| Nonradiological workers | | | | | | | |
| Onsite construction | 56,995,392 | 2014 | 2157 | 144 | 395,801 | 191 | |
| Onsite exempt | 35,200,000 | 2014 | 2157 | 144 | 244,444 | 118 | |
| Offsite design | 43,200,000 | 2014 | 2157 | 144 | 300,000 | 145 | |

Draft Tank Closure and Waste Management Environmental Impact Statement for the
Hanford Site, Richland, Washington

**Table I-33. Tank Closure Alternative 6A, Base Case, Construction Rollup
Workforce Estimate (continued)**

| Activity | Total Hours | Duration | | | Hours per Year | Full-Time Equivalents per Year | Onsite Full-Time Equivalents |
|---|-------------|----------|--------|-------|----------------|--------------------------------|------------------------------|
| | | Start | Finish | Years | | | |
| Other Infrastructure Upgrades (CON_OIU) | | | | | | | |
| Radiological workers | 782,094 | 2006 | 2034 | 29 | 26,969 | 13 | 45 |
| Nonradiological workers | | | | | | | |
| On site | 1,918,531 | 2006 | 2034 | 29 | 66,156 | 32 | |
| Off site | 743,125 | 2006 | 2034 | 29 | 25,625 | 13 | |
| Tank Upgrades (CON_TU) | | | | | | | |
| Radiological workers | 1,195,652 | 2006 | 2025 | 20 | 59,783 | 29 | 104 |
| Nonradiological workers | | | | | | | |
| On site | 3,112,174 | 2006 | 2025 | 20 | 155,609 | 75 | |
| Off site | 1,179,130 | 2006 | 2025 | 20 | 58,957 | 29 | |
| Underground Transfer Lines (CON_UTL) | | | | | | | |
| Radiological workers | N/A | | | | | | 61 |
| Nonradiological workers | | | | | | | |
| On site | 126,005 | 2009 | 2009 | 1 | 126,005 | 61 | |
| Off site | 17,400 | 2009 | 2009 | 1 | 17,400 | 9 | |
| Waste Treatment Plant (CON_WTP) | | | | | | | |
| Radiological workers | N/A | | | | | | 906 |
| Nonradiological workers | | | | | | | |
| On site | 22,612,500 | 2006 | 2017 | 12 | 1,884,375 | 906 | |
| Off site | 7,537,500 | 2006 | 2017 | 12 | 628,125 | 302 | |
| Cesium and Strontium Capsule Processing Facility (CON_CSC) | | | | | | | |
| Radiological workers | N/A | | | | | | 190 |
| Nonradiological workers | | | | | | | |
| On site | 1,578,029 | 2158 | 2161 | 4 | 394,507 | 190 | |
| Off site | 465,683 | 2158 | 2161 | 4 | 116,421 | 56 | |
| Tank Risers (CON_RIS) | | | | | | | |
| Radiological workers | 188,760 | 2013 | 2016 | 4 | 47,190 | 23 | 54 |
| Nonradiological workers | | | | | | | |
| On site | 254,540 | 2013 | 2016 | 4 | 63,635 | 31 | |
| Off site | N/A | | | | | | |
| Double-Shell Tank Replacements (CON_DST)^a | | | | | | | |
| Radiological workers | N/A | | | | | | 1,005 |
| Nonradiological workers | | | | | | | |
| On site | 37,590,000 | 2029 | 2114 | 18 | 2,088,333 | 1,005 | |
| Off site | 13,524,000 | 2029 | 2114 | 18 | 751,333 | 362 | |
| Mobile Retrieval System (CON_MRS) | | | | | | | |
| Radiological workers | 33,070,100 | 2013 | 2162 | 150 | 220,467 | 106 | 224 |
| Nonradiological workers | | | | | | | |
| On site | 36,507,695 | 2013 | 2162 | 150 | 243,385 | 118 | |
| Off site | 19,575,745 | 2013 | 2162 | 150 | 130,505 | 63 | |
| Vacuum-Based Retrieval System (CON_VBR) | | | | | | | |
| Radiological workers | 9,686,600 | 2013 | 2162 | 150 | 64,577 | 32 | 66 |
| Nonradiological workers | | | | | | | |
| On site | 10,344,950 | 2013 | 2162 | 150 | 68,966 | 34 | |
| Off site | 5,898,200 | 2013 | 2162 | 150 | 39,321 | 19 | |

Table I-33. Tank Closure Alternative 6A, Base Case, Construction Rollup Workforce Estimate (continued)

| Activity | Total Hours | Duration | | | Hours per Year | Full-Time Equivalents per Year | Onsite Full-Time Equivalents |
|---|-------------|----------|--------|-------|----------------|--------------------------------|------------------------------|
| | | Start | Finish | Years | | | |
| Chemical Wash System (CON_CHW) | | | | | | | |
| Radiological workers | 3,063,830 | 2013 | 2162 | 150 | 20,426 | 10 | 12 |
| Nonradiological workers | | | | | | | |
| On site | 607,453 | 2013 | 2162 | 150 | 4,050 | 2 | |
| Off site | 817,719 | 2013 | 2162 | 150 | 5,451 | 3 | |
| High-Level Radioactive Waste Melter Interim Storage Facilities (CON_PAD)^b | | | | | | | |
| Radiological workers | N/A | | | | | | 1 |
| Nonradiological workers | | | | | | | |
| On site | 19,656 | 2017 | 2138 | 14 | 1,404 | 1 | |
| Off site | N/A | | | | | | |
| Underground Transfer Line Replacements (CON_UTLU) | | | | | | | |
| Radiological workers | N/A | | | | | | 61 |
| Nonradiological workers | | | | | | | |
| On site | 126,005 | 2064 | 2064 | 1 | 126,005 | 61 | |
| Off site | 17,400 | 2064 | 2064 | 1 | 17,400 | 9 | |
| Waste Treatment Plant Replacement (CON_WTPU)^c | | | | | | | |
| Radiological workers | N/A | | | | | | 678 |
| Nonradiological workers | | | | | | | |
| On site | 33,800,000 | 2067 | 2138 | 24 | 1,408,333 | 678 | |
| Off site | 11,300,000 | 2067 | 2138 | 24 | 470,833 | 227 | |
| Immobilized High-Level Radioactive Waste Shipping/Transfer Facility Replacement (CON_STFU)^d | | | | | | | |
| Radiological workers | N/A | | | | | | 380 |
| Nonradiological workers | | | | | | | |
| Onsite construction | 5,271,000 | 2076 | 2198 | 9 | 585,667 | 282 | |
| Onsite exempt | 1,830,000 | 2076 | 2198 | 9 | 203,333 | 98 | |
| Offsite design | 2,244,000 | 2076 | 2198 | 9 | 249,333 | 120 | |
| Immobilized High-Level Radioactive Waste Interim Storage Module Replacement (CON_ISMU) | | | | | | | |
| Radiological workers | N/A | | | | | | 838 |
| Nonradiological workers | | | | | | | |
| Onsite construction | 129,130,185 | 2078 | 2197 | 120 | 1,076,085 | 518 | |
| Onsite exempt | 79,750,000 | 2078 | 2197 | 120 | 664,583 | 320 | |
| Offsite design | 97,875,000 | 2078 | 2197 | 120 | 815,625 | 393 | |
| High-Level Radioactive Waste Debris Storage Facilities (CON_HLWST) | | | | | | | |
| Radiological workers | N/A | | | | | | 4 |
| Nonradiological workers | | | | | | | |
| On site | 577,280 | 2041 | 2110 | 70 | 8,247 | 4 | |
| Off site | N/A | | | | | | |
| Effluent Treatment Facility Replacement (CON ETF) | | | | | | | |
| Radiological workers | N/A | | | | | | 329 |
| Nonradiological workers | | | | | | | |
| On site | 2,047,400 | 2023 | 2025 | 3 | 682,467 | 329 | |
| Off site | 703,895 | 2023 | 2025 | 3 | 234,632 | 113 | |

Draft Tank Closure and Waste Management Environmental Impact Statement for the
Hanford Site, Richland, Washington

**Table I-33. Tank Closure Alternative 6A, Base Case, Construction Rollup
Workforce Estimate (continued)**

| Activity | Total Hours | Duration | | | Hours per Year | Full-Time Equivalents per Year | Onsite Full-Time Equivalents |
|---|--------------------|----------|--------|-------|-------------------|--------------------------------|------------------------------|
| | | Start | Finish | Years | | | |
| Effluent Treatment Facility Replacement (CON ETFU)^e | | | | | | | |
| Radiological workers | N/A | | | | | | |
| Nonradiological workers | | | | | | | 329 |
| On site | 8,189,600 | 2053 | 2145 | 12 | 682,467 | 329 | |
| Off site | 865,168 | 2053 | 2145 | 12 | 72,097 | 35 | |
| 242-A Evaporator Replacement (CON EVA) | | | | | | | |
| Radiological workers | N/A | | | | | | |
| Nonradiological workers | | | | | | | 102 |
| On site | 635,400 | 2015 | 2017 | 3 | 211,800 | 102 | |
| Off site | 217,918 | 2015 | 2017 | 3 | 72,639 | 35 | |
| 242-A Evaporator Replacement (CON EVAU) Five 3-year construction periods^f | | | | | | | |
| Radiological workers | N/A | | | | | | |
| Nonradiological workers | | | | | | | 102 |
| On site | 3,177,000 | 2040 | 2142 | 15 | 211,800 | 102 | |
| Off site | 1,145,741 | 2040 | 2142 | 15 | 76,383 | 37 | |
| Total | 730,132,170 | | | | 17,184,712 | 8,285 | 6,192 |

^a CON_DST activities are conducted over three 6-year periods, totaling 18 years.

 Period 1, 2029–2034

 Period 2, 2069–2074

 Period 3, 2109–2114

^b CON_PAD activities are conducted over seven 2-year periods, totaling 14 years.

 Period 1, 2017–2018

 Period 2, 2037–2038

 Period 3, 2057–2058

 Period 4, 2077–2078

 Period 5, 2097–2098

 Period 6, 2117–2118

 Period 7, 2137–2138

^c CON_WTPU activities are conducted over two 12-year periods, totaling 24 years.

 Period 1, 2067–2078

 Period 2, 2127–2138

^d CON_STFU activities are conducted over three 3-year periods, totaling 9 years.

 Period 1, 2076–2078

 Period 2, 2136–2138

 Period 3, 2196–2198

^e CON_EFTU activities are conducted over four 3-year periods, totaling 12 years.

 Period 1, 2053–2055

 Period 2, 2083–2085

 Period 3, 2113–2115

 Period 4, 2143–2145

^f CON_EVAU activities are conducted over five 3-year periods, totaling 15 years.

 Period 1, 2040–2042

 Period 2, 2065–2067

 Period 3, 2090–2092

 Period 4, 2115–2117

 Period 5, 2140–2142

Notes and Assumptions:

Total number of offsite full-time equivalents = 2,093.

Hours worked per year = 2,080.

One full-time equivalent was assumed for activities estimated to require less than 2,080 hours per year.

Key: N/A=not applicable.

Source: Compiled from SAIC 2007a, 2008.

Table I–34. Tank Closure Alternative 6A, Base Case, Operations Rollup Workforce Estimate

| Activity | Total Hours | Duration | | | Hours per Year | Full-Time Equivalents per Year | Onsite Full-Time Equivalents |
|--|-------------|----------|--------|-------|----------------|--------------------------------|------------------------------|
| | | Start | Finish | Years | | | |
| Immobilized High-Level Radioactive Waste Interim Storage Facilities (OPS_ISF) | | | | | | | |
| Radiological workers | 427,868,980 | 2018 | 2262 | 245 | 1,746,404 | 840 | 1,310 |
| Nonradiological workers | | | | | | | |
| On site | 239,316,000 | 2018 | 2262 | 245 | 976,800 | 470 | |
| Off site | N/A | | | | | | |
| Other Infrastructure Upgrades (OPS_OIU) | | | | | | | |
| Radiological workers | 185,545 | 2006 | 2162 | 157 | 1,182 | 1 | 4 |
| Nonradiological workers | | | | | | | |
| On site | 680,333 | 2006 | 2162 | 157 | 4,333 | 3 | |
| Off site | 485,273 | 2006 | 2162 | 157 | 3,091 | 2 | |
| Routine Operations (OPS_ROUT) | | | | | | | |
| Radiological workers | 40,820,000 | 2006 | 2162 | 157 | 260,000 | 125 | 651 |
| Nonradiological workers | | | | | | | |
| On site | 171,601,000 | 2006 | 2162 | 157 | 1,093,000 | 526 | |
| Off site | 24,335,000 | 2006 | 2162 | 157 | 155,000 | 75 | |
| Retrieval Operations (OPS_RET) | | | | | | | |
| Radiological workers | 53,523 | 2006 | 2162 | 157 | 341 | 1 | 28 |
| Nonradiological workers | | | | | | | |
| On site | 8,724,205 | 2006 | 2162 | 157 | 55,568 | 27 | |
| Off site | 67,795 | 2006 | 2162 | 157 | 432 | 1 | |
| Interim Stabilization/Double-Shell Tanks (OPS_IST) | | | | | | | |
| Radiological workers | 5,762,614 | 2006 | 2162 | 157 | 36,705 | 18 | 44 |
| Nonradiological workers | | | | | | | |
| On site | 8,246,068 | 2006 | 2162 | 157 | 52,523 | 26 | |
| Off site | 9,106,000 | 2006 | 2162 | 157 | 58,000 | 28 | |
| Waste Treatment Plant—(OPS_WTP) | | | | | | | |
| Radiological workers | 388,094,815 | 2018 | 2162 | 145 | 2,676,516 | 1,287 | 2,170 |
| Nonradiological workers | | | | | | | |
| On site | 266,176,439 | 2018 | 2162 | 145 | 1,835,700 | 883 | |
| Off site | 38,970 | 2018 | 2162 | 145 | 269 | 1 | |
| Waste Treatment Plant—Cesium and Strontium Capsules (OPS_WTPCSC) | | | | | | | |
| Radiological workers | 2,676,516 | 2163 | 2163 | 1 | 2,676,516 | 1,287 | 2,170 |
| Nonradiological workers | | | | | | | |
| On site | 1,835,700 | 2163 | 2163 | 1 | 1,835,700 | 883 | |
| Off site | 269 | 2163 | 2163 | 1 | 269 | 1 | |
| Cesium and Strontium—Capsule Processing Facility (OPS_CSC) | | | | | | | |
| Radiological workers | 103,334 | 2162 | 2163 | 2 | 51,667 | 25 | 25 |
| Nonradiological workers | | | | | | | |
| On site | N/A | | | | | | |
| Off site | N/A | | | | | | |
| Mobile Retrieval System (OPS_MRS) | | | | | | | |
| Radiological workers | 21,108,220 | 2013 | 2162 | 150 | 140,721 | 68 | 130 |
| Nonradiological workers | | | | | | | |
| On site | 19,105,345 | 2013 | 2162 | 150 | 127,369 | 62 | |
| Off site | N/A | | | | | | |

Draft Tank Closure and Waste Management Environmental Impact Statement for the
Hanford Site, Richland, Washington

**Table I-34. Tank Closure Alternative 6A, Base Case, Operations Rollup
Workforce Estimate (continued)**

| Activity | Total Hours | Duration | | | Hours per Year | Full-Time Equivalents per Year | Onsite Full-Time Equivalents |
|---|----------------------|----------|--------|-------|-------------------|--------------------------------|------------------------------|
| | | Start | Finish | Years | | | |
| Vacuum-Based Retrieval System (OPS_VBR) | | | | | | | |
| Radiological workers | 6,634,012 | 2013 | 2162 | 150 | 44,227 | 22 | 42 |
| Nonradiological workers | | | | | | | |
| On site | 6,004,537 | 2013 | 2162 | 150 | 40,030 | 20 | |
| Off site | N/A | | | | | | |
| Chemical Wash System (OPS_CHW) | | | | | | | |
| Radiological workers | 13,871,116 | 2013 | 2162 | 150 | 92,474 | 45 | 86 |
| Nonradiological workers | | | | | | | |
| On site | 12,555,102 | 2013 | 2162 | 150 | 83,701 | 41 | |
| Off site | N/A | | | | | | |
| High-Level Radioactive Waste Melter Interim Storage Facilities (OPS_PAD) | | | | | | | |
| Radiological workers | N/A | 2018 | 2262 | 245 | | | 0 |
| Nonradiological workers | | | | | | | |
| On site | N/A | | | | | | |
| Off site | N/A | | | | | | |
| High-Level Radioactive Waste Debris Storage Facilities (OPS_HLWST) | | | | | | | |
| Radiological workers | N/A | 2042 | 2262 | 221 | | | 0 |
| Nonradiological workers | | | | | | | |
| On site | N/A | | | | | | |
| Off site | N/A | | | | | | |
| Effluent Treatment Facility Replacement (OPS ETF) | | | | | | | |
| Radiological workers | 24,884,160 | 2006 | 2166 | 161 | 154,560 | 75 | 94 |
| Nonradiological workers | | | | | | | |
| On site | 6,221,040 | 2006 | 2166 | 161 | 38,640 | 19 | |
| Off site | N/A | | | | | | |
| 242-A Evaporator Replacement (OPS_EVA) | | | | | | | |
| Radiological workers | 7,138,758 | 2018 | 2163 | 146 | 48,896 | 24 | 32 |
| Nonradiological workers | | | | | | | |
| On site | 2,183,211 | 2018 | 2163 | 146 | 14,954 | 8 | |
| Off site | N/A | | | | | | |
| Borrow Area C (OPS_CAREA) | | | | | | | |
| Radiological workers | N/A | | | | | | 43 |
| Nonradiological workers | | | | | | | |
| On site | 14,482,800 | 2006 | 2167 | 162 | 89,400 | 43 | |
| Off site | N/A | | | | | | |
| Total | 1,730,366,680 | | | | 14,394,986 | 6,937 | 6,829 |

Notes and Assumptions:

Total number of offsite full-time equivalents = 108.

Hours worked per year = 2,080.

One full-time equivalent was assumed for activities estimated to require less than 2,080 hours per year.

Key: N/A=not applicable.

Source: Compiled from SAIC 2007a, 2008.

Table I-35. Tank Closure Alternative 6A, Base Case, Deactivation Rollup Workforce Estimate

| Activity | Total Hours | Duration | | | Hours per Year | Full-Time Equivalents per Year | Onsite Full-Time Equivalents |
|--|-------------------|----------|--------|-------|------------------|--------------------------------|------------------------------|
| | | Start | Finish | Years | | | |
| Immobilized High-Level Radioactive Waste Interim Storage Facilities (DEA_ISF) | | | | | | | |
| Radiological workers | N/A | | | | | | |
| Nonradiological workers | | | | | | | 1 |
| On site | 3,840 | 2078 | 2197 | 120 | 32 | 1 | |
| Off site | N/A | | | | | | |
| Waste Treatment Plant (DEA_WTP)^a | | | | | | | |
| Radiological workers | 13,470,000 | 2078 | 2166 | 9 | 1,496,667 | 720 | |
| Nonradiological workers | | | | | | | 1,214 |
| On site | 9,240,000 | 2078 | 2166 | 9 | 1,026,667 | 494 | |
| Off site | N/A | | | | | | |
| Mobile Retrieval System (DEA_MRS) | | | | | | | |
| Radiological workers | 2,775,115 | 2013 | 2162 | 150 | 18,501 | 9 | |
| Nonradiological workers | | | | | | | 9 |
| On site | N/A | | | | | | |
| Off site | N/A | | | | | | |
| Vacuum-Based Retrieval System (DEA_VBR) | | | | | | | |
| Radiological workers | 223,300 | 2013 | 2162 | 150 | 1,489 | 1 | |
| Nonradiological workers | | | | | | | 1 |
| On site | N/A | | | | | | |
| Off site | N/A | | | | | | |
| Chemical Wash System (DEA_CHW) | | | | | | | |
| Radiological workers | 185,472 | 2013 | 2162 | 150 | 1,236 | 1 | |
| Nonradiological workers | | | | | | | 1 |
| On site | N/A | | | | | | |
| Off site | N/A | | | | | | |
| Cesium and Strontium Capsule Processing Facility (DEA_CSC) | | | | | | | |
| Radiological workers | 23,920 | 2164 | 2164 | 1 | 23,920 | 12 | |
| Nonradiological workers | | | | | | | 12 |
| On site | N/A | | | | | | |
| Off site | N/A | | | | | | |
| Effluent Treatment Facility Replacement (DEA ETF)^b | | | | | | | |
| Radiological workers | 463,680 | 2026 | 2167 | 6 | 77,280 | 38 | |
| Nonradiological workers | | | | | | | 48 |
| On site | 115,920 | 2026 | 2167 | 6 | 19,320 | 10 | |
| Off site | N/A | | | | | | |
| 242-A Evaporator Replacement (DEA_EVA)^c | | | | | | | |
| Radiological workers | 171,135 | 2018 | 2168 | 7 | 24,448 | 12 | |
| Nonradiological workers | | | | | | | 16 |
| On site | 52,337 | 2018 | 2168 | 7 | 7,477 | 4 | |
| Off site | N/A | | | | | | |
| Total | 26,724,719 | | | | 2,697,036 | 1,302 | 1,302 |

**Table I-35. Tank Closure Alternative 6A, Base Case, Deactivation Rollup
Workforce Estimate (continued)**

- ^a DEA_WTP activities are conducted over three 3-year periods, totaling 9 years.
 Period 1, 2078–2080
 Period 2, 2138–2140
 Period 3, 2164–2166
- ^b DEA ETF activities are conducted over six 1-year periods, totaling 6 years.
 Period 1, 2026–2026
 Period 2, 2056–2056
 Period 3, 2086–2086
 Period 4, 2116–2116
 Period 5, 2146–2146
 Period 6, 2167–2167
- ^c DEA_EVA activities are conducted over seven 1-year periods, totaling 7 years.
 Period 1, 2018–2018
 Period 2, 2043–2043
 Period 3, 2068–2068
 Period 4, 2093–2093
 Period 5, 2118–2118
 Period 6, 2143–2143
 Period 7, 2168–2168

Notes and Assumptions:

Total number of offsite full-time equivalents = 0.
 Hours worked per year = 2,080.

One full-time equivalent was assumed for activities estimated to require less than 2,080 hours per year.

Key: N/A=not applicable.

Source: Compiled from SAIC 2007a, 2008.

Table I-36. Tank Closure Alternative 6A, Base Case, Closure Rollup Workforce Estimate

| Activity | Total Hours | Duration | | | Hours per Year | Full-Time Equivalents per Year | Onsite Full-Time Equivalents |
|---|-------------|----------|--------|-------|----------------|--------------------------------|------------------------------|
| | | Start | Finish | Years | | | |
| Containment Structure Construction (CLO_CONCS)^a | | | | | | | |
| Radiological workers | 12,000 | 2038 | 2141 | 24 | 500 | 1 | 4 |
| Nonradiological workers | | | | | | | |
| On site | 120,000 | 2038 | 2141 | 24 | 5,000 | 3 | |
| Off site | N/A | | | | | | |
| Containment Structure Deactivation (CLO_DEACS)^b | | | | | | | |
| Radiological workers | 12,000 | 2062 | 2164 | 21 | 571 | 1 | 4 |
| Nonradiological workers | | | | | | | |
| On site | 120,000 | 2062 | 2164 | 21 | 5,714 | 3 | |
| Off site | N/A | | | | | | |
| Decontamination and Decommissioning of 10 Selected Facilities (CLO_D&DTEN) | | | | | | | |
| Radiological workers | 44,418 | 2018 | 2028 | 11 | 4,038 | 2 | 9 |
| Nonradiological workers | | | | | | | |
| On site | 146,679 | 2018 | 2028 | 11 | 13,334 | 7 | |
| Off site | 78,970 | 2018 | 2028 | 11 | 7,179 | 4 | |
| Modified Resource Conservation and Recovery Act Subtitle C Barrier (CLO_RCRA) | | | | | | | |
| Radiological workers | 429,000 | 2149 | 2150 | 2 | 214,500 | 104 | 414 |
| Nonradiological workers | | | | | | | |
| On site | 1,287,000 | 2149 | 2150 | 2 | 643,500 | 310 | |
| Off site | N/A | | | | | | |

**Table I-36. Tank Closure Alternative 6A, Base Case, Closure Rollup
Workforce Estimate (continued)**

| Activity | Total Hours | Duration | | | Hours per Year | Full-Time Equivalents per Year | Onsite Full-Time Equivalents |
|---|-------------|----------|--------|-------|----------------|--------------------------------|------------------------------|
| | | Start | Finish | Years | | | |
| Postclosure Care (CLO_POST) | | | | | | | |
| Radiological workers | N/A | | | | | | |
| Nonradiological workers | | | | | | | 3 |
| On site | 471,262 | 2151 | 2250 | 100 | 4,713 | 3 | |
| Off site | N/A | | | | | | |
| Removal of B Tank Farm (CLO_REMTB) | | | | | | | |
| Radiological workers | 692,733 | 2065 | 2076 | 12 | 57,728 | 28 | |
| Nonradiological workers | | | | | | | 73 |
| On site | 1,098,495 | 2065 | 2076 | 12 | 91,541 | 45 | |
| Off site | N/A | | | | | | |
| Removal of T Tank Farm (CLO_REMTT) | | | | | | | |
| Radiological workers | 692,733 | 2126 | 2137 | 12 | 57,728 | 28 | |
| Nonradiological workers | | | | | | | 73 |
| On site | 1,098,495 | 2126 | 2137 | 12 | 91,541 | 45 | |
| Off site | N/A | | | | | | |
| Removal of BY Tank Farm (CLO_REMTBY) | | | | | | | |
| Radiological workers | 519,550 | 2111 | 2122 | 12 | 43,296 | 21 | |
| Nonradiological workers | | | | | | | 55 |
| On site | 823,871 | 2111 | 2122 | 12 | 68,656 | 34 | |
| Off site | N/A | | | | | | |
| Removal of BX Tank Farm (CLO_REMTBX) | | | | | | | |
| Radiological workers | 519,550 | 2042 | 2053 | 12 | 43,296 | 21 | |
| Nonradiological workers | | | | | | | 55 |
| On site | 823,871 | 2042 | 2053 | 12 | 68,656 | 34 | |
| Off site | N/A | | | | | | |
| Removal of C Tank Farm (CLO_REMTC) | | | | | | | |
| Radiological workers | 692,733 | 2088 | 2099 | 12 | 57,728 | 28 | |
| Nonradiological workers | | | | | | | 73 |
| On site | 1,098,495 | 2088 | 2099 | 12 | 91,541 | 45 | |
| Off site | N/A | | | | | | |
| Removal of A Tank Farm (CLO_REMTA) | | | | | | | |
| Radiological workers | 259,775 | 2142 | 2153 | 12 | 21,648 | 11 | |
| Nonradiological workers | | | | | | | 28 |
| On site | 411,936 | 2142 | 2153 | 12 | 34,328 | 17 | |
| Off site | N/A | | | | | | |
| Removal of AX Tank Farm (CLO_REMTAX) | | | | | | | |
| Radiological workers | 173,183 | 2142 | 2153 | 12 | 14,432 | 7 | |
| Nonradiological workers | | | | | | | 19 |
| On site | 274,624 | 2142 | 2153 | 12 | 22,885 | 12 | |
| Off site | N/A | | | | | | |
| Removal of S Tank Farm (CLO_REMTS) | | | | | | | |
| Radiological workers | 519,550 | 2126 | 2137 | 12 | 43,296 | 21 | |
| Nonradiological workers | | | | | | | 55 |
| On site | 823,871 | 2126 | 2137 | 12 | 68,656 | 34 | |
| Off site | N/A | | | | | | |

Draft Tank Closure and Waste Management Environmental Impact Statement for the
Hanford Site, Richland, Washington

**Table I-36. Tank Closure Alternative 6A, Base Case, Closure Rollup
Workforce Estimate (continued)**

| Activity | Total Hours | Duration | | | Hours per Year | Full-Time Equivalents per Year | Onsite Full-Time Equivalents |
|---|-------------|----------|--------|-------|----------------|--------------------------------|------------------------------|
| | | Start | Finish | Years | | | |
| Removal of TY Tank Farm (CLO_REMTTY) | | | | | | | |
| Radiological workers | 259,775 | 2111 | 2122 | 12 | 21,648 | 11 | 28 |
| Nonradiological workers | | | | | | | |
| On site | 411,936 | 2111 | 2122 | 12 | 34,328 | 17 | |
| Off site | N/A | | | | | | |
| Removal of TX Tank Farm (CLO_REMTTX) | | | | | | | |
| Radiological workers | 779,325 | 2088 | 2099 | 12 | 64,944 | 32 | 82 |
| Nonradiological workers | | | | | | | |
| On site | 1,235,807 | 2088 | 2099 | 12 | 102,984 | 50 | |
| Off site | N/A | | | | | | |
| Removal of U Tank Farm (CLO_REMTU) | | | | | | | |
| Radiological workers | 692,733 | 2065 | 2076 | 12 | 57,728 | 28 | 73 |
| Nonradiological workers | | | | | | | |
| On site | 1,098,495 | 2065 | 2076 | 12 | 91,541 | 45 | |
| Off site | N/A | | | | | | |
| Removal of SX Tank Farm (CLO_REMTSX) | | | | | | | |
| Radiological workers | 649,437 | 2042 | 2053 | 12 | 54,120 | 27 | 69 |
| Nonradiological workers | | | | | | | |
| On site | 1,029,839 | 2042 | 2053 | 12 | 85,820 | 42 | |
| Off site | N/A | | | | | | |
| Removal of Deep Soil-B Tank Farm (CLO_REMSB) | | | | | | | |
| Radiological workers | 73,371 | 2077 | 2084 | 8 | 9,171 | 5 | 11 |
| Nonradiological workers | | | | | | | |
| On site | 84,852 | 2077 | 2084 | 8 | 10,607 | 6 | |
| Off site | N/A | | | | | | |
| Removal of Deep Soil-T Tank Farm (CLO_REMTST) | | | | | | | |
| Radiological workers | 563,796 | 2138 | 2145 | 8 | 70,474 | 34 | 74 |
| Nonradiological workers | | | | | | | |
| On site | 652,024 | 2138 | 2145 | 8 | 81,503 | 40 | |
| Off site | N/A | | | | | | |
| Removal of Deep Soil-BX Tank Farm (CLO_REMSBX) | | | | | | | |
| Radiological workers | 293,483 | 2054 | 2061 | 8 | 36,685 | 18 | 39 |
| Nonradiological workers | | | | | | | |
| On site | 339,410 | 2054 | 2061 | 8 | 42,426 | 21 | |
| Off site | N/A | | | | | | |
| Removal of Deep Soil-C Tank Farm (CLO_REMSC) | | | | | | | |
| Radiological workers | 4,449 | 2100 | 2107 | 8 | 556 | 1 | 2 |
| Nonradiological workers | | | | | | | |
| On site | 5,145 | 2100 | 2107 | 8 | 643 | 1 | |
| Off site | N/A | | | | | | |
| Removal of Deep Soil-A Tank Farm (CLO_REMSA) | | | | | | | |
| Radiological workers | 13,346 | 2154 | 2161 | 8 | 1,668 | 1 | 2 |
| Nonradiological workers | | | | | | | |
| On site | 15,434 | 2154 | 2161 | 8 | 1,929 | 1 | |
| Off site | N/A | | | | | | |

**Table I-36. Tank Closure Alternative 6A, Base Case, Closure Rollup
Workforce Estimate (continued)**

| Activity | Total Hours | Duration | | | Hours per Year | Full-Time Equivalents per Year | Onsite Full-Time Equivalents |
|---|-------------------|----------|--------|-------|-------------------|--------------------------------|------------------------------|
| | | Start | Finish | Years | | | |
| Removal of Deep Soil–AX Tank Farm (CLO_REMSAX) | | | | | | | |
| Radiological workers | 222,429 | 2154 | 2161 | 8 | 27,804 | 14 | 30 |
| Nonradiological workers | | | | | | | |
| On site | 257,237 | 2154 | 2161 | 8 | 32,155 | 16 | |
| Off site | N/A | | | | | | |
| Removal of Deep Soil–TX Tank Farm (CLO_REMSTX) | | | | | | | |
| Radiological workers | 700,651 | 2100 | 2107 | 8 | 87,581 | 43 | 92 |
| Nonradiological workers | | | | | | | |
| On site | 810,297 | 2100 | 2107 | 8 | 101,287 | 49 | |
| Off site | N/A | | | | | | |
| Removal of Deep Soil–U Tank Farm (CLO_REMSU) | | | | | | | |
| Radiological workers | 367,008 | 2077 | 2084 | 8 | 45,876 | 23 | 49 |
| Nonradiological workers | | | | | | | |
| On site | 424,441 | 2077 | 2084 | 8 | 53,055 | 26 | |
| Off site | N/A | | | | | | |
| Removal of Deep Soil–SX Tank Farm (CLO_REMSXX) | | | | | | | |
| Radiological workers | 895,895 | 2054 | 2061 | 8 | 111,987 | 54 | 117 |
| Nonradiological workers | | | | | | | |
| On site | 1,036,093 | 2054 | 2061 | 8 | 129,152 | 63 | |
| Off site | N/A | | | | | | |
| Preprocessing Facility Construction (CLO_CONPPF) | | | | | | | |
| Radiological workers | N/A | | | | | | 2,389 |
| Nonradiological workers | | | | | | | |
| On site | 14,904,804 | 2039 | 2041 | 3 | 4,968,268 | 2,389 | |
| Off site | 5,035,407 | 2039 | 2041 | 3 | 1,678,469 | 807 | |
| Preprocessing Facility Operations (CLO_OPSPPF) | | | | | | | |
| Radiological workers | 13,087,360 | 2042 | 2162 | 121 | 108,160 | 52 | 54 |
| Nonradiological workers | | | | | | | |
| On site | 402,688 | 2042 | 2162 | 121 | 3,328 | 2 | |
| Off site | N/A | | | | | | |
| Preprocessing Facility Deactivation (CLO_DEAPPF) | | | | | | | |
| Radiological workers | 108,160 | 2163 | 2163 | 1 | 108,160 | 52 | 54 |
| Nonradiological workers | | | | | | | |
| On site | 3,328 | 2163 | 2163 | 1 | 3,328 | 2 | |
| Off site | N/A | | | | | | |
| Total | 59,703,247 | | | | 10,003,750 | 4,841 | 4,030 |

^a CLO_CONCS activities are conducted over six 4-year periods, totaling 24 years.

- Period 1, 2038–2041; 2 facilities
- Period 2, 2061–2064; 2 facilities
- Period 3, 2084–2087; 2 facilities
- Period 4, 2107–2110; 2 facilities
- Period 5, 2122–2125; 2 facilities
- Period 6, 2138–2141; 2 facilities

**Table I-36. Tank Closure Alternative 6A, Base Case, Closure Rollup
Workforce Estimate (continued)**

^b CLO_DEACS activities are conducted over seven 3-year periods, totaling 21 years.

- Period 1, 2062–2064; 2 facilities
- Period 2, 2085–2087; 2 facilities
- Period 3, 2108–2110; 2 facilities
- Period 4, 2123–2125; 2 facilities
- Period 5, 2146–2148; 1 facility
- Period 6, 2138–2140; 1 facility
- Period 7, 2162–2164; 2 facilities

Formula: Hours per year = (total hours/12 containment structures)/3 years of deactivation per deactivation period.

Notes and Assumptions:

Total number of offsite full-time equivalents = 811.

Hours worked per year = 2,080.

One full-time equivalent was assumed for activities estimated to require less than 2,080 hours per year.

Key: N/A=not applicable.

Source: Compiled from SAIC 2007a, 2008.

**I.2.10 Tank Closure Alternative 6A: All Vitrification/No Separations;
Clean Closure–Option Case**

Table I-37. Tank Closure Alternative 6A, Option Case, Construction Rollup Workforce Estimate

| Activity | Total Hours | Duration | | | Hours per Year | Full-Time Equivalents per Year | Onsite Full-Time Equivalents |
|--|-------------|----------|--------|-------|----------------|--------------------------------|------------------------------|
| | | Start | Finish | Years | | | |
| Canister Storage Building (CON_CSB) | | | | | | | |
| Radiological workers | 115,500 | 2006 | 2016 | 11 | 10,500 | 6 | 12 |
| Nonradiological workers | | | | | | | |
| On site | 135,929 | 2006 | 2016 | 11 | 12,357 | 6 | |
| Off site | 50,286 | 2006 | 2016 | 11 | 4,571 | 3 | |
| Immobilized High-Level Radioactive Waste Shipping/Transfer Facility (CON_STF) | | | | | | | |
| Radiological Workers | N/A | | | | | | 380 |
| Nonradiological workers | | | | | | | |
| Onsite construction | 1,757,000 | 2011 | 2013 | 3 | 585,667 | 282 | |
| Onsite exempt | 610,000 | 2011 | 2013 | 3 | 203,333 | 98 | |
| Offsite design | 748,000 | 2011 | 2013 | 3 | 249,333 | 120 | |
| Immobilized High-Level Radioactive Waste Interim Storage Modules (CON_ISM) | | | | | | | |
| Radiological Workers | N/A | | | | | | 309 |
| Nonradiological workers | | | | | | | |
| Onsite construction | 56,995,392 | 2014 | 2157 | 144 | 395,801 | 191 | |
| Onsite exempt | 35,200,000 | 2014 | 2157 | 144 | 244,444 | 118 | |
| Offsite design | 43,200,000 | 2014 | 2157 | 144 | 300,000 | 145 | |
| Other Infrastructure Upgrades (CON_OIU) | | | | | | | |
| Radiological workers | 782,094 | 2006 | 2034 | 29 | 26,969 | 13 | 45 |
| Nonradiological workers | | | | | | | |
| On site | 1,918,531 | 2006 | 2034 | 29 | 66,156 | 32 | |
| Off site | 743,125 | 2006 | 2034 | 29 | 25,625 | 13 | |
| Tank Upgrades (CON_TU) | | | | | | | |
| Radiological workers | 1,195,652 | 2006 | 2025 | 20 | 59,783 | 29 | 104 |
| Nonradiological workers | | | | | | | |
| On site | 3,112,174 | 2006 | 2025 | 20 | 155,609 | 75 | |
| Off site | 1,179,130 | 2006 | 2025 | 20 | 58,957 | 29 | |

**Table I-37. Tank Closure Alternative 6A, Option Case, Construction Rollup
Workforce Estimate (continued)**

| Activity | Total Hours | Duration | | | Hours per Year | Full-Time Equivalents per Year | Onsite Full-Time Equivalents |
|---|-------------|----------|--------|-------|----------------|--------------------------------|------------------------------|
| | | Start | Finish | Years | | | |
| Underground Transfer Lines (CON_UTL) | | | | | | | |
| Radiological workers | N/A | | | | | | |
| Nonradiological workers | | | | | | | 61 |
| On site | 126,005 | 2009 | 2009 | 1 | 126,005 | 61 | |
| Off site | 17,400 | 2009 | 2009 | 1 | 17,400 | 9 | |
| Waste Treatment Plant (CON_WTP) | | | | | | | |
| Radiological workers | N/A | | | | | | |
| Nonradiological workers | | | | | | | 906 |
| On site | 22,612,500 | 2006 | 2017 | 12 | 1,884,375 | 906 | |
| Off site | 7,537,500 | 2006 | 2017 | 12 | 628,125 | 302 | |
| Cesium and Strontium Capsule Processing Facility (CON_CSC) | | | | | | | |
| Radiological workers | N/A | | | | | | |
| Nonradiological workers | | | | | | | 190 |
| On site | 1,578,029 | 2158 | 2161 | 4 | 394,507 | 190 | |
| Off site | 465,683 | 2158 | 2161 | 4 | 116,421 | 56 | |
| Tank Risers (CON_RIS) | | | | | | | |
| Radiological workers | 188,760 | 2013 | 2016 | 4 | 47,190 | 23 | |
| Nonradiological workers | | | | | | | 54 |
| On site | 254,540 | 2013 | 2016 | 4 | 63,635 | 31 | |
| Off site | N/A | | | | | | |
| Double-Shell Tank Replacement (CON_DST)^a | | | | | | | |
| Radiological workers | N/A | | | | | | |
| Nonradiological workers | | | | | | | 1,005 |
| On site | 37,590,000 | 2029 | 2114 | 18 | 2,088,333 | 1,005 | |
| Off site | 13,524,000 | 2029 | 2114 | 18 | 751,333 | 362 | |
| Mobile Retrieval System (CON_MRS) | | | | | | | |
| Radiological workers | 33,070,100 | 2013 | 2162 | 150 | 220,467 | 106 | |
| Nonradiological workers | | | | | | | 224 |
| On site | 36,507,695 | 2013 | 2162 | 150 | 243,385 | 118 | |
| Off site | 19,575,745 | 2013 | 2162 | 150 | 130,505 | 63 | |
| Vacuum-Based Retrieval System (CON_VBR) | | | | | | | |
| Radiological workers | 9,686,600 | 2013 | 2162 | 150 | 64,577 | 32 | |
| Nonradiological workers | | | | | | | 66 |
| On site | 10,344,950 | 2013 | 2162 | 150 | 68,966 | 34 | |
| Off site | 5,898,200 | 2013 | 2162 | 150 | 39,321 | 19 | |

Draft Tank Closure and Waste Management Environmental Impact Statement for the
Hanford Site, Richland, Washington

**Table I-37. Tank Closure Alternative 6A, Option Case, Construction Rollup
Workforce Estimate (continued)**

| Activity | Total Hours | Duration | | | Hours per Year | Full-Time Equivalents per Year | Onsite Full-Time Equivalents |
|---|-------------|--|--------|-------|----------------|--------------------------------|------------------------------|
| | | Start | Finish | Years | | | |
| Chemical Wash System (CON_CHW) | | | | | | | |
| Radiological workers | 3,063,830 | 2013 | 2162 | 150 | 20,426 | 10 | 12 |
| Nonradiological workers | | | | | | | |
| On site | 607,453 | 2013 | 2162 | 150 | 4,050 | 2 | |
| Off site | 817,719 | 2013 | 2162 | 150 | 5,451 | 3 | |
| High-Level Radioactive Waste Melter Interim Storage Facilities (CON_PAD) | | | | | | | |
| Radiological workers | N/A | | | | | | 1 |
| Nonradiological workers | | | | | | | |
| On site | 19,656 | 2017 | 2138 | 14 | 1,404 | 1 | |
| Off site | N/A | Seven 2-year construction periods ^b | | | | | |
| Underground Transfer Line Replacements (CON_UTLU) | | | | | | | |
| Radiological workers | N/A | | | | | | 61 |
| Nonradiological workers | | | | | | | |
| On site | 126,005 | 2064 | 2064 | 1 | 126,005 | 61 | |
| Off site | 17,400 | 2064 | 2064 | 1 | 17,400 | 9 | |
| Waste Treatment Plant Replacement (CON_WTPU) | | | | | | | |
| Radiological workers | N/A | Two 12-year construction periods ^c | | | | | 678 |
| Nonradiological workers | | | | | | | |
| On site | 33,800,000 | 2067 | 2138 | 24 | 1,408,333 | 678 | |
| Off site | 11,300,000 | 2067 | 2138 | 24 | 470,833 | 227 | |
| Immobilized High-Level Radioactive Waste Shipping/Transfer Facility Replacement (CON_STFU) | | | | | | | |
| Three 3-year construction periods ^d | | | | | | | |
| Radiological workers | N/A | | | | | | 380 |
| Nonradiological workers | | | | | | | |
| Onsite construction | 5,271,000 | 2076 | 2198 | 9 | 585,667 | 282 | |
| Onsite exempt | 1,830,000 | 2076 | 2198 | 9 | 203,333 | 98 | |
| Offsite design | 2,244,000 | 2076 | 2198 | 9 | 249,333 | 120 | |
| Immobilized High-Level Radioactive Waste Interim Storage Module Replacement (CON_ISMU) | | | | | | | |
| Radiological workers | N/A | | | | | | 838 |
| Nonradiological workers | | | | | | | |
| Onsite construction | 129,130,185 | 2078 | 2197 | 120 | 1,076,085 | 518 | |
| Onsite exempt | 79,750,000 | 2078 | 2197 | 120 | 664,583 | 320 | |
| Offsite design | 97,875,000 | 2078 | 2197 | 120 | 815,625 | 393 | |
| High-Level Radioactive Waste Debris Storage Facilities (CON_HLWST) | | | | | | | |
| Radiological workers | N/A | | | | | | 4 |
| Nonradiological workers | | | | | | | |
| On site | 577,280 | 2041 | 2110 | 70 | 8,247 | 4 | |
| Off site | N/A | | | | | | |
| Effluent Treatment Facility Replacement (CON ETF) | | | | | | | |
| Radiological workers | N/A | | | | | | 329 |
| Nonradiological workers | | | | | | | |
| On site | 2,047,400 | 2023 | 2025 | 3 | 682,467 | 329 | |
| Off site | 703,895 | 2023 | 2025 | 3 | 234,632 | 113 | |

**Table I-37. Tank Closure Alternative 6A, Option Case, Construction Rollup
Workforce Estimate (continued)**

| Activity | Total Hours | Duration | | | Hours per Year | Full-Time Equivalents per Year | Onsite Full-Time Equivalents |
|---|--------------------|----------|--------|-------|-------------------|--------------------------------|------------------------------|
| | | Start | Finish | Years | | | |
| Effluent Treatment Facility Replacement (CON_ETFU)^e | | | | | | | |
| Radiological workers | N/A | | | | | | |
| Nonradiological workers | | | | | | | |
| On site | 8,189,600 | 2053 | 2145 | 12 | 682,467 | 329 | 329 |
| Off site | 865,168 | 2053 | 2145 | 12 | 72,097 | 35 | |
| 242-A Evaporator Replacement (CON_EVA) | | | | | | | |
| Radiological workers | N/A | | | | | | |
| Nonradiological workers | | | | | | | |
| On site | 635,400 | 2015 | 2017 | 3 | 211,800 | 102 | 102 |
| Off site | 217,918 | 2015 | 2017 | 3 | 72,639 | 35 | |
| 242-A Evaporator Replacement (CON_EVAU)^f | | | | | | | |
| Radiological workers | N/A | | | | | | |
| Nonradiological workers | | | | | | | |
| On site | 3,177,000 | 2040 | 2142 | 15 | 211,800 | 102 | 102 |
| Off site | 1,145,741 | 2040 | 2142 | 15 | 76,383 | 37 | |
| Total | 730,132,170 | | | | 17,184,712 | 8,285 | 6,192 |

^a CON_DST activities are conducted over three 6-year periods, totaling 18 years.

Period 1, 2029–2034

Period 2, 2069–2074

Period 3, 2109–2114

^b CON_PAD activities are conducted over seven 2-year periods, totaling 14 years.

Period 1, 2017–2018

Period 2, 2037–2038

Period 3, 2057–2058

Period 4, 2077–2078

Period 5, 2097–2098

Period 6, 2117–2118

Period 7, 2137–2138

^c CON_WTPU activities are conducted over two 12-year periods, totaling 24 years.

Period 1, 2067–2078

Period 2, 2127–2138

^d CON_STFU activities are conducted over three 3-year periods, totaling 9 years.

Period 1, 2076–2078

Period 2, 2136–2138

Period 3, 2196–2198

^e CON_EFTU activities are conducted over four 3-year periods, totaling 12 years.

Period 1, 2053–2055

Period 2, 2083–2085

Period 3, 2113–2115

Period 4, 2143–2145

^f CON_EVAU activities are conducted over five 3-year periods, totaling 15 years.

Period 1, 2040–2042

Period 2, 2065–2067

Period 3, 2090–2092

Period 4, 2115–2117

Period 5, 2140–2142

Notes and Assumptions:

Total number of offsite full-time equivalents = 2,093.

Hours worked per year = 2,080.

One full-time equivalent was assumed for activities estimated to require less than 2,080 hours per year.

Key: N/A=not applicable.

Source: Compiled from SAIC 2007a, 2008.

Draft Tank Closure and Waste Management Environmental Impact Statement for the
Hanford Site, Richland, Washington

Table I-38. Tank Closure Alternative 6A, Option Case, Operations Rollup Workforce Estimate

| Activity | Total Hours | Duration | | | Hours per Year | Full-Time Equivalents per Year | Onsite Full-Time Equivalents |
|--|-------------|----------|--------|-------|----------------|--------------------------------|------------------------------|
| | | Start | Finish | Years | | | |
| Immobilized High-Level Radioactive Waste Interim Storage Facilities (OPS_ISF) | | | | | | | |
| Radiological workers | 427,868,980 | 2018 | 2262 | 245 | 1,746,404 | 840 | 1,310 |
| Nonradiological workers | | | | | | | |
| On site | 239,316,000 | 2018 | 2262 | 245 | 976,800 | 470 | |
| Off site | N/A | | | | | | |
| Other Infrastructure Upgrades (OPS_OIU) | | | | | | | |
| Radiological workers | 185,545 | 2006 | 2162 | 157 | 1,182 | 1 | 4 |
| Nonradiological workers | | | | | | | |
| On site | 680,333 | 2006 | 2162 | 157 | 4,333 | 3 | |
| Off site | 485,273 | 2006 | 2162 | 157 | 3,091 | 2 | |
| Routine Operations (OPS_ROUT) | | | | | | | |
| Radiological workers | 40,820,000 | 2006 | 2162 | 157 | 260,000 | 125 | 651 |
| Nonradiological workers | | | | | | | |
| On site | 171,601,000 | 2006 | 2162 | 157 | 1,093,000 | 526 | |
| Off site | 24,335,000 | 2006 | 2162 | 157 | 155,000 | 75 | |
| Retrieval Operations (OPS_RET) | | | | | | | |
| Radiological workers | 53,523 | 2006 | 2162 | 157 | 341 | 1 | 28 |
| Nonradiological workers | | | | | | | |
| On site | 8,724,205 | 2006 | 2162 | 157 | 55,568 | 27 | |
| Off site | 67,795 | 2006 | 2162 | 157 | 432 | 1 | |
| Interim Stabilization/Double-Shell Tanks (OPS_IST) | | | | | | | |
| Radiological workers | 5,762,614 | 2006 | 2162 | 157 | 36,705 | 18 | 44 |
| Nonradiological workers | | | | | | | |
| On site | 8,246,068 | 2006 | 2162 | 157 | 52,523 | 26 | |
| Off site | 9,106,000 | 2006 | 2162 | 157 | 58,000 | 28 | |
| Waste Treatment Plant—Cesium and Strontium Capsules (OPS_WTP) | | | | | | | |
| Radiological workers | 388,094,815 | 2018 | 2162 | 145 | 2,676,516 | 1,287 | 2,170 |
| Nonradiological workers | | | | | | | |
| On site | 266,176,439 | 2018 | 2162 | 145 | 1,835,700 | 883 | |
| Off site | 38,970 | 2018 | 2162 | 145 | 269 | 1 | |
| Waste Treatment Plant (OPS_WTPCSC) | | | | | | | |
| Radiological workers | 2,676,516 | 2163 | 2163 | 1 | 2,676,516 | 1,287 | 2,170 |
| Nonradiological workers | | | | | | | |
| On site | 1,835,700 | 2163 | 2163 | 1 | 1,835,700 | 883 | |
| Off site | 269 | 2163 | 2163 | 1 | 269 | 1 | |
| Cesium and Strontium Capsule Processing Facility (OPS_CSC) | | | | | | | |
| Radiological workers | 103,334 | 2162 | 2163 | 2 | 51,667 | 25 | 25 |
| Nonradiological workers | | | | | | | |
| On site | N/A | | | | | | |
| Off site | N/A | | | | | | |

**Table I-38. Tank Closure Alternative 6A, Option Case, Operations Rollup
Workforce Estimate (continued)**

| Activity | Total Hours | Duration | | | Hours per Year | Full-Time Equivalents per Year | Onsite Full-Time Equivalents |
|---|-------------|----------|--------|-------|----------------|--------------------------------|------------------------------|
| | | Start | Finish | Years | | | |
| Mobile Retrieval System (OPS_MRS) | | | | | | | |
| Radiological workers | 21,108,220 | 2013 | 2162 | 150 | 140,721 | 68 | 130 |
| Nonradiological workers | | | | | | | |
| On site | 19,105,345 | 2013 | 2162 | 150 | 127,369 | 62 | |
| Off site | N/A | | | | | | |
| Vacuum-Based Retrieval System (OPS_VBR) | | | | | | | |
| Radiological workers | 6,634,012 | 2013 | 2162 | 150 | 44,227 | 22 | 42 |
| Nonradiological workers | | | | | | | |
| On site | 6,004,537 | 2013 | 2162 | 150 | 40,030 | 20 | |
| Off site | N/A | | | | | | |
| Chemical Wash System (OPS_CHW) | | | | | | | |
| Radiological workers | 13,871,116 | 2013 | 2162 | 150 | 92,474 | 45 | 86 |
| Nonradiological workers | | | | | | | |
| On site | 12,555,102 | 2013 | 2162 | 150 | 83,701 | 41 | |
| Off site | N/A | | | | | | |
| High-Level Radioactive Waste Melter Interim Storage Facilities (OPS_PAD) | | | | | | | |
| Radiological workers | N/A | 2018 | 2262 | 245 | | | |
| Nonradiological workers | | | | | | | |
| On site | N/A | | | | | | |
| Off site | N/A | | | | | | |
| High-Level Radioactive Waste Debris Storage Facilities (OPS_HLWST) | | | | | | | |
| Radiological workers | N/A | 2042 | 2262 | 221 | | | |
| Nonradiological workers | | | | | | | |
| On site | N/A | | | | | | |
| Off site | N/A | | | | | | |
| Effluent Treatment Facility Replacement (OPS ETF) | | | | | | | |
| Radiological workers | 24,884,160 | 2006 | 2166 | 161 | 154,560 | 75 | 94 |
| Nonradiological workers | | | | | | | |
| On site | 6,221,040 | 2006 | 2166 | 161 | 38,640 | 19 | |
| Off site | N/A | | | | | | |
| 242-A Evaporator Replacement (OPS_EVA) | | | | | | | |
| Radiological workers | 7,138,758 | 2018 | 2163 | 146 | 48,896 | 24 | 32 |
| Nonradiological workers | | | | | | | |
| On site | 2,183,211 | 2018 | 2163 | 146 | 14,954 | 8 | |
| Off site | N/A | | | | | | |

Draft Tank Closure and Waste Management Environmental Impact Statement for the
Hanford Site, Richland, Washington

**Table I-38. Tank Closure Alternative 6A, Option Case, Operations Rollup
Workforce Estimate (continued)**

| Activity | Total Hours | Duration | | | Hours per Year | Full-Time Equivalents per Year | Onsite Full-Time Equivalents |
|----------------------------------|----------------------|----------|--------|-------|-------------------|--------------------------------|------------------------------|
| | | Start | Finish | Years | | | |
| Borrow Area C (OPS_CAREA) | | | | | | | |
| Radiological workers | N/A | | | | | | |
| Nonradiological workers | | | | | | | |
| On site | 14,482,800 | 2006 | 2167 | 162 | 89,400 | 43 | 43 |
| Off site | N/A | | | | | | |
| Total | 1,730,366,679 | | | | 14,394,985 | 6,937 | 6,829 |

Notes and Assumptions:

Total number of offsite full-time equivalents = 108.

Hours worked per year = 2,080.

One full-time equivalent was assumed for activities estimated to require less than 2,080 hours per year.

Key: N/A=not applicable.

Source: Compiled from SAIC 2007a, 2008.

Table I-39. Tank Closure Alternative 6A, Option Case, Deactivation Rollup Workforce Estimate

| Activity | Total Hours | Duration | | | Hours per Year | Full-Time Equivalents per Year | Onsite Full-Time Equivalents |
|--|-------------|----------|--------|-------|----------------|--------------------------------|------------------------------|
| | | Start | Finish | Years | | | |
| Immobilized High-Level Radioactive Waste Interim Storage Facilities (DEA_ISF) | | | | | | | |
| Radiological workers | N/A | | | | | | |
| Nonradiological workers | | | | | | | |
| On site | 3,840 | 2078 | 2197 | 120 | 32 | 1 | 1 |
| Off site | N/A | | | | | | |
| Waste Treatment Plant (DEA_WTP)^a | | | | | | | |
| Radiological workers | 13,459,936 | 2079 | 2166 | 9 | 1,495,548 | 720 | |
| Nonradiological workers | | | | | | | 1,214 |
| On site | 9,231,553 | 2079 | 2166 | 9 | 1,025,728 | 494 | |
| Off site | N/A | | | | | | |
| Mobile Retrieval System (DEA_MRS) | | | | | | | |
| Radiological workers | 2,775,115 | 2013 | 2162 | 150 | 18,501 | 9 | |
| Nonradiological workers | | | | | | | 9 |
| On site | N/A | | | | | | |
| Off site | N/A | | | | | | |
| Vacuum-Based Retrieval System (DEA_VBR) | | | | | | | |
| Radiological workers | 223,300 | 2013 | 2162 | 150 | 1,489 | 1 | |
| Nonradiological workers | | | | | | | 1 |
| On site | N/A | | | | | | |
| Off site | N/A | | | | | | |
| Chemical Wash System (DEA_CHW) | | | | | | | |
| Radiological workers | 185,472 | 2013 | 2162 | 150 | 1,236 | 1 | |
| Nonradiological workers | | | | | | | 1 |
| On site | N/A | | | | | | |
| Off site | N/A | | | | | | |

**Table I-39. Tank Closure Alternative 6A, Option Case, Deactivation Rollup
Workforce Estimate (continued)**

| Activity | Total Hours | Duration | | | Hours per Year | Full-Time Equivalents per Year | Onsite Full-Time Equivalents |
|--|-------------------|----------|--------|-------|------------------|--------------------------------|------------------------------|
| | | Start | Finish | Years | | | |
| Cesium and Strontium Capsule Processing Facility (DEA_CSC) | | | | | | | |
| Radiological workers | 23,920 | 2164 | 2164 | 1 | 23,920 | 12 | 12 |
| Nonradiological workers | | | | | | | |
| On site | N/A | | | | | | |
| Off site | N/A | | | | | | |
| Effluent Treatment Facility Replacement (DEA ETF)^b | | | | | | | |
| Radiological workers | 463,680 | 2026 | 2167 | 6 | 77,280 | 38 | 48 |
| Nonradiological workers | | | | | | | |
| On site | 115,920 | 2026 | 2167 | 6 | 19,320 | 10 | |
| Off site | N/A | | | | | | |
| 242-A Evaporator Replacement (DEA_EVA)^c | | | | | | | |
| Radiological workers | 171,135 | 2018 | 2168 | 7 | 24,448 | 12 | 16 |
| Nonradiological workers | | | | | | | |
| On site | 52,337 | 2018 | 2168 | 7 | 7,477 | 4 | |
| Off site | N/A | | | | | | |
| Total | 26,706,208 | | | | 2,694,979 | 1,302 | 1,302 |

^a DEA_WTP activities are conducted over three 3-year periods, totaling 9 years.

Period 1, 2079–2081

Period 2, 2139–2141

Period 3, 2164–2166

^b DEA ETF activities are conducted over six 1-year periods, totaling 6 years.

Period 1, 2026–2026

Period 2, 2056–2056

Period 3, 2086–2086

Period 4, 2116–2116

Period 5, 2146–2146

Period 6, 2167–2167

^c DEA_EVA activities are conducted over seven 1-year periods, totaling 7 years.

Period 1, 2018–2018

Period 2, 2043–2043

Period 3, 2068–2068

Period 4, 2093–2093

Period 5, 2118–2118

Period 6, 2143–2143

Period 7, 2168–2168

Notes and Assumptions:

Total number of offsite full-time equivalents = 0.

Hours worked per year = 2,080.

One full-time equivalent was assumed for activities estimated to require less than 2,080 hours per year.

Key: N/A=not applicable.

Source: Compiled from SAIC 2007a, 2008.

Draft Tank Closure and Waste Management Environmental Impact Statement for the
Hanford Site, Richland, Washington

Table I-40. Tank Closure Alternative 6A, Option Case, Closure Rollup Workforce Estimate

| Activity | Total Hours | Duration | | | Hours per Year | Full-Time Equivalents per Year | Onsite Full-Time Equivalents |
|---|-------------|----------|--------|-------|----------------|--------------------------------|------------------------------|
| | | Start | Finish | Years | | | |
| Containment Structure Construction (CLO_CONCS1)^a | | | | | | | |
| Radiological workers | 12,000 | 2038 | 2141 | 24 | 500 | 1 | 4 |
| Nonradiological workers | | | | | | | |
| On site | 120,000 | 2038 | 2141 | 24 | 5,000 | 3 | |
| Off site | N/A | | | | | | |
| Containment Structure Deactivation (CLO_DEACS1)^b | | | | | | | |
| Radiological workers | 12,000 | 2062 | 2164 | 21 | 571 | 1 | 4 |
| Nonradiological workers | | | | | | | |
| On site | 120,000 | 2062 | 2164 | 21 | 5,714 | 3 | |
| Off site | N/A | | | | | | |
| Decontamination and Decommissioning of 10 Selected Facilities (CLO_D&DTEN) | | | | | | | |
| Radiological workers | 44,418 | 2018 | 2028 | 11 | 4,038 | 2 | 9 |
| Nonradiological workers | | | | | | | |
| On site | 146,679 | 2018 | 2028 | 11 | 13,334 | 7 | |
| Off site | 78,970 | 2018 | 2028 | 11 | 7,179 | 4 | |
| Removal of B Tank Farm (CLO_REMTB) | | | | | | | |
| Radiological workers | 692,733 | 2065 | 2076 | 12 | 57,728 | 28 | 73 |
| Nonradiological workers | | | | | | | |
| On site | 1,098,495 | 2065 | 2076 | 12 | 91,541 | 45 | |
| Off site | N/A | | | | | | |
| Removal of T Tank Farm (CLO_REMTT) | | | | | | | |
| Radiological workers | 692,733 | 2126 | 2137 | 12 | 57,728 | 28 | 73 |
| Nonradiological workers | | | | | | | |
| On site | 1,098,495 | 2126 | 2137 | 12 | 91,541 | 45 | |
| Off site | N/A | | | | | | |
| Removal of BY Tank Farm (CLO_REMTBY) | | | | | | | |
| Radiological workers | 519,550 | 2111 | 2122 | 12 | 43,296 | 21 | 55 |
| Nonradiological workers | | | | | | | |
| On site | 823,871 | 2111 | 2122 | 12 | 68,656 | 34 | |
| Off site | N/A | | | | | | |
| Removal of BX Tank Farm (CLO_REMTBX) | | | | | | | |
| Radiological workers | 519,550 | 2042 | 2053 | 12 | 43,296 | 21 | 55 |
| Nonradiological workers | | | | | | | |
| On site | 823,871 | 2042 | 2053 | 12 | 68,656 | 34 | |
| Off site | N/A | | | | | | |
| Removal of C Tank Farm (CLO_REMTC) | | | | | | | |
| Radiological workers | 692,733 | 2088 | 2099 | 12 | 57,728 | 28 | 73 |
| Nonradiological workers | | | | | | | |
| On site | 1,098,495 | 2088 | 2099 | 12 | 91,541 | 45 | |
| Off site | N/A | | | | | | |
| Removal of A Tank Farm (CLO_REMTA) | | | | | | | |
| Radiological workers | 259,775 | 2142 | 2153 | 12 | 21,648 | 11 | 28 |
| Nonradiological workers | | | | | | | |
| On site | 411,936 | 2142 | 2153 | 12 | 34,328 | 17 | |
| Off site | N/A | | | | | | |

**Table I-40. Tank Closure Alternative 6A, Option Case, Closure Rollup
Workforce Estimate (continued)**

| Activity | Total Hours | Duration | | | Hours per Year | Full-Time Equivalents per Year | Onsite Full-Time Equivalents |
|---|-------------|----------|--------|-------|----------------|--------------------------------|------------------------------|
| | | Start | Finish | Years | | | |
| Removal of AX Tank Farm (CLO_REMTAX) | | | | | | | |
| Radiological workers | 173,183 | 2142 | 2153 | 12 | 14,432 | 7 | 19 |
| Nonradiological workers | | | | | | | |
| On site | 274,624 | 2142 | 2153 | 12 | 22,885 | 12 | |
| Off site | N/A | | | | | | |
| Removal of S Tank Farm (CLO_REMTS) | | | | | | | |
| Radiological workers | 519,550 | 2126 | 2137 | 12 | 43,296 | 21 | 55 |
| Nonradiological workers | | | | | | | |
| On site | 823,871 | 2126 | 2137 | 12 | 68,656 | 34 | |
| Off site | N/A | | | | | | |
| Removal of TY Tank Farm (CLO_REMTTY) | | | | | | | |
| Radiological workers | 259,775 | 2111 | 2122 | 12 | 21,648 | 11 | 28 |
| Nonradiological workers | | | | | | | |
| On site | 411,936 | 2111 | 2122 | 12 | 34,328 | 17 | |
| Off site | N/A | | | | | | |
| Removal of TX Tank Farm (CLO_REMTTX) | | | | | | | |
| Radiological workers | 779,325 | 2088 | 2099 | 12 | 64,944 | 32 | 82 |
| Nonradiological workers | | | | | | | |
| On site | 1,235,807 | 2088 | 2099 | 12 | 102,984 | 50 | |
| Off site | N/A | | | | | | |
| Removal of U Tank Farm (CLO_REMTU) | | | | | | | |
| Radiological workers | 692,733 | 2065 | 2076 | 12 | 57,728 | 28 | 73 |
| Nonradiological workers | | | | | | | |
| On site | 1,098,495 | 2065 | 2076 | 12 | 91,541 | 45 | |
| Off site | N/A | | | | | | |
| Removal of SX Tank Farm (CLO_REMTSX) | | | | | | | |
| Radiological workers | 649,437 | 2042 | 2053 | 12 | 54,120 | 27 | 69 |
| Nonradiological workers | | | | | | | |
| On site | 1,029,839 | 2042 | 2053 | 12 | 85,820 | 42 | |
| Off site | N/A | | | | | | |
| Removal of Deep Soil-B Tank Farm (CLO_REMSB) | | | | | | | |
| Radiological workers | 73,371 | 2077 | 2084 | 8 | 9,171 | 5 | 11 |
| Nonradiological workers | | | | | | | |
| On site | 84,852 | 2077 | 2084 | 8 | 10,607 | 6 | |
| Off site | N/A | | | | | | |
| Removal of Deep Soil-T Tank Farm (CLO_REMST) | | | | | | | |
| Radiological workers | 563,796 | 2138 | 2145 | 8 | 70,474 | 34 | 74 |
| Nonradiological workers | | | | | | | |
| On site | 652,024 | 2138 | 2145 | 8 | 81,503 | 40 | |
| Off site | N/A | | | | | | |

Draft Tank Closure and Waste Management Environmental Impact Statement for the
Hanford Site, Richland, Washington

**Table I-40. Tank Closure Alternative 6A, Option Case, Closure Rollup
Workforce Estimate (continued)**

| Activity | Total Hours | Duration | | | Hours per Year | Full-Time Equivalents per Year | Onsite Full-Time Equivalents |
|---|-------------|----------|--------|-------|----------------|--------------------------------|------------------------------|
| | | Start | Finish | Years | | | |
| Removal of Deep Soil-BX Tank Farm (CLO_REMSBX) | | | | | | | |
| Radiological workers | 293,483 | 2054 | 2061 | 8 | 36,685 | 18 | 39 |
| Nonradiological workers | | | | | | | |
| On site | 339,410 | 2054 | 2061 | 8 | 42,426 | 21 | |
| Off site | N/A | | | | | | |
| Removal of Deep Soil-C Tank Farm (CLO_REMSC) | | | | | | | |
| Radiological workers | 4,449 | 2100 | 2107 | 8 | 556 | 1 | 2 |
| Nonradiological workers | | | | | | | |
| On site | 5,145 | 2100 | 2107 | 8 | 643 | 1 | |
| Off site | N/A | | | | | | |
| Removal of Deep Soil-A Tank Farm (CLO_REMSA) | | | | | | | |
| Radiological workers | 13,346 | 2154 | 2161 | 8 | 1,668 | 1 | 2 |
| Nonradiological workers | | | | | | | |
| On site | 15,434 | 2154 | 2161 | 8 | 1,929 | 1 | |
| Off site | N/A | | | | | | |
| Removal of Deep Soil-AX Tank Farm (CLO_REMSAX) | | | | | | | |
| Radiological workers | 222,429 | 2154 | 2161 | 8 | 27,804 | 14 | 30 |
| Nonradiological workers | | | | | | | |
| On site | 257,237 | 2154 | 2161 | 8 | 32,155 | 16 | |
| Off site | N/A | | | | | | |
| Removal of Deep Soil-TX Tank Farm (CLO_REMSTX) | | | | | | | |
| Radiological workers | 700,651 | 2100 | 2107 | 8 | 87,581 | 43 | 92 |
| Nonradiological workers | | | | | | | |
| On site | 810,297 | 2100 | 2107 | 8 | 101,287 | 49 | |
| Off site | N/A | | | | | | |
| Removal of Deep Soil-U Tank Farm (CLO_REMSU) | | | | | | | |
| Radiological workers | 367,008 | 2077 | 2084 | 8 | 45,876 | 23 | 49 |
| Nonradiological workers | | | | | | | |
| On site | 424,441 | 2077 | 2084 | 8 | 53,055 | 26 | |
| Off site | N/A | | | | | | |
| Removal of Deep Soil-SX Tank Farm (CLO_REMSSX) | | | | | | | |
| Radiological workers | 895,895 | 2054 | 2061 | 8 | 111,987 | 54 | 117 |
| Nonradiological workers | | | | | | | |
| On site | 1,036,093 | 2054 | 2061 | 8 | 129,512 | 63 | |
| Off site | N/A | | | | | | |
| Clean Closure of B Area Cribs and Trenches (Ditches) (CLO_REMBC&T) | | | | | | | |
| Radiological workers | 4,003,722 | 2054 | 2084 | 31 | 129,152 | 63 | 135 |
| Nonradiological workers | | | | | | | |
| On site | 4,630,266 | 2054 | 2084 | 31 | 149,363 | 72 | |
| Off site | N/A | | | | | | |
| Clean Closure of T Area Cribs and Trenches (Ditches) (CLO_REMTC&T) | | | | | | | |
| Radiological workers | 4,003,722 | 2100 | 2145 | 46 | 87,037 | 42 | 91 |
| Nonradiological workers | | | | | | | |
| On site | 4,630,266 | 2100 | 2145 | 46 | 100,658 | 49 | |
| Off site | N/A | | | | | | |

Table I-40. Tank Closure Alternative 6A, Option Case, Closure Rollup Workforce Estimate (continued)

| Activity | Total Hours | Duration | | | Hours per Year | Full-Time Equivalents per Year | Onsite Full-Time Equivalents |
|--|--------------------|----------|--------|-------|-------------------|--------------------------------|------------------------------|
| | | Start | Finish | Years | | | |
| Containment Structure Construction—B and T Area Cribs and Trenches (Ditches) (CLO_CONCS2)^c | | | | | | | |
| Radiological workers | 4,000 | 2050 | 2099 | 8 | 500 | 1 | 4 |
| Nonradiological workers | | | | | | | |
| On site | 40,000 | 2050 | 2099 | 8 | 5,000 | 3 | |
| Off site | N/A | | | | | | |
| Decontamination and Decommissioning of the Structure over the Tank Farm after Soil Removal (CLO_DEACS2)^d | | | | | | | |
| Radiological workers | 4,000 | 2085 | 2148 | 6 | 667 | 1 | 5 |
| Nonradiological workers | | | | | | | |
| On site | 40,000 | 2085 | 2148 | 6 | 6,667 | 4 | |
| Off site | N/A | | | | | | |
| Preprocessing Facility Construction (CLO_CONPPF) | | | | | | | |
| Radiological workers | N/A | | | | | | 4,778 |
| Nonradiological workers | | | | | | | |
| On site | 29,809,609 | 2039 | 2041 | 3 | 9,936,536 | 4,778 | |
| Off site | 10,070,814 | 2039 | 2041 | 3 | 3,356,938 | 1,614 | |
| Preprocessing Facility Operations (CLO_OPSPPF) | | | | | | | |
| Radiological workers | 50,386,336 | 2042 | 2162 | 121 | 416,416 | 201 | 208 |
| Nonradiological workers | | | | | | | |
| On site | 1,550,349 | 2042 | 2162 | 121 | 12,813 | 7 | |
| Off site | N/A | | | | | | |
| Preprocessing Facility Deactivation (CLO_DEAPPF) | | | | | | | |
| Radiological workers | 380,160 | 2163 | 2163 | 1 | 380,160 | 183 | 189 |
| Nonradiological workers | | | | | | | |
| On site | 11,697 | 2163 | 2163 | 1 | 11,697 | 6 | |
| Off site | N/A | | | | | | |
| Total | 133,539,179 | | | | 16,864,930 | 8,144 | 6,526 |

^a CLO_CONCS1 activities are conducted over six 4-year periods, totaling 24 years.

- Period 1, 2038–2041; 2 facilities
- Period 2, 2061–2064; 2 facilities
- Period 3, 2084–2087; 2 facilities
- Period 4, 2107–2110; 2 facilities
- Period 5, 2122–2125; 2 facilities
- Period 6, 2138–2141; 2 facilities

^b CLO_DEACS1 activities are conducted over seven 3-year periods, totaling 21 years.

- Period 1, 2062–2064; 2 facilities
- Period 2, 2085–2087; 2 facilities
- Period 3, 2108–2110; 2 facilities
- Period 4, 2123–2125; 2 facilities
- Period 5, 2138–2140; 1 facility
- Period 6, 2146–2148; 1 facility
- Period 7, 2162–2164; 2 facilities

^c CLO_CONCS2 activities are conducted over two 4-year periods, totaling 8 years.

- Period 1, 2050–2053; 2 facilities
- Period 2, 2096–2099; 2 facilities

^d CLO_DEACS2 activities are conducted over two 3-year periods, totaling 6 years.

- Period 1, 2085–2087; 2 facilities
- Period 2, 2146–2148; 2 facilities

**Table I-40. Tank Closure Alternative 6A, Option Case, Closure Rollup
Workforce Estimate (continued)**

Notes and Assumptions:

Total number of offsite full-time equivalents = 811.

Hours worked per year = 2,080.

One full-time equivalent was assumed for activities estimated to require less than 2,080 hours per year.

Key: N/A=not applicable.

Source: Compiled from SAIC 2007a, 2008.

**I.2.11 Tank Closure Alternative 6B: All Vitrification with Separations;
Clean Closure–Base Case**

Table I-41. Tank Closure Alternative 6B, Base Case, Construction Rollup Workforce Estimate

| Activity | Total Hours | Duration | | | Hours per Year | Full-Time Equivalents per Year | Onsite Full-Time Equivalents |
|--|-------------|----------|--------|-------|----------------|--------------------------------|------------------------------|
| | | Start | Finish | Years | | | |
| Canister Storage Building (CON_CSB) | | | | | | | |
| Radiological workers | 115,500 | 2006 | 2016 | 11 | 10,500 | 6 | 12 |
| Nonradiological workers | | | | | | | |
| On site | 135,929 | 2006 | 2016 | 11 | 12,357 | 6 | |
| Off site | 50,286 | 2006 | 2016 | 11 | 4,571 | 3 | |
| Immobilized High-Level Radioactive Waste Shipping/Transfer Facility (CON_STF) | | | | | | | |
| Radiological workers | N/A | | | | | | 380 |
| Nonradiological workers | | | | | | | |
| Onsite construction | 1,757,000 | 2011 | 2013 | 3 | 585,667 | 282 | |
| Onsite exempt | 610,000 | 2011 | 2013 | 3 | 203,333 | 98 | |
| Offsite design | 748,000 | 2011 | 2013 | 3 | 249,333 | 120 | |
| Immobilized High-Level Radioactive Waste Interim Storage Modules (CON_ISM) | | | | | | | |
| Radiological workers | N/A | | | | | | 232 |
| Nonradiological workers | | | | | | | |
| Onsite construction | 2,671,659 | 2014 | 2022 | 9 | 296,851 | 143 | |
| Onsite exempt | 1,650,000 | 2014 | 2022 | 9 | 183,333 | 89 | |
| Offsite design | 2,025,000 | 2014 | 2022 | 9 | 225,000 | 109 | |
| Other Infrastructure Upgrades (CON_OIU) | | | | | | | |
| Radiological workers | 782,094 | 2006 | 2034 | 29 | 26,969 | 13 | 45 |
| Nonradiological workers | | | | | | | |
| On site | 1,918,531 | 2006 | 2034 | 29 | 66,156 | 32 | |
| Off site | 743,125 | 2006 | 2034 | 29 | 25,625 | 13 | |
| Tank Upgrades (CON_TU) | | | | | | | |
| Radiological workers | 1,195,652 | 2006 | 2025 | 20 | 59,783 | 29 | 104 |
| Nonradiological workers | | | | | | | |
| On site | 3,112,174 | 2006 | 2025 | 20 | 155,609 | 75 | |
| Off site | 1,179,130 | 2006 | 2025 | 20 | 58,957 | 29 | |
| Underground Transfer Lines (CON_UTL) | | | | | | | |
| Radiological workers | N/A | | | | | | 61 |
| Nonradiological workers | | | | | | | |
| On site | 126,005 | 2009 | 2009 | 1 | 126,005 | 61 | |
| Off site | 17,400 | 2009 | 2009 | 1 | 17,400 | 9 | |

Table I-41. Tank Closure Alternative 6B, Base Case, Construction Rollup Workforce Estimate (continued)

| Activity | Total Hours | Duration | | | Hours per Year | Full-Time Equivalents per Year | Onsite Full-Time Equivalents |
|---|-------------|----------|--------|-------|----------------|--------------------------------|------------------------------|
| | | Start | Finish | Years | | | |
| Waste Treatment Plant (CON_WTP) | | | | | | | |
| Radiological workers | N/A | | | | | | |
| Nonradiological workers | | | | | | | 1,189 |
| On site | 29,672,500 | 2006 | 2017 | 12 | 2,472,708 | 1,189 | |
| Off site | 9,927,500 | 2006 | 2017 | 12 | 827,292 | 398 | |
| Additional Low-Activity Waste Melters (CON_LAW) | | | | | | | |
| Radiological workers | N/A | | | | | | |
| Nonradiological workers | | | | | | | 340 |
| On site | 7,064,246 | 2008 | 2017 | 10 | 706,425 | 340 | |
| Off site | 2,386,570 | 2008 | 2017 | 10 | 238,657 | 115 | |
| Cesium and Strontium Capsule Processing Facility (CON_CSC) | | | | | | | |
| Radiological workers | N/A | | | | | | |
| Nonradiological workers | | | | | | | 190 |
| On site | 1,578,029 | 2035 | 2038 | 4 | 394,507 | 190 | |
| Off site | 465,683 | 2035 | 2038 | 4 | 116,421 | 56 | |
| Waste Receiver Facilities (CON_WRF) | | | | | | | |
| Radiological workers | N/A | | | | | | |
| Nonradiological workers | | | | | | | 454 |
| On site | 4,716,000 | 2013 | 2017 | 5 | 943,200 | 454 | |
| Off site | 1,696,000 | 2013 | 2017 | 5 | 339,200 | 164 | |
| Tank Risers (CON_RIS) | | | | | | | |
| Radiological workers | 188,760 | 2013 | 2016 | 4 | 47,190 | 23 | |
| Nonradiological workers | | | | | | | 54 |
| On site | 254,540 | 2013 | 2016 | 4 | 63,635 | 31 | |
| Off site | N/A | | | | | | |
| Mobile Retrieval System (CON_MRS) | | | | | | | |
| Radiological workers | 21,731,780 | 2013 | 2043 | 31 | 701,025 | 338 | |
| Nonradiological workers | | | | | | | 711 |
| On site | 23,990,771 | 2013 | 2043 | 31 | 773,896 | 373 | |
| Off site | 12,864,061 | 2013 | 2043 | 31 | 414,970 | 200 | |
| Vacuum-Based Retrieval System (CON_VBR) | | | | | | | |
| Radiological workers | 11,196,200 | 2013 | 2043 | 31 | 361,168 | 174 | |
| Nonradiological workers | | | | | | | 360 |
| On site | 11,957,150 | 2013 | 2043 | 31 | 385,715 | 186 | |
| Off site | 6,817,400 | 2013 | 2043 | 31 | 219,916 | 106 | |
| Chemical Wash System (CON_CHW) | | | | | | | |
| Radiological workers | 2,378,750 | 2013 | 2043 | 31 | 76,734 | 37 | |
| Nonradiological workers | | | | | | | 45 |
| On site | 471,625 | 2013 | 2043 | 31 | 15,214 | 8 | |
| Off site | 634,875 | 2013 | 2043 | 31 | 20,480 | 10 | |

Draft Tank Closure and Waste Management Environmental Impact Statement for the
Hanford Site, Richland, Washington

**Table I-41. Tank Closure Alternative 6B, Base Case, Construction Rollup
Workforce Estimate (continued)**

| Activity | Total Hours | Duration | | | Hours per Year | Full-Time Equivalents per Year | Onsite Full-Time Equivalents |
|---|--------------------|----------|--------|-------|-------------------|--------------------------------|------------------------------|
| | | Start | Finish | Years | | | |
| High-Level Radioactive Waste Melter Interim Storage Facilities (CON_PAD)^a | | | | | | | |
| Radiological workers | N/A | | | | | | |
| Nonradiological workers | | | | | | | 1 |
| On site | 5,616 | 2015 | 2030 | 4 | 1,404 | 1 | |
| Off site | N/A | | | | | | |
| Effluent Treatment Facility Replacement (CON ETF) | | | | | | | |
| Radiological workers | N/A | | | | | | |
| Nonradiological workers | | | | | | | 329 |
| On site | 2,047,400 | 2023 | 2025 | 3 | 682,467 | 329 | |
| Off site | 703,895 | 2023 | 2025 | 3 | 234,632 | 113 | |
| Effluent Treatment Facility Replacement (CON ETFU)^b | | | | | | | |
| Radiological workers | N/A | | | | | | |
| Nonradiological workers | | | | | | | 329 |
| On site | 4,094,800 | 2053 | 2085 | 6 | 682,467 | 329 | |
| Off site | 736,162 | 2053 | 2085 | 6 | 122,694 | 59 | |
| 242-A Evaporator Replacement (CON EVA) | | | | | | | |
| Radiological workers | N/A | | | | | | |
| Nonradiological workers | | | | | | | 102 |
| On site | 635,400 | 2015 | 2017 | 3 | 211,800 | 102 | |
| Off site | 217,918 | 2015 | 2017 | 3 | 72,639 | 35 | |
| Immobilized Low-Activity Waste Interim Storage Facility (CON_ILAWST) | | | | | | | |
| Radiological workers | N/A | | | | | | |
| Nonradiological workers | | | | | | | 11 |
| On site | 602,600 | 2016 | 2043 | 28 | 21,521 | 11 | |
| Off site | N/A | | | | | | |
| High-Level Radioactive Waste Debris Storage Facilities (CON_HLWST) | | | | | | | |
| Radiological workers | N/A | | | | | | |
| Nonradiological workers | | | | | | | 4 |
| On site | 577,280 | 2021 | 2090 | 70 | 8,247 | 4 | |
| Off site | N/A | | | | | | |
| Total | 178,450,996 | | | | 13,463,671 | 6,492 | 4,953 |

^a CON_PAD Activities include two 2-year construction periods.

Period 1, 2015–2016

Period 2, 2029–2030

^b CON ETFU activities include two 3-year construction periods.

Period 1, 2053–2055

Period 2, 2083–2085

Notes and Assumptions:

Total number of offsite full-time equivalents = 1,539.

Hours worked per year = 2,080.

One full-time equivalent was assumed for activities estimated to require less than 2,080 hours per year.

Key: N/A=not applicable.

Source: Compiled from SAIC 2007a, 2008.

Table I–42. Tank Closure Alternative 6B, Base Case, Operations Rollup Workforce Estimate

| Activity | Total Hours | Duration | | | Hours per Year | Full-Time Equivalents per Year | Onsite Full-Time Equivalents |
|--|-------------|----------|--------|-------|----------------|--------------------------------|------------------------------|
| | | Start | Finish | Years | | | |
| Immobilized High-Level Radioactive Waste Interim Storage Facilities (OPS_ISF) | | | | | | | |
| Radiological workers | 7,779,436 | 2018 | 2066 | 49 | 158,764 | 77 | 120 |
| Nonradiological workers | | | | | | | |
| On site | 4,351,200 | 2018 | 2066 | 49 | 88,800 | 43 | |
| Off site | N/A | | | | | | |
| Other Infrastructure Upgrades (OPS_OIU) | | | | | | | |
| Radiological workers | 44,909 | 2006 | 2043 | 38 | 1,182 | 1 | 4 |
| Nonradiological workers | | | | | | | |
| On site | 164,667 | 2006 | 2043 | 38 | 4,333 | 3 | |
| Off site | 117,455 | 2006 | 2043 | 38 | 3,091 | 2 | |
| Routine Operations (OPS_ROUT) | | | | | | | |
| Radiological workers | 9,880,000 | 2006 | 2043 | 38 | 260,000 | 125 | 651 |
| Nonradiological workers | | | | | | | |
| On site | 41,534,000 | 2006 | 2043 | 38 | 1,093,000 | 526 | |
| Off site | 5,890,000 | 2006 | 2043 | 38 | 155,000 | 75 | |
| Interim Stabilization/Double-Shell Tanks (OPS_IST) | | | | | | | |
| Radiological workers | 1,394,773 | 2006 | 2043 | 38 | 36,705 | 18 | 44 |
| Nonradiological workers | | | | | | | |
| On site | 1,995,864 | 2006 | 2043 | 38 | 52,523 | 26 | |
| Off site | 2,204,000 | 2006 | 2043 | 38 | 58,000 | 28 | |
| Retrieval Operations (OPS_RET) | | | | | | | |
| Radiological workers | 12,955 | 2006 | 2043 | 38 | 341 | 1 | 28 |
| Nonradiological workers | | | | | | | |
| On site | 2,111,591 | 2006 | 2043 | 38 | 55,568 | 27 | |
| Off site | 16,409 | 2006 | 2043 | 38 | 432 | 1 | |
| Waste Treatment Plant (OPS_WTP) | | | | | | | |
| Radiological workers | 62,753,000 | 2018 | 2043 | 26 | 2413,577 | 1,161 | 1,939 |
| Nonradiological workers | | | | | | | |
| On site | 42,074,000 | 2018 | 2043 | 26 | 1,618,231 | 778 | |
| Off site | 8,000 | 2018 | 2043 | 26 | 308 | 1 | |
| Waste Treatment Plant—Cesium and Strontium Capsules (OPS_WTPCSC) | | | | | | | |
| Radiological workers | 2,413,577 | 2040 | 2040 | 1 | 2,413,577 | 1,161 | 1,939 |
| Nonradiological workers | | | | | | | |
| On site | 1,618,231 | 2040 | 2040 | 1 | 1,168,231 | 778 | |
| Off site | 308 | 2040 | 2040 | 1 | 308 | 1 | |
| Cesium and Strontium Capsule Processing Facility (OPS_CSC) | | | | | | | |
| Radiological workers | 103,334 | 2039 | 2040 | 2 | 51,667 | 25 | 25 |
| Nonradiological workers | | | | | | | |
| On site | N/A | | | | | | |
| Off site | N/A | | | | | | |
| Mobile Retrieval System (OPS_MRS) | | | | | | | |
| Radiological workers | 13,871,116 | 2013 | 2043 | 31 | 447,455 | 216 | 411 |
| Nonradiological workers | | | | | | | |
| On site | 12,554,941 | 2013 | 2043 | 31 | 404,998 | 195 | |
| Off site | N/A | | | | | | |

Draft Tank Closure and Waste Management Environmental Impact Statement for the
Hanford Site, Richland, Washington

**Table I-42. Tank Closure Alternative 6B, Base Case, Operations Rollup
Workforce Estimate (continued)**

| Activity | Total Hours | Duration | | | Hours per Year | Full-Time Equivalents per Year | Onsite Full-Time Equivalents |
|---|--------------------|----------|--------|-------|-------------------|--------------------------------|------------------------------|
| | | Start | Finish | Years | | | |
| Vacuum-Based Retrieval System (OPS_VBR) | | | | | | | |
| Radiological workers | 7,667,884 | 2013 | 2043 | 31 | 247,351 | 119 | 227 |
| Nonradiological workers | | | | | | | |
| On site | 6,940,309 | 2013 | 2043 | 31 | 223,881 | 108 | |
| Off site | N/A | | | | | | |
| Chemical Wash System (OPS_CHW) | | | | | | | |
| Radiological workers | 10,769,500 | 2013 | 2043 | 31 | 347,403 | 168 | 320 |
| Nonradiological workers | | | | | | | |
| On site | 9,747,750 | 2013 | 2043 | 31 | 314,444 | 152 | |
| Off site | N/A | | | | | | |
| High-Level Radioactive Waste Melter Interim Storage Facilities (OPS_PAD) | | | | | | | |
| Radiological workers | N/A | 2018 | 2199 | 182 | | | 0 |
| Nonradiological workers | | | | | | | |
| On site | N/A | | | | | | |
| Off site | N/A | | | | | | |
| Effluent Treatment Facility Replacement (OPS ETF) | | | | | | | |
| Radiological workers | 14,683,200 | 2006 | 2100 | 95 | 154,560 | 75 | 94 |
| Nonradiological workers | | | | | | | |
| On site | 3,670,800 | 2006 | 2100 | 95 | 38,640 | 19 | |
| Off site | N/A | | | | | | |
| 242-A Evaporator Replacement (OPS_EVA) | | | | | | | |
| Radiological workers | 1,858,033 | 2006 | 2043 | 38 | 48,896 | 24 | 32 |
| Nonradiological workers | | | | | | | |
| On site | 568,233 | 2006 | 2043 | 38 | 14,954 | 8 | |
| Off site | N/A | | | | | | |
| Borrow Area C (OPS_CAREA) | | | | | | | |
| Radiological workers | N/A | | | | | | 43 |
| Nonradiological workers | | | | | | | |
| On site | 8,671,800 | 2006 | 2102 | 97 | 89,400 | 43 | |
| Off site | N/A | | | | | | |
| High-level Radioactive Waste Debris Storage Facility (OPS_ILAWST) | | | | | | | |
| Radiological workers | N/A | 2018 | 2199 | 182 | | | |
| Nonradiological workers | | | | | | | |
| On site | N/A | | | | | | |
| Off site | N/A | | | | | | |
| High-Level Radioactive Waste Debris Storage Facilities (OPS_HLWST) | | | | | | | |
| Radiological workers | N/A | 2023 | 2199 | 177 | | | |
| Nonradiological workers | | | | | | | |
| On site | N/A | | | | | | |
| Off site | N/A | | | | | | |
| Total | 277,471,275 | | | | 12,415,618 | 5,985 | 5,877 |

Notes and Assumptions:

Total number of offsite full-time equivalents = 108.

Hours worked per year = 2,080.

One full-time equivalent was assumed for activities estimated to require less than 2,080 hours per year.

Key: N/A=not applicable.

Source: Compiled from SAIC 2007a, 2008.

Table I-43. Tank Closure Alternative 6B, Base Case, Deactivation Rollup Workforce Estimate

| Activity | Total Hours | Duration | | | Hours per Year | Full-Time Equivalents per Year | Onsite Full-Time Equivalents |
|--|------------------|----------|--------|-------|------------------|--------------------------------|------------------------------|
| | | Start | Finish | Years | | | |
| Immobilized High-Level Radioactive Waste Interim Storage Facilities (DEA_ISF) | | | | | | | |
| Radiological workers | N/A | | | | | | |
| Nonradiological workers | | | | | | | 1 |
| On site | 160 | 2067 | 2067 | 1 | 160 | 1 | |
| Off site | N/A | | | | | | |
| Waste Treatment Plant (DEA_WTP) | | | | | | | |
| Radiological workers | 3,800,000 | 2044 | 2045 | 2 | 1,900,000 | 914 | |
| Nonradiological workers | | | | | | | 1,527 |
| On site | 2,550,000 | 2044 | 2045 | 2 | 1,275,000 | 613 | |
| Off site | 500 | 2044 | 2045 | 2 | 250 | 1 | |
| Mobile Retrieval System (DEA_MRS) | | | | | | | |
| Radiological workers | 1,823,647 | 2013 | 2043 | 31 | 58,827 | 29 | |
| Nonradiological workers | | | | | | | 29 |
| On site | N/A | | | | | | |
| Off site | N/A | | | | | | |
| Vacuum-Based Retrieval System (DEA_VBR) | | | | | | | |
| Radiological workers | 258,100 | 2013 | 2043 | 31 | 8,326 | 5 | |
| Nonradiological workers | | | | | | | 5 |
| On site | N/A | | | | | | |
| Off site | N/A | | | | | | |
| Chemical Wash System (DEA_CHW) | | | | | | | |
| Radiological workers | 144,000 | 2013 | 2043 | 31 | 4,645 | 3 | |
| Nonradiological workers | | | | | | | 3 |
| On site | N/A | | | | | | |
| Off site | N/A | | | | | | |
| Cesium and Strontium Capsule Processing Facility (DEA_CSC) | | | | | | | |
| Radiological workers | 23,920 | 2041 | 2041 | 1 | 23,920 | 12 | |
| Nonradiological workers | | | | | | | 12 |
| On site | N/A | | | | | | |
| Off site | N/A | | | | | | |
| Effluent Treatment Facility Replacement (DEA ETF)^a | | | | | | | |
| Radiological workers | 309,120 | 2026 | 2101 | 4 | 77,280 | 38 | |
| Nonradiological workers | | | | | | | 48 |
| On site | 77,280 | 2026 | 2101 | 4 | 19,320 | 10 | |
| Off site | N/A | | | | | | |
| 242-A Evaporator (Original) (DEA_EVAO) | | | | | | | |
| Radiological workers | 24,448 | 2018 | 2018 | 1 | 24,448 | 12 | |
| Nonradiological workers | | | | | | | 16 |
| On site | 7,477 | 2018 | 2018 | 1 | 7,477 | 4 | |
| Off site | N/A | | | | | | |
| 242-A Evaporator Replacement (DEA_EVA) | | | | | | | |
| Radiological workers | 24,448 | 2044 | 2044 | 1 | 24,448 | 12 | |
| Nonradiological workers | | | | | | | 16 |
| On site | 7,477 | 2044 | 2044 | 1 | 7,477 | 4 | |
| Off site | N/A | | | | | | |
| Total | 9,050,577 | | | | 3,431,578 | 1,658 | 1,657 |

**Table I-43. Tank Closure Alternative 6B, Base Case, Deactivation Rollup
Workforce Estimate (continued)**

^a DEA ETF Activities include four 1-year periods.
Period 1, 2026–2026
Period 2, 2056–2056
Period 3, 2086–2086
Period 4, 2101–2101

Notes and Assumptions:

Total number of offsite full-time equivalents = 1.
Hours worked per year = 2,080.

One full-time equivalent was assumed for activities estimated to require less than 2,080 hours per year.

Key: N/A=not applicable.

Source: Compiled from SAIC 2007a, 2008.

Table I-44. Tank Closure Alternative 6B, Base Case, Closure Rollup Workforce Estimate

| Activity | Total Hours | Duration | | | Hours per Year | Full-Time Equivalents per Year | Onsite Full-Time Equivalents |
|---|-------------|--|--------|-------|----------------|--------------------------------|------------------------------|
| | | Start | Finish | Years | | | |
| Containment Structure Construction (CLO_CONCS) | | | | | | | |
| Radiological workers | 12,000 | 2019 | 2076 | 12 | 1,000 | 1 | 6 |
| Nonradiological workers | | | | | | | |
| On site | 120,000 | 2019 | 2076 | 12 | 10,000 | 5 | |
| Off site | N/A | Three 4-year construction periods ^a | | | | | |
| Containment Structure Deactivation (CLO_DEACS) | | | | | | | |
| Radiological workers | 12,000 | 2043 | 2099 | 15 | 800 | 1 | 5 |
| Nonradiological workers | | | | | | | |
| On site | 120,000 | 2043 | 2099 | 15 | 8,000 | 4 | |
| Off site | N/A | Five 3-year deactivation periods ^b | | | | | |
| Decontamination and Decommissioning of 10 Selected Facilities (CLO_D&DTEN) | | | | | | | |
| Radiological workers | 44,418 | 2018 | 2028 | 11 | 4,038 | 2 | 9 |
| Nonradiological workers | | | | | | | |
| On site | 146,679 | 2018 | 2028 | 11 | 13,334 | 7 | |
| Off site | 78,970 | 2018 | 2028 | 11 | 7,179 | 4 | |
| Modified Resource Conservation and Recovery Act Subtitle C Barrier (CLO_RCRA) | | | | | | | |
| Radiological workers | 429,000 | 2100 | 2101 | 2 | 214,500 | 104 | 414 |
| Nonradiological workers | | | | | | | |
| On site | 1,287,000 | 2100 | 2101 | 2 | 643,500 | 310 | |
| Off site | N/A | | | | | | |
| Postclosure Care (CLO_POST) | | | | | | | |
| Radiological workers | N/A | | | | | | 3 |
| Nonradiological workers | | | | | | | |
| On site | 471,262 | 2102 | 2201 | 100 | 4,713 | 3 | |
| Off site | N/A | | | | | | |
| Removal of B Tank Farm (CLO_REMTB) | | | | | | | |
| Radiological workers | 692,733 | 2023 | 2034 | 12 | 57,728 | 28 | 73 |
| Nonradiological workers | | | | | | | |
| On site | 1,098,495 | 2023 | 2034 | 12 | 91,541 | 45 | |
| Off site | N/A | | | | | | |

**Table I-44. Tank Closure Alternative 6B, Base Case, Closure Rollup
Workforce Estimate (continued)**

| Activity | Total Hours | Duration | | | Hours per Year | Full-Time Equivalents per Year | Onsite Full-Time Equivalents |
|---|-------------|----------|--------|-------|----------------|--------------------------------|------------------------------|
| | | Start | Finish | Years | | | |
| Removal of T Tank Farm (CLO_REMTT) | | | | | | | |
| Radiological workers | 692,733 | 2077 | 2088 | 12 | 57,728 | 28 | 73 |
| Nonradiological workers | | | | | | | |
| On site | 1,098,495 | 2077 | 2088 | 12 | 91,541 | 45 | |
| Off site | N/A | | | | | | |
| Removal of BY Tank Farm (CLO_REMTBY) | | | | | | | |
| Radiological workers | 519,550 | 2050 | 2061 | 12 | 43,296 | 21 | 55 |
| Nonradiological workers | | | | | | | |
| On site | 823,871 | 2050 | 2061 | 12 | 68,656 | 34 | |
| Off site | N/A | | | | | | |
| Removal of BX Tank Farm (CLO_REMTBX) | | | | | | | |
| Radiological workers | 519,550 | 2023 | 2034 | 12 | 43,296 | 21 | 55 |
| Nonradiological workers | | | | | | | |
| On site | 823,871 | 2023 | 2034 | 12 | 68,656 | 34 | |
| Off site | N/A | | | | | | |
| Removal of C Tank Farm (CLO_REMTC) | | | | | | | |
| Radiological workers | 692,733 | 2050 | 2061 | 12 | 57,728 | 28 | 73 |
| Nonradiological workers | | | | | | | |
| On site | 1,098,495 | 2050 | 2061 | 12 | 91,541 | 45 | |
| Off site | N/A | | | | | | |
| Removal of A Tank Farm (CLO_REMTA) | | | | | | | |
| Radiological workers | 259,775 | 2077 | 2088 | 12 | 21,648 | 11 | 28 |
| Nonradiological workers | | | | | | | |
| On site | 411,936 | 2077 | 2088 | 12 | 34,328 | 17 | |
| Off site | N/A | | | | | | |
| Removal of AX Tank Farm (CLO_REMTAX) | | | | | | | |
| Radiological workers | 173,183 | 2077 | 2088 | 12 | 14,432 | 7 | 19 |
| Nonradiological workers | | | | | | | |
| On site | 274,624 | 2077 | 2088 | 12 | 22,885 | 12 | |
| Off site | N/A | | | | | | |
| Removal of S Tank Farm (CLO_REMTS) | | | | | | | |
| Radiological workers | 519,550 | 2077 | 2088 | 12 | 43,296 | 21 | 55 |
| Nonradiological workers | | | | | | | |
| On site | 823,871 | 2077 | 2088 | 12 | 68,656 | 34 | |
| Off site | N/A | | | | | | |
| Removal of TY Tank Farm (CLO_REMTTY) | | | | | | | |
| Radiological workers | 259,775 | 2050 | 2061 | 12 | 21,648 | 11 | 28 |
| Nonradiological workers | | | | | | | |
| On site | 411,936 | 2050 | 2061 | 12 | 34,328 | 17 | |
| Off site | N/A | | | | | | |
| Removal of TX Tank Farm (CLO_REMTTX) | | | | | | | |
| Radiological workers | 779,325 | 2050 | 2061 | 12 | 64,944 | 32 | 82 |
| Nonradiological workers | | | | | | | |
| On site | 1,235,807 | 2050 | 2061 | 12 | 102,984 | 50 | |
| Off site | N/A | | | | | | |

Draft Tank Closure and Waste Management Environmental Impact Statement for the
Hanford Site, Richland, Washington

**Table I-44. Tank Closure Alternative 6B, Base Case, Closure Rollup
Workforce Estimate (continued)**

| Activity | Total Hours | Duration | | | Hours per Year | Full-Time Equivalents per Year | Onsite Full-Time Equivalents |
|---|-------------|----------|--------|-------|----------------|--------------------------------|------------------------------|
| | | Start | Finish | Years | | | |
| Removal of U Tank Farm (CLO_REMTU) | | | | | | | |
| Radiological workers | 692,733 | 2023 | 2034 | 12 | 57,728 | 28 | 73 |
| Nonradiological workers | | | | | | | |
| On site | 1,098,495 | 2023 | 2034 | 12 | 91,541 | 45 | |
| Off site | N/A | | | | | | |
| Removal of SX Tank Farm (CLO_REMTSX) | | | | | | | |
| Radiological workers | 649,437 | 2023 | 2034 | 12 | 54,120 | 27 | 69 |
| Nonradiological workers | | | | | | | |
| On site | 1,029,839 | 2023 | 2034 | 12 | 85,820 | 42 | |
| Off site | N/A | | | | | | |
| Removal of Deep Soil-B Tank Farm (CLO_REMSB) | | | | | | | |
| Radiological workers | 73,371 | 2035 | 2042 | 8 | 9,171 | 5 | 11 |
| Nonradiological workers | | | | | | | |
| On site | 84,852 | 2035 | 2042 | 8 | 10,607 | 6 | |
| Off site | N/A | | | | | | |
| Removal of Deep Soil-T Tank Farm (CLO_REMST) | | | | | | | |
| Radiological workers | 563,796 | 2089 | 2096 | 8 | 70,474 | 34 | 74 |
| Nonradiological workers | | | | | | | |
| On site | 652,024 | 2089 | 2096 | 8 | 81,503 | 40 | |
| Off site | N/A | | | | | | |
| Removal of Deep Soil-BX Tank Farm (CLO_REMSBX) | | | | | | | |
| Radiological workers | 293,483 | 2035 | 2042 | 8 | 36,685 | 18 | 39 |
| Nonradiological workers | | | | | | | |
| On site | 339,410 | 2035 | 2042 | 8 | 42,426 | 21 | |
| Off site | N/A | | | | | | |
| Removal of Deep Soil-C Tank Farm (CLO_REMSC) | | | | | | | |
| Radiological workers | 4,449 | 2062 | 2069 | 8 | 556 | 1 | 2 |
| Nonradiological workers | | | | | | | |
| On site | 5,145 | 2062 | 2069 | 8 | 643 | 1 | |
| Off site | N/A | | | | | | |
| Removal of Deep Soil-A Tank Farm (CLO_REMSA) | | | | | | | |
| Radiological workers | 13,346 | 2089 | 2096 | 8 | 1,668 | 1 | 2 |
| Nonradiological workers | | | | | | | |
| On site | 15,434 | 2089 | 2096 | 8 | 1,929 | 1 | |
| Off site | N/A | | | | | | |
| Removal of Deep Soil-AX Tank Farm (CLO_REMSAX) | | | | | | | |
| Radiological workers | 222,429 | 2089 | 2096 | 8 | 27,804 | 14 | 30 |
| Nonradiological workers | | | | | | | |
| On site | 257,237 | 2089 | 2096 | 8 | 32,155 | 16 | |
| Off site | N/A | | | | | | |
| Removal of Deep Soil-TX Tank Farm (CLO_REMSTX) | | | | | | | |
| Radiological workers | 700,651 | 2062 | 2069 | 8 | 87,581 | 43 | 92 |
| Nonradiological workers | | | | | | | |
| On site | 810,297 | 2062 | 2069 | 8 | 101,287 | 49 | |
| Off site | N/A | | | | | | |

Table I-44. Tank Closure Alternative 6B, Base Case, Closure Rollup Workforce Estimate (continued)

| Activity | Total Hours | Duration | | | Hours per Year | Full-Time Equivalents per Year | Onsite Full-Time Equivalents |
|---|-------------------|----------|--------|-------|-------------------|--------------------------------|------------------------------|
| | | Start | Finish | Years | | | |
| Removal of Deep Soil–U Tank Farm (CLO_REMSU) | | | | | | | |
| Radiological workers | 367,008 | 2035 | 2042 | 8 | 45,876 | 23 | 49 |
| Nonradiological workers | | | | | | | |
| On site | 424,441 | 2035 | 2042 | 8 | 53,055 | 26 | |
| Off site | N/A | | | | | | |
| Removal of Deep Soil–SX Tank Farm (CLO_REMSX) | | | | | | | |
| Radiological workers | 895,895 | 2035 | 2042 | 8 | 111,987 | 54 | 117 |
| Nonradiological workers | | | | | | | |
| On site | 1,036,093 | 2035 | 2042 | 8 | 129,512 | 63 | |
| Off site | N/A | | | | | | |
| Preprocessing Facility Construction (CLO_CONPPF) | | | | | | | |
| Radiological workers | N/A | | | | | | 2,389 |
| Nonradiological workers | | | | | | | |
| On site | 14,904,804 | 2020 | 2022 | 3 | 4,968,268 | 2,389 | |
| Off site | 5,035,407 | 2020 | 2022 | 3 | 1,678,469 | 807 | |
| Preprocessing Facility Operations (CLO_OPSPPF) | | | | | | | |
| Radiological workers | 8,328,320 | 2023 | 2099 | 77 | 108,160 | 52 | 54 |
| Nonradiological workers | | | | | | | |
| On site | 256,256 | 2023 | 2099 | 77 | 3,328 | 2 | |
| Off site | N/A | | | | | | |
| Preprocessing Facility Deactivation (CLO_DEAPPF) | | | | | | | |
| Radiological workers | 108,160 | 2100 | 2100 | 1 | 108,160 | 52 | 54 |
| Nonradiological workers | | | | | | | |
| On site | 3,328 | 2100 | 2100 | 1 | 3,328 | 2 | |
| Off site | N/A | | | | | | |
| Total | 54,797,775 | | | | 10,011,765 | 4,844 | 4,033 |

^a CLO_CONCS activities include three 4-year periods.
 Period 1, 2019–2022
 Period 2, 2046–2049
 Period 3, 2073–2076

^b CLO_DEACS activities include five 3-year periods.
 Period 1, 2043–2045
 Period 2, 2062–2064
 Period 3, 2070–2072
 Period 4, 2089–2091
 Period 5, 2097–2099

Notes and Assumptions:

Total number of offsite full-time equivalents = 811.

Hours worked per year = 2,080.

One full-time equivalent was assumed for activities estimated to require less than 2,080 hours per year.

Key: N/A=not applicable.

Source: Compiled from SAIC 2007a, 2008.

I.2.12 Tank Closure Alternative 6B: All Vitrification with Separations; Clean Closure–Option Case

Table I–45. Tank Closure Alternative 6B, Option Case, Construction Rollup Workforce Estimate

| Activity | Total Hours | Duration | | | Hours per Year | Full-Time Equivalents per Year | Onsite Full-Time Equivalents |
|--|-------------|----------|--------|-------|----------------|--------------------------------|------------------------------|
| | | Start | Finish | Years | | | |
| Canister Storage Building (CON_CSB) | | | | | | | |
| Radiological workers | 115,500 | 2006 | 2016 | 11 | 10,500 | 6 | 12 |
| Nonradiological workers | | | | | | | |
| On site | 135,929 | 2006 | 2016 | 11 | 12,357 | 6 | |
| Off site | 50,286 | 2006 | 2016 | 11 | 4,571 | 3 | |
| Immobilized High-Level Radioactive Waste Shipping/Transfer Facility (CON_STF) | | | | | | | |
| Radiological workers | N/A | | | | | | 380 |
| Nonradiological workers | | | | | | | |
| Onsite construction | 1,757,000 | 2011 | 2013 | 3 | 585,667 | 282 | |
| Onsite exempt | 610,000 | 2011 | 2013 | 3 | 203,333 | 98 | |
| Offsite design | 748,000 | 2011 | 2013 | 3 | 249,333 | 120 | |
| Immobilized High-Level Radioactive Waste Interim Storage Modules (CON_ISM) | | | | | | | |
| Radiological workers | N/A | | | | | | 232 |
| Nonradiological workers | | | | | | | |
| Onsite construction | 2,671,659 | 2014 | 2022 | 9 | 296,851 | 143 | |
| Onsite exempt | 1,650,000 | 2014 | 2022 | 9 | 183,333 | 89 | |
| Offsite design | 2,025,000 | 2014 | 2022 | 9 | 225,000 | 109 | |
| Other Infrastructure Upgrades (CON_OIU) | | | | | | | |
| Radiological workers | 782,094 | 2006 | 2034 | 29 | 26,969 | 13 | 45 |
| Nonradiological workers | | | | | | | |
| On site | 1,918,531 | 2006 | 2034 | 29 | 66,156 | 32 | |
| Off site | 743,125 | 2006 | 2034 | 29 | 25,625 | 13 | |
| Tank Upgrades (CON_TU) | | | | | | | |
| Radiological workers | 1,195,652 | 2006 | 2025 | 20 | 59,783 | 29 | 104 |
| Nonradiological workers | | | | | | | |
| On site | 3,112,174 | 2006 | 2025 | 20 | 155,609 | 75 | |
| Off site | 1,179,130 | 2006 | 2025 | 20 | 58,957 | 29 | |
| Underground Transfer Lines (CON_UTL) | | | | | | | |
| Radiological workers | N/A | | | | | | 61 |
| Nonradiological workers | | | | | | | |
| On site | 126,005 | 2009 | 2009 | 1 | 126,005 | 61 | |
| Off site | 17,400 | 2009 | 2009 | 1 | 17,400 | 9 | |
| Waste Treatment Plant (CON_WTP) | | | | | | | |
| Radiological workers | N/A | | | | | | 1,189 |
| Nonradiological workers | | | | | | | |
| On site | 29,672,500 | 2006 | 2017 | 12 | 2,472,708 | 1,189 | |
| Off site | 9,927,500 | 2006 | 2017 | 12 | 827,292 | 398 | |

**Table I-45. Tank Closure Alternative 6B, Option Case, Construction Rollup
Workforce Estimate (continued)**

| Activity | Total Hours | Duration | | | Hours per Year | Full-Time Equivalents per Year | Onsite Full-Time Equivalents |
|---|-------------|----------|--------|-------|----------------|--------------------------------|------------------------------|
| | | Start | Finish | Years | | | |
| Additional Low-Activity Waste Melters (CON_LAW) | | | | | | | |
| Radiological workers | N/A | | | | | | |
| Nonradiological workers | | | | | | | 340 |
| On site | 7,064,246 | 2008 | 2017 | 10 | 706,425 | 340 | |
| Off site | 2,386,570 | 2008 | 2017 | 10 | 238,657 | 115 | |
| Cesium and Strontium Capsule Processing Facility (CON_CSC) | | | | | | | |
| Radiological workers | N/A | | | | | | |
| Nonradiological workers | | | | | | | 190 |
| On site | 1,578,029 | 2035 | 2038 | 4 | 394,507 | 190 | |
| Off site | 465,683 | 2035 | 2038 | 4 | 116,421 | 56 | |
| Waste Receiver Facilities (CON_WRF) | | | | | | | |
| Radiological workers | N/A | | | | | | |
| Nonradiological workers | | | | | | | 454 |
| On site | 4,716,000 | 2013 | 2017 | 5 | 943,200 | 454 | |
| Off site | 1,696,000 | 2013 | 2017 | 5 | 339,200 | 164 | |
| Tank Risers (CON_RIS) | | | | | | | |
| Radiological workers | 188,760 | 2013 | 2016 | 4 | 47,190 | 23 | |
| Nonradiological workers | | | | | | | 54 |
| On site | 254,540 | 2013 | 2016 | 4 | 63,635 | 31 | |
| Off site | N/A | | | | | | |
| Mobile Retrieval System (CON_MRS) | | | | | | | |
| Radiological workers | 21,731,780 | 2013 | 2043 | 31 | 701,025 | 338 | |
| Nonradiological workers | | | | | | | 711 |
| On site | 23,990,771 | 2013 | 2043 | 31 | 773,896 | 373 | |
| Off site | 12,864,061 | 2013 | 2043 | 31 | 414,970 | 200 | |
| Vacuum-Based Retrieval System (CON_VBR) | | | | | | | |
| Radiological workers | 11,196,200 | 2013 | 2043 | 31 | 361,168 | 174 | |
| Nonradiological workers | | | | | | | 360 |
| On site | 11,957,150 | 2013 | 2043 | 31 | 385,715 | 186 | |
| Off site | 6,817,400 | 2013 | 2043 | 31 | 219,916 | 106 | |
| Chemical Wash System (CON_CHW) | | | | | | | |
| Radiological workers | 2,378,750 | 2013 | 2043 | 31 | 76,734 | 37 | |
| Nonradiological workers | | | | | | | 45 |
| On site | 471,625 | 2013 | 2043 | 31 | 15,214 | 8 | |
| Off site | 634,875 | 2013 | 2043 | 31 | 20,480 | 10 | |
| High-Level Radioactive Waste Melter Interim Storage Facilities (CON_PAD)^a | | | | | | | |
| Radiological workers | N/A | | | | | | |
| Nonradiological workers | | | | | | | 1 |
| On site | 5,616 | 2015 | 2030 | 4 | 1,404 | 1 | |
| Off site | N/A | | | | | | |

Draft Tank Closure and Waste Management Environmental Impact Statement for the
Hanford Site, Richland, Washington

**Table I-45. Tank Closure Alternative 6B, Option Case, Construction Rollup
Workforce Estimate (continued)**

| Activity | Total Hours | Duration | | | Hours per Year | Full-Time Equivalents per Year | Onsite Full-Time Equivalents |
|---|--------------------|----------|--------|-------|-------------------|--------------------------------|------------------------------|
| | | Start | Finish | Years | | | |
| Effluent Treatment Facility Replacement (CON_ETF) | | | | | | | |
| Radiological workers | N/A | | | | | | |
| Nonradiological workers | | | | | | | 329 |
| On site | 2,047,400 | 2023 | 2025 | 3 | 682,467 | 329 | |
| Off site | 703,895 | 2023 | 2025 | 3 | 234,632 | 113 | |
| Effluent Treatment Facility Replacement (CON_ETFU)^b | | | | | | | |
| Radiological workers | N/A | | | | | | |
| Nonradiological workers | | | | | | | 329 |
| On site | 4,094,800 | 2053 | 2085 | 6 | 682,467 | 329 | |
| Off site | 736,162 | 2053 | 2085 | 6 | 122,694 | 59 | |
| 242-A Evaporator Replacement (CON_EVA) | | | | | | | |
| Radiological workers | N/A | | | | | | |
| Nonradiological workers | | | | | | | 102 |
| On site | 635,400 | 2015 | 2017 | 3 | 211,800 | 102 | |
| Off site | 217,918 | 2015 | 2017 | 3 | 72,639 | 35 | |
| Immobilized Low-Activity Waste Interim Storage Facility (CON_ILAWST) | | | | | | | |
| Radiological workers | N/A | | | | | | |
| Nonradiological workers | | | | | | | 11 |
| On site | 602,600 | 2016 | 2043 | 28 | 21,521 | 11 | |
| Off site | N/A | | | | | | |
| High-Level Radioactive Waste Debris Storage Facilities (CON_HLWST) | | | | | | | |
| Radiological workers | N/A | | | | | | |
| Nonradiological workers | | | | | | | 4 |
| On site | 577,280 | 2021 | 2090 | 70 | 8,247 | 4 | |
| Off site | N/A | | | | | | |
| Total | 178,450,996 | | | | 13,463,671 | 6,492 | 4,953 |

^a CON_PAD Activities include two 2-year construction periods.
Period 1, 2015–2016
Period 2, 2029–2030

^b CON_PAD Activities include two 3-year construction periods.
Period 1, 2053–2055
Period 2, 2083–2085

Notes and Assumptions:

Total number of offsite full-time equivalents = 1,539.

Hours worked per year = 2,080.

One full-time equivalent was assumed for activities estimated to require less than 2,080 hours per year.

Key: N/A=not applicable.

Source: Compiled from SAIC 2007a, 2008.

Table I-46. Tank Closure Alternative 6B, Option Case, Operations Rollup Workforce Estimate

| Activity | Total Hours | Duration | | | Hours per Year | Full-Time Equivalents per Year | Onsite Full-Time Equivalents |
|--|-------------|----------|--------|-------|----------------|--------------------------------|------------------------------|
| | | Start | Finish | Years | | | |
| Immobilized High-Level Radioactive Waste Interim Storage Facilities (OPS_ISF) | | | | | | | |
| Radiological workers | 7,779,436 | 2018 | 2066 | 49 | 158,764 | 77 | 120 |
| Nonradiological workers | | | | | | | |
| On site | 4,351,200 | 2018 | 2066 | 49 | 88,800 | 43 | |
| Off site | N/A | | | | | | |
| Other Infrastructure Upgrades (OPS_OIU) | | | | | | | |
| Radiological workers | 44,909 | 2006 | 2043 | 38 | 1,182 | 1 | 4 |
| Nonradiological workers | | | | | | | |
| On site | 164,667 | 2006 | 2043 | 38 | 4,333 | 3 | |
| Off site | 117,455 | 2006 | 2043 | 38 | 3,091 | 2 | |
| Routine Operations (OPS_ROUT) | | | | | | | |
| Radiological workers | 9,880,000 | 2006 | 2043 | 38 | 260,000 | 125 | 651 |
| Nonradiological workers | | | | | | | |
| On site | 41,534,000 | 2006 | 2043 | 38 | 1,093,000 | 526 | |
| Off site | 5,890,000 | 2006 | 2043 | 38 | 155,000 | 75 | |
| Interim Stabilization/Double-Shell Tanks (OPS_IST) | | | | | | | |
| Radiological workers | 1,394,773 | 2006 | 2043 | 38 | 36,705 | 18 | 44 |
| Nonradiological workers | | | | | | | |
| On site | 1,995,864 | 2006 | 2043 | 38 | 52,523 | 26 | |
| Off site | 2,204,000 | 2006 | 2043 | 38 | 58,000 | 28 | |
| Retrieval Operations (OPS_RET) | | | | | | | |
| Radiological workers | 12,955 | 2006 | 2043 | 38 | 341 | 1 | 28 |
| Nonradiological workers | | | | | | | |
| On site | 2,111,591 | 2006 | 2043 | 38 | 55,568 | 27 | |
| Off site | 16,409 | 2006 | 2043 | 38 | 432 | 1 | |
| Waste Treatment Plant (OPS_WTP) | | | | | | | |
| Radiological workers | 62,753,000 | 2018 | 2043 | 26 | 2,413,577 | 1,161 | 1,939 |
| Nonradiological workers | | | | | | | |
| On site | 42,074,000 | 2018 | 2043 | 26 | 1,618,231 | 778 | |
| Off site | 8,000 | 2018 | 2043 | 26 | 308 | 1 | |
| Waste Treatment Plant—Cesium and Strontium Capsules (OPS_WTPCSC) | | | | | | | |
| Radiological workers | 2,413,577 | 2040 | 2040 | 1 | 2,413,577 | 1,161 | 1,939 |
| Nonradiological workers | | | | | | | |
| On site | 1,618,231 | 2040 | 2040 | 1 | 1,168,231 | 778 | |
| Off site | 308 | 2040 | 2040 | 1 | 308 | 1 | |
| Cesium and Strontium Capsule Processing Facility (OPS_CSC) | | | | | | | |
| Radiological workers | 103,334 | 2039 | 2040 | 2 | 51,667 | 25 | 25 |
| Nonradiological workers | | | | | | | |
| On site | N/A | | | | | | |
| Off site | N/A | | | | | | |
| Mobile Retrieval System (OPS_MRS) | | | | | | | |
| Radiological workers | 13,871,116 | 2013 | 2043 | 31 | 447,455 | 216 | 411 |
| Nonradiological workers | | | | | | | |
| On site | 12,554,941 | 2013 | 2043 | 31 | 404,998 | 195 | |
| Off site | N/A | | | | | | |

Draft Tank Closure and Waste Management Environmental Impact Statement for the
Hanford Site, Richland, Washington

**Table I-46. Tank Closure Alternative 6B, Option Case, Operations Rollup
Workforce Estimate (continued)**

| Activity | Total Hours | Duration | | | Hours per Year | Full-Time Equivalents per Year | Onsite Full-Time Equivalents |
|---|--------------------|----------|--------|-------|-------------------|--------------------------------|------------------------------|
| | | Start | Finish | Years | | | |
| Vacuum-Based Retrieval System (OPS_VBR) | | | | | | | |
| Radiological workers | 7,667,884 | 2013 | 2043 | 31 | 247,351 | 119 | 227 |
| Nonradiological workers | | | | | | | |
| On site | 6,940,309 | 2013 | 2043 | 31 | 223,881 | 108 | |
| Off site | N/A | | | | | | |
| Chemical Wash System (OPS_CHW) | | | | | | | |
| Radiological workers | 10,769,500 | 2013 | 2043 | 31 | 347,403 | 168 | 320 |
| Nonradiological workers | | | | | | | |
| On site | 9,747,750 | 2013 | 2043 | 31 | 314,444 | 152 | |
| Off site | N/A | | | | | | |
| High-Level Radioactive Waste Melter Interim Storage Facilities (OPS_PAD) | | | | | | | |
| Radiological workers | N/A | 2018 | 2199 | 182 | | | 0 |
| Nonradiological workers | | | | | | | |
| On site | N/A | | | | | | |
| Off site | N/A | | | | | | |
| Effluent Treatment Facility Replacement (OPS ETF) | | | | | | | |
| Radiological workers | 14,683,200 | 2006 | 2100 | 95 | 154,560 | 75 | 94 |
| Nonradiological workers | | | | | | | |
| On site | 3,670,800 | 2006 | 2100 | 95 | 38,640 | 19 | |
| Off site | N/A | | | | | | |
| 242-A Evaporator Replacement (OPS_EVA) | | | | | | | |
| Radiological workers | 1,858,033 | 2006 | 2043 | 38 | 48,896 | 24 | 32 |
| Nonradiological workers | | | | | | | |
| On site | 568,233 | 2006 | 2043 | 38 | 14,954 | 8 | |
| Off site | N/A | | | | | | |
| Borrow Area C (OPS_CAREA) | | | | | | | |
| Radiological workers | N/A | | | | | | 43 |
| Nonradiological workers | | | | | | | |
| On site | 8,671,800 | 2006 | 2102 | 97 | 89,400 | 43 | |
| Off site | N/A | | | | | | |
| Immobilized Low-Activity Waste Interim Storage Facility (OPS_ILAWST) | | | | | | | |
| Radiological workers | N/A | 2018 | 2199 | 182 | N/A | | |
| Nonradiological workers | | | | | | | |
| On site | N/A | | | | | | |
| Off site | N/A | | | | | | |
| High-Level Radioactive Waste Debris Storage Facilities (OPS_HLWST) | | | | | | | |
| Radiological workers | N/A | 2023 | 2199 | 177 | N/A | | |
| Nonradiological workers | | | | | | | |
| On site | N/A | | | | | | |
| Off site | N/A | | | | | | |
| Total | 277,471,275 | | | | 12,415,618 | 5,985 | 5,877 |

Notes and Assumptions:

Total number of offsite full-time equivalents = 108.

Hours worked per year = 2,080.

One full-time equivalent was assumed for activities estimated to require less than 2,080 hours per year.

Key: N/A=not applicable.

Source: Compiled from SAIC 2007a, 2008.

Table I-47. Tank Closure Alternative 6B, Option Case, Deactivation Rollup Workforce Estimate

| Activity | Total Hours | Duration | | | Hours per Year | Full-Time Equivalents per Year | Onsite Full-Time Equivalents |
|--|-------------|----------|--------|-------|----------------|--------------------------------|------------------------------|
| | | Start | Finish | Years | | | |
| Immobilized High-Level Radioactive Waste Interim Storage Facilities (DEA_ISF) | | | | | | | |
| Radiological workers | N/A | | | | | | |
| Nonradiological workers | | | | | | | 1 |
| On site | 160 | 2067 | 2067 | 1 | 160 | 1 | |
| Off site | N/A | | | | | | |
| Waste Treatment Plant (DEA_WTP) | | | | | | | |
| Radiological workers | 3,800,000 | 2044 | 2045 | 2 | 1,900,000 | 914 | |
| Nonradiological workers | | | | | | | 1,527 |
| On site | 2,550,000 | 2044 | 2045 | 2 | 1,275,000 | 613 | |
| Off site | 500 | 2044 | 2045 | 2 | 250 | 1 | |
| Mobile Retrieval System (DEA_MRS) | | | | | | | |
| Radiological workers | 1,823,647 | 2013 | 2043 | 31 | 58,827 | 29 | |
| Nonradiological workers | | | | | | | 29 |
| On site | N/A | | | | | | |
| Off site | N/A | | | | | | |
| Vacuum-Based Retrieval System (DEA_VBR) | | | | | | | |
| Radiological workers | 258,100 | 2013 | 2043 | 31 | 8,326 | 5 | |
| Nonradiological workers | | | | | | | 5 |
| On site | N/A | | | | | | |
| Off site | N/A | | | | | | |
| Chemical Wash System (DEA_CHW) | | | | | | | |
| Radiological workers | 144,000 | 2013 | 2043 | 31 | 4,645 | 3 | |
| Nonradiological workers | | | | | | | 3 |
| On site | N/A | | | | | | |
| Off site | N/A | | | | | | |
| Cesium and Strontium Capsule Processing Facility (DEA_CSC) | | | | | | | |
| Radiological workers | 23,920 | 2041 | 2041 | 1 | 23,920 | 12 | |
| Nonradiological workers | | | | | | | 12 |
| On site | N/A | | | | | | |
| Off site | N/A | | | | | | |
| Effluent Treatment Facility Replacement (DEA ETF)^a | | | | | | | |
| Radiological workers | 309,120 | 2026 | 2101 | 4 | 77,280 | 38 | |
| Nonradiological workers | | | | | | | 48 |
| On site | 77,280 | 2026 | 2101 | 4 | 19,320 | 10 | |
| Off site | N/A | | | | | | |
| 242-A Evaporator (Original) (DEA_EVAO) | | | | | | | |
| Radiological workers | 24,448 | 2018 | 2018 | 1 | 24,448 | 12 | |
| Nonradiological workers | | | | | | | 16 |
| On site | 7,477 | 2018 | 2018 | 1 | 7,477 | 4 | |
| Off site | N/A | | | | | | |

**Table I-47. Tank Closure Alternative 6B, Option Case, Deactivation Rollup
Workforce Estimate (continued)**

| Activity | Total Hours | Duration | | | Hours per Year | Full-Time Equivalents per Year | Onsite Full-Time Equivalents |
|---|------------------|----------|--------|-------|------------------|--------------------------------|------------------------------|
| | | Start | Finish | Years | | | |
| 242-A Evaporator Replacement (DEA_EVA) | | | | | | | |
| Radiological workers | 24,448 | 2044 | 2044 | 1 | 24,448 | 12 | 16 |
| Nonradiological workers | | | | | | | |
| On site | 7,477 | 2044 | 2044 | 1 | 7,477 | 4 | |
| Off site | N/A | | | | | | |
| Total | 9,050,577 | | | | 3,431,578 | 1,658 | 1,657 |

^a DEA ETF Activities include four 1-year periods.

Period 1, 2026–2026

Period 2, 2056–2056

Period 3, 2086–2086

Period 4, 2101–2101

Notes and Assumptions:

Total number of offsite full-time equivalents = 1.

Hours worked per year = 2,080.

One full-time equivalent was assumed for activities estimated to require less than 2,080 hours per year.

Key: N/A=not applicable.

Source: Compiled from SAIC 2007a, 2008.

Table I-48. Tank Closure Alternative 6B, Option Case, Closure Rollup Workforce Estimate

| Activity | Total Hours | Duration | | | Hours per Year | Full-Time Equivalents per Year | Onsite Full-Time Equivalents |
|--|-------------|----------|--------|-------|----------------|--------------------------------|------------------------------|
| | | Start | Finish | Years | | | |
| Containment Structure Construction (CLO_CONCS1) Three 4-year construction periods^a | | | | | | | |
| Radiological workers | 12,000 | 2019 | 2076 | 12 | 1,000 | 1 | 6 |
| Nonradiological workers | | | | | | | |
| On site | 120,000 | 2019 | 2076 | 12 | 10,000 | 5 | |
| Off site | N/A | | | | | | |
| Containment Structure Deactivation (CLO_DEACS1) Five 3-year deactivation periods^b | | | | | | | |
| Radiological workers | 12,000 | 2043 | 2099 | 15 | 800 | 1 | 5 |
| Nonradiological workers | | | | | | | |
| On site | 120,000 | 2043 | 2099 | 15 | 8,000 | 4 | |
| Off site | N/A | | | | | | |
| Decontamination and Decommissioning of 10 Selected Facilities (CLO_D&DTEN) | | | | | | | |
| Radiological workers | 44,418 | 2018 | 2028 | 11 | 4,038 | 2 | 9 |
| Nonradiological workers | | | | | | | |
| On site | 146,679 | 2018 | 2028 | 11 | 13,334 | 7 | |
| Off site | 78,970 | 2018 | 2028 | 11 | 7,179 | 4 | |
| Removal of B Tank Farm (CLO_REMTB) | | | | | | | |
| Radiological workers | 692,733 | 2023 | 2034 | 12 | 57,728 | 28 | 73 |
| Nonradiological workers | | | | | | | |
| On site | 1,098,495 | 2023 | 2034 | 12 | 91,541 | 45 | |
| Off site | N/A | | | | | | |

**Table I-48. Tank Closure Alternative 6B, Option Case, Closure Rollup
Workforce Estimate (continued)**

| Activity | Total Hours | Duration | | | Hours per Year | Full-Time Equivalents per Year | Onsite Full-Time Equivalents |
|---|-------------|----------|--------|-------|----------------|--------------------------------|------------------------------|
| | | Start | Finish | Years | | | |
| Removal of T Tank Farm (CLO_REMTT) | | | | | | | |
| Radiological workers | 692,733 | 2077 | 2088 | 12 | 57,728 | 28 | 73 |
| Nonradiological workers | | | | | | | |
| On site | 1,098,495 | 2077 | 2088 | 12 | 91,541 | 45 | |
| Off site | N/A | | | | | | |
| Removal of BY Tank Farm (CLO_REMTBY) | | | | | | | |
| Radiological workers | 519,550 | 2050 | 2061 | 12 | 43,296 | 21 | 55 |
| Nonradiological workers | | | | | | | |
| On site | 823,871 | 2050 | 2061 | 12 | 68,656 | 34 | |
| Off site | N/A | | | | | | |
| Removal of BX Tank Farm (CLO_REMTBX) | | | | | | | |
| Radiological workers | 519,550 | 2023 | 2034 | 12 | 43,296 | 21 | 55 |
| Nonradiological workers | | | | | | | |
| On site | 823,871 | 2023 | 2034 | 12 | 68,656 | 34 | |
| Off site | N/A | | | | | | |
| Removal of C Tank Farm (CLO_REMTC) | | | | | | | |
| Radiological workers | 692,733 | 2050 | 2061 | 12 | 57,728 | 28 | 73 |
| Nonradiological workers | | | | | | | |
| On site | 1,098,495 | 2050 | 2061 | 12 | 91,541 | 45 | |
| Off site | N/A | | | | | | |
| Removal of A Tank Farm (CLO_REMTA) | | | | | | | |
| Radiological workers | 259,775 | 2077 | 2088 | 12 | 21,648 | 11 | 28 |
| Nonradiological workers | | | | | | | |
| On site | 411,936 | 2077 | 2088 | 12 | 34,328 | 17 | |
| Off site | N/A | | | | | | |
| Removal of AX Tank Farm (CLO_REMTAX) | | | | | | | |
| Radiological workers | 173,183 | 2077 | 2088 | 12 | 14,432 | 7 | 19 |
| Nonradiological workers | | | | | | | |
| On site | 274,624 | 2077 | 2088 | 12 | 22,885 | 12 | |
| Off site | N/A | | | | | | |
| Removal of S Tank Farm (CLO_REMTS) | | | | | | | |
| Radiological workers | 519,550 | 2077 | 2088 | 12 | 43,296 | 21 | 55 |
| Nonradiological workers | | | | | | | |
| On site | 823,871 | 2077 | 2088 | 12 | 68,656 | 34 | |
| Off site | N/A | | | | | | |
| Removal of TY Tank Farm (CLO_REMTTY) | | | | | | | |
| Radiological workers | 259,775 | 2050 | 2061 | 12 | 21,648 | 11 | 28 |
| Nonradiological workers | | | | | | | |
| On site | 411,936 | 2050 | 2061 | 12 | 34,328 | 17 | |
| Off site | N/A | | | | | | |
| Removal of TX Tank Farm (CLO_REMTTX) | | | | | | | |
| Radiological workers | 779,325 | 2050 | 2061 | 12 | 64,944 | 32 | 82 |
| Nonradiological workers | | | | | | | |
| On site | 1,235,807 | 2050 | 2061 | 12 | 102,984 | 50 | |
| Off site | N/A | | | | | | |

Draft Tank Closure and Waste Management Environmental Impact Statement for the
Hanford Site, Richland, Washington

**Table I-48. Tank Closure Alternative 6B, Option Case, Closure Rollup
Workforce Estimate (continued)**

| Activity | Total Hours | Duration | | | Hours per Year | Full-Time Equivalents per Year | Onsite Full-Time Equivalents |
|---|-------------|----------|--------|-------|----------------|--------------------------------|------------------------------|
| | | Start | Finish | Years | | | |
| Removal of U Tank Farm (CLO_REMTU) | | | | | | | |
| Radiological workers | 692,733 | 2023 | 2034 | 12 | 57,728 | 28 | 73 |
| Nonradiological workers | | | | | | | |
| On site | 1,098,495 | 2023 | 2034 | 12 | 91,541 | 45 | |
| Off site | N/A | | | | | | |
| Removal of SX Tank Farm (CLO_REMTSX) | | | | | | | |
| Radiological workers | 649,437 | 2023 | 2034 | 12 | 54,120 | 27 | 69 |
| Nonradiological workers | | | | | | | |
| On site | 1,029,839 | 2023 | 2034 | 12 | 85,820 | 42 | |
| Off site | N/A | | | | | | |
| Removal of Deep Soil-B Tank Farm (CLO_REMSB) | | | | | | | |
| Radiological workers | 73,371 | 2035 | 2042 | 8 | 9,171 | 5 | 11 |
| Nonradiological workers | | | | | | | |
| On site | 84,852 | 2035 | 2042 | 8 | 10,607 | 6 | |
| Off site | N/A | | | | | | |
| Removal of Deep Soil-T Tank Farm (CLO_REMST) | | | | | | | |
| Radiological workers | 563,796 | 2089 | 2096 | 8 | 70,474 | 34 | 74 |
| Nonradiological workers | | | | | | | |
| On site | 652,024 | 2089 | 2096 | 8 | 81,503 | 40 | |
| Off site | N/A | | | | | | |
| Removal of Deep Soil-BX Tank Farm (CLO_REMSBX) | | | | | | | |
| Radiological workers | 293,483 | 2035 | 2042 | 8 | 36,685 | 18 | 39 |
| Nonradiological workers | | | | | | | |
| On site | 339,410 | 2035 | 2042 | 8 | 42,426 | 21 | |
| Off site | N/A | | | | | | |
| Removal of Deep Soil-C Tank Farm (CLO_REMSC) | | | | | | | |
| Radiological workers | 4,449 | 2062 | 2069 | 8 | 556 | 1 | 2 |
| Nonradiological workers | | | | | | | |
| On site | 5,145 | 2062 | 2069 | 8 | 643 | 1 | |
| Off site | N/A | | | | | | |
| Removal of Deep Soil-A Tank Farm (CLO_REMSA) | | | | | | | |
| Radiological workers | 13,346 | 2089 | 2096 | 8 | 1,668 | 1 | 2 |
| Nonradiological workers | | | | | | | |
| On site | 15,434 | 2089 | 2096 | 8 | 1,929 | 1 | |
| Off site | N/A | | | | | | |
| Removal of Deep Soil-AX Tank Farm (CLO_REMSAX) | | | | | | | |
| Radiological workers | 222,429 | 2089 | 2096 | 8 | 27,804 | 14 | 30 |
| Nonradiological workers | | | | | | | |
| On site | 257,237 | 2089 | 2096 | 8 | 32,155 | 16 | |
| Off site | N/A | | | | | | |

Table I-48. Tank Closure Alternative 6B, Option Case, Closure Rollup Workforce Estimate (continued)

| Activity | Total Hours | Duration | | | Hours per Year | Full-Time Equivalents per Year | Onsite Full-Time Equivalents |
|--|-------------|----------|--------|-------|----------------|--------------------------------|------------------------------|
| | | Start | Finish | Years | | | |
| Removal of Deep Soil–TX Tank Farm (CLO_REMSTX) | | | | | | | |
| Radiological workers | 700,651 | 2062 | 2069 | 8 | 87,581 | 43 | 92 |
| Nonradiological workers | | | | | | | |
| On site | 810,297 | 2062 | 2069 | 8 | 101,287 | 49 | |
| Off site | N/A | | | | | | |
| Removal of Deep Soil–U Tank Farm (CLO_REMSU) | | | | | | | |
| Radiological workers | 367,008 | 2035 | 2042 | 8 | 45,876 | 23 | 49 |
| Nonradiological workers | | | | | | | |
| On site | 424,441 | 2035 | 2042 | 8 | 53,055 | 26 | |
| Off site | N/A | | | | | | |
| Removal of Deep Soil–SX Tank Farm (CLO_REMSSX) | | | | | | | |
| Radiological workers | 895,895 | 2035 | 2042 | 8 | 111,987 | 54 | 117 |
| Nonradiological workers | | | | | | | |
| On site | 1,036,093 | 2035 | 2042 | 8 | 129,512 | 63 | |
| Off site | N/A | | | | | | |
| Clean Closure of B Area Cribs and Trenches (Ditches) (CLO_REMBC&T) | | | | | | | |
| Radiological workers | 4,003,722 | 2035 | 2061 | 27 | 148,286 | 72 | 155 |
| Nonradiological workers | | | | | | | |
| On site | 4,630,266 | 2035 | 2061 | 27 | 171,491 | 83 | |
| Off site | N/A | | | | | | |
| Clean Closure of T Area Cribs and Trenches (Ditches) (CLO_REMTC&T) | | | | | | | |
| Radiological workers | 4,003,722 | 2062 | 2096 | 35 | 114,392 | 55 | 119 |
| Nonradiological workers | | | | | | | |
| On site | 4,630,266 | 2062 | 2096 | 35 | 132,293 | 64 | |
| Off site | N/A | | | | | | |
| Containment Structure Construction–B and T Area Cribs and Trenches (Ditches) (CLO_CONCS2)^c | | | | | | | |
| Radiological workers | 4,000 | 2029 | 2059 | 8 | 500 | 1 | 4 |
| Nonradiological workers | | | | | | | |
| On site | 40,000 | 2029 | 2059 | 8 | 5,000 | 3 | |
| Off site | N/A | | | | | | |
| Containment Structure Deactivation–T Area Cribs and Trenches (Ditches) (CLO_DEACS2)^d | | | | | | | |
| Radiological workers | 4,000 | 2062 | 2099 | 6 | 667 | 1 | 5 |
| Nonradiological workers | | | | | | | |
| On site | 40,000 | 2062 | 2099 | 6 | 6,667 | 4 | |
| Off site | N/A | | | | | | |
| Preprocessing Facility Construction (CLO_CONPPF) | | | | | | | |
| Radiological workers | N/A | | | | | | 4,778 |
| Nonradiological workers | | | | | | | |
| On site | 29,809,069 | 2020 | 2022 | 3 | 9,936,536 | 4,778 | |
| Off site | 10,070,814 | 2020 | 2022 | 3 | 3,356,938 | 1,614 | |
| Preprocessing Facility Operations (CLO_OPSPPF) | | | | | | | |
| Radiological workers | 29,272,320 | 2023 | 2099 | 77 | 380,160 | 183 | 189 |
| Nonradiological workers | | | | | | | |
| On site | 900,687 | 2023 | 2099 | 77 | 11,697 | 6 | |
| Off site | N/A | | | | | | |

**Table I-48. Tank Closure Alternative 6B, Option Case, Closure Rollup
Workforce Estimate (continued)**

| Activity | Total Hours | Duration | | | Hours per Year | Full-Time Equivalents per Year | Onsite Full-Time Equivalents |
|---|--------------------|----------|--------|-------|-------------------|--------------------------------|------------------------------|
| | | Start | Finish | Years | | | |
| Preprocessing Facility Deactivation (CLO_DEAPPF) | | | | | | | |
| Radiological workers | 380,160 | 2100 | 2100 | 1 | 380,160 | 183 | 189 |
| Nonradiological workers | | | | | | | |
| On site | 11,697 | 2100 | 2100 | 1 | 11,697 | 6 | |
| Off site | N/A | | | | | | |
| Total | 111,775,501 | | | | 16,935,824 | 8,176 | 6,558 |

^a CLO_CONCS1 activities include three 4-year periods.

Period 1, 2019–2022

Period 2, 2046–2049

Period 3, 2073–2076

^b CLO_DEACS1 activities include five 3-year periods.

Period 1, 2043–2045

Period 2, 2062–2064

Period 3, 2070–2072

Period 4, 2089–2091

Period 5, 2097–2099

^c CLO_CONCS2 activities include two 4-year periods.

Period 1, 2029–2032

Period 2, 2056–2059

^d CLO_DEACS2 activities include two 3-year periods.

Period 1, 2062–2064

Period 2, 2097–2099

Notes and Assumptions:

Total number of offsite full-time equivalents = 1,618.

Hours worked per year = 2,080.

One full-time equivalent was assumed for activities estimated to require less than 2,080 hours per year.

Key: N/A=not applicable.

Source: Compiled from SAIC 2007a, 2008.

I.2.13 Tank Closure Alternative 6C: All Vitrification with Separations; Landfill Closure

Table I-49. Tank Closure Alternative 6C Construction Rollup Workforce Estimate

| Activity | Total Hours | Duration | | | Hours per Year | Full-Time Equivalents per Year | Onsite Full-Time Equivalents |
|--|-------------|----------|--------|-------|----------------|--------------------------------|------------------------------|
| | | Start | Finish | Years | | | |
| Canister Storage Building (CON_CSB) | | | | | | | |
| Radiological workers | 115,500 | 2006 | 2016 | 11 | 10,500 | 6 | 12 |
| Nonradiological workers | | | | | | | |
| On site | 135,929 | 2006 | 2016 | 11 | 12,357 | 6 | |
| Off site | 50,286 | 2006 | 2016 | 11 | 4,571 | 3 | |
| Immobilized High-Level Radioactive Waste Shipping/Transfer Facility (CON_STF) | | | | | | | |
| Radiological workers | N/A | | | | | | 380 |
| Nonradiological workers | | | | | | | |
| Onsite construction | 1,757,000 | 2011 | 2013 | 3 | 585,667 | 282 | |
| Onsite exempt | 610,000 | 2011 | 2013 | 3 | 203,333 | 98 | |
| Offsite design | 748,000 | 2011 | 2013 | 3 | 249,333 | 120 | |

Table I-49. Tank Closure Alternative 6C Construction Rollup Workforce Estimate (continued)

| Activity | Total Hours | Duration | | | Hours per Year | Full-Time Equivalents per Year | Onsite Full-Time Equivalents |
|---|-------------|----------|--------|-------|----------------|--------------------------------|------------------------------|
| | | Start | Finish | Years | | | |
| Immobilized High-Level Radioactive Waste Interim Storage Modules (CON_ISM) | | | | | | | |
| Radiological workers | N/A | | | | | | |
| Nonradiological workers | | | | | | | |
| Onsite construction | 2,671,659 | 2014 | 2022 | 9 | 296,851 | 143 | 232 |
| Onsite exempt | 1,650,000 | 2014 | 2022 | 9 | 183,333 | 89 | |
| Offsite design | 2,025,000 | 2014 | 2022 | 9 | 225,000 | 109 | |
| Other Infrastructure Upgrades (CON_OIU) | | | | | | | |
| Radiological workers | 782,094 | 2006 | 2034 | 29 | 26,969 | 13 | |
| Nonradiological workers | | | | | | | 45 |
| On site | 1,918,531 | 2006 | 2034 | 29 | 66,156 | 32 | |
| Off site | 743,125 | 2006 | 2034 | 29 | 25,625 | 13 | |
| Tank Upgrades (CON_TU) | | | | | | | |
| Radiological workers | 1,195,652 | 2006 | 2025 | 20 | 59,783 | 29 | |
| Nonradiological workers | | | | | | | 104 |
| On site | 3,112,174 | 2006 | 2025 | 20 | 155,609 | 75 | |
| Off site | 1,179,130 | 2006 | 2025 | 20 | 58,957 | 29 | |
| Underground Transfer Lines (CON_UTL) | | | | | | | |
| Radiological workers | N/A | | | | | | |
| Nonradiological workers | | | | | | | 61 |
| On site | 126,005 | 2009 | 2009 | 1 | 126,005 | 61 | |
| Off site | 17,400 | 2009 | 2009 | 1 | 17,400 | 9 | |
| Waste Treatment Plant (CON_WTP) | | | | | | | |
| Radiological workers | N/A | | | | | | |
| Nonradiological workers | | | | | | | 1,189 |
| On site | 29,672,500 | 2006 | 2017 | 12 | 2,472,708 | 1,189 | |
| Off site | 9,927,500 | 2006 | 2017 | 12 | 827,292 | 398 | |
| Additional Low-Activity Waste Melters (CON_LAW) | | | | | | | |
| Radiological workers | N/A | | | | | | |
| Nonradiological workers | | | | | | | 340 |
| On site | 7,064,246 | 2008 | 2017 | 10 | 706,425 | 340 | |
| Off site | 2,386,570 | 2008 | 2017 | 10 | 238,657 | 115 | |
| Cesium and Strontium Capsule Processing Facility (CON_CSC) | | | | | | | |
| Radiological workers | N/A | | | | | | |
| Nonradiological workers | | | | | | | 190 |
| On site | 1,578,029 | 2035 | 2038 | 4 | 394,507 | 190 | |
| Off site | 465,683 | 2035 | 2038 | 4 | 116,421 | 56 | |
| Waste Receiver Facilities (CON_WRF) | | | | | | | |
| Radiological workers | N/A | | | | | | |
| Nonradiological workers | | | | | | | 454 |
| On site | 4,716,000 | 2013 | 2017 | 5 | 943,200 | 454 | |
| Off site | 1,696,000 | 2013 | 2017 | 5 | 339,200 | 164 | |

Draft Tank Closure and Waste Management Environmental Impact Statement for the
Hanford Site, Richland, Washington

Table I-49. Tank Closure Alternative 6C Construction Rollup Workforce Estimate (continued)

| Activity | Total Hours | Duration | | | Hours per Year | Full-Time Equivalents per Year | Onsite Full-Time Equivalents |
|---|--------------------|----------|--------|-------|-------------------|--------------------------------|------------------------------|
| | | Start | Finish | Years | | | |
| Tank Risers (CON_RIS) | | | | | | | |
| Radiological workers | 172,920 | 2013 | 2016 | 4 | 43,230 | 21 | 50 |
| Nonradiological workers | | | | | | | |
| On site | 233,180 | 2013 | 2016 | 4 | 58,295 | 29 | |
| Off site | N/A | | | | | | |
| Modified Sluicing Retrieval System (CON_MS) | | | | | | | |
| Radiological workers | 3,847,797 | 2013 | 2043 | 31 | 124,122 | 60 | 155 |
| Nonradiological workers | | | | | | | |
| On site | 6,076,615 | 2013 | 2043 | 31 | 196,020 | 95 | |
| Off site | 2,137,968 | 2013 | 2043 | 31 | 68,967 | 34 | |
| Mobile Retrieval System (CON_MRS) | | | | | | | |
| Radiological workers | 8,098,800 | 2013 | 2028 | 16 | 506,175 | 244 | 513 |
| Nonradiological workers | | | | | | | |
| On site | 8,940,660 | 2013 | 2028 | 16 | 558,791 | 269 | |
| Off site | 4,794,060 | 2013 | 2028 | 16 | 299,629 | 145 | |
| Vacuum-Based Retrieval System (CON_VBR) | | | | | | | |
| Radiological workers | 11,196,200 | 2029 | 2043 | 15 | 746,413 | 359 | 743 |
| Nonradiological workers | | | | | | | |
| On site | 11,957,150 | 2029 | 2043 | 15 | 797,143 | 384 | |
| Off site | 6,817,400 | 2029 | 2043 | 15 | 454,493 | 219 | |
| High-Level Radioactive Waste Melter Interim Storage Facilities (CON_PAD)^a | | | | | | | |
| Radiological workers | N/A | | | | | | 1 |
| Nonradiological workers | | | | | | | |
| On site | 5,616 | 2015 | 2030 | 4 | 1,404 | 1 | |
| Off site | N/A | | | | | | |
| Effluent Treatment Facility Replacement (CON ETF) | | | | | | | |
| Radiological workers | N/A | | | | | | 329 |
| Nonradiological workers | | | | | | | |
| On site | 2,047,400 | 2023 | 2025 | 3 | 682,467 | 329 | |
| Off site | 703,895 | 2023 | 2025 | 3 | 234,632 | 113 | |
| 242-A Evaporator Replacement (CON EVA) | | | | | | | |
| Radiological workers | N/A | | | | | | 102 |
| Nonradiological workers | | | | | | | |
| On site | 635,400 | 2015 | 2017 | 3 | 211,800 | 102 | |
| Off site | 217,918 | 2015 | 2017 | 3 | 72,639 | 35 | |
| Immobilized Low-Activity Waste Interim Storage Facility (CON_ILAWST) | | | | | | | |
| Radiological workers | N/A | | | | | | 11 |
| Nonradiological workers | | | | | | | |
| On site | 602,600 | 2016 | 2043 | 28 | 21,521 | 11 | |
| Off site | N/A | | | | | | |
| Total | 144,829,591 | | | | 13,423,601 | 6,473 | 4,911 |

^a CON_PAD activities include two 2-year periods.
Period 1, 2015–2016
Period 2, 2029–2030

Table I-49. Tank Closure Alternative 6C Construction Rollup Workforce Estimate (continued)

Notes and Assumptions:

Total number of offsite full-time equivalents = 1,562.

Hours worked per year = 2,080.

One full-time equivalent was assumed for activities estimated to require less than 2,080 hours per year.

Key: N/A=not applicable.

Source: Compiled from SAIC 2007a, 2008.

Table I-50. Tank Closure Alternative 6C Operations Rollup Workforce Estimate

| Activity | Total Hours | Duration | | | Hours per Year | Full-Time Equivalents per Year | Onsite Full-Time Equivalents |
|--|-------------|----------|--------|-------|----------------|--------------------------------|------------------------------|
| | | Start | Finish | Years | | | |
| Immobilized High-Level Radioactive Waste Interim Storage Facilities (OPS_ISF) | | | | | | | |
| Radiological workers | 7,779,436 | 2018 | 2066 | 49 | 158,764 | 77 | 120 |
| Nonradiological workers | | | | | | | |
| On site | 4,351,200 | 2018 | 2066 | 49 | 88,800 | 43 | |
| Off site | N/A | | | | | | |
| Other Infrastructure Upgrades (OPS_OIU) | | | | | | | |
| Radiological workers | 44,909 | 2006 | 2043 | 38 | 1,182 | 1 | 4 |
| Nonradiological workers | | | | | | | |
| On site | 164,667 | 2006 | 2043 | 38 | 4,333 | 3 | |
| Off site | 117,455 | 2006 | 2043 | 38 | 3,091 | 2 | |
| Routine Operations (OPS_ROUT) | | | | | | | |
| Radiological workers | 9,880,000 | 2006 | 2043 | 38 | 260,000 | 125 | 651 |
| Nonradiological workers | | | | | | | |
| On site | 41,534,000 | 2006 | 2043 | 38 | 1,093,000 | 526 | |
| Off site | 5,890,000 | 2006 | 2043 | 38 | 155,000 | 75 | |
| Retrieval Operations (OPS_RET) | | | | | | | |
| Radiological workers | 12,955 | 2006 | 2043 | 38 | 341 | 1 | 28 |
| Nonradiological workers | | | | | | | |
| On site | 2,111,591 | 2006 | 2043 | 38 | 55,568 | 27 | |
| Off site | 16,409 | 2006 | 2043 | 38 | 432 | 1 | |
| Interim Stabilization/Double-Shell Tanks (OPS_IST) | | | | | | | |
| Radiological workers | 1,394,773 | 2006 | 2043 | 38 | 36,705 | 18 | 44 |
| Nonradiological workers | | | | | | | |
| On site | 1,995,864 | 2006 | 2043 | 38 | 52,523 | 26 | |
| Off site | 2,204,000 | 2006 | 2043 | 38 | 58,000 | 28 | |
| Waste Treatment Plant (OPS_WTP) | | | | | | | |
| Radiological workers | 62,753,000 | 2018 | 2043 | 26 | 2,413,577 | 1,161 | 1,939 |
| Nonradiological workers | | | | | | | |
| On site | 42,074,000 | 2018 | 2043 | 26 | 1,618,231 | 778 | |
| Off site | 8,000 | 2018 | 2043 | 26 | 308 | 1 | |
| Waste Treatment Plant—Cesium and Strontium Capsules (OPS_WTPCSC) | | | | | | | |
| Radiological workers | 2,413,577 | 2040 | 2040 | 1 | 2,413,577 | 1,161 | 1,939 |
| Nonradiological workers | | | | | | | |
| On site | 1,618,231 | 2040 | 2040 | 1 | 1,618,231 | 778 | |
| Off site | 308 | 2040 | 2040 | 1 | 308 | 1 | |

Draft Tank Closure and Waste Management Environmental Impact Statement for the
Hanford Site, Richland, Washington

Table I-50. Tank Closure Alternative 6C Operations Rollup Workforce Estimate (continued)

| Activity | Total Hours | Duration | | | Hours per Year | Full-Time Equivalents per Year | Onsite Full-Time Equivalents |
|---|--------------------|----------|--------|-------|-------------------|--------------------------------|------------------------------|
| | | Start | Finish | Years | | | |
| Cesium and Strontium Capsule Processing Facility (OPS_CSC) | | | | | | | |
| Radiological workers | 103,334 | 2039 | 2040 | 2 | 51,667 | 25 | 25 |
| Nonradiological workers | | | | | | | |
| On site | N/A | | | | | | |
| Off site | N/A | | | | | | |
| Modified Sluicing Retrieval System (OPS_MS) | | | | | | | |
| Radiological workers | 5,778,109 | 2013 | 2043 | 31 | 186,391 | 90 | 149 |
| Nonradiological workers | | | | | | | |
| On site | 3,777,905 | 2013 | 2043 | 31 | 121,868 | 59 | |
| Off site | N/A | | | | | | |
| Mobile Retrieval System (OPS_MRS) | | | | | | | |
| Radiological workers | 5,169,360 | 2013 | 2028 | 16 | 323,085 | 156 | 297 |
| Nonradiological workers | | | | | | | |
| On site | 4,678,860 | 2013 | 2028 | 16 | 292,429 | 141 | |
| Off site | N/A | | | | | | |
| Vacuum-Based Retrieval System (OPS_VBR) | | | | | | | |
| Radiological workers | 7,667,884 | 2029 | 2043 | 15 | 511,192 | 246 | 469 |
| Nonradiological workers | | | | | | | |
| On site | 6,940,309 | 2029 | 2043 | 15 | 462,687 | 223 | |
| Off site | N/A | | | | | | |
| High-Level Radioactive Waste Melter Interim Storage Facilities (OPS_PAD) | | | | | | | |
| Radiological workers | N/A | 2018 | 2145 | 128 | | | |
| Nonradiological workers | | | | | | | |
| On site | N/A | | | | | | |
| Off site | | | | | | | |
| Effluent Treatment Facility Replacement (OPS ETF) | | | | | | | |
| Radiological workers | 6,182,400 | 2006 | 2045 | 40 | 154,560 | 75 | 94 |
| Nonradiological workers | | | | | | | |
| On site | 1,545,600 | 2006 | 2045 | 40 | 38,640 | 19 | |
| Off site | N/A | | | | | | |
| 242-A Evaporator Replacement (OPS_EVA) | | | | | | | |
| Radiological workers | 1,858,033 | 2006 | 2043 | 38 | 48,896 | 24 | 32 |
| Nonradiological workers | | | | | | | |
| On site | 568,233 | 2006 | 2043 | 38 | 14,954 | 8 | |
| Off site | N/A | | | | | | |
| Borrow Area C (OPS_CAREA) | | | | | | | |
| Radiological workers | N/A | | | | | | 43 |
| Nonradiological workers | | | | | | | |
| On site | 4,201,800 | 2006 | 2052 | 47 | 89,400 | 43 | |
| Off site | N/A | | | | | | |
| Immobilized Low-Activity Waste Interim Storage Facility (OPS_ILAWST) | | | | | | | |
| Radiological workers | N/A | 2018 | 2145 | 128 | N/A | | |
| Nonradiological workers | | | | | | | |
| On site | N/A | | | | | | |
| Off site | N/A | | | | | | |
| Total | 234,836,202 | | | | 12,327,738 | 5,942 | 5,834 |

Table I-50. Tank Closure Alternative 6C Operations Rollup Workforce Estimate (continued)

Notes and Assumptions:

Total number of offsite full-time equivalents = 108.

Hours worked per year = 2,080.

One full-time equivalent was assumed for activities estimated to require less than 2,080 hours per year.

Key: N/A=not applicable.

Source: Compiled from SAIC 2007a, 2008.

Table I-51. Tank Closure Alternative 6C Deactivation Rollup Workforce Estimate

| Activity | Total Hours | Duration | | | Hours per Year | Full-Time Equivalents per Year | Onsite Full-Time Equivalents |
|--|-------------|----------|--------|-------|----------------|--------------------------------|------------------------------|
| | | Start | Finish | Years | | | |
| Immobilized High-Level Radioactive Waste Interim Storage Facilities (DEA_ISF) | | | | | | | |
| Radiological workers | N/A | | | | | | |
| Nonradiological workers | | | | | | | |
| On site | 160 | 2067 | 2067 | 1 | 160 | 1 | 1 |
| Off site | N/A | | | | | | |
| Waste Treatment Plant (DEA_WTP) | | | | | | | |
| Radiological workers | 3,800,000 | 2044 | 2045 | 2 | 1,900,000 | 914 | |
| Nonradiological workers | | | | | | | 1,527 |
| On site | 2,550,000 | 2044 | 2045 | 2 | 1,275,000 | 613 | |
| Off site | 500 | 2044 | 2045 | 2 | 250 | 1 | |
| Modified Sluicing Retrieval System (DEA_MS) | | | | | | | |
| Radiological workers | 291,082 | 2013 | 2043 | 31 | 9,390 | 5 | |
| Nonradiological workers | | | | | | | 5 |
| On site | N/A | | | | | | |
| Off site | N/A | | | | | | |
| Mobile Retrieval System (DEA_MRS) | | | | | | | |
| Radiological workers | 679,620 | 2013 | 2028 | 16 | 42,476 | 21 | |
| Nonradiological workers | | | | | | | 21 |
| On site | N/A | | | | | | |
| Off site | N/A | | | | | | |
| Vacuum-Based Retrieval System (DEA_VBR) | | | | | | | |
| Radiological workers | 258,100 | 2029 | 2043 | 15 | 17,207 | 9 | |
| Nonradiological workers | | | | | | | 9 |
| On site | N/A | | | | | | |
| Off site | N/A | | | | | | |
| Cesium and Strontium Capsule Processing Facility (DEA_CSC) | | | | | | | |
| Radiological workers | 23,920 | 2041 | 2041 | 1 | 23,920 | 12 | |
| Nonradiological workers | | | | | | | 12 |
| On site | N/A | | | | | | |
| Off site | N/A | | | | | | |
| Effluent Treatment Facility (Original) (DEA_ETFO) | | | | | | | |
| Radiological workers | 77,280 | 2026 | 2026 | 1 | 77,280 | 38 | |
| Nonradiological workers | | | | | | | 48 |
| On site | 19,320 | 2026 | 2026 | 1 | 19,320 | 10 | |
| Off site | N/A | | | | | | |

Draft Tank Closure and Waste Management Environmental Impact Statement for the
Hanford Site, Richland, Washington

Table I-51. Tank Closure Alternative 6C Deactivation Rollup Workforce Estimate (continued)

| Activity | Total Hours | Duration | | | Hours per Year | Full-Time Equivalents per Year | Onsite Full-Time Equivalents |
|---|------------------|----------|--------|-------|------------------|--------------------------------|------------------------------|
| | | Start | Finish | Years | | | |
| Effluent Treatment Facility (DEA ETF) | | | | | | | |
| Radiological workers | 77,280 | 2046 | 2046 | 1 | 77,280 | 38 | 48 |
| Nonradiological workers | | | | | | | |
| On site | 19,320 | 2046 | 2046 | 1 | 19,320 | 10 | |
| Off site | N/A | | | | | | |
| 242-A Evaporator (Original) (DEA EVAO) | | | | | | | |
| Radiological workers | 24,448 | 2018 | 2018 | 1 | 24,448 | 12 | 16 |
| Nonradiological workers | | | | | | | |
| On site | 7,477 | 2018 | 2018 | 1 | 7,477 | 4 | |
| Off site | N/A | | | | | | |
| 242-A Evaporator Replacement (DEA EVA) | | | | | | | |
| Radiological workers | 24,448 | 2044 | 2044 | 1 | 24,448 | 12 | 16 |
| Nonradiological workers | | | | | | | |
| On site | 7,477 | 2044 | 2044 | 1 | 7,477 | 4 | |
| Off site | N/A | | | | | | |
| Total | 7,860,432 | | | | 3,525,453 | 1,704 | 1,703 |

Notes and Assumptions:

Total number of offsite full-time equivalents = 1.

Hours worked per year = 2,080.

One full-time equivalent was assumed for activities estimated to require less than 2,080 hours per year.

Key: N/A=not applicable.

Source: Compiled from SAIC 2007a, 2008.

Table I-52. Tank Closure Alternative 6C Closure Rollup Workforce Estimate

| Activity | Total Hours | Duration | | | Hours per Year | Full-Time Equivalents per Year | Onsite Full-Time Equivalents |
|--|-------------|----------|--------|-------|----------------|--------------------------------|------------------------------|
| | | Start | Finish | Years | | | |
| Tank-Filling Grout Facility Construction (CLO_CONGRO) | | | | | | | |
| Radiological workers | 480 | 2032 | 2033 | 2 | 240 | 1 | 5 |
| Nonradiological workers | | | | | | | |
| On site | 13,360 | 2032 | 2033 | 2 | 6,680 | 4 | |
| Off site | 4,160 | 2032 | 2033 | 2 | 2,080 | 1 | |
| Tank-Filling Grout Facility Operations (CLO_OPSGRO) | | | | | | | |
| Radiological workers | 68,000 | 2034 | 2043 | 10 | 6,800 | 4 | 13 |
| Nonradiological workers | | | | | | | |
| On site | 185,280 | 2034 | 2043 | 10 | 18,528 | 9 | |
| Off site | 130,000 | 2034 | 2043 | 10 | 13,000 | 7 | |
| Tank-Filling Grout Facility Deactivation (CLO_DEAGRO) | | | | | | | |
| Radiological workers | 480 | 2044 | 2044 | 1 | 480 | 1 | 4 |
| Nonradiological workers | | | | | | | |
| On site | 4,320 | 2044 | 2044 | 1 | 4,320 | 3 | |
| Off site | 1,040 | 2044 | 2044 | 1 | 1,040 | 1 | |
| Ancillary Equipment Grouting (CLO_ANCFIL) | | | | | | | |
| Radiological workers | 337,943 | 2013 | 2037 | 25 | 13,518 | 7 | 7 |
| Nonradiological workers | | | | | | | |
| On site | N/A | | | | | | |
| Off site | N/A | | | | | | |

Table I-52. Tank Closure Alternative 6C Closure Rollup Workforce Estimate (continued)

| Activity | Total Hours | Duration | | | Hours per Year | Full-Time Equivalents per Year | Onsite Full-Time Equivalents |
|---|------------------|----------|--------|-------|----------------|--------------------------------|------------------------------|
| | | Start | Finish | Years | | | |
| Ancillary Equipment Removal (CLO_ANCREM) | | | | | | | |
| Radiological workers | 166,452 | 2032 | 2037 | 6 | 27,742 | 14 | 14 |
| Nonradiological workers | | | | | | | |
| On site | N/A | | | | | | |
| Off site | N/A | | | | | | |
| BX and SX Tank Farm Soil Removal (CLO_SOIL) | | | | | | | |
| Radiological workers | 33,000 | 2032 | 2037 | 6 | 5,500 | 3 | 6 |
| Nonradiological workers | | | | | | | |
| On site | 30,000 | 2032 | 2037 | 6 | 5,000 | 3 | |
| Off site | N/A | | | | | | |
| Containment Structure Construction (CLO_CONCS) | | | | | | | |
| Radiological workers | 2,000 | 2028 | 2031 | 4 | 500 | 1 | 4 |
| Nonradiological workers | | | | | | | |
| On site | 20,000 | 2028 | 2031 | 4 | 5,000 | 3 | |
| Off site | N/A | | | | | | |
| Containment Structure Deactivation (CLO_DEACS) | | | | | | | |
| Radiological workers | 2,000 | 2038 | 2040 | 3 | 667 | 1 | 5 |
| Nonradiological workers | | | | | | | |
| On site | 20,000 | 2038 | 2040 | 3 | 6,667 | 4 | |
| Off site | N/A | | | | | | |
| Modified Resource Conservation and Recovery Act Subtitle C Barrier Construction (CLO_RCRA) | | | | | | | |
| Radiological workers | 1,430,000 | 2039 | 2045 | 7 | 204,286 | 99 | 394 |
| Nonradiological workers | | | | | | | |
| On site | 4,290,000 | 2039 | 2045 | 7 | 612,857 | 295 | |
| Off site | N/A | | | | | | |
| Decontamination and Decommissioning of 10 Selected Facilities (CLO_D&DTEN) | | | | | | | |
| Radiological workers | 44,418 | 2018 | 2028 | 11 | 4,038 | 2 | 9 |
| Nonradiological workers | | | | | | | |
| On site | 146,679 | 2018 | 2028 | 11 | 13,334 | 7 | |
| Off site | 78,970 | 2018 | 2028 | 11 | 7,179 | 4 | |
| Postclosure Care (CLO_POST) | | | | | | | |
| Radiological workers | N/A | | | | | | 3 |
| Nonradiological workers | | | | | | | |
| On site | 471,262 | 2046 | 2145 | 100 | 4,713 | 3 | |
| Off site | N/A | | | | | | |
| Total | 7,479,844 | | | | 964,168 | 477 | 464 |

Notes and Assumptions:

Total number of offsite full-time equivalents = 13.

Hours worked per year = 2,080.

One full-time equivalent was assumed for activities estimated to require less than 2,080 hours per year.

Key: N/A=not applicable.

Source: Compiled from SAIC 2007a, 2008.

I.2.14 FTF Decommissioning Alternative 1: No Action

Table I-53. FTF Decommissioning Alternative 1 Deactivation Rollup Workforce Estimate

| Activity | Total Hours | Duration | | | Hours per Year | Full-Time Equivalents per Year | Onsite Full-Time Equivalents |
|--|---------------|----------|--------|-------|----------------|--------------------------------|------------------------------|
| | | Start | Finish | Years | | | |
| Administrative Controls (DEA_ADM) | | | | | | | |
| Radiological workers | 41,600 | 2008 | 2107 | 100 | 416 | 1 | |
| Nonradiological workers | | | | | | | 1 |
| On site | N/A | | | | | | |
| Off site | N/A | | | | | | |
| Total | 41,600 | | | | 416 | 1 | 1 |

Notes and Assumptions:

Total number of offsite full-time equivalents = 0.

Hours worked per year = 2,080.

One full-time equivalent was assumed for activities estimated to require less than 2,080 hours per year.

Key: FTF=Fast Flux Test Facility; N/A=not applicable.

Source: Compiled from SAIC 2007b, 2008.

I.2.15 FTF Decommissioning Alternative 2: Entombment

Table I-54. FTF Decommissioning Alternative 2 Facility Disposition Rollup Workforce Estimate

| Activity | Total Hours | Duration | | | Hours per Year | Full-Time Equivalents per Year | Onsite Full-Time Equivalents |
|--|-------------|----------|--------|-------|----------------|--------------------------------|------------------------------|
| | | Start | Finish | Years | | | |
| Above-Grade Structure and Equipment Removal (DEC_AGSR) | | | | | | | |
| Radiological workers | N/A | | | | | | |
| Nonradiological workers | | | | | | | 33 |
| On site | 546,000 | 2013 | 2020 | 8 | 68,250 | 33 | |
| Off site | 20,005 | 2013 | 2020 | 8 | 2,501 | 2 | |
| Removal of Reactor Containment Building Below-Grade Vessels, Piping, Components (DEC_GB1) | | | | | | | |
| Radiological workers | 7,680 | 2017 | 2017 | 1 | 7,680 | 4 | |
| Nonradiological workers | | | | | | | 6 |
| On site | 3,840 | 2017 | 2017 | 1 | 3,840 | 2 | |
| Off site | N/A | | | | | | |
| 491 East and West Backfill with Grout (DEC_GB2) | | | | | | | |
| Radiological workers | N/A | 2017 | 2017 | 1 | | | |
| Nonradiological workers | | | | | | | |
| On site | N/A | | | | | | |
| Off site | N/A | | | | | | |
| Grout Facility Resource Calculation (DEC_OGFC) | | | | | | | |
| Radiological workers | N/A | | | | | | |
| Nonradiological workers | | | | | | | 11 |
| On site | 22,378 | 2016 | 2016 | 1 | 22,378 | 11 | |
| Off site | N/A | | | | | | |
| Grout Facility Resource Calculation-Operation (DEC_OGFO) | | | | | | | |
| Radiological workers | N/A | | | | | | |
| Nonradiological workers | | | | | | | 6 |
| On site | 10,560 | 2017 | 2017 | 1 | 10,560 | 6 | |
| Off site | N/A | | | | | | |

**Table I–54. FFTF Decommissioning Alternative 2 Facility Disposition Rollup Workforce Estimate
(continued)**

| Activity | Total Hours | Duration | | | Hours per Year | Full-Time Equivalents per Year | Onsite Full-Time Equivalents |
|--|----------------|----------|--------|-------|----------------|--------------------------------|------------------------------|
| | | Start | Finish | Years | | | |
| Grout Facility Resource Calculation–Deactivation (DEC_OGFD) | | | | | | | |
| Radiological workers | N/A | | | | | | |
| Nonradiological workers | | | | | | | 4 |
| On site | 7,214 | 2018 | 2018 | 1 | 7,214 | 4 | |
| Off site | N/A | | | | | | |
| Nonhazardous Waste Transportation (DEC_WTR) | | | | | | | |
| Radiological workers | N/A | | | | | | |
| Nonradiological workers | | | | | | | 1 |
| On site | 95 | 2013 | 2020 | 8 | 12 | 1 | |
| Off site | 9 | 2013 | 2020 | 8 | 1 | 1 | |
| Site Regrading (CLO_SRG) | | | | | | | |
| Radiological workers | N/A | | | | | | |
| Nonradiological workers | | | | | | | 22 |
| On site | 45,228 | 2021 | 2021 | 1 | 45,228 | 22 | |
| Off site | 4,523 | 2021 | 2021 | 1 | 4,523 | 3 | |
| Site Revegetation (CLO_REV) | | | | | | | |
| Radiological workers | N/A | | | | | | |
| Nonradiological workers | | | | | | | 1 |
| On site | 942 | 2021 | 2021 | 1 | 942 | 1 | |
| Off site | 94 | 2021 | 2021 | 1 | 94 | 1 | |
| Modified Resource Conservation and Recovery Act Subtitle C Barrier (CLO_RCRA) | | | | | | | |
| Radiological workers | N/A | | | | | | |
| Nonradiological workers | | | | | | | 27 |
| On site | 55,715 | 2021 | 2021 | 1 | 55,715 | 27 | |
| Off site | 5,571 | 2021 | 2021 | 1 | 5,571 | 3 | |
| Institutional Controls (CLO_POST) | | | | | | | |
| Radiological workers | N/A | | | | | | |
| Nonradiological workers | | | | | | | 1 |
| On site | 80,000 | 2022 | 2121 | 100 | 800 | 1 | |
| Off site | N/A | | | | | | |
| Total | 809,855 | | | | 235,309 | 122 | 112 |

Notes and Assumptions:

Total number of offsite full-time equivalents = 10.

Hours worked per year = 2,080.

One full-time equivalent was assumed for activities estimated to require less than 2,080 hours per year.

Key: FFTF=Fast Flux Test Facility; N/A=not applicable.

Source: Compiled from SAIC 2007b, 2008.

I.2.16 FFTF Decommissioning Alternative 3: Removal

Table I-55. FFTF Decommissioning Alternative 3 Facility Disposition Rollup Workforce Estimate

| Activity | Total Hours | Duration | | | Hours per Year | Full-Time Equivalents per Year | Onsite Full-Time Equivalents |
|---|-------------|----------|--------|-------|----------------|--------------------------------|------------------------------|
| | | Start | Finish | Years | | | |
| Above-Grade Structure and Equipment Removal (DEC_AGSR) | | | | | | | |
| Radiological workers | N/A | | | | | | |
| Nonradiological workers | | | | | | | 33 |
| On site | 546,000 | 2013 | 2020 | 8 | 68,250 | 33 | |
| Off site | 20,005 | 2013 | 2020 | 8 | 2,501 | 2 | |
| Removal of Reactor Containment Building Below-Grade Vessels, Piping, Components (DEC_RVRG) | | | | | | | |
| Radiological workers | 130,881 | 2013 | 2014 | 2 | 65,440 | 32 | |
| Nonradiological workers | | | | | | | 48 |
| On site | 64,563 | 2013 | 2014 | 2 | 32,282 | 16 | |
| Off site | N/A | | | | | | |
| Grout Facility Resource Calculation (DEC_OGFC) | | | | | | | |
| Radiological workers | N/A | | | | | | |
| Nonradiological workers | | | | | | | 11 |
| On site | 22,378 | 2012 | 2012 | 1 | 22,378 | 11 | |
| Off site | N/A | | | | | | |
| Grout Facility Resource Calculation-Operation (DEC_OGFO) | | | | | | | |
| Radiological workers | N/A | | | | | | |
| Nonradiological workers | | | | | | | 3 |
| On site | 10,560 | 2013 | 2014 | 2 | 5,280 | 3 | |
| Off site | N/A | | | | | | |
| Grout Facility Resource Calculation-Deactivation (DEC_OGFD) | | | | | | | |
| Radiological workers | N/A | | | | | | |
| Nonradiological workers | | | | | | | 4 |
| On site | 7,214 | 2015 | 2015 | 1 | 7,214 | 4 | |
| Off site | N/A | | | | | | |
| Nonhazardous Waste Transportation (DEC_WTR) | | | | | | | |
| Radiological workers | N/A | | | | | | |
| Nonradiological workers | | | | | | | 1 |
| On site | 95 | 2013 | 2020 | 8 | 12 | 1 | |
| Off site | 9 | 2013 | 2020 | 8 | 1 | 1 | |
| Site Regrading (CLO_SRG) | | | | | | | |
| Radiological workers | N/A | | | | | | |
| Nonradiological workers | | | | | | | 30 |
| On site | 61,620 | 2021 | 2021 | 1 | 61,620 | 30 | |
| Off site | 6,162 | 2021 | 2021 | 1 | 6,162 | 3 | |
| Site Revegetation (CLO_REV) | | | | | | | |
| Radiological workers | N/A | | | | | | |
| Nonradiological workers | | | | | | | 1 |
| On site | 1,063 | 2021 | 2021 | 1 | 1,063 | 1 | |
| Off site | 106 | 2021 | 2021 | 1 | 106 | 1 | |

**Table I-55. FFTF Decommissioning Alternative 3 Facility Disposition Rollup
Workforce Estimate (continued)**

| Activity | Total Hours | Duration | | | Hours per Year | Full-Time Equivalents per Year | Onsite Full-Time Equivalents |
|--|----------------|----------|--------|-------|----------------|--------------------------------|------------------------------|
| | | Start | Finish | Years | | | |
| Institutional Controls (CLO_POST) | | | | | | | |
| Radiological workers | N/A | | | | | | |
| Nonradiological workers | | | | | | | 1 |
| On site | 80,000 | 2022 | 2121 | 100 | 800 | 1 | |
| Off site | N/A | | | | | | |
| Total | 950,656 | | | | 273,109 | 139 | 132 |

Notes and Assumptions:

Total number of offsite full-time equivalents = 8.

Hours worked per year = 2,080.

One full-time equivalent was assumed for activities estimated to require less than 2,080 hours per year.

Key: FFTF=Fast Flux Test Facility; N/A=not applicable.

Source: Compiled from SAIC 2007b, 2008.

Table I-56. FFTF Decommissioning Alternatives 2 and 3 – Disposition of Remote-Handled Components Rollup Workforce Estimate

| Activity | Total Hours | Duration | | | Hours per Year | Full-Time Equivalents per Year | Onsite Full-Time Equivalents |
|--|----------------|----------|--------|-------|----------------|--------------------------------|------------------------------|
| | | Start | Finish | Years | | | |
| Hanford Option | | | | | | | |
| Remote Treatment Project–Hanford 200-West Area (CON_H RTP) | | | | | | | |
| Radiological workers | N/A | | | | | | |
| Nonradiological workers | | | | | | | 53 |
| On site | 219,164 | 2015 | 2016 | 2 | 109,582 | 53 | |
| Off site | 124,370 | 2015 | 2016 | 2 | 62,185 | 30 | |
| Remote Treatment Project–Hanford (OPS_H RTP) | | | | | | | |
| Radiological workers | 83,200 | 2017 | 2017 | 1 | 83,200 | 40 | |
| Nonradiological workers | | | | | | | 40 |
| On site | N/A | | | | | | |
| Off site | 5 | 2017 | 2017 | 1 | 5 | 1 | |
| Remote Treatment Project–Hanford 200-West Area (DEA_H RTP) | | | | | | | |
| Radiological workers | 41,600 | 2018 | 2018 | 1 | 41,600 | 20 | |
| Nonradiological workers | | | | | | | 20 |
| On site | N/A | | | | | | |
| Off site | N/A | | | | | | |
| Total | 468,340 | | | | 296,573 | 144 | 113 |
| Idaho Option | | | | | | | |
| Remote Treatment Project–Idaho National Laboratory Materials and Fuels Complex (CON_IRTP) | | | | | | | |
| Radiological workers | N/A | | | | | | |
| Nonradiological workers | | | | | | | 46 |
| On site | 189,358 | 2015 | 2016 | 2 | 94,679 | 46 | |
| Off site | 107,456 | 2015 | 2016 | 2 | 53,728 | 26 | |

Draft Tank Closure and Waste Management Environmental Impact Statement for the
Hanford Site, Richland, Washington

Table I-56. FFTF Decommissioning Alternatives 2 and 3 – Disposition of Remote-Handled Components Rollup Workforce Estimate (continued)

| Activity | Total Hours | Duration | | | Hours per Year | Full-Time Equivalents per Year | Onsite Full-Time Equivalents |
|--|----------------|----------|--------|-------|----------------|--------------------------------|------------------------------|
| | | Start | Finish | Years | | | |
| Remote Treatment Project–Idaho National Laboratory Materials and Fuels Complex (OPS_IRTP) | | | | | | | |
| Radiological workers | 83,200 | 2017 | 2017 | 1 | 83,200 | 40 | 40 |
| Nonradiological workers | | | | | | | |
| On site | N/A | | | | | | |
| Off site | 87 | 2017 | 2017 | 1 | 87 | 1 | |
| Remote Treatment Project–Idaho National Laboratory Materials and Fuels Complex (DEA_IRTP) | | | | | | | |
| Radiological workers | 41,632 | 2018 | 2018 | 1 | 41,632 | 21 | 21 |
| Nonradiological workers | | | | | | | |
| On site | N/A | | | | | | |
| Off site | N/A | | | | | | |
| Total | 421,733 | | | | 273,326 | 134 | 107 |

Notes and Assumptions:

Total number of offsite full-time equivalents at Hanford= 31.

Total number of offsite full-time equivalents at INL = 27.

Hours worked per year = 2,080.

One full-time equivalent was assumed for activities estimated to require less than 2,080 hours per year.

Key: FFTF=Fast Flux Test Facility; N/A=not applicable.

Source: Compiled from SAIC 2007b, 2008.

Table I-57. FFTF Decommissioning Alternatives 2 and 3 – Disposition of Bulk Sodium Rollup Workforce Estimate

| Activity | Total Hours | Duration | | | Hours per Year | Full-Time Equivalents per Year | Onsite Full-Time Equivalents |
|--|----------------|----------|--------|-------|----------------|--------------------------------|------------------------------|
| | | Start | Finish | Years | | | |
| Hanford Reuse Option | | | | | | | |
| Hanford Sodium Reaction Facility (CON_HSRF) | | | | | | | |
| Radiological workers | N/A | | | | | | 44 |
| Nonradiological workers | | | | | | | |
| On site | 179,214 | 2015 | 2016 | 2 | 89,607 | 44 | |
| Off site | 86,994 | 2015 | 2016 | 2 | 43,497 | 21 | |
| Hanford Sodium Reaction Facility (OPS_HSP) | | | | | | | |
| Radiological workers | 10,400 | 2017 | 2017 | 1 | 10,400 | 5 | 5 |
| Nonradiological workers | | | | | | | |
| On site | N/A | | | | | | |
| Off site | N/A | | | | | | |
| Hanford Sodium Reaction Facility (OPS_HSRF) | | | | | | | |
| Radiological workers | 185,023 | 2017 | 2018 | 2 | 92,512 | 45 | 60 |
| Nonradiological workers | | | | | | | |
| On site | 61,796 | 2017 | 2018 | 2 | 30,898 | 15 | |
| Off site | 5,888 | 2017 | 2018 | 2 | 2,944 | 2 | |
| Hanford Sodium Reaction Facility (DEA_HSRF) | | | | | | | |
| Radiological workers | 11,027 | 2019 | 2019 | 1 | 11,027 | 6 | 17 |
| Nonradiological workers | | | | | | | |
| On site | 22,855 | 2019 | 2019 | 1 | 22,855 | 11 | |
| Off site | 16,444 | 2019 | 2019 | 1 | 16,444 | 8 | |
| Total | 579,641 | | | | 320,184 | 157 | 126 |

Table I-57. FFTF Decommissioning Alternatives 2 and 3 – Disposition of Bulk Sodium Rollup Workforce Estimate (continued)

| Activity | Total Hours | Duration | | | Hours per Year | Full-Time Equivalents per Year | Onsite Full-Time Equivalents |
|---|----------------|----------|--------|-------|----------------|--------------------------------|------------------------------|
| | | Start | Finish | Years | | | |
| Idaho Reuse Option | | | | | | | |
| Materials and Fuels Complex Sodium Processing Facility (CON_ISPF) | | | | | | | |
| Radiological workers | 21,022 | 2014 | 2014 | 1 | 21,022 | 11 | 19 |
| Nonradiological workers | | | | | | | |
| On site | 15,648 | 2014 | 2014 | 1 | 15,648 | 8 | |
| Off site | 12,599 | 2014 | 2014 | 1 | 12,599 | 7 | |
| Idaho National Laboratory Materials and Fuels Complex–Sodium Processing Facility and Fast Flux Test Facility Sodium Storage Facility (OPS_ISP) | | | | | | | |
| Radiological workers | 10,400 | 2015 | 2015 | 1 | 10,400 | 5 | 5 |
| Nonradiological workers | | | | | | | |
| On site | N/A | | | | | | |
| Off site | N/A | | | | | | |
| Sodium Processing Facility (OPS_ISPF) | | | | | | | |
| Radiological workers | 168,978 | 2015 | 2016 | 2 | 84,489 | 41 | 50 |
| Nonradiological workers | | | | | | | |
| On site | 35,793 | 2015 | 2016 | 2 | 17,897 | 9 | |
| Off site | N/A | | | | | | |
| Fast Flux Test Facility Sodium Disposition–Idaho Option (DEA_ISPF) | | | | | | | |
| Radiological workers | 828 | 2016 | 2016 | 1 | 828 | 1 | 2 |
| Nonradiological workers | | | | | | | |
| On site | 379 | 2016 | 2016 | 1 | 379 | 1 | |
| Off site | N/A | | | | | | |
| Total | 265,647 | | | | 163,262 | 83 | 76 |

Notes and Assumptions:

Total number of offsite full-time equivalents at Hanford= 31.

Total number of offsite full-time equivalents at INL = 7.

Hours worked per year = 2,080.

One full-time equivalent was assumed for activities estimated to require less than 2,080 hours per year.

Key: FFTF=Fast Flux Test Facility; N/A=not applicable.

Source: Compiled from SAIC 2007b, 2008.

I.2.17 Waste Management Alternative 1: No Action

Table I-58. Waste Management Alternative 1 Operations/Deactivation Rollup Workforce Estimate

| Activity | Total Hours | Duration | | | Hours per Year | Full-Time Equivalents per Year | Onsite Full-Time Equivalents |
|--|-------------|----------|--------|-------|----------------|--------------------------------|------------------------------|
| | | Start | Finish | Years | | | |
| Low-Level Radioactive Waste Burial Grounds (OPS_LLBG) | | | | | | | |
| Radiological workers | 386,570 | 2007 | 2035 | 29 | 13,330 | 7 | 9 |
| Nonradiological workers | | | | | | | |
| On site | 113,769 | 2007 | 2035 | 29 | 3,923 | 2 | |
| Off site | 193,523 | 2007 | 2035 | 29 | 6,673 | 4 | |
| Integrated Disposal Facility (DEA_IDF) | | | | | | | |
| Radiological workers | 6,240 | 2009 | 2009 | 1 | 6,240 | 3 | 100 |
| Nonradiological workers | | | | | | | |
| On site | 200,120 | 2009 | 2009 | 1 | 200,120 | 97 | |
| Off site | 31,200 | 2009 | 2009 | 1 | 31,200 | 15 | |

Draft Tank Closure and Waste Management Environmental Impact Statement for the
Hanford Site, Richland, Washington

**Table I-58. Waste Management Alternative 1 Operations/Deactivation Rollup
Workforce Estimate (continued)**

| Activity | Total Hours | Duration | | | Hours per Year | Full-Time Equivalents per Year | Onsite Full-Time Equivalents |
|-----------------------------------|------------------|----------|--------|-------|----------------|--------------------------------|------------------------------|
| | | Start | Finish | Years | | | |
| Postclosure Care (DEA_ADM) | | | | | | | |
| Radiological workers | N/A | | | | | | |
| Nonradiological workers | | | | | | | |
| On site | 72,657 | 2036 | 2135 | 100 | 727 | 1 | 1 |
| Off site | N/A | | | | | | |
| Total | 1,004,078 | | | | 262,212 | 129 | 110 |

Notes and Assumptions:

Total number of offsite full-time equivalents = 4.

Hours worked per year = 2,080.

One full-time equivalent was assumed for activities estimated to require less than 2,080 hours per year.

Key: N/A=not applicable.

Source: Compiled from SAIC 2007c, 2008.

I.2.18 Waste Management Alternative 2: Disposal in IDF, 200-East Area Only

Table I-59. Waste Management Alternative 2 Construction Rollup Workforce Estimate

| Activity | Total Hours | Duration | | | Hours per Year | Full-Time Equivalents per Year | Onsite Full-Time Equivalents |
|---|------------------|----------|--------|-------|------------------|--------------------------------|------------------------------|
| | | Start | Finish | Years | | | |
| A 2706T/TA/TB Facility (CON_TPLANT) | | | | | | | |
| Radiological workers | N/A | | | | | | |
| Nonradiological workers | | | | | | | |
| On site | 78,468 | 2011 | 2012 | 2 | 39,234 | 19 | 19 |
| Off site | 31,033 | 2011 | 2012 | 2 | 15,516 | 8 | |
| Central Waste Complex (CON_WRAPCH) | | | | | | | |
| Radiological workers | N/A | | | | | | |
| Nonradiological workers | | | | | | | |
| On site | 882,789 | 2011 | 2012 | 2 | 441,395 | 213 | 213 |
| Off site | 133,191 | 2011 | 2012 | 2 | 66,595 | 33 | |
| Waste Receiving and Processing Facility (CON_WRAPRH) | | | | | | | |
| Radiological workers | N/A | | | | | | |
| Nonradiological workers | | | | | | | |
| On site | 1,482,600 | 2013 | 2018 | 6 | 247,100 | 119 | 119 |
| Off site | 509,296 | 2013 | 2018 | 6 | 84,883 | 41 | |
| Central Waste Complex (CON_CWCE) | | | | | | | |
| Radiological workers | N/A | | | | | | |
| Nonradiological workers | | | | | | | |
| On site | 294,263 | 2011 | 2012 | 2 | 147,132 | 71 | 71 |
| Off site | 104,571 | 2011 | 2012 | 2 | 52,286 | 26 | |
| Total | 3,516,211 | | | | 1,094,140 | 530 | 422 |

Notes and Assumptions:

Total number of offsite full-time equivalents = 108.

Hours worked per year = 2,080.

One full-time equivalent was assumed for activities estimated to require less than 2,080 hours per year.

Key: N/A=not applicable.

Source: Compiled from SAIC 2007c, 2008.

Table I–60. Waste Management Alternative 2 Operations Rollup Workforce Estimate

| Activity | Total Hours | Duration | | | Hours per Year | Full-Time Equivalents per Year | Onsite Full-Time Equivalents |
|--|-------------------|----------|--------|-------|----------------|--------------------------------|------------------------------|
| | | Start | Finish | Years | | | |
| T Plant Solid Waste Activities (OPS_TPLANT) | | | | | | | |
| Radiological workers | 1,264,640 | 2013 | 2050 | 38 | 33,280 | 16 | 20 |
| Nonradiological workers | | | | | | | |
| On site | 316,160 | 2013 | 2050 | 38 | 8,320 | 4 | |
| Off site | N/A | | | | | | |
| Solid Waste Operations Complex Waste Receiving and Processing Facility (OPS_WRAPCH) | | | | | | | |
| Radiological workers | 21,660,000 | 2013 | 2050 | 38 | 570,000 | 275 | 300 |
| Nonradiological workers | | | | | | | |
| On site | 1,976,000 | 2013 | 2050 | 38 | 52,000 | 25 | |
| Off site | N/A | | | | | | |
| Solid Waste Operations Complex Waste Receiving and Processing Facility (OPS_WRAPRH) | | | | | | | |
| Radiological workers | 7,296,000 | 2019 | 2050 | 32 | 228,000 | 110 | 120 |
| Nonradiological workers | | | | | | | |
| On site | 665,600 | 2019 | 2050 | 32 | 20,800 | 10 | |
| Off site | N/A | | | | | | |
| Central Waste Complex (OPS_CWCE) | | | | | | | |
| Radiological workers | 622,668 | 2013 | 2050 | 38 | 16,386 | 8 | 9 |
| Nonradiological workers | | | | | | | |
| On site | 69,198 | 2013 | 2050 | 38 | 1,821 | 1 | |
| Off site | N/A | | | | | | |
| Total | 33,870,266 | | | | 930,607 | 449 | 449 |

Notes and Assumptions:

Total number of offsite full-time equivalents = 0.

Hours worked per year = 2,080.

One full-time equivalent was assumed for activities estimated to require less than 2,080 hours per year.

Key: N/A=not applicable.

Source: Compiled from SAIC 2007c, 2008.

Table I–61. Waste Management Alternative 2 Deactivation Rollup Workforce Estimate

| Activity | Total Hours | Duration | | | Hours per Year | Full-Time Equivalents per Year | Onsite Full-Time Equivalents |
|---|-------------|----------|--------|-------|----------------|--------------------------------|------------------------------|
| | | Start | Finish | Years | | | |
| T Plant Solid Waste Activities (DEA_TPLANT) | | | | | | | |
| Radiological workers | 22,187 | 2051 | 2051 | 1 | 22,187 | 11 | 14 |
| Nonradiological workers | | | | | | | |
| On site | 5,547 | 2051 | 2051 | 1 | 5,547 | 3 | |
| Off site | N/A | | | | | | |
| Solid Waste Operations Complex Waste Receiving and Processing Facility–Deactivation of the Contact-Handled Mixed Transuranic/Transuranic Waste Facility (DEA_WRAPCH) | | | | | | | |
| Radiological workers | 285,000 | 2051 | 2051 | 1 | 285,000 | 138 | 151 |
| Nonradiological workers | | | | | | | |
| On site | 26,000 | 2051 | 2051 | 1 | 26,000 | 13 | |
| Off site | N/A | | | | | | |
| Solid Waste Operations Complex Waste Receiving and Processing Facility–Remote-Handled Mixed Transuranic/Transuranic Waste Facility Waste Expansion (DEA_WRAPRH) | | | | | | | |
| Radiological workers | 114,000 | 2051 | 2051 | 1 | 114,000 | 55 | 60 |
| Nonradiological workers | | | | | | | |
| On site | 10,400 | 2051 | 2051 | 1 | 10,400 | 5 | |
| Off site | N/A | | | | | | |

Draft Tank Closure and Waste Management Environmental Impact Statement for the
Hanford Site, Richland, Washington

**Table I-61. Waste Management Alternative 2 Deactivation Rollup
Workforce Estimate (continued)**

| Activity | Total Hours | Duration | | | Hours per Year | Full-Time Equivalents per Year | Onsite Full-Time Equivalents |
|---|----------------|----------|--------|-------|----------------|--------------------------------|------------------------------|
| | | Start | Finish | Years | | | |
| Central Waste Complex (DEA_CWCE) | | | | | | | |
| Radiological workers | 8,193 | 2051 | 2051 | 1 | 8,193 | 4 | |
| Nonradiological workers | | | | | | | 5 |
| On site | 911 | 2051 | 2051 | 1 | 911 | 1 | |
| Off site | N/A | | | | | | |
| Total | 472,237 | | | | 472,237 | 230 | 230 |

Notes and Assumptions:

Total number of offsite full-time equivalents = 0.

Hours worked per year = 2,080.

One full-time equivalent was assumed for activities estimated to require less than 2,080 hours per year.

Key: N/A=not applicable.

Source: Compiled from SAIC 2007c, 2008.

**Table I-62. Waste Management Alternative 2, Disposal Group 1, Construction Rollup
Workforce Estimate**

| Activity | Total Hours | Duration | | | Hours per Year | Full-Time Equivalents per Year | Onsite Full-Time Equivalents |
|---|------------------|----------|--------|-------|----------------|--------------------------------|------------------------------|
| | | Start | Finish | Years | | | |
| Single Integrated Disposal Facility (CON_IDF) | | | | | | | |
| Radiological workers | N/A | | | | | | |
| Nonradiological workers | | | | | | | 160 |
| On site | 992,655 | 2006 | 2008 | 3 | 330,885 | 160 | |
| Off site | N/A | | | | | | |
| River Protection Project Disposal Facility (CON_RPPDF) | | | | | | | |
| Radiological workers | N/A | | | | | | |
| Nonradiological workers | | | | | | | 170 |
| On site | 1,056,703 | 2019 | 2021 | 3 | 352,234 | 170 | |
| Off site | N/A | | | | | | |
| Total | 2,049,357 | | | | 683,119 | 330 | 330 |

Notes and Assumptions:

Total number of offsite full-time equivalents = 0.

Hours worked per year = 2,080.

One full-time equivalent was assumed for activities estimated to require less than 2,080 hours per year.

Key: N/A=not applicable.

Source: Compiled from SAIC 2007c, 2008.

Table I–63. Waste Management Alternative 2, Disposal Group 1, Operations Rollup Workforce Estimate

| Activity | Total Hours | Duration | | | Hours per Year | Full-Time Equivalents per Year | Onsite Full-Time Equivalents |
|---|-------------------|----------|--------|-------|----------------|--------------------------------|------------------------------|
| | | Start | Finish | Years | | | |
| Low-Level Radioactive Waste Burial Grounds (OPS_LLBG) | | | | | | | |
| Radiological workers | 586,520 | 2007 | 2050 | 44 | 13,330 | 7 | 9 |
| Nonradiological workers | | | | | | | |
| On site | 172,615 | 2007 | 2050 | 44 | 3,923 | 2 | |
| Off site | 293,621 | 2007 | 2050 | 44 | 6,673 | 4 | |
| Single Integrated Disposal Facility (OPS_IDF) | | | | | | | |
| Radiological workers | 1,510,454 | 2009 | 2050 | 42 | 35,963 | 18 | 42 |
| Nonradiological workers | | | | | | | |
| On site | 2,091,398 | 2009 | 2050 | 42 | 49,795 | 24 | |
| Off site | 2,788,531 | 2009 | 2050 | 42 | 66,394 | 32 | |
| River Protection Project Disposal Facility (OPS_RPPDF) | | | | | | | |
| Radiological workers | 1,664,832 | 2022 | 2050 | 29 | 57,408 | 28 | 43 |
| Nonradiological workers | | | | | | | |
| On site | 897,562 | 2022 | 2050 | 29 | 30,950 | 15 | |
| Off site | 1,664,832 | 2022 | 2050 | 29 | 57,408 | 28 | |
| Total | 11,670,365 | | | | 321,845 | 158 | 94 |

Notes and Assumptions:

Total number of offsite full-time equivalents = 64.

Hours worked per year = 2,080.

One full-time equivalent was assumed for activities estimated to require less than 2,080 hours per year.

Source: Compiled from SAIC 2007c, 2008.

Table I–64. Waste Management Alternative 2, Disposal Group 1, Closure Rollup Workforce Estimate

| Activity | Total Hours | Duration | | | Hours per Year | Full-Time Equivalents per Year | Onsite Full-Time Equivalents |
|---|-------------|----------|--------|-------|----------------|--------------------------------|------------------------------|
| | | Start | Finish | Years | | | |
| Modified Resource Conservation and Recovery Act Subtitle C Barrier (CLO_IDF) | | | | | | | |
| Radiological workers | N/A | | | | | | 619 |
| Nonradiological workers | | | | | | | |
| On site | 2,572,997 | 2051 | 2052 | 2 | 1,286,498 | 619 | |
| Off site | 257,300 | 2051 | 2052 | 2 | 128,650 | 62 | |
| Postclosure Care (CLO_POSTIDF) | | | | | | | |
| Radiological workers | N/A | | | | | | 2 |
| Nonradiological workers | | | | | | | |
| On site | 390,770 | 2053 | 2152 | 100 | 3,908 | 2 | |
| Off site | N/A | | | | | | |
| Modified Resource Conservation and Recovery Act Subtitle C Barrier (CLO_RPPDF) | | | | | | | |
| Radiological workers | N/A | | | | | | 559 |
| Nonradiological workers | | | | | | | |
| On site | 2,321,501 | 2051 | 2052 | 2 | 1,160,750 | 559 | |
| Off site | 232,150 | 2051 | 2052 | 2 | 116,075 | 56 | |

Draft Tank Closure and Waste Management Environmental Impact Statement for the
Hanford Site, Richland, Washington

**Table I-64. Waste Management Alternative 2, Disposal Group 1, Closure Rollup
Workforce Estimate (continued)**

| Activity | Total Hours | Duration | | | Hours per Year | Full-Time Equivalents per Year | Onsite Full-Time Equivalents |
|---|------------------|----------|--------|-------|------------------|--------------------------------|------------------------------|
| | | Start | Finish | Years | | | |
| Postclosure Care (CLO_POSTRPPDF) | | | | | | | |
| Radiological workers | | | | | | | |
| Nonradiological workers | | | | | | | |
| On site | 352,575 | 2053 | 2152 | 100 | 3,526 | 2 | 2 |
| Off site | | | | | | | |
| Total | 6,127,293 | | | | 2,699,407 | 1,300 | 1,182 |

Notes and Assumptions:

Total number of offsite full-time equivalents = 118.

Hours worked per year = 2,080.

One full-time equivalent was assumed for activities estimated to require less than 2,080 hours per year.

Key: N/A=not applicable.

Source: Compiled from SAIC 2007c, 2008.

**Table I-65. Waste Management Alternative 2, Disposal Group 2, Construction Rollup
Workforce Estimate**

| Activity | Total Hours | Duration | | | Hours per Year | Full-Time Equivalents per Year | Onsite Full-Time Equivalents |
|---|------------------|----------|--------|-------|------------------|--------------------------------|------------------------------|
| | | Start | Finish | Years | | | |
| Single Integrated Disposal Facility (CON_IDF) | | | | | | | |
| Radiological workers | N/A | | | | | | |
| Nonradiological workers | | | | | | | |
| On site | 700,596 | 2006 | 2008 | 3 | 233,532 | 113 | 113 |
| Off site | N/A | | | | | | |
| River Protection Project Disposal Facility (CON_RPPDF) | | | | | | | |
| Radiological workers | N/A | | | | | | |
| Nonradiological workers | | | | | | | |
| On site | 8,189,445 | 2019 | 2021 | 3 | 2,729,815 | 1,313 | 1,313 |
| Off site | N/A | | | | | | |
| Total | 8,890,041 | | | | 2,963,347 | 1,426 | 1,426 |

Notes and Assumptions:

Total number of offsite full-time equivalents = 0.

Hours worked per year = 2,080.

One full-time equivalent was assumed for activities estimated to require less than 2,080 hours per year.

Key: N/A=not applicable.

Source: Compiled from SAIC 2007c, 2008.

**Table I-66. Waste Management Alternative 2, Disposal Group 2, Operations Rollup
Workforce Estimate**

| Activity | Total Hours | Duration | | | Hours per Year | Full-Time Equivalents per Year | Onsite Full-Time Equivalents |
|--|-------------|----------|--------|-------|----------------|--------------------------------|------------------------------|
| | | Start | Finish | Years | | | |
| Low-Level Radioactive Waste Burial Grounds (OPS_LLBG) | | | | | | | |
| Radiological workers | 586,520 | 2007 | 2050 | 44 | 13,330 | 7 | |
| Nonradiological workers | | | | | | | |
| On site | 172,615 | 2007 | 2050 | 44 | 3,923 | 2 | 9 |
| Off site | 293,621 | 2007 | 2050 | 44 | 6,673 | 4 | |

**Table I–66. Waste Management Alternative 2, Disposal Group 2, Operations Rollup
Workforce Estimate (continued)**

| Activity | Total Hours | Duration | | | Hours per Year | Full-Time Equivalents per Year | Onsite Full-Time Equivalents |
|---|-------------------|----------|--------|-------|------------------|--------------------------------|------------------------------|
| | | Start | Finish | Years | | | |
| Single Integrated Disposal Facility (OPS_IDF) | | | | | | | |
| Radiological workers | 1,169,210 | 2009 | 2100 | 92 | 12,709 | 7 | |
| Nonradiological workers | | | | | | | |
| On site | 1,168,906 | 2009 | 2100 | 92 | 17,597 | 9 | 16 |
| Off site | 2,158,541 | 2009 | 2100 | 92 | 23,462 | 12 | |
| River Protection Project Disposal Facility (OPS_RPPDF) | | | | | | | |
| Radiological workers | 35,148,048 | 2022 | 2100 | 79 | 444,912 | 214 | |
| Nonradiological workers | | | | | | | |
| On site | 18,949,382 | 2022 | 2100 | 79 | 239,866 | 116 | 330 |
| Off site | 35,148,048 | 2022 | 2100 | 79 | 444,912 | 214 | |
| Total | 95,244,890 | | | | 1,207,384 | 585 | 355 |

Notes and Assumptions:

Total number of offsite full-time equivalents = 230.

Hours worked per year = 2,080.

One full-time equivalent was assumed for activities estimated to require less than 2,080 hours per year.

Source: Compiled from SAIC 2007c, 2008.

**Table I–67. Waste Management Alternative 2, Disposal Group 2, Closure Rollup
Workforce Estimate**

| Activity | Total Hours | Duration | | | Hours per Year | Full-Time Equivalents per Year | Onsite Full-Time Equivalents |
|---|-------------|----------|--------|-------|----------------|--------------------------------|------------------------------|
| | | Start | Finish | Years | | | |
| Modified Resource Conservation and Recovery Act Subtitle C Barrier (CLO_IDF) | | | | | | | |
| Radiological workers | N/A | | | | | | |
| Nonradiological workers | | | | | | | |
| On site | 909,255 | 2101 | 2102 | 2 | 454,627 | 219 | 219 |
| Off site | 90,925 | 2101 | 2102 | 2 | 45,463 | 22 | |
| Postclosure Care (CLO_POSTIDF) | | | | | | | |
| Radiological workers | N/A | | | | | | |
| Nonradiological workers | | | | | | | |
| On site | 138,092 | 2103 | 2202 | 100 | 1,381 | 1 | 1 |
| Off site | N/A | | | | | | |
| Modified Resource Conservation and Recovery Act Subtitle C Barrier (CLO_RPPDF) | | | | | | | |
| Radiological workers | N/A | | | | | | |
| Nonradiological workers | | | | | | | |
| On site | 17,991,632 | 2101 | 2102 | 2 | 8,995,816 | 4,325 | 4,325 |
| Off site | 1,799,163 | 2101 | 2102 | 2 | 899,582 | 433 | |

**Table I-67. Waste Management Alternative 2, Disposal Group 2, Closure Rollup
Workforce Estimate (continued)**

| Activity | Total Hours | Duration | | | Hours per Year | Full-Time Equivalents per Year | Onsite Full-Time Equivalents |
|---|-------------------|----------|--------|-------|-------------------|--------------------------------|------------------------------|
| | | Start | Finish | Years | | | |
| Postclosure Care (CLO_POSTRPPDF) | | | | | | | |
| Radiological workers | N/A | | | | | | |
| Nonradiological workers | | | | | | | |
| On site | 2,732,453 | 2103 | 2202 | 100 | 27,325 | 14 | 14 |
| Off site | N/A | | | | | | |
| Total | 23,661,521 | | | | 10,424,193 | 5,014 | 4,559 |

Notes and Assumptions:

Total number of offsite full-time equivalents = 455.

Hours worked per year = 2,080.

One full-time equivalent was assumed for activities estimated to require less than 2,080 hours per year.

Key: N/A=not applicable.

Source: Compiled from SAIC 2007c, 2008.

**Table I-68. Waste Management Alternative 2, Disposal Group 3, Construction Rollup
Workforce Estimate**

| Activity | Total Hours | Duration | | | Hours per Year | Full-Time Equivalents per Year | Onsite Full-Time Equivalents |
|---|------------------|----------|--------|-------|------------------|--------------------------------|------------------------------|
| | | Start | Finish | Years | | | |
| Single Integrated Disposal Facility (CON_IDF) | | | | | | | |
| Radiological workers | N/A | | | | | | |
| Nonradiological workers | | | | | | | |
| On site | 700,596 | 2006 | 2008 | 3 | 233,532 | 113 | 113 |
| Off site | N/A | | | | | | |
| River Protection Project Disposal Facility (CON_RPPDF) | | | | | | | |
| Radiological workers | N/A | | | | | | |
| Nonradiological workers | | | | | | | |
| On site | 8,189,445 | 2019 | 2021 | 3 | 2,729,815 | 1,313 | 1,313 |
| Off site | N/A | | | | | | |
| Total | 8,890,041 | | | | 2,963,347 | 1,426 | 1,426 |

Notes and Assumptions:

Total number of offsite full-time equivalents = 0.

Hours worked per year = 2,080.

One full-time equivalent was assumed for activities estimated to require less than 2,080 hours per year.

Key: N/A=not applicable.

Source: Compiled from SAIC 2007c, 2008.

**Table I-69. Waste Management Alternative 2, Disposal Group 3, Operations Rollup
Workforce Estimate**

| Activity | Total Hours | Duration | | | Hours per Year | Full-Time Equivalents per Year | Onsite Full-Time Equivalents |
|--|-------------|----------|--------|-------|----------------|--------------------------------|------------------------------|
| | | Start | Finish | Years | | | |
| Low-Level Radioactive Waste Burial Grounds (OPS_LLBG) | | | | | | | |
| Radiological workers | 586,520 | 2007 | 2050 | 44 | 13,330 | 7 | |
| Nonradiological workers | | | | | | | |
| On site | 172,615 | 2007 | 2050 | 44 | 3,923 | 2 | 9 |
| Off site | 293,621 | 2007 | 2050 | 44 | 6,673 | 4 | |

**Table I-69. Waste Management Alternative 2, Disposal Group 3, Operations Rollup
Workforce Estimate (continued)**

| Activity | Total Hours | Duration | | | Hours per Year | Full-Time Equivalents per Year | Onsite Full-Time Equivalents |
|---|--------------------|----------|--------|-------|------------------|--------------------------------|------------------------------|
| | | Start | Finish | Years | | | |
| Single Integrated Disposal Facility (OPS_IDF) | | | | | | | |
| Radiological workers | 1,995,282 | 2009 | 2165 | 157 | 12,709 | 7 | |
| Nonradiological workers | | | | | | | |
| On site | 2,762,698 | 2009 | 2165 | 157 | 17,597 | 9 | 16 |
| Off site | 3,683,597 | 2009 | 2165 | 157 | 23,462 | 12 | |
| River Protection Project Disposal Facility (OPS_RPPDF) | | | | | | | |
| Radiological workers | 64,067,328 | 2022 | 2165 | 144 | 444,912 | 214 | |
| Nonradiological workers | | | | | | | 330 |
| On site | 34,540,646 | 2022 | 2165 | 144 | 239,866 | 116 | |
| Off site | 64,067,328 | 2022 | 2165 | 144 | 444,912 | 214 | |
| Total | 171,583,114 | | | | 1,194,054 | 585 | 355 |

Notes and Assumptions:

Total number of offsite full-time equivalents = 230.

Hours worked per year = 2,080.

One full-time equivalent was assumed for activities estimated to require less than 2,080 hours per year.

Source: Compiled from SAIC 2007c, 2008.

**Table I-70. Waste Management Alternative 2, Disposal Group 3, Closure Rollup
Workforce Estimate**

| Activity | Total Hours | Duration | | | Hours per Year | Full-Time Equivalents per Year | Onsite Full-Time Equivalents |
|---|-------------------|----------|--------|-------|-------------------|--------------------------------|------------------------------|
| | | Start | Finish | Years | | | |
| Modified Resource Conservation and Recovery Act Subtitle C Barrier (CLO_IDF) | | | | | | | |
| Radiological workers | N/A | | | | | | |
| Nonradiological workers | | | | | | | 219 |
| On site | 909,255 | 2166 | 2167 | 2 | 454,627 | 219 | |
| Off site | 90,925 | 2166 | 2167 | 2 | 45,463 | 22 | |
| Postclosure Care (CLO_POSTIDF) | | | | | | | |
| Radiological workers | N/A | | | | | | |
| Nonradiological workers | | | | | | | 1 |
| On site | 138,092 | 2168 | 2267 | 100 | 1,381 | 1 | |
| Off site | N/A | | | | | | |
| Modified Resource Conservation and Recovery Act Subtitle C Barrier (CLO_RPPDF) | | | | | | | |
| Radiological workers | N/A | | | | | | |
| Nonradiological workers | | | | | | | 4,325 |
| On site | 17,991,632 | 2166 | 2167 | 2 | 8,995,816 | 4,325 | |
| Off site | 1,799,163 | 2166 | 2167 | 2 | 899,582 | 433 | |
| Postclosure Care (CLO_POSTRPPDF) | | | | | | | |
| Radiological workers | N/A | | | | | | |
| Nonradiological workers | | | | | | | 14 |
| On site | 2,732,453 | 2168 | 2267 | 100 | 27,325 | 14 | |
| Off site | N/A | | | | | | |
| Total | 23,661,521 | | | | 10,424,193 | 5,014 | 4,559 |

Notes and Assumptions:

Total number of offsite full-time equivalents = 455.

Hours worked per year = 2,080.

One full-time equivalent was assumed for activities estimated to require less than 2,080 hours per year.

Key: N/A=not applicable.

Source: Compiled from SAIC 2007c, 2008.

I.2.19 Waste Management Alternative 3: Disposal in IDF, 200-East and 200-West Areas

Table I-71. Waste Management Alternative 3 Construction Rollup Workforce Estimate

| Activity | Total Hours | Duration | | | Hours per Year | Full-Time Equivalents per Year | Onsite Full-Time Equivalents |
|---|------------------|----------|--------|-------|------------------|--------------------------------|------------------------------|
| | | Start | Finish | Years | | | |
| A 2706T/TA/TB Facility (CON_TPLANT) | | | | | | | |
| Radiological workers | N/A | | | | | | |
| Nonradiological workers | | | | | | | 19 |
| On site | 78,468 | 2011 | 2012 | 2 | 39,234 | 19 | |
| Off site | 31,033 | 2011 | 2012 | 2 | 15,516 | 8 | |
| Central Waste Complex (CON_WRAPCH) | | | | | | | |
| Radiological workers | N/A | | | | | | |
| Nonradiological workers | | | | | | | 213 |
| On site | 882,789 | 2011 | 2012 | 2 | 441,395 | 213 | |
| Off site | 133,191 | 2011 | 2012 | 2 | 66,595 | 33 | |
| Waste Receiving and Processing Facility (CON_WRAPRH) | | | | | | | |
| Radiological workers | N/A | | | | | | |
| Nonradiological workers | | | | | | | 119 |
| On site | 1,482,600 | 2013 | 2018 | 6 | 247,100 | 119 | |
| Off site | 509,296 | 2013 | 2018 | 6 | 84,883 | 41 | |
| Central Waste Complex (CON_CWCE) | | | | | | | |
| Radiological workers | N/A | | | | | | |
| Nonradiological workers | | | | | | | 71 |
| On site | 294,263 | 2011 | 2012 | 2 | 147,132 | 71 | |
| Off site | 104,571 | 2011 | 2012 | 2 | 52,286 | 26 | |
| Total | 3,516,211 | | | | 1,094,140 | 530 | 422 |

Notes and Assumptions:

Total number of offsite full-time equivalents = 108.

Hours worked per year = 2,080.

One full-time equivalent was assumed for activities estimated to require less than 2,080 hours per year.

Key: N/A=not applicable.

Source: Compiled from SAIC 2007c, 2008.

Table I-72. Waste Management Alternative 3 Operations Rollup Workforce Estimate

| Activity | Total Hours | Duration | | | Hours per Year | Full-Time Equivalents per Year | Onsite Full-Time Equivalents |
|--|-------------|----------|--------|-------|----------------|--------------------------------|------------------------------|
| | | Start | Finish | Years | | | |
| T Plant Solid Waste Activities (OPS_TPLANT) | | | | | | | |
| Radiological workers | 1,264,640 | 2013 | 2050 | 38 | 33,280 | 16 | |
| Nonradiological workers | | | | | | | 20 |
| On site | 316,160 | 2013 | 2050 | 38 | 8,320 | 4 | |
| Off site | N/A | | | | | | |
| Solid Waste Operations Complex Waste Receiving and Processing Facility (OPS_WRAPCH) | | | | | | | |
| Radiological workers | 21,660,000 | 2013 | 2050 | 38 | 570,000 | 275 | |
| Nonradiological workers | | | | | | | 300 |
| On site | 1,976,000 | 2013 | 2050 | 38 | 52,000 | 25 | |
| Off site | N/A | | | | | | |

Appendix I • Workforce Estimates

Table I-72. Waste Management Alternative 3 Operations Rollup Workforce Estimate (continued)

| Activity | Total Hours | Duration | | | Hours per Year | Full-Time Equivalents per Year | Onsite Full-Time Equivalents |
|--|-------------------|----------|--------|-------|----------------|--------------------------------|------------------------------|
| | | Start | Finish | Years | | | |
| Solid Waste Operations Complex Waste Receiving and Processing Facility (OPS_WRAPRH) | | | | | | | |
| Radiological workers | 7,296,000 | 2019 | 2050 | 32 | 228,000 | 110 | 120 |
| Nonradiological workers | | | | | | | |
| On site | 665,600 | 2019 | 2050 | 32 | 20,800 | 10 | |
| Off site | N/A | | | | | | |
| Central Waste Complex (OPS_CWCE) | | | | | | | |
| Radiological workers | 622,668 | 2013 | 2050 | 38 | 16,386 | 8 | 9 |
| Nonradiological workers | | | | | | | |
| On site | 69,198 | 2013 | 2050 | 38 | 1,821 | 1 | |
| Off site | N/A | | | | | | |
| Total | 33,870,266 | | | | 930,607 | 449 | 449 |

Notes and Assumptions:

Total number of offsite full-time equivalents = 0.

Hours worked per year = 2,080.

One full-time equivalent was assumed for activities estimated to require less than 2,080 hours per year.

Key: N/A=not applicable.

Source: Compiled from SAIC 2007c, 2008.

Table I-73. Waste Management Alternative 3 Deactivation Rollup Workforce Estimate

| Activity | Total Hours | Duration | | | Hours per Year | Full-Time Equivalents per Year | Onsite Full-Time Equivalents |
|---|----------------|----------|--------|-------|----------------|--------------------------------|------------------------------|
| | | Start | Finish | Years | | | |
| T Plant Solid Waste Activities (DEA_TPLANT) | | | | | | | |
| Radiological workers | 22,187 | 2051 | 2051 | 1 | 22,187 | 11 | 14 |
| Nonradiological workers | | | | | | | |
| On site | 5,547 | 2051 | 2051 | 1 | 5,547 | 3 | |
| Off site | N/A | | | | | | |
| Solid Waste Operations Complex Waste Receiving and Processing Facility–Deactivation of the Contact-Handled Mixed Transuranic/Transuranic Waste Facility (DEA_WRAPCH) | | | | | | | |
| Radiological workers | 285,000 | 2051 | 2051 | 1 | 285,000 | 138 | 151 |
| Nonradiological workers | | | | | | | |
| On site | 26,000 | 2051 | 2051 | 1 | 26,000 | 13 | |
| Off site | N/A | | | | | | |
| Solid Waste Operations Complex Waste Receiving and Processing Facility–Remote-Handled Transuranic Waste Expansion (DEA_WRAPRH) | | | | | | | |
| Radiological workers | 114,000 | 2051 | 2051 | 1 | 114,000 | 55 | 60 |
| Nonradiological workers | | | | | | | |
| On site | 10,400 | 2051 | 2051 | 1 | 10,400 | 5 | |
| Off site | N/A | | | | | | |
| Central Waste Complex (DEA_CWCE) | | | | | | | |
| Radiological workers | 8,193 | 2051 | 2051 | 1 | 8,193 | 4 | 5 |
| Nonradiological workers | | | | | | | |
| On site | 911 | 2051 | 2051 | 1 | 911 | 1 | |
| Off site | N/A | | | | | | |
| Total | 472,237 | | | | 472,237 | 230 | 230 |

Notes and Assumptions:

Total number of offsite full-time equivalents = 0.

Hours worked per year = 2,080.

One full-time equivalent was assumed for activities estimated to require less than 2,080 hours per year.

Key: N/A=not applicable.

Source: Compiled from SAIC 2007c, 2008.

Draft Tank Closure and Waste Management Environmental Impact Statement for the
Hanford Site, Richland, Washington

**Table I-74. Waste Management Alternative 3, Disposal Group 1, Construction Rollup
Workforce Estimate**

| Activity | Total Hours | Duration | | | Hours per Year | Full-Time Equivalents per Year | Onsite Full-Time Equivalents |
|--|------------------|----------|--------|-------|------------------|--------------------------------|------------------------------|
| | | Start | Finish | Years | | | |
| Two Integrated Disposal Facilities (One in 200-West Area and one in 200-East Area) (CON_IDFE) | | | | | | | |
| Radiological workers | N/A | | | | | | |
| Nonradiological workers | | | | | | | |
| On site | 1,496,280 | 2006 | 2008 | 3 | 498,760 | 240 | 240 |
| Off site | N/A | | | | | | |
| Two Integrated Disposal Facilities (One in 200-West Area and one in 200-East Area) (CON_IDFW) | | | | | | | |
| Radiological workers | N/A | | | | | | |
| Nonradiological workers | | | | | | | |
| On site | 1,115,924 | 2006 | 2008 | 3 | 371,975 | 179 | 179 |
| Off site | N/A | | | | | | |
| River Protection Project Disposal Facility (CON_RPPDF) | | | | | | | |
| Radiological workers | N/A | | | | | | |
| Nonradiological workers | | | | | | | |
| On site | 1,056,703 | 2019 | 2021 | 3 | 352,234 | 170 | 170 |
| Off site | N/A | | | | | | |
| Total | 3,668,908 | | | | 1,222,969 | 589 | 589 |

Notes and Assumptions:

Total number of offsite full-time equivalents = 0.

Hours worked per year = 2,080.

One full-time equivalent was assumed for activities estimated to require less than 2,080 hours per year.

Key: N/A=not applicable.

Source: Compiled from SAIC 2007c, 2008.

**Table I-75. Waste Management Alternative 3, Disposal Group 1, Operations Rollup
Workforce Estimate**

| Activity | Total Hours | Duration | | | Hours per Year | Full-Time Equivalents per Year | Onsite Full-Time Equivalents |
|--|-------------|----------|--------|-------|----------------|--------------------------------|------------------------------|
| | | Start | Finish | Years | | | |
| Low-Level Radioactive Waste Burial Grounds (OPS_LLBG) | | | | | | | |
| Radiological workers | 586,520 | 2007 | 2050 | 44 | 13,330 | 7 | |
| Nonradiological workers | | | | | | | 9 |
| On site | 172,615 | 2007 | 2050 | 44 | 3,923 | 2 | |
| Off site | 293,621 | 2007 | 2050 | 44 | 6,673 | 4 | |
| Integrated Disposal Facility-200-East Area (OPS_IDFE) | | | | | | | |
| Radiological workers | 1,385,530 | 2009 | 2050 | 42 | 32,989 | 16 | |
| Nonradiological workers | | | | | | | 38 |
| On site | 1,918,426 | 2009 | 2050 | 42 | 45,677 | 22 | |
| Off site | 2,557,901 | 2009 | 2050 | 42 | 60,902 | 30 | |
| Integrated Disposal Facility-200-West Area (OPS_IDFW) | | | | | | | |
| Radiological workers | 113,568 | 2009 | 2050 | 42 | 2,704 | 2 | |
| Nonradiological workers | | | | | | | 4 |
| On site | 157,248 | 2009 | 2050 | 42 | 3,744 | 2 | |
| Off site | 209,664 | 2009 | 2050 | 42 | 4,992 | 3 | |

**Table I-75. Waste Management Alternative 3, Disposal Group 1, Operations Rollup
Workforce Estimate (continued)**

| Activity | Total Hours | Duration | | | Hours per Year | Full-Time Equivalents per Year | Onsite Full-Time Equivalents |
|---|-------------------|----------|--------|-------|----------------|--------------------------------|------------------------------|
| | | Start | Finish | Years | | | |
| River Protection Project Disposal Facility (OPS_RPPDF) | | | | | | | |
| Radiological workers | 1,664,832 | 2022 | 2050 | 29 | 57,408 | 28 | |
| Nonradiological workers | | | | | | | 43 |
| On site | 897,562 | 2022 | 2050 | 29 | 30,950 | 15 | |
| Off site | 1,664,832 | 2022 | 2050 | 29 | 57,408 | 28 | |
| Total | 11,622,317 | | | | 320,701 | 159 | 94 |

Notes and Assumptions:

Total number of offsite full-time equivalents = 65.

Hours worked per year = 2,080.

One full-time equivalent was assumed for activities estimated to require less than 2,080 hours per year.

Source: Compiled from SAIC 2007c, 2008.

**Table I-76. Waste Management Alternative 3, Disposal Group 1, Closure Rollup
Workforce Estimate**

| Activity | Total Hours | Duration | | | Hours per Year | Full-Time Equivalents per Year | Onsite Full-Time Equivalents |
|---|-------------|----------|--------|-------|----------------|--------------------------------|------------------------------|
| | | Start | Finish | Years | | | |
| Integrated Disposal Facility-200-East Area (CLO_IDFE) | | | | | | | |
| Radiological workers | N/A | | | | | | |
| Nonradiological workers | | | | | | | 568 |
| On site | 2,360,193 | 2051 | 2052 | 2 | 1,180,096 | 568 | |
| Off site | 236,019 | 2051 | 2052 | 2 | 118,010 | 57 | |
| Integrated Disposal Facility-200-West Area (CLO_IDFW) | | | | | | | |
| Radiological workers | N/A | | | | | | |
| Nonradiological workers | | | | | | | 47 |
| On site | 193,458 | 2051 | 2052 | 2 | 96,729 | 47 | |
| Off site | 19,346 | 2051 | 2052 | 2 | 9,673 | 5 | |
| Postclosure Care-Integrated Disposal Facility 200-East Area (CLO_POSTIDFE) | | | | | | | |
| Radiological workers | N/A | | | | | | |
| Nonradiological workers | | | | | | | 2 |
| On site | 365,740 | 2053 | 2152 | 100 | 3,657 | 2 | |
| Off site | N/A | | | | | | |
| Postclosure Care-Integrated Disposal Facility 200-West Area (CLO_POSTIDFW) | | | | | | | |
| Radiological workers | N/A | | | | | | |
| Nonradiological workers | | | | | | | 1 |
| On site | 29,979 | 2053 | 2152 | 100 | 300 | 1 | |
| Off site | N/A | | | | | | |
| Modified Resource Conservation and Recovery Act Subtitle C Barrier (CLO_RPPDF) | | | | | | | |
| Radiological workers | N/A | | | | | | |
| Nonradiological workers | | | | | | | 559 |
| On site | 2,321,501 | 2051 | 2052 | 2 | 1,160,750 | 559 | |
| Off site | 232,150 | 2051 | 2052 | 2 | 116,075 | 56 | |

Draft Tank Closure and Waste Management Environmental Impact Statement for the
Hanford Site, Richland, Washington

**Table I-76. Waste Management Alternative 3, Disposal Group 1, Closure Rollup
Workforce Estimate (continued)**

| Activity | Total Hours | Duration | | | Hours per Year | Full-Time Equivalents per Year | Onsite Full-Time Equivalents |
|--|------------------|----------|--------|-------|------------------|--------------------------------|------------------------------|
| | | Start | Finish | Years | | | |
| Postclosure Care–River Protection Project Disposal Facility (CLO_POSTRPPDF) | | | | | | | |
| Radiological workers | N/A | | | | | | |
| Nonradiological workers | | | | | | | |
| On site | 352,575 | 2053 | 2152 | 100 | 3,526 | 2 | 2 |
| Off site | N/A | | | | | | |
| Total | 6,110,960 | | | | 2,688,817 | 1,297 | 1,179 |

Notes and Assumptions:

Total number of offsite full-time equivalents = 118.

Hours worked per year = 2,080.

One full-time equivalent was assumed for activities estimated to require less than 2,080 hours per year.

Key: N/A=not applicable.

Source: Compiled from SAIC 2007c, 2008.

**Table I-77. Waste Management Alternative 3, Disposal Group 2, Construction Rollup
Workforce Estimate**

| Activity | Total Hours | Duration | | | Hours per Year | Full-Time Equivalents per Year | Onsite Full-Time Equivalents |
|--|-------------------|----------|--------|-------|------------------|--------------------------------|------------------------------|
| | | Start | Finish | Years | | | |
| Two Integrated Disposal Facilities (One in 200-West Area and one in 200-East Area) (CON_IDFE) | | | | | | | |
| Radiological workers | N/A | | | | | | |
| Nonradiological workers | | | | | | | |
| On site | 1,211,013 | 2006 | 2008 | 3 | 403,671 | 195 | 195 |
| Off site | N/A | | | | | | |
| Two Integrated Disposal Facilities (One in 200-West Area and one in 200-East Area) (CON_IDFW) | | | | | | | |
| Radiological workers | N/A | | | | | | |
| Nonradiological workers | | | | | | | |
| On site | 1,115,924 | 2006 | 2008 | 3 | 371,975 | 179 | 179 |
| Off site | N/A | | | | | | |
| River Protection Project Disposal Facility (CON_RPPDF) | | | | | | | |
| Radiological workers | N/A | | | | | | |
| Nonradiological workers | | | | | | | |
| On site | 8,189,445 | 2019 | 2021 | 3 | 2,729,815 | 1,313 | 1,313 |
| Off site | N/A | | | | | | |
| Total | 10,516,383 | | | | 3,505,461 | 1,687 | 1,687 |

Notes and Assumptions:

Total number of offsite full-time equivalents = 0.

Hours worked per year = 2,080.

One full-time equivalent was assumed for activities estimated to require less than 2,080 hours per year.

Key: N/A=not applicable.

Source: Compiled from SAIC 2007c, 2008.

Table I-78. Waste Management Alternative 3, Disposal Group 2, Operations Rollup Workforce Estimate

| Activity | Total Hours | Duration | | | Hours per Year | Full-Time Equivalents per Year | Onsite Full-Time Equivalents |
|---|-------------------|----------|--------|-------|------------------|--------------------------------|------------------------------|
| | | Start | Finish | Years | | | |
| Low-Level Radioactive Waste Burial Grounds (OPS_LLBG) | | | | | | | |
| Radiological workers | 586,520 | 2007 | 2050 | 44 | 13,330 | 7 | 9 |
| Nonradiological workers | | | | | | | |
| On site | 172,615 | 2007 | 2050 | 44 | 3,923 | 2 | |
| Off site | 293,621 | 2007 | 2050 | 44 | 6,673 | 4 | |
| Integrated Disposal Facility-200-East Area (OPS_IDFE) | | | | | | | |
| Radiological workers | 945,318 | 2009 | 2100 | 92 | 10,275 | 5 | 12 |
| Nonradiological workers | | | | | | | |
| On site | 1,308,902 | 2009 | 2100 | 92 | 14,227 | 7 | |
| Off site | 1,745,203 | 2009 | 2100 | 92 | 18,970 | 10 | |
| Integrated Disposal Facility-200-West Area (OPS_IDFW) | | | | | | | |
| Radiological workers | 113,568 | 2009 | 2050 | 42 | 2,704 | 2 | 4 |
| Nonradiological workers | | | | | | | |
| On site | 157,248 | 2009 | 2050 | 42 | 3,744 | 2 | |
| Off site | 209,664 | 2009 | 2050 | 42 | 4,992 | 3 | |
| River Protection Project Disposal Facility (OPS_RPPDF) | | | | | | | |
| Radiological workers | 35,148,048 | 2022 | 2100 | 79 | 444,912 | 214 | 330 |
| Nonradiological workers | | | | | | | |
| On site | 18,949,382 | 2022 | 2100 | 79 | 239,866 | 116 | |
| Off site | 35,148,048 | 2022 | 2100 | 79 | 444,912 | 214 | |
| Total | 94,778,138 | | | | 1,208,528 | 586 | 355 |

Notes and Assumptions:

Total number of offsite full-time equivalents = 231.

Hours worked per year = 2,080.

One full-time equivalent was assumed for activities estimated to require less than 2,080 hours per year.

Source: Compiled from SAIC 2007c, 2008.

Table I-79. Waste Management Alternative 3, Disposal Group 2, Closure Rollup Workforce Estimate

| Activity | Total Hours | Duration | | | Hours per Year | Full-Time Equivalents per Year | Onsite Full-Time Equivalents |
|---|-------------|----------|--------|-------|----------------|--------------------------------|------------------------------|
| | | Start | Finish | Years | | | |
| Integrated Disposal Facility-200-East Area (CLO_IDFE) | | | | | | | |
| Radiological workers | N/A | | | | | | 177 |
| Nonradiological workers | | | | | | | |
| On site | 735,142 | 2101 | 2102 | 2 | 367,571 | 177 | |
| Off site | 73,514 | 2101 | 2102 | 2 | 36,757 | 18 | |
| Integrated Disposal Facility-200-West Area (CLO_IDFW) | | | | | | | |
| Radiological workers | N/A | | | | | | 47 |
| Nonradiological workers | | | | | | | |
| On site | 193,458 | 2051 | 2052 | 2 | 96,729 | 47 | |
| Off site | 19,346 | 2051 | 2052 | 2 | 9,673 | 5 | |
| Postclosure Care-Integrated Disposal Facility 200-East Area (CLO_POSTIDFE) | | | | | | | |
| Radiological workers | N/A | | | | | | 1 |
| Nonradiological workers | | | | | | | |
| On site | 113,919 | 2103 | 2202 | 100 | 1,139 | 1 | |
| Off site | N/A | | | | | | |

Draft Tank Closure and Waste Management Environmental Impact Statement for the
Hanford Site, Richland, Washington

**Table I-79. Waste Management Alternative 3, Disposal Group 2, Closure Rollup
Workforce Estimate (continued)**

| Activity | Total Hours | Duration | | | Hours per Year | Full-Time Equivalents per Year | Onsite Full-Time Equivalents |
|---|-------------------|----------|--------|-------|-------------------|--------------------------------|------------------------------|
| | | Start | Finish | Years | | | |
| Postclosure Care–Integrated Disposal Facility 200-West Area (CLO_POSTIDFW) | | | | | | | |
| Radiological workers | N/A | | | | | | |
| Nonradiological workers | | | | | | | |
| On site | 29,979 | 2053 | 2152 | 100 | 300 | 1 | 1 |
| Off site | N/A | | | | | | |
| Modified Resource Conservation and Recovery Act Subtitle C Barrier (CLO_RPPDF) | | | | | | | |
| Radiological workers | N/A | | | | | | |
| Nonradiological workers | | | | | | | |
| On site | 17,991,632 | 2101 | 2102 | 2 | 8,995,816 | 4,325 | 4,325 |
| Off site | 1,799,163 | 2101 | 2102 | 2 | 899,582 | 433 | |
| Postclosure Care–River Protection Project Disposal Facility (CLO_POSTRPPDF) | | | | | | | |
| Radiological workers | N/A | | | | | | |
| Nonradiological workers | | | | | | | |
| On site | 2,732,453 | 2103 | 2202 | 100 | 27,325 | 14 | 14 |
| Off site | N/A | | | | | | |
| Total | 23,688,607 | | | | 10,434,892 | 5,021 | 4,565 |

Notes and Assumptions:

Total number of offsite full-time equivalents = 456.

Hours worked per year = 2,080.

One full-time equivalent was assumed for activities estimated to require less than 2,080 hours per year.

Key: N/A=not applicable.

Source: Compiled from SAIC 2007c, 2008.

**Table I-80. Waste Management Alternative 3, Disposal Group 3, Construction Rollup
Workforce Estimate**

| Activity | Total Hours | Duration | | | Hours per Year | Full-Time Equivalents per Year | Onsite Full-Time Equivalents |
|--|-------------------|----------|--------|-------|------------------|--------------------------------|------------------------------|
| | | Start | Finish | Years | | | |
| Two Integrated Disposal Facilities (One in 200-West Area and one in 200-East Area) (CON_IDFE) | | | | | | | |
| Radiological workers | N/A | | | | | | |
| Nonradiological workers | | | | | | | |
| On site | 1,211,013 | 2006 | 2008 | 3 | 403,671 | 195 | 195 |
| Off site | N/A | | | | | | |
| Two Integrated Disposal Facilities (One in 200-West Area and one in 200-East Area) (CON_IDFW) | | | | | | | |
| Radiological workers | N/A | | | | | | |
| Nonradiological workers | | | | | | | |
| On site | 1,115,924 | 2006 | 2008 | 3 | 371,975 | 179 | 179 |
| Off site | N/A | | | | | | |
| River Protection Project Disposal Facility (CON_RPPDF) | | | | | | | |
| Radiological workers | N/A | | | | | | |
| Nonradiological workers | | | | | | | |
| On site | 8,189,445 | 2019 | 2021 | 3 | 2,729,815 | 1,313 | 1,313 |
| Off site | N/A | | | | | | |
| Total | 10,516,383 | | | | 3,505,461 | 1,687 | 1,687 |

Notes and Assumptions:

Total number of offsite full-time equivalents = 0.

Hours worked per year = 2,080.

One full-time equivalent was assumed for activities estimated to require less than 2,080 hours per year.

Key: N/A=not applicable.

Source: Compiled from SAIC 2007c, 2008.

Table I-81. Waste Management Alternative 3, Disposal Group 3, Operations Rollup Workforce Estimate

| Activity | Total Hours | Duration | | | Hours per Year | Full-Time Equivalents per Year | Onsite Full-Time Equivalents |
|---|--------------------|----------|--------|-------|------------------|--------------------------------|------------------------------|
| | | Start | Finish | Years | | | |
| Low-Level Radioactive Waste Burial Grounds (OPS_LLBG) | | | | | | | |
| Radiological workers | 586,520 | 2007 | 2050 | 44 | 13,330 | 7 | 9 |
| Nonradiological workers | | | | | | | |
| On site | 172,615 | 2007 | 2050 | 44 | 3,923 | 2 | |
| Off site | 293,621 | 2007 | 2050 | 44 | 6,673 | 4 | |
| Integrated Disposal Facility-200-East Area (OPS_IDFE) | | | | | | | |
| Radiological workers | 1,613,206 | 2009 | 2165 | 157 | 10,275 | 5 | 12 |
| Nonradiological workers | | | | | | | |
| On site | 2,233,670 | 2009 | 2165 | 157 | 14,227 | 7 | |
| Off site | 2,978,227 | 2009 | 2165 | 157 | 18,970 | 10 | |
| Integrated Disposal Facility-200-West Area (OPS_IDFW) | | | | | | | |
| Radiological workers | 113,568 | 2009 | 2050 | 42 | 2,704 | 2 | 4 |
| Nonradiological workers | | | | | | | |
| On site | 157,248 | 2009 | 2050 | 42 | 3,744 | 2 | |
| Off site | 209,664 | 2009 | 2050 | 42 | 4,992 | 3 | |
| River Protection Project Disposal Facility (OPS_RPPDF) | | | | | | | |
| Radiological workers | 64,067,328 | 2022 | 2165 | 144 | 444,912 | 214 | 330 |
| Nonradiological workers | | | | | | | |
| On site | 34,540,646 | 2022 | 2165 | 144 | 239,866 | 116 | |
| Off site | 64,067,328 | 2022 | 2165 | 144 | 444,912 | 214 | |
| Total | 171,033,642 | | | | 1,208,528 | 586 | 355 |

Notes and Assumptions:

Total number of offsite full-time equivalents = 231.

Hours worked per year = 2,080.

One full-time equivalent was assumed for activities estimated to require less than 2,080 hours per year.

Source: Compiled from SAIC 2007c, 2008.

Table I-82. Waste Management Alternative 3, Disposal Group 3, Closure Rollup Workforce Estimate

| Activity | Total Hours | Duration | | | Hours per Year | Full-Time Equivalents per Year | Onsite Full-Time Equivalents |
|---|-------------|----------|--------|-------|----------------|--------------------------------|------------------------------|
| | | Start | Finish | Years | | | |
| Integrated Disposal Facility-200-East Area (CLO_IDFE) | | | | | | | |
| Radiological workers | N/A | | | | | | 177 |
| Nonradiological workers | | | | | | | |
| On site | 735,142 | 2166 | 2167 | 2 | 367,571 | 177 | |
| Off site | 73,514 | 2166 | 2167 | 2 | 36,757 | 18 | |
| Integrated Disposal Facility-200-West Area (CLO_IDFW) | | | | | | | |
| Radiological workers | N/A | | | | | | 47 |
| Nonradiological workers | | | | | | | |
| On site | 193,458 | 2051 | 2052 | 2 | 96,729 | 47 | |
| Off site | 19,346 | 2051 | 2052 | 2 | 9,673 | 5 | |
| Postclosure Care-Integrated Disposal Facility 200-East Area (CLO_POSTIDFE) | | | | | | | |
| Radiological workers | N/A | | | | | | 1 |
| Nonradiological workers | | | | | | | |
| On site | 113,919 | 2168 | 2267 | 100 | 1,139 | 1 | |
| Off site | N/A | | | | | | |

**Table I-82. Waste Management Alternative 3, Disposal Group 3, Closure Rollup
Workforce Estimate (continued)**

| Activity | Total Hours | Duration | | | Hours per Year | Full-Time Equivalents per Year | Onsite Full-Time Equivalents |
|--|-------------------|----------|--------|-------|-------------------|--------------------------------|------------------------------|
| | | Start | Finish | Years | | | |
| Postclosure Care-Integrated Disposal Facility 200-West Area (CLO_POSTIDFW) | | | | | | | |
| Radiological workers | N/A | | | | | | |
| Nonradiological workers | | | | | | | |
| On site | 29,979 | 2053 | 2152 | 100 | 300 | 1 | 1 |
| Off site | N/A | | | | | | |
| Modified Resource Conservation Recovery Act Subtitle C Barrier (CLO_RPPDF) | | | | | | | |
| Radiological workers | N/A | | | | | | |
| Nonradiological workers | | | | | | | |
| On site | 17,991,632 | 2166 | 2167 | 2 | 8,995,816 | 4,325 | 4,325 |
| Off site | 1,799,163 | 2166 | 2167 | 2 | 899,582 | 433 | |
| Postclosure Care-River Protection Project Disposal Facility (CLO_POSTRPPDF) | | | | | | | |
| Radiological workers | N/A | | | | | | |
| Nonradiological workers | | | | | | | |
| On site | 2,732,453 | 2168 | 2267 | 100 | 27,325 | 14 | 14 |
| Off site | N/A | | | | | | |
| Total | 23,688,607 | | | | 10,434,892 | 5,021 | 4,565 |

Notes and Assumptions:

Total number of offsite full-time equivalents = 456.

Hours worked per year = 2,080.

One full-time equivalent was assumed for activities estimated to require less than 2,080 hours per year.

Key: N/A=not applicable.

Source: Compiled from SAIC 2007c, 2008.

I.3 REFERENCES

SAIC (Science Applications International Corporation), 2007a, Tank Closure Alternatives, Scaled Data Sets to Support the “Tank Closure and Waste Management Environmental Impact Statement for the Hanford Site, Richland, Washington,” Germantown, Maryland, July 12.

SAIC (Science Applications International Corporation), 2007b, Fast Flux Test Facility Alternatives, Scaled Data Sets to Support the “Tank Closure and Waste Management Environmental Impact Statement for the Hanford Site, Richland, Washington,” Germantown, Maryland, July 12.

SAIC (Science Applications International Corporation), 2007c, Waste Management Alternatives, Scaled Data Sets to Support the “Tank Closure and Waste Management Environmental Impact Statement for the Hanford Site, Richland, Washington,” Germantown, Maryland, July 12.

SAIC (Science Applications International Corporation), 2008, Revised Scaled Data Sets to Support the “Tank Closure and Waste Management Environmental Impact Statement for the Hanford Site, Richland, Washington,” Germantown, Maryland, October 9.