

# Report to Congress on the Potential Environmental Effects of Marine and Hydrokinetic Energy Technologies

December 2009

PREPARED IN RESPONSE TO THE ENERGY  
INDEPENDENCE AND SECURITY ACT OF  
2007, SECTION 633(B)

## **NOTICE**

This report is being disseminated by the Department of Energy. As such, it was prepared in compliance with Section 515 of the Treasury and General Government Appropriations Act for Fiscal Year 2001 (Pub. L. No. 106-554) and information guidelines issued by the Department of Energy.

Neither the United States government nor any agency thereof, nor any of their employees, makes any warranty, express or implied, or assumes any legal liability or responsibility for the accuracy, completeness, or usefulness of any information, apparatus, product, or process disclosed, or represents that its use would not infringe privately owned rights. Reference herein to any specific commercial product, process, or service by trade name, trademark, manufacturer, or otherwise does not necessarily constitute or imply its endorsement, recommendation, or favoring by the United States government or any agency thereof.



## Executive Summary

Section 633(b) of the Energy Independence and Security Act of 2007 (EISA) called for a report to be provided to Congress that would address (1) the potential environmental impacts of marine and hydrokinetic energy technologies, (2) options to prevent adverse environmental impacts, (3) the potential role of monitoring and adaptive management, and (4) the necessary components of an adaptive management program. As few marine and hydrokinetic devices have been deployed, there have been correspondingly few opportunities to assess their direct impacts. Based on the available information, however, as well as the observed impacts of other activities that may share some characteristics with the deployment and operation of marine and hydrokinetic technologies, this report describes nine types of environmental effects that may occur and describes how monitoring and adaptive management principles might be employed to evaluate and mitigate those effects. There is no conclusive evidence that marine and hydrokinetic technologies will actually cause significant environmental impacts, and the possible effects detailed in this report should serve to highlight areas where further information and research is needed.

This Report to Congress was prepared based on peer-reviewed literature, project documents, and both U.S. and international environmental assessments of these new technologies. The information was supplemented by contributions from technology developers and experts in state resource and regulatory agencies as well as non-governmental organizations. Inputs and reviews were also provided by Federal agencies including the National Oceanic and Atmospheric Administration (NOAA), the U.S. Department of the Interior (DOI), and the Federal Energy Regulatory Commission (FERC).

This report focuses on potential impacts of marine and hydrokinetic technologies to aquatic environments (i.e., rivers, estuaries, and oceans), fish and fish habitats, ecological relationships, and other marine and freshwater aquatic resources. The report does not address impacts to terrestrial ecosystems and organisms that are common to other electricity-generating technologies (e.g., construction and maintenance of transmission lines) or possible effects on the human environment, including:

- human use conflicts
- aesthetics
- viewsheds
- noise in the terrestrial environment
- light
- recreation
- transportation
- navigation
- cultural resources
- socioeconomic impacts

The cultural and socioeconomic effects of these technologies on coastal communities and other users of rivers and oceans would need to be evaluated to fully understand the range of impacts associated with deploying marine and hydrokinetic technologies on the environment and to take advantage of opportunities for mitigation. The impacts could be addressed more fully in separate, focused reports.

### ***Potential Environmental Effects of Marine and Hydrokinetic Energy Technologies***

There are well over 100 conceptual designs for converting the energy of waves, river and tidal currents, and ocean temperature differences into electricity. Most of these ocean energy and hydrokinetic renewable energy technologies remain at the conceptual stage and have not yet been developed as full-scale prototypes or tested in the field.

Consequently, there have been few studies of their environmental effects. Most considerations of the environmental effects have been in the form of predictive studies and environmental assessments that have not yet been verified. While these assessments cannot predict what if any impact a given technology may have at a given site, they have been instructive in identifying several common elements among the technologies that may pose a risk of adverse environmental effects:

- Alteration of current and wave strengths and directions
- Alteration of substrates and sediment transport and deposition
- Alteration of habitats for benthic organisms
- Noise during construction and operation
- Generation of electromagnetic fields (EMF)
- Toxicity of paints, lubricants, and antifouling coatings
- Interference with animal movements and migrations, including entanglement
- Strike by rotor blades or other moving parts

In the case of ocean thermal energy conversion technologies, additional potential effects stem from the intake and discharge of large volumes of sea water; changes in temperatures, nutrients, dissolved gases, and other water quality parameters; and entrainment of aquatic organisms into the intake and the discharge plume.

Although there have been few environmental studies of these new energy conversion concepts, a preliminary indication of the importance of each of the environmental issues was gained from published literature related to other technologies (e.g., noises generated by similar marine construction activities, EMF emissions from existing submarine cables, environmental monitoring of active offshore wind farms, and turbine passage injury mechanisms examined for conventional hydropower turbines). Experience with other similar activities in freshwater and marine systems has also provided information about impact minimization and mitigation options applicable to these new renewable energy technologies.

Table ES-1 summarizes potential effects to aquatic environments from installation and operation of marine and hydrokinetic renewable energy technologies. As shown in the table, project installation, operation, and decommissioning would change the physical environment. These changes would in turn have effects on biological resources, potentially including alteration of animal behaviors, damage and mortality to individual plants and animals, and wider, longer-term changes to plant and animal populations and communities. The cells in Table ES-1 are color coded to reflect the possible need for further studies of an environmental issue as a part of project licensing. For some issues, existing information summarized in this report suggests that the potential effects are likely to be minor and may not require extensive investigation; these cells are colored green and marked with one triangle. Other cells are colored yellow or red and marked

with two or three triangles, respectively, indicating an increasing possibility that further investigation may be needed at any particular site owing to a lack of information about a potentially greater environment effect. Regarding population-level and ecosystem-level responses (the last two columns in Table ES-1), there is insufficient information to make general statements about the seriousness of the effects for most projects. The need to study these higher-level environmental responses will hinge on the results of early monitoring and plans for the eventual size of the project. The color coding is not definitive; in all cases, particular characteristics of the site or technology will ultimately be used to determine the environmental monitoring that will be needed.

At this time, there is a lack of data to address the potential cumulative impacts of multiple projects on the environment, particularly when combined with the impacts of other human activities in rivers and oceans. Because of this lack of information, it is important that cumulative environmental impacts be evaluated during the leasing and site-specific permitting of individual projects to ensure informed decision making and the implementation of needed mitigation measures.

### ***Options to Prevent Adverse Environmental Impacts***

Mitigation of environmental effects can involve (1) avoiding the impact altogether by not taking a certain action or parts of an action; (2) minimizing impacts by limiting the degree or magnitude of the action and its implementation; (3) rectifying the impact by repairing, rehabilitating, or restoring the affected environment; (4) reducing or eliminating the impact over time by preservation and maintenance operations during the life of the action; and (5) compensating for the impact by replacing or providing substitute resources or environments. Many of the Federal and state agencies that are concerned with environmental effects of energy development prefer to implement mitigation in the order listed, giving priority to avoidance of impacts, then minimization, and finally to restoration.

The most certain way to mitigate potential impacts is to avoid environmentally sensitive areas. Such areas may be particularly fragile, exhibit high biological productivity or biodiversity, embody special cultural or environmental values (e.g., critical habitats for endangered species), or be vulnerable to major impacts from longer-range consequences like sedimentation. For biological resources, impacts are likely to be reduced by avoiding installation during sensitive seasons (e.g., during migrations of aquatic animals or reproductive periods for fish, marine mammals, and shorebirds). Structural and operational mitigation options are often unique to the technology or issue, and could include streamlining the shapes of non-generating structures, burial of electrical transmission cables, insulation against noise and EMF, protective screens to prevent entrainment or blade strike, and appropriate spacing of individual units or projects.

### ***The Potential Role of Monitoring and Adaptive Management***

Both monitoring and adaptive management have important roles in resolving the environmental issues associated with these new technologies. Some aspects of the environmental impacts will be unique to specific technologies or the environmental setting, requiring operational monitoring to determine the extent of the effects. Because

the environmental effects of these technologies are a function of both project design and site conditions, small projects sited in non-sensitive areas may not require extensive studies. On the other hand, large projects, especially those located in environmentally sensitive areas or in the presence of an endangered species, may be more likely to warrant substantial investigations. It should be emphasized that the potential significance of many of the environmental issues cannot yet be determined due to a lack of experience with operating projects. Also, the severity of these impacts could be increased by the cumulative effects of multiple units within a project, multiple projects, or energy projects coupled with other stressors. Potential effects on bottom habitats, hydrographic conditions, or animal movements that are inconsequential for a few units could become significant if large, multi-unit projects expand over large areas of a river, estuary, or the nearshore ocean. For some environmental issues, it will be difficult to extrapolate predicted effects from small to large numbers of units because of complicated, non-linear interactions between the placement of the machines and the distribution and movements of aquatic organisms. Assessment of these cumulative effects will require careful environmental monitoring as the projects are deployed.

The ability to modify a project in order to minimize and mitigate unacceptable environmental impacts identified by operational monitoring might be based on the application of adaptive management principles reflected in the project license conditions. In the context of marine and hydrokinetic energy technologies, adaptive management is a systematic process by which the potential environmental impacts of installation and operation could be evaluated against quantified environmental performance goals during project monitoring. Adaptive management allows for the repeated evaluation of monitoring results over time, in the context of specified outcomes. As projects expand from small, demonstration scales to commercial developments, the use of an adaptive management framework could be an effective means of resolving particular issues and addressing cumulative effects.

### ***The Components of an Adaptive Management Program***

The Federal agencies involved in licensing marine and hydrokinetic energy projects have procedures, rules, and/or guidance to help ensure sound and orderly development. Both FERC and DOI promote adaptive management as a tool to resolve uncertainties about environmental effects. The approaches toward adaptive management of proposed actions that are used by different organizations all share common components: definition and quantification of the desired outcomes, implementation, monitoring, evaluation, modification of the action, and re-evaluation through additional monitoring. Within this general framework, the adaptive management-related elements of energy project licenses issued by these agencies can be tailored to the particular technologies and unique environmental settings. Further, public input to the licensing actions will help refine the adaptive management components and performance goals embodied in each project license.

Early information about undesirable outcomes of environmental monitoring could lead to the implementation of additional minimization or mitigation actions that could then be re-evaluated. The adaptive management process is particularly valuable in the early stages

of technology development, when many of the potential environmental effects are unknown for individual units, much less for the build-out of large-scale projects. Basing project licenses and environmental monitoring programs on adaptive management principles, as advocated by many resource and regulatory agencies, will take advantage of ongoing research and monitoring to help refine technology designs and to improve environmental acceptability of future installations. The rapid dissemination of information will be an important part of this process.



**Table ES-1. Summary of potential impacts to the aquatic environment from installation and operation of marine and hydrokinetic renewable energy technologies.**

**Possibility that the issue will require further investigation: ▲ = low | ▲▲ = medium | ▲▲▲ = high\***

Issue	Potential effects on the physical and biological environment				
	Physical environment	Animal behavior	Individual injury & mortality	Population-level effects	Community- & ecosystem-level effects
Alteration of currents and waves	Current velocities or wave heights reduced in proportion to the size and number of units; possible changes to mixing, circulation, and water quality ▲▲	Changes in animal behavior resulting from alterations of currents, waves, circulation patterns, and water quality ▲	Likely not applicable ▲	Alterations of plant and animal populations from changes in hydrodynamics ▲▲	Alterations of plant and animal communities from changes in hydrodynamics ▲▲
Alteration of bottom substrates, sediment transport, and sediment deposition	Increased sediment deposition due to slower currents and smaller waves ▲▲	Behavioral responses to changed substrates and sediment dynamics ▲	Injuries or mortalities from gradual changes in substrate composition and dynamics ▲	Changes to plant and animal populations from changes in substrates ▲▲	Changes to plant and animal communities in vicinity of altered bottom substrates ▲▲
Alteration of benthic habitats	Habitat changes for bottom-dwelling plants and animals due to altered current velocities and sediment transport and deposition ▲▲	Avoidance of unsuitable habitats by some species and attraction by other species ▲▲	Mortality of sessile organisms during project installation ▲	Population declines in vicinity of the project for some species and population increases for other species ▲▲	Changes in plant and animal communities in response to altered substrates ▲▲
Noise	Additional noise in the environment from installation and operation ▲	Avoidance of areas with highest noise levels. Possible masking of animal communications and echolocation ▲▲	Hearing damage or mortality of marine animals near pile-driving activities and from operational noise ▲▲	Population level effects for marine mammals and sea turtles ▲▲	Changes to plant and animal communities from operational noise ▲▲
Electromagnetic fields (EMF)	New electrical and magnetic fields in the water and sediments near generating devices and electrical cables ▲	Altered feeding behavior, migration, reproduction, or susceptibility to predation of animals near the project ▲▲	Injuries and mortalities from the predicted electrical and magnetic field strengths ▲	Population-level impacts from effects on behavior and long-distance migrations ▲▲	Alterations of animal communities from effects on behavior and long distance migrations ▲▲

\* The color code and triangles are intended to indicate the possible need for further investigation of an issue as part of siting and licensing a project. These are not recommendations that studies of a particular environmental issue should or should not be conducted for any given site or technology. Rather, they are intended to help the reader see general patterns across all technologies and locations.

**Table ES-1 (continued). Summary of potential impacts to the aquatic environment from installation and operation of marine and hydrokinetic renewable energy technologies.**  
**Possibility that the issue will require further investigation: ▲ = low | ▲▲ = medium | ▲▲▲ = high\***

Issue	Effects on the physical and biological environment				
	Physical environment	Animal behavior	Individual injury & mortality	Population-level effects	Community- & ecosystem-level effects
Chemical toxicity	Releases of contaminants from oils and other operating fluids and anti-biofouling coatings ▲▲	Effects on behavior from released contaminants, except for avoidance of oil spills ▲▲	Toxicity to plants and animals exposed to contaminants; potential bioaccumulation of metals and other compounds ▲▲	Effects on local plant and animals populations from toxicity to individuals ▲▲	Effects on local communities and ecosystems from population-level changes ▲▲
Interference with animal movements and migrations	Creation of new structures and sensory stimuli on the bottom and in the water column ▲	Entanglement, obstruction, or avoidance by some organisms; attraction of some species to new habitat or sensory stimuli ▲▲▲	Injury and mortality associated with entanglement and increased predator activity; decreased injury and mortality if fishing is reduced ▲▲▲	Increases because of additional structures and reduced fishing; Declines from entanglement, predation, and interference with migrations ▲▲	Net effect of avoidance and attraction mechanisms and between population enhancements and declines ▲▲
Strike	Rigid, moving structure and possible cavitation near rapidly moving blades ▲	Ability of animals to sense and avoid strike may alter the potential for damage ▲▲	Injury and mortality from blade strike, impingement, and exposure to cavitation ▲▲▲	Changes to animal populations from strike mortality ▲▲	Effects on communities and ecosystems from strike mortality ▲▲
Ocean Thermal Energy Conversion (OTEC) operation	Transfer of large volumes of water between ocean depths; alteration of nutrients, water temperatures, dissolved solids, and dissolved gas concentrations; addition of biocides ▲▲▲	Effects on behavior; animals may avoid discharge plume and intakes ▲▲	Injury and mortality from entrainment, impingement, and temperature shock; toxicity of biocides ▲▲▲	Alteration of plant and animal populations from individual mortalities and avoidance of the project area ▲▲	Alteration of communities and ecosystems from mortalities, avoidance of the project area, and productivity changes ▲▲

\* The color code and triangle are intended to indicate the possible need for further investigation of an issue as part of siting and licensing a project. These are not recommendations that studies of a particular environmental issue should or should not be conducted for any given site or technology. Rather, they are intended to help the reader see general patterns across all technologies and locations.



## List of Figures

Figure 2-1.	General types of current energy converters. Technology type (technology name) and source of photograph are provided.....	5
Figure 2-2.	General types of wave energy converters. Technology type (technology name) and source of photograph are provided.....	8
Figure 2-3.	Schematic of an OTEC generation system. ....	10
Figure 2-4.	Potential co-products of an onshore OTEC electrical energy development. ....	10
Figure 3-1.	Since 1972, 13 national marine sanctuaries and 4 marine national monuments, representing a wide variety of ocean environments, have been established.....	12
Figure 3-2.	Horizontal axis turbine generators can be deployed on existing infrastructure such as bridge abutments in large rivers (e.g., Lower and Middle Mississippi). ....	14
Figure 3-3.	Artist's depiction of an array of PowerBuoy point absorbers deployed to capture wave energy.....	15
Figure 3-4.	The ORECon Multi Resonant Chambers (MRC) device deploys multiple OWCs around a 40-meter platform tethered to the sea floor offshore. ....	18
Figure 3-5.	Examples of different benthic habitats: (left to right) oyster bed, seagrass meadow, amphipod tube mat, sandflat. ....	20
Figure 3-6.	Mollusks comprise the largest portion of biomass on many offshore platforms. ....	21
Figure 3-7.	Johnson's seagrass is a threatened species with a disjunct and patchy distribution along the east coast of Florida. Its continued existence and recovery may be limited due to habitat alteration by a number of human and natural perturbations, including dredging and degraded water quality.....	22
Figure 3-8.	Harbor porpoises, like all marine mammals, are protected under the Marine Mammal Protection Act. ....	24
Figure 3-9.	Air bubble curtain in operation. ....	26
Figure 3-10.	Electronic acoustic harassment devices that are used to deter animals (e.g., Pacific harbor seals, California seal lions) from damaging property might also be useful for safely excluding marine mammals, fish, and marine turtles from an ocean energy installation. ....	27
Figure 3-11.	Diagram of High Frequency Acoustic Recording Package (a type of PAM) designed and built by the Whale Acoustics Lab at Scripps Institute of Oceanography.....	28
Figure 3-12.	Simplified view of the fields associated with submarine power cables.....	29
Figure 3-13.	A network of generating devices may have a matrix of electrical cables in the water along the bottom. ....	30
Figure 3-14.	Growth of biofouling organisms on a floating spherical buoy after 521 days at sea.....	32

Figure 3-15.	The leatherback is the largest of the living turtles. ....	34
Figure 3-16.	Jellyfish may become entangled in electrical and mooring cables.....	36
Figure 3-17.	Pilot whales socializing at the surface during the middle of the day.....	36
Figure 3-18.	Artist’s impression of the Seagen marine current turbine in Strangford Lough, UK. ....	39
Figure 3-19.	Predicted zone of potentially damaging strike associated with an unducted horizontal axis turbine. ....	39
Figure 3-20.	Ducted horizontal axis hydrokinetic turbine.....	40
Figure 3-21.	An OTEC system could produce a significant amount of power in those the world’s oceans where the temperature difference between the warm, surface water and the cold, deep water is about 20°C or more. ....	43
Figure 3-22.	Zooplankton, tiny animals that graze upon phytoplankton as they ride the ocean currents, are eaten by whales, small fish, invertebrates, and birds. ....	45
Figure 4-1.	The cultural use of an area by Native Americans is considered in NEPA documents. The Chumash, indigenous people historically lived along the California Coast from Malibu to San Luis Obispo; they harvested the marine resources of the Channel Islands for food and trade. ....	47
Figure 4-2.	Diagram of the adaptive management process. ....	49
Figure 4-3.	Appropriate conditions for adaptive management use.....	52
Figure 4-4.	FERC hydrokinetic projects and MMS alternative energy projects in the U. S.....	56
Figure 4-5.	Reedsport OPT Wave Park.....	57
Figure B-1.	U.S. Wave Technologies by Development Stage and Technology Type. ....	B-1
Figure B-2:	Example of the “List All Technologies” function in the Marine & Hydrokinetic Technology Database.....	B-2
Figure C-1.	Frequency spectrum (at 1/3-octave band levels) of pile-driving pulses at 400 m from the source. ....	C-2
Figure C-2.	Frequency spectrum (at 1/3-octave band levels) of ambient noise measured at five different locations of the North Sea at wind speeds of 3-8 m/s. From Thomsen <i>et al.</i> (2006). ....	C-5
Figure C-3.	Examples of audiograms of fish and marine mammals.....	C-9
Figure D-1.	Simplified view of the field associated with submarine power cables.....	D-1
Figure D-2.	Calculated magnetic field (A/m) and magnetic flux density (μT) near the WEC submarine power cable.....	D-3

## List of Tables

Table ES-1.	Summary of potential impacts to the aquatic environment from installation and operation of marine and hydrokinetic renewable energy technologies. ....	vi-vii
Table C-1.	Frequencies and intensities of some anthropogenic sounds.....	C-3



## Acronyms and Abbreviations

A	amperes
AAM	active acoustic monitoring
AC	alternating current
ADD	acoustic deterrent device
ADM	acoustic daylight monitoring
ADS	acoustic detection systems
AHD	acoustic harassment device
AMD	acoustic mitigation device
B	magnetic field
BACI	before-after, control-impact experimental design
CEQ	Council on Environmental Quality
CWA	Clean Water Act
CZMA	Coastal Zone Management Act
dB	decibel
DC	direct current
DOE	U.S. Department of Energy
DON	U.S. Department of the Navy
E	electrical field
EISA	Energy Independence and Security Act of 2007 (Public Law 110-140)
EMEC	European Marine Energy Centre
EMF	electromagnetic field
EMS	Environmental Management System
EPA	U.S. Environmental Protection Agency
FAD	fish aggregation device
FERC	Federal Energy Regulatory Commission
FRC	foul-release coatings
FWS	U.S. Fish and Wildlife Service
h	hour
HVDC	high voltage, direct current
Hz	hertz
ISO	International Organization for Standardization
iE	induced (secondary) electrical field
kg	kilogram
km	kilometer
kW	kilowatt
m	meter
MMS	Minerals Management Service
$\mu$ Pa	micropascal
m/s	meters per second
ms	milliseconds
MW	megawatt
MWe	megawatt electrical
NEPA	National Environmental Policy Act
NOAA	National Oceanic and Atmospheric Administration



OCS	Outer Continental Shelf
OTEC	ocean thermal energy conversion
P	pressure
PAM	passive acoustic monitoring
rms	root mean square
s	seconds
SEL	sound exposure level
SPL	sound pressure level
T	tesla
V	volt
WEC	wave energy conversion

## Glossary

**Absorption:** Conversion of sound to heat.

**Alternating current:** An electric current whose direction reverses cyclically.

**Acoustic signature:** The sound pressure levels across the full range of frequencies emitted by a device.

**Acoustic harassment device:** An underwater noise-generating device used by fish farmers to drive away predatory marine mammals, such as killer whales and seals.

**Ambient noise:** Background noise in the environment without distinguishable sources

**Acoustic mitigation:** A device that uses aversive or alarming sounds to move sensitive animals out of high risk areas.

**Amperage:** The rate of flow of electricity through a wire, measured in amperes (A).

**Anadromous:** Fish that ascend rivers from the sea for breeding.

**Anoxic:** Lacking oxygen.

**Attenuation (transmission loss):** Decrease of sound pressure levels or acoustic energy.

**Audiogram:** Graph showing the absolute auditory threshold versus frequency.

**Auditory threshold (hearing threshold):** Minimum sound level that can be perceived by an animal in the absence of background noise.

**B field:** Magnetic field, measured in teslas (T).

**Bandwidth:** The range of frequencies of a given sound

**Benthic macroinvertebrates:** Large (i.e., not microscopic) aquatic invertebrates that live in or on the bottom of freshwater and marine systems.

**Benthos:** The community of aquatic plants and animals that inhabit the bottom of lakes, rivers, and the ocean.

**Bioaccumulation:** The increase in concentration of a substance, such as a toxic chemical, in various tissues of a living organism.

**Bioassay:** A method of testing a material's effects on living organisms, for example, tests used to determine the toxicity of specific chemical contaminants.

**Biofouling:** The undesirable accumulation of microorganisms, plants, algae, and animals on submerged structures.

**Biomass:** The total quantity (weight) of living matter within a given unit of environmental area.

**Catadromous:** Fish that migrate from freshwater to the sea to spawn.

**Cavitation:** The sudden formation and collapse of low-pressure bubbles in liquids by means of mechanical forces, such as those resulting from rotation of a marine propeller.

**Cetacean:** A member of an order of aquatic (mostly marine) mammals, including whales, dolphins, and porpoises.

**Diadromous:** Fish that regularly migrate between freshwater and sea water, including both anadromous species (e.g., salmon and American shad) and catadromous species (e.g., eels).

**Direct current:** An electric current whose direction remains constant.

**Decibel (dB):** The logarithmic measure of sound intensity (sound pressure). The decibel value for sound pressure is  $20 \log_{10} (P/P_0)$ , with  $P$  = actual pressure and  $P_0$  = reference pressure.

**Dipole:** A pair of electric charges or magnetic poles, of equal magnitude but of opposite sign or polarity, separated by a small distance.

**Dynamic positioning:** A system that generally uses computer-driven propulsion units to maintain a floating offshore drilling rig in position over the well. It might be employed for energy conversion devices to reduce the need for anchors.

**E field:** Electric field, measured in V/m.

**Echolocation:** A sensory system in certain animals, such as dolphins, in which usually high-pitched sounds are emitted and their echoes interpreted to determine the direction and distance of objects. Also called echo ranging.

**Embolus:** A mass (such as an air bubble, a detached blood clot, or a foreign body) that travels through the bloodstream and lodges so as to obstruct or occlude a blood vessel.

**Electromagnetic field:** A physical field produced by electrically charged objects, and composed of an electric field and a magnetic field.

**Entrainment:** The incidental trapping of fish and other aquatic organisms in the water that passes through current energy devices or OTEC plants.

**Electroreception:** The ability of organisms to perceive electrical impulses, often used for detecting objects (electrolocation).

**Eutrophication:** The process by which water bodies receive excess nutrients that stimulate excessive plant growth.

**Fairing:** A structure whose primary function is to produce a smooth outline and reduce drag.

**Fish Aggregation Device (FAD):** Also called fish attraction device, a structure deployed in open water specifically to congregate fishes.

**Foraging:** The act of looking or searching for food.

**Frequency:** The rate of oscillations or vibration.

**Frequency spectrum:** The range of frequencies representing sounds produced by a given source or audible to an organism.

**HVDC transmission:** A high voltage, direct current power transmission system used for the long-range bulk transmission of electricity.

**Hz (Hertz):** The unit for sound wave frequency, where 1 Hz = 1 cycle per second. One kilohertz (1 kHz) is 1,000 cycles per second.

**Hydrofoil:** A device consisting of a flat or curved piece (as a metal plate) so that its surface reacts to the water that passes over it.

**Hydrokinetic:** Relating to the motions of fluids

**Hypoxia:** Low dissolved oxygen content in water

**iE field:** Induced electrical field, measured in V/m

**Impingement:** The entrapment of fish and shellfish on the outer part of an intake structure or against an intake screening device during water withdrawal.

**Magnetic flux density:** The density of magnetic lines of force, or magnetic flux lines, passing through a specific area, measured in teslas (T).

**Magnetoreception:** The ability of some organisms to perceive a magnetic field, often used for orientation and navigation.

**Marine Protected Area:** Any area of the intertidal or subtidal terrain, together with its overlying water and associated flora, fauna, historical, and cultural features, which has been reserved by law or other effective means to protect part or all of the enclosed environment.

**Marine Reserve:** An area where some or all fishing is prohibited for a lengthy period of time. A type of Marine Protected Area.

**Masking:** Obscuring sounds of interest by interfering sounds at similar frequencies.

**Mesocosm:** Outdoor, semi-controlled ecosystems (such as experimental ponds and streams) whose physical dimensions and basic water chemistry are known and controlled.

**Micropascal ( $\mu\text{Pa}$ ):** A unit of pressure. The reference pressure for underwater sound is  $1 \mu\text{Pa}$  ( $10^{-5} \mu\text{bar}$ ).

**Mooring:** Equipment, such as anchors or chains, for holding an energy device in place.

**Nekton:** Aquatic animals that swim strongly enough to resist the currents.

**Ocean thermal energy conversion (OTEC):** The conversion of energy arising from the temperature difference between warm surface water of oceans and cold deep-ocean current into electrical energy or other useful forms of energy.

**Odontocetes:** A suborder of toothed marine mammals, including belugas, narwhals, dolphins, porpoises, sperm whales, and killer whales.

**Pascal (Pa):** A unit of pressure equal to one Newton per square meter.

**Pelagic:** Pertaining to the open sea or water column, away from the sea bottom.

**Photic zone:** The surface layer of oceans or lakes that is penetrated by enough light to support photosynthesis.

**Pile (or piling):** Steel tube up to several meters in diameter used as a foundation for offshore structures.

**Pile driver:** – A device used to drive piles into the sediment using impulses or vibrations.

**Pinger:** A device that emits a short, high-pitched sound burst, sometimes used to deter marine mammals from dangerous areas.

**Pinniped:** A member of the suborder of carnivorous aquatic mammals that includes the seals, walruses, and similar animals having finlike flippers as organs of locomotion.

**Plankton:** Weakly swimming aquatic plants and animals that drift with the currents.

**Polychaete:** A mainly marine worm.

**Prototype:** The first full-scale, functional form of a new type or design.

**Recruitment:** The number of young-of-the-year fish entering a population in a given year. Alternatively, the size at which a fish can be legally caught or at which it becomes susceptible to a particular fishing gear.

**Rise time:** The time needed to go from zero to maximum sound pressure.

**Rotor:** The rotating part of a current energy conversion device, often propeller-like in form.

**Sound exposure level (SEL):** Sound level of a single sound event averaged in a way as if the event duration was 1 second.

**Sound pressure level (SPL):** The intensity of a sound, measured in decibels.

**Sound transmission:** Propagation of sound from a source through a medium (air, water, or sediments) to a receiver.

**Species diversity:** The number and frequency of species in a biological assemblage or community.

**Species richness:** The number of species present in an area or sample.

**Strumming:** Vibration of an underwater cable produced by water movements, typically the shedding of von Karman vortex streets from the cable.

**Sweeping:** The movement of unanchored mooring lines or electrical transmission cables in response to water movements.

**Turbidity:** A measure of water cloudiness caused by suspended particles.

**Turbine:** A machine that generates rotary mechanical power from the energy of a moving fluid, such as water or air.

**Voltage:** The difference in electrical potential between two points, and thus a measure of the pressure under which electricity flows.

**Wave energy:** The total energy in a wave is the sum of potential energy (due to vertical displacement of the water surface) and kinetic energy (due to water in oscillatory motion).

**Wave energy converter (WEC)** – A technical device or system designed to convert wave energy to electrical energy.



# Table of Contents

Executive Summary .....	i
List of Figures .....	ix
List of Tables .....	xi
Acronyms and Abbreviations .....	xiii
Glossary .....	xv
1 Introduction.....	1
2 Description of Technologies .....	4
2.1 Current Energy Technologies .....	4
2.2 Wave Energy Technologies .....	6
2.3 Ocean Thermal Energy Conversion.....	9
2.4 Marine and Hydrokinetic Technologies Database.....	9
3 Potential Environmental Impacts and Mitigation Options.....	11
3.1 Alteration of Currents and Waves.....	13
3.1.1 Potential Near Field and Far Field Impacts of Hydrodynamic Alterations.....	13
3.1.2 Mitigation Options to Address Hydrodynamic Alterations .....	17
3.2 Alteration of Substrates and Sediment Transport and Deposition.....	17
3.2.1 Potential Near Field and Far Field Impacts of the Alteration of Sediment Transport.....	18
3.2.2 Mitigation Options to Address the Alteration of Sediment Transport.....	19
3.3 Impacts of Habitat Alterations on Benthic Organisms .....	20
3.3.1 Displacement of Benthic Organisms by Installation of the Project.....	20
3.3.2 Alteration of Habitats for Benthic Organisms during Operation.....	21
3.3.3 Mitigation Options to Address Habitat Alterations for Benthic Organisms .....	23
3.4 Impacts of Noise .....	24
3.4.1 Noise in the Aquatic Environment and Its Effects on Animals .....	25
3.4.2 Mitigation Options to Address Noise .....	25
3.5 Impacts of Electromagnetic Fields (EMF).....	29
3.5.1 Effects of Electromagnetic Fields on Aquatic Organisms.....	29
3.5.2 Mitigation Options for Effects of Electromagnetic Fields.....	30
3.6 Toxic Effects of Chemicals.....	31
3.6.1 Toxicity of Paints, Anti-Fouling Coatings, and Other Chemicals .....	31
3.6.2 Mitigation Options to Address Chemical Toxicity.....	32
3.7 Interference with Animal Movements and Migrations.....	33
3.7.1 Alteration of Local Movement Patterns.....	33
3.7.2 Interference with Migratory Animals .....	35
3.7.3 Mitigation Options to Address Local and Migratory Movements of Animals.....	37



3.8	Collision and Strike.....	37
3.8.1	Effects of Rotor Blade Strike on Aquatic Animals.....	38
3.8.2	Effects of Water Pressure Changes and Cavitation.....	41
3.8.3	Mitigation Options to Address Collision and Strike.....	41
3.9	Impacts of Ocean Thermal Energy Conversion (OTEC).....	43
3.9.1	Effects on Ocean Ecosystems.....	44
3.9.2	Mitigation Options to Address Effects of OTEC Technologies on Ocean Ecosystems.....	46
4	Environmental Assessment, Adaptive Management, and Environmental Monitoring.....	47
4.1	Environmental Impact Assessment Approaches.....	47
4.2	Incorporating Adaptive Management into Development and Environmental Monitoring of Marine and Hydrokinetic Energy Technologies.....	49
4.3	Federal Licensing of Marine and Hydrokinetic Renewable Energy Technologies.....	55
4.4	Environmental Monitoring.....	58
4.4.1	Monitoring for Alteration of Currents and Waves.....	60
4.4.2	Monitoring for Effects on Sediment Transport.....	60
4.4.3	Monitoring for Effects of Benthic Habitat Alterations.....	60
4.4.4	Monitoring for Effects of Noise.....	61
4.4.5	Monitoring for Electromagnetic Fields.....	62
4.4.6	Monitoring the Toxic Effects of Chemicals.....	62
4.4.7	Monitoring Interference with Animal Movements and Migrations.....	62
4.4.8	Monitoring the Effects of Strike.....	63
4.4.9	Monitoring of OTEC Projects.....	64
4.4.10	Monitoring for Cumulative Impacts of Multiple Units and Multiple Energy Projects.....	64
5	Conclusions.....	66
6	Literature Cited.....	68
	Appendix A.....	A-1
	Appendix B.....	B-1
	Appendix C.....	C-1
	Appendix D.....	D-1

# 1 Introduction

Broadly categorized as “marine and hydrokinetic” energy systems, a new generation of water power technologies offers the possibility of generating electricity from water without the need for dams and diversions. There are numerous plans, both in the United States and internationally, to develop these energy conversion technologies. However, because the concepts are new, few devices have been deployed and tested in rivers and oceans. Even fewer environmental studies of these technologies have been carried out, and thus potential environmental effects remain mostly speculative (Pelc and Fujita 2002; Cada *et al.* 2007; Michel *et al.* 2007; Boehlert *et al.* 2008).

Section 633(b) of the Energy Independence and Security Act of 2007 (EISA; Pub. L. 110-140; signed December 19, 2007) called for a report to be issued to Congress:

- (b) REPORT.-Not later than 18 months after the date of enactment of this Act, the Secretary, in conjunction with the Secretary of Commerce, acting through the Undersecretary of Commerce for Oceans and Atmosphere, and the Secretary of the Interior, shall provide to the Congress a report that addresses-
- (1) the potential environmental impacts, including impacts to fisheries and marine resources, of marine and hydrokinetic renewable energy technologies;
  - (2) options to prevent adverse environmental impacts;
  - (3) the potential role of monitoring and adaptive management in identifying and addressing any adverse environmental impacts; and
  - (4) the necessary components of such an adaptive management program.

Section 632 provides the following definitions used in the development of this Report:

- For the purposes of this Act, the term "marine and hydrokinetic renewable energy" means electrical energy from-
- (1) waves, tides, and currents in oceans, estuaries, and tidal areas;
  - (2) free flowing water in rivers, lakes, and streams;
  - (3) free flowing water in man-made channels; and
  - (4) differentials in ocean temperature (ocean thermal energy conversion).

The term “marine and hydrokinetic renewable energy” does not include energy from any source that uses a dam, diversionary structure, or impoundment for electric power purposes.

This report addresses the requirements of EISA Section 633(b) by describing the technologies that are being considered for development (Section 2), their potential environmental impacts and options to minimize or mitigate the impacts (Section 3), and the potential role of environmental monitoring and adaptive management in guiding their deployment (Section 4). The report was prepared by the U.S. Department of Energy (DOE) based on the following sources:

- Reviews of existing information obtained from peer-reviewed journals; U.S. and international environmental impact assessments; and websites of technology developers, research organizations, and resource management agencies

- Contacts with technology developers to ascertain the environmental issues that they have faced and their plans for resolving the issues
- Consultations with the technical staff of the Departments of Commerce (National Oceanic and Atmospheric Administration [NOAA]) and Interior (Minerals Management Service [MMS], U.S. Fish and Wildlife Service [FWS], National Park Service [NPS], and Bureau of Indian Affairs [BIA]) (Appendix A)
- Input received from regulatory agencies (e.g., the Federal Energy Regulatory Commission [FERC]), state agencies, the public, academic institutions, and non-governmental organizations (Appendix A)

Section 632 of EISA specifically excludes energy sources that use dams, diversionary structures, or impoundments; it considers only technologies that can be broadly classified as wave energy and current energy devices and ocean thermal energy conversion (OTEC). This report focuses on potential impacts of these technologies to the environment, particularly aquatic environments (rivers, estuaries, and oceans), fish and fish habitats, ecological relationships, and other marine and freshwater aquatic resources. It does not evaluate impacts to terrestrial ecosystems and organisms that are common to other electricity-generating technologies (e.g., construction and maintenance of transmission lines); assessments of these issues can be found in other reviews (e.g., Bevanger 1998; Willyard *et al.* 1998; Lehman *et al.* 2007).

Also, this report does not address the following:

- |                       |                         |
|-----------------------|-------------------------|
| ▪ human use conflicts | ▪ recreation            |
| ▪ aesthetics          | ▪ transportation        |
| ▪ viewsheds           | ▪ navigation            |
| ▪ noise               | ▪ cultural resources    |
| ▪ light               | ▪ socioeconomic impacts |

The cultural and socioeconomic impacts of these technologies on coastal communities and other users of rivers and oceans are important, and these concerns could be addressed more fully in separate, focused reports and during site-specific leasing and licensing decisions. For example, Hackett (2008) considered the potential socioeconomic effects of developing wave energy projects in California. The Programmatic Environmental Impact Statement for Alternative Energy Production and Alternate Uses of Facilities on the Outer Continental Shelf (MMS 2007) presented in detail the effects of alternate energy technologies on other human uses. In that document and the subsequent Record of Decision (73 FR 1894; January 10, 2008), the MMS identified 52 “best management practices” that will be individually considered when authorizing any lease for alternative energy development on the Outer Continental Shelf (OCS). Similarly, the NPS provides comments to the FERC on the potential impacts of proposed hydrokinetic projects to recreation, public access, and aesthetics. Consideration of the full range of impacts to the human environment will occur in the environmental analyses completed in compliance with the National Environmental Policy Act (NEPA).

This report is being disseminated by DOE. As such, it was prepared in compliance with Section 515 of the Treasury and General Government Appropriations Act for Fiscal Year 2001 (Public Law 106-554) and information quality guidelines issued by DOE. This report has been subject to pre-dissemination reviews for purposes of the basic information quality guidelines.

## 2 Description of Technologies

Bedard *et al.* (2007) outlined the wave and current energy resources that are estimated to be available in North America, as well as the types of technologies that could be used to exploit them. Numerous technologies have been proposed to convert the kinetic energy, potential energy, or thermal energy in freshwater and marine systems into electricity. This section provides a brief description of each of these general approaches and the status of technology development.

### 2.1 Current Energy Technologies

Current energy technologies (also called tidal or hydrokinetic technologies) (Figure 2-1) convert the kinetic energy associated with moving water into electricity. Current energy technologies depend on the horizontal movements of river currents and ocean currents (tidal and stream) to drive a generator that converts mechanical power into electrical power. Current energy devices are often rotating machines that can be compared to wind turbines – a rotor spins in response to the movements of water currents with the rotational speed being proportional to the velocity of the fluid (Bedard 2005). The rotor may have an open design like a wind turbine or may be enclosed in a duct that channels the flow. Further, the rotor may be characterized by conventional “propeller-type” blades or helical blades.

The European Marine Energy Centre (EMEC) further divides current energy converters into four main types:

- **Horizontal axis turbines.** Horizontal axis turbines often look similar to wind turbines. They extract kinetic energy from the moving water in the same way that wind turbines extract energy from moving air.
- **Ducted horizontal axis turbines.** Enclosing the horizontal rotor inside a duct (often funnel-shaped) has the effect of concentrating the flow past the turbine. This configuration may allow operation over a greater range of current velocities, thereby generating more electricity per unit of rotor area (Kirke 2006).
- **Vertical axis turbines.** In vertical axis turbines, the axis of the rotor is oriented perpendicular to the flow. These turbines may also take different forms, such as being enclosed within a duct.
- **Oscillating hydrofoils.** Oscillating hydrofoils pivot in response to tidal currents flowing over a wing or flap-like structure; the movements drive fluid in a hydraulic system to generate electricity.

There are no commercial developments of current energy converting technologies in the U.S., although several partial- or full-scale prototypes have been tested. For example, Verdant Power is conducting performance and environmental monitoring of an array of six horizontal axis turbines in the East River in New York City. If operation and environmental impacts are acceptable, this initial project could lead to an arrangement of around 100 turbines.

## Current Energy Converters



Oscillating Hydrofoil (Stingray)  
Source: The Engineering Business



Horizontal Axis Turbine (DEEP-Gen)  
Source: Tidal Generation

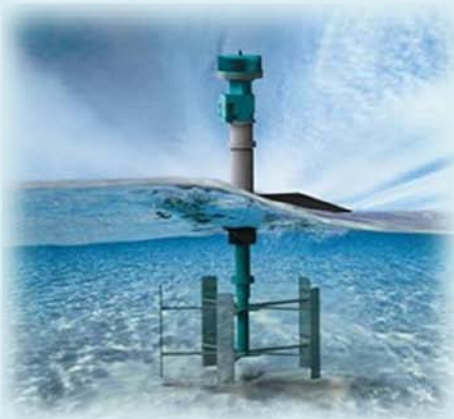

Vertical Axis Turbine  
(Blue Energy Ocean Turbine)  
Source: Blue Energy



Ducted Horizontal Axis Turbine  
(Open-Centre Turbine)  
Source: OpenHydro

Figure 2-1. General types of current energy converters. Technology type (technology name) and source of photograph are provided.

## 2.2 Wave Energy Technologies

Wave energy technologies (Figure 2-2) convert wave energy (the sum of potential energy [due to vertical displacement of the water surface] and kinetic energy [due to water in oscillatory motion]) into electricity. Thus, these devices operate by means of changes in the height of ocean waves (head or elevation changes). There is a wide variety of wave energy converter designs that can be categorized in several ways (e.g., Bedard 2005; Michel *et al.* 2007).

The EMEC divides wave energy converters into six main types:

- **Point absorbers.** Point absorbers are like buoys, floating at or near the surface and moored to the ocean bottom. These devices are able to capture energy from a wave front greater than the physical dimension of the device. The vertical motions of ocean waves provide the mechanical power to drive an electrical generator.
- **Attenuators.** Attenuators are floating structures that are orientated parallel to the direction of the incoming wave (rather than perpendicular as with a point absorber). The differences in the relative horizontal and vertical motions of the articulated parts of an attenuator are converted into electricity by an internal generator.
- **Oscillating wave surge converters.** Oscillating wave surge converters are considered to be pitching/surging/heaving devices, which utilize the relative motion between a flap and a fixed reaction point. These devices are fixed to the bottom (or hang from a floating or shoreline structure) and swing like a gate in response to the surging movement of water in the waves.
- **Oscillating water column.** An oscillating water column device is a partially submerged structure that encloses a column of air above a column of water; a collector funnels waves into the structure below the waterline, causing the water column to rise and fall; this alternately pressurizes and depressurizes the air column, pushing or pulling it through a bidirectional air turbine. Oscillating water column devices can be installed on the shoreline or floating and moored to the bottom.
- **Overtopping devices.** Overtopping devices incorporate elements from traditional hydroelectric power plants (vertical axis turbine) in an offshore floating platform. A collector on the partially submerged structure funnels waves over the top of the structure into a reservoir and then the water runs back out to the sea from this reservoir through low-head hydropower turbines.
- **Submerged pressure differential devices.** Submerged pressure differential devices are typically located near the shore and attached to the seabed. Wave motions cause the water level to rise and fall above the device, which induces a pressure differential inside the device that can then pump fluid to drive a generator.

There are no full-scale wave energy projects in operation in the U.S. Wave converter technologies have undergone or are slated to undergo pilot scale tests in the U.S., including attenuators and point absorbers. Field tests of various wave converter types have been carried out or are planned in other countries: point absorbers (Portugal, United Kingdom, Sweden, Spain, Norway, Denmark, and Ireland), attenuators (Portugal, United Kingdom, Israel, Sri Lanka, and Canada), oscillating wave surge converters (United Kingdom, Australia, Japan, and Denmark), oscillating water column (Portugal, Japan, Ireland, Australia, United Kingdom, and Spain), and overtopping devices (Denmark, United Kingdom, and Norway). Of these, oscillating water column technologies in Portugal, Spain, and the United Kingdom are presently producing electrical power, and the commercial operation of three Pelamis attenuators began in Portugal in September 2008.



## Wave Energy Converters



Submerged Pressure Differential  
(Archimedes Wave Swing)  
Source: AWS Ocean Energy



Oscillating Water Column (OEBuoy)  
Source: Ocean Energy



Oscillating Wave Surge Converter  
(Wave Roller) Source: AW Energy



Point Absorber (PowerBuoy)  
Source: Ocean Power Technologies



Attenuator (Pelamis)  
Source: Pelamis Wave Power



Overtopping  
(Wave Dragon)  
Source: Wave  
Dragon, Ltd.

Figure 2-2. General types of wave energy converters. Technology type (technology name) and source of photograph are provided.

### **2.3 Ocean Thermal Energy Conversion**

Ocean thermal energy conversion (OTEC) relies on the temperature difference between cold, deep water and warm, surface waters of the ocean to alternately evaporate and condense a fluid (Figure 2-3). Two distinct types of OTEC technologies have been developed, and a third form is a hybrid; all use thermal energy in seawater to power a steam turbine (TCPA 2008). Closed-cycle OTEC uses warm seawater to vaporize a low-boiling-point liquid (e.g., ammonia, propane, or freon) that drives a turbine to generate electricity. The vapor is cooled and condensed back to a liquid by cold seawater at depth, and the cycle repeats. Open-cycle OTEC vaporizes warm seawater by lowering the pressure and uses the resulting steam to drive a turbine. Much like closed-cycle OTEC, cold seawater condenses the vapor after it leaves the turbine in an open-cycle system. Finally, the hybrid design uses steam from boiled seawater to vaporize a low-boiling-point liquid, which then drives a turbine. Ocean thermal energy conversion (OTEC) plants can be built either onshore or on offshore floating platforms or ships (Pelc and Fujita 2002). If located onshore, the OTEC development could be used not only to generate electricity, but also to provide co-products such as desalinated water, coldwater air conditioning, aquaculture, agriculture, ice, and hydrogen fuel (<http://www.nrel.gov/otec/applications.html>) (Figure 2-4).

Theoretically, OTEC systems can tap an enormous global resource, far greater than that of current and wave energy conversion systems (Buigues *et al.* 2006). However, the temperature difference between surface and deep waters required for OTEC to work efficiently is 20° C or higher; the higher the temperature differential, the better the efficiency. These temperature ranges are generally limited to tropical, equatorial oceans with access to deep (e.g., 600 meters [m]) water (Heydt 1993). In the U.S., such areas are found mainly near the Hawaiian Islands ([http://www.nrel.gov/otec/design\\_location.html](http://www.nrel.gov/otec/design_location.html)), but potential sites may also occur near Puerto Rico and the continental shelf of the Gulf of Mexico (Pelc and Fujita 2002), as well as Guam and other U.S. Pacific Islands.

### **2.4 Marine and Hydrokinetic Technologies Database**

The DOE Wind and Hydropower Program released the Marine and Hydrokinetic Technologies Database, which provides frequently updated information on marine and hydrokinetic renewable energy innovations, both in the U.S. and around the world. The database includes wave, tidal, current, and ocean thermal energy conversion devices, companies active in the field, and status of projects in the water. Depending on the needs of the user, the database can present a snapshot of projects in a given region, assess the progress of a certain technology type, or provide a comprehensive view of the entire marine and hydrokinetic energy industry. This online resource is available at <http://www1.eere.energy.gov/windandhydro/hydrokinetic/default.aspx>. Additional information is provided in Appendix B.

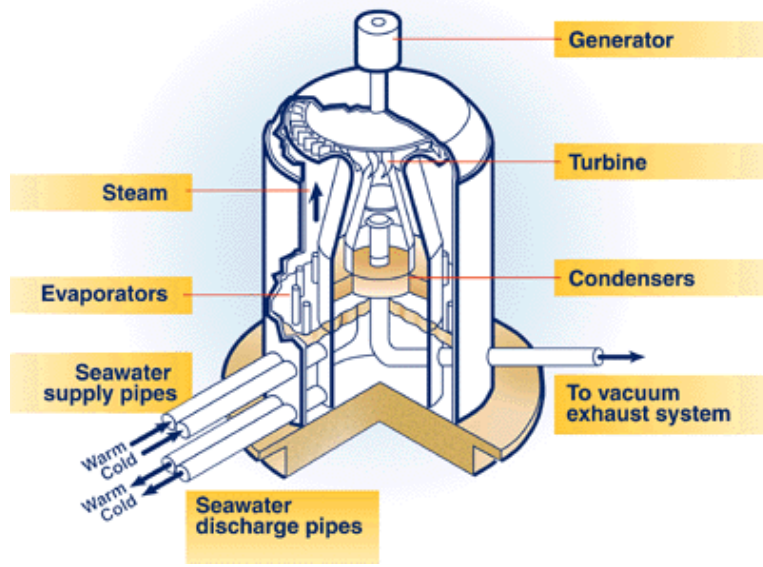

Figure 2-3. Schematic of an OTEC generation system. Source: National Renewable Energy Laboratory, <http://www.nrel.gov/otec/what.html>



Figure 2-4. Potential co-products of an onshore OTEC electrical energy development. Source: Ocean Engineering & Energy Systems (OCEES), <http://www.ocees.com/mainpages/Coproducts.html>

### 3 Potential Environmental Impacts and Mitigation Options

This section summarizes the peer-reviewed literature and technical reports describing the potential environmental impacts of new ocean energy and hydrokinetic technologies and measures to mitigate them.

Environmental issues that apply to all technologies include alteration of river or ocean currents or waves (Section 3.1), alteration of bottom substrates and sediment transport/deposition (Section 3.2), alteration of bottom habitats (Section 3.3), impacts of noise (Section 3.4), effects of electromagnetic fields (Section 3.5), toxicity of chemicals (Section 3.6), and interference with animal movements and migrations (Section 3.7). Designs that incorporate moving rotors or blades also pose the potential for injury to aquatic organisms from strike or impingement (Section 3.8). Ocean thermal energy conversion technologies have unique environmental impacts that are described in Section 3.9.

The Council on Environmental Quality (CEQ) definition of mitigation in 40 CFR 1508.20(a-e) is used in this report and includes the following:

- Avoiding the impact altogether by not taking a certain action or parts of an action
- Minimizing impacts by limiting the degree or magnitude of the action and its implementation
- Rectifying the impact by repairing, rehabilitating, or restoring the affected environment
- Reducing or eliminating the impact over time by preservation and maintenance operations during the life of the action
- Compensating for the impact by replacing or providing substitute resources or environments

Many of the Federal and state agencies that are concerned with environmental effects of energy development prefer to implement mitigation in the order listed above, giving priority to avoidance of impacts, then minimization, and finally to restoration. Whereas some of the possible mitigation options described in this section are structural or operational, the reduction of project impacts through the avoidance of environmentally sensitive areas would be an important consideration for nearly all of the issues. Such areas may be particularly fragile, exhibit high biological productivity or biodiversity, embody some special cultural or environmental values (e.g., critical habitats for endangered species), or be vulnerable to major impacts from longer-range consequences like sedimentation. MMS (2007) described areas of special concern for alternative energy development on the Outer Continental Shelf (OCS) including national marine sanctuaries and marine national monuments (Figure 3-1), national parks, national monuments, national seashores, national wildlife refuges, national estuarine research reserves, and estuaries within the National Estuary Program. Marine reserves are areas where some or all fishing is prohibited (PFMC 2007). Marine protected areas are geographic areas with discrete boundaries that have been designated to enhance the conservation of marine resources; an online inventory of marine protected areas is

provided at Marine Protected Areas of the United States (2008). NOAA (2008) provides maps of sensitive coastal resources that are at risk from accidents such as oil spills. Examples of at-risk resources include biological resources (e.g., birds and shellfish beds), sensitive shorelines (e.g., marshes and tidal flats), and human-use resources (e.g., public beaches and parks). Many states have enacted broad river protection programs, and designation of a river under the Federal Wild and Scenic Rivers Act may preclude development. The Federal Energy Regulatory Commission is prohibited from licensing hydropower projects within a Wild and Scenic River corridor under Section 7(a) of the Wild and Scenic Rivers Act. A project upstream, downstream, or on any tributary to a Wild and Scenic River is prohibited if the project has the potential to “invade the area or unreasonably diminish” the free-flow or scenic, recreational, and fish and wildlife values present within the Wild and Scenic River. In addition to the Federal lists, individual states may have their own lists of sensitive areas within which the development of marine and hydrokinetic energy technologies would be constrained or prohibited. While project development would not necessarily be excluded from environmentally sensitive areas, they should be given special consideration in siting, and detailed spatial and temporal investigations could be used to identify optimum locations that would minimize environmental damage. It may be possible to minimize impacts to these areas by restricting installation and maintenance activities during migrations, reproductive seasons, and other sensitive times.

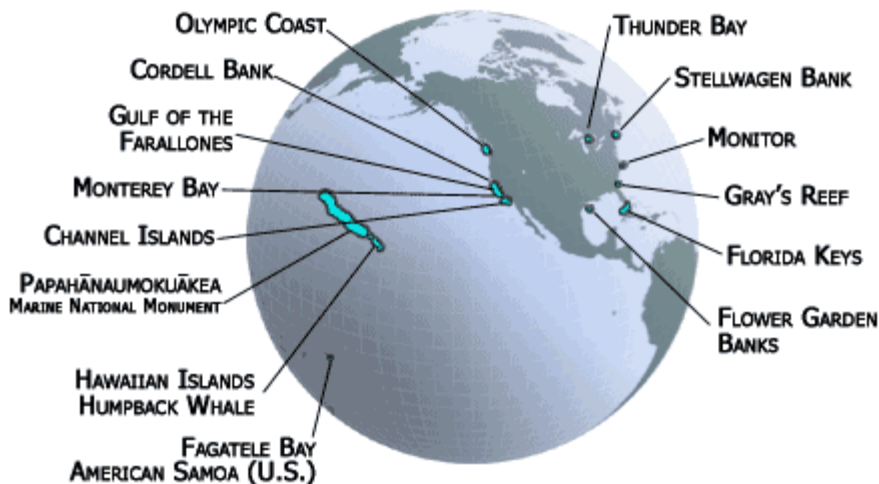

Figure 3-1. Since 1972, 13 national marine sanctuaries and 4 marine national monuments, representing a wide variety of ocean environments, have been established. Source: NOAA, <http://sanctuaries.noaa.gov/visit/welcome.html>



Recent reviews of the potential impacts of these technologies have been conducted (Michel *et al.* 2007; Boehlert *et al.* 2008), which mainly focus on ocean systems and their effects on marine organisms. However, freshwater organisms would experience the same impacts from hydrokinetic energy developments, and diadromous fish (that regularly migrate between fresh water and sea water) could be exposed to both hydrokinetic/current projects and wave energy projects. Many of the reviews and environmental assessments make judgments about significance of potential impacts, but few of these are based on *in situ* monitoring or even predictive modeling. Adding to the uncertainty about the actual impacts of particular technologies are the uncertainties about scaling up from single units to the cumulative impacts of dozens or hundreds of multiple units that would eventually be installed as part of the full build-out of energy projects. For some environmental issues (e.g., habitat alteration, sediment suspension, toxicity of chemicals), the cumulative impacts are likely to be approximately proportional to the number of units and/or the number of projects. On the other hand, for other issues (e.g., interference with migration, alteration of hydraulics/hydrologic regimes, noise and electromagnetic fields, blade strike, impingement), the cumulative impacts may vary with the number of units by a more complicated, potentially synergistic function. Phased monitoring would allow for the evaluation of the environmental effects of scaling up from a small number of units to large numbers of units in large projects. In addition to the information gaps identified in this section, Michel and Burkhard (2007) provide a summary of information needs (their Tables 1-8). Monitoring and research that could reduce the uncertainties about environmental effects of these new technologies are discussed in Section 4.

Most of the studies summarized in this section relate to the potential direct effects of hydrokinetic and ocean energy technologies. Gill (2005) described a number of indirect ecological effects that would result from extensive installation of offshore renewable energy developments. These possible impacts include changes in food availability, competition, predation, reproduction, and recruitment. The influence of energy developments on these ecological processes is largely speculative at this point, with possible changes being difficult to predict in some cases. Nonetheless, such indirect effects are real possibilities. More subtle environmental changes should also be considered as basic information on direct effects is developed from the early monitoring efforts. In addition to installation and operation, the effects of eventual decommissioning of these energy technologies will need to be considered as part of project licensing actions.

### **3.1 Alteration of Currents and Waves**

#### **3.1.1 Potential Near Field and Far Field Impacts of Hydrodynamic Alterations**

The extraction of kinetic energy from river and ocean currents or tides will reduce water velocities in the vicinity (i.e., near field) of the project (Bryden *et al.* 2004). Large numbers of devices in a river will reduce water velocities, increase water surface elevations, and decrease flood conveyance capacity. These effects would be proportional

to the number and size of structures installed in the water. Rotors, foils, mooring and electrical cables, and fixed structures will all act as impediments to water movement (Figure 3-2). The resulting reduction in water velocities could, in turn, affect the transport and deposition of sediment (Section 3.2), organisms living on or in the bottom sediments (Section 3.3), and plants and animals in the water column (Section 3.7). Conversely, moving rotors and foils might increase mixing in systems where salinity or temperature gradients are well defined. Changes in water velocity and turbulence will vary greatly, depending on distance from the structure. For small numbers of units, the changes are expected to dissipate quickly with distance and are expected to be only localized; however, for large arrays, the cumulative effects may extend to a greater area. The alterations of circulation/mixing patterns caused by large numbers of structures might cause changes in nutrient inputs and water quality, which could in turn lead to eutrophication, hypoxia, and effects on the aquatic food web.

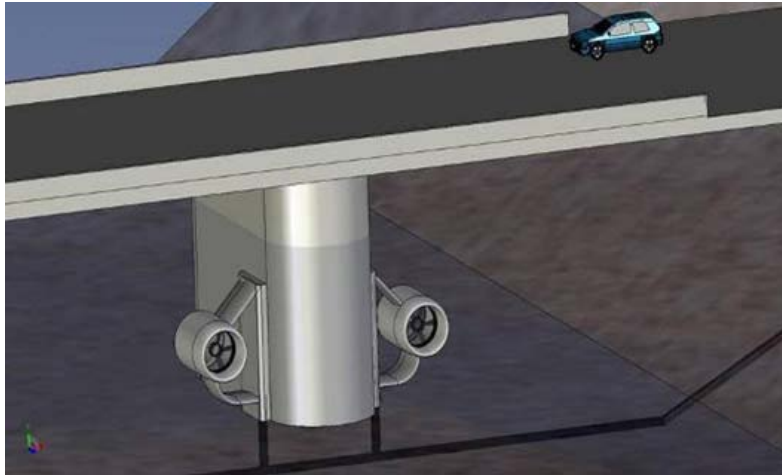

**Figure 3-2. Horizontal axis turbine generators can be deployed on existing infrastructure such as bridge abutments in large rivers (e.g., Lower and Middle Mississippi). Source: Free Flow Power Corporation, <http://free-flow-power.com>**

The presence of floating wave energy converters will alter wave heights and structures, both in the near field (within meters of the units or project) and, if installed in large numbers, potentially in the far field (extending meters to kilometers out from the project). The above-water structures of wave energy converters will act as a localized barrier to wind and, thus, reduce wind-wave interactions. Michel *et al.* (2007) noted that many of the changes would not directly relate to environmental impacts; for example, impacts on navigational conditions, wave loads on adjacent structures, and recreation on nearby beaches (e.g., surfing, swimming) might be expected. Reduced wave action could alter bottom erosion and sediment transport and deposition (Largier *et al.* 2008).

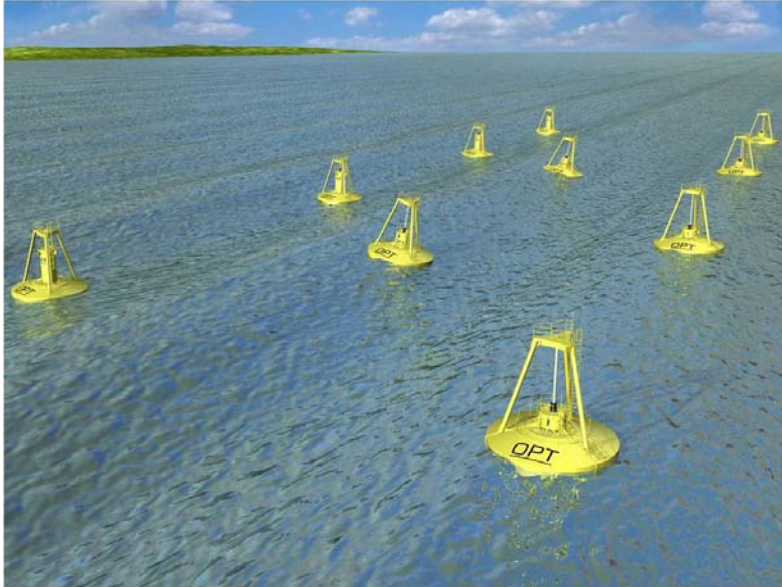

**Figure 3-3. Artist's depiction of an array of PowerBuoy point absorbers deployed to capture wave energy. Source: Ocean Power Technologies, Inc.**

Wave measurements at operating wave energy conversion projects have not yet been made, and the data will be technology and project-size specific. The potential reductions in wave heights are probably smaller than those for wind turbines due to the low profiles of wave energy devices (Figure 3-3). For example, ASR Ltd. (2007) predicted that operation of wave energy conversion devices at the proposed Wave Hub (a wave power research facility off the coast of Cornwall, UK; <http://www.wavehub.co.uk>) would reduce wave height at shorelines 5 to 20 kilometers (km) away by 3 to 6 percent. Operation of six wave energy conversion buoys (WEC; a version of OPT's PowerBuoys) in Hawaii was not predicted to impact oceanographic conditions (DON 2003). This conclusion was based on modeling analyses of wave height reduction due to both wave scattering and energy absorption. The proposed large spacing of buoy cylinders (51.5 m apart, compared to a buoy diameter of 4.5 m) resulted in predicted wave height reductions of 0.5 percent for a wave period of 9 seconds (s) and less than 0.3 percent for a wave period of 15 s. Boehlert *et al.* (2008) summarized the changes in wave heights that were predicted in various environmental assessments. Recognizing that impacts will be technology- and location-specific, estimated wave height reductions ranged from 3 to 15 percent, with maximum effects closest to the installation and near the shoreline. Millar *et al.* (2007) used a mathematical model to predict that operation of the Wave Hub, with WECs covering a 1 km by 3 km area located 20 km from shore, could decrease average wave heights by about 1 to 2 centimeters (cm) at the coastline. This represents an average decrease in wave height of 1 percent; a maximum decrease in the wave height of 3 percent was predicted to occur with a 90 percent energy transmitting wave farm (Smith *et al.* 2007). Other estimates in other environmental settings predict wave height reductions ranging from 3 to 13 percent (Nelson *et al.* 2008). Largier *et al.* (2008) concluded that height and incident angle are the most important wave parameters for determining the effects of reducing the energy supply to the coast.



The effects of reduced wave heights on coastal systems will vary from site to site. It is known that the richness and density of benthic organisms is related to such factors as relative tidal range and sediment grain size (e.g., Rodil and Lastra 2004), so changes in wave height can be expected to alter benthic sediments (Section 3.2) and habitat for benthic organisms (Section 3.3). Coral reefs reduce wave heights and dissipate wave and tidal energy, thereby creating valuable ecosystems (Roberts *et al.* 1992; Lugo-Fernandez *et al.* 1998). In other cases, wave height reductions can have long-term adverse effects. Estuary and lagoon inlets may be particularly sensitive to changes in wave heights. For example, construction of a storm-surge barrier across an estuary in the Netherlands permanently reduced both the tidal range and mean high water level by about 12 percent from original values, and numerous changes to the affected salt marshes and wetlands soils were observed (de Jong *et al.* 1994).

Tidal energy converters can also modify wave heights and structure by extracting energy from the underlying current. The effects of structural drag on currents were not expected to be significant (MMS 2007), but few measurements of the effects of tidal/current energy devices on water velocities have been reported. A few tidal velocity measurements were made near a single, 150-kilowatt (kW) Stingray demonstrator in Yell Sound in the Shetland Islands (The Engineering Business Ltd 2005). Acoustic Doppler Current Profilers were installed near the oscillating hydroplane (which travels up and down in the water column in response to lift and drag forces) as well as upstream and downstream of the device. Too few velocity measurements were taken for firm conclusions to be made, but the data suggest that 1.5 to 2.0 m/s tidal currents were slowed by about 0.5 m/s downstream from the Stingray. In practice, multiple units will be spaced far enough apart to prevent a drop in performance (turbine output) caused extraction of kinetic energy and localized water velocity reductions.

Modeling of the Wave Hub project in the United Kingdom suggested a local reduction in marine current velocities of up to 0.8 m/s, with a simultaneous increase in velocities of 0.6 m/s elsewhere (Michel *et al.* 2007). Wave energy converters are expected to affect water velocities less than submerged rotors and other, similar designs because only cables and anchors will interfere with the movements of tides and currents.

Tidal energy conversion devices will increase turbulence, which in turn will alter mixing properties, sediment transport and, potentially, wave properties. In both the near field and far field, extraction of kinetic energy from tides will decrease tidal amplitude, current velocities, and water exchange in proportion to the number of units installed, potentially altering the hydrologic, sediment transport, and ecological relationships of rivers, estuaries, and oceans. For example, Polagye *et al.* (2008) used an idealized estuary to model the effects of kinetic power extraction on estuary-scale fluid mechanics. The predicted effects of kinetic power extraction included (a) reduction of the volume of water exchanged through the estuary over the tidal cycle, (b) reduction of the tidal range landward of the turbine array, and (c) reduction of the kinetic power density in the tidal channel. These impacts were strongly dependent on the magnitude of kinetic power extraction, estuary geometry, tidal regime, and non-linear turbine dynamics.

Karsten *et al.* (2008) estimated that extracting the maximum of 7 gigawatts (GW) of power from the Minas Passage (Bay of Fundy) with in-stream tidal turbines could result in large changes in the tides of the Minas Basin (greater than 30 percent) and significant far-field changes (greater than 15 percent). Extracting 4 GW of power was predicted to cause less than a 10 percent change in tidal amplitudes, and 2.5 GW could be extracted with less than a 5 percent change. The model of Blanchfield *et al.* (2007) predicted that extracting the maximum value of 54 megawatts (MW) from the tidal current of Masset Sound (British Columbia) would decrease the water surface elevation within a bay and the maximum flow rate through the channel by approximately 40 percent. On the other hand, the tidal regime could be kept within 90 percent of the undisturbed regime by limiting extracted power to approximately 12 MW.

In the extreme far field (i.e., thousands of km), there is an unknown potential for dozens or hundreds of tidal energy extraction devices to alter major ocean currents such as the Gulf Stream (Michel *et al.* 2007). The significance of these potential impacts could be ascertained by predictive modeling and subsequent operational monitoring as projects are installed.

### **3.1.2 Mitigation Options to Address Hydrodynamic Alterations**

The extraction of kinetic energy from moving water is a necessary aspect of current/tidal energy converters, and effects on water velocities cannot be reduced without reducing the amount of electricity generated. Minimizing the environmental impacts of velocity changes is most easily accomplished by limiting the number of devices, by siting the projects away from marine protected areas (Figure 3-1) and sensitive seabed habitats, and by avoiding areas where primary production and managed fish species could be disrupted. Far field effects can be mitigated by selecting an environmentally appropriate scale of development for the particular aquatic system. With regard to non-generating structures (e.g., pilings, cables, submerged housing structures), water velocity effects could be reduced by streamlining component shapes, reducing the size and/or overall surface areas, burying electrical cables, and altering the spacing between individual machines. Similar design considerations could also minimize the water velocity effects of wave energy converters. Minimizing the changes in water velocities and wave heights to only those necessary for power production (e.g., by using variable pitch rotors and reducing drag on support structures) will also serve to minimize the consequent effects on bottom substrates, benthic habitats, and aquatic organisms.

## **3.2 *Alteration of Substrates and Sediment Transport and Deposition***

Operation of hydrokinetic or ocean energy technologies will extract energy from the water, which will reduce the height of waves or the velocity of currents in the local area. This loss of wave/current energy could, in turn, alter sediment transport and the wave climate of nearby shorelines.

### 3.2.1 Potential Near Field and Far Field Impacts of the Alteration of Sediment Transport



**Figure 3-4. The ORECon Multi Resonant Chambers (MRC) device deploys multiple OWCs around a 40-meter platform tethered to the sea floor offshore.**  
Source: ORECon

Installation of many of the hydrokinetic and ocean energy technologies will entail attaching the devices to the bottom by means of pilings or anchors and cables (Figure 3-4). Transmission of electricity to the shore will be through cables that are either buried in or attached to the seabed. Thus, project installation will temporarily disturb sediments, the significance of which will be proportional to the amount and type of bottom substrate disturbed. There have been few studies of the effects of burying cables from ocean energy technologies, but experience with other buried cables and trawl fishing indicate the possible severity of the impacts. For example, Kogan *et al.* (2006) surveyed the condition of an armored, 6.6-cm-diameter coaxial cable that was laid on the surface of the seafloor off Half Moon Bay, California. The cable was not anchored to the seabed. Whereas the impacts of laying the cable on the surface of the seabed were probably small, subsequent movements of the cable had continuing impacts on the bottom substrates. For example, cable strumming by wave action in shallower, nearshore areas created incisions in rocky siltstone outcrops ranging from superficial scrapes to vertical grooves, and had minor effects on the habitats of aquatic organisms (Section 3.3.2). At greater depths, there was little evidence of effects of the cable on the seafloor, regardless of exposure. Limited self-burial of the unanchored cable occurred over an 8-year period, particularly in deeper waters of the continental shelf.

During operation, changes in current velocities or wave heights (Section 3.1) will alter sediment transport, erosion, and sedimentation. Due to the complexity of currents and their interaction with structures, operation of the projects will likely increase scour and deposition of fine sediments on both localized and far field scales. For example, turbulent vortices that are shed immediately downstream from a velocity-reducing structure (e.g., rotors, pilings, concrete anchor blocks) will cause scour, and this sediment is likely to be deposited further downstream. On average, extraction of kinetic energy from currents and waves is likely to increase sediment deposition in the shadow of the project (Michel *et al.* 2007), the depth and areal extent of which will depend on local topography, sediment types, and characteristics of the current and the project. Subsequent deposition of sediments is likely to cause shoaling and a shift to a finer sediment grain size on the lee side of wave energy arrays (Boehlert *et al.* 2008). Scour and deposition should be considered in project development, but many of the high energy (high velocity) river and nearshore marine sites that could be utilized for electrical energy production are likely to have substrates with few or no fine sediments. Indeed, a possible

benefit of ocean energy projects may be to reduce undesirable coastal erosion in high-energy environments. Changes in scour and deposition will in turn alter the habitats for bottom-dwelling plants and animals (Section 3.3).

Loss of wave energy may lead to changes in longshore currents, reductions in the width and energy of the surf zone, and changes in beach sand erosion and deposition patterns. Millar *et al.* (2007) modeled the wave climate near the Wave Hub electrical grid connection point off the north coast of Cornwall. The installation would be located 20 km off the coast, in water depths of 50 to 60 m. Arrays of WECs connected to the Wave Hub would occupy a 1 km x 3 km site. The mathematical model predicted that an array of WECs would potentially affect the wave climate on the nearby coast, on the order of 1 to 2 cm. It is unknown whether such small reductions in the average wave height would measurably alter sediment dynamics along the shore, given the normal variations in waves due to wind and storms.

Water quality will be temporarily affected by increased suspended sediments (turbidity) during installation and initial operation. Suspension of anoxic sediments may result in a temporary and localized decline in the dissolved oxygen content of the water, but dilution by oxygenated water currents would minimize the impacts. Water quality may also be compromised by the mobilization of buried contaminated sediments during both construction and operation of the projects. Excavation to install the turbines, anchoring structures, and cables could release contaminants adsorbed to sediments, posing a threat to water quality and aquatic organisms. Effects on aquatic biota may range from temporary degradation of water quality (e.g., a decline in dissolved oxygen content) to biotoxicity and bioaccumulation of previously buried contaminants such as metals.

### **3.2.2 Mitigation Options to Address the Alteration of Sediment Transport**

Some alteration of sediment transport, erosion, and deposition is a necessary consequence of the extraction of energy from currents and waves. As with hydraulic changes, the effects on sediments of non-generating elements (e.g., pilings, cables, submerged housing structures) could be reduced by streamlining component shapes, reducing the size and/or overall surface areas, and altering the spacing between individual machines. Some designs are based on floating platforms that support the generating structures higher in the water column and eliminate the need for pilings and other structures fixed to the bottom.

Near field effects on substrates and sediment transport could be minimized by proper siting and orientation of the project to avoid locations with a particular sensitivity to altered sediment dynamics. Far field effects could best be mitigated by sizing the project appropriately for the size and hydrodynamics of the area.

Regarding the mobilization of buried contaminants, pre-construction surveys of the area subject to excavation during construction and scouring during operation could minimize the risk of water quality degradation and toxicity to aquatic organisms. If contaminants are found, measures to avoid the areas or to isolate and safely contain the contaminants

should be investigated. Periodic operational monitoring will help determine whether further minimization or mitigation options are needed.

### **3.3 Impacts of Habitat Alterations on Benthic Organisms**

Installation and operation of hydrokinetic and marine energy projects can directly displace benthic (i.e., bottom-dwelling) plants and animals or change their habitats by altering water flows, wave structures, or substrate composition (Figure 3-5). Many of the designs will include a large anchoring system made of concrete or metal, mooring cables, and electrical cables that lead from the offshore facility to the shoreline. Electrical cables might simply be laid on the bottom, or they more likely will be anchored or buried to prevent movement. Large bottom structures will alter water flow, which may result in localized scour and/or deposition. Because these new structures will affect bottom habitats, consequential changes to the benthic community composition and species interactions in the area defined by the project may be expected (Lohse *et al.* 2008).

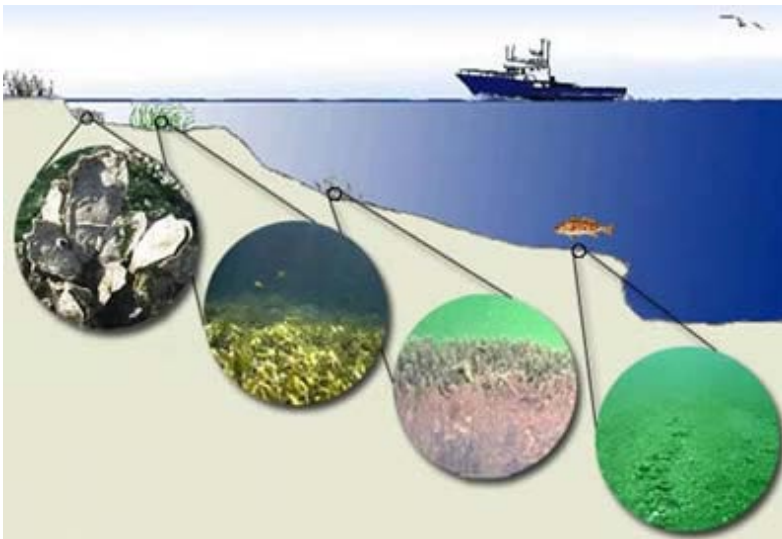

Figure 3-5. Examples of different benthic habitats: (left to right) oyster bed, seagrass meadow, amphipod tube mat, sandflat. Source: NOAA Coastal Services Center, <http://www.csc.noaa.gov/benthic/start/what.htm>

#### **3.3.1 Displacement of Benthic Organisms by Installation of the Project**

Bottom disturbances will result from the temporary anchoring of construction vessels; digging and refilling the trenches for power cables; and installation of permanent anchors, pilings, or other mooring devices. Motile organisms will be displaced and sessile organisms destroyed in the limited areas affected by these activities. Displaced organisms may be able to relocate if similar habitats exist nearby and those habitats are not already at carrying capacity. Species with benthic-associated spawning or whose offspring settle into and inhabit benthic habitats are likely to be most vulnerable to disruption during project installation. Temporary increases in suspended sediments and sedimentation down current from the construction area can be expected. The potential effects of suspended sediments and sedimentation on aquatic organisms are periodically reviewed (e.g., Newcombe and Jensen 1996; Wood and Armitage 1997; Wilber and

Clarke 2001; Wilber *et al.* 2005). When construction is completed, disturbed areas are likely to be recolonized by these same organisms, assuming that the substrate and habitats are restored to a similar state. For example, Lewis *et al.* (2003) found that numbers of clams and burrowing polychaetes fully recovered within one year after construction of an estuarine pipeline, although fewer wading birds returned to forage on these invertebrates during the same time period.

### 3.3.2 Alteration of Habitats for Benthic Organisms during Operation

Installation of the project will alter benthic habitats over the longer term if the trenches containing electrical cables are backfilled with sediments of different size or composition than the previous substrate. Permanent structures on the bottom (ranging in size from anchoring systems to seabed-mounted generators or turbine rotors) will supplant the existing habitats. These new structures

would replace natural hard substrates or, in the case of previously sandy areas, add to the amount of hard bottom habitat available to benthic algae, invertebrates, and fish. This could attract a community of rocky reef fish and invertebrate species (including biofouling organisms) that would not normally exist at that site. Depending on the situation, the newly created habitat could increase biodiversity or have negative effects by enabling introduced (exotic) benthic species to spread. Marine fouling communities developed on monopiles for offshore wind power plants are significantly different from the benthic communities on adjacent hard substrates (Wilhelmsson *et al.* 2006; Wilhelmsson and Malm 2008; Figure 3-6).



**Figure 3-6. Mollusks comprise the largest portion of biomass on many offshore platforms.** Source: MMS, [http://www.gomr.mms.gov/homepg/regulate/enviro/studies/turning\\_to\\_the\\_sea](http://www.gomr.mms.gov/homepg/regulate/enviro/studies/turning_to_the_sea).

Changes in water velocities (Section 3.1) and sediment transport, erosion, and deposition (Section 3.2) caused by the presence of new structures will alter benthic habitats, at least on a local scale. This impact may be more extensive and long-lasting than the effects of anchor and cable installation. Deposition of sand may impact seagrass beds by increasing mortality and decreasing the growth rate of plant shoots (Craig *et al.* 2008; Figure 3-7). Conversely, deposition of organic matter in the wakes of marine energy devices could encourage the growth of benthic invertebrate communities that are adapted to that substrate. Mussel shell mounds that slough off from oil and gas platforms may create surrounding artificial reefs that attract a large variety of invertebrates (e.g., crabs, sea stars, sea cucumbers, anemones) and fish (Love *et al.* 1999). Accumulation of shells and organic matter in the area would depend on the wave and current energy, activities of biota, and numerous other factors (Widdows and Brinsley 2002). While the new habitats created by energy conversion structures may enhance the abundance and diversity of



invertebrates, predation by fish attracted to artificial structures (Section 3.7) can greatly reduce the numbers of benthic organisms (Davis *et al.* 1982; Langlois *et al.* 2005).



**Figure 3-7. Johnson's seagrass is a threatened species with a disjunct and patchy distribution along the east coast of Florida. Its continued existence and recovery may be limited due to habitat alteration by a number of human and natural perturbations, including dredging and degraded water quality. Source: Lynn Lefebvre, NOAA, <http://www.nmfs.noaa.gov/pr/species/plants/johnsonsseagrass.htm>**

Movements of mooring or electrical transmission cables along the bottom (sweeping) could be a continual source of habitat disruption during operation of the project (Section 3.2.1). For example, Kogan *et al.* (2006) found that shallow water wave action shifted a 6.6-cm-diameter, armored coaxial cable that was laid on the surface of the seafloor. The strumming action caused incisions in rocky outcrops, but effects on seafloor organisms were minor. Anemones colonized the cable itself, preferring the hard structure over the nearby sediment-dominated seafloor. Some flatfishes were more abundant near the cable than at control sites, probably because the cable created a more structurally heterogeneous habitat. Sensitive habitats that may be particularly vulnerable to the effects of cable movements include macroalgae and seagrass beds, coral habitats, and other biogenic habitats like worm reefs and mussel mounds.

Renewable energy projects may also have benefits to some aquatic habitats and populations. The presence of a marine energy conversion project will likely limit most fishing activities and other access in the immediate area. Bottom trawling can disrupt habitats, and benthic communities in areas that are heavily fished tend to be less complex and productive than in areas that are not fished in that way (Kaiser *et al.* 2000; Jennings *et al.* 2001). Blyth *et al.* (2004) found that cessation of towed-gear fishing resulted in significantly greater total species richness and biomass of benthic communities compared to sites that were still fished. The value of these areas in which fishing is precluded (or, at least limited to certain gear types) by the energy project would depend on the species of fish and their mobility. For relatively sedentary animals, reserves less than 1 km<sup>2</sup> across have augmented local fisheries, and reserves in Florida of 16 km<sup>2</sup> and 24 km<sup>2</sup> have

sustained more abundant and sizable fish than nearby exploited areas (Gell and Roberts 2003). On the other hand, the protection of long-lived, late-maturing, or migratory marine fish species may require much larger marine protected areas (greater than 500 km<sup>2</sup>) than those envisioned for most energy developments (Kaiser 2005; Blyth-Skyrme et al. 2006; Nelson et al. 2008).

### **3.3.3 Mitigation Options to Address Habitat Alterations for Benthic Organisms**

The direct effects on habitat resulting from the installation of project structures can be readily estimated based on (1) the surface area disturbed and (2) the densities and composition of the benthic community in that area. Operational effects are more difficult to predict; effects of a facility on velocities and sediment dynamics are highly variable and site-specific, and predicted effects would need to be verified by monitoring.

The most certain ways to minimize impacts on benthic habitats are (1) to site projects in non-sensitive areas and (2) to limit the number of generating devices. Projects placed further offshore are less likely to impact nearshore currents and communities and more likely to cause disturbance to sandy substrates. When compared to rocky areas, coral reefs, or kelp beds, sandy substrates are easier to restore after construction disturbance and may already support lower benthic diversity and productivity. Habitat areas that are particularly sensitive to disruption (such as coral reefs, cold-water soft corals, seagrass beds, worm reefs, and sponge communities) could be avoided when permanent structures and submarine cables are installed. Project installation could be timed to avoid seasons when benthic spawning species are most vulnerable. Divers can be used to direct the placement of cables (Michel et al. 2007), and the use of a narrow slit trench to bury cables could minimize disruption of sediments during project installation. Where it is not practical to route a trench line around sensitive areas, horizontal directional drilling/boring (HDD/HDB) techniques can be options, taking into consideration appropriate substrates, oceanographic conditions, and desired drilling distances. Anchoring systems that use concrete anchors and heavy chains can be designed to reduce the detrimental effects of chain sweep (AquaEnergy, Ltd. 2006).

Michel et al. (2007) list several possible mitigation options based on the assessments they reviewed:

- Route the cable to avoid sensitive substrates such as live coral, seagrass beds, and productive rocky habitats
- Use HDD/HDB methods for cable routing through sensitive habitats
- Use dynamic positioning in sensitive areas to reduce the need for anchors
- Use “soft startup” of pile driving so that increasing noise levels encourage mobile benthic species to move away from the source of disturbance (Section 3.4.2)
- Design the mooring systems to minimize the anchor size, footprint on the seafloor, and the chain/cable sweep of the seafloor



### 3.4 Impacts of Noise

Freshwater and marine animals rely on sound for many aspects of their lives including reproduction, feeding, predator and hazard avoidance, communication, and navigation (Popper 2003; Weilgart 2007). Consequently, underwater noise generated during installation and operation of a hydrokinetic or ocean energy conversion device has the potential to impact these organisms. Noise may interfere with sounds animals make to communicate, or may drive animals from the area. If severe enough, loud sounds could damage their hearing or cause mortalities. For example, it is known from experience with other marine construction activities that the noise created by pile driving creates sound pressure levels high enough to impact the hearing of harbor porpoises (Figure 3-8)



**Figure 3-8. Harbor porpoises, like all marine mammals, are protected under the Marine Mammal Protection Act. Source: NOAA, [http://www.afsc.noaa.gov/nmml/species/species\\_harporp.php](http://www.afsc.noaa.gov/nmml/species/species_harporp.php)**

and harbor seals (Thomsen *et al.* 2006). The effects are less certain for fish (Hasting and Popper 2005), although fish mortalities have been reported for some pile-driving activities (Longmuir and Lively 2001; Caltrans 2001). Noise generated during normal operations is expected to be less powerful, but could still disrupt the behavior of marine mammals, sea turtles, and fish at great distances from the source. Changes in animal behavior or physiological stresses could lead to decreased foraging efficiency, abandonment of nearby habitats, decreased reproduction, and increased mortality (NRC 2005) – all of which could have adverse effects on both individuals and populations.

Construction and operation noise may disturb seabirds using the offshore and intertidal environment. Shorebirds will be disturbed by onshore construction and operations, causing them to abandon breeding colonies (Thompson *et al.* 2008). Pinnipeds may abandon onshore sites used for reproduction (rookeries) because of noise and other disturbing activities during installation. On the other hand, some marine mammals and birds may be attracted to the area by underwater sounds, lights, or increased prey availability (Section 3.7).

There are many sources of sound/noise in the aquatic environment (NRC 2003; Simmonds *et al.* 2003). Natural sources include wind, waves, earthquakes, precipitation, cracking ice, and mammal and fish vocalizations. Human-generated ocean noise comes from such diverse sources as recreational, military, and commercial ship traffic; dredging; construction; oil drilling and production; geophysical surveys; sonar; explosions; and ocean research (Johnson *et al.* 2008). Many of these sounds will be present in an area of new energy developments. Noises generated by marine and hydrokinetic energy technologies should be considered in the context of these background sounds. The additional noises from these energy technologies could result from installation and maintenance of the units, movements of internal machinery, waves striking the buoys, water flow moving over mooring and transmission cables,

synchronous and additive non-synchronous sound from multiple unit arrays, and environmental monitoring using hydroacoustic techniques.

### **3.4.1 Noise in the Aquatic Environment and Its Effects on Animals**

Appendix C provides a description of noise in the aquatic environment, a review of sound levels produced by ocean energy technologies, and their possible effects on aquatic organisms. There is very little information on the sound levels produced by construction and operation of ocean energy conversion devices. If project installation involves pile driving, nearby noise levels are likely to exceed threshold values for the protection of fish and marine mammals. Operational noise from a small number of units may not exceed threshold levels, but the cumulative noise production from large numbers of units has the potential to mask the communication and echolocation sounds produced by aquatic organisms in the vicinity of the project.

### **3.4.2 Mitigation Options to Address Noise**

Johnson *et al.* (2008) list a number of measures that can be employed to reduce the effects of noise on aquatic animals, some of which could be applied to these technologies. The minimization or mitigation of noise from a hydrokinetic or marine energy conversion array could be achieved in a variety of ways:

- Use of sound insulation within and around the device
- Employment of bubble screens and other noise barriers during installation
- Operation of acoustic mitigation devices (AMD) to exclude animals from the area
- Location of the project away from sensitive environments
- Limiting the number of devices and size of the projects
- Limiting the noisiest activities to least sensitive times

#### ***Use of Sound Insulation Within and Around the Device***

Equipment design will be an important element of any strategy to reduce the source levels of noise. For example, sound insulation might be employed to minimize the noises associated with movements of internal machinery. Technologies that are based on floating platforms will likely create less noise during installation, and operational (generator) noise will not be transmitted to the bottom by pilings. Noise and pressure changes associated with cavitation of rotor blades could be reduced by optimization of blade shape (Bahaj *et al.* 2007).

Cable strumming occurs when water currents pass over mooring and electrical cables and cause them to vibrate, producing sounds; the characteristics of these sounds could change over the life of the project due to marine fouling. The strumming of thicker cables produces a lower-frequency sound than thinner cables, and looser cables strum at lower levels than tighter cables (but the reduction in noise from a slack cable might be accompanied by an increase in the potential for entanglement of marine mammals and turtles). Anti-strum devices (sheathing or fairing) might be used to reduce the noise levels.

The production of synchronous sounds or additive asynchronous sounds from multiple unit arrays could be minimized by proper layout of the array. Modeling of the sound produced by a single unit and small number of units in an array might be used to establish the appropriate spacing of large numbers of units in an energy development (Boehlert *et al.* 2008).

### ***Employment of Bubble Screens and Other Noise Barriers During Installation***

Bubble screens or curtains can reduce underwater noise levels by reflecting and absorbing the sound waves (Figure 3-9). For example, Wursig *et al.* (2000) used a perforated hose to produce a bubble curtain around pile-driving activities in shallow water. The bubble curtain reduced broadband pulse levels by 3 to 5 dB, especially in the frequency range of 400 to 6400 Hz. Nearby dolphins increased their speeds of travel during pile driving, suggesting that the bubble curtain did not eliminate all responses to the noise. Effective bubble screens have been employed in British Columbia (Longmuir and Lively 2001) and California (Caltrans 2001).

Nehls *et al.* (2008) reviewed the costs and possible effectiveness of structural measures to mitigate underwater noise from offshore pile driving, and concluded that bubble curtains would not be feasible at the great water depths and tidal currents where windfarms would be located. Nor was the modification of the piling hammer to prolong the impact time and lower the noise level a viable option. They recommended investigation into the placement of noise barriers around piles in the form of either an inflatable sleeve or a



**Figure 3-9. Air bubble curtain in operation.**  
Source: Caltrans (2001)

telescoping, foam-filled, double-walled steel tube. The expected pile-driving noise attenuation that could be achieved by these devices is 20 and 15 dB broadband, respectively. A fabric barrier system with aerating mechanism effectively reduced the impulse sound pressure from pile driving in San Francisco Bay (Caltrans 2001). With no sound attenuation, sound levels of 190 dB re 1  $\mu$ Pa (root mean square [rms]) could be detected over 200 m from the source. Operation of the fabric barrier system reduced the distance to the 190 dB threshold to less than 100 m.

### ***Operation of AMDs to Exclude Animals from the Area***

Acoustic mitigation devices (AMDs) produce aversive sounds in order to drive animals away from aquaculture facilities and commercial trawling nets. Although constituting another source of noise in the aquatic environment, AMDs might be useful for safely excluding marine mammals, fish, and marine turtles from an ocean energy installation. Gordon *et al.* (2007) provided a review of the characteristics and effectiveness of AMDs for use as marine mammal deterrents. Acoustic deterrent systems (ADS) have been used to repel fish from power plant intakes (Maes *et al.* 2004). In a laboratory experiment,

Pacific herring failed to react to an AMD used to reduce bycatch of cetaceans in fishing nets, but responded to ultrasonic frequencies that simulated echolocation sounds by odontocetes (Wilson and Dill 2002). An effective AMD would broadcast a signal that was sufficiently frightening or aversive to cause animals to move away from the installation without injury. Variations of this concept, such as acoustic deterrent devices (ADD, pingers), seal scarers, and acoustic harassment devices (AHD) (Figure 3-10) are discussed by Nowacek *et al.* (2007).



**Figure 3-10. Electronic acoustic harassment devices that are used to deter animals (e.g., Pacific harbor seals, California seal lions) from damaging property might also be useful for safely excluding marine mammals, fish, and marine turtles from an ocean energy installation. Source: NOAA**

### ***Location of the Project Away from Sensitive Environments***

Simmonds, *et al.* (2003) noted that there are few data on the effectiveness of any noise mitigation options, in part due to complications associated with the non-uniform way in which sound travels through water, different sensitivities of different aquatic species, different sensitivities among individual members in a group, and the differing sound types and intensities depending on the activities being undertaken. Weilgart (2007) concluded that many noise mitigation tools are of questionable effectiveness and suggested that reducing noise levels and distancing the noise from biologically important areas would offer the most protection.

Minimization and mitigation options can be applied in combination to reduce the effects of underwater noise. Under the Marine Mammal Protection Act, NOAA is considering the monitoring and mitigation needed to limit the effects of open water pile driving associated with construction of the San Francisco-Oakland Bay Bridge (73 FR 129:38180-38183; July 3, 2008). These measures include establishment and monitoring of safety/buffer zones where the underwater sound pressure levels (SPL) are anticipated to equal or exceed 190 dB re 1  $\mu$ Pa rms (impulse) for pinnipeds and 180 dB re 1  $\mu$ Pa rms (impulse) for gray whales and harbor porpoises. The pile driving hammer would be “soft started” (ramped up) prior to operating at full capacity, where the initial hammer strikes would be limited to 40 to 60 percent energy levels with no less than a 1-minute interval between strikes in order to allow marine mammals to move from the area. All construction equipment will comply with applicable equipment noise standards of the U.S. Environmental Protection Agency (EPA). In addition to these measures, proposed monitoring would include: (1) visual observations beginning at least 30 minutes prior to startup of pile driving and continuing at least 30 minutes after ending; and (2) measurements of underwater noise levels near the piles and at reference locations 100 m and 500 m from the construction activities.

### ***Limiting the Noisiest Activities to Least Sensitive Times***

Due to the limitations of visual monitoring of an area for marine mammals, especially at night or under conditions of poor visibility, ADS are being developed to improve the detection of animals that might be affected by underwater noise (Parvin *et al.* 2007). Three approaches used by ADS are: (1) Passive Acoustic Monitoring (PAM) (Figure 3-11), in which a sonar-type system monitors for the animals' vocalizations or echolocation signals; (2) active acoustic monitoring (AAM), in which a sonar "ping" is broadcast into the water in search of targets; and (3) acoustic daylight monitoring (ADM; also called acoustic daylight imaging), which detects existing background noise scattered from a target.

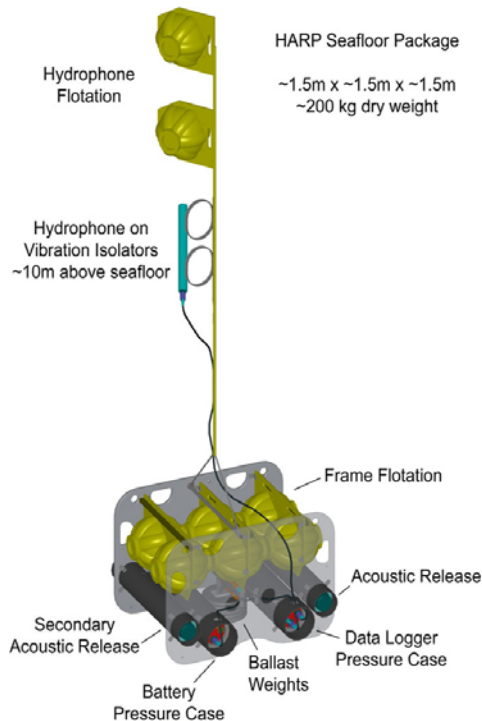

**Figure 3-11. Diagram of High Frequency Acoustic Recording Package (a type of passive acoustic monitoring system or PAM) designed and built by the Whale Acoustics Lab at Scripps Institute of Oceanography. Source: NOAA, <http://www.pifsc.noaa.gov/psd/mmrp/cetaceans.php>**

Parvin *et al.* (2007) concluded that a well-designed PAM system could detect large whales and odontocetes at sufficient range that a noise-producing activity could be suspended until the animal has moved away, but this strategy might not suffice for the smaller detection ranges of smaller animals. For example, a PAM system called the T-POD has been used to detect porpoises in the vicinity of offshore wind farms (Tougaard *et al.* 2005; Carstensen *et al.* 2006). The T-POD is a small, self-contained data logger that records echolocation clicks from cetaceans; it is programmable and thus can be set to detect the particular frequencies that indicate the presence of particular species. The T-POD can provide data on cetacean echolocations with high temporal resolution but low spatial resolution; for example, this device was able to demonstrate a decline in harbor porpoise activity during construction of an offshore wind farm. Similarly, Koschinski *et al.* (2003) used a T-POD to detect a change in echolocation activity among harbour seals and harbour porpoises in response to simulated wind turbine operational noise. The

sounds produced by ADS monitoring would constitute yet another source of noise in the aquatic environment which would need to be quantified and minimized.

### 3.5 Impacts of Electromagnetic Fields (EMF)

Underwater cables will be used to transmit electricity between turbines in an array (inter-turbine cables), between the array and a submerged step-up transformer (if part of the design), and from the transformer or array to the shore (CMACS 2003). Ohman *et al.* (2007) categorize submarine electric cables into the following types: telecommunications cables; high voltage, direct current (HVDC) cables; alternating current three-phase power cables, and low-voltage cables. All types of cable will emit EMF in the surrounding water. The electric current traveling through the cables will induce magnetic fields in the immediate vicinity, which can in turn induce a secondary electrical field when animals move through the magnetic fields (CMACS 2003).

#### 3.5.1 Effects of Electromagnetic Fields on Aquatic Organisms

Appendix D provides a description of EMF in the aquatic environment, a review of EMF that may be produced by ocean energy technologies, and possible EMF effects on aquatic organisms. The EMF associated with new marine and hydrokinetic energy designs have not been quantified. The EMF created by electric current passing through a cable is composed of both an electric field (E field) and an induced magnetic field (B field). Although E fields can be contained within undamaged insulation surrounding the cable, B fields cannot be contained and will induce a secondary electric field (iE field). Thus, it is important to distinguish between the two constituents of the EMF (E and B) and the induced field, iE (Figure 3-12).

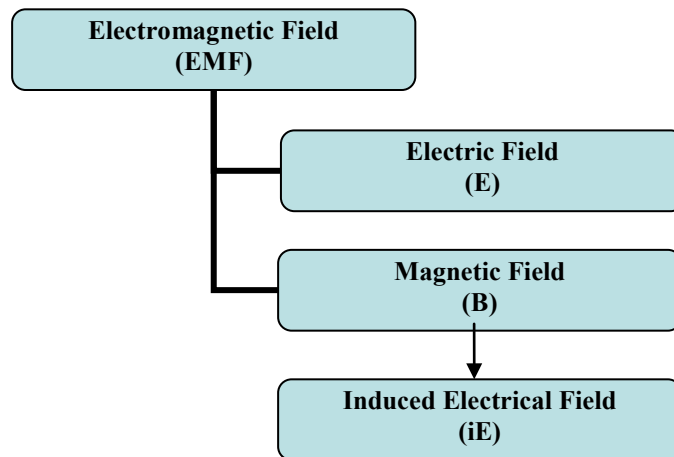

Figure 3-12. Simplified view of the fields associated with submarine power cables. Modified from Gill *et al.* (2005).



The EMF associated with new marine and hydrokinetic energy designs have not been quantified. The current state of knowledge about the EMF emitted by submarine power cables is too variable and inconclusive to make an informed assessment of the effects on aquatic organisms (CMACS 2003). Following a thorough review of the literature related to EMF and extensive contacts with the electrical cable and offshore wind industries, Gill *et al.* (2005) concluded that there are significant gaps in knowledge regarding sources and effects of EMF in the marine environment. They recommended developing information about likely electrical and magnetic field strengths associated with the generating units, offshore substations and transformers, and submarine cables that are a part of offshore renewable energy projects. They cautioned that networks of cables in close proximity to each other, as would be found in large current and tidal energy projects where cables come together at substations, are likely to have overlapping, and potentially additive, EMF fields. These combined EMF fields would be more difficult to evaluate than those emitted from a single electrical cable (Figure 3-13). The small, time-varying B field emitted by a submarine three-phase, alternating current (AC) cable may be perceived differently by sensitive marine organisms than the persistent, static, geomagnetic field generated by the Earth (CMACS 2003).

### 3.5.2 Mitigation Options for Effects of Electromagnetic Fields

As with many other issues, selecting the proper location for the power project is likely to be the most reliable and cost-effective way to minimize the potential effects of EMF. Avoidance of critical migratory paths and ensuring that the electrical transmission cables do not create a physical or electromagnetic barrier to animal movements may obviate the need for additional shielding or cable repairs.

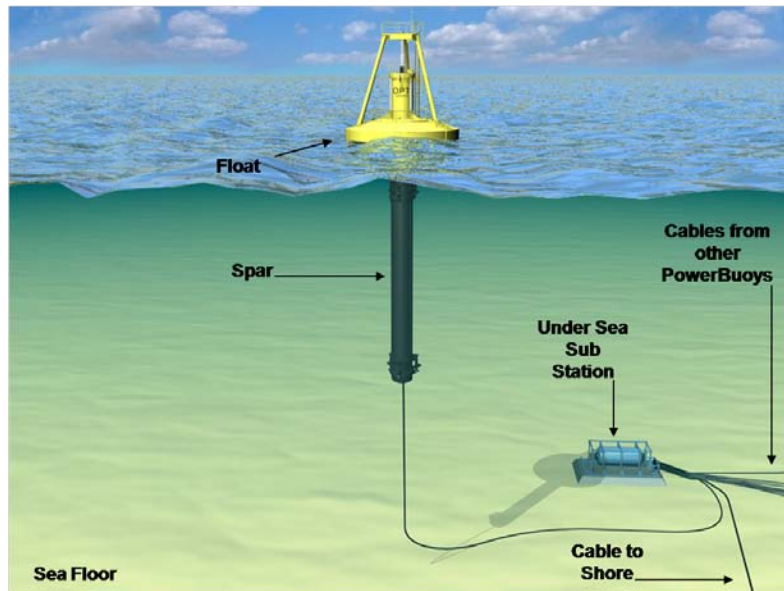

Figure 3-13. A network of generating devices may have a matrix of electrical cables in the water along the bottom. Source: Ocean Power Technologies, Inc.

Damage to the electrical transmission cable could cause an electrical fault or short, during which electrical current would leak to the water. The cable that would be used for the proposed Wave Energy Technology (WET) project in Hawaii (a 1-MW PowerBuoy from Ocean Power Technologies) would be armored with steel wires and an external jacket to prevent damage (DON 2003). In the event of current leakage from a damaged cable, the WET system includes a computer-controlled electrical fault detection and interruption system which would shunt the electric current to load resistors within 6 to 20 ms. Studies suggest that electrical fault currents of less than 5 millivolts (mV) and durations less than 20 ms had only minor, transient effects on marine life and nearby divers (DON 2003).

Industry-standard AC cables effectively shield against direct electric field emissions, but cannot completely shield the magnetic field (Gill 2005). The Centre for Marine and Coastal Studies (2003) modeled the strength of the EMF under different conditions of permeability and conductivity of the cable sheath and armor. As either the permeability or the conductivity of the armor increased, the strength of the resultant EMF decreased. The model suggested that using materials with very high permeability and conductivity values to armor submarine power cables could reduce the EMF generated to below the lowest known level that elasmobranchs can detect. Cable burial was predicted to be ineffective in dampening the magnetic B field. However, because the B field is strongest at the surface of the cable and declines rapidly with distance, burying the cable in sediment may be sufficient to minimize effects on sensitive fish (CMACS 2003).

### ***3.6 Toxic Effects of Chemicals***

Chemicals that are accidentally or chronically released from hydrokinetic and ocean energy installations could have toxic effects on aquatic organisms. Accidental releases include leaks of hydraulic fluids from a damaged unit or fuel from a vessel due to a collision with the unit; such events are unlikely but could potentially have a high impact (Boehlert *et al.* 2008). On the other hand, chronic releases of dissolved metals or organic compounds used to control biofouling in marine applications would result in low, predictable concentrations of contaminants over time. Even at low concentrations that are not directly lethal, some contaminants can cause sublethal effects on sensory systems, growth, and behavior of animals; they may also be bioaccumulated.

#### **3.6.1 Toxicity of Paints, Anti-Fouling Coatings, and Other Chemicals**

Biofouling (growth on external surfaces by algae, barnacles, mussels, and other marine organisms) will occur rapidly in ocean applications (Langhamer, undated; Wilhelmsson and Malm 2008). Sundberg and Langhamer (2005) observed that a 3-m-diameter buoy may accumulate as much as 300 kg of biomass on the buoy and mooring cables, whereas siting devices in deeper water with even slight currents will exhibit reduced biofouling. The encrustation of biofouling organisms could cause undesirable mechanical wear or changes in the weight, shape, and performance of energy conversion devices that would require increased maintenance or the application of antifouling measures (Figure 3-14). Encrustation by barnacles and other organisms could increase corrosion and fatigue and decrease electrical generating efficiency.





**Figure 3-14. Growth of biofouling organisms on a floating spherical buoy after 521 days at sea. Source: NOAA, [http://www.aoml.noaa.gov/phod/dac/gdp\\_drifter.html](http://www.aoml.noaa.gov/phod/dac/gdp_drifter.html)**

Michel *et al.* (2007) noted that there are three options for removing marine biofouling: (1) use of antifouling coatings, (2) *in situ* cleaning using a high pressure jet spray, and (3) removal of the device from the water for cleaning on a floating platform or onshore. Antifouling coatings hinder the development of marine encrustations by slowly releasing a biocide such as tributyltin (TBT), copper, or arsenic. As the coatings wear away, they must be reapplied periodically. There are concerns about the immediate toxicity of these biocides to other, non-targeted organisms, and numerous countries and organizations have called for the ban of TBT as an anti-fouling coating (Antizar-Ladislao 2008). As a result, alternative coatings are being explored. The release of toxic contaminants from a single unit may be relatively minor, but the cumulative impacts of persistent toxic compounds from dozens or hundreds of units may be considerable (Boehlert *et al.* 2008). Accumulations of biofouling organisms (e.g., barnacles) removed from the project structures may alter nearby bottom substrates and habitats (Section 3.3.2)

Accidental releases of hydraulic fluids and lubricating oils from inside the energy conversion device or from vessels used to install and service the equipment could have toxic effects. At the least, leaks of inert (non-toxic) oils could cause physical/mechanical effects by coating organisms and blanketing the sediments.

### **3.6.2 Mitigation Options to Address Chemical Toxicity**

Impacts of chemicals could be reduced by the use of inert (non-toxic) paints and lubricating oils. Due to concerns about the toxicity of TBT and copper-containing paints, there has been considerable research into alternative, environmentally friendly antifouling coatings in the marine environment (Yebra *et al.* 2004; Genzer and Efimenko 2006; Webster *et al.* 2007). Yebra *et al.* (2004) reviewed the history of anti-fouling paint development and described promising new alternatives to TBT biocides. They concluded that although biocide-based antifouling coatings will continue to dominate the market in coming years, there is potential in the development of paints with natural biocides or non-biocidal foul-release coatings (FRC) that prevent the adhesion of fouling organisms by providing a low-friction, ultra-smooth surface. FRCs do not prevent fouling, but their surface properties reduce the adhesion of organisms so that they can be easily removed with a brush or water jet. Many of the FRCs are based on silicone oils that are not bound into the resin matrix and thus may leach into the marine environment. Nendza (2007) concluded that the silicone oils in FRCs are very persistent in the environment, but they do not bioaccumulate in marine organisms and the soluble fractions of the oils have low toxicity. Like any inert oil, at high concentrations silicone oil films or droplets could coat small organisms and cause suffocation. Minimizing the non-toxic coatings may require more mechanical removal of biofouling, which requires more vessel servicing trips that disturb the area and increase the potential for collisions or spills.

Information about the processes that determine the biological activity of anti-fouling paints is being incorporated into mathematical models (Yebera 2006) or screening assays (Watermann *et al.* 2005; Webster *et al.* 2007) that predict performance and help speed the testing of alternative paint formulations. As with other issues, it will be important to identify the chemical compounds that may be released into the environment, estimate their concentrations under routine and accident situations, describe the fate of the contaminants in the environment (e.g., taken up by plants and animals, adsorbed to sediments, transported downstream), and then subsequently judge their toxicity and the need for minimization and mitigation options.

### ***3.7 Interference with Animal Movements and Migrations***

Energy developments will add new structures to rivers and oceans that may affect the movements and migrations of aquatic organisms. Hydrokinetic devices, and their associated anchors and cables in a river, could attract or repel animals or interfere with their movements. In addition to seabed structures (e.g., anchors, turbines), many of the ocean energy devices would use mooring lines to attach a floating generator to the ocean bottom and electrical transmission lines to connect multiple devices to each other and to the shoreline. For example, MMS (2007) estimated that wave energy facilities may have as many as 200 to 300 mooring lines securing the wave energy devices to the ocean floor (based on 2 to 3 mooring lines per device and a 100-device facility). Mooring and transmission lines that extend from a floating structure to the ocean floor will create new fish attraction devices in the pelagic zone, pose a threat of collision or entanglement to some organisms, and potentially alter both local movements and long distance migrations of marine animals (Nelson 2008; Thompson *et al.* 2008). Because the transport of planktonic (drifting) life stages is affected by water velocity (Epifanio 1988; DiBacco *et al.* 2001), localized reduction of water velocities by large, multi-unit projects could influence recruitment of some species. A variety of aquatic organisms use magnetic, chemical, and hydrodynamic cues for navigation (Cain *et al.* 2005; Lohmann *et al.* 2008a). Thus, in addition to mechanical obstructions, the electrical and magnetic fields and current and wave alterations produced by energy technologies could interfere with local movement or long-distance migrations.

#### **3.7.1 Alteration of Local Movement Patterns**

As described in Section 3.3, anchors and other permanent structures on the bottom will create new habitats, and thus may act as artificial reefs (Wilhelmsson *et al.* 2006). Artificial reefs are often constructed in order to increase fish production, but some studies suggest that they may be less effective than natural reefs (Carr and Hixon 1997) and that they may even have deleterious effects on reef fish populations by stimulating overfishing and overexploitation (Grossman *et al.* 1997).

Similarly, new structures in the pelagic zone (e.g., pilings or mooring cables for floating devices) will create habitat that may act as fish aggregation/attraction devices (FADs). These devices are extremely effective in concentrating fish and making them susceptible to harvest (Dempster and Tacquet 2004; Michel *et al.* 2007; Myers *et al.* 1986). Sea

turtles (Figure 3-15) are also known to be attracted to floating objects (Arenas and Hall 1992). Fish are attracted to the devices as physical structure/shelter, and they may feed on organisms attached to the structures (Boehlert *et al.* 2008). Artificial lighting used to distinguish structures at night may also attract aquatic organisms.



**Figure 3-15. The leatherback is the largest of the living turtles.** Source: NOAA, <http://www8.nos.noaa.gov/onms/park/Parks/SpeciesCard.aspx?plD=13&refID=6&CreatureID=1628>

between times when predators were present or absent; few small fishes were observed near the FADs when predators were present, regardless of the season. Using FADs as an experimental tool, Nelson (2003) found that fish formed larger, more species-rich assemblages around large FADs compared to small ones, and they formed larger assemblages around FADs with fouling biota. Devices enriched with fish accumulated additional recruits more quickly than those in which fish were removed.

It is likely that floating wave energy devices will act as FADs, but the effect on fish populations may be difficult to determine. FADs are attractive to fish because they provide food and shelter (Castro *et al.* 2002); subsequently, they also attract predators (Dempster 2005) that can in turn attract commercial and sport fisheries. Without well-designed monitoring, it will be difficult to determine whether an energy park will enhance populations of aquatic organisms (by providing more habitat to support more fish), will have no overall effect (because it simply draws fish from other, nearby areas), or will decrease fish populations (by facilitating harvest by predators and fishermen). Kingsford (1999) pointed out that the determination of the effects of FADs at a particular location is complicated by the influence of non-independent factors: proximity of other FADs (e.g., other wave energy units), interconnection of multiple FADs to provide routes for the movement of associated fishes, and temporal dependence (the number of fish present at one sampling date influencing the number at the next sampling date due to fish becoming residents). Statistical approaches that could be applied to experiments on the effects of FADs on fish populations and solutions to the independent factor problems were also described.

The aggregation of predators near FADs may adversely affect juvenile salmonids or Dungeness crabs moving through the project area. Wilhelmsson *et al.* (2006) found that fish abundance in the vicinity of monopiles that supported wind turbines was greater than in surrounding areas, although species richness and diversity were similar. Most of the fish they observed near the structure were small (juvenile gobies), which may in turn attract commercially important fish looking for prey. Dempster (2005) observed considerable temporal variability in the abundance and diversity of fish associated with FADs moored between 3 and 10 km offshore. The variability was often related to the seasonal appearance of large schools of juvenile fish. Fish assemblages differed

Since anchoring systems and mooring lines will likely exclude fishing activities, energy parks could serve as marine protected areas (Section 3.3). The Pacific Fisheries Management Council (2008) expressed concerns related to the prohibition of commercial fishing at wave energy test areas, and suggested that there may be either a reduction in total fishing effort and lost productivity or a displacement of fishing effort to areas outside the areas closed to fishing. Displaced fishermen would likely concentrate their efforts in areas immediately outside the wave park boundaries, resulting in increased pressures on fish and habitats in those nearby areas.

Floating offshore wave energy facilities could create artificial haul-out sites for marine mammals (pinnipeds). Devices with a low profile above the waterline (desirable for aesthetic reasons) may enable seals and sea lions to use them as a haul-out site, particularly if the installations attract the marine mammals by acting as fish-concentrating devices. NOAA considers the creation of such artificial haul-outs as undesirable and recommends the use of deterrents to discourage use by marine mammals.

Floating devices could potentially impede movements of floating marine habitat communities, such as *Sargassum* communities. Masses of floating *Sargassum* algae form unique communities of organisms that serve as important habitat for hatchling sea turtles and juvenile fish (Coston-Clements *et al.* 1991). Strong current from the Sargasso Sea in the middle of the Atlantic Ocean carry these *Sargassum* communities around the world.

Floating devices with above-water structures may attract seabirds by creating artificial roosting sites or encouraging predation on fish near the FAD (Michel *et al.* 2007). There is particular concern about collision injuries to marine birds that are attracted to lighted structures at night or in inclement weather (Boehlert *et al.* 2008; Thompson *et al.* 2008). Petersen *et al.* (2006) monitored the interactions of birds and above-water structures at a Danish offshore wind farm from 1999-2005, and found that birds generally avoided the wind farms by flying around them, although there were considerable differences among species. The monitoring data suggested that avoidance was reduced at night. The authors obtained few data under conditions of poor visibility because bird migrations slowed or ceased during such times. Birds typically showed avoidance responses to the rotating wind turbine blades. A stochastic model predicted very low rates of Eider collisions with the offshore wind turbines, and the predictions were confirmed by subsequent monitoring (Petersen *et al.* 2006). Desholm (2006) provides a series of papers that describe techniques for predicting and monitoring interactions of birds and wind turbine structures at sea.

### **3.7.2 Interference with Migratory Animals**

The numerous floating and submerged structures, mooring lines, and transmission cables associated with large ocean energy facilities could interfere with the long-distance migrations of marine animals (e.g., juvenile and adult salmonids, Dungeness crabs, green sturgeon, elasmobranchs, sea turtles, marine mammals, birds) if they are sited along migration corridors. On the U.S. Pacific Coast, effects on gray whales (*Eschrichtius robustus*) may be of particular concern because they migrate within 2.8 km of the shoreline (Hagerman and Bedard 2004). Boehlert *et al.* (2008) noted that buoys attached

to commercial crab pots already comprise a major existing risk to gray whales off the coast of Oregon. Lines associated with lobster pots and other fishing gears are a source



**Figure 3-16. Jellyfish may become entangled in electrical and mooring cables.**

Source: Glenn Cada

of injury and mortality to endangered North Atlantic right whales (*Eubalaena glacialis*) on the East Coast of the U.S. (Caswell et al. 1999; Kraus et al. 2005). Many marine fish species drift or actively migrate long distances in the sea, and may interact with ocean energy developments. Anadromous fish (e.g., green sturgeon, salmon, steelhead) and catadromous fish (e.g., eels) migrate through both rivers and oceans and therefore may encounter both hydrokinetic devices in the rivers and ocean energy projects (Dadswell et al. 1987).

Entanglement of large, planktonic jellyfish (Figure 3-16) with long tentacles (as well as actively swimming sea turtles and marine mammals) is a potential issue for energy technologies with mooring lines in the pelagic zone. Thin mooring cables are expected to be more dangerous than thick ones because they are more likely to cause lacerations and entanglements, and slack cables are more likely to cause entanglements than taut ones (Boehlert et al. 2008).

Michel et al. (2007) expect that smaller dolphins and pinnipeds could easily move around mooring cables, but larger whales may have difficulty passing through an energy facility with numerous, closely spaced lines. Marine species with proportionately large pectoral fins or flippers may be relatively more vulnerable to mooring lines, based on information from humpback whale entanglements with pot and gill net lines (Johnson et al. 2005).



**Figure 3-17. Pilot whales socializing at the surface during the middle of the day.**

Source: NOAA , <http://www.pifsc.noaa.gov/psd/mmrp/cetaceans.php>

Boehlert et al. (2008) suggested that whales probably do not sense the presence of mooring cables, and as a result could strike them or become entangled. In addition, they believed that if the cable density is sufficiently great and spacing is close, cables could have a “wall effect” that could force whales around them, potentially changing their migration routes. Whales and dolphins traveling or feeding together (Figure 3-17) may be at a greater risk than solitary individuals because “group responses” may lead some individuals to follow others into danger (Faber Maunsell and Metoc 2007).

Wave energy converters deployed near sea turtle nesting beaches have the potential to interfere with the offshore migration of hatchlings. Interference with migration could occur if the energy project acts as a physical barrier or alters wave action, which has been

demonstrated to guide hatchlings away from the beach toward the open ocean (Lohmann et al. 1995; Goff et al. 1998; Wang et al. 1998).

Some marine fish species form spawning aggregations at specific sites or times (Cushing 1969; Sinclair and Tremblay 1984; Crawford and Carey 1985; Colin 1992; Coleman et al. 1996; Domeier and Colin 1997). The numbers of fish in aggregations may be quite large; Smith (1972) reported a spawning aggregation consisting of 30,000 to 100,000 Nassau groupers (*Epinephelus striatus*) in the Bahamas. Since spawning success is important to the viability of populations, the siting and operation of ocean energy facilities would need to avoid interfering with these activities.

### **3.7.3 Mitigation Options to Address Local and Migratory Movements of Animals**

The most reliable impact mitigation measure is likely to be proper siting of the energy project in order to avoid sensitive fish populations; habitat areas; important fishing grounds; and migration corridors for fish, marine mammals, and sea turtles. Installation could be limited to periods when migratory marine mammals and fish are not present or, for resident fish, during less sensitive seasons.

The project design should allow easy escape/exit of animals, with adequate distances between individual units. Cables laid on the surface of the seabed should have enough slack to conform to the contour but enough tension to preclude suspensions or loops. In the water column, taut lines are less likely to cause entanglements than slack lines. Thick mooring lines are less likely to cause abrasions than thin lines and may be easier for migrating animals to detect. Acoustic pingers, seal-scaring devices, or visual cues (e.g., highly visible paints) have been suggested to reduce entanglements or collisions with turbines or mooring lines.

As an example of proposed impact minimization measures, the above-water structures of floating buoys could be cone shaped to prevent pinnipeds from using them as haul-out sites (FERC 2007). Minimizing horizontal surfaces above the waterline would prevent sea turtles and birds from using the devices as resting habitat. Anchor lines would have sufficient tension to minimize entanglement sometimes seen with smaller and lighter tensions.

## **3.8 Collision and Strike**

Submerged structures present a collision risk to aquatic organisms and diving birds, and the above-water components of floating structures may be a risk to flying animals (see Section 3.7.1). Wilson et al. (2007) defined collision as physical contact between a device or its pressure field and an organism that may result in an injury to that organism. They noted that collisions can occur between animals and fixed submerged structures, mooring equipment, surface structures, horizontal and vertical axis turbines, and structures that, by their individual design or in combination, may form traps. Harmful effects to animal populations could occur directly (e.g., from strike mortality) or



indirectly (e.g., if the loss of prey species to strike reduces food for predators). Attraction of marine mammals and other predators to fish congregating near structures may also expose them to increased risk of collision or blade strike.

In an attempt to define the risk of collisions from marine renewable energy devices, Wilson *et al.* (2007) reviewed information from other industrial and natural activities: power plant cooling intakes, shipping, fishing gear, fish aggregation devices, and wind turbines. They concluded that although animals may strike any of the physical structures associated with marine renewable energy devices (i.e., vertical or horizontal support piles, ducts, nacelles, anchor blocks, chains, cables, and floating structures), turbine rotors are the most intuitive sources of significant collision risks with marine vertebrates.

### **3.8.1 Effects of Rotor Blade Strike on Aquatic Animals**

Many of the hydrokinetic and ocean current technologies extract kinetic energy by means of moving/rotating blades. A wide variety of swimming and drifting organisms (e.g., fish, sea turtles, diving birds, cetaceans, seals, and otters) may be struck by the blades and suffer injury or mortality (Wilson *et al.* 2007). Mortality is a function of the probability of strike and the force of the strike. The seriousness of strike is related to the animal's swimming ability (i.e., ability to avoid the blade), water velocity, number of blades, blade design (i.e., leading edge shape), blade length and thickness, blade spacing, blade movement (rotation) rate, and the part of the rotor that the animal strikes. A vertical axis turbine, such as the Blue Energy Ocean Turbine depicted in Figure 2-1, will have the same leading edge velocity along the entire length of the blade. On the other hand, blade velocity on a horizontal axis turbine will increase from the hub out to the tip. The rotor blade tip has a much higher velocity than the hub because of the greater distance that is covered in each revolution. For example, on a rotor spinning at 20 rpm, the leading edge of the blade 1 m from the center point will be traveling at a velocity of about 2 m/s – a speed that is likely to be avoidable or undamaging to most organisms. However, a 20-m-diameter rotor spinning at 20 rpm would have a tip velocity of nearly 21 m/s. Fraenkel (2006; 2007b) described a horizontal axis turbine (Seagen; Figure 3-18) with a maximum rotation speed of 12 to 15 rpm, which results in a maximum blade tip velocity of 12 m/s. Wilson *et al.* (2007) suggested that rotor blades tips will likely move at or below 12 m/s because greater speeds will incur efficiency losses through cavitation.

The force of the strike is expected to be proportional to the strike velocity. Consequently, the potential for injury from a strike would be greatest at the outer periphery of the rotor. Unfortunately, little is known about the magnitude of impact forces that cause injuries to most marine and freshwater organisms (Cada *et al.* 2005; 2006) or the swimming behavior (e.g., burst speeds) that organisms may use to avoid strike. Although the blade tip will be moving at the highest velocity and exhibit the greatest strike force, animals may be able to avoid the tip of an unducted rotor. As shown in Figure 3-19, relatively safe areas of passage through the rotor would be nearest the hub (because of low velocities) and potentially nearest the tip (because of the opportunity for the animal to move outward to avoid strike). The central zone of relatively high blade velocities and relatively less opportunity to avoid strike may be the most dangerous area (Coutant and Cada 2005). For rotors contained in housings (Figure 3-20), there would be no

opportunity for an organism entrained in the intake flow to escape strike by moving outward from the periphery; safe passage would depend on sensing and evading the intake flow or passing through the rotor between the blades. This suggestion of relatively high and low risk passage zones has not been tested and remains speculative until the phenomenon is investigated in field applications.

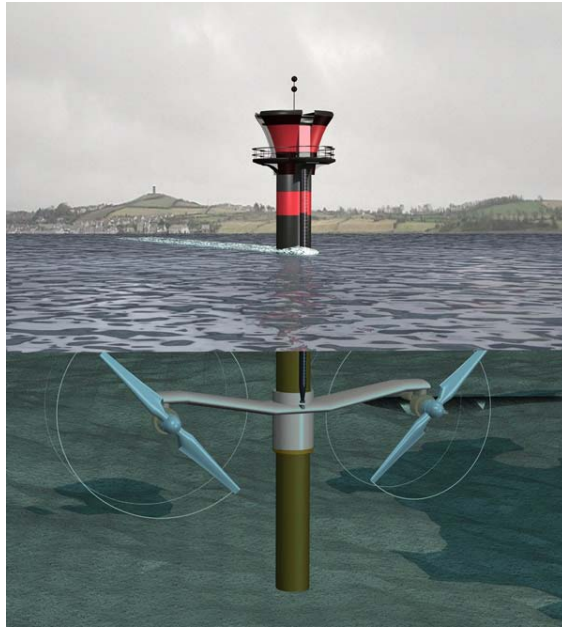

Figure 3-18. Artist's impression of the Seagen marine current turbine in Strangford Lough, UK. Source: Davison and Mallows (2005).

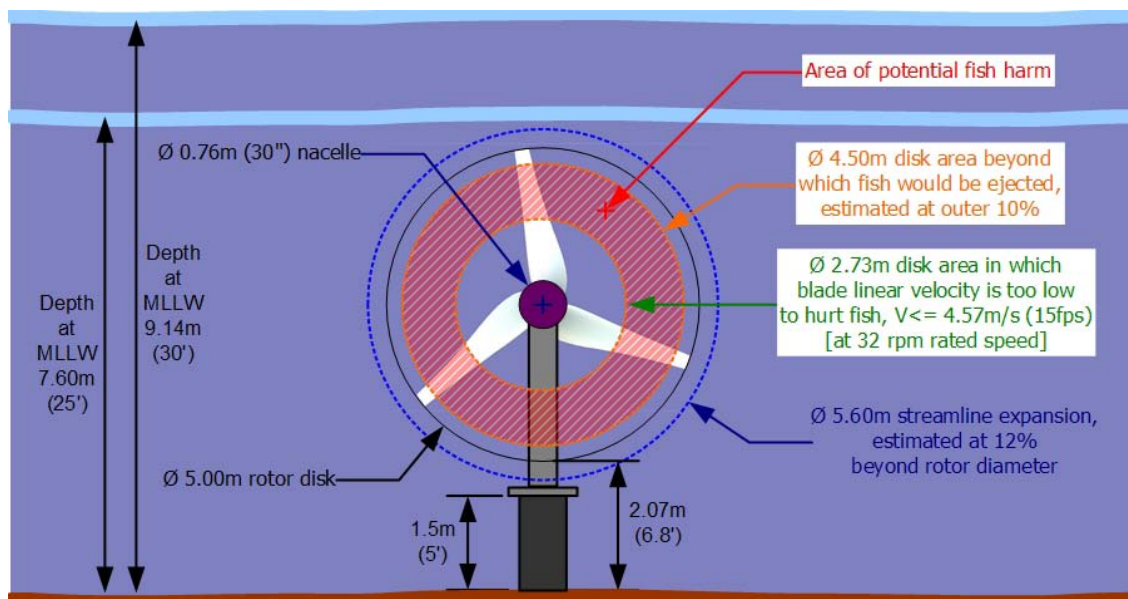

Figure 3-19. Predicted zone of potentially damaging strike associated with an unducted horizontal axis turbine. Source: Coutant and Cada (2005)



There have been several studies to estimate the potential of fish strike by rotating blades (e.g., Cada 1990; Carlson and Ploskey 2004; Deng *et al.* 2005), but all involve conventional hydroelectric turbines that are enclosed in turbine housings and afford little opportunity for flow-entrained organisms to avoid strike. It is likely that both the probability and consequences of organisms striking the rotor blade are greater for a conventional turbine than for an unducted current energy turbine, due to the greater opportunities for organisms to avoid approaching the turbine rotor or moving outward from the periphery. However, passage through a conventional turbine poses only a single exposure to the rotor, whereas passage through a project consisting of large numbers of hydrokinetic energy turbines represents a larger risk of strike that has not been investigated.



**Figure 3-20. Ducted horizontal axis hydrokinetic turbine. Source: Hydro Green Energy LLC.**

Wilson *et al.* (2007) described a simple model to estimate the probability of aquatic animals entering the path of a marine turbine. The model is based on the density of the animals and the water volume swept by the rotor. The volume swept by the turbine can be estimated from the radius of the rotor and the velocity of the animals and the turbine blades. They emphasized that their model predicts the probability of an animal entering the region swept by a rotor, not collisions. Entry into the path toward the rotor may lead to a collision, but only if

the animal does not take evasive action or has not already sensed the presence of the turbine and avoided the encounter. Applying this simplified model (no avoidance or evasive action) to a hypothetical field of 100 turbines, each with a 2-bladed rotor 16 m in diameter, they predicted that 2 percent of the herring population and 3.6 to 10.7 percent of the porpoise population near the Scottish coast would encounter a rotating blade. At this time, there is no information about the degree to which marine animals may sense the presence of turbines, take appropriate evasive maneuvers, or suffer injury in response to a collision. Wilson *et al.* (2007) suggested that marine vertebrates may see or hear the device at some distance and avoid the area, or they may evade the structure by dodging or swerving when in closer range.

The potential injurious effects of turbine rotors have been compared to those of ship propellers, which are common in the aquatic environment. Fraenkel (2007a) pointed out that in contrast to ship propellers, the rotors of hydrokinetic and current energy devices are much less energetic. He estimated that a tidal turbine rotor at a good site will absorb about 4 kW/m<sup>2</sup> of swept area from the current, whereas typical ship propellers release over 100 kW/m<sup>2</sup> of swept area into the water column. In addition to the greater power density, a ship propeller and ship hull generate suction that can pull objects toward it, increasing the area of influence for strike (Fraenkel 2006).

### **3.8.2 Effects of Water Pressure Changes and Cavitation**

In addition to direct strike, there is a potential for adverse effects due to sudden water pressure changes associated with movement of the blade. For example, if the local water pressures immediately behind the turbine blades drop below the vapor pressure of water, cavitation will occur. Cavitation is the process of forming water vapor bubbles in areas of extreme low pressure within liquids. As a turbine blade rotates, cavitation can occur in areas of low pressure (i.e., downstream surface of blades) causing increased local velocities, abrupt changes in the direction of flow, and roughness or surface irregularities (USACE 1995). Once formed, cavitation bubbles stream from the area of formation and flow to regions of higher pressure where they collapse. The violent collapse of cavitation bubbles creates shock waves, the intensity of which depends on bubble size, water pressure in the region of collapse, and dissolved gas content. Within enclosed, conventional hydroelectric turbines, forces generated by cavitation bubble collapse may reach tens of thousands of kilopascals at the instant and point of collapse (Hamilton 1983; Rodrigue 1986). Cavitation is an undesirable condition that will reduce the efficiency of the turbine and damage blades as well as nearby organisms (Cada *et al.* 1997). Properly operating turbines would not cavitate, and the zone of low pressure that might be injurious to organisms would be relatively small.

The pressure drops associated with the blades of hydrokinetic turbines have not been measured in field applications, but experimental evidence suggests that tidal turbines may experience strong and unstable sheet and cloud cavitation, as well as tip vortices at a shallow depth of submergence (Wang *et al.* 2007). If this occurs, aquatic organisms passing near the cavitation zones in the immediate blade area may be injured. The likelihood of cavitation-related injuries would depend on the extent of cavitation and the ability of aquatic organisms to avoid the area – the collapse of cavitation vapor bubbles creates noise which may act as a deterrent.

### **3.8.3 Mitigation Options to Address Collision and Strike**

It is expected that if an organism does not approach the immediate area of the blade leading edge (for strike) or downstream side of the blade tip (for cavitation), the risk of injury will be small. For an organism in the zone of influence of the rotor, the risk of rotor strike from a single unit can be readily estimated from information on such factors as water velocity, blade rotation velocity, and size of the organism. Assuming that the animal is able to sense the presence of the blade and attempt evasive maneuvers, an estimate of its ability to avoid strike might be made by comparing the blade speed with the animal's burst (darting) speed. A fish's maximum burst speed depends on several factors (e.g., species, size, physiological state, water temperature), but it may be roughly estimated as 10 body lengths per second (Videler and Wardle 1991).

Predicting the probability of strike for a large project with hundreds of closely spaced rotors has not been accomplished. Statistical models, supplemented by laboratory studies, could be used to extrapolate from strike estimates for single units. Until information about the ability of aquatic animals to avoid strike is developed, impacts can be reduced by siting projects in areas where blade contact is least likely. Data on

animals' migratory paths, preferred depths, diurnal activity, and attraction or repulsion by the project structures might be used to locate projects away from sensitive areas. Unfortunately, the best locations for tidal energy devices are often at "pinch points" where the underwater topography causes currents to accelerate, such as straits between islands and the mainland and shallows around headlands (Fraenkel 2006). If these areas also concentrate aquatic organisms moving with the current, the risk of strike may be increased.

Structural and operational modifications could be made to reduce the risk of injury from blade strike (Cada *et al.* 1997). For example, rotors with large blade spacing and low rotation rates are unlikely to pose a serious strike threat for most organisms. Blunt leading edges are less likely to injure an organism than sharp leading edges (Turnpenny *et al.* 1992; Amaral *et al.* 2008; EPRI 2008). Hydrokinetic and ocean current turbine designers have a number of options that can affect the incidence of strike: altering the number of blades, blade speed, area per blade channel, thickness and bluntness of blade leading edges, and blade tilt. The optimal blade shape (especially leading edge shape) may be a tradeoff between the goals of maximizing generating efficiency and minimizing cavitation and strike damage to organisms. Some turbine designs (especially those with ducted rotors) might support fish screens to prevent contact with the blades, although the possibility of screen impingement of weakly swimming organisms would need to be considered. Also, the growth of biofouling organisms (e.g., marine organisms, zebra mussels) or the accumulation of debris on screens would alter their effectiveness.

Noise and damaging pressure changes associated with cavitation will be reduced by optimization of blade shape (Bahaj *et al.* 2007). Batten *et al.* (2006) applied a computational model to the design of a marine current turbine which suggested that changes in the blade pitch angle or camber can alter stall performance and the possibility of cavitation. They noted that acceptable levels of cavitation for marine turbines are not yet known but will depend upon the erosion performance of blade materials. Although excessive noise is undesirable, low levels of noise may help animals detect and avoid dangerous areas.

Wilson *et al.* (2007) listed a number of techniques that could be considered to minimize collisions:

- Reducing encounter risk (e.g., using appropriate locations relative to bathymetry, critical habitat areas, spacing among individual devices; shutting down operation during critical seasons)
- Raising the conspicuousness of the devices (e.g., blade colors and acoustic deterrents)
- Shielding the blades with protective netting or grids
- Reducing vertical traps in the device design and/or among multiple devices for air-breathing animals
- Softening collisions (e.g., shock absorbing structures, reduction of sharp edges)

Many aquatic animals (including mammals, turtles, fish, and invertebrates) have the ability to sense disturbances in the environment, such as sounds and other pressure waves. If an animal can sense the presence of the device, recognize it as a potential danger, and can maneuver to avoid the device, then the risk of strike will be small. Effective mitigation of strike potential will be based on careful siting and spacing of individual units within an energy project, a better understanding of the escape potential of organisms at risk, and the development of strike avoidance measures such as acoustic deterrents and screens.

### 3.9 Impacts of Ocean Thermal Energy Conversion (OTEC)

An OTEC technology operates a low temperature heat engine based on the temperature differences between warm, surface water and cold, deep water (Holdren et al. 1980). (Figure 3.21) This type of project consists of pumps and ducts for transferring large volumes of water (several times more flow than is needed for a once-through cooling system of a comparably-sized steam electric power plant), large heat exchangers, and a working fluid that can be vaporized and recondensed (i.e., ammonia, propane, Freon<sup>®</sup>, or water). Electrical energy could be transported from offshore systems via subsea cables, or alternatively could be converted to chemical energy *in situ* (e.g., hydrogen, ammonia, methanol) and transported to shore in tankers (Pelc and Fujita 2002).

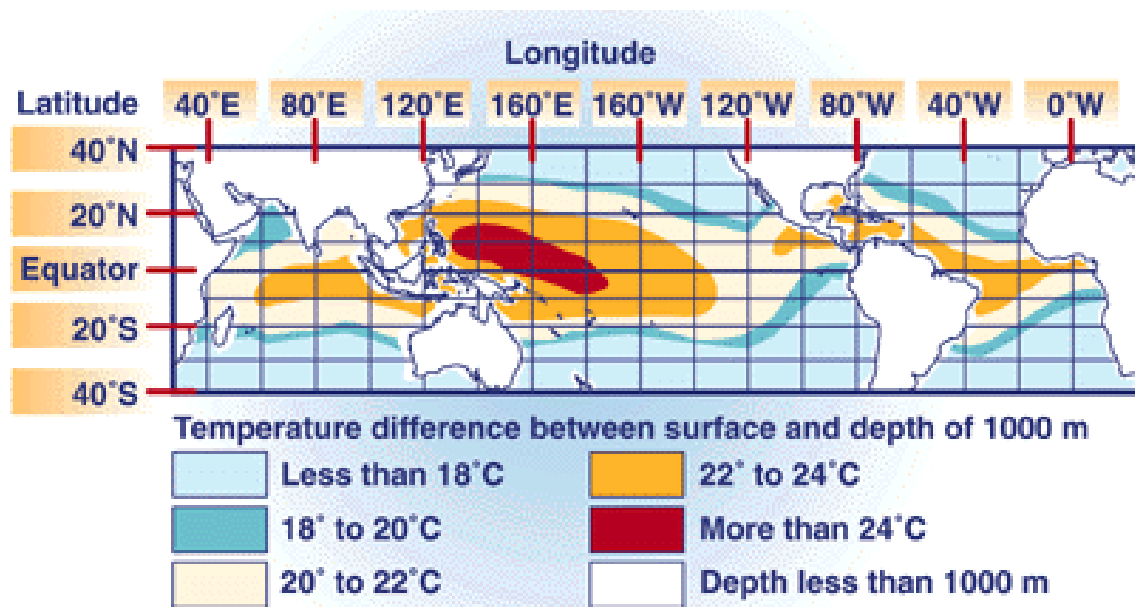

Figure 3-21. An OTEC system could produce a significant amount of power in the world's oceans where the temperature difference between the warm surface water and the cold deep water is about 20°C or more. Source: NREL, <http://www.nrel.gov/otec/markets.html>

### 3.9.1 Effects on Ocean Ecosystems

Impacts of construction of an OTEC facility will depend on whether the project is located onshore or offshore. An onshore facility (Figure 2-4) would require the installation of large, long water conduits on the seabed to access deep water. Alternatively, OTEC projects located on offshore platforms would depend on subsea cables to transfer electricity to shore. The installation and maintenance of pipelines and electrical cables would disturb bottom habitats and generate EMF (Sections 3.3 and 3.5). Structures could become colonized with marine organisms and attract fish (see discussion of FADs in Section 3.7.1). Depending on the location of the warm water intake and discharges, these fish might be more susceptible to entrainment, impingement, or contact with the discharge plume.

The potential environmental effects of OTEC operation have been considered by a number of authors (Holdren *et al.* 1980; Myers *et al.* 1986; Harrison 1987; Abbasi and Abbasi 2000; Pelc and Fujita 2002). Myers *et al.* (1986) provided the most comprehensive assessment of the possible effects on the marine environment resulting from operation of the types of OTEC facilities that were contemplated in the early 1980s. Most of the likely effects were expected to be physical and chemical changes in the ocean surface waters arising from the transfer of large volumes of cool, deep water. Abbasi and Abbasi (2000) suggested that OTEC plants will displace about 4 m<sup>3</sup>/s of water per MW of electricity output from both the surface layer and the deep ocean layer, and then discharge the water at some intermediate depth. The warm water intake would be located at about 10 to 20 m depth, and the cold water intake might extend to a depth of 750 to 1000 m (Myers *et al.* 1986). The large transfer of water may disturb the thermal structure of the ocean near the plant, change salinity gradients, and change the amounts of dissolved gases, dissolved minerals, and turbidity. The transfer will result in an artificial upwelling of nutrient-rich deep water, which may increase marine productivity in the area. The stimulation of marine productivity may be especially strong in tropical waters, where nutrient levels are often low, and could have detrimental effects on nearby sensitive habitats like coral reefs. Moreover, carbon dioxide will also be released when the deep water is warmed and subjected to lower pressures at the surface. The possible amounts of carbon dioxide released have not been rigorously quantified; some estimate that the quantities will be minute (Pelc and Fujita 2002) and others suggest that the contribution will be relatively large (Holdren *et al.* 1980). The relatively high carbon dioxide and low dissolved oxygen content of the deep water may alter pH and dissolved oxygen concentrations in a surface mixing zone.

The large heat exchangers will need to be treated with biocides (e.g., chlorine or hypochlorite) in order to prevent the growth of bacterial slimes and other biofouling organisms; volumes of biocides would be proportional to the large volume of heating and cooling water. Degradation of the heat exchanger materials will result in chronic releases of metals (e.g., copper, nickel, aluminum). Accidental release of the working fluid that is evaporated and condensed to drive the turbine could have toxic effects. The potential for acute and chronic toxicity and bioaccumulation of metals from deep ocean water will need to be considered (Fast *et al.* 1990).

Ocean thermal energy conversion projects would be sources of waterborne noise, arising from operation of ammonia turbines, seawater pumps, support systems associated with the energy-producing cycle, and in some cases propulsion machinery for dynamic positioning of the OTEC platform. Janota and Thompson (1983) measured noise from OTEC-I, a 1-MWe test facility that was moored near Keahole Point, Hawaii. The most significant sources of noise from the small project resulted from the interaction of inflow turbulence with the seawater pumps and from thrusters used for dynamic positioning. Based on their measurements, Janota and Thompson (1983) predicted that a 160-MWe OTEC plant would radiate less than 0.05 acoustic W of broadband sound in the frequency range of 10 to 1,000 Hz, which is at least an order of magnitude less than that which is produced by a typical ocean-going freighter. Similarly, Rucker and Friedl (1985) predicted that pump noise (at 10 Hz) from a 40 MWe OTEC plant would be reduced from 136 dB to 78dB at about 0.8 km; this is less than ambient noise at a sea state of 1 (very gentle sea with waves less than 0.3 m in height).

Large marine organisms may be impinged on the screens that protect the OTEC intakes, and smaller organisms (e.g., zooplankton [Figure 3-22], fish eggs, and larvae) will pass through the screens and be entrained in the heat exchanger system (Abbasi and Abbasi 2000). The numbers of organisms entrained in the water will depend on their concentrations in the intake areas; more aquatic organisms are likely to be impinged and entrained at the surface water intake than from the deep water intake. Due to the large flow rates of water at the warm water intake, impingement and entrainment will especially need to be monitored there. As with steam electric power plants, the heat exchanger-entrained organisms will be susceptible to mechanical damage in the piping and to rapid changes in temperature, pressure, salinity, and dissolved gases that may cause mortality. For example, the temperature of cold, deep water is expected to increase by about 2 to 3°C after passing through the heat exchangers; likewise, the temperature of shallow, warm water is expected to decrease by the same amount. Myers *et al.* (1986) noted that there is insufficient information to judge the impacts of a 2 to 3°C temperature shock, but assumed that most organisms will probably not be directly impacted by this amount of temperature change. However, secondary entrainment into the discharge plume will also expose marine organisms to chemical, physical, and temperature stresses. A mixed discharge of warm and cold water could subject organisms entrained from the warm surface waters to a drop of 10°C, which would likely cause lethal cold shock for some species. Few organisms are expected to be entrained in the deep, cold water flow, but those that do will be subjected to potentially lethal pressure decreases of 70 to 100 atmospheres (7,100-10,100 kilopascals) (Myers *et al.* 1986).

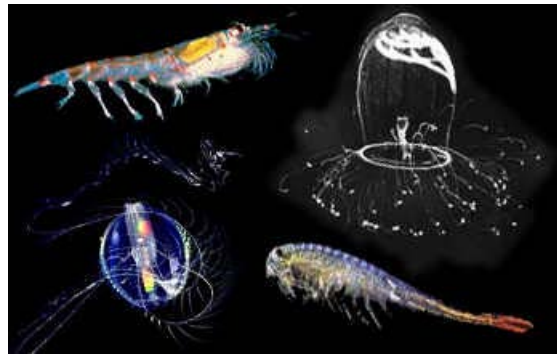

**Figure 3-22. Zooplankton, tiny animals that graze upon phytoplankton as they ride the ocean currents, are eaten by whales, small fish, invertebrates, and birds. Source: USGS, [http://www.absc.usgs.gov/research/seabird\\_for\\_agefish/marinehabitat/home.html](http://www.absc.usgs.gov/research/seabird_for_agefish/marinehabitat/home.html)**

### **3.9.2 Mitigation Options to Address Effects of OTEC Technologies on Ocean Ecosystems**

Pelc and Fujita (2002) suggested a number of measures to control the environmental impacts of OTEC: (1) refraining from siting OTEC plants in sensitive areas such as prime fishing grounds, spawning areas, and sensitive reef habitats (more feasible than for energy technologies located in shallow waters); (2) using the OTEC discharge for ancillary benefits (e.g., agriculture, aquaculture, desalinization) to reduce the degree to which the discharges alter local water temperatures and water chemistry; (3) carefully regulating the use of toxic chemicals such as ammonia and chlorine; and (4) relying mainly on relatively small plants, which will reduce the local impacts of entrainment, impingement, and discharges. Abbasi and Abbasi (2000) suggested that the OTEC plant be designed to discharge its water below the photic zone, thereby reducing the amount of carbon dioxide emitted and the negative effects of temperature changes and nutrient over-enrichment. Myers *et al.* (1986) suggested a variety of measures to reduce the potential effects on fisheries: (1) locating the cold water intake as deeply as feasible to avoid entrainment of zooplankton and fish eggs and larvae; (2) locating the warm water intake away from concentrations of plankton, possibly in shallow water; (3) minimizing warm water intake velocities to reduce impingement; and (4) optimizing the location of the discharge in order to minimize biocide toxicity, cold shock, and other effects of secondary entrainment, and the possibility of poisoning from toxic algae blooms. Intake screens could be installed to prevent the entrainment of large organisms, but the possibility of screen impingement mortality would need to be considered.

## 4 Environmental Assessment, Adaptive Management, and Environmental Monitoring

This section considers the impact assessment approaches and environmental laws and regulations that may be used to guide the environmentally sound development of ocean energy and hydrokinetic projects. It describes the regulatory authorities that determine monitoring requirements for the new developments, the types of monitoring that could be employed to address the issues discussed in Section 3, and the opportunities for conducting environmental monitoring within an adaptive management framework.

### 4.1 Environmental Impact Assessment Approaches

There are numerous state and Federal agencies and environmental laws and regulations that influence the development of marine and hydrokinetic energy technologies. For example, Lane (2008a) outlined the statutory requirements for developments in the United States and its territorial waters and described relevant Federal agency authorities and Federal legislation. States may also impose their own conditions on the use of cultural, fish and wildlife, and water resources by these technologies – possibly enacting legislation more stringent than Federal law. Relevant state agencies will be involved in the approval process for a wave, tidal, or hydrokinetic energy project proposals (Lane 2008a). Local agencies may regulate necessary onshore infrastructure development and, in some cases, regulate activities on state tidelands in state waters (within 3 nautical miles of shore). Thus, depending on the project type and location, a number of regulatory and resource agencies may be involved in reviewing or permitting a project, and approaches for assessing the environmental impacts and corresponding minimization and mitigation options may differ.



**Figure 4-1.** The cultural use of an area by Native Americans is considered in NEPA documents. The Chumash, indigenous people historically lived along the California Coast from Malibu to San Luis Obispo; they harvested the marine resources of the Channel Islands for food and trade. Source: NOAA, <http://oceanexplorer.noaa.gov/explorations/02quest/background/uses/uses.html>

Different Federal and state agencies will have their own processes to assess the environmental impacts of these renewable energy projects. Federal agencies must comply with the NEPA, which requires the preparation of an environmental impact statement (EIS) or environmental assessment (EA) for Federal actions that may significantly affect the quality of the human environment (Figure 4-1). In this present context, Federal action may include granting a permit or license to construct and operate an ocean energy project. The EIS or EA must consider alternatives to the proposed action such as alternate locations; a no-action alternative; and socioeconomic,



environmental, and cultural impacts. Each Federal agency has its own approach to implementing NEPA, but all include public consultation and consideration of relevant environmental laws, such as the Clean Water Act (CWA), Endangered Species Act (ESA), Coastal Zone Management Act (CZMA), and National Marine Sanctuaries Act (Lane 2007), Marine Mammals Protection Act and others (Lane 2008a). NOAA would be consulted regarding the potential effects on essential fish habitat under the Magnuson-Stevens Act. Coastal construction (e.g. the discharge of dredge and fill material) would be regulated under a CWA Section 404 permit issued by the U.S. Army Corps of Engineers. In addition, States administer portions of Federal regulatory laws (including CZMA and CWA), and some require environmental reports and assessments consistent with their own environmental protection laws.

Quantification of both the environmental impacts and environmental benefits for a proposed action can promote a better understanding of the consequences related to different alternatives considered under NEPA. For example, EPA may use an ecological risk assessment process to evaluate the likelihood of adverse ecological effects that may occur as a result of exposure to one or more stressors. Combining ecorisk analysis and weight-of-evidence assessment approaches would support sound decision making even in cases of relatively high uncertainty (e.g., Suter *et al.* 2002; Forbes and Calow 2002; McDonald *et al.* 2007). EPA provides guidelines (EPA 1998) and maintains a website for training on the procedures (<http://www.epa.gov/pesticides/ecosystem/ecorisk.htm>). Net Environmental Benefits Analysis (NEBA) is a type of cost-benefit analysis that rigorously compares the natural resource benefits of alternative mitigation, restoration, enhancement, and preservation actions. This analysis is commonly used for remediation of chemically contaminated sites (Efroymson *et al.* 2004), but Layman *et al.* (2000) suggested that it may be a useful way to deal with contentious natural resource issues in hydropower licensing. It is especially useful for evaluating impacts over time, where initial changes may be balanced by longer-term recovery of habitats. Adaptive management (Section 4.2) is being applied increasingly as a means of using the results of environmental monitoring to improve to environmental performance of a variety of activities.

Internationally, the United Nations Environment Programme (UNEP) promotes the use of the Environmental Impact Assessment (EIA) and the Strategic Environmental Assessment (SEA) as structured approaches for obtaining and evaluating environmental information prior to its use in decision making (Abaza *et al.* 2004). The EIA makes predictions about changes to the environment from proposed physical developments (such as power stations and water resources projects), while SEA focuses on proposed actions at a higher level (such as new policies and programs). Like NEPA, the use of EIA/SEA has been formalized in many countries by incorporation into national laws and regulations. UNEP encourages the integration of EIA and SEA in order to ensure that the environmental consequences of both policies and the projects that implement those policies are formally considered by decision makers. The effective application of these processes is encouraged by EIA Principles of Best Practice (Senecal *et al.* 1999) and SEA Performance Criteria (IAIA 2002).

Predictive environmental assessments (whether by NEPA, EIA, or SEA) are oriented toward making decisions about policies, programs, or projects before full implementation – when environmentally sound alternatives can still be chosen. After a decision has been made and operation of a marine or hydrokinetic energy project has begun, the identification (and correction) of environmental impacts will depend on monitoring. The ability to modify the project in order to mitigate unacceptable environmental impacts identified by operational monitoring might be based on application of adaptive management principles reflected in the project license conditions.

## ***4.2 Incorporating Adaptive Management into Development and Environmental Monitoring of Marine and Hydrokinetic Energy Technologies***

Accurate assessment of the environmental impacts of a new technology is constrained initially by a lack of information. Eventually, operating experience will suggest whether the particular issues described in Section 3 will be inconsequential or will require additional investigation. A systematic development of understanding of the environmental issues could be accomplished through the incorporation of adaptive management principles into the monitoring required by project licenses. Adaptive management is a system of management practices based on clearly identified outcomes and monitoring to determine whether management actions are meeting desired outcomes. If not, management changes are facilitated to ensure that outcomes are met or re-evaluated (Walters 1986; 73 FR 61291-61323, October 15, 2008) (Figure 4-2). In the context of marine and hydrokinetic energy technologies, adaptive management is a systematic process by which the potential environmental impacts of installation and operation could be evaluated against quantified environmental performance goals during project monitoring. Early information about undesirable outcomes can lead to the implementation of minimization or mitigation actions which are subsequently re-evaluated. An adaptive management process is particularly valuable in the early stages of technology development, when many of the potential environmental effects are unknown for individual units, much less for the eventual build-out of large numbers of units. There is widespread realization of the possible benefits of incorporating an adaptive management approach in the development and monitoring of these new technologies. For example, PFMC (2008) recommended that license conditions issued for wave energy test leases incorporate

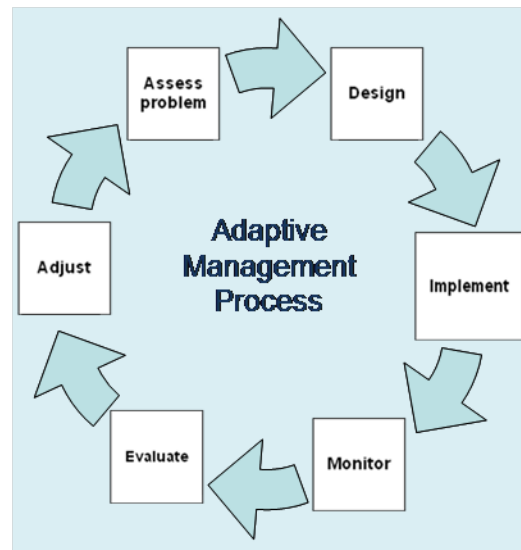

**Figure 4-2. Diagram of the adaptive management process. Source: Williams et al. 2007**

adaptive management to identify and respond to uncertainties regarding the projects' effects.

The Department of Interior (DOI) (Williams *et al.* 2007) adopted the description of adaptive management published by the National Research Council (2004):

Adaptive management [is a decision process that] promotes flexible decision making that can be adjusted in the face of uncertainties as outcomes from management actions and other events become better understood. Careful monitoring of these outcomes both advances scientific understanding and helps adjust policies or operations as part of an iterative learning process. Adaptive management also recognizes the importance of natural variability in contributing to ecological resilience and productivity. It is not a 'trial and error' process, but rather emphasizes learning while doing. Adaptive management does not represent an end in itself, but rather a means to more effective decisions and enhanced benefits. Its true measure is in how well it helps meet environmental, social, and economic goals, increases scientific knowledge, and reduces tensions among stakeholders.

Adaptive management is an iterative process of planning and implementing an action, then monitoring, evaluating, and making adjustments as needed.

Williams *et al.* (2007) point out that there are two overarching conditions that argue for the application of adaptive management to a decision: (1) there must be a mandate to take action in the face of uncertainty and (2) there must be an institutional capacity and commitment to undertake and sustain an adaptive program. The mandate might come from laws (e.g., NEPA, CWA, ESA), regulations (e.g., FERC license conditions), or policies (e.g., DOI policy on the use of adaptive management; DOI 2007 and 2008 and 73 FR 61291-61323; October 15, 2008).

When a decision to employ adaptive management has been made, Williams *et al.* (2007) recommended carrying out the process in a series of nine steps, divided into a set-up phase and an iterative phase:

#### Set-up phase

- (1) Stakeholder involvement – ensure that the stakeholders are committed to adaptively manage the enterprise for its duration;
- (2) Management objectives – identify clear, measurable, and agreed-upon management objectives to guide decision making and evaluate effectiveness over time;
- (3) Management alternatives – identify a set of potential management actions for decision making;
- (4) Predictive models – identify models that characterize different ideas/hypotheses about how the system works;
- (5) Monitoring plans – design and implement a monitoring plan to track resource status and other key resource attributes;

#### Iterative phase

- (6) Decision making – select management actions based on management objectives, resource conditions, and understanding;
- (7) Monitoring responses to management – use monitoring to track system responses to management actions;

- (8) Assessment – improve understanding of resource dynamics by comparing predicted and observed changes in resource status;
- (9) Adjustment to management actions – go back to step 6 as necessary.

## Using Adaptive Management

Framed in the context of marine and hydrokinetic renewable energy technology developments, adaptive management should be considered in the following types of situations (Williams *et al.* 2007):

- a) ***There is a need to make consequential decisions.*** That is, there are real, unresolved concerns about the impacts to the environment of the installation and operation of a renewable energy technology whose significance warrant hypothesis testing (e.g., the development of predictive models and collection of modeling data). Minor issues (e.g., the decision to implement proven mitigation options such as environmentally benign chemicals or sound insulation) can be resolved without the commitment of time and resources associated with the adaptive management process.
- b) ***There is an opportunity to apply knowledge – the potential issue can be usefully studied and the initial decision can be revisited and modified over time.*** If the methods by which a marine/hydrokinetic facility are installed and operated cannot be satisfactorily evaluated and modified, then adaptive management has no role.
- c) ***Clear and measurable management objectives can be specified by the regulatory and resource agencies.*** The pre- and post-installation state of water quality, aquatic habitats, and/or aquatic biological communities must be quantified to detect changes brought about by the energy technology.
- d) ***There is a high value for future decision making.*** This applies to decisions related to continued operation of the particular renewable energy facility that is being monitored or to the development of future installations.
- e) ***Testable analytical or theoretical models can be crafted to predict the effects of the renewable energy development on the environment, and the output of these models can be compared to actual monitoring data.*** The models must reflect appropriate scales for the potential effects – both time scales (seconds vs. days vs. years) and spatial (impacts occurring over localized vs. large areas). Expected impacts of a marine/hydrokinetic technology must be clearly stated as one or more testable hypotheses. Analytical models can be modified and validated with actual test data.
- f) ***Effective monitoring can be established that allows statistically based hypothesis testing.*** Small changes in the environment (e.g., water quality, habitat, biological populations and communities) are difficult to detect, and monitoring that is insufficient to detect real, but small, changes may lead to the erroneous conclusion that the technology has no impacts. The level of field monitoring should be appropriate to adequately test the hypotheses and refine the predictive models using appropriate time and spatial scales. Monitoring should not be so infrequent that it fails to detect natural or technology-caused changes in the environment. Similarly, monitoring restricted to a local scale (e.g., habitat changes occurring near a single marine turbine) may miss more extensive habitat alterations associated with multiple units.

**Figure 4-3. Appropriate conditions for adaptive management use.**

One value of adaptive management is in sharing information, so that future installations can benefit by reducing environmental impacts. The timely availability of monitoring

data to all affected agencies and stakeholders is important (CEQ 2003; 40 C.F.R. 1505.3(d)).

Prato (2003) noted that there are two forms of adaptive management: passive and active. In passive adaptive management, simulation models and expert judgment are combined to select a preferred action, and monitoring data are used to revise model parameters. Passive adaptive management is relatively simple and inexpensive to implement, but it is non-experimental and may not provide reliable information for making decisions. On the other hand, active adaptive management uses statistically designed experiments to test assumptions or hypotheses about ecosystem responses to actions. Such experiments could incorporate replication and randomization of management actions (i.e., treatments) and, as a result, might provide more clear-cut, reliable results. Active adaptive management (experiments) may, however, be too difficult and costly to carry out in a large river or marine environment. Prato (2003) suggested that passive adaptive management could be employed to assess actions that have a localized effect or relatively certain outcome, reserving the resources needed for active adaptive management to the subset of issues with the greatest uncertainty.

CEQ (2003) discussed the value of incorporating adaptive management into the environmental impact analysis model used in the traditional NEPA process. In the traditional process, results from research, modeling, and expert opinions are used to: (1) predict potential impacts; (2) identify mitigation options; and (3) release a document for public review. The process does not account for changes in environmental conditions, inaccurate predictions, or subsequent information that might affect the original environmental protections. CEQ considered the “monitor and adapt” elements of adaptive management to be a significant improvement over the traditional NEPA process. Both DOI and the U.S Forest Service recently incorporated adaptive management into their NEPA planning process (73 FR 61291-61323, October 15, 2008, and 73 FR 43084-43099, July 24, 2008, respectively).

CEQ (2003) noted that the following key factors must be considered when implementing an adaptive management approach:

- Capability to establish clear monitoring objectives
- Agreement on the impact thresholds being monitored
- Existence of a baseline (or the ability to develop a baseline) for the resources being monitored
- Capability to detect the effects within an appropriate time frame after action is taken
- Availability of procedures and equipment used to identify and measure changes in the affected resources as well as the ability to analyze the changes
- Availability of resources required to perform the monitoring and respond to results

An adaptive management strategy can help determine whether mitigation options are cost effective and appropriately implemented. The U.S. FWS (1993) established a policy “to

seek to mitigate losses of fish, wildlife, and their habitats, and uses thereof, from land and water developments.” The intended effect of the policy is to protect and conserve the most important and valuable fish and wildlife resources while facilitating balanced development of the nation’s natural resources. FWS developed this mitigation policy to allow developers to anticipate FWS recommendations and plan for mitigation needs early, hopefully reducing the conflicts between FWS and developers that can result in project delays. The policy incorporates the CEQ definition of “mitigation” in 40 CFR 1508.20(a-e) and states that this is the general order and priority in which mitigation options should be recommended:

- Avoiding the impact altogether by not taking a certain action or parts of an action
- Minimizing impacts by limiting the degree or magnitude of the action and its implementation
- Rectifying the impact by repairing, rehabilitating, or restoring the affected environment
- Reducing or eliminating the impact over time by preservation and maintenance operations during the life of the action
- Compensating for the impact by replacing or providing substitute resources or environments

FWS would follow this policy in evaluating proposed marine and hydrokinetic renewable energy projects and preparing recommendations to mitigate any adverse impacts that might be anticipated. This policy also encourages and supports post-project evaluations (as could be done under an adaptive management strategy) to determine the effectiveness of recommendations in achieving the mitigation planning goal.

Adaptive management could also be incorporated into the Environmental Management System (EMS) developed for the marine/hydrokinetic energy technology. An EMS is a structure of procedures and policies used to systematically identify, evaluate, and manage environmental impacts of ongoing activities (CEQ 2007). Like adaptive management, EMS is used by organizations not only to assess environmental issues, but also to actively manage them in a process that includes monitoring and action based on the monitoring results. The International Organization for Standardization (ISO) 14001 Standard (ISO 2004) is a widely used framework for establishing an EMS. ISO 14001 has many elements in common with adaptive management procedures in that it enables organizations to identify and control the environmental impacts of their activities, improve environmental performance continually, and implement a systematic approach to setting environmental objectives and targets, achieving them, and demonstrating that they have been achieved.

Due to the similarity of approaches and goals, CEQ (2007) recommended that agencies consider developing complementary NEPA and EMS procedures:

An EMS can support the implementation of a NEPA ‘adaptive management’ approach when there are uncertainties in the prediction of the impacts or outcome of a project implementation, or the effectiveness of proposed mitigation. The checking and corrective action elements of the EMS can add the ‘monitor and adapt’ steps to the traditional NEPA

'predict-mitigate-implement' model. The resulting adaptive management approach (the 'predict-mitigate-implement-monitor-adapt' model) can provide managers with the flexibility to make necessary corrections or adjustments, possibly without needing new or supplemental NEPA analyses, when the NEPA process has identified and analyzed the range of possible outcomes and the appropriate adjustments to respond to them (see CEQ 2003; FAA 2004). This approach allows continuous improvement in management effectiveness and in reducing environmental impacts within parameters established by the NEPA-informed decision.

Marine and hydrokinetic renewable energy projects must comply with a number of environmental laws (e.g., ESA, Marine Mammals Protection Act, Sustainable Fisheries Act) that can include adaptive management as part of their implementation. For example, before FERC issues a license for any project (see Section 4.3), the Commission conducts consultation under Section 7 of ESA, including development of a biological assessment (BA). Adaptive management can be used as a tool to address uncertainty due to significant data or information gaps in addressing the impacts of a project on a species covered by a BA. These gaps are not limited to biological information but also can include uncertainty in mitigation or management techniques, effects of the action, or any other missing information that poses a significant risk. Although useful in some ESA-related contexts, an adaptive management strategy may not be an appropriate course of action when dealing with critically endangered species or severely imperiled habitats.

Adaptive management strategies included as part of a proposal can assist applicants of marine and hydrokinetic renewable energy projects develop an adequate operating conservation program and improve its effectiveness. An adaptive management strategy for such projects could: (1) identify the uncertainty and questions that need to be addressed to resolve the uncertainty; (2) develop alternative strategies and determine which ones to implement; (3) include a monitoring program that is able to detect the information necessary to evaluate the strategy; and (4) incorporate feedback loops that link implementation and monitoring to a decision-making process (similar to a dispute resolution process) that results in appropriate changes in management.

### ***4.3 Federal Licensing of Marine and Hydrokinetic Renewable Energy Technologies***

Environmental monitoring and adaptive management will be components of the Federal licenses issued to these technologies. Lane (2008a,b) outlined Federal agencies' authorities and Federal legislation that guide the development of tidal, wave, and in-stream generation projects, and will be considered in the licensing of new projects (Figure 4-4). MMS has authority for leasing all renewable energy projects on the OCS. Licensing of marine and hydrokinetic renewable energy technologies in both freshwater and on the OCS rests with FERC. FERC has the primary responsibility for determining that new renewable energy projects are properly designed, constructed, and monitored to safeguard environmental resources. Some of the uncertainties about the environmental impacts of these technologies may be addressed during the lease acquisition from the MMS while other impacts may be addressed through monitoring associated with FERC license conditions.



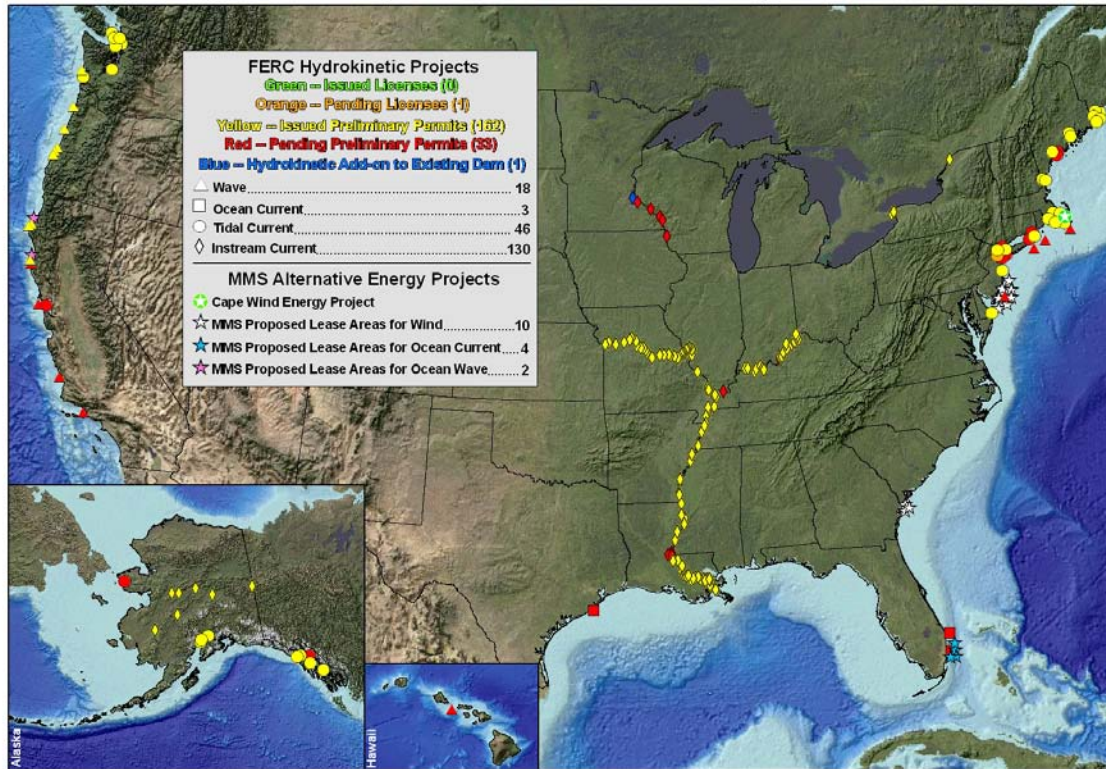

Produced by NOAA Fisheries Office of Habitat Conservation. Information accurate as of February 11, 2009. For reference purposes only.

**Figure 4-4. FERC hydrokinetic projects and MMS alternative energy projects in the U. S.**  
**Source: NOAA Fisheries Office of Habitat Conservation**

FERC published guidance on licensing procedures (FERC 2008) as part of its ongoing effort to support the advancement and orderly development of innovative hydrokinetic technologies. The guidance noted that FERC did not propose a new rule for hydrokinetic technologies, but rather proposed adaptation of existing regulations and, in some cases, provision of waivers for specific types of projects. For example, compared to licenses for conventional hydropower projects (which can be issued for a term of up to 50 years), pilot projects should not be located in sensitive areas and may have short license terms of 5 years. The pilot project license emphasizes post-license monitoring and contains conditions that require project modification, shutdown, or removal in the event that monitoring reveals an unacceptable risk to the public or environmental harm (FERC 2008).

The primary purpose of FERC’s guidance on expedited licensing procedures is to encourage testing of hydrokinetic pilot projects and reduce the uncertainties surrounding the technologies (FERC 2008). In its draft and final application, the applicant for a hydrokinetic pilot project license is expected to provide proposed plans that describe monitoring measures, performance standards, and thresholds for modification, shutdown, or removal. The pilot project license also has a license condition requiring project removal and site restoration before license expiration if a new license is not obtained. Stakeholders (i.e., Federal, state, and local resource agencies, Indian tribes, non-

governmental organizations, and members of the public) will be able to recommend modifications and additional measures or require license conditions. The proposed Reedsport OPT Wave Park in Oregon provides an example of licensing process (Figure 4-5).

### **Reedsport Ocean Power Technologies (OPT) Wave Park**

On February 16, 2007, FERC issued a preliminary permit to Reedsport OPT Wave Park, LLC (OPT) to study the proposed site for a 50-MW power project in the Pacific Ocean, about 5 km offshore of Douglas county, Oregon. The proposed project (FERC Project No. 12713) would consist of deployment and operation of 14 PowerBuoy wave energy converters having a total capacity of 2.1 MW and an electrical transmission line to shore. Each PowerBuoy has a diameter of 11.3 m, extends 8.2 m above the water, and has a draft of 36.6 m. The PowerBuoys would be deployed about 100 m apart, in an array of 3 to 4 rows. The maximum project footprint for the 14 PowerBuoys would be approximately 0.65 km<sup>2</sup> (0.8 km x 0.8 km). OPT envisions future expansion of the power park to 200 PowerBuoys resulting in a project area of approximately 0.64 km x 5 km (3.2 km<sup>2</sup>).

FERC issues preliminary permits for the purpose of enabling prospective applicants to conduct investigations and secure necessary data to determine the feasibility of the proposed project. The preliminary permit preserves the right of the permit holder to first priority in applying for a license for the project being studied, but it grants no land disturbing activities, construction, or other property rights.

OPT has consulted resource agencies and stakeholders during preparation of the license application. The meetings have focused on identifying of issues, quantifying impacts, and exploring options for resolution or mitigation. As a result of the consultations, OPT has developed a series of study plans to characterize baseline conditions of the project site and to monitor the project during operation. These plans include studies of fish and invertebrates, cetaceans, pinnipeds, sediment transport, electromagnetic fields, and seabirds.

**Figure 4-5. Reedsport OPT Wave Park.**

MMS is authorized to grant leases, easements, or rights-of-way on the OCS for the development of oil and gas resources. The OCS comprises submerged lands, subsoil, and sea bed lying between the seaward extent of the states' jurisdictions and the seaward extent of Federal jurisdiction, commonly 3 to over 200 nautical miles offshore. In addition, the Energy Policy Act of 2005 provided DOI with permitting authority for the production, transportation, or transmission of energy from the OCS, including renewable energy sources. On March 17, 2009, DOI and FERC announced an agreement on the permitting of offshore renewable energy development. Under the agreement, MMS has permitting and development authority over wind power projects that use offshore resources beyond state waters, as well as sole responsibility for leasing Federal lands offshore for all renewable energy projects (except for OTEC). FERC has primary responsibility to manage the licensing of hydrokinetic power (wave, tidal, and ocean current energy) on OCS areas that have MMS leases. FERC will seek the input of state

and Federal agencies, including MMS, when licensing marine and hydrokinetic technologies. Further details of the agreement are contained in a Memorandum of Understanding between DOI and FERC signed on April 9, 2009 (found at [http://www.mms.gov/offshore/RenewableEnergy/PDFs/DOI\\_FERC\\_MOU.pdf](http://www.mms.gov/offshore/RenewableEnergy/PDFs/DOI_FERC_MOU.pdf)).

MMS proposed priority issuing of limited leases for (1) data collection and technology testing activities related to current resources off the coast of Florida and (2) data collection and technology testing activities related to wave resources off the coast of Northern California (73 FR 21152; April 18, 2008). Under the interim policy, the installation of resource data collection and technology testing facilities will require MMS review of a plan describing the proposed construction, operation, and removal of the facility. A NEPA review of potential environmental impacts will be conducted for each lease, and appropriate restrictions and mitigation measures may be applied.

The Ocean Thermal Energy Act of 1980 (42 U.S.C. 9101 *et seq.*) gave NOAA lead responsibility for licensing the construction, ownership, location, and commercial operation of OTEC plants. NOAA promulgated regulations governing applications for OTEC licenses in 1981 (15 CFR Part 981), but withdrew them in 1996 due to a lack of applicants. In removing the Part 981 regulations (61 FR 21073; May 9, 1996), NOAA emphasized that the agency would continue to be responsible for licensing commercial OTEC facilities and that it would take appropriate steps to review and process applications in the future as interest in OTEC develops. OTEC would comply with the same Federal and state environmental laws as other marine and hydrokinetic energy technologies (Section 4.1). In addition, discharges from OTEC projects would be regulated under the CWS Section 402 (National Pollutant Discharge Elimination System) and 403 (Ocean Discharge Criteria Evaluations).

In summary, MMS has the responsibility for leasing the OCS for energy development, as well as permitting renewable energy technologies such as wind and solar. FERC has responsibility for the licensing of hydrokinetic energy projects in both freshwater and the OCS. These agencies will develop the final rules and guidance to help ensure sound and orderly development which include the active involvement of relevant Federal and state land and resource agencies. In addition, some states have their own procedures and regulatory processes to guide the development of energy projects. MMS leasing and FERC licensing actions will provide opportunities for public input to the environmental monitoring programs. Disclosure of non-proprietary information as part of monitoring reports will help future developers better understand the potential effects of their proposed projects and to refine their own studies, particularly if monitoring is carried out in an adaptive management context.

#### ***4.4 Environmental Monitoring***

The monitoring needed to understand and minimize environmental impacts can have either site-specific or general value (Cada *et al.* 2007). Site-specific research would typically be conducted by the manufacturer/developer and might include impacts of particular design details (e.g., comparison of the toxicity of different paints or lubricating

fluids, comparisons of noise measurements to tolerances of local fauna) or the effects on a particular river or estuary that is proposed for development (e.g., collection of sediment cores and modeling of multi-unit placement relative to a specific bottom profile). Site-specific monitoring will focus on groups of species of particular interest (e.g., endangered or threatened species or commercially and recreationally important fish and shellfish). In some cases, there is a deficiency of baseline information about the environmental resources of a proposed site, so pre-installation monitoring will be aimed at determining the occurrence of sensitive habitats and their use by species of concern.

On the other hand, many environmental questions are of general interest, and the monitoring and research to answer them might best be addressed by collaborative groups that make their results readily available to all stakeholders. Collaborative studies could include experiments to understand the impacts of hydrokinetic and wave conversion devices. Similarly, the development of generalized, predictive models to describe phenomena such as hydrodynamics or sediment transport could be made site-specific and used to inform monitoring strategies. Subsequent site monitoring could validate and strengthen the both the site-specific and general models. Both monitoring and modeling may be employed to understand project effects on plankton productivity, biodiversity, and plant and animal demography. Individual developers rarely have the resources to carry out this general research on their own, however the information that comes from such studies is often of interest to a wide audience seeking to refine their designs and operations in order to minimize environmental impacts. An important component of adaptive management (i.e., the continuing process of action, monitoring, evaluation, and adjustment) is the interpretation of site-specific monitoring results in light of more generalized, explanatory research findings. The rapid dissemination of non-proprietary information will be important for the assessment, mitigation, and adaptive management of environmental effects.

The site-specific monitoring and general research needs for new ocean energy and hydrokinetic technologies have been considered in various publications. For example, Table 2.1 of EMEC (2005) lists the detailed information that should be provided by a project proponent in order to evaluate the potential environmental effects of installation and operation at their facility off the Orkney coast. Michel and Burkhard (2007) tabulated information needs related to numerous environmental issues including EMF, noise, movements of aquatic organisms, collision, and habitat changes. Appendix 5 of Boehlert *et al.* (2008) describes recommended monitoring of a wave farm near Reedsport, Oregon. Although developed for offshore wind farms, the report by Elsam Engineering and Energi E2 (2005) describes a number of techniques for monitoring the status of marine communities. Environmental monitoring needs and techniques are considered in the individual chapters of Nelson *et al.* (2008).

The following subsections describe possible monitoring activities associated with each of the environmental issues discussed in this report. The list is not exhaustive; each site is unique and may benefit from more or less monitoring for particular environmental issues.

#### **4.4.1 Monitoring for Alteration of Currents and Waves**

In order to address the effects of energy extraction on tidal/river currents, current velocities could be measured upstream, downstream, and at the site where the devices will be installed. The monitoring locations would need to be appropriate for collecting information about water velocity changes associated with both individual units and multiple units, recognizing that a small number of units will only exhibit a small and localized impact on water velocities. Seasonal variations could be examined by making water velocity measurements over an appropriate time frame (i.e., at different river flows or over several daily and seasonal tidal cycles). For example, to evaluate the influence on tides, it would be valuable to obtain at least a 35-day record in two different seasons, both before and after installation of the turbines. After project installation has begun, the velocity measurements could be repeated with one unit in place and then again after several units have been installed.

As with current velocities, wave height measurements could be made at appropriate locations before installation of the ocean energy conversion device, then repeated after single and multiple units have been installed. Measured changes in current velocities or wave heights could be used to validate predictive models and help explain concurrent changes in sediment transport and aquatic habitats. Monitoring the effects of impact minimization and mitigation options (Section 3.1.2) would be valuable.

#### **4.4.2 Monitoring for Effects on Sediment Transport**

It is important to characterize the bottom sediments that would be disturbed by installation of the energy conversion devices and their associated cables. Pre-installation sampling can define the grain sizes, organic content and mineral content of sediments, and the presence of contaminants that might degrade water quality. Information on sediment transport dynamics would be useful for predicting the influence of altered hydrography on post-installation sediment transport and deposition. Acoustic Doppler current profiler instruments are useful for monitoring both current direction and sediment movements.

Periodic operational monitoring will be valuable for detecting changes in sediment transport and the effects of impact mitigation measures. In many cases, this will be most easily accomplished by onsite, underwater sampling and visual observations. In other instances, remote monitoring may be used to evaluate the significance of changes brought about by the energy project. For example, Elsam Engineering and Energi E2 (2005; p. 61-64) used satellite imagery to determine impacts on shoreline changes resulting from the modified wave climate created by a wind park.

#### **4.4.3 Monitoring for Effects of Benthic Habitat Alterations**

The amount of habitat for bottom-dwelling organisms that would be altered by installation and operation can be estimated from detailed descriptions of the anchoring system (e.g., number of anchors, size, construction material), the mooring system, the electrical transmission system (length and size of cables, buried or anchored on the

surface, construction materials), and the installation procedures (e.g., pile driving, trenching, boring).

Pre-installation monitoring could be used to characterize benthic habitat and predict the biological responses. Initial monitoring could include descriptions of the benthic organisms, quantification of their densities, and species richness values. Because plant and animal communities exhibit natural variations both spatially and over time, a before-after, control-impact (BACI) experimental design is often the best way to detect changes that have occurred as a result of the project. Monitoring should be frequent during the installation period, but can be less frequent during initial operations if the benthic community recovers. The potential effects on benthic habitats and benthic communities of removing intertidal energy and/or longshore wave energy could be addressed by comprehensive systems ecology modeling.

As noted in Section 3.3.2, the presence of a marine energy project may reduce fishing pressure in the immediate area, thereby serving as a *de facto* marine reserve. This may be considered a benefit of the project (by enhancing the marine organisms) or a negative impact (by eliminating areas from commercial or recreational fishing); in either case it may be desirable to evaluate the marine reserve effect with field monitoring. Halpern et al. (2004) describe mathematical models that can be used to predict fisheries benefits of marine reserves and discuss the difficulties of detecting significant effects given the uncertainties of identifying appropriate control sites and the normal interannual fluctuations in population numbers. It may be useful to design such monitoring programs so that the effects of the marine energy project could be compared with fish habitat or species assemblages in nearby marine reserves or protected areas. The cumulative effects of the *de facto* and actual marine reserves could then be assessed.

#### **4.4.4 Monitoring for Effects of Noise**

Noise impact monitoring could begin with a complete characterization of sounds produced by the energy conversion technology, including measurements of the device's acoustic signature, sound pressure levels (SPL) across the full range of frequencies. The European Marine Energy Centre (2005) suggested that the amplitude of the noise be quantified for the device as a whole (as dB re 1  $\mu$ Pa at 1 m in water or at 20 m in air) or for different parts of the device as appropriate. The relative importance of the new source of noise could be evaluated by making measurements at varying distances from the installation or operation with background noise levels included for comparison. These measurements could be performed under a variety of ocean/river conditions in order to assess how meteorological, current strength, and/or wave height conditions affect sound generation and sound masking. The effects of marine fouling on noise production, noise from any tensioned wires or other components that resonate in water, and the effects of measures to reduce noise could be measured for both individual and multiple units.

The biological response to noise generated by installation and operation can be evaluated initially by comparing the device's acoustic signature to information about the hearing sensitivity (e.g., audiograms) of exposed animals. Monitoring of fish, sea turtles, and marine mammal activity might be carried out in parallel with measurements of sound



levels (Simmonds *et al.* 2003). Visual or automated monitoring (e.g. by means of an acoustic detection system) could be implemented to investigate changes in animal behavior (e.g., avoidance, attraction, changes in schooling behavior or migration routes). Federal agencies are increasingly aware of the need to determine whether their activities generate sounds and, if so, the consequent effects on marine life. Southall *et al.* (2009) summarize ongoing marine sound research and monitoring activities by Federal agencies. The report provides an explicit interagency roadmap that agencies can use to focus and prioritize their research efforts related to human-generated sounds.

#### **4.4.5 Monitoring for Electromagnetic Fields**

It would be useful to characterize and quantify the E field, B field, and iE field because EMF associated with submarine electrical transmission cables are poorly understood (Section 3.5.1; Appendix D). Measurements could be made at various distances from the cable and at the full range of voltages and amperages that the cables will carry as additional generating units are installed. The measurements can be compared to the published electro- and magneto-sensitivity levels of aquatic organisms to evaluate whether EMF are likely to interfere with local movements or migrations. If the project incorporates networks of cables in close proximity to each other, the complex overlapping and potentially additive effects of EMF could be analyzed. Biological responses to the EMF may best be monitored by visual observations of the reactions of sensitive organisms (i.e., elasmobranchs, eels, cod, salmon, catfish) as they approach the generating device and electrical cables. More generalized research to resolve EMF issues might be based on the type of mesocosm experiments described in Gill *et al.* (2005).

#### **4.4.6 Monitoring the Toxic Effects of Chemicals**

For all chemicals associated with a project, a compilation and assessment of information regarding their toxicity to aquatic organisms should be completed. Chemicals to be examined would include hydraulic fluids and lubricating oils that may leak from the generating unit, as well as antifouling coatings that are designed to slowly release toxicants into the environment. As appropriate, the potential for bioaccumulation of toxic compounds (e.g., heavy metals, refractory organic compounds) might be considered and monitored. Screening bioassays for new chemicals could be conducted if information is lacking in the published literature about toxicity to particular species found at the project site. These might include ecotoxicology studies that consider a variety of trophic levels including bacteria, simple and complex plants, and aquatic animals.

#### **4.4.7 Monitoring Interference with Animal Movements and Migrations**

There is insufficient information about the likely effects of numerous mooring and electrical transmission lines associated with large energy conversion projects on the movements and migrations of aquatic animals. With regard to the local movements, these new structures in the pelagic zone may act as FADs and increase the abundance of fish, at least locally. Changes in numbers and relative abundance of fish populations could be monitored before and after project installation, using both control and impacted sites (i.e., a BACI experimental design). Monitoring can be used to determine how

economically important species such as albacore, rockfish, and salmon interact with floating wave energy devices, including the time frame for establishment of the fish community; temporal, and spatial dimensions of the fish community; and the population structure (Michel *et al.* 2007). Determining of the effects of FADs at a particular location is complicated by the influence of non-independent factors including the proximity of other FADs (i.e., other wave energy units), the interconnection of multiple FADs to provide routes for the movement of associated fishes, and temporal dependence (where the number of fish present at one time influences the number at the next time due to fish becoming residents). Kingsford (1999) described statistical approaches that could be applied to experiments on the effects of FADs on fish populations and solutions to the independent factor problems. Suggestions for monitoring the marine reserve effect resulting from a restriction on commercial and recreational fishing are provided in Halpern *et al.* (2004).

Effects on long distance movements and migrations are more difficult to assess, and may depend initially on telemetry studies or visual observations of the reactions of migrating animals to the energy project. The Pacific Fisheries Management Council (2008) concluded that a response protocol for entanglement of organisms in the mooring/electrical lines should be developed. Boehlert *et al.* (2008) suggested that assessment of behavioral interactions of marine mammals and sea turtles with wave energy conversion devices and cables could include development of a migration corridor model for cetaceans and pinnipeds based on tagging studies.

Desholm (2003) described a thermal camera-based monitoring system that was used to estimate collision frequency between migrating birds and the above-water structures of offshore wind turbines. The Thermal Animal Detection System was capable of recording birds approaching the rotating blades of a turbine, even under conditions with poor visibility.

#### **4.4.8 Monitoring the Effects of Strike**

Pre-installation predictions about the susceptibility of organisms to collision with project structures could be validated by operational monitoring. Monitoring of strike might be possible by visual observations, underwater video and still photography, and/or netting in shallow, clear water environments. In other settings, hydroacoustic monitoring may be needed to assess the incidence of strike. For example, both a mobile hydroacoustic fish survey and a fixed hydroacoustic transducer were employed in an attempt to detect and quantify fish strike at the Roosevelt Island Tidal Energy project (Smith 2007). As fish and other aquatic organisms passed through the turbine field, the hydroacoustic monitoring system automatically tracked and documented their location and behavior relative to the zone of risk at each turbine (BioSonics 2008). Strike will not necessarily result in injury or mortality; among other factors, strike injury is related to the velocity of impact (i.e., portion of the blade contacted) and the shape of the leading edge (Section 3.8). Consequently, it would be useful to monitor the consequences of organisms impacting the structures at different velocities and locations, including rates of injury and immediate and delayed mortalities. Techniques have been developed for monitoring the collisions of marine birds with above-water structures (Section 3.7.1).



The cavitation performance of the rotor could be established, with a view toward reducing blade erosion, noise, and injury to animals. Watten *et al.* (2006) suggested that blade performance predictions include modification to twist/pitch to account for non-uniform inflow from the tidal profile and waves, changes in blade thickness, and performance in yawed flow during tidal changes.

The risk of rotor strike from a single unit can be readily estimated for an organism in the zone of influence from information on such factors as water velocity, blade rotation rate, blade spacing, and size of the animal (Section 3.8.1). Laboratory studies could provide valuable data on the probability and effects of strike associated with various zones of passage through hydrokinetic turbines, and these predictions can be verified by operational monitoring. However, estimates of the probability of strike for a large project with hundreds of closely spaced rotors have not yet been calculated. Data on animals' migratory paths, preferred depths, diurnal activity, and attraction or repulsion by the project structures might be used to locate projects away from sensitive areas. Monitoring passage of marine organisms through the entire ocean energy project would be needed to resolve uncertainties of cumulative risk of strike from multiple units.

#### **4.4.9 Monitoring of OTEC Projects**

Prior to construction of the OTEC project, data on the vertical distribution of aquatic organisms, especially the eggs and larvae of fish and shellfish, would allow predictions of the susceptibility of aquatic organisms to entrainment in both the cold and warm water intakes (Meyer *et al.* 1986). In addition, data could be collected to support predictive modeling of the fate of the discharge plume in order to avoid secondary entrainment of marine organisms, maximize dilution and dissipation of biocides, and/or enhance the redistribution of nutrients from deep waters (if desired). It will be important to evaluate the toxicity of working fluids, corroded metals, and biocides, as well as the fate of dissolved gases and nutrients from the cold water discharge. Subsequent operational monitoring could be used to validate the predictions about entrainment, discharge plume effects, and chemical toxicity.

#### **4.4.10 Monitoring for Cumulative Impacts of Multiple Units and Multiple Energy Projects**

Beyond the environmental evaluations of individual machines, concerns have been expressed about both multiple-unit deployments and the cumulative impacts of energy developments when added to other stresses on aquatic systems (Resolve, Inc. 2005). In order for these technologies to make a significant contribution to electricity supply, larger devices or installations of many units will be needed. For example, Williams (2005) suggested that 3,000 to 4,000 open center turbines could be deployed in the Gulf Stream to provide a generation potential of 10,000 MW of electricity. The effects of above water structures on wind and wave heights (Section 3.1.1) might be exacerbated where both wind turbines and floating wave energy converters are combined in the same project. Impacts to bottom habitats, hydrology, or strike that are inconsequential for one or a few units may become significant if energy farms exploit large areas in a river, estuary, or

nearshore ocean. By extracting energy from currents, very large installations might conceivably influence large-scale ocean circulation patterns. It may not be easy to extrapolate effects from small to large numbers of units because the complicated interactions between water motions and turbines depend on placement of the machines (proximity to each other), as well as local hydraulic conditions. Hydrodynamic models will be needed to predict the effects of multiple units.

The deployment of turbines could add to existing environmental stresses and cumulative effects. In rivers, the effects of hydrokinetic turbines could occur in the context of other impacts associated with boat traffic, water withdrawals, and discharges. In the ocean, energy developments must compete with aquaculture; offshore wind, gas, and oil platforms; defense-related activities; mining; merchant shipping; recreational and commercial fishing; and recreational boating (Ogden 2005). Perhaps the most sensitive habitats to cumulative impacts are estuaries, highly complex and productive ecosystems that are already subject to anthropogenic alteration from water diversion, habitat conversion, pollution, dredging, and urbanization (Swanson 2005). As with other cumulative effects, the contribution of new energy developments to overall impacts on aquatic resources could be additive, synergistic, or offsetting. Predictive models and monitoring techniques would need to be developed to understand and resolve the environmental impacts of large energy projects.

Adequate understanding of the environmental effects of ocean energy and hydrokinetic devices is essential to their acceptance by regulators and the public (Resolve, Inc. 2005). In the initial installations of these new technologies, a proportional response from regulators is appropriate – small deployments are likely to have small, localized impacts. Small-scale monitoring programs would help resolve issues of individual installations and, if results are disseminated, would help focus the more extensive monitoring that would be needed for large deployments. At this early stage of technology development, both regulators and developers need to be open to an adaptive management approach, in which predictive modeling, environmental monitoring, and phased deployment are adjusted to reflect the findings of the previous monitoring (Cada *et al.* 2007). The process of collecting environmental effects data might be guided by what is needed to achieve the ultimate goal of full-sized, multi-unit projects. It is also important that developers realize that a “disassembly plan” may be required in the event that environmental impacts of a project cross a previously defined threshold for significant environmental impacts. Project licensing should include an assessment of the impacts and ease of decommissioning.

## 5 Conclusions

Few marine and hydrokinetic renewable energy technologies have been tested at full scale, and it is therefore difficult to resolve all of the uncertainties about their specific environmental effects. Relevant information is available in the scientific literature on potential effects, some of which reference other developments in marine environments such as oil and gas wells and undersea cables. Assessment methods, such as ecological risk assessment, are available to identify and evaluate adverse impacts, and mitigation practices have been established to address many of these risks. Quantitative environmental impact assessment techniques, combined with environmental effects monitoring, mechanistic and predictive modeling, and adaptive management are tools that can be applied to reduce risks and uncertainties of impacts.

There are numerous conceptual designs for converting the energy of waves, river and tidal currents, and ocean temperature differences into electricity. The DOE database described in Appendix B lists well over 100 ocean energy and hydrokinetic renewable energy technologies. Most of these technologies remain at the conceptual stage – they have not yet been tested in the field or as prototype, full-scale devices. Consequently, there have been few studies of their environmental effects. Most considerations of the environmental impacts have been in the form of predictive studies and environmental assessments that have not yet been verified.

The assessments identified common elements among these technologies that may pose a risk of adverse environmental effects. These potential impacts include the alteration of currents and waves; alteration of substrates and sediment transport and deposition; alteration of habitats for benthic organisms; noise during construction and operation; emission of electromagnetic fields; toxicity of paints, lubricants, and antifouling coatings; interference with animal movements and migrations; and strike by rotor blades or other moving parts. In the case of OTEC, additional potential impacts stem from the intake and discharge of large volumes of sea water, temperature and other water quality changes, and entrainment of aquatic organisms into the intake and discharge plume. A sense of the significance of each of these issues can be gained from published literature related to other technologies (e.g., noises generated by similar marine construction activities, EMF emissions from existing submarine cables, and environmental monitoring of active offshore wind farms). Experience with other, similar activities in freshwater and marine systems will also provide clues to effective impact minimization and mitigation options that can be applied to these devices.

Some aspects of the environmental impacts are unique to the technologies and require operational studies to determine the seriousness of the effects and best mitigation options. This is particularly true for the cumulative effects of large numbers of ocean energy or hydrokinetic devices that would comprise fully built-out projects. For example, there is no existing analogous situation that allows a confident *a priori* evaluation of the risk of strike from passage through a field of hundreds of horizontal axis turbines or of the biological effects of EMF or noise from a network of generating devices with a matrix of

electrical cables in the water column and/or along the bottom. Assessment of these effects would require careful environmental monitoring as the projects are deployed.

Modification of the project in order to mitigate unacceptable environmental impacts identified by operational monitoring might be based on the application of adaptive management principles incorporated into the project license conditions. Early information about undesirable outcomes could lead to the implementation of additional minimization or mitigation actions which could be subsequently re-evaluated. The review of the scientific literature shows that an adaptive management process has a valuable role in the early stages of technology development, when many of the potential environmental effects are unknown for individual units, much less the build-out of large-scale projects.

FERC, the Federal agency with primary responsibility for licensing marine and hydrokinetic energy projects, has rules and guidance to help ensure sound and orderly development. This Federal agency and others that provide input to the license conditions promote adaptive management as a tool to resolve uncertainties about environmental effects. The adaptive management components contained in the project licenses can be tailored to the particular technologies and unique environmental settings. Basing the project licenses and environmental monitoring programs on adaptive management principles, as advocated by many resource and regulatory agencies, would take advantage of ongoing research and monitoring to help refine technology designs and to improve environmental acceptability of future installations. Environmentally sound development of ocean and hydrokinetic renewable energy technologies would not only benefit from the dissemination of information from site-specific monitoring of existing installations, but also from generalized research to understand the nature and severity of impacts associated with particular stressors common to many technologies.

## 6 Literature Cited

Abaza, H., R. Bisset, and B. Sadler. 2004. Environmental Impact Assessment and Strategic Environmental Assessment: Towards an Integrated Approach. United Nations Environment Programme. Geneva, Switzerland. 163 p. <http://www.unep.ch/etb/publications/EnvImpAss/textONUBr.pdf> (accessed November 11, 2008).

Abbasi, S.A. and N. Abbasi. 2000. The likely adverse environmental impacts of renewable energy sources. *Applied Energy* 65:121-144.

Amaral, S.V., G.E. Hecker, P. Stacy, and D.A. Dixon. 2008. Effects of leading edge turbine blade thickness on fish strike survival and injury. *Proceedings of HydroVision 2008*. HCI Publications, St. Louis, Missouri.

Andrzejewicz, E. D. Napierska, and Z. Otremba. 2003. The environmental effects of the installation and functioning of the submarine *SwePol Link* HVDC transmission line: a case study of the Polish Marine Area of the Baltic Sea. *Journal of Sea Research* 49 (2003): 337-345.

Antizar-Ladislao, B. 2008. Environmental levels, toxicity, and human exposure to tributyltin (TBT)-contaminated marine environment. A review. *Environment International* 34 (2008):292-308.

AquaEnergy, Ltd. 2006. Makah Bay Offshore Wave Energy Pilot Project: FERC Docket No. 12751. Preliminary Draft Environmental Assessment. November 8, 2006. 179 pp.

Arenas, P. and M. Hall. 1992. The association of sea turtles and other pelagic fauna with floating objects in the eastern tropical Pacific Ocean. P. 7-10 IN: M. Salmon and J. Wyneken (compilers). *Proceedings of the Eleventh Annual Workshop on Sea Turtle Biology and Conservation*. U.S. Department of Commerce, NOAA Technical Memorandum NMFS-SEFSC-302. <http://www.nmfs.noaa.gov/pr/pdfs/species/turtlesymposium1991.pdf> (accessed November 6, 2008).

ASR, Ltd. 2007. Review of Wave Hub Technical Studies: Impacts on Inshore Surfing Beaches. Version 3. Final Report to South West of England Regional Development Agency, Sutton Harbor, Plymouth, United Kingdom. <http://www.sas.org.uk/pr/2007/docs07/Review-of-Wave-Hub-Technical-Studies-Apr-071.pdf> (accessed January 9, 2009).

Avens L, and K.J. Lohmann. 2003. Use of multiple orientation cues by juvenile loggerhead sea turtles, *Caretta caretta*. *The Journal of Experimental Biology* 206:4317-4325.

Bahaj, A.S., A.F. Molland, J.R. Chaplin, and W.M.J. Batten. 2007. Power and thrust measurement of marine current turbines under various hydrodynamic flow conditions in a cavitation tunnel and a towing tank. *Renewable Energy* 32:407-426.

Balayev, L.A. and N.N. Fursa. 1980. The behavior of ecologically different fish in electric fields I. Threshold of first reaction in fish. *Journal of Ichthyology* 20(4): 147-152.

Basov, B.M. 1999. Behavior of sterlet *Acipenser ruthenus* and Russian sturgeon *A. gueldenstaedtii* in low-frequency electric fields. *Journal of Ichthyology* 39(9):782-787.

Basov, B.M. 2007. On electric fields of power lines and on their perception by freshwater fish. *Journal of Ichthyology* 47(8):656-661.

Bedard, R. 2005. Hydrokinetic energy “lay of the land.” Proceedings of the Hydrokinetic and Wave Energy Technologies Technical and Environmental Issues Workshop. October 26-28, 2005. Washington, DC. [http://hydropower.id.doe.gov/hydrokinetic\\_wave/index.shtml](http://hydropower.id.doe.gov/hydrokinetic_wave/index.shtml) (accessed October 7, 2008).

Bedard, R., M. Previsic, G. Hagerman, B. Polagye, W. Musial, J. Klure, A. von Jouanne, U. Mathur, C. Collar, C. Hopper, and S. Amsden. 2007. North American Ocean Energy Status – March 2007. Proceedings of the 7<sup>th</sup> European Wave and Tidal Energy Conference, Porto, Portugal. September 11-14, 2007. <http://oceanenergy.epri.com/oceanenergy.html#briefings> (accessed January 8, 2009).

Betke, K., M. Schultz-von Glahn, and R. Matuschek. 2004. Underwater noise emissions from offshore wind turbines. Proceedings of the Joint Congress of CFA/DAGA '04. Strasbourg, France. <http://www.itap.de/daga04owea.pdf> (accessed June 18, 2008).

Bevanger, K. 1998. Biological and conservation aspects of bird mortality caused by electricity power lines: A review. *Biological Conservation* 86(1):67-76.

BioSonics. 2008. BioSonics Pioneers Environmental Monitoring for the Tidal Power Industry. [http://www.biosonicsinc.com/resources/monitoring\\_tidal\\_power.html](http://www.biosonicsinc.com/resources/monitoring_tidal_power.html) (accessed October 7, 2008).

Blanchfield, J., A. Rowe, P. Wild, and C. Garrett. 2007. The power potential of tidal streams including a case study for Masset Sound. Proceedings of the 7<sup>th</sup> European Wave and Tidal Energy Conference. Porto, Portugal. 10 p.

Blyth, R.E., M.J. Kaiser, G. Edwards-Jones, and P.J.B. Hart. 2004. Implications of a zoned fishery management system for marine benthic communities. *Journal of Applied Ecology* 41:951-961.

Blyth-Skyrme, R.E., M.J. Kaiser, J.G. Hiddink, G. Edwards-Jones, and P.J.B. Hart. 2006. Conservation benefits of temperate marine protected areas: variation among fish species. *Conservation Biology* 20(3):811-820.

Bochert R. and M.I. Zettler. 2006. Effect of electromagnetic fields on marine organisms. Chapter 14 in: *Offshore Wind Energy*. J. Koller, J. Koppel, and W. Peters (eds.). Springer-Verlag, Berlin.

Boehlert, G.W., G.R. McMurray, and C.E. Tortorici (eds.). 2008. *Ecological Effects of Wave Energy Development in the Pacific Northwest*. U.S. Department of Commerce, NOAA Technical Memorandum NMFS-F/SPO-92. 174 p.

Boles, L.C. and K.J. Lohmann. 2003. True navigation and magnetic maps in spiny lobsters. *Nature* 421:60-63.

Bryden, I.G., T. Grinstead, and G.T. Melville. 2004. Assessing the potential of a simple tidal channel to deliver useful energy. *Applied Ocean Research* 26:198-204.

Buigues, G. I., Zamora, A.J. Mazon, V. Valverde, and F.J. Perez. 2006. Sea energy conversion: problems and possibilities. *The International Conference on Renewable Energies and Power Quality (ICREPQ '06)*. 8 p. <http://www.icrepq.com/icrepq06/242-buigues.pdf> (accessed June 4, 2008).

Cada, G. F. 1990. A review of studies related to the effects of propeller-type turbine passage on fish early life stages. *North American Journal of Fisheries Management* 10(4):418-426.

Cada, G.F., C.C. Coutant, and R.R. Whitney. 1997. *Development of Biological Criteria for the Design of Advanced Hydropower Turbines*. DOE/ID-10578. U.S. Department of Energy, Idaho Operations Office, Idaho Falls, ID. 85 p.

Cada, G.F., J. Smith, and J. Busey. 2005. Use of pressure sensitive film to quantify sources of injury to fish. *North American Journal of Fisheries Management* 25(2):57-66.

Cada, G.F., J.M. Loar, L. Garrison, R.K. Fisher, and D. Neitzel. 2006. Efforts to reduce mortality to hydroelectric turbine-passed fish: Locating and quantifying damaging shear stresses. *Environmental Management* 37(6):898-906.

Cada, G.F., J. Ahlgrimm, M. Bahleda, T. Bigford, S. Damiani Stavrakas, D. Hall, R. Moursund, and M. Sale. 2007. Potential impacts of hydrokinetic and wave energy conversion technologies on aquatic environments. *Fisheries* 32(4):174-181.

Cain, S.D., L.C. Boles, J.H. Wang, and K.J. Lohmann. 2005. Magnetic orientation and navigation in marine turtles, lobsters, and molluscs: concepts and conundrums. *Integrative and Comparative Biology* 45:539-546.

Caltrans. 2001. *Fisheries Impact Assessment. Pile Installation Demonstration Project. San Francisco-Oakland Bay Bridge East Span Seismic Safety Project*. PIDP EA 012081. 59 p. [http://www.biomitigation.org/reports/files/PIDP\\_Fisheries\\_Impact\\_Assessment\\_01240.pdf](http://www.biomitigation.org/reports/files/PIDP_Fisheries_Impact_Assessment_01240.pdf) (accessed February 17, 2009).

Carr, M.H. and M.A. Hixon. 1997. Artificial reefs: The importance of comparisons with natural reefs. *Fisheries* 22(4):28-33.

Carstensen, J., O.D. Henriksen, and J. Teilmann. 2006. Impacts of offshore wind farm construction on harbor porpoises: acoustic monitoring of echolocation activity using porpoise detectors (T-PODSs). *Marine Ecology Progress Series* 321:295-308.

Castro, J.J., J.A. Santiago, and A.T. Santana-Ortega. 2002. A general theory on fish aggregation to floating objects: An alternative to the meeting point hypothesis. *Reviews in Fish Biology and Fisheries* 11:255-277.

Caswell, H., M. Fujiwara, and S. Brault. 1999. Declining survival probability threatens the North American right whale. *Proceedings of the National Academy of Science USA*. 96:3308-3313.

CEQ (Council on Environmental Quality). 2003. Modernizing NEPA Implementation. The NEPA Task Force Report to the Council on Environmental Quality. September 2003. <http://ceq.hss.doe.gov/ntf/report/index.html> (accessed December 9, 2008).

CEQ (Council on Environmental Quality). 2007. Aligning National Environmental Policy Act Processes with Environment Management Systems. A Guide for NEPA and EMS Practitioners. April 2007. [http://www.fedcenter.gov/\\_kd/Items/actions.cfm?action=Show&item\\_id=6899&destination=ShowItem](http://www.fedcenter.gov/_kd/Items/actions.cfm?action=Show&item_id=6899&destination=ShowItem) (accessed December 9, 2008).

CMACS (Centre for Marine and Coastal Studies). 2003. A Baseline Assessment of Electromagnetic Fields Generated by Offshore Windfarm Cables. COWRIE Report EMF-01-2002 66. Liverpool, UK. <http://www.offshorewind.co.uk> (accessed August 20, 2008).

Coleman, F.C., C.C. Koenig, and L.A. Collins. 1996. Reproductive styles of shallow-water groupers (Pisces: Serranidae) in the eastern Gulf of Mexico and the consequences of fishing spawning aggregations. *Environmental Biology of Fishes* 47:129-141.

Colin, P.L. 1992. Reproduction of the Nassau grouper, *Epinephrus striatus* (Pisces: Serranidae) and its relationship to environmental conditions. *Environmental Biology of Fishes* 34:357-377.

Collin, S.P. and D. Whitehead. 2004. The functional roles of passive electroreception in non-electric fishes. *Animal Biology* 54(1):1-25.

Coston-Clements, L., L.R. Settle, D.E. Hoss, and F.A. Cross. 1991. Utilization of the *Sargassum* Habitat by Marine Invertebrates and Vertebrates – A Review. NOAA Technical Memorandum NMFS-SEFSC-296. National Marine Fisheries Service, Southeast Fisheries Science Center, Beaufort, SC. 32 p. <http://www.aoml.noaa.gov/general/lib/seagrass.html> (accessed February 13, 2009).



Coutant, C.C. and G.F. Cada. 2005. What's the future of instream hydro? *Hydro Review* XXIV(6):42-49.

Craig, C., S. Wyllie-Escheverria, E. Carrington, and D. Shafer. 2008. Short-term sediment burial effects on the seagrass *Phyllospadix scouleri*. EMRPP Technical Notes Collection (ERDC TN-EMRRP-EI-03). Vicksburg, MS: U.S. Army Engineer Research and Development Center. 10 p.

Crawford, R.E. and C.G. Carey. 1985. Retention of winter flounder larvae with a Rhode Island salt pond. *Estuaries* 8(2B):217-227.

Cushing, D.H. 1969. The regularity of spawning season of some fishes. *Journal du Conseil – Conseil International pour l'Exploration de la Mer* 33(1):81-92.

Dadswell, M.J., R.J. Klauda, C.M. Moffitt, R.L. Saunders, R.A. Rulifson, J.E. Cooper. 1987. Common Strategies of Anadromous and Catadromous Fishes. American Fisheries Society Symposium 1, Bethesda, MD.

Davis, N., G.R. VanBlaricom, and P.K. Dayton. 1982. Man-made structures on marine sediments: effects on adjacent benthic communities. *Marine Biology* 70:295-303.

Davison, A. and T. Mallows. 2005. Strangford Lough Marine Current Turbine Environmental Statement (Non-Technical Summary). Project No. 9P5161. Royal Haskoning Ltd., Edinburgh, UK.

de Jong, D.J., Z. de Jong, and J.P.M. Mulder. 1994. Changes in area, geomorphology, and sediment nature of salt marshes in the Oosterschelde estuary (SW Netherlands) due to tidal changes. *Hydrobiologia* 282/283:303-316.

Dempster, T. 2005. Temporal variability of pelagic fish assemblages around fish aggregation devices: biological and physical influences. *Journal of Fish Biology* 66:1237-1260.

Dempster, T. and M. Taquet. 2004. Fish aggregation device (FAD) research: gaps in current knowledge and future directions for ecological studies. *Reviews in Fish Biology and Fisheries* 14:21-42.

Deng, D.L., T.J. Carlson, G.R. Ploskey, and M.C. Richmond. 2005. Evaluation of Blade-Strike Models for Estimating the Biological Performance of Large Kaplan Turbines. PNNL-15370. Pacific Northwest National Laboratory, Richland, WA.

Desholm, M. 2003. Thermal Animal Detection System (TADS). Development of a method for estimating collisions frequency of migrating birds at offshore wind turbines. NERI Technical Report No. 440. National Environmental Research Institute, Denmark. 27 p. [http://www2.dmu.dk/1\\_Viden/2\\_Publikationer/3\\_fagrappporter/rappporter/FR440.pdf](http://www2.dmu.dk/1_Viden/2_Publikationer/3_fagrappporter/rappporter/FR440.pdf)

Desholm, M. 2006. Wind farm related mortality among avian migrants. A remote sensing study and modeling analysis. Ph.D. Thesis. Department of Wildlife Ecology and Biodiversity, University of Copenhagen. 132 p. [http://www2.dmu.dk/Pub/phd\\_mde.pdf#page=27](http://www2.dmu.dk/Pub/phd_mde.pdf#page=27)

DiBacco, C., D. Sutton, and L. McConnico. 2001. Vertical migration behavior and horizontal distribution of brachyuran larvae in a low-inflow estuary: Implications for bay-ocean exchange. *Marine Ecology Progress Series* 217:191-206.

DOI (U.S. Department of the Interior). 2007. Adaptive Management. Order No. 3270. March 9, 2007.

DOI (U.S. Department of the Interior). 2008. Adaptive Management Implementation Policy. 522 DM 1. February 1, 2008. [http://elips.doi.gov/app\\_DM/act\\_getfiles.cfm?relnum=3786](http://elips.doi.gov/app_DM/act_getfiles.cfm?relnum=3786) (accessed 10/22/08).

Domeier, M.L. and P.L. Colin. 1997. Tropical reef fish spawning aggregations: defined and reviewed. *Bulletin of Marine Science* 60(3):698-726.

DON (U.S. Department of the Navy). 2003. Environmental Assessment – Proposed Wave Energy Technology Project. Marine Corps Base Hawaii, Kaneohe Bay, Hawaii. Office of Naval Research.

Efroymsen, R.A., J.P. Nicolette, and G.W. Suter II. 2004. A framework for net environmental benefit analysis for remediation or restoration of contaminated sites. *Environmental Management* 34(3):315-331.

Elsam Engineering and Energi E2. 2005. The Danish Offshore Wind Farm Demonstration Project: Horns Rev and Nysted Offshore Wind Farms. Environmental Impact Assessment and Monitoring. Review Report 2004. 135 p. <http://www.hornsrev.dk/Miljoeforhold/miljoerapporter/review%20rapport%202004%20version0.pdf> (accessed August 19, 2008).

EMEC (European Marine Energy Centre). 2005. Environmental Impact Assessment (EIA) Guidance for Developers at the European Marine Energy Centre. Revision 0, March 2005. [http://www.emec.org.uk/emec\\_documents.asp](http://www.emec.org.uk/emec_documents.asp) (accessed October 6, 2008).

Enger, P.S., L. Kristensen, and O. Sand. 1976. The perception of weak electric d.c. currents by the European eel (*Anguilla anguilla*). *Comparative Biochemistry and Physiology* 54A:101-103.

EPA (U.S. Environmental Protection Agency). 1998. Guidelines for Ecological Risk Assessment. EPA/630/R-95/002F. April 1998. Washington, DC. <http://www.epa.gov/pesticides/ecosystem/ecorisk.htm> (accessed October 28, 2008).

- Epifanio, C.E. 1988. Transport of invertebrate larvae between estuaries and the continental shelf. Chapter 10 in Larval Fish and Shellfish Transport Through Inlets. American Fisheries Society Symposium 3: 104-114.
- EPRI. 2008. Evaluation of the Effects of Turbine Blade Leading Edge Design on Fish Survival. Report No. 1014937, Electric Power Research Institute, Palo Alto, CA. 94 p.
- FAA (Federal Aviation Administration). 2004. Environmental Management Systems and NEPA Adaptive Management. May 2004. <http://www.faa.gov/regulations%5Fpolicies/policy%5Fguidance/envir%5Fpolicy/> (accessed April 9, 2008).
- Faber Maunsell and Metoc. 2007. Scottish Marine SEA: Environmental Report Section C. Chapter C9: Marine Mammals. Scottish Executive. 42 p. + figures.
- Fast, A.W., F.M. D'Itri, D.K. Barclay, S.A. Katase, and C. Madenjian. 1990. Heavy metal content of coho *Onchorhynchus kisutch* and Chinook salmon *O. tshawytscha* reared in deep upwelled ocean waters in Hawaii. Journal of the World Aquaculture Society 21(4):271-276.
- FERC (Federal Energy Regulatory Commission). 2007. Makah Bay Offshore Energy Pilot Project. FERC Docket No. 12751-000. Environmental Assessment for Hydropower License. FERC Office of Energy Projects, Washington, DC. 175 p.
- FERC (Federal Energy Regulatory Commission). 2008. Licensing Hydrokinetic Pilot Projects. April 14, 2008. <http://www.ferc.gov/industries/hydropower/indus-act/hydrokinetics.asp> (accessed November 13, 2008).
- Fernandez, A., J.F. Edwards, F. Rodriguez, A. Espinosa de los Monteros, P. Harraez, P. Castro, J.R. Jaber, V. Martin, and M. Arbelo. 2005. "Gas and fat embolic syndrome" involving a mass stranding of beaked whales (Family Ziphiidae) exposed to anthropogenic sonar signals. Veterinary Pathology 42:446-457.
- Forbes, V.E. and P. Calow. 2002. Applying weight-of-evidence on retrospective ecological risk assessment when quantitative data are limited. Human and Ecological Risk Assessment 8(7):1625-1639.
- Fraenkel, P.L. 2006. Tidal current energy technologies. Ibis 148:145-151.
- Fraenkel, P.L. 2007a. Marine current turbines: Pioneering the development of marine kinetic energy converters. Proceedings of the Institution of Mechanical Engineers, Part A: Journal of Power and Energy. 221(2):159-169.
- Fraenkel, P.L. 2007b. Marine current turbines: Moving from experimental test rigs to a commercial technology. 26<sup>th</sup> International Conference on Offshore Mechanics & Arctic Engineering. ASME-OMAE07. 10 p.

FWS (U.S. Fish and Wildlife Service). 1993. Mitigation Policy. 501 FW 2. February 24, 1993. <http://www.fws.gov/policy/501fw2.html> (accessed 10/22/08).

FWS (U.S. Fish and Wildlife Service). 2005. Habitat Conservation Plans, Working Together for Endangered Species. March 2005. <http://www.fws.gov/endangered/pubs/HCPBrochure/HCPsWorkingTogether5-2005web%20.pdf> (accessed 10/21/08).

FWS/NOAA (U.S. Fish and Wildlife Service and National Oceanic and Atmospheric Administration). 2000a. Addendum to the HCP Handbook Questions and Answers. May 2000. [http://www.fws.gov/endangered/pdfs/HCP/Final\\_Addendum\\_QandA.pdf](http://www.fws.gov/endangered/pdfs/HCP/Final_Addendum_QandA.pdf) (accessed 10/21/08).

FWS/NOAA (U.S. Fish and Wildlife Service and National Oceanic and Atmospheric Administration). 2000b. Availability of a Final Addendum to the Handbook for Habitat Conservation Planning and Incidental Take Permitting Process; Notice. June 1, 2000. 65 FR 35241-35257. [http://www.fws.gov/endangered/pdfs/HCP/final\\_notice.pdf](http://www.fws.gov/endangered/pdfs/HCP/final_notice.pdf) (accessed 10/21/08).

Gell, F.R. and C. M. Roberts. 2003. Benefits beyond boundaries: the fishery effects of marine reserves. *Trends in Ecology and Evolution* 18(9):448-455.

Genzer, J. and K. Efimenko. 2006. Recent developments in superhydrophobic surfaces and their relevance to marine fouling: a review. *Biofouling* 22(5):339-360.

Gill, A.B. 2005. Offshore renewable energy: ecological implications of generating electricity in the coastal zone. *Journal of Applied Ecology* 42:605-615.

Gill, A.B. and H. Taylor. 2002. The potential effects of electromagnetic fields generated by cabling between offshore wind turbines upon elasmobranch fishes. Report to the Countryside Council for Wales (CCW Contract Science Report No. 488). 60 p.

Gill, A.B., I. Gloyne-Phillips, K.J. Neal, and J.A. Kimber. 2005. The Potential Effects of Electromagnetic Fields Generated by Sub-Sea Power Cables Associated with Offshore Wind Farm Developments on Electrically and Magnetically Sensitive Marine Organisms – A Review. COWRIE Report EM Field 2-06-2004. <http://www.offshorewind.co.uk> (accessed May 1, 2008).

Goff, M., M. Salmon, and K.J. Lohmann. 1998. Hatchling sea turtles use surface waves to establish a magnetic compass direction. *Animal Behavior* 55:69-77.

Gordon, J., D. Thompson, D. Gillespie, M. Lonergan, S. Calderan, B. Jaffey, and V. Todd. 2007. Assessment of the potential for acoustic deterrents to mitigate the impact on marine mammals of underwater noise arising from the construction of offshore windfarms. COWRIE DETER-01-2007. July 2007. 71 p. <http://www.offshorewindfarms.co.uk/Pages/Publications> (accessed August 7, 2008).

Gould, J.L. 1984. Magnetic field sensitivity in animals. *Annual Reviews in Physiology* 46:585-598.

Griffiths, J. 2005. European Marine Energy Centre. Pages 80-84 in *Proceedings of the Hydrokinetic and Wave Energy Technologies Technical and Environmental Issues Workshop*. U.S. Department of Energy, Washington, DC. [http://hydropower.id.doe.gov/hydrokinetic\\_wave/index.shtml](http://hydropower.id.doe.gov/hydrokinetic_wave/index.shtml) (accessed October 7, 2008).

Grossman, G.D., G.P. Jones, and W.J. Seaman, Jr. 1997. Do artificial reefs increase regional fish production? A review of existing data. *Fisheries* 22(4):17-23.

Hackett, S.C. 2008. Economic and Social Considerations for Wave Energy Development in California. Chapter 2 In: Nelson, P.A., D. Behrens, J. Castle, G. Crawford, R.N. Gaddam, S.C. Hackett, J. Largier, D.P. Lohse, K.L. Mills, P.T. Raimondi, M. Robart, W.J. Sydeman, S.A. Thompson, and S. Woo. 2008. *Developing Wave Energy in Coastal California: Potential Socio-Economic and Environmental Effects*. California Energy Commission, PIER Energy-Related Environmental Research Program & California Ocean Protection Council CEC-500-2008-083. [http://www.resources.ca.gov/copc/docs/ca\\_wec\\_effects.pdf](http://www.resources.ca.gov/copc/docs/ca_wec_effects.pdf) (accessed November 19, 2008).

Halpern, B.S., S.D. Gaines, and R.R. Warner. 2004. Confounding effects of the export of production and the displacement of fishing effort from marine reserves. *Ecological Applications* 14(4):1248-1256.

Hamilton, W.S. 1983. Preventing cavitation damage to hydraulic structures. Part one. *Water Power and Dam Construction*. November, 1983. p. 48-53.

Harrison, J.T. 1987. The 40 MWe OTEC Plant at Kahe Point, Oahu, Hawaii: A Case Study of Potential Biological Impacts. NOAA Technical Memorandum NMFS NOAA-TM-NMFS-SWFC-68. Southwest Fisheries Center, Honolulu, HI. 105 p.

Hastings, M.C. and A.N. Popper. 2005. Effects of Sound on Fish. Report to California Department of Transportation. January 28, 2005. 82 p. [http://www.dot.ca.gov/hq/env/bio/files/Effects\\_of\\_Sound\\_on\\_Fish23Aug05.pdf](http://www.dot.ca.gov/hq/env/bio/files/Effects_of_Sound_on_Fish23Aug05.pdf) (accessed August 7, 2008).

Heydt, G.T. 1993. An assessment of ocean thermal energy conversion as an advanced electric generation methodology. *Proceedings of the Institute of Electrical and Electronics Engineers* 81(3):409-418.

Holdren, J.P., G. Morris, and I. Mintzer. 1980. Environmental aspects of renewable energy sources. *Annual Review of Energy* 5:241-291.

IAIA (International Association for Impact Assessment). 2002. Strategic Environmental Assessment Performance Criteria. Special Publication Series No. 1. 1 p. <http://www.iaia.org/modx/assets/files/sp1.pdf> (accessed November 11, 2008).

Irwin, W.P. and K.J. Lohmann. 1996. Disruption of magnetic orientation in hatchling loggerhead sea turtles by pulsed magnetic fields. *Journal of Comparative Physiology A* 191:475-480.

ISO (International Organization for Standardization). 2004. ISO 14001:2004. Environmental Management Systems – Requirements with Guidance for Use. [http://www.iso.org/iso/iso\\_14000\\_essentials](http://www.iso.org/iso/iso_14000_essentials) (accessed April 9, 2008).

Janota, C.P. and D.E. Thompson. 1983. Waterborne noise due to ocean thermal energy conversion plants. *Journal of the Acoustic Society of America* 74(1):256-266.

Jennings, S., J.K. Pinnegar, N.V.C. Polunin, and K.J. Warr. Impacts of trawling disturbance on the trophic structure of benthic invertebrate communities. *Marine Ecology Progress Series* 213:127-142.

Johnsen, S. and K.J. Lohmann. 2005. The physics and neurobiology of magnetoreception. *Neuroscience* 6:703-712.

Johnsen, S. and K.J. Lohmann. 2008. Magnetoreception in animals. *Physics Today*. 61(3):29-35.

Johnson, A., G. Salvador, J. Kenney, J. Robbins, S. Kraus, S. Landry, and P. Clapham. 2005. Fishing gear involved in entanglements of right and humpback whales. *Marine Mammal Science* 21(4):635-645.

Johnson, M.R., C. Boelke, L.A. Chiarella, P.D. Colosi, K. Greene, K. Lellis-Dibble, H. Ludemann, M. Ludwig, S. McDermott, J. Ortiz, D. Rusanowsky, M. Scott, and J. Smith. 2008. Impacts to Marine Fisheries Habitat from Nonfishing Activities in the Northeastern United States. NOAA Technical Memorandum NMFS-NE-209. U.S. Department of Commerce, National Marine Fisheries Service, Gloucester, MA. 322 p. <http://www.nefsc.noaa.gov/nefsc/publications/tm/tm209/tm209.pdf> (accessed February 12, 2009).

Kaiser, M.J., F.E. Spence, and P.J.B. Hart. 2000. Fishing-gear restrictions and conservation of benthic habitat complexity. *Conservation Biology* 14(5):1512-1525.

Kaiser, M.J. 2005. Are marine protected areas a red herring or fisheries panacea. *Canadian Journal of Fisheries and Aquatic Sciences* 62:1194-1199.

Kalmijn, A.T. 1982. Electric and magnetic field detection in elasmobranch fishes. *Science* 218(4575):916-918.

Kalmijn, A.T. 2000. Detection and processing of electromagnetic and near-field acoustic signals in elasmobranch fishes. *Philosophical Transactions of the Royal Society of London B*. 355:1135-1141.

Karsten, R.H., J.M. McMillan, M.J. Lickley, and R.D. Haynes. 2008. Assessment of tidal current energy in the Minas Passage, Bay of Fundy. *Proceedings of the Institution of Mechanical Engineers. Part A: Journal of Power and Energy* 222(5):493-507.

Kingsford, M.J. 1999. Fish attraction devices (FADs) and experimental designs. *Scientia Marina* 63(3-4):181-190.

Kirke, B.K. 2006. *Developments in Ducted Water Turbines*. Cyberiad. Adelaide, Australia. 12 p. <http://www.cyberiad.net/tide.htm> (accessed June 5, 2008).

Kogan, I., C.K. Paull, L.A. Kuhnz, E.J. Burton, S. Von Thun, H.G. Greene, and J.P. Barry. 2006. ATOC/Pioneer Seamount cable after 8 years on the seafloor: Observations, environmental impact. *Continental Shelf Research* 26 (2006):771-787.

Koschinski, S., B.M. Kulik, O.D. Henriksen, N. Tregenza, G. Ellis, C. Jansen, and G. Kathe. 2003. Behavioural reactions of free-swimming porpoises and seals to the noise of a simulated 2 MW windpower generator. *Marine Ecology Progress Series* 265:263-273.

Kraus, S.D., M.W. Brown, H. Caswell, C.W. Clark, M. Fujiwara, P.K. Hamilton, R.D. Kenney, A. R. Knowlton, S. Landry, C.A. Mayo, W.A. McLellan, M.J. Moore, D.P. Nowacek, D.A. Pabst, A.J. Read, and R.M. Rolland. 2005. North Atlantic right whales in crisis. *Science* 309:561-562.

Lane, N. 2008a. *Issues Affecting Tidal, Wave, and In-Stream Generation Projects*. Congressional Research Service Report to Congress, Order Code RL33883, Updated October 7, 2008.

Lane, N. 2008b. *Wave, Tidal, and Instream Energy Projects: Which Federal Agency Has the Lead?* Congressional Research Service Report to Congress, Order Code RS22721, Updated October 7, 2008.

Langhamer, O. Undated. *Man-made offshore installations: Are marine colonizers a problem or an advantage?* Introductory Research Essay, Uppsala University. 21 p. [http://www.el.angstrom.uu.se/forskningsprojekt/Islandsberg\\_pek/Man-made%20offshore%20installations.pdf](http://www.el.angstrom.uu.se/forskningsprojekt/Islandsberg_pek/Man-made%20offshore%20installations.pdf) (accessed August 11, 2008).

Langlois, T.J., M.J. Anderson, and R.C. Babcock. 2005. Reef-associated predators influence adjacent soft-sediment communities. *Ecology* 86(6):1508-1519.



Largier, J., D. Behrens, and M. Robart. 2008. The Potential Impact of WEC Development on Nearshore and Shoreline Environments through a reduction in Nearshore Wave Energy. Chapter 3 In: Nelson, P.A., D. Behrens, J. Castle, G. Crawford, R.N. Gaddam, S.C. Hackett, J. Largier, D.P. Lohse, K.L. Mills, P.T. Raimondi, M. Robart, W.J. Sydeman, S.A. Thompson, and S. Woo. 2008. Developing Wave Energy in Coastal California: Potential Socio-Economic and Environmental Effects. California Energy Commission, PIER Energy-Related Environmental Research Program & California Ocean Protection Council CEC-500-2008-083. [http://www.resources.ca.gov/copc/docs/ca\\_wec\\_effects.pdf](http://www.resources.ca.gov/copc/docs/ca_wec_effects.pdf) (accessed November 19, 2008).

Layman, S.R., M.J. Kealy, and J.P. Nicolette. 2000. Use of a net environmental benefits analysis approach in the alternative hydropower licensing process. Proceedings of HydroVision 2000, HCI Publications, Inc., Kansas City, MO.

Lehman, R.N., P.L. Kennedy, and J.A. Savidge. 2007. The state of the art in raptor electrocution research: A global review. *Biological Conservation* 136(2):159-174.

Lewis, L.J., J. Davenport, and T.C. Kelly. A study of the impact of a pipeline construction on estuarine benthic invertebrate communities. Part 2. Recolonization by benthic invertebrates after 1 year and response of estuarine birds. *Estuarine, Coastal and Shelf Sciences* 57 (2003):201-208.

Lohmann, K.J., A.W. Swartz, and C.M.F. Lohmann. 1995. Perception of ocean wave direction by sea turtles. *The Journal of Experimental Biology* 198:1079-1085.

Lohmann, K.J. and C.M.F. Lohmann 1996. Detection of magnetic field intensity by sea turtles. *Nature* 380:59-61.

Lohmann, K.J., C.M.F. Lohmann, and C.S. Endres. 2008a. The sensory ecology of ocean navigation. *The Journal of Experimental Biology* 211: 1719-1728.

Lohmann, K.J., N.F. Putman, and C.M.F. Lohmann. 2008b. Geomagnetic imprinting: a unifying hypothesis of long-distance natal homing in salmon and sea turtles. *The Proceedings of the National Academy of Sciences USA* 105(49):19096-19101.

Lohse, D.P., R.N. Gaddam, and R.T. Raimondi. 2008. Predicted Effects of Wave Energy Conversion on Communities in the Nearshore Environment. Chapter 4 In: Nelson, P.A., D. Behrens, J. Castle, G. Crawford, R.N. Gaddam, S.C. Hackett, J. Largier, D.P. Lohse, K.L. Mills, P.T. Raimondi, M. Robart, W.J. Sydeman, S.A. Thompson, and S. Woo. 2008. Developing Wave Energy in Coastal California: Potential Socio-Economic and Environmental Effects. California Energy Commission, PIER Energy-Related Environmental Research Program & California Ocean Protection Council CEC-500-2008-083. [http://www.resources.ca.gov/copc/docs/ca\\_wec\\_effects.pdf](http://www.resources.ca.gov/copc/docs/ca_wec_effects.pdf) (accessed November 19, 2008).



- Longmuir, C. and T. Lively. 2001. Bubble curtain systems help protect the marine environment. *Pile Driver Magazine*. Summer 2001. p. 11-16.
- Love, M.S., J. Caselle, and L. Snook. 1999. Fish assemblages on mussel mounds surrounding seven oil platforms in the Santa Barbara Channel and Santa Maria Basin. *Bulletin of Marine Science* 65(2):497-513.
- Lugo-Fernandez, A., H.H. Roberts, and W.J. Wiseman, Jr. 1998. Tide effects on wave attenuation and wave set-up on a Caribbean coral reef. *Estuarine, Coastal and Shelf Science* 47:385-393.
- Madsen, P.T. 2005. Marine mammals and noise: Problems with root mean square sound pressure levels for transients. *Journal of the Acoustic Society of America* 117(6):3952-3957.
- Maes, J., A.W.H. Turnpenny, D.R. Lambert, J.R. Nedwell, R. Parmentier, and F. Ollevier. 2004. Field evaluation of a sound system to reduce estuarine fish intake rates at a power plant cooling water inlet. *Journal of Fish Biology* 64(4):938-946.
- Mann, S., N.H.C. Sparks, M.M. Walker, and J.L. Kirschvink. 1988. Ultrastructure, morphology and organization of biogenic magnetite from sockeye salmon, *Oncorhynchus nerka*: implications for magnetoreception, *Journal of Experimental Biology*, 140: 35-49.
- Marine Protected Areas of the United States. 2008. The Marine Protected Areas Inventory. [http://www.mpa.gov/helpful\\_resources/inventory.html](http://www.mpa.gov/helpful_resources/inventory.html) (accessed February 11, 2009).
- Marra, L.J. 1989. Sharkbite on the SL submarine lightwave cable system: History, causes, and resolution. *IEEE Journal of Oceanic Engineering* 14(3):230-237.
- McCauley, R.D., J. Fewtrell, A.J. Duncan, C. Jenner, M-N. Jenner, J.D. Penrose, R.I.T. Prince, A. Adhitya, J. Murdoch, and K. McCabe. 2000a. Marine Seismic Surveys: Analysis and Propagation of Air-Gun Signals; and Effects of Air-Gun Exposure on Humpback Whales, Sea Turtles, Fishes and Squid. Report R99-15. Centre for Marine Science and Technology, Curtin University of Technology, Western Australia.
- McCauley, R.D., J. Fewtrell, A.J. Duncan, C. Jenner, M-N. Jenner, J.D. Penrose, R.I.T. Prince, A. Adhitya, J. Murdoch, and K. McCabe. 2000b. Marine seismic surveys: a study of environmental implications. *Australian Petroleum Production Exploration Association Journal* 2000:692-708.
- McDonald, B.G., A.M.H. deBruyn, B.G. Wernick, L. Paterson, N. Pallerin, and P.M. Chapman. 2007. Design and application of a transparent and scalable weight-of-evidence framework: an example from Wabamun Lake, Alberta, Canada. *Integrated Environmental Assessment and Management* 3(4):476-483.

Meyer, C.G., K.N. Holland, and Y.P. Papastamatiou. 2004. Sharks can detect changes in the geomagnetic field. *Journal of the Royal Society Interface* 2(2):129-130.

Michel, J. and E. Burkhard. 2007. Workshop to Identify Alternative Energy Environmental Information Needs – Workshop Summary. OCS Report MMS 2007-057. Minerals Management Service, U.S. Department of the Interior, Washington, DC. <http://www.mms.gov/offshore/AlternativeEnergy/Studies.htm> (accessed April 25, 2008).

Michel, J., H. Dunagan, C. Boring, E. Healy, W. Evans, J. Dean, A. McGillis, and J. Hain. 2007. Worldwide Synthesis and Analysis of Existing Information Regarding Environmental Effects of Alternative Energy Uses on the Outer Continental Shelf. OCS Report MMS 2007-038. Minerals Management Service, U.S. Department of the Interior, Washington, DC. <http://www.mms.gov/offshore/AlternativeEnergy/Studies.htm> (accessed April 25, 2008).

Millar, D.L., H.C.M. Smith, and D.E. Reeve. 2007. Modelling analysis of the sensitivity of shoreline change to a wave farm. *Ocean Engineering* 34(2007):884-901.

MMS (Minerals Management Service). 2007. Programmatic Environmental Impact Statement for Alternative Energy Development and Production and Alternate Uses of Facilities on the Outer Continental Shelf. Final EIS. MMS 2007-046. October 2007. <http://ocsenergy.anl.gov> (accessed August 13, 2008).

Moore, S.E. and J.T. Clarke. 2002. Potential impact of offshore human activities on gray whale (*Eschrichtius robustus*). *Journal of Cetacean Research and Management* 4(1):19-25.

Myers, E.P., D.E. Hoss, D.S. Peters, W.M. Matsumoto, M.P. Seki, R.N. Uchida, J.D. Ditmars, and R.A. Paddock. 1986. The potential impact of ocean thermal energy conversion (OTEC) on fisheries. NOAA Technical Report NMFS 40. U.S. Department of Commerce, Seattle, WA. 33 pp.

Nedwell, J.R., B. Edwards, A.W.H. Turnpenny, and J. Gordon. 2004. Fish and Marine Mammals Audiograms: A Summary of Available Information. Subacoustech Report ref: 534R0214 to Chevron Texaco Ltd., TotalFinaElf Exploration UK Plc, DSTL, DTI and Shell U.K. Exploration and Production Ltd. 281 p. <http://www.subacoustech.com/information/publications.shtml> (accessed May 30, 2008).

Nehls, G., K. Betke, S. Eckelmann, and M. Ros. 2007. Assessment and costs of potential engineering solutions for the mitigation of the impacts of underwater noise arising from the construction of offshore windfarms. COWRIE ENG-01-2007. October 2007. 47 p. <http://www.offshorewindfarms.co.uk/Pages/Publications> (accessed August 7, 2008).

Nelson, P.A. 2003. Marine fish assemblages associated with fish aggregating devices: Effects of fish removal, FAD size, fouling communities, and prior recruits. *Fishery Bulletin* 101(4):835-850.

Nelson, P.A. 2008. Ecological Effects of Wave Energy Conversion Technology on California's Marine and Anadromous Fishes. Chapter 5 In: Nelson, P.A., D. Behrens, J. Castle, G. Crawford, R.N. Gaddam, S.C. Hackett, J. Largier, D.P. Lohse, K.L. Mills, P.T. Raimondi, M. Robart, W.J. Sydeman, S.A. Thompson, and S. Woo. 2008. Developing Wave Energy in Coastal California: Potential Socio-Economic and Environmental Effects. California Energy Commission, PIER Energy-Related Environmental Research Program & California Ocean Protection Council CEC-500-2008-083. [http://www.resources.ca.gov/copc/docs/ca\\_wec\\_effects.pdf](http://www.resources.ca.gov/copc/docs/ca_wec_effects.pdf) (accessed November 19, 2008).

Nelson, P.A., D. Behrens, J. Castle, G. Crawford, R.N. Gaddam, S.C. Hackett, J. Largier, D.P. Lohse, K.L. Mills, P.T. Raimondi, M. Robart, W.J. Sydeman, S.A. Thompson, and S. Woo. 2008. Developing Wave Energy in Coastal California: Potential Socio-Economic and Environmental Effects. California Energy Commission, PIER Energy-Related Environmental Research Program & California Ocean Protection Council CEC-500-2008-083. [http://www.resources.ca.gov/copc/docs/ca\\_wec\\_effects.pdf](http://www.resources.ca.gov/copc/docs/ca_wec_effects.pdf) (accessed November 19, 2008).

Nendza, M. 2007. Hazard assessment of silicone oils (polydimethylsiloxanes, PDMS) used in antifouling-/foul-release-products in the marine environment. *Marine Pollution Bulletin* 54:1190-1196.

Newcombe, C.P. and J.O.T. Jensen. 1996. Channel suspended sediment and fisheries: A synthesis for quantitative assessment of risk and impact. *North American Journal of Fisheries Management* 16(4): 693-727.

NMFS (National Marine Fisheries Service). 2003. Taking Marine Mammals Incidental to Conducting Oil and Gas Exploration Activities in the Gulf of Mexico. March 3, 2003. *Federal Register* 68(41):9991-9996.

NOAA (National Oceanic and Atmospheric Administration). 2008. Environmental Sensitivity Index Mapping. NOAA's National Ocean Service, Office of Response and Restoration. [http://response.restoration.noaa.gov/book\\_shelf/827\\_ERD\\_ESI.pdf](http://response.restoration.noaa.gov/book_shelf/827_ERD_ESI.pdf) (accessed November 13, 2008).

Nowacek, D.P., L.H. Thorne, D.W. Johnston, and P.L. Tyack. 2007. Responses of cetaceans to anthropogenic noise. *Mammal Review* 37(2):81-115.

NRC (National Research Council). 2000. *Marine Mammals and Low-Frequency Sound. Progress Since 1994*. National Academy Press, Washington, DC.

NRC (National Research Council). 2003. *Ocean Noise and Marine Mammals*. National Academies Press, Washington, DC.

NRC (National Research Council). 2004. *Adaptive Management for Water Resources Planning*. The National Academies Press. Washington, DC.

- NRC (National Research Council). 2005. *Marine Mammal Populations and Ocean Noise: Determining when Noise Causes Biologically Significant Effects*. National Academy Press, Washington, DC.
- Ogden, J. 2005. Resource concerns associated with the off-shore environment. Pages 51-53 in *Proceedings of the Hydrokinetic and Wave Energy Technologies Technical and Environmental Issues Workshop*. U.S. Department of Energy, Washington, DC.  
[http://hydropower.id.doe.gov/hydrokinetic\\_wave/index.shtml](http://hydropower.id.doe.gov/hydrokinetic_wave/index.shtml) (accessed October 7, 2008).
- Ohman, M.C., P. Sigray, and H. Westerberg. 2007. Offshore windmills and the effects of electromagnetic fields on fish. *Ambio* 36(8):630-633.
- Parvin, S.J., J.R. Nedwell, and E. Harland. 2007. *Lethal and Physical Injury of Marine Mammals, and Requirements for Passive Acoustic Monitoring*. Subacoustech Report Reference: 565R0212, February 2007 to DTI, 1 Victoria Street, London, SW1H 0ET.  
<http://www.subacoustech.com/information/publications.shtml> (accessed May 30, 2008).
- Pelc, R. and R.M. Fujita. 2002. Renewable energy from the ocean. *Marine Policy* 26:471-479.
- Petersen, I.K., T.K. Christensen, J. Kahlert, M. Desholm, and A.D. Fox. 2006. Final results of bird studies at the offshore wind farms at Nysted and Horns Rev, Denmark. National Environmental Research Institute, Denmark.
- PFMC (Pacific Fisheries Management Council). 2007. *Marine Reserves*.  
<http://www.pcouncil.org/reserves/reservesback.html> (accessed December 16, 2008).
- PFMC (Pacific Fisheries Management Council). 2008. June 17, 2008 letter from D.O. McIsaac, Executive Director of PFMC to Director Randall Luthi, Minerals Management Service, regarding Docket ID MMS-2008-OMM-0020.
- Ploskey, G.R. and T.J. Carlson. 2004. Comparison of Blade-Strike Modeling Results with Empirical Data. PNNL-14603. Pacific Northwest National Laboratory, Richland, WA.
- Polagye, B., P. Malte, M. Kawase, and D. Durran. 2008. Effect of large-scale kinetic power extraction on time-dependent estuaries. *Proceedings of the Institution of Mechanical Engineers. Part A: Journal of Power and Energy* 222(5):471-484.
- Popper, A.N. 2003. Effects of anthropogenic sound on fishes. *Fisheries* 28:24-31.
- Prato, T. 2003. Adaptive management of large rivers with special reference to the Missouri River. *Journal of the American Water Resources Association (JAWRA)* 39(4):935-946.

Resolve, Inc. 2005. Proceedings of the Hydrokinetic and Wave Energy Technologies Technical and Environmental Issues Workshop. U.S. Department of Energy, Washington, DC. [http://hydropower.id.doe.gov/hydrokinetic\\_wave/index.shtml](http://hydropower.id.doe.gov/hydrokinetic_wave/index.shtml) (accessed October 7, 2008).

Roberts, H.H., P.A. Wilson, and A. Lugo-Fernandez. 1992. Biologic and geologic responses to physical processes: examples from modern reef systems of the Caribbean-Atlantic region. *Continental Shelf Research* 12(7/8):809-834.

Rodil, I.F. and M. Lastra. 2004. Environmental factors affecting benthic macrofauna along a gradient of intermediate sandy beaches in northern Spain. *Estuarine, Coastal and Shelf Science* 61:37-44.

Rodrigue, P.R. 1986. Cavitation pitting mitigation in hydraulic turbines. Volume 2: cavitation review and assessment. EPRI AP-4719, Electric Power Research Institute, Palo Alto, CA.

Rommel, S.A. Jr. and J.D. McCleave. 1972. Oceanic electric fields: perception by American eels? *Science* 176:1233-1235.

Rucker, J.B. and W.A. Friedl. 1985. Potential impacts from OTEC-generated underwater sounds. *Oceans* 17:1279-1283.

Senecal, P., B. Goldsmith, S. Conover, B. Sadler, and K. Brown. 1999. Principles of Environmental Impact Assessment Best Practice. 4 p. [http://www.iaia.org/modx/assets/files/Principles%20of%20IA\\_web.pdf](http://www.iaia.org/modx/assets/files/Principles%20of%20IA_web.pdf) (accessed November 11, 2008).

Simmonds, M.P., S.J. Dolman, and L. Weilgart (eds.). 2003. Oceans of Noise. A Whale and Dolphin Conservation Society Science Report. 164 p. <http://www.wdcs.org> (accessed May 30, 2008).

Sinclair, M. and M.J. Tremblay. 1984. Timing of spawning of Atlantic herring (*Clupea harengus harengus*) populations and the match-mismatch theory. *Canadian Journal of Fisheries and Aquatic Sciences* 41:1055-1065.

Smith, C.L. 1972. A spawning aggregation of Nassau grouper, *Epinephelus striatus* (Bloch). *Transactions of the American Fisheries Society* 101(2):257-261.

Smith, H.C.M., D.L. Millar, and D.E. Reeve. 2007. Generalization of wave farm impact assessment on inshore wave climate. Proceedings of the 7<sup>th</sup> European Wave and Tidal Energy Conference, September 11-13, 2007, Porto, Portugal. 7 p.

- Smith, R. 2007. The Roosevelt Island Tidal Energy (RITE) Project Environmental Assessment. Environmental Monitoring, Evaluation and Protection in New York: Linking Science and Policy. Presentation at the New York State Energy Research and Development Authority Conference, November 15-16, 2007. [http://www.nyserda.org/Programs/Environment/EMEP/conference\\_2007/Smith\\_Ron.pdf](http://www.nyserda.org/Programs/Environment/EMEP/conference_2007/Smith_Ron.pdf) (accessed October 7, 2008).
- Southall, B., J. Berkson, D. Bowen, R. Brake, J. Eckman, J. Field, R. Gisiner, S. Gregerson, W. Lang, J. Lewandoski, J. Wilson, and R. Winokur. 2009. Addressing the Effects of Human-Generated Sound on Marine Life: An Integrated Research Plan for U.S. Federal Agencies. Interagency Task Force on Anthropogenic Sound and the Marine Environment of the Joint Subcommittee on Ocean Science and Technology. Washington, DC. 66 p. [http://ocean.ceq.gov/about/docs/iatf\\_finalreport\\_09.pdf](http://ocean.ceq.gov/about/docs/iatf_finalreport_09.pdf)
- Southall, B.L., A.E. Bowles, W.T. Ellison, J.J. Finneran, R.L. Gentry, C.R. Greene, Jr., D. Kastak, D.R. Ketten, J.H. Miller, P.E. Nachtigall, W.J. Richardson, J.A. Thomas, and P.L. Tyack. 2007. Marine mammal noise exposure criteria: initial scientific recommendations. *Aquatic Mammals* 33(4):411-521.
- Sundberg J. and O. Langhamer. 2005. Environmental questions related to point-absorbing linear wave-generators: impact, effects and fouling. In: Proceeding of the 6th European Wave and Tidal Energy Conference. 30<sup>th</sup> August–2<sup>nd</sup> September 2005. Glasgow, Scotland.
- Suter, G.W. II, S.B. Norton, and S.M. Cormier. 2002. A methodology for inferring the causes of observed impairments in aquatic ecosystems. *Environmental Toxicology and Chemistry* 21(6):1101-1111.
- Swanson, T. 2005. Resource concerns associated with estuaries. Pages 45-49 in Proceedings of the Hydrokinetic and Wave Energy Technologies Technical and Environmental Issues Workshop. U.S. Department of Energy, Washington, DC. [http://hydropower.id.doe.gov/hydrokinetic\\_wave/index.shtml](http://hydropower.id.doe.gov/hydrokinetic_wave/index.shtml) (accessed October 7, 2008).
- TCPA (Texas Comptroller of Public Accounts). 2008. Ocean Power. Chapter 20 in The Energy Report. May, 2008. <http://www.window.state.tx.us/specialrpt/energy/> (accessed June 4, 2008).
- The Engineering Business Ltd. 2005. Stingray Tidal Stream Energy Device – Phase 3. T/06/00230/00/REP URN 05/864. 110 p. + appendices. <http://www.engb.com/downloads/Stingray%20Phase%203r.pdf> (accessed August 18, 2008).

Thompson, S.A., J. Castle, K.L. Mills, and W.J. Sydeman. 2008. Wave Energy Conversion Technology Development in Coastal California: Potential Impacts on Marine Birds and Mammals. Chapter 6 In: Nelson, P.A., D. Behrens, J. Castle, G. Crawford, R.N. Gaddam, S.C. Hackett, J. Largier, D.P. Lohse, K.L. Mills, P.T. Raimondi, M. Robart, W.J. Sydeman, S.A. Thompson, and S. Woo. 2008. Developing Wave Energy in Coastal California: Potential Socio-Economic and Environmental Effects. California Energy Commission, PIER Energy-Related Environmental Research Program & California Ocean Protection Council CEC-500-2008-083. [http://www.resources.ca.gov/copc/docs/ca\\_wec\\_effects.pdf](http://www.resources.ca.gov/copc/docs/ca_wec_effects.pdf) (accessed November 19, 2008).

Thomsen, F., K. Lüdemann, R. Kafemann, and W. Piper. 2006. Effects of offshore wind farm noise on marine mammals and fish. biola, Hamburg, Germany on behalf of COWRIE, Ltd. <http://www.offshorewind.co.uk/Assets/BIOLARep06072006FINAL.pdf> (accessed May 12, 2008).

Tougaard, J., J. Carstensen, J. Teilmann, and N.I. Bech. 2005. Effects of the Nysted Offshore Wind Farm on harbour porpoises. Annual status report for the T-POD monitoring program. NERI Technical Report. 49 p. [http://uk.nystedhavmoellepark.dk/upload/pdf/marsvin\\_2004.pdf](http://uk.nystedhavmoellepark.dk/upload/pdf/marsvin_2004.pdf) (accessed August 7, 2008).

Turnpenny, A.W.H., M.H. Davis, J.M. Fleming, and J.K. Davies. 1992. Experimental studies relating to the passage of fish and shrimps through tidal power turbines. Marine and Freshwater Biology Unit, National Power, Fawley, Southampton, Hampshire, England.

USACE (U.S. Army Corps of Engineers). 1995. Proceedings: 1995 Turbine Passage Survival Workshop. U.S. Army Corps of Engineers, Portland District, Portland, OR. 212 p. + appendices.

Viada, S.T., R.M. Hammer, R. Racca, D. Hannay, M.J. Thompson, B.J. Balcom, and N.W. Phillips. 2008. Review of potential impacts to sea turtles from underwater explosive removal of offshore structures. Environmental Impact Assessment Review 28(2008): 267-285.

Videler, J.J. and C.S. Wardle. 1991. Fish swimming stride by stride: speed limits and endurance. Reviews in Fish Biology and Fisheries 1:23-40.

Wahlberg, M. and H. Westerberg. 2005. Hearing in fish and their reactions to sounds from offshore wind farms. Marine Ecology Progress Series 288:295-309.

Walker, M.M., C.E. Diebel, C.V. Haugh, P.M. Pankhurst, J.C. Montgomery, and C.R. Green. 1997. Structure and function of the vertebrate magnetic sense. Nature 390:371-376.



- Walker, M.M., T.P. Quinn, J.L. Kirschvink, and C. Groot. 1988. Production of single-domain magnetite throughout life by sockeye salmon, *Oncorhynchus nerka*. *Journal of Experimental Biology* 140:51-63.
- Walters, C. 1986. *Adaptive Management of Renewable Resources*. Macmillan Publishing Company, New York. 374 p.
- Wang, D., M. Atlar, and R. Sampson. 2007. An experimental investigation on cavitation, noise, and slipstream characteristics of ocean stream turbines. *Proceedings of the Institution of Mechanical Engineers, Part A: Journal of Power and Energy* 221(2):219-231.
- Wang, J.H., J.K. Jackson, and K.J. Lohmann. 1998. Perception of wave surge motion by hatchling sea turtles. *Journal of Experimental Marine Biology and Ecology* 229:177-186.
- Watermann, B.T., B. Daehne, S. Seivers, R. Dannenberg, J.C. Overbeke, J.W. Klijnstra, and O. Heemken. 2005. Bioassays and selected chemical analysis of biocide-free antifouling coatings. *Chemosphere* 60(2005):1530-1541.
- Watten, W.M.J., A.S. Bahaj, A.F. Molland, and J.R. Chaplin. 2006. Hydrodynamics of marine current turbines. *Renewable Energy* 31:249-256.
- Wave Dragon Wales Ltd. 2007. *Wave Dragon Pre-Commercial Wave Energy Device. Volume 2, Environmental Statement*. April, 2007. <http://www.wavedragon.co.uk/> (accessed August 4, 2008).
- Webster, D.C., B.J. Chisholm, and S.J. Stafslien. 2007. Mini-review: combinatorial approaches for the design of novel coating systems. *Biofouling* 23(3/4):179-192.
- Weilgart, L.S. 2007. The impacts of anthropogenic ocean noise on cetaceans and implications for management. *Canadian Journal of Zoology* 85:1091-1116.
- Weir, C.R. 2007. Observations of marine turtles in relation to seismic airgun sound off Angola. *Marine Turtle Newsletter* 116:17-20.
- Widdows, J. and M. Brinsley. 2002. Impact of biotic and abiotic processes on sediment dynamics and the consequences to the structure and functioning of the intertidal zone. *Journal of Sea Research* 48:143-156.
- Wilber, D.H. and D.G. Clarke. 2001. Biological effects of suspended sediments: A review of suspended sediment impacts on fish and shellfish with relation to dredging activities in estuaries. *North American Journal of Fisheries Management* 21(4):855-875.



Wilber, D. H., W. Brostoff, D.G. Clarke, and G.L. Ray. 2005. Sedimentation: Potential biological effects from dredging operations in estuarine and marine environments. DOER Technical Notes Collection ERDC TN-DOER-E20. U.S. Army Engineer Research and Development Center, Vicksburg, MS. <http://stinet.dtic.mil/cgi-bin/GetTRDoc?AD=ADA434926&Location=U2&doc=GetTRDoc.pdf>

Wilhelmsson, D., T. Malm, and M.C. Ohman. 2006. The influence of offshore windpower on demersal fish. *ICES Journal of Marine Science* 63:775-784.

Wilhelmsson, D. and T. Malm. 2008. Fouling assemblages on offshore wind power plants and adjacent substrata. *Estuarine, Coastal and Shelf Science* 79(3):459-466.

Wilkins, L.A. and M.H. Hoffman. 2005. Behavior of animals with passive, low-frequency electrosensory systems. Pages 229-263 In: *Electroreception*. T.H. Bullock, C.D. Hopkins, A.N. Popper, and R.R. Fay (eds.). Springer Handbook of Auditory Research Volume 21, Springer, New York.

Williams, H. 2005. Open center turbine. Pages 12-13 In: *Proceedings of the Hydrokinetic and Wave Energy Technologies Technical and Environmental Issues Workshop*. U.S. Department of Energy, Washington, DC. [http://hydropower.id.doe.gov/hydrokinetic\\_wave/index.shtml](http://hydropower.id.doe.gov/hydrokinetic_wave/index.shtml) (accessed October 7, 2008).

Williams, B.K., R.C. Szaro, and C.D. Shapiro. 2007. Adaptive Management: The U.S. Department of the Interior Technical Guide. Adaptive Management Working Group, U.S. Department of the Interior, Washington, DC.

Wilson, B. and L.M. Dill. 2002. Pacific herring respond to simulated odontocete echolocation sounds. *Canadian Journal of Fisheries and Aquatic Sciences* 59:542-553.

Wilson, B., R.S. Batty, F. Daunt, and C. Carter. 2007. Collision Risks Between Marine Renewable Energy Devices and Mammals, Fish and Diving Birds. Report to the Scottish Executive. Scottish Association for Marine Science, Oban, Scotland. PA25 1QA. 110 p.

Willyard, C.J., S.M. Tikalsky, and P.A. Mullins. 2004. Ecological Effects of Fragmentation Related to Transmission Line Rights-of-Way: A Review of the State of the Science. Wisconsin Focus on Energy Environmental Research Program. State of Wisconsin Department of Energy, Madison, Wisconsin. 66 p. [http://www.rs-inc.com/downloads/Ecological\\_Effects\\_of\\_Fragmentation\\_on\\_Rights-of-Way.pdf](http://www.rs-inc.com/downloads/Ecological_Effects_of_Fragmentation_on_Rights-of-Way.pdf)

Wiltschko, R. and W. Wiltschko. 1995. *Magnetic Orientation in Animals*. Springer Verlag, Berlin.

Wood, P.J. and P.D. Armitage. 1997. Biological effects of fine sediment in the lotic environment. *Environmental Management* 21(2): 203-217.

Woytenek, W., X. Pei, and L.A. Wilkens. 2001. Paddlefish strike at artificial dipoles simulating the weak electric fields of planktonic prey. *The Journal of Experimental Biology* 204:1391-1399.

Wursig, B., C.R. Greene, Jr., and T.A. Jefferson. 2000. Development of an air bubble curtain to reduce underwater noise of percussive piling. *Marine Environmental Research* 49:79-93.

Yebara, D.M., S. Kiil, and K. Dam-Johansen. 2004. Antifouling technology – past, present and future steps towards efficient and environmentally friendly antifouling coatings. *Progress in Organic Coatings* 50:75-104.

Yebara, D.M., S. Kiil, K. Dam-Johansen, and C.E. Weinell. 2006. Mathematical modeling of tin-free chemically-active antifouling paint behavior. *AIChE Journal* 52(5):1926-1940.



## Appendix A

### List of Individuals, Agencies, and Organizations Contacted

The following is a list of individuals who were specifically consulted in the preparation of this report or who provided comments on earlier drafts. Individuals involved as technical or policy reviewers from DOI and Department of Commerce, consistent with the Congressional direction in EISA Section 633(b), are indicated with a single asterisk (\*). Technical specialists involved in the peer review process, in compliance with the Information Quality Act (Section 515 of Public Law 106-554), are indicated with a double asterisk (\*\*).

Seventy-four people participated in a web-based seminar (webinar) on November 25, 2008. The webinar was held to inform interested parties about the initial findings of the report. Some of the webinar participants subsequently provided comments on the report. Also, the developers of marine and hydrokinetic technologies were individually contacted for information about environmental studies; a total of 48 developers responded to the request.

Shawn Alam \*  
*Office of Environmental Policy and Compliance*  
*U.S. Department of the Interior*

Steve Amaral \*\*  
*Alden Research Laboratory, Inc.*

Benjamin Baron-Taltre \*  
*National Oceanic and Atmospheric Administration*

Thomas Bigford \*  
*National Oceanic and Atmospheric Administration*

Jonathan Black  
*Alden Research Laboratory, Inc.*

Mary Josie Blanchard \*  
*Office of Environmental Policy and Compliance*  
*U.S. Department of the Interior*

Mary Boatman \*  
*Minerals Management Service*  
*U.S. Department of the Interior*

George Boehlert  
*Hatfield Marine Science Center*  
*Oregon State University*

Maureen Bornholdt, Chief \*  
*Minerals Management Service*  
*U.S. Department of the Interior*

Stephen Bowler  
*Federal Energy Regulatory Commission*

Charlie Brandt \*\*  
*Pacific Northwest National Laboratory*

Elizabeth Burkhard \*  
*Minerals Management Service*  
*U.S. Department of the Interior*

Brian Cable  
*Naval Facilities Engineering Command*

Chris Catlin  
*Bourne Energy*

Linda Church Ciocci  
*National Hydropower Association*

Andrea Copping \*\*  
*Pacific Northwest National Laboratory*

Bob Dach \*  
*Bureau of Indian Affairs*  
*U.S. Department of the Interior*

Stefanie Damiani Stavrakas \*  
*U.S. Fish & Wildlife Service*  
*U.S. Department of the Interior*

Dennis Dauble  
*Pacific Northwest National Laboratory*

Dick Ecker \*\*  
*Pacific Northwest National Laboratory*

Joan Harn \*  
*National Park Service*  
*U.S. Department of the Interior*

George Hecker \*\*  
*Alden Research Laboratory, Inc.*

Jennifer Hill  
*Federal Energy Regulatory Commission*

Tim Hogan  
*Alden Research Laboratory, Inc.*

Ken Homolka  
*Oregon Department of Fish and Wildlife*

B.J. Howerton \*  
*Bureau of Indian Affairs*  
*U.S. Department of the Interior*

Cheri Hunter \*  
*Minerals Management Service*  
*U.S. Department of the Interior*

Gary Johnson \*\*  
*Pacific Northwest National Laboratory*

Lingard Knutson  
*U.S. Environmental Protection Agency, Region II*

Andrew Krueger \*  
*Minerals Management Service*  
*U.S. Department of the Interior*

Eugenia Laychak \*\*  
*California Energy Commission*

Jeff Leahey  
*National Hydropower Association*

Emily Lindow \*  
*National Oceanic and Atmospheric Administration*

Ralph Lopez \*  
*National Oceanic and Atmospheric Administration*

Megan McClure  
*U.S. Department of Energy*

Gregory McMurray  
*Oregon Department of Land Conservation and Development*

Ann Miles  
*Federal Energy Regulatory Commission*

Alejandro Moreno  
*U.S. Department of Energy*

William Munslow  
*Lockheed Martin MS2*

Chad Nelson \*\*  
*Surfrider Foundation*

Joe O'Hagan \*\*  
*California Energy Commission*

Sean O'Neill  
*Ocean Renewable Energy Coalition*

Cherise Oram  
*Stoel Rives LLP*

Brian Polagye  
*University of Washington*

Kathryn Roberts \*  
*U.S. Fish and Wildlife Service*

Mike Sale  
*Sentech, Inc.*

Dave Schowalter  
*Alden Research Laboratory, Inc.*

George Taylor  
*Ocean Power Technologies, Inc.*

Trey Taylor  
*Verdant Power, Inc.*

Ron Thom \*\*  
*Pacific Northwest National Laboratory*

Rob Whitson  
*Sentech, Inc.*

George Wolff  
*Ocean Power Technologies, Inc.*





# Appendix B

## Technology Concepts and Developers

### *DOE's Marine and Hydrokinetic Renewable Energy Technology Database*

The DOE Wind and Hydropower Technologies Program developed and maintains the Marine and Hydrokinetic Technology Database, which provides frequently updated information on marine and hydrokinetic renewable energy technologies in the U.S. and around the world (Figure B-1). The database includes wave, tidal, current, and ocean thermal energy, and contains information on the various energy conversion technologies, companies active in the field, and development of projects in the water. This public resource can be accessed at <http://www.eere.energy.gov/windandhydro/hydrokinetic/default.aspx>.

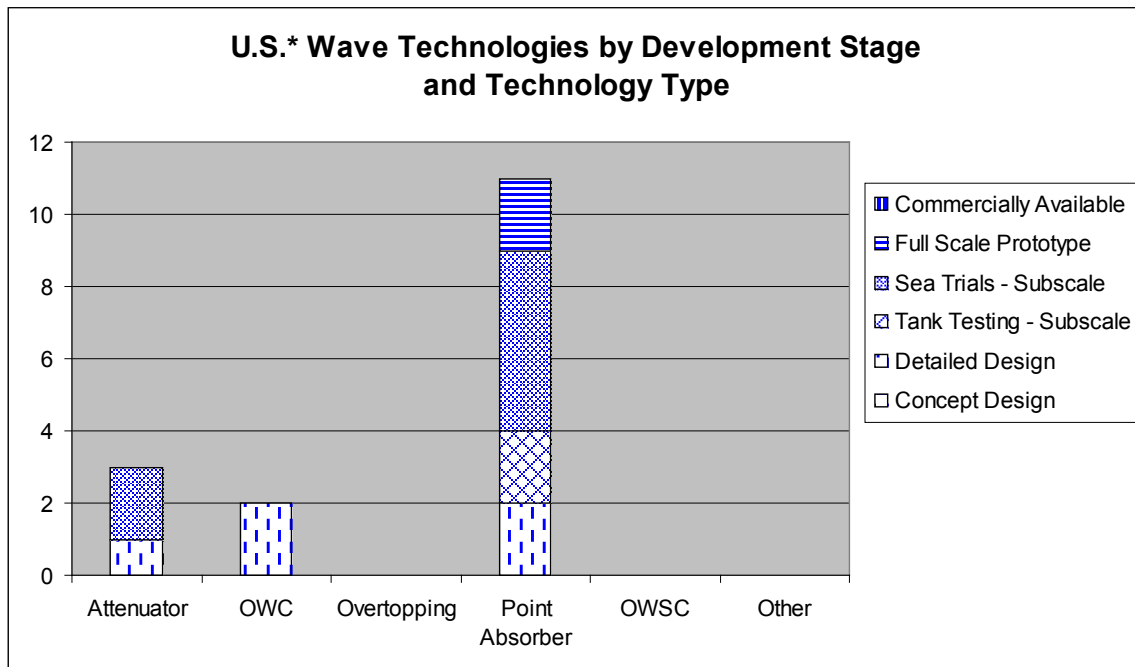

**Figure B-1. U.S. Wave Technologies by Development Stage and Technology Type (January 2009)**

*\*U.S. refers to domestically-based companies.*

Depending on the needs of the user, the database can present a snapshot of projects in a given region, assess the progress of a certain technology type, or provide a comprehensive view of the entire marine and hydrokinetic energy industry. Using the online interface, the user can display all technologies, companies, or projects within the database using the “List All...” functions or filter and sort data by company location, project location, technology application, technology type, technology stage, and/or project status using the “Advanced Search” function.

Results are displayed in user-friendly tables that can be sub-sorted using column titles (Figure 2). Furthermore, many of the results are hyperlinked to a corresponding profile pages with additional information such as the following:

- **Company:** Name, address, country, website address, associated technology or technologies, and associated project(s)
- **Technology:** Name, description, application (e.g., wave - open ocean), stage (e.g., full-scale prototype), type (e.g., point absorber), dimensions, mooring method, nameplate capacity, partnership(s), associated company, and associated project(s)
- **Project:** Title, associated company, start date, project details, location, GPS coordinates, number of devices, nameplate capacity, project status (e.g., Phase 1 – Siting/Planning), permit information, FERC docket number (for U.S. projects only), partnerships, power purchase agreement information, and links to any supporting documents

A glossary is provided to define technology terms included in the database.

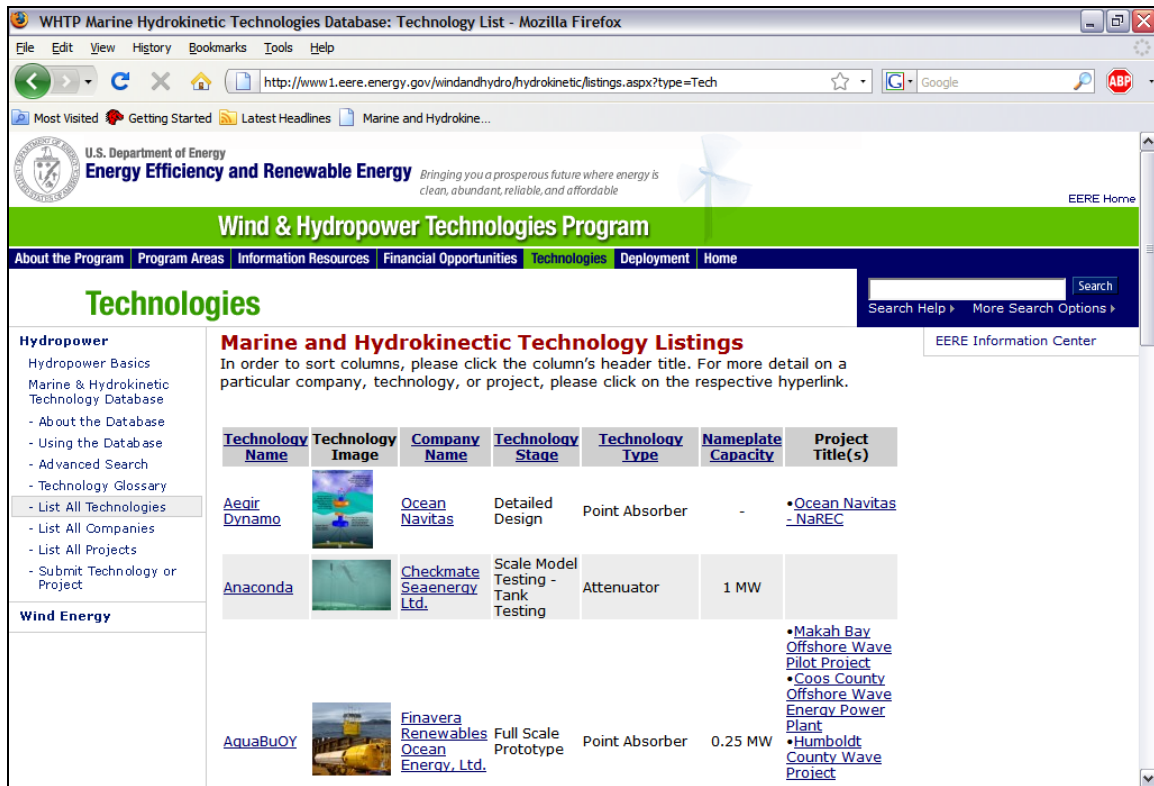

Figure B-2: Example of the “List All Technologies” function in the Marine & Hydrokinetic Technology Database.

## Appendix C

### Noise in the Aquatic Environment and Its Effects on Aquatic Animals

#### *Expressing Underwater Sounds*

There are many ways to express the intensity and frequency of underwater sound waves (Wahlberg and Westerberg 2005; Thomsen et al. 2006). An underwater acoustic wave is generated by displacement of water particles. Consequently, the passage of an acoustic wave creates local pressure oscillations that travel through water with a given sound velocity. These two parameters, pressure and velocity, are used to define the intensity of an acoustic field, and therefore are useful for considering the effects of noise on aquatic animals.

The intensity of the acoustic field is defined as the vector product of the local pressure fluctuations and the velocity of the particle displacement. A basic unit for measuring the intensity of underwater noise is the sound pressure level (SPL). The SPL of a sound, given in decibels (dB), is calculated by:

$$\text{SPL (dB)} = 20 \log_{10} (P/P_0)$$

where  $P$  is a pressure fluctuation caused by a sound source, and  $P_0$  is the reference pressure, defined in underwater acoustics as  $1 \mu\text{Pa}$  at 1 m from the source (Thomsen et al. 2006). Using the above formula, doubling the pressure of a sound ( $P$ ) results in a 6 dB increase in SPL.

The sound pressure of a continuous signal is often expressed by a root mean square (rms) measure, which is the square root of the mean value of squared instantaneous sound pressures, integrated over time (Madsen 2005). Like SPL, the resulting integration of instantaneous sound pressure levels is also expressed in dB re  $1 \mu\text{Pa}$  (rms). An rms level of safe exposure to received noise has been established for marine mammals; the lower limits for concern about temporary or permanent hearing impairments in cetaceans and pinnipeds are currently 180 and 190 dB re  $1 \mu\text{Pa}$  (rms) respectively (NMFS 2003; Southall et al. 2007). However, Madsen (2005) argues that rms safety measures are insufficient, and should be supplemented by other estimates of the magnitude of noise (e.g., maximum peak-to-peak SPL in concert with a maximum received energy flux level).

Sound intensity is greatest near the sound source and, in the far field, decreases smoothly with distance. As the acoustic wave propagates through the water, intensity is reduced by geometric spreading (dilution of the energy of the sound wave as it spreads out from the source over a larger and larger area) and, to a lesser extent, absorption, refraction, and reflection (Wahlberg and Westerberg 2005). Attenuation of sound due to spherical spreading in deep water is estimated by  $20 \log_{10} r$ , where  $r$  is the distance in m from the

source (NRC 2000). Assuming simple spherical spreading (no reflection from the sea surface or bottom) and the consequent transmission loss of SPL, a 190 dB source level would be reduced to 150 dB at 100 m. Close to the source, changes in sound intensity vary in a more complicated fashion, particularly in shallow water, as a result of acoustic interference from natural or man-made sounds or where there are reflective surfaces (seabed and water surface).

Sound exposure level (SEL) is a measure of the cumulative physical energy of the sound event which takes into account both intensity and duration. SELs are computed by summing the cumulative sound pressure squared ( $p^2$ ) over time and normalizing the time to 1 second. Because calculation of the SEL for a given underwater sound source is a way to normalize to one second the energy of noise that may be much briefer (such as the powerful, but short impulses caused by pile driving), SEL is typically used to compare noise events of varying durations and intensities.

In addition to intensity, underwater noise will have a range of frequencies (Hz or cycles per s). For convenience, measurements of the potentially wide range of individual frequencies associated with noise are integrated into “critical bands” or filters; the width of a band is often given in 1/3-octave levels (Thomsen *et al.* 2006). Thus, sounds can be expressed in terms of the intensities (dB) at particular frequency (Hz) bands (Figure C-1; Table C-1).

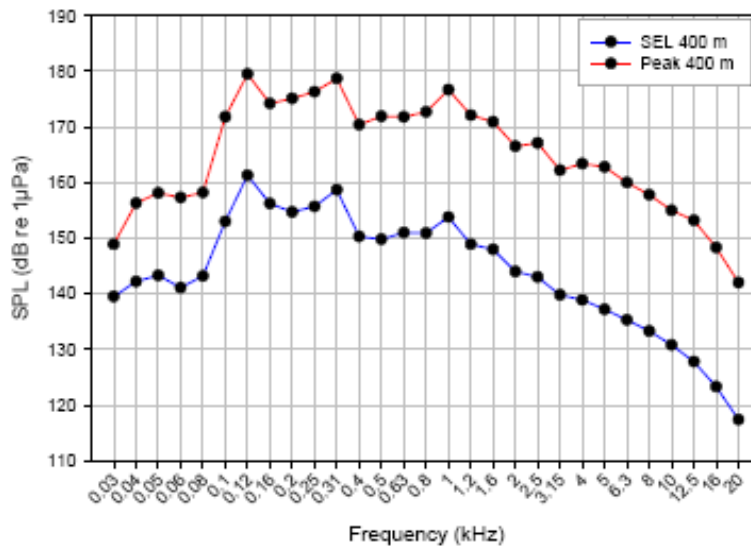

Figure C-1. Frequency spectrum (at 1/3-octave band levels) of pile-driving pulses at 400 m from the source. Source: Thomsen *et al.* (2006)

**Table C-1. Frequencies and intensities of some anthropogenic sounds. Modified from NRC (2000).**

Source	Frequency at the highest level 1/3-octave band (Hz)	Source level at the highest level 1/3-octave band (dB re 1 µPa at 1 m)
5-m Zodiac inflatable boat	6,300	152
Bell 212 helicopter	16	159
Large tanker	100 + 125	177
Icebreaker	100	183
Medium-sized support/supply ships <sup>b</sup>	10-20	130-160
Acoustic Thermometry of Ocean Climate (ATOC) <sup>a</sup>	75	195
Air gun array	50	210
Heard Island Feasibility Test (HIST; research device)	50 + 63	221
Military search sonar	2,000-5,000	230+
Pile-driving (Sweden; 30 m from source) <sup>b</sup>	250	140->180
Pile-driving (UK; 1 m from source) <sup>b</sup>	200 + 800 + 1,600	262
Pile-driving (Germany; 400 m from source) <sup>b</sup> See Figure C-1 for frequency spectrum	125 + 315 + 1,100	180

<sup>a</sup> scientific research device

<sup>b</sup> from Thomsen et al. (2006)

The National Research Council (2000) pointed out that there are four fundamental properties of sound transmission in water relevant to the consideration of the effects of noise on aquatic animals:

1. The transmission distance of sound in seawater is determined by a combination of geometric spreading loss and an absorptive loss that is proportional to the sound frequency. Thus, attenuation (weakening) of sound increases as its frequency increases.
2. The speed of a sound wave in water is proportional to the temperature.
3. The sound intensity decreases with distance from the sound source. Transmission loss of energy (intensity) due to spherical spreading in deep water is estimated by  $20 \log_{10} r$ , where  $r$  is the distance in m from the source.
4. The strength of sound is measured on a logarithmic scale.

From these properties, it can be seen that high frequency sounds will dissipate faster than low frequency sounds, and a sound level may decrease by as much as 60dB at 1 km from the source. Acoustic wave intensity of 180 dB is 10 times less intense than 190 dB, and 170 dB is 100 times less than 190 dB (NRC 2000).

### ***Noise Produced by Ocean Energy Technologies***

There is very little information available on sound levels produced by construction and operation of ocean energy conversion structures (Michel et al. 2007). However, reviews of the construction and operation of European offshore wind farms provide useful information on the sensitivity of aquatic organisms to underwater noise. For example, Thomsen et al. (2006) reported that pile-driving activities generate brief, but very high sound pressure levels over a broad band of frequencies (20 to 20,000 Hz). Single pulses are about 50-100 ms in duration and occur approximately 30 to 60 times per minute. The SEL at 400 m from the driving of a 1.5-m-diameter pile exceeded 140 dB re 1  $\mu$ Pa over a frequency range of 40 to 3,000 Hz (Betke et al. 2004). It usually takes 1 to 2 h to drive one pile into the bottom. Sounds produced by the pile-driving impacts above the water's surface enter the water from the air and from the submerged portion of the pile, propagate through the water column, and into the sediments, from which they pass successively back into the water column. Larger-diameter, longer piles require relatively more energy to drive into the sediments, which results in higher noise levels. For example, the SPL associated with driving 3.5-m-diameter piles is expected to be roughly 10 dB greater than for a 1.5-m-diameter pile (Thomsen et al. 2006). Pile driving sounds, while intense and potentially damaging, would occur only during the installation of some marine and hydrokinetic energy devices. Mitigation options to reduce adverse effects of pile driving noises are discussed in Section 3.4.2.

Some ocean energy technologies will be secured to the bottom by means of moorings and anchors drilled into rock. Like pile-driving, hydraulic drilling will occur during a limited time period, and noise generation will be intermittent. DON (2003) summarized underwater SPL measurements of three hydraulic rock drills; frequencies ranged from about 15 Hz to over 39 kHz, and SPLs ranged from about 120 to 170 dB re 1  $\mu$ Pa. SPLs were relatively consistent across the entire frequency range.

During operation, vibration of the device's gearbox, generator, and other moving components are radiated as sound into the surrounding water. Noise during operation of wind farms is of much lower intensity than noise during construction (Thomsen et al. 2006; Betke et al. 2004), and the same may be true for hydrokinetic and ocean energy farms. However, this source of noise will be continuous. Measurements of sound levels associated with the operation of hydrokinetic and ocean energy farms have not yet been published. One example of a wave energy technology, the WEC buoy (a version of OPT's PowerBuoy) that has been tested in Hawaii, has many of the mechanical parts contained within an equipment canister or mounted to a structure through mounting pads. Thus, the acoustic energy produced by the equipment is not well coupled to the seawater, which is expected to reduce the amount of radiated noise (DON 2003). Although no measurements had been made, it was predicted that the acoustic output from the WEC buoy system would probably be in the range of 75 to 80 dB re 1  $\mu$ Pa. This SPL is equivalent to light to normal density shipping noise, although the frequency spectrum of the WEC buoy is expected to be shifted to higher frequencies than typical shipping noise.

By comparison, Thomsen *et al.* (2006) reported the ambient noise measured at five different locations in the North Sea (Figure C-2). Depending on frequency, SPL ranged from 85 to 115 dB, with most energy occurring at frequencies less than 100 Hz.

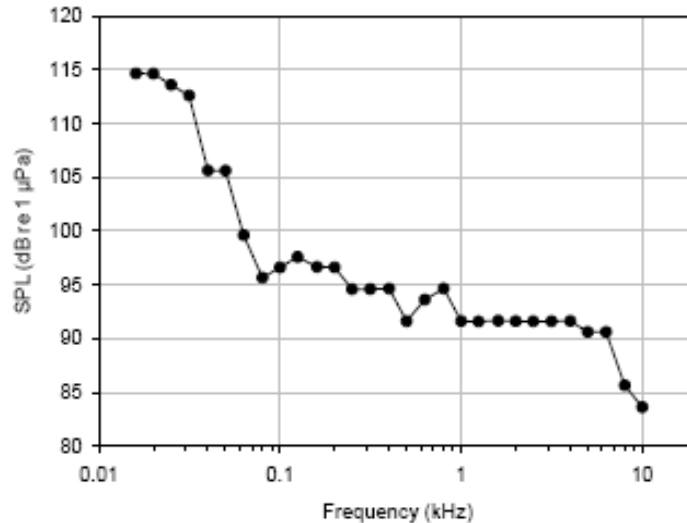

**Figure C-2. Frequency spectrum (at 1/3-octave band levels) of ambient noise measured at five different locations of the North Sea at wind speeds of 3-8 m/s. Source: Thomsen *et al.* (2006).**

The Environmental Statement for the proposed installation of the Wave Dragon wave energy demonstrator off the coast of Pembrokeshire, UK predicted noise levels associated with installation of concrete caisson (gravity) blocks and steel cable mooring arrangement, installation of subsea cable, and support activity (Wave Dragon Wales Ltd. 2007). The installation of gravity blocks is not expected to generate additional noise over and above that of the vessel conducting the operation. Vessel noise will depend on size and design of the ship, but is expected to be up to 180 dB re 1 µPa at 1 m. Other predicted installation noise sources and levels stem from operation of the ship’s echosounder (220 dB re 1 µPa at 1 m peak-to-peak), cable laying and fixing (159 to 181 dB re 1 µPa at 1 m), and directional drilling (129 dB re 1 µPa rms at 40 m above the drill). There are no measurements available for the noise associated with operation of an overtopping device such as the Wave Dragon. Wave Dragon Wales Ltd. (2007) predicted that operational noise would result from the Kaplan-style hydro turbines (an estimated 143 dB re 1 µPa at 1 m), as well as unknown levels and frequencies of sound from wave interactions with the body of the device, hydraulic pumps, and the mooring system.

In April, 2008 the Ocean Renewable Power Company (ORPC) made limited measurements of underwater noise associated with operation of their 1/3-scale working prototype in-stream tidal energy conversion device, its Turbine Generator Unit (TGU). The TGU is a single horizontal axis device with two advanced design cross-flow turbines that drive a permanent magnet generator. An omnidirectional hydrophone, calibrated for a frequency range of 20 to 250 kHz, was used to make near field measurements adjacent



to the barge from which the turbine was suspended and at approximately 15 m from the turbine. Multiple far field measurements were also made at distances out to 2.0 km from the barge. Noise measurements were made over one full tidal cycle, with supplemental measurements taken later (Ernest Hauser, Ocean Renewable Power Company Maine, LLC; personal communication, June 25, 2008). Sound pressure levels at 1/3-octave frequency bands were used to calculate rms levels and SELs. During times when the turbine generator unit was not operating, background noise ranged from 112 to 138 dB re 1  $\mu$ Pa rms and SELs ranged from 120 to 140 dB re 1  $\mu$ Pa. A single measurement made when the turbine blades were rotating (at 52 rpm) resulted in an estimate of 132 dB re 1  $\mu$ Pa (rms) and an SEL of 126 dB re 1  $\mu$ Pa at a horizontal distance of 15 m and a water depth of 10 m. These very limited readings suggest that the single 1/3-scale turbine generator unit did not increase noise above ambient levels.

In addition to the sound intensity and frequency spectrum produced by the operation of individual machines, impacts of noise will depend on the geographic location of the project (water depth, type of substrate), the number of units, and the arrangement of multiple-unit arrays. For example, due to noise from surf and surface waves, noise levels in shallow, nearshore areas ( $\leq 100$  m deep and within 5 km of the shore) are typically somewhat higher for low frequencies ( $\leq 1$  kHz) and much higher at frequencies above 1 kHz (Appendix F of DON 2003).

### ***Potential Effects of Noise on Aquatic Animals***

Due to the complexity of describing underwater sounds, investigators have often used different units to express the effects of sound on aquatic animals and have not always reported precisely the experimental conditions. For example, acoustic signal characteristics that might be relevant to biological effects include frequency content, rise time, pressure and particle velocity time series, zero-to-peak and peak-to-peak amplitude, mean squared amplitude, duration, integral of mean squared amplitude over duration, sound exposure level, and repetition rate (NRC 2003; Thomsen *et al.* 2006). Each of these sound characteristics may differentially impact different species of aquatic animals, but the relationships are not sufficiently understood to specify which are the most important. Many studies of the effects of noise report the frequency spectrum and some measure of sound intensity (SPL, rms, and/or SEL).

Underwater noise can be detected by fish and marine mammals if the frequency and intensity falls within the range of hearing for the particular species. An organism's hearing ability can be displayed as an audiogram, which plots sound pressure level (dB) against frequency (Hz). Nedwell *et al.* (2004) compiled audiograms for a number of aquatic organisms, examples of which are shown in Figure C-3. If the pressure level of a generated sound is transmitted at these frequencies and exceeds the sound pressure level (i.e., above the line) on a given species' audiogram, the organism will be able to detect the sound. There is a wide range of sensitivity to sound among marine fish. The herrings (Clupeoidea) are highly sensitive to sound due to the structure of their swim bladder and auditory apparatus, whereas flatfish such as plaice and dab (Pleuronectidae) that have no swim bladder are relatively insensitive to sound (Nedwell *et al.* 2004). Possible responses to the received sound may include altered behavior (i.e., attraction, avoidance,

interference with normal activities) (Nelson *et al.* 2008) or, if the intensity is great enough, hearing damage or mortality. For example, fish kills have been reported in the vicinity of pile-driving activities (Longmuir and Lively 2001; Caltrans 2001).

The National Research Council (2000) reviewed studies that demonstrated a wide range of susceptibilities to exposure-induced hearing damage among different marine species. The implications are that critical sound levels will not be able to be extrapolated from studies of a few species (although a set of representative species might be identified), and it will not be possible to identify a single sound level value at which damage to the auditory system will begin at all, or even most, marine mammals. Participants in a recent NOAA workshop (Boehlert *et al.* 2008) suggested that sounds that are within the range of hearing and “sweep” in frequency are more likely to disturb marine mammals than constant-frequency sounds. Thus, devices that emit a constant frequency may be preferable to ones that vary. They believed that the same may be true, although perhaps to a lesser extent, for sounds that change in amplitude.

Moore and Clarke (2002) compiled information on the reactions of gray whales (*Eschrichtius robustus*) to noise associated with offshore oil and gas development and vessel traffic. Gray whale responses included changes in swim speed and direction to avoid the sound source, abrupt but temporary cessation of feeding, changes in calling rates and call structure, and changes in surface behavior. They reported a 0.5 probability of avoidance when continuous noise levels exceeded about 120 dB re 1  $\mu$ Pa and when intermittent noise levels exceeded about 170 dB re 1  $\mu$ Pa. They found little evidence that gray whales travel far or remain disturbed for long as a result of noises of this nature.

Weilgart (2007) reviewed the literature on the effects of ocean noise on cetaceans, focusing on underwater explosions, shipping, seismic exploration by the oil and gas industries, and naval sonar operations. She noted that strandings and mortalities of cetaceans have been observed even when estimated received sound levels were not high enough to cause hearing damage. This suggests that a change in diving patterns may have resulted in injuries due to gas and fat emboli. That is, aversive noise may prompt cetaceans to rise to the surface too rapidly, and the rapid decompression causes nitrogen gas supersaturation and the subsequent formation of bubbles (emboli) in their tissues (Fernandez *et al.* 2005). Other adverse (but not directly lethal) impacts could include increased stress levels, abandonment of important habitats, masking of important sounds, and changes in vocal behavior that may lead to reduced foraging efficiency or mating opportunities. Weilgart (2007) pointed out that responses of cetaceans to ocean noise are highly variable between species, age classes, and behavioral states, and many examples of apparent tolerance of noise have been documented.

Nowacek *et al.* (2007) reviewed the literature on the behavioral, acoustic, and physiological effects of anthropogenic noise on cetaceans, and concluded that the noise sources of primary concern are ships, seismic exploration, sonars, and some acoustic harassment devices (AHDs) that are employed to reduce the by-catch of small cetaceans and seals by commercial fishing gear.

Two marine mammals whose hearing and susceptibility to noise have been studied are the harbor porpoise (*Phocoena phocoena*) and the harbor seal (*Phoca vitulina*). Both species inhabit shallow coastal waters in the North Atlantic and North Pacific. Harbor porpoises are found as far south as Central California on the West Coast. The hearing of the harbor porpoise ranges from below 1 kHz to around 140 kHz. In the United States, harbor seals range from Alaska to Southern California on the West Coast, and as far south as South Carolina on the East Coast. Harbor seal hearing ranges from less than 0.1 kHz to around 100 kHz (Thomsen et al. 2006). Sounds produced by marine energy devices that are outside of these frequency ranges would not be detected by these species.

Thomsen et al. (2006) compared the underwater noise associated with pile driving to the audiograms of harbor porpoises and harbor seals, and concluded that pile-driving noise would likely be detectable at least 80 km away from the source. The zone of masking (the area within which the noise is strong enough to interfere with the detection of other sounds) may differ between the two species. Because the echolocation (sonar) used by harbor porpoises is in a frequency range (120 to 150 kHz) where pile-driving noises have little or no energy (Figure C-1), they considered masking of echolocation to be unlikely. On the other hand, harbor seals communicate at frequencies ranging from 0.2 to 3.5 kHz, which is within the range of highest pile-driving sound pressure levels; thus, harbor seals may have their communications masked at considerable distances by pile-driving activities.

The responses of green turtles (*Chelonia mydas*) and loggerhead turtles (*Caretta caretta*) to the sounds of air guns used for marine seismic surveys were studied by McCauley et al. (2000a, b). They found that above a noise level of 166 dB re 1  $\mu$ Pa rms the turtles noticeably increased their swimming activity, and above 175 dB re 1  $\mu$ Pa rms their behavior became more erratic, possibly indicating that the turtles were in an agitated state. On the other hand, Weir (2007) was not able to detect an impact on turtles of the sounds produced by air guns used in geophysical seismic surveys. Caged squid (*Sepioteuthis australis*) showed a strong startle response to an air gun at a received level of 174 dB re 1  $\mu$ Pa rms. When sound levels were ramped up (rather than a sudden nearby startup), the squid showed behavioral responses (e.g., rapid swimming) at sound levels as low as approximately 156 dB re 1  $\mu$ Pa rms but did not display the startle response seen in the other tests.

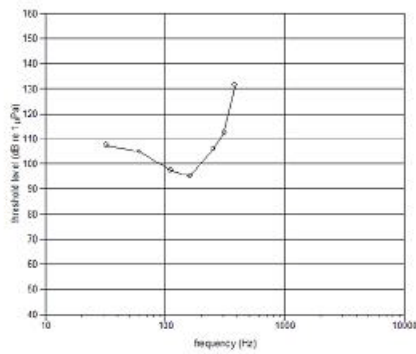

Atlantic salmon, *Salmo salar*

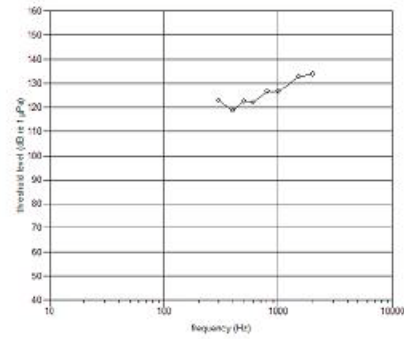

Bluegill sunfish, *Lepomis macrochirus*

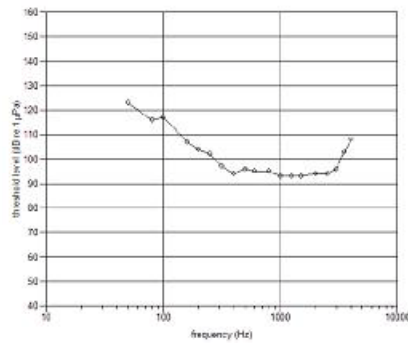

Channel catfish, *Ictalurus punctatus*

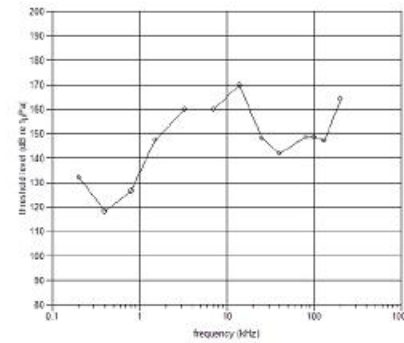

American shad, *Alosa sapidissima*

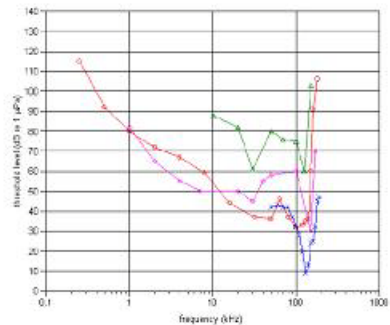

Harbor porpoise, *Phocoena phocoena*

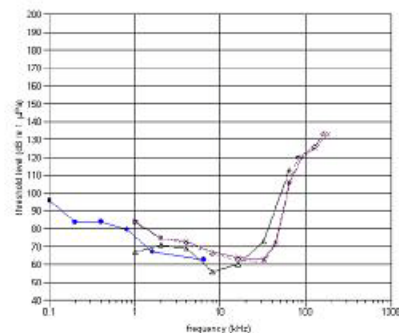

Harbor seal, *Phoca vitulina*

**Figure C-3. Examples of audiograms of fish and marine mammals. From Nedwell et al. (2004).**

Hastings and Popper (2005) reviewed the literature on the effects of underwater sounds on fish, particularly noises associated with pile driving. The limited number of quantitative studies found evidence of changes in the hearing capabilities of some fish, damage to the sensory structure of the inner ear, or, for fish close to the source, mortality. They concluded that the body of scientific and commercial data is inadequate to develop more than the most preliminary criteria to protect fish from pile driving sounds, and suggested the types of studies that could be conducted to address the information gaps. Similarly, Viada et al. (2008) found very little information on the potential impacts to sea turtles of underwater explosives. Although explosives produce greater sound pressures

than pile driving and are unlikely to be used in most ocean energy installations, studies of their effects provide general information about the peak pressures and distances that have been used to establish safety zones for turtles.

Wahlberg and Westerberg (2005) compared source level and underwater measurements of sounds from offshore windmills to information about the hearing capabilities of three species of fish: goldfish, Atlantic salmon, and cod. They predicted that these fish could detect offshore windmills at a maximum distance of about 0.4 to 25 km, depending on wind speed, type and number of windmills, water depth, and substrate. They could find no evidence that the underwater sounds emitted by windmill operation would cause temporary or permanent hearing loss in these species, even at a distance of a few meters, although sound intensities might cause permanent avoidance within ranges of about 4 m. They noted that shipping causes considerably higher sound intensities than operating windmills (although the noise from shipping is transient), and noises from installation may have much more significant impacts on fish than those from operation.

In the Environmental Assessment of the proposed Wave Energy Technology (WET) Project, DON (2003) considered the sounds made by hydraulic rock drilling to be detectable by humpback whales, bottlenose dolphins, Hawaiian spinner dolphins, and green sea turtles. Assuming a transmission loss due to spherical spreading, drilling sound pressure levels of 160 dB re 1  $\mu$ Pa would decrease by about 40 dB at 100 m from the source. They regarded a SPL of 120 dB re 1  $\mu$ Pa to be below the level that would affect these four species. In fact, they reported that other construction activities involving similar drilling attracted marine life, fish and sea turtles in particular, perhaps because bottom organisms were stirred up by the drilling (Appendix F of DON 2003).

There are considerable information gaps regarding the effects of noise generated by marine and hydrokinetic energy technologies on cetaceans, pinnipeds, turtles, and fish. Sound levels from these devices have not been measured, but it is likely that installation will create more noise than operation, at least for those technologies that require pile driving. Operational noise from generators, rotating equipment, and other moving parts may have comparable frequencies and magnitudes to those measured at offshore wind farms; however, the underwater noise created by a wind turbine is transmitted down through the pilings, whereas noises from marine and hydrokinetic devices are likely to be greater because they are at least partially submerged. It is probable that noise from marine energy projects may be less than the intermittent noises associated with shipping and many other anthropogenic sound sources (e.g., seismic exploration, explosions, commercial, naval sonar).

The resolution of noise impacts will require information about the device's acoustic signature (e.g., sound pressure levels across the full range of frequencies) for both individual units and multiple-unit arrays, similar characterization of ambient (background) noise in the vicinity of the project, the hearing sensitivity (e.g., audiograms) of fish and marine mammals that inhabit the area, and information about the behavioral responses to anthropogenic noise (e.g., avoidance, attraction, changes in schooling behavior or migration routes). Simmonds *et al.* (2003) describe the types of *in situ*

monitoring that could be carried out to develop information on the effects of underwater noise arising from a variety of activities. The studies include monitoring marine mammal activity in parallel with sound level monitoring during construction and operation. Baseline sound surveys would be needed against which to measure the added effects of energy generation. It will be important to measure the acoustic characteristics produced by both single units and multiple units in an array, due to the possibility of synchronous or asynchronous, additive noise produced by the array (Boehlert *et al.* 2008). Minimally, the operational monitoring would quantify the sound pressure levels across the entire range of sound frequencies for a variety of ocean/river conditions in order to assess how meteorological, current strength, and/or wave height conditions affect sound generation and sound masking. The monitoring effort should consider the effects of marine fouling on noise production, particularly as it relates to mooring cables.



## Appendix D

### Electromagnetic Fields in the Aquatic Environment and their Effects on Aquatic Animals

#### *Nature of the Underwater Electromagnetic Field*

The electromagnetic field (EMF) created by electric current passing through a cable is composed of both an electric field (E field) and an induced magnetic field (B field). Although E can be contained within undamaged insulation surrounding the cable, B fields are unavoidable and will in turn induce a secondary electric field (iE field). Thus, it is important to distinguish between the two constituents of the EMF (E and B) and the induced field, iE (Figure D-1 of Gill *et al.* 2005). Because the electric field is a measure of how the voltage changes when a measurement point is moved in a given direction, E and iE are expressed in volts/m (V/m).

The intensity of a magnetic field can be expressed as magnetic field strength or magnetic flux density (CMACS 2003). The magnetic field can be visualized as field lines, and the field strength (measured in amperes/m [A/m]) corresponds to the density of the field lines. Magnetic flux density is a measure of the density of magnetic lines of force, or magnetic flux lines, passing through an area. Magnetic flux density (measured in teslas[T]) diminishes with increasing distance from a straight current-carrying wire. At a given location in the vicinity of a current-carrying wire, the magnetic flux density is directly proportional to the current in amperes. Thus, the magnetic field B is directly linked to the magnetic flux density that is flowing in a given direction.

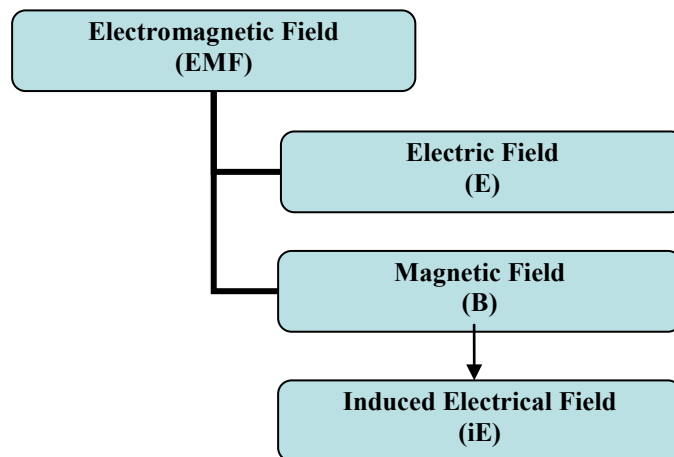

Figure D-1. Simplified view of the field associated with submarine power cables. Modified from Gill *et al.* (2005)



The EMF associated with new marine and hydrokinetic energy designs have not been quantified. However, there is considerable experience with submarine electrical transmission cables, with some predictions and measurements of their associated electrical and magnetic fields. For example, the Wave Energy Technology (WET) generator will be housed in a canister buoy and connected to shore by a 1190-m-long, 6.5-cm-diameter electrical cable (Appendix F of DON 2003). The cable is designed for three-phase AC transmission, can carry up to 250 kW, and has multiple layers of insulation and armoring to contain the electrical current. Depending on current flow (amperage), at 1 m from the cable, the magnetic field strength was predicted to range from 0.1 to 0.8 A/m and the magnetic flux density would range from 0.16 to 1.0  $\mu\text{T}$  (Figure D-2). The estimated strength of the electric field at the surface of the cable (apparently the *iE*) would range from 1.5 to 10.5 mV/m. The electric field strength, magnetic field strength, and magnetic flux density would all decrease exponentially with distance from the cable.

The Centre for Marine and Coastal Studies (2003) surveyed cable manufacturers and independent investigators to compile estimates of the magnitudes of E, B, and *iE* fields. Most agreed that the E field can be completely contained within the cable by insulation. Estimates of the B field strength ranged from zero (by one manufacturer) to 1.7 and 0.61  $\mu\text{T}$  at distances of 0 and 2.5 m from the cable respectively. By comparison, the Earth's geomagnetic field strength ranges from approximately 20 to 75  $\mu\text{T}$  (Bochert and Zettler 2006). In another study cited by CMACS (2003), a 150 kV cable carrying a current of 600 A generated an induced electric field (*iE*) of more than 1 mV/m at a distance of 4 m from the cable; the field extended for approximately 100 m before dissipating. Lower voltage/amperage cables generated similarly large *iE* fields near the cable, but the fields dissipated much more rapidly with distance.

For short distance undersea transmission of electricity, three-phase AC power cables are most common; HVDC are used for longer distance, high power applications (Ohman *et al.* 2007). In AC cables the voltage and current alternate sinusoidally at a given frequency (50 or 60 Hz), and therefore the E and B fields are also time varying. That is, like AC current, the magnetic field induced by a three-phase AC current has a cycling polarity, which is not like the natural geomagnetic fields. On the other hand, the E and B fields produced by a direct current (DC) cable (e.g., HVDC) are static. Because the magnetic fields induced by DC and AC cables are different, they are likely to be perceived differently by aquatic organisms.

Because neither sand nor seawater has magnetic properties, burying a cable will not affect the magnitude of the magnetic (B) field; that is, the B fields at the same distance from the cable are identical, whether in water or sediment (CMACS 2003). On the other hand, due to the higher conductivity of seawater compared to sand, the *iE* field associated with a buried cable is discontinuous across the sand/water boundary; the *iE* field strength is greater in water than in sand at a given distance from the cable. For example, for the three-phase AC cable modeled by CMACS (2003), the estimated *iE* field strengths at 8 m from the cable were 10  $\mu\text{V}/\text{m}$  and 1 to 2  $\mu\text{V}/\text{m}$  in water and sand, respectively.

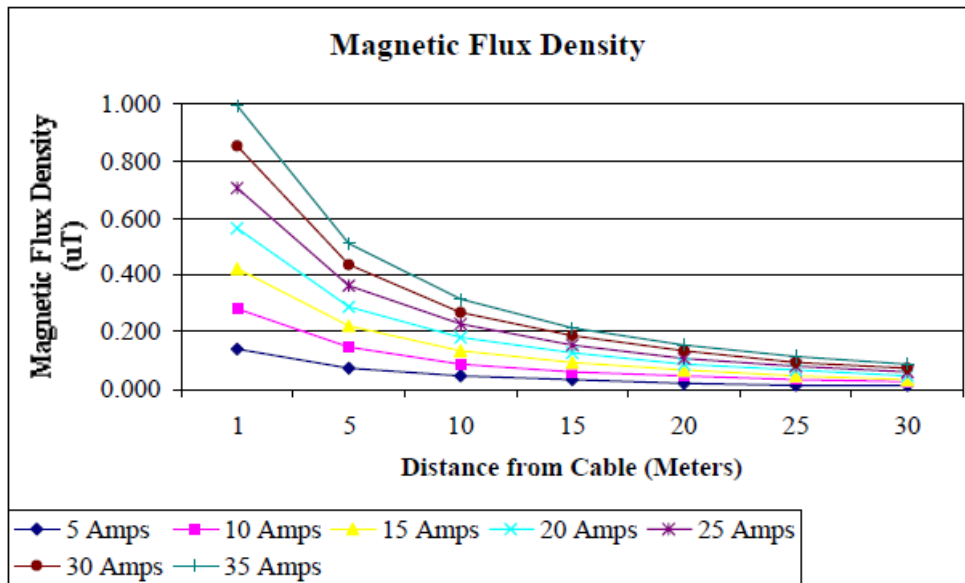
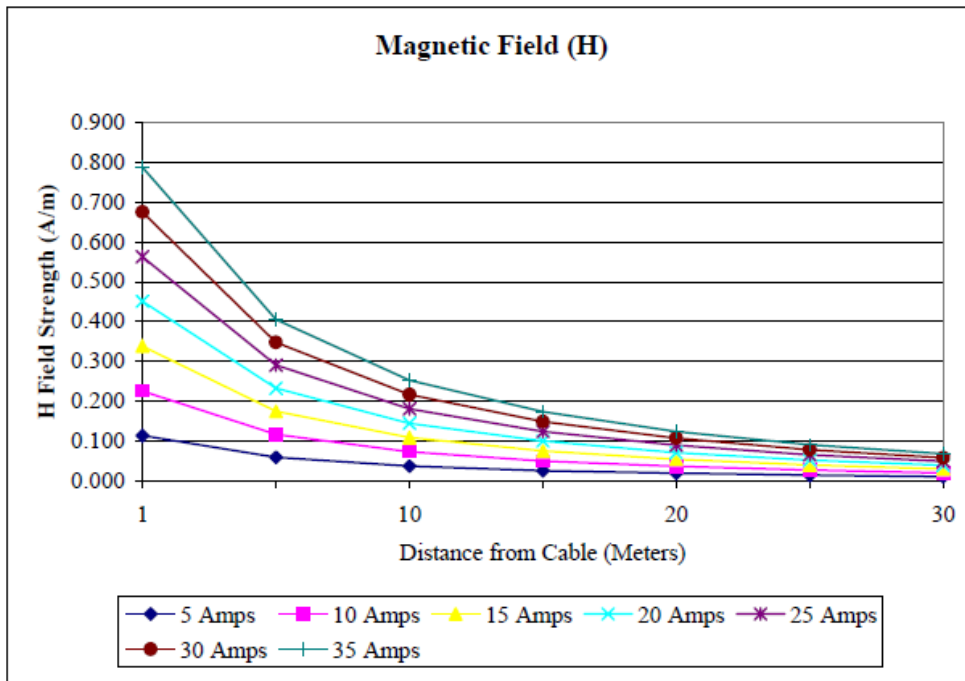

Figure D-2. Calculated magnetic field (A/m) and magnetic flux density ( $\mu\text{T}$ ) near the WEC submarine power cable.

The EMF generated by a multi-unit array of marine or hydrokinetic devices will differ from EMF associated with a single unit or from the single cable sources that have been surveyed. Depending on the power generation device, a project may have electrical cables running vertically through the water column in addition to multiple cables running along the seabed or converging on a subsea pod. The EMF created by a matrix of cables has not been predicted or quantified.

## ***Effects of Electromagnetic Fields on Aquatic Organisms***

### Electrical Fields

Natural electric fields can occur in the aquatic environment as a result of biochemical, physiological, and neurological processes within an organism or as a result of an organism swimming through a magnetic field (Gill *et al.* 2005). Some of the elasmobranchs (e.g., sharks, skates, rays) have specialized tissues that enable them to detect electric fields (i.e., electroreception), an ability which allows them to detect prey and potential predators and competitors. Two species of Asian sturgeon have been reported to alter their behavior in changing electric fields (Basov 1999; 2007). Other fish species (e.g., eels, cod, Atlantic salmon, catfish, paddlefish) will respond to induced voltage gradients associated with water movement and geomagnetic emissions (Collin and Whitehead 2004; Wilkens and Hofmann 2005), but their electrosensitivity does not appear to be based on the same mechanism as sharks (Gill *et al.* 2005).

Balayev and Fursa (1980) observed the reactions of 23 species of marine fish to electric currents in the laboratory. Visible reactions occurred following exposure to electric fields ranging from 0.6 to 7.2 V/m, and varied depending on the species and orientation to the field. They noted that changes in the fishes' electrocardiograms occurred at field strengths 20 times lower than those that elicited observable behavioral responses. Enger *et al.* (1975) found that European eels (*Anguilla anguilla*) exhibited a decelerated heart rate when exposed to a direct current electrical field with a voltage gradient of about 400 to 600  $\mu\text{V}/\text{cm}$ . In contrast, Rommel and McCleave (1972) observed much lower voltage thresholds of response (0.07 to 0.67  $\mu\text{V}/\text{cm}$ ) in American eels (*Anguilla rostrata*). The eels' electrosensitivity measured by Rommel and McCleave is well within the range of naturally occurring oceanic electric fields of at least 0.10  $\mu\text{V}/\text{cm}$  in many currents in the Atlantic Ocean and up to 0.46  $\mu\text{V}/\text{cm}$  in the Gulf Stream.

Kalmijn (1982) described the extreme sensitivity of some elasmobranchs to electric fields. For example, the skate (*Raja clavata*) exhibited cardiac responses to uniform square-wave fields of 5 Hz at voltage gradients as low as 0.01  $\mu\text{V}/\text{cm}$ . Dogfish (*Mustelus canis*) initiated attacks on electrodes from distances in excess of 38 cm and voltage gradients as small as 0.005  $\mu\text{V}/\text{cm}$ .

Marra (1989) described the interactions of elasmobranchs with submarine optical communications cables. The cable created an iE field (1  $\mu\text{V}/\text{m}$  at 0.1 m) when sharks crossed the magnetic field induced by the cable. The sharks responded by attacking and biting the cable. Marra (1989) was unable to identify the specific stimuli that elicited the attacks, but he suggested that at close range the shark interpreted the electrical stimulus of the iE field as prey, which it then attacked.

The weak electric fields produced by swimming movements of zooplankton can be detected by juvenile freshwater paddlefish (*Polyodon spathula*). Wojtenek *et al.* (2001) used dipole electrodes to create electric fields that simulated those created by water flea (*Daphnia* sp.) swimming. They tested the effects of alternating current oscillations at frequencies ranging from 0.1 to 50 Hz and stimulus intensities ranging from 0.125 to 1.25

$\mu\text{A}$  peak-to-peak amplitude. Paddlefish made significantly more feeding strikes at the electrodes at sinusoidal frequencies of 5 to 15 Hz compared to lower and higher frequencies. Similarly, the highest strike rate occurred at the intermediate electric field strength (stimulus intensity of 0.25  $\mu\text{A}$  peak-to-peak amplitude). Strike rate was reduced at higher water conductivity, and their fish habituated (ceased to react) to repetitive dipole stimuli that were not reinforced by prey capture.

Gill and Taylor (2002; cited in CMAC 2003) carried out a pilot study of the effects on dogfish of electric fields generated by a DC electrode in a laboratory tank. They reported that the dogfish avoided constant electric fields as small as 1,000  $\mu\text{V}/\text{m}$ , which would be produced by 150 kV cables with a current of 600 A. Conversely, the dogfish were attracted to a field of 10  $\mu\text{V}/\text{m}$  at 0.1 m from the source, which is similar to the bioelectric fields emitted by dogfish prey. The electrical field created by the three-phase, AC cable modeled by CMACS (2003) would likely be detectable by a dogfish (or other similarly sensitive elasmobranchs) at a radial distance of 20 m. It is possible that the ability of fish to discriminate an electrical field is a function of not only the size/intensity but also the frequency (Hz) of the emitted field.

Like elasmobranchs, sturgeon (closely related to paddlefish) can utilize electroreceptor senses to locate prey, and may exhibit varying behavior at different electric field frequencies (Basov 1999). For this reason electrical fields are a concern as they may impact migration or ability to find prey. The National Marine Fisheries Service (NMFS) proposed critical habitat for the Southern distinct population segment of the threatened North American green sturgeon (*Acipenser medirostris*) along the coastline out to the 110 m isobath line (70 FR 52084-52110; September 8, 2008). One of the principal constituent elements in the proposal is safe passage along the migratory corridor. Green sturgeons migrate extensively along the nearshore coast from California to Alaska, and there is concern that these fish may be deterred from migration by either low frequency sounds or electromagnetic fields created during operation of marine energy facilities.

### Magnetic Fields

Many terrestrial and aquatic animals can sense the Earth's magnetic field and appear to use this magnetosensitivity for long distance migrations. Aquatic species whose long-distance migrations or spatial orientation appear to involve magnetoreception include eels (Westerberg and Begout-Aranas 1999; cited in CMACS 2003), spiny lobsters (Boles and Lohmann 2003), elasmobranchs (Kalmijn 2000), sea turtles (Lohmann and Lohmann 1996), rainbow trout (Walker et al. 1997), tuna, and cetaceans (Wiltschko and Wiltschko 1995; Lohmann et al. 2008a). Four species of Pacific salmon were found to have crystals of magnetite within them and it is believed that these crystals serve as a compass that orients to the earth's magnetic field (Mann et al. 1988; Walker et al. 1988). Because some aquatic species use the Earth's magnetic field to navigate or orient themselves in space, there is a potential for the magnetic fields created by the numerous electrical cables associated with offshore power projects to disrupt these movements.

Gill et al. (2005) placed magnetosensitive organisms into two categories: (1) those able to detect the iE field caused by movement through a natural or anthropogenic magnetic

field, and (2) those with detection systems based on ferromagnetic minerals (i.e., magnetite or greigite). Johnsen and Lohmann (2005; 2008) add a third possible mechanism for magnetosensitivity – chemical reactions involving proteins known as cryptochromes. Those species using the iE mode may either do it passively (i.e., the animal estimates its drift from the electric fields produced by the interaction between tidal/wind-driven currents and the vertical component of the Earth’s magnetic field) or actively (i.e., the animal derives its magnetic compass heading from its own interaction with the horizontal component of the Earth’s magnetic field). For example, Kalmijn (1982) suggested that the electric fields that elasmobranchs induce by swimming through the Earth’s magnetic field may allow them to detect their magnetic compass headings; the resulting voltage gradients may range from 0.05 to 0.5  $\mu\text{V}/\text{cm}$ . Detection of a magnetic field based on internal deposits of magnetite occurs in a wide range of animals, including birds, insects, fish, sea turtles, and cetaceans (Gould 1984; Bochert and Zettler 2006). There is no evidence to suggest that seals are sensitive to magnetic fields (Gill et al. 2005).

Westerberg and Begout-Aranas (1999; cited in CMACS 2003) studied the effects of a B field generated by a HVDC power cable on eels (*Anguilla anguilla*). The B field was on the same order of magnitude as the Earth’s geomagnetic field and, coming from a DC cable, was also a static field. Approximately 60 percent of the 25 eels tracked crossed the cable, and the authors concluded that the cable did not appear to act as a barrier to the eel migration. In another behavioral study, Meyer et al. (2004) showed that conditioned sandbar and scalloped hammerhead sharks readily responded to localized magnetic fields of 25 to 100  $\mu\text{T}$ , a range of values that encompasses the strength of the Earth’s magnetic field.

Some sea turtles undergo transoceanic migrations before returning to nest on or near the same beaches where they were hatched. Lohmann and Lohmann (1996) showed that sea turtles have the sensory abilities necessary to approximate their global position on a magnetic map. This would allow them to exploit unique combinations of magnetic field intensity and field line inclination in the ocean environment to determine direction and/or position during their long-distance migrations. Irwin and Lohmann (2005) found that magnetic orientation in loggerhead sea turtles (*Caretta caretta*) can be disrupted at least temporarily by strong magnetic pulses (i.e., five brief pulses of 40,000  $\mu\text{T}$  with a 4 ms rise time). The impact of a changed magnetic environment would depend upon the role of magnetic information in the hierarchy of cues used to orient/navigate (Wiltschko and Wiltschko 1995). Juvenile loggerheads deprived of either magnetic or visual information were still able to maintain a direction of orientation, but when both cues were removed, the turtles were disoriented (Arens and Lohmann 2003). The magnetic map sense exhibited by hatchlings is also thought to allow female sea turtles to imprint upon the location of their natal beaches so that later in life they can return there to nest. This phenomenon is termed ‘natal homing’ (Lohmann et al. 2008b), and it serves to drive genetic division among subpopulations of the same species. As a result, altering magnetic fields near nesting beaches could potentially result in altered nesting patterns. Given the important role of magnetic information in the movements of sea turtles, impacts of magnetic field disruption could range from minimal (i.e., temporary

disorientation near a cable or structure) to significant (i.e., altered nesting patterns and corresponding demographic shifts resulting from large-scale magnetic field changes) and should be carefully considered when siting projects.

The emphasis of most of these studies is on the value of magnetoreception for navigation; marine and hydrokinetic energy technologies are unlikely to create magnetic fields strong enough to cause physical damage. For example, Bochert and Zettler (2006) summarized several studies of the potential injurious effects of magnetic fields on marine organisms. They subjected several marine benthic species (i.e., flounder, blue mussel, prawn, isopods and crabs) to static (DC-induced) magnetic fields of 3,700  $\mu\text{T}$  for several weeks and detected no differences in survival compared to controls. In addition, they exposed shrimp, isopods, echinoderms, polychaetes, and young flounder to a static, 2,700  $\mu\text{T}$  magnetic field in laboratory aquaria where the animals could move away from or toward the source of the field. At the end of the 24-h test period, most of the test species showed a uniform distribution relative to the source, not significantly different from controls. Only one of the species, the benthic isopod *Saduria entomon*, showed a tendency to leave the area of the magnetic field. The oxygen consumption of two North Sea prawn species exposed to both static (DC) and cycling (AC) magnetic fields were not significantly different from controls. Based on these limited studies, Bochert and Zettler (2006) could not detect changes in marine benthic organisms' survival, behavior, or a physiological response parameter (e.g., oxygen consumption) resulting from magnetic flux densities that might be encountered near an undersea electrical cable.

The current state of knowledge about the EMF emitted by submarine power cables is too variable and inconclusive to make an informed assessment of the effects on aquatic organisms (CMACS 2003). Following a thorough review of the literature related to EMF and extensive contacts with the electrical cable and offshore wind industries, Gill *et al.* (2005) concluded that there are significant gaps in knowledge regarding sources and effects of electrical and magnetic fields in the marine environment. They recommended developing information about likely electrical and magnetic field strengths associated with existing sources (e.g., telecommunications cables, power cables, electrical heating cables for oil and gas pipelines), as well as the generating units, offshore sub-stations and transformers, and submarine cables that are a part of offshore renewable energy projects. They cautioned that networks of cables in close proximity to each other (as would be found in large current and tidal energy projects where cables come together at substations) are likely to have overlapping, and potentially additive, EMF fields. These combined EMF fields would be more difficult to evaluate than those emitted from a single, electrical cable. The small, time-varying B field emitted by a submarine three-phase AC cable may be perceived differently by sensitive marine organisms than the persistent, static, geomagnetic field generated by the Earth (CMACS 2003). Possible mitigation options for the effects of EMF are discussed in Section 3.5.2.

**EERE Information Center**

1-877-EERE-INF (1-877-337-3463)

*[www.eere.energy.gov/informationcenter](http://www.eere.energy.gov/informationcenter)*

U.S. DEPARTMENT OF  
**ENERGY**

Energy Efficiency &  
Renewable Energy

DOE/GO-102009-2955 • December 2009

Printed with a renewable-source ink on paper containing at least 50% wastepaper, including 10% post-consumer waste.